

Veritas™ 5360 Appliance Product Description Guide

VERITAS™

Veritas 5360 Appliance Product Description Guide

Last updated: 2024-01-19

Legal Notice

Copyright © 2024 Veritas Technologies LLC. All rights reserved.

Veritas, the Veritas Logo, and NetBackup are trademarks or registered trademarks of Veritas Technologies LLC or its affiliates in the U.S. and other countries. Other names may be trademarks of their respective owners.

This product may contain third-party software for which Veritas is required to provide attribution to the third party ("Third-party Programs"). Some of the Third-party Programs are available under open source or free software licenses. The License Agreement accompanying the Software does not alter any rights or obligations you may have under those open source or free software licenses. Refer to the Third-party Legal Notices document accompanying this Veritas product or available at:

<https://www.veritas.com/about/legal/license-agreements>

The product described in this document is distributed under licenses restricting its use, copying, distribution, and decompilation/reverse engineering. No part of this document may be reproduced in any form by any means without prior written authorization of Veritas Technologies LLC and its licensors, if any.

THE DOCUMENTATION IS PROVIDED "AS IS" AND ALL EXPRESS OR IMPLIED CONDITIONS, REPRESENTATIONS AND WARRANTIES, INCLUDING ANY IMPLIED WARRANTY OF MERCHANTABILITY, FITNESS FOR A PARTICULAR PURPOSE OR NON-INFRINGEMENT, ARE DISCLAIMED, EXCEPT TO THE EXTENT THAT SUCH DISCLAIMERS ARE HELD TO BE LEGALLY INVALID. VERITAS TECHNOLOGIES LLC SHALL NOT BE LIABLE FOR INCIDENTAL OR CONSEQUENTIAL DAMAGES IN CONNECTION WITH THE FURNISHING, PERFORMANCE, OR USE OF THIS DOCUMENTATION. THE INFORMATION CONTAINED IN THIS DOCUMENTATION IS SUBJECT TO CHANGE WITHOUT NOTICE.

The Licensed Software and Documentation are deemed to be commercial computer software as defined in FAR 12.212 and subject to restricted rights as defined in FAR Section 52.227-19 "Commercial Computer Software - Restricted Rights" and DFARS 227.7202, et seq. "Commercial Computer Software and Commercial Computer Software Documentation," as applicable, and any successor regulations, whether delivered by Veritas as on premises or hosted services. Any use, modification, reproduction release, performance, display or disclosure of the Licensed Software and Documentation by the U.S. Government shall be solely in accordance with the terms of this Agreement.

Veritas Technologies LLC
2625 Augustine Drive
Santa Clara, CA 95054

<https://www.veritas.com>

Technical Support

Technical Support maintains support centers globally. All support services will be delivered in accordance with your support agreement and the then-current enterprise technical support policies. For information about our support offerings and how to contact Technical Support, visit our website:

<https://www.veritas.com/support>

You can manage your Veritas account information at the following URL:

<https://my.veritas.com>

If you have questions regarding an existing support agreement, please email the support agreement administration team for your region as follows:

Worldwide (except Japan)

CustomerCare@veritas.com

Japan

CustomerCare_Japan@veritas.com

Documentation

Make sure that you have the current version of the documentation. Each document displays the date of the last update on page 2. The latest documentation is available on the Veritas website:

https://www.veritas.com/content/support/en_US/dpp.Appliances.html

Documentation feedback

Your feedback is important to us. Suggest improvements or report errors or omissions to the documentation. Include the document title, document version, chapter title, and section title of the text on which you are reporting. Send feedback to:

APPL.docs@veritas.com

You can also see documentation information or ask a question on the Veritas community site:

<https://www.veritas.com/community/>

Veritas Services and Operations Readiness Tools (SORT)

Veritas Services and Operations Readiness Tools (SORT) is a website that provides information and tools to automate and simplify certain time-consuming administrative tasks. Depending on the product, SORT helps you prepare for installations and upgrades, identify risks in your datacenters, and improve operational efficiency. To see what services and tools SORT provides for your product, see the data sheet:

https://sort.veritas.com/data/support/SORT_Data_Sheet.pdf

Contents

| | | |
|------------------|------------------------------------------------------------------------------------------------|-----------|
| Chapter 1 | About the Veritas 5360 Appliance | 6 |
| | Veritas 5360 Appliance overview | 6 |
| | Features and components of the appliance | 7 |
| | Locating the appliance serial number | 9 |
| | Compute node drive configurations | 10 |
| | About the drive LEDs | 12 |
| | About the Veritas 5360 Appliance front panel USB port | 12 |
| | About the 5360 Appliance control panel | 13 |
| | About the System Status LED states | 15 |
| | About the Power button LED states | 18 |
| | About the compute node rear panel | 19 |
| | Veritas 5360 Appliance I/O configuration options | 21 |
| | Total I/O on-board and PCIe ports | 23 |
| | Available I/O configurations by slot for Veritas 5360 Appliance | 24 |
| | Broadcom P225p 10/25Gb PCIe Ethernet card | 25 |
| | QLE2772 dual-port 32 Gb Fibre Channel host bus adapter | 26 |
| | Intel Storage Adapter RS3P4GF016J | 27 |
| Chapter 2 | About the Veritas 5U84 Storage Shelves | 29 |
| | About Veritas 5360 Appliance storage shelves | 29 |
| | Available appliance storage options | 31 |
| | About the Veritas 5U84 Storage Shelf disk drive drawers | 33 |
| | 5U84 Primary Storage Shelf and the 5U84 Expansion Storage Shelf control panel | 45 |
| | About the 5U84 Primary Storage Shelf and 5U84 Expansion Storage Shelf rear components | 46 |
| | Veritas 5U84 Primary Storage Shelf RAID controllers | 49 |
| | Veritas 5U84 Expansion Storage Shelf Expansion I/O modules | 52 |
| | Veritas 5U84 Storage Shelf cooling modules | 56 |
| | 5U84 Storage Shelf Power Supply Units | 57 |

| | | |
|-------------------|---------------------------------------------------------------------------------------------------|-----------|
| Chapter 3 | Veritas 5360 Appliance and 5U84 Storage Shelf cables | 59 |
| | Power cables | 59 |
| | Network cable | 61 |
| | SAS-3 cable | 62 |
| | Twinaxial copper cables | 63 |
| Appendix A | Technical specifications, Environmental/Protocol standards, and Compliance standards | 65 |
| | Veritas 5360 compute node technical specifications | 66 |
| | Veritas 5U84 Storage Shelf technical specifications | 68 |
| | Environmental specifications | 71 |
| | Protocol standards | 73 |
| | Regulatory, compliance, and certification information | 74 |
| | Product regulatory compliance | 74 |
| | Country approvals | 74 |
| | Product safety compliance | 75 |
| | Product EMC Compliance - Class A Compliance | 75 |
| | Product environmental compliance | 76 |

About the Veritas 5360 Appliance

This chapter includes the following topics:

- [Veritas 5360 Appliance overview](#)
- [Features and components of the appliance](#)
- [Locating the appliance serial number](#)
- [Compute node drive configurations](#)
- [About the Veritas 5360 Appliance front panel USB port](#)
- [About the 5360 Appliance control panel](#)
- [About the compute node rear panel](#)
- [Veritas 5360 Appliance I/O configuration options](#)

Veritas 5360 Appliance overview

The Veritas 5360 Appliance is a hardware and software storage system that scales up to a total of 1,920 TiB (2,112 TB) of usable backup capacity. It consists of one or two 2U 5360 Appliance compute nodes and one required externally attached 5U84 Primary Storage Shelf, which is used for data storage purposes.

Figure 1-1 Veritas 5360 Appliance



By itself, the 5360 Appliance compute node does not provide internal disk space for data storage. You can add up to three optional 5U84 Expansion Storage Shelves if you require additional data storage space.

The Veritas 5360 Appliance supports the following software:

- Flex Appliance 3.2 and above

Note: Total usable backup capacity depends on the hardware configuration you purchase.

See [“Available appliance storage options”](#) on page 31.

SAS-3 cables connect the 5360 Appliance compute nodes to 5U84 Primary Storage Shelf RAID controllers. SAS-3 cables also connect 5U84 Primary Storage Shelves to the optional 5U84 Expansion Storage Shelves.

See See [“About Veritas 5360 Appliance storage shelves”](#) on page 29.

Features and components of the appliance

This section describes the features and components of the Veritas 5360 Appliances.

Table 1-1 Veritas 5360 Appliance features

| Technical Specification | Veritas 5360 Appliance system |
|------------------------------------------------------------------------------|---------------------------------------------------------------------------------------------------------------------------------------------------------------------------------------------------------------------------------------------------------------------------------------------------------------------------------------------------------------------------------------------------------------------------------------------------------------------------------------------------------------------------------------------------------------------------------------------------------------|
| Processor | Intel® Xeon® Third generation Scalable Processors |
| Appliance software version | Flex Appliance 3.2 or higher |
| Performance and capacity | <ul style="list-style-type: none"> ■ Supports high-performance processors with low-power consumption ■ Provides high efficiency and performance |
| System memory (each Appliance compute node) | <p>Base memory capacity: 768 GB, expandable to 1.5 TB</p> <p>Note: Higher memory capacities are capable depending on CPU population.</p> <p>Memory type: DDR4 RDIMM</p> <p>Configuration:</p> <ul style="list-style-type: none"> ■ 768 GB: 64 GB x 12 RDIMM modules on capacities less than 960 TB ■ 1536 GB: 64 GB x 24 RDIMM modules on capacities of 960 TB or greater <p>Note: If you want to upgrade your capacity to 950 GB or more, you have to purchase a 768 GB memory upgrade kit.</p> <p>Operating voltage: 1.2V</p> <p>Configured clock speed: 3200 MHz</p> |
| Usable MSDP and AdvancedDisk usable storage capacity (TB) | <p>AdvancedDisk usable storage capacity: up to 1,920 TiB (2,112 TB)</p> <p>MSDP storage capacity: up to 960TiB (1,056TB)</p> <p>See “Available appliance storage options” on page 31.</p> |
| VROC enabled OS RAID | Yes |
| SAS RAID PCIe card installed in a appliance compute node PCIe riser assembly | Yes |

Table 1-1 Veritas 5360 Appliance features (*continued*)

| Technical Specification | Veritas 5360 Appliance system | |
|------------------------------------------------------------------------------------------------------------------------------------------------------------------------|-------------------------------------------------------------------------------------------------------------------------------------------------------------------------------------------------------------------------------------------------------------------------------------------------------------------|-------------------------------------------------------------------------------------------|
| RAID levels | RAID1 (mirroring) and RAID6 (block level striping with double distributed parity) are used as follows: <ul style="list-style-type: none"> ■ RAID1: Appliance compute node system disks ■ RAID6 and RAID10: 5U84 Primary Storage Shelf and 5U84 Expansion Storage Shelf data storage disks | |
| Maximum number of storage shelves | 4 One required 5U84 Primary Storage Shelf and three optional 5U84 Expansion Storage Shelves See “Available appliance storage options” on page 31. | |
| I/O Ports See “Veritas 5360 Appliance I/O configuration options” on page 21. See “Total I/O on-board and PCIe ports” on page 23. | 12 Gb SAS-3 ports (PCIe-based) | 8 Used to connect the Veritas Appliance compute node to the 5U84 Primary Storage Shelf |
| | 10/25 GbE Ethernet/iSCSI-capable ports (PCIe-based) | Up to 8, depending on the appliance I/O configuration |
| | 32 Gb Fibre Channel ports (PCIe-based) | Up to six, depending on the appliance I/O configuration |
| | 10Gb/5Gb/2.5Gb/1Gb Ethernet ports (on-board) | 4 |

Locating the appliance serial number

The serial number is located on the rear panel of the appliance above PSU 1 and begins with letters VTAS.

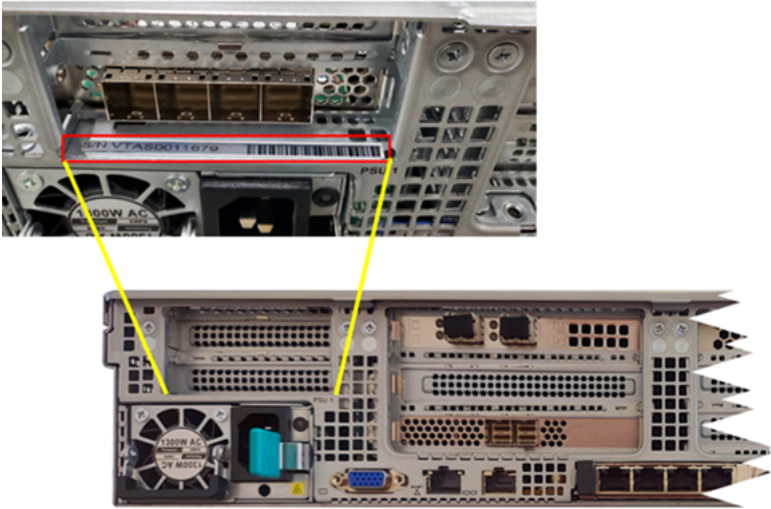

The serial number can also be found on the pull-out tab on the front of the appliance.

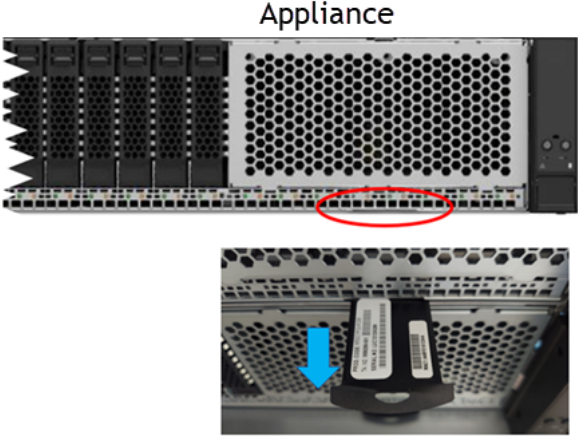

Compute node drive configurations

The Veritas 5360 Appliance compute node contains three Opal-compliant SED **only** 1.92 TB NVMe SSDs. Each SSD is accessible from the compute node's front panel. An embedded RAID controller on the compute node's mainboard configures two of the three SATA SSDs into a RAID1 volume.

The two RAID1 volumes contain the appliance operating system, the operating system swap file, the Flex application, and the logs. You can hot-swap one of these drives at a time if a drive becomes problematic. Replacements **must** be SED capable and of the same capacity. Or in other words, only like-for-like replacements are permitted.

The drives in slot 1 and slot 2 are configured as RAID1 with slot 3 as the hot spare. If a drive in the RAID volume experiences a hardware error, the appliance automatically initiates a RAID rebuild operation. During the rebuild operation, the appliance dynamically accesses the hot-spare drive and uses it to rebuild the RAID volume.

Figure 1-2 Compute node front drive



Table 1-2 Veritas 5360 Appliance compute node front panel drive configurations

| Slot | RAID level | Drive size (TB) | Drive role |
|------|------------|-----------------|---------------------------------|
| 0, 1 | RAID1 | 1.92 TB | Operating system and log volume |
| 2 | RAID1 | 1.92 TB | Operating system/log hot spare |
| 3-7 | RAID1 | - | blank |

About the drive LEDs

Figure 1-3 Appliance drive LEDs

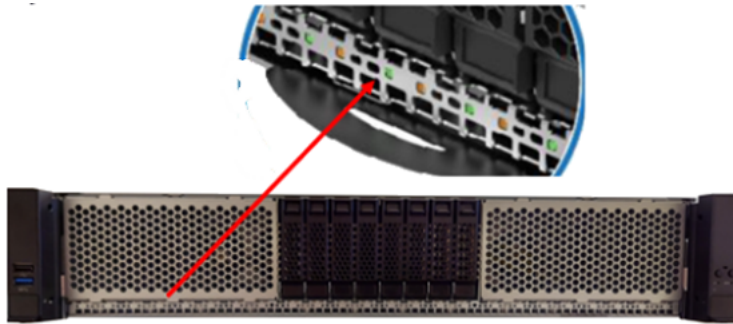

Table 1-3 Drive Status LED descriptions

| Description | LED behavior | Condition |
|------------------|----------------|-------------------------------------------------------------------------------------------|
| Amber Status LED | Off | No drive access and no disk drive faults |
| | Solid amber | A drive fault has occurred |
| | Blinking amber | A RAID rebuild is in progress (1Hz blink) Locating / identifying the drive (2Hz blink) |

Table 1-4 Drive Activity LED States

| Description | LED behavior | Condition |
|--------------------|----------------|---------------------------------------------------------------------------------------------|
| Green Activity LED | Off | Power on - the drive has spun down |
| | Solid green | Power on - no drive activity |
| | Blinking green | Power on - I/O is being processed by the drive or Power on - the drive is spinning up |

About the Veritas 5360 Appliance front panel USB port

The Veritas 5360 Appliance front panel includes a USB 3.0-compliant port that supports a data transfer rate of up to 500 Mb/second.

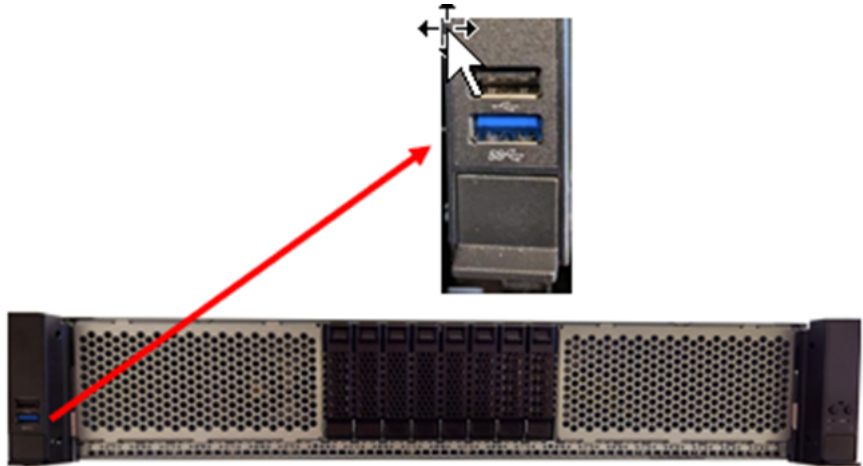

About the 5360 Appliance control panel

The front control panel provides push button system controls and LED indicators for several system features.

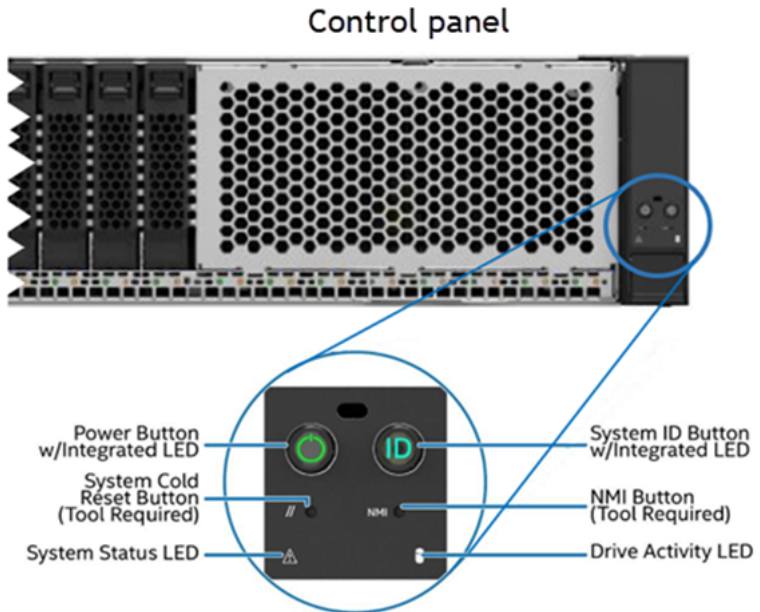

Table 1-5 Control panel system LED descriptions

| LED | System information |
|----------------------------------------------|-----------------------------------------------------------------------------------------------------------------------------------------------------------------------------------------------------------------------------------------------------------------------------------------------------------------------------------------------------------------------------------------------------------------------------------------------------------------------------------------------------------------------------------------------------------------------------------------------------------------------------------------------------------------------------------------------------------------------------------------------------------------------|
| Power button with integrated LED | <p>The Power button toggles the system on and off. This button also functions as a sleep button if enabled by an ACPI compliant operating system. Pressing this button sends a signal to the integrated BMC that either powers on or powers off the system. Holding the power button for 10 seconds or more leads to a hard shutdown.</p> <p>The integrated LED is a single color (green) and supports different indicator states as defined in the following table. See “About the Power button LED states” on page 18.</p> |
| Drive Activity LED | <p>The drive activity LED on the front panel indicates drive activity from the server board SATA and sSATA storage controllers. The server board also has an I2C header labeled “SAS_MODULE_MISC” to provide access to this LED for add-in SATA or sSATA storage controllers.</p> |
| System ID button with integrated LED | <p>Toggles the integrated ID LED and the blue server board system ID LED on and off. Both LEDs are tied together and show the same state. The onboard system ID LED is on the back edge of the server board, viewable from the back of the system. The system ID LEDs are used to identify the system for maintenance when installed in a rack of similar server systems. Two options available for illuminating the system ID LEDs are:</p> <ul style="list-style-type: none"> ■ The front panel system ID LED button is pushed, which causes the LEDs to illuminate to a solid On state until the button is pushed again. ■ An IPMI <code>Chassis Identify</code> command is remotely entered that causes the LEDs to blink for 15 seconds. |
| NMI button (recessed, tool required for use) | <p>When the NMI button is pressed, it puts the system in a halt state and issues a non-maskable interrupt (NMI). This situation can be useful when performing diagnostics for a given issue where a memory download is necessary to help determine the cause of the problem. To prevent an inadvertent system halt, the actual NMI button is behind the front control panel faceplate where it is only accessible with the use of a small tipped tool like a pin or paper clip.</p> |

Table 1-5 Control panel system LED descriptions (*continued*)

| LED | System information |
|--------------------------|------------------------------------------------------------------------------------------------------------------------------------------------------------------------------------------------------------------------------------------------------------------------------------------------------------------------------------------------------------------------------------------------------------------------------------------------------------------------------------------------------------------------------------------------------------------------------------------------------------------------------------------------------------------------------------------------------------------------------------------------------------------------------------------------------------------------------------------------------------------------------------------------------------------------------------------------------------------------------------------------------------------------------------------------------------------------|
| System Cold Reset Button | <p>When pressed, this button reboots and re-initializes the system. Unlike the power button, the reset button does not disconnect the power to the system. It just starts the system's Power-On Self-Test (POST) sequence over again.</p> |
| System Status LED | <p>The system status LED is a bi-color (green/amber) indicator that shows the current health of the server system.</p> <p>The system provides two locations for this feature; one is on the front control panel and the other is on the back edge of the server board, viewable from the back of the system. Both LEDs are tied together and show the same state. The system status LED states are driven by the server board platform management subsystem. When the server is powered down (transitions to the DC-Off state or S5), the BMC is still on standby power and retains the sensor and front panel status LED state established before the power-down event.</p> <p>Two locations are provided for you to monitor the health of the system. You can find the first location on the front control panel, while the second location is located on the back edge of the server board. It is viewable from the rear of the appliance. Both LEDs show the same state of health.</p> <p>See "About the System Status LED states" on page 15.</p> |

About the System Status LED states

The following table provides a description of each LED state.

Table 1-6 System Status LED states

| Color | State | Criticality | Description |
|----------|------------------------------------|-------------|----------------------------------------------------------------------------------------------------------------------------------|
| No color | Off - The system is not operating. | Not ready | <ul style="list-style-type: none"> ■ System power is off (AC and/or DC) ■ System is in EuP Lot6 Off Mode |

Table 1-6 System Status LED states (*continued*)

| Color | State | Criticality | Description |
|-------|---------------|----------------------------------------------------------------------------------------------------------------------------------------------------------------------------------------------------|---------------------------------------------------------------------------------------------------------------------------------------------------------------------------------------------------------------------------------------------------------------------------------------------------------------------------------------------------------------------------------------------------------------------------------------------------------------------------------------------------------------------------------------------------------------------------------------------------------------------------------------------------------------------------------------------------------------------------------------------------------------------------------------------------------------------------------------------------------------------------------------------------------------------------------------------------------------------------------------------------------------------------------------------------------------------------------------------------------------------------------------------------------|
| Green | Solid on (SO) | Healthy | <ul style="list-style-type: none"> ■ System is in S5 Soft-Off State ■ Indicates that the system is running (in S0 State) and its status is “Healthy”. The system is not exhibiting any errors. AC power is present and BMC has booted and manageability functionality is up and running. ■ After a BMC reset, and with the chassis ID solid on, the BMC is booting Linux*. Control has been passed from BMC uBoot to BMC Linux*. The BMC is in this state for roughly 10–20 seconds. |
| Green | ~1 Hz blink | <p>Degraded</p> <p>The system is operating in a degraded state although still functional.</p> <p>or</p> <p>The system is operating in a redundant state but with an impending failure warning.</p> | <p>System degraded:</p> <ul style="list-style-type: none"> ■ Redundant loss, such as power supply or fan. Applies only if the associated platform sub-system has redundancy capabilities. ■ Fan warning or failure when the number of fully operational fans is more than minimum number needed to cool the system. ■ Non-critical threshold crossed: Temperature (including HSBP temp), voltage, input power to power supply, output current for main power rail from power supply and Processor Thermal Control (Therm Ctrl) sensors. ■ Power supply predictive failure occurred while redundant power supply configuration was present. ■ Unable to use all of the installed memory (one or more DIMMs failed/disabled but functional memory remains available). ■ Battery failure ■ BMC executing in uBoot. (Indicated by Chassis ID blinking at 3Hz). System in degraded state (no manageability). BMC uBoot is running but has not transferred control to the BMC Linux. Server will be in this state 6-8 seconds after BMC reset while it pulls the Linux image into flash. |

Table 1-6 System Status LED states (*continued*)

| Color | State | Criticality | Description |
|-----------------------------|-------------|-----------------------------------------------------------------------------------------------------------------------------------------------------|-----------------------------------------------------------------------------------------------------------------------------------------------------------------------------------------------------------------------------------------------------------------------------------------------------------------------------------------------------------------------------------------------------------------------------------------------------------------------------------------------------------------------------------------------------------------------------------------------------------------------------------------------------------------------------------------------------------------------------------------------------------------------------------------------------|
| Green | ~1 Hz blink | Degraded (continued) | <p>System degraded (continued):</p> <ul style="list-style-type: none"> ■ BMC Watchdog has reset the BMC. ■ Power unit sensor offset for configuration error is asserted. ■ SSD Hot Swap Controller is off-line or degraded. |
| Green and amber alternately | ~1 Hz blink | System is initializing after source power is applied | <ul style="list-style-type: none"> ■ PFR in the process of updating/authenticating/recovering when source power is connected, system firmware being updated. ■ System not ready to take power button event/signal. |
| Amber | ~1 Hz blink | <p>Non-critical</p> <p>The system is operating in a degraded state with an impending failure warning. However, the system is still functioning.</p> | <p>Non-fatal, although the system is likely to fail due to the following issues:</p> <ul style="list-style-type: none"> ■ Critical threshold crossed – Voltage, temperature (including HSBP temp), input power to power supply, output current for main power rail from power supply and PROCHOT (Therm Ctrl) sensors. ■ VRD Hot asserted ■ Minimum number of fans to cool the system not present or failed ■ Hard drive fault ■ Power Unit Redundancy sensor – Insufficient resources offset (indicates not enough power supplies present) ■ In non-sparing and non-mirroring mode, if the threshold of correctable errors is crossed within the window. ■ Invalid firmware image detected during boot up or firmware update. |

Table 1-6 System Status LED states (*continued*)

| Color | State | Criticality | Description |
|-------|----------|----------------------------------------------|-----------------------------------------------------------------------------------------------------------------------------------------------------------------------------------------------------------------------------------------------------------------------------------------------------------------------------------------------------------------------------------------------------------------------------------------------------------------------------------------------------------------------------------------------------------------------------------------------------------------------------------------------------------------------------------------------------------------------------------------------------------------------------------------------------------------------------------------------------------------------------------------------------------------------------------------------------------------------------------------------------------------------------------------------------------------------------------------------------------------------------------------------------------------------------------------------------------------------------------------------------------------------------------------------------------------------------|
| Amber | Solid on | Critical, non-recoverable – System is halted | <p>Fatal alarm – system has failed or shutdown:</p> <ul style="list-style-type: none"> ■ CPU CATERR signal asserted ■ MSID mismatch detected (CATERR also asserts for this case) ■ CPU0 is missing ■ CPU Thermal Trip ■ No power – power fault ■ DIMM failure when there is only one DIMM present; no other good DIMM memory present ■ Runtime memory uncorrectable error in non-redundant mode. ■ DIMM Thermal Trip or equivalent ■ BMC/Video memory test failed (Chassis ID shows blue/solid-on for this condition) ■ SBB Thermal Trip or equivalent ■ 240VA fault ■ Both uBoot BMC FW images are bad (Chassis ID shows blue/solid-on for this condition) ■ Fatal Error in processor initialization: <ul style="list-style-type: none"> ■ Processor family not identical ■ Processor model not identical ■ Processor core/thread counts not identical ■ Processor cache size not identical ■ Unable to synchronize processor frequency ■ Unable to synchronize QPI link frequency ■ BMC fail authentication with non-recoverable condition, system hang at T-1; boot PCH only, system hang; PIT failed, system lockdown. |

About the Power button LED states

The following table provides a description of each power state.

Table 1-7 Power button LED states

| State | Power Mode | LED | Description |
|-------------|------------------------------------------------------|-----------|----------------------------------------------------------------------------------------------|
| Power - off | Non-ACPI | Off | The system power is off, and the BIOS has not initialized the chipset. |
| Power - on | Non-ACPI | On | The system power is on and the green Power button LED is active. |
| S0 | ACPI (Advanced Configuration and Power Interface) | Steady on | The system and the operating system are up and running. |
| S5 | ACPI (Advanced Configuration and Power Interface) | Off | Mechanical is off and the operating system has not saved any context to the hard disk drive. |

About the compute node rear panel

The rear panel of the appliance compute node has several access ports and other features.

The rear panel of the Veritas 5360 Appliance contains three PCIe riser card assemblies. PCIe riser card assemblies 1 and 2 each support three standard PCIe cards, while PCIe riser card assembly 3 supports two low profile PCIe cards.

Figure 1-4 Appliance rear panel and connectors

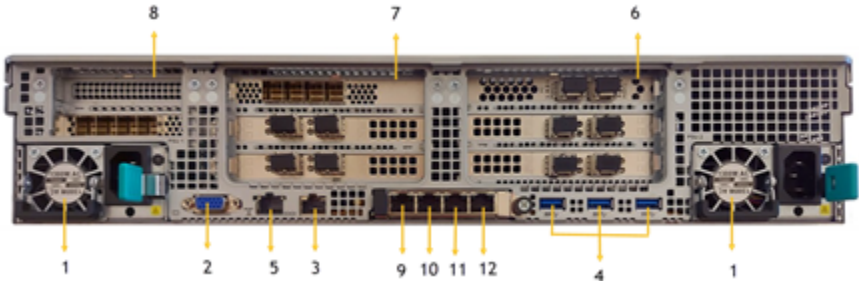

Table 1-8 Veritas 5360 Appliance rear panel features and connectors

| Number | Function |
|--------|-------------------------------------------------------------------------------------------------------------------------------------------------------------------------------------------------------------------|
| 1 | Power Supply 1 and Power Supply 2 - Dual, redundant, and hot-swappable power supply modules |
| 2 | DB-15 VGA monitor connector |
| 3 | Serial port - Serial connection for Veritas Technical Support use only |
| 4 | Three USB 3.0 Type A serial ports for general use |
| 5 | IPMI port - An external RJ45 port used for appliance remote management purposes |
| 6 | PCIe Riser # 1 |
| 7 | PCIe Riser # 2 |
| 8 | PCIe Riser # 3 |
| 9 | Flex Appliance (host1): A 1-10 GbE port copper connector that you can connect to an administrative network to manage the Appliance system. It is bonded with host0 during initial configuration as bond mgmt0. |
| 10 | Flex Appliance (host0): A 1-10 GbE port copper connector that you can connect to an administrative network to manage the Appliance system. It is bonded with host1 during initial configuration as bond mgmt0. |
| 11 | Flex Appliance (privnic1): A 1-10 GbE Private Low Latency Transport port that is used for connections between the two appliance compute nodes. |
| 12 | Flex Appliance (privnic0): A 1-10 GbE Private Low Latency Transport port that is used for connections between the two appliance compute nodes. |

Note: You should not bond copper 1-10 Gb Ethernet ports that are installed in the appliance chassis with PCIe-based 10/25 Gb Ethernet Fibre Channel ports.

Veritas appliances may include grounding studs in case your lab environment has such a requirement. The studs are located on the rear panel of the appliance. You can use standard grounding practices to connect grounding wires to the studs.

The serial number is located on the rear panel of the appliance.

The ports on the rear panel are color-coded for easy identification.

Figure 1-5 Veritas 5360 Appliance rear panel color codes

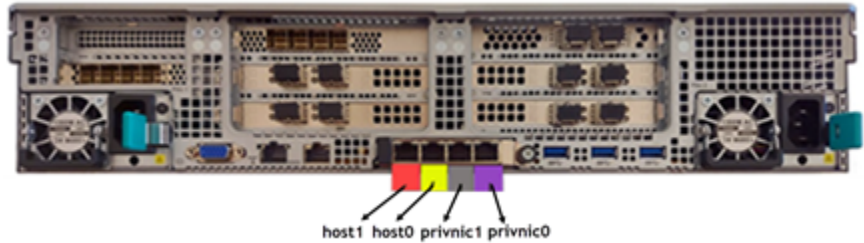

Veritas 5360 Appliance I/O configuration options

The rear panel of the Veritas 5360 Appliance contains three PCIe riser card assemblies. PCIe riser card assemblies 1 and 2 each support three standard PCIe cards, while PCIe riser card assembly 3 supports two low profile PCIe cards. The slots are labeled 1 to 8. Slots 1, 2, and 3 are located in PCIe riser card assembly 2. Slots 4, 5, and 6 are located in PCIe riser card assembly 1, while slots 7 and 8 are located in PCIe riser card assembly 3.

Figure 1-6 Rear panel riser assembly locations and PCIe slot number assignments

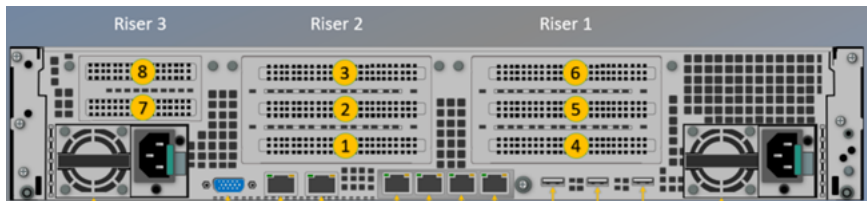

The Veritas 5360 Appliance supports multiple PCIe-based I/O configuration options. The following table shows the different I/O configuration options that are available.

Table 1-9 Available Veritas 5360 Appliance PCIe-based I/O configuration options

| I/O configuration option | Slot 1 | Slot 2 | Slot 3 | Slot 4 | Slot 5 | Slot 6 | Slot 7 | Slot 8 |
|--------------------------|---------------|---------------|---------|---------------|---------------|--------------|---------|--------|
| A | 10/25 GbE NIC | 10/25 GbE NIC | SAS HBA | 10/25 GbE NIC | 10/25 GbE NIC | 32 Gb FC HBA | SAS HBA | - |
| B | 10/25 GbE NIC | 10/25 GbE NIC | SAS HBA | 10/25 GbE NIC | 32 Gb FC HBA | 32 Gb FC HBA | SAS HBA | - |
| C | 10/25 GbE NIC | 10/25 GbE NIC | SAS HBA | 32 Gb FC HBA | 32 Gb FC HBA | 32 Gb FC HBA | SAS HBA | - |

For more information, see the *Veritas™ Flex 5360 Appliance Cabling Poster*.

Figure 1-7 Flex 5360 Model A

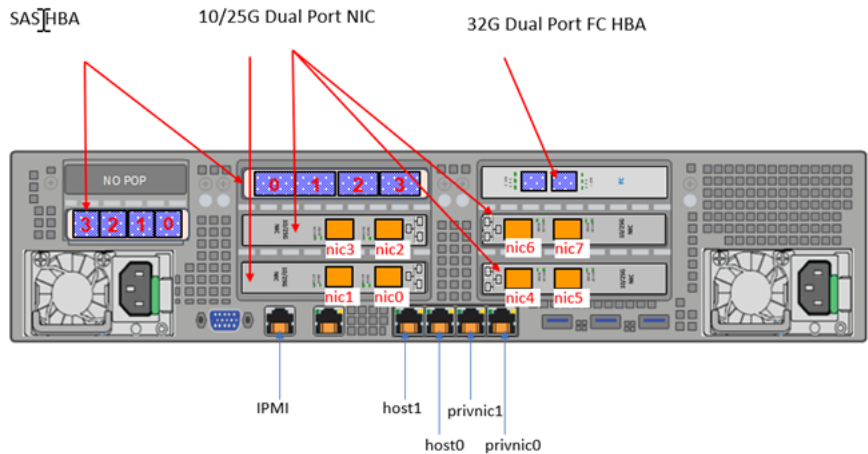

Figure 1-8 Flex 5360 Model B

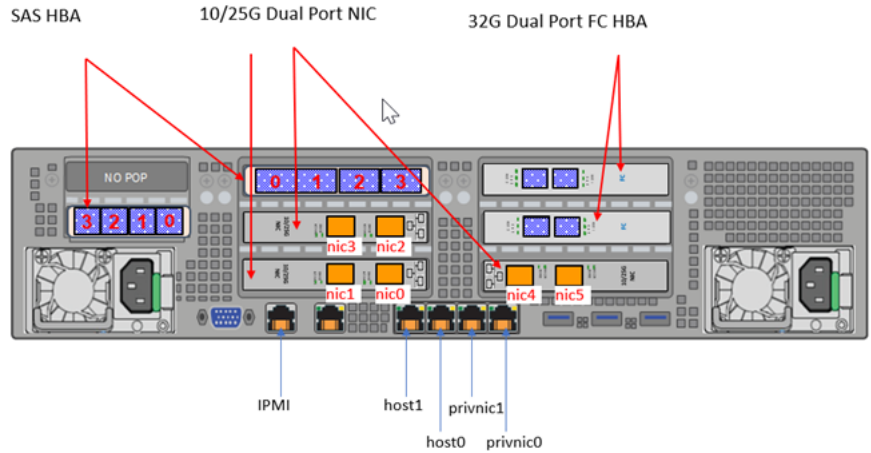
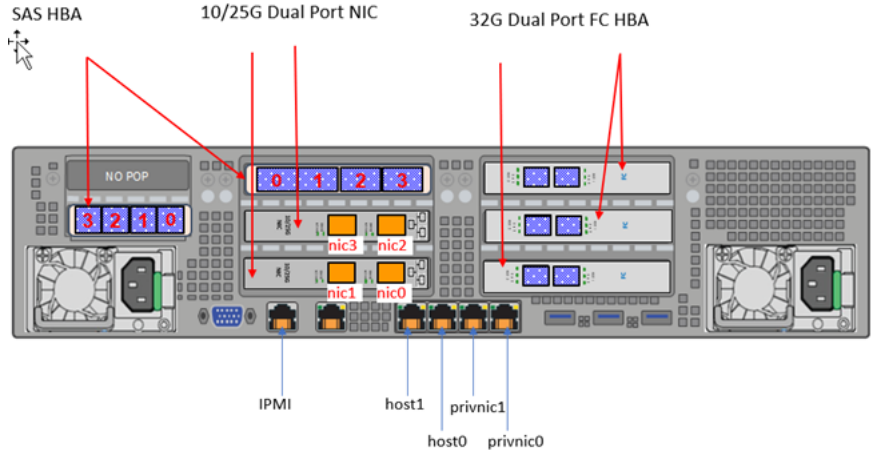

Figure 1-9 Flex 5360 Model C



Total I/O on-board and PCIe ports

The following table shows the total I/O on-board and PCIe ports options that are available in the Veritas 5360 Appliance.

Table 1-10 Total number of on-board and PCIe I/O ports for each I/O configuration

| I/O Configuration option | 10 Gb Ethernet ports (copper) | 10/25 Gb Ethernet PCIe ports (optical/SFP) | 32 Gb Fibre Channel PCIe ports (optical/SFP) |
|--------------------------|-------------------------------|--------------------------------------------|----------------------------------------------|
| A | 4 on-board | 8 | 2 |
| B | 4 on-board | 6 | 4 |
| C | 4 on-board | 4 | 6 |

Cable connection types:

copper = Standard copper cable

optical = Fiber optic cable

Available I/O configurations by slot for Veritas 5360 Appliance

You can use the supported Veritas 5360 Appliance I/O configurations to best serve the needs of your particular environment. The controller is installed in both non-shelf and with-shelf configurations

The following table provides information on the make and model of each the PCIe cards that are available for use in each appliance I/O slot.

Table 1-11 Acceptable PCIe-based I/O cards for each appliance I/O slot

| Slot | Acceptable PCIe I/O card | Comment |
|------|--------------------------------------------------------|--------------------------------------------------------------------|
| 1 | Broadcom P225p Ethernet card | PCIe based 10/25 Gb Ethernet card |
| 2 | Broadcom P225p Ethernet card | PCIe based 10/25 Gb Ethernet card |
| 3 | Intel RS3P4GF016J Storage Adapter | PCIe-based 16-port SAS HBA storage adapter and external controller |
| 4 | Broadcom P225p Ethernet card | PCIe based 10/25 Gb Ethernet card |
| | Marvell QLE2772 dual-port 32 Gb Fibre Channel HBA card | PCIe-based 32 Gb Fibre Channel dual-port Host Bus Adapter card |
| 5 | Broadcom P225p Ethernet card | PCIe-based 25/10Gb network interface card |
| | Marvell QLE2772 dual-port 32 Gb Fibre Channel HBA card | PCIe-based 32 Gb Fibre Channel dual-port Host Bus Adapter card |

Table 1-11 Acceptable PCIe-based I/O cards for each appliance I/O slot
(continued)

| Slot | Acceptable PCIe I/O card | Comment |
|------|--------------------------------------------------------|---------------------------------------------------------------------|
| 6 | Marvell QLE2772 dual-port 32 Gb Fibre Channel HBA card | PCIe-based 32 Gb Fibre Channel dual-port Host Bus Adapter card |
| 7 | Intel RS3P4GF016J Storage Adapter | PCIe-based 16-port SAS HBA storage adapter and external controller. |
| 8 | Open | Open |

Broadcom P225p 10/25Gb PCIe Ethernet card

The Broadcom® BCM957414A4142CC is a dual-port 25 Gb/s, PCI-Express Gen3 x8 Network Interface Card that supports both SFP28/SFP+ optical modules and copper direct attach cable. The card uses the Broadcom BCM57414 25GbE MAC controller with the integrated dual channel 25GbE SFI transceiver.

By default, a 10 GB SFP is shipped with the appliance.



Note: Veritas recommends that you use Finisar FTLX8574D3BCV SFP part for 10G connectivity and Broadcom AFBR-735SMZ SFP part for 25G connectivity.

Table 1-12 Broadcom P225p NIC adapter specifications

| Item | Specification |
|------------------------------|---------------------------------------------|
| Bracket height | Full height |
| Power consumption | Typical: 12.5 watts Maximum: 12.9 watts |
| Operating temperature | 0°C to 55°C (32 F to 131 F) |
| Storage temperature | -40°C to +70°C (-49°F to +221°F) |
| Storage humidity | 90% at 35°C |
| System interface type | PCIe v3.0 |
| Speed and slot width | 8.0 GT/s (gigatransfers per second), 8-Lane |
| Data rate supported per port | 10/25Gb |
| Air Flow (minimum) | 150 LFM (linear feet per minute) |

QLE2772 dual-port 32 Gb Fibre Channel host bus adapter

The QLE2772 dual-port 32 Gb Fibre Channel (FC) host bus adapter connects the appliance compute node to the 5U84 Primary Storage Shelf.



Table 1-13 QLE2772 dual-port 32Gb Fibre Channel host bus adapter specifications

| Item | Description | | | | |
|---------------------------|---------------------------------------------------|----------------------------------------------------------|------------|------------|------------|
| Bracket height | Full Height | | | | |
| Form factor | Low-profile PCIe card (6.6 inches × 2.731 inches) | | | | |
| Power consumption (watts) | Nominal: 11.0 W Maximum: 13.7 W | | | | |
| Operating temperature | 0°C to 55°C (32°F to 131°F) | | | | |
| Storage temperature | -20°C to 70°C (-4°F to 158°F) | | | | |
| Operating humidity | 10% to 90% | | | | |
| Storage humidity | 5% to 95% | | | | |
| System interface type | PCIe v4.0 | | | | |
| Certifications | UL, CSA, TUV, CB, FCC, VCCI | | | | |
| Maximum cable distances | Rate | Cable and Distance (m) (multimode optic cable) | | | |
| | | OM2 | OM3 | OM4 | OM5 |
| | 8 Gbps | 50 | 150 | 190 | 190 |
| | 16 Gbps | 35 | 100 | 125 | 125 |
| | 32 Gbps | 20 | 70 | 100 | 100 |

Intel Storage Adapter RS3P4GF016J

The RS3P4GF016J is an Intel 16-port SAS HBA storage adapter and external controller.

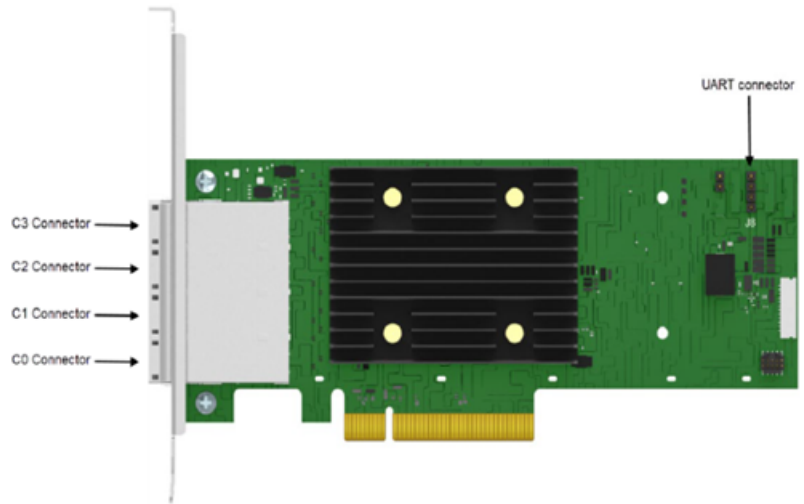

Table 1-14 RS3P4GF016J storage adapter specifications

| Item | Specification |
|------------------------------|-------------------------------------------------------|
| Bracket height | Low profile mounting bracket |
| Power consumption | Typical: 8.74 watts Maximum: 11.89 watts |
| Operating temperature | 0°C to 55°C (32 F to 131 F) |
| Storage temperature | -45°C to +105°C (-49°F to +221°F) |
| Storage humidity | 20-80% RH (operating) 05-95% RH (non-operating) |
| System interface type | PCIe v4.0 (x8 PCI Express* 4.0 PCIe*) |
| Speed and slot width | 16 GT/s (gigatransfers per second), per lane |
| Data rate supported per port | 12, 6, 3 Gbps per port SAS 6, 3 Gbps per port SATA |
| Air Flow (minimum) | 200 LFM (linear feet per minute) |

About the Veritas 5U84 Storage Shelves

This chapter includes the following topics:

- [About Veritas 5360 Appliance storage shelves](#)
- [About the 5U84 Primary Storage Shelf and 5U84 Expansion Storage Shelf rear components](#)

About Veritas 5360 Appliance storage shelves

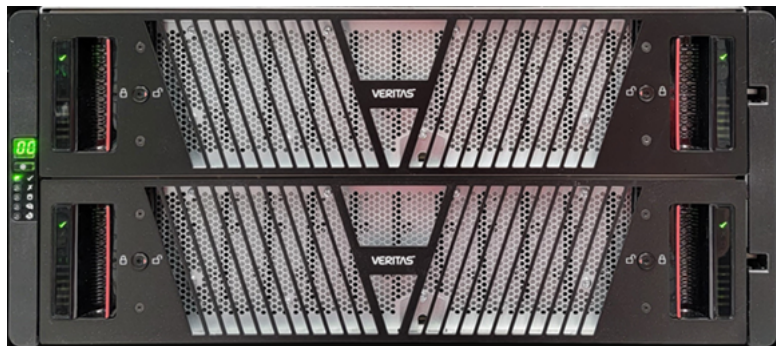

Veritas offers two external storage shelf models for the Veritas 5360 Appliance.

These include the:

- Veritas 5U84 Primary Storage Shelf (required)
- Veritas 5U84 Expansion Storage Shelf (optional)

Both of the 5U84 Storage Shelf chassis include a set of common internal core components, along with a set of plug-in modules.

The core components include:

- Two sliding disk drawers that contain Disk Drive In Carrier (DDIC) modules
- A front operations panel
- A front bezel
- Mid-plane printed circuit boards (PCB) that interface with controllers on the 5U84 Primary Storage Shelf and the 5U84 Expansion Storage Shelf.

In addition to the core components, the storage shelves also incorporate the following plug-in modules:

- Two 12Gb SAS-3 RAID controller modules (*5U84 Primary Storage Shelf only*)
- Two Storage Bay Bridge 2.1-compliant Expansion I/O controller modules (*5U84 Expansion Storage Shelf only*)
- Two power supply units (PSUs)
- Five fan modules
- Up to 84 Disk Drive In Carrier (DDIC) modules with drives installed
- A rail kit for rack mounting

The 5U84 Primary Storage Shelf and the 5U84 Expansion Storage Shelf each use a 5U chassis. Each chassis contains two sliding disk drive drawers that are located in the front of the storage shelf. Each drawer holds 42 Disk Drive In Carrier (DDIC) modules. The DDIC modules are installed in the drive drawer slots, which hold a total of 84 disk drives. Each DDIC module holds SAS-3, 7200 rpm hard disk drives, in either 4TB or 8TB capacities. The disk drives and the DDIC modules are hot-swappable and can be replaced on-site while the storage shelf is operational.

Note: Whether you use 4TB or 8TB disk drives in the storage shelves, each storage shelf drawer must be populated with disk drives of the same capacities.

In each storage shelf, two disk drives are used as global hot spares. Four of the disk drives provide storage space for a dedicated RAID 10 metadata volume group. When 4TB disk drives are used, the storage shelf provides 7.27TBs of metadata storage capacity. When 8TB disk drives are used, the storage shelf provides 15.75TBs of metadata storage capacity. The remaining disks are configured in a storage group that uses RAID 6 disk array technology. These disks are used for MSDP and AdvancedDisk data storage purposes. Depending on the storage configuration you purchase, the Appliance storage system supports up to 1,920TiBs of usable data storage space.

Note: RAID10 is also known as RAID 1+0. It combines disk mirroring and disk striping to protect data.

Available appliance storage options

The Veritas 5360 Appliance compute nodes do not contain internal disk space on which to store data. Instead, the 5360 Appliance uses the required Veritas 5U84 Primary Storage Shelf as the main data storage device. The 5U84 Primary Storage Shelf connects to the 5360 Appliance compute nodes and uses RAID 6 drive sets to protect the stored data.

Note: RAID 6 is also known as double-parity RAID. It uses two parity stripes on each disk to protect data. RAID 6 allows for two hard disk failures within the RAID disk array before any data is lost.

If additional data storage space is required, you can connect up to three optional Veritas 5U84 Expansion Storage Shelves to the existing 5U84 Primary Storage Shelf. The 5U84 Expansion Storage Shelves connect to the 5U84 Primary Storage Shelf using SAS-3 data cables. After connecting the shelves, the disk drives in the 5U84 Expansion Storage Shelf use RAID 6 sets that are controlled by the 5U84 Primary Storage Shelf to protect the stored data.

Note: Veritas does not support mixing 4TB and 8TB disk drives within a storage shelf.

Table 2-1 Usable *Veritas 5360 Appliance* 5U84 Storage Shelf storage capacities by disk drive capacities

| Usable storage capacities (4-TB Drives) | Usable storage capacities (8-TB Drives) |
|-----------------------------------------|-----------------------------------------|
| 132TB (120TiB) | 264TB (240TiB) |
| 264TB (240TiB) | 528TB (480TiB) |
| 396TB (360TiB) | 792TB (720TiB) |
| 528TB (480TiB) | 1,056TB (960TiB) ^{***} |

Table 2-1 Usable *Veritas 5360 Appliance* 5U84 Storage Shelf storage capacities by disk drive capacities (*continued*)

| Usable storage capacities (4-TB Drives) | Usable storage capacities (8-TB Drives) |
|-----------------------------------------|-----------------------------------------|
| 660TB (600TiB) | 1,320TB (1200TiB) ^{* **} |
| 792TB (720TiB) | 1,583TB (1440TiB) ^{* **} |
| 924TB (840TiB) | 1,847TB (1680TiB) ^{* **} |
| 1,056TB (960TiB) ^{**} | 2,112TB (1920TiB) ^{**} |

^{*}Veritas 5360 Appliance supports up to 1,056TB (960TiB) of usable MSDP storage capacity. For all storage configurations with an aggregate total of all MSDP pools equaling 960TB or larger, Veritas strongly recommends upgrading the memory capacity to 1536GB.

^{**} For these storage shelf configurations, Veritas strongly recommends that you upgrade the memory capacity to 1.5TB due to the increased resource requirements from updated MSDP encryption standards.

Figure 2-1 5U84 Storage Shelf (capacity with 4TB drives (half and full))

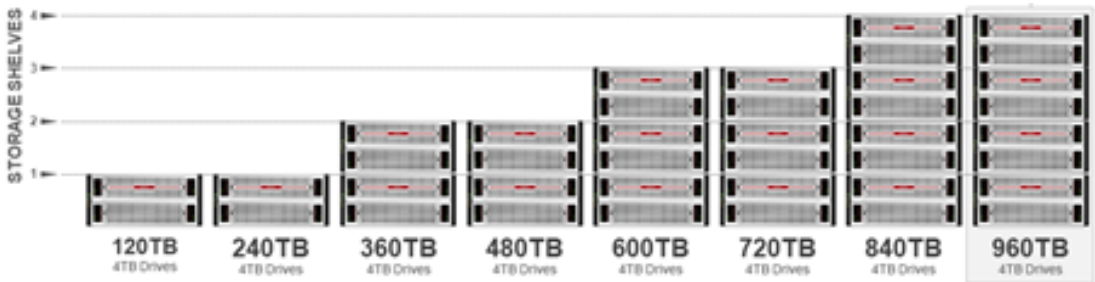

Figure 2-2 5U84 Storage Shelf (capacity with 8TB drives (half and full))



To determine the hardware configuration for the storage capacities that your environment requires, contact your Veritas sales representative, or your Veritas Partner representative.

About the Veritas 5U84 Storage Shelf disk drive drawers

This section discusses the 5U84 Primary Storage Shelf and 5U84 Expansion Storage Shelf disk drive drawers and the components that comprise the drawers.

Disk drive drawers

Figure 2-3 5U84 Primary Storage Shelf/5U84 Expansion Storage Shelf disk drive drawer



The 5U84 Primary Storage Shelf and the 5U84 Expansion Storage Shelf each use a 5U chassis. Each chassis contains two sliding drawers that are accessible from the front of the storage shelves. Each drawer holds 42 Disk Drive In Carrier (DDIC) modules. The DDIC modules are installed in each of the drive drawer slots, which can hold a total of 84 disk drives. Each DDIC module holds one 3.5" SAS-3, 7200 rpm hard disk drive, in either 4-TB or 8-TB capacities. The disk drives and the DDIC modules are hot-swappable and can be replaced on-site while the storage shelf is operational.

Disk drive slot numbering

Each disk drive drawer in a 5U84 storage shelf is divided into three compartments. The compartments contain the individual drive slots that hold the DDIC modules and the disk drives.

In the top drive drawer, the drive slots are numbered from left to right, beginning with the first compartment that is closest to the front panel. The drive slots in this compartment are numbered 0 to 13. The drive slots in the second compartment are in the middle of the drive drawer. These slots are numbered 14 to 27. The drive slots in third compartment are closest to the rear of the shelf. These slots are numbered 28 to 41.

In the bottom drive drawer, the drive slots are numbered from left to right, beginning with the first compartment that is closest to the front panel. The drive slots in this compartment are numbered 42 to 55. The drive slots in the second compartment are in the middle of the drive drawer. These slots are numbered 56 to 69. The drive slots in third compartment are closest to the rear of the shelf. These slots are numbered 70 to 83.

See [Figure 2-4](#) on page 35.

Figure 2-4 Disk drive slot numbering of a half-populated storage shelf

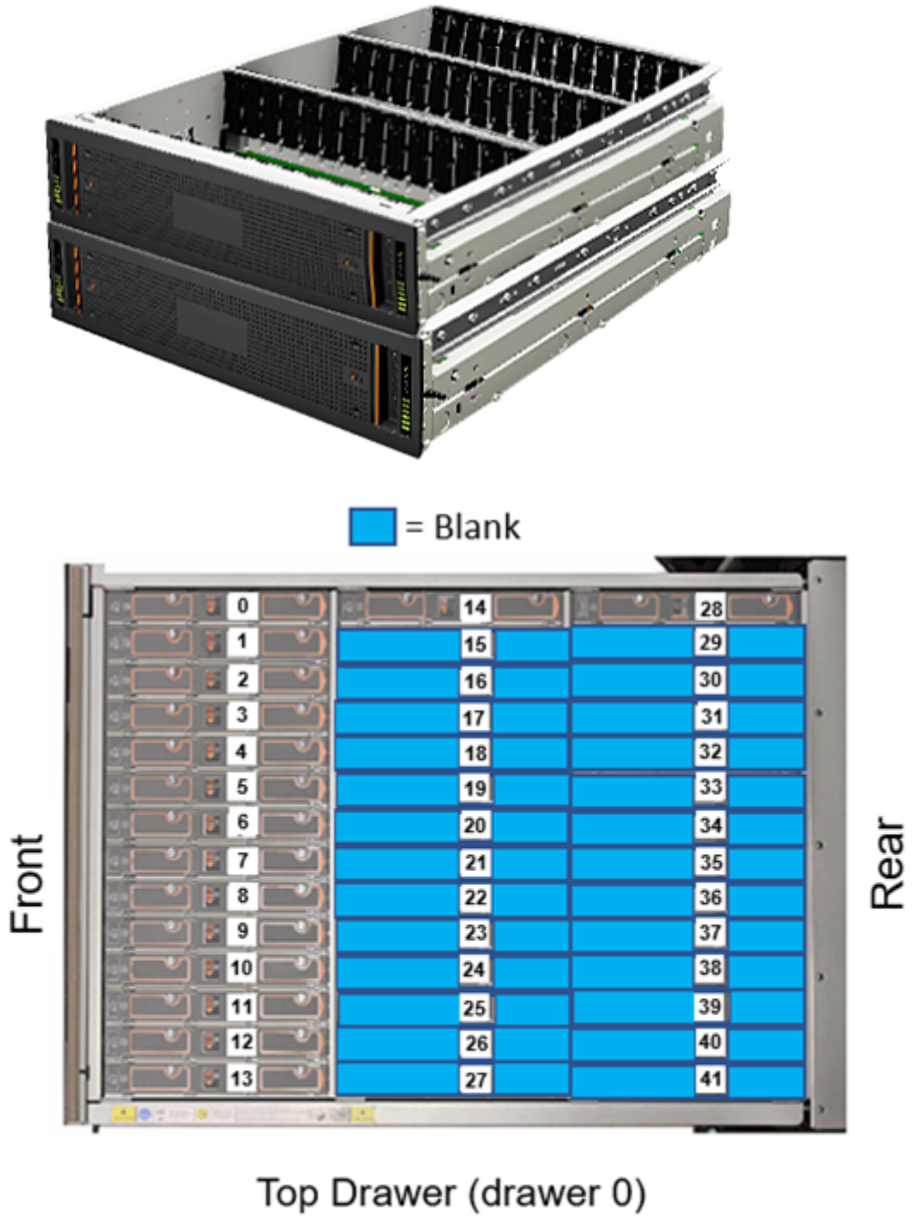

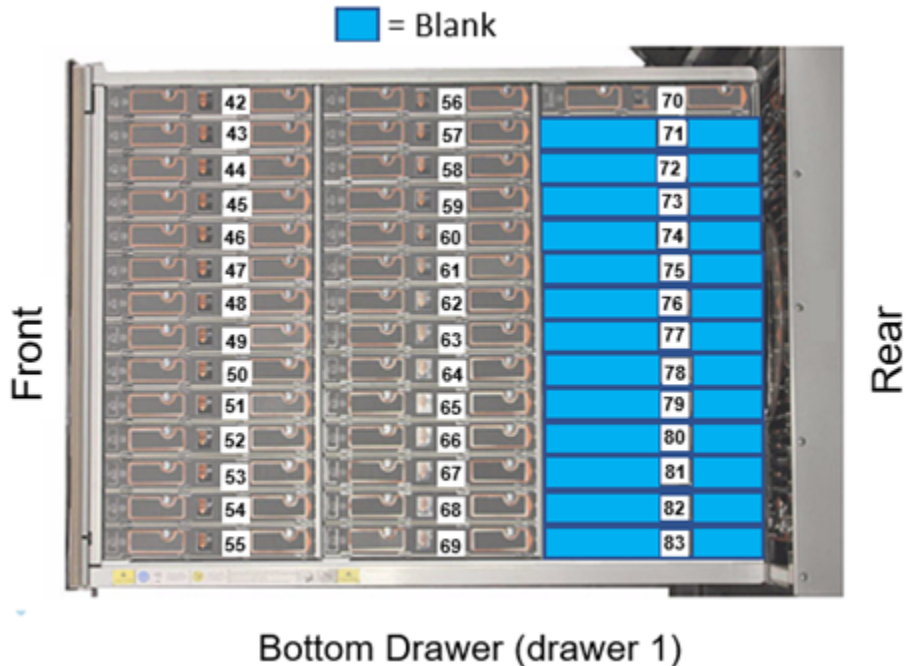

Disk Drive In Carrier (DDIC) modules

All storage shelf hard disk drives are housed in DDIC modules. Each disk drive drawer accepts a Disk Drive In Carrier (DDIC) module for each disk drive slot in the drawer. DDIC modules enable disk drives to be quickly inserted and removed without turning off the 5U84 storage shelves. In addition, each DDIC prevents mis-alignment and damage to the disk drive connectors during the disk drive insertion and removal process.

For troubleshooting purposes, DDIC modules provide one amber drive fault LED indicator per disk drive. The fault indicator enables you to easily identify a failed drive carrier in the drive drawer. You can see drive fault LED indicator when the disk drive drawer is open.

Figure 2-5 Disk Drive In Carrier (DDIC) module



Figure 2-6 Disk Drive In Carrier (DDIC) module components and locations

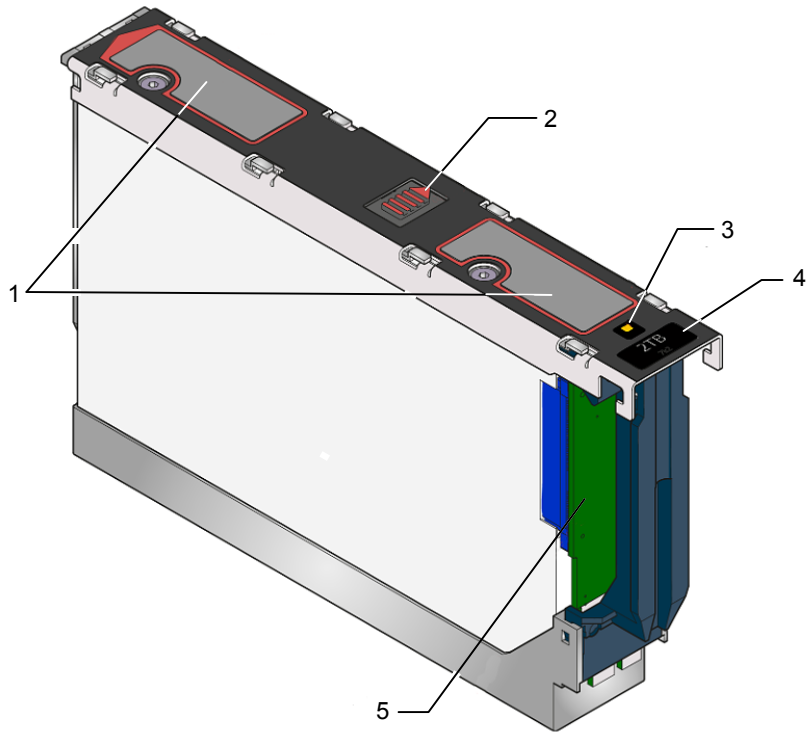

Table 2-2 5U84 Storage Shelf DDIC component locations

| Number | Component |
|--------|--------------------------------------------------------------------------------------------------------------------------------|
| 1 | Touch points Note: Touch points are used to facilitate the removal of the DDIC module from the storage shelf drawer. |
| 2 | Latch button |
| 3 | Drive Fault LED |
| 4 | Disk drive capacity label |
| 5 | Dongle |

Disk Drive Drawer printed circuit board (PCB) assemblies

Each disk drive drawer in a 5U84 storage shelf uses a printed circuit board (PCB) assembly to provide the electrical connectivity to the drawer's disk drives.

Along with providing the electrical connectivity to the disk drives, PCB assemblies also provide:

- Mounting platforms for the drawer cabling system
- Redundant power paths to each disk drive
- Redundant 12Gb/s SAS signal paths to each disk drive
- Provide technical feedback to the system when a drawer is opened or closed.

PCB assemblies include the following components:

- Three drawer Baseplane cards
- One right side Drawer Sideplane card
- One left side Drawer Sideplane card

Figure 2-7 Disk Drive Drawer PCB assembly

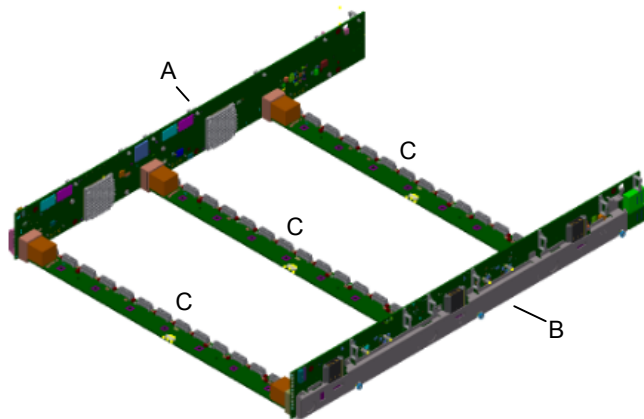

Table 2-3 Disk drive drawer PCB assembly components

| Label | Item |
|-------|-------------------------------|
| A | Drawer Sideplane card (left) |
| B | Drawer Sideplane card (right) |
| C | Baseplane card |

Each PCB assembly contains two Drawer Sideplane cards. One Sideplane card mounts on the right side of the disk drawer, while the other card mounts on the left side of the drawer.

Drawer Sideplane cards provide power paths to the drawer Baseplanes and the DDICs and their installed disk drives. Sideplane cards also provide 12Gb/s SAS connections.

Sideplane cards are hot swappable and replaceable by service personnel while the storage shelf is running in a rack.

Note: Removing the Sideplane upper metal cover removes power to the Sideplane, which enables the faulty Sideplane to be hot-swapped.

Figure 2-8 Inside and outside views of a right side Sideplane card

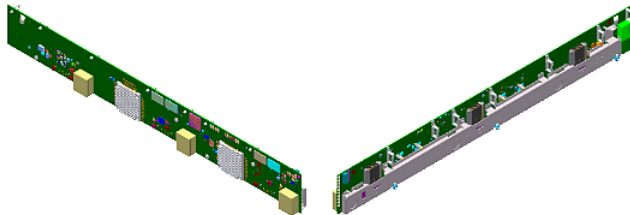

Three Drawer Baseplanes comprise each PCB assembly. Drawer Baseplanes provide a dual path for 12Gb/s SAS connectivity between the Drawer Sideplane cards and the DDICs. They also provide power to the DDICs from either the right or the left Drawer Sideplane cards.

The Drawer Baseplanes also provide four remote temperature sensing diodes that monitor disk drive temperatures within the disk drive drawers.

Figure 2-9 Drawer Baseplane example

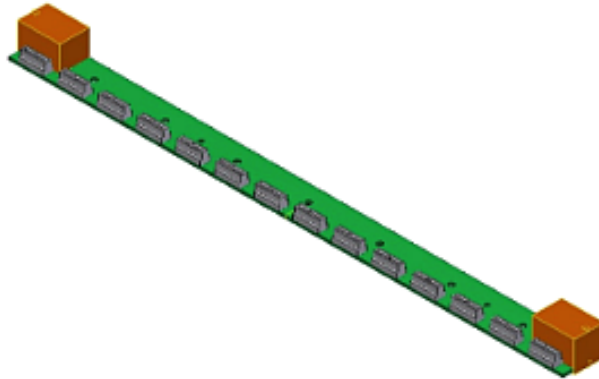

Drawer Sideplane Status panels

Drawer Sideplane Status panels are located on the front of the 5U84 storage shelves. These panels provide status and the activity information about the Sideplane card.

Figure 2-10 Drawer Sideplane Status panel locations



Figure 2-11 5U84 Primary Storage Shelf / 5U84 Expansion Storage Shelf
 Drawer Sideplane Status panel

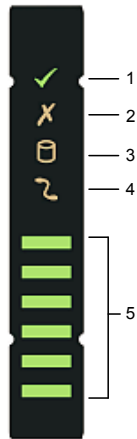

Table 2-4 Drawer Sideplane Status panel descriptions

| Number | Item |
|--------|--------------------------------|
| 1 | Sideplane card OK / Power good |
| 2 | Sideplane card Fault |
| 3 | Logical Fault |
| 4 | Cable Fault |
| 5 | Activity Bar Graph |

The following table describes the Drawer Sideplane LED statuses.

Table 2-5 Drawer Sideplane LED statuses

| Status | Power (Green) | Drawer Fault (Amber) | Cable Fault (Amber) | Logical Fault (Amber) | Activity Bar Graph (Green) |
|---------------------------------------------|------------------|-------------------------|------------------------|--------------------------|----------------------------------|
| Drawer Sideplane card OK / Power Good | On | Off | Off | Off | X |
| Drawer Sideplane card Fault | Off | On | X | X | Off |

Table 2-5 Drawer Sideplane LED statuses (*continued*)

| Status | Power (Green) | Drawer Fault (Amber) | Cable Fault (Amber) | Logical Fault (Amber) | Activity Bar Graph (Green) |
|-----------------------------------------------------------------------|---------------|----------------------|---------------------|-----------------------|----------------------------|
| Drive failure has occurred causing loss of availability or redundancy | On | On | X | X | X |
| Array in impacted state (SES) Indicated | On | X | X | Flashing | X |
| Cable Fault | Off | X | On | X | Off |
| Drive Activity | On | Off | Off | Off | On * |

X = Disregard

* The Activity Bar Graph is a six-segment indicator that shows activity of the SAS disk drive interface to the Sideplane. If none of the segments are lit, then there is no SAS disk drive activity occurring. Increasing disk drive activity is measured upward, starting with the bottom segment. When full disk drive activity occurs, all six segments are lit.

Drawer Sideplane hot swap LED indicators

Drawer Sideplane hot-swap LED indicator lights are mounted on each drawer's Sideplane printed circuit board assembly. They are visible through each Sideplane's metal frame when the drawer is open.

Figure 2-12 Drawer Sideplane hot-swap LED location

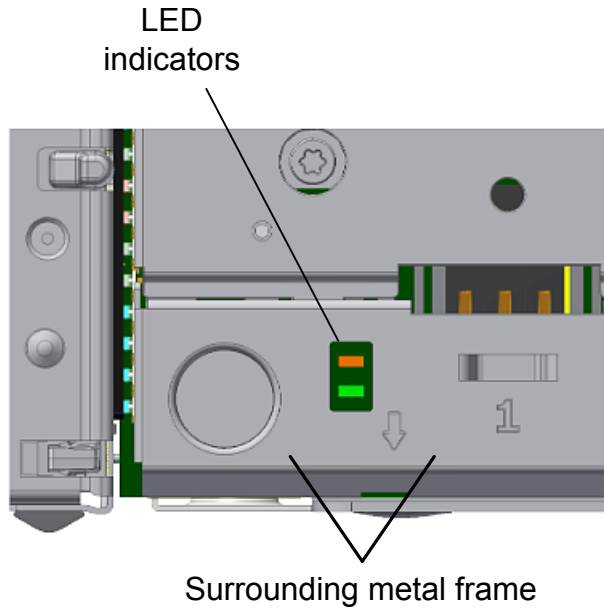

The following table describes the Drawer hot-swap Sideplane LED indicator statuses.

Table 2-6 Drawer Sideplane Hot-swap LED indicator statuses

| Status | 12V Power LED (Green) | Power disabled LED (Amber) |
|----------------------------------------------------------------|-----------------------|----------------------------|
| Sideplane 12V power present (DO NOT hot-swap the sideplane) | On | X |
| Sideplane 12V is disabled (OK to hot-swap the Sideplane) | Off | On |

X = Disregard

5U84 Primary Storage Shelf and the 5U84 Expansion Storage Shelf control panel

The control panel is installed on the left side of both the 5U84 Primary Storage Shelf and the 5U84 Expansion Storage Shelf. It is functionally the same for both systems.

Figure 2-13 Control panel location



Figure 2-14 Control panel

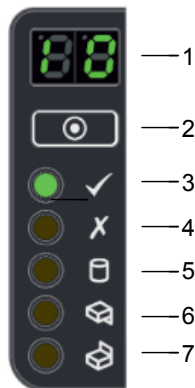

The following table describes the control panel functions.

Table 2-7 Control panel functions and descriptions

| Number | Function | Description |
|--------|--------------------------------------------------------------------|-----------------------------------------------------------------------------------------------------------------------------------------------------------------------------------------------------------------------------------------------------------------------------------------------------------|
| 1 | Unit Identification Display | The Unit Identification Display is a dual digit display that provides information about the storage shelf. Its primary function is to assist in the configuration of multiple storage shelves that are connected to the appliance. |
| 2 | Input button | The Input button enables you to set the Unit Identification display number. |
| 3 | Power On / Standby LED (Green or Amber) | The Power On/Standby LED shows Amber when only standby power is available. Otherwise, the LED shows Green when system power is available. |
| 4 | Module Fault LED (Power Cooling Module, I/O module status) (Amber) | The Module Fault LED illuminates when there is a system hardware fault. The system hardware fault may be associated with a fault LED on a Power Cooling Module (PCM) or on an I/O module. |
| 5 | Logical Fault LED (Amber) | The Logical Status LED shows a change of status or a fault. Typically these changes of status or faults are associated with the shelf's disk drives. However, the Logical Status LED can also indicate an issue with an internal RAID controller or external RAID controller, or with a host bus adapter. |
| 6 | Top Drawer Fault (Amber) | The Top Drawer Fault LED (drawer 1) shows a change of status or a fault with the top disk drive drawer in the storage shelf. |
| 7 | Bottom Drawer Fault (Amber) | The Bottom Drawer Fault LED (drawer 2) shows a change of status or a fault with the bottom disk drive drawer in the storage shelf. |

About the 5U84 Primary Storage Shelf and 5U84 Expansion Storage Shelf rear components

This section describes the rear components of the 5U84 Primary Storage Shelf and 5U84 Expansion Storage Shelf.

The 5U84 Primary Storage Shelf and the 5U84 Expansion Storage Shelf contain the following removable rear components:

- SAS-3 RAID Controllers (*5U84 Primary Storage Shelf only*)
- Expansion I/O modules (*5U84 Expansion Storage Shelf only*)

- Fan modules
- Power Supply Units (PSUs)

Figure 2-15 5U84 Primary Storage Shelf rear components

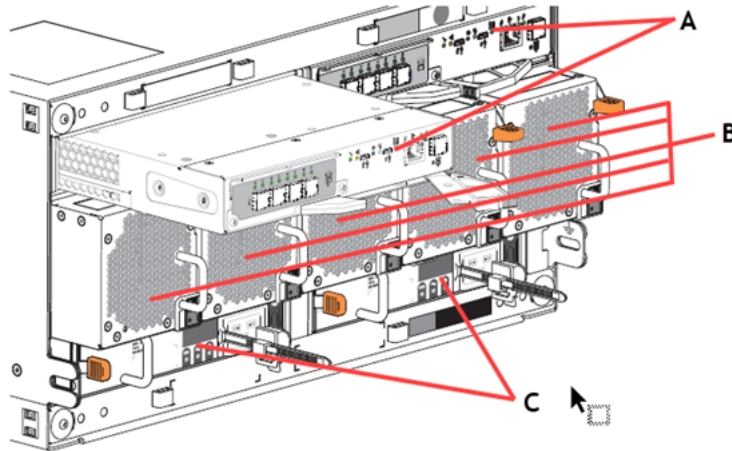

Table 2-8 5U84 Primary Storage Shelf rear component locations

| Letter | Item |
|--------|--------------------------------------------------------------------------------------------------------------|
| A | RAID Controllers (from left to right) RAID Controller A, RAID Controller B |
| B | Fan modules (from left to right) Fan Module 0, Fan Module 1, Fan Module 2, Fan Module 3, and Fan Module 4 |
| C | Power Supply Units (from left to right) PSU 0, PSU 1 |

Figure 2-16 5U84 Expansion Storage Shelf rear components

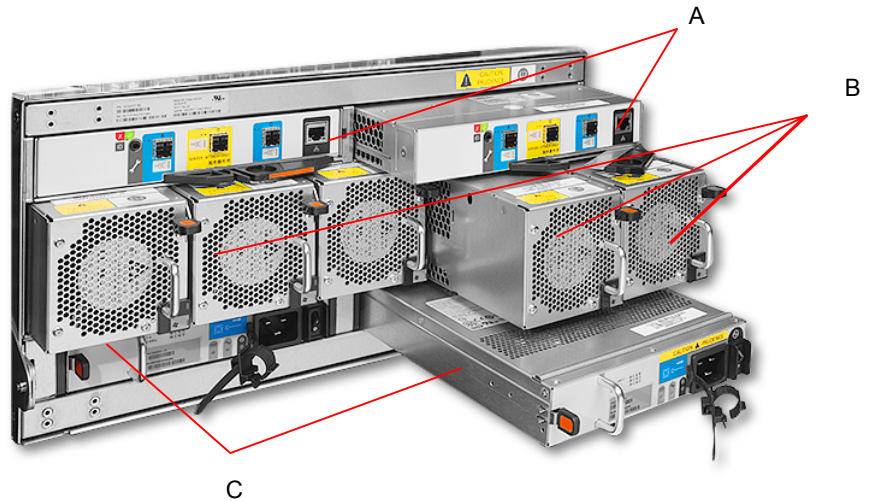

Table 2-9 5U84 Expansion Storage Shelf rear component locations

| Letter | Item |
|--------|--------------------------------------------------------------------------------------------------------------|
| A | Expansion I/O modules (from left to right) Expansion I/O Module A, Expansion I/O Module B |
| B | Fan modules (from left to right) Fan Module 0, Fan Module 1, Fan Module 2, Fan Module 3, and Fan Module 4 |
| C | Power Supply Units (from left to right) PSU 0, PSU 1 |

5U84 Primary Storage Shelf

The 5U84 Primary Storage Shelf uses two SAS-3 RAID controllers, which are located in the top two slots of the back panel. The RAID controllers provide RAID data protection technology for the data that is stored on the 5U84 Primary Storage Shelf disk drives. The RAID controllers also provide RAID data protection technology for the optional 5U84 Expansion Storage Shelves that you connect to the 5U84 Primary Storage Shelf.

SAS-3 copper cables connect the 5360 Appliance compute nodes to the 5U84 Primary Storage Shelf through the storage shelf's RAID controllers.

Five high performance fan modules connect to the storage shelf's midplane connector through the middle slots. Each fan module contains two contra-rotating high performance fans, along with separate power and control circuits for each internal fan.

Two redundant Power Supply Units (PSUs) are located in slots beneath the fan modules.

To operate, the 5U84 Primary Storage Shelf must have at least one functioning RAID controller, one functioning power supply unit, and four functioning fan modules.

5U84 Expansion Storage Shelf

The 5U84 Expansion Storage Shelf uses two Expansion I/O modules, which are located in the top two slots of the back panel. The Expansion I/O modules provide SAS-3 I/O data transfers between the 5U84 Primary Storage Shelf and the 5U84 Expansion Storage Shelf. The Expansion I/O modules also provide I/O data transfers between the first 5U84 Expansion Storage Shelf and up to two additional 5U84 Expansion Storage Shelves.

SAS-3 cables connect the 5U84 Expansion Storage Shelf to the 5U84 Primary Storage Shelf through the 5U84 Expansion Storage Shelf's Expansion I/O modules. SAS-3 cables are also used to daisy chain up to two additional 5U84 Expansion Storage Shelves to the first 5U84 Expansion Storage Shelf.

Five high performance fan modules connect to the storage shelf's midplane connector through the middle slots. Each fan module contains two contra-rotating, high performance fans, along with separate power and control circuits for each internal fan. The device must have at least one functioning RAID controller, one functioning power supply module, and one functioning fan module.

Two redundant Power Supply Units (PSUs) are located in slots beneath the fan modules.

To operate, the 5U84 Expansion Storage Shelf must have at least one functioning Expansion I/O module, one functioning PSU, and four functioning fan modules.

See "[Veritas 5U84 Expansion Storage Shelf Expansion I/O modules](#)" on page 52.

Veritas 5U84 Primary Storage Shelf RAID controllers

The Veritas 5U84 Primary Storage Shelf uses dual, hot swappable SAS-3 RAID controllers. These controllers create and manage the 5U84 Primary Storage Shelf disk drive RAID sets that contain backed up data. They also create and manage the RAID sets on 5U84 Expansion Storage Shelves when those are attached to the 5U84 Primary Storage Shelf.

The SAS-3 RAID controllers run RAID level 6 on the storage shelf. RAID 6 offers the highest level of data protection. It allows simultaneous write operations, while

also allocating two sets of parity data across the drives that comprise the RAID 6 array.

The SAS-3 RAID controllers also provides an additional SAS-3 port. The SAS-3 port enables data to flow at SAS-3 data transfer rates between the 5U84 Primary Storage Shelf and the first optional 5U84 Expansion Storage Shelf.

Figure 2-17 Veritas 5U84 Primary Storage Shelf SAS-3 RAID controllers

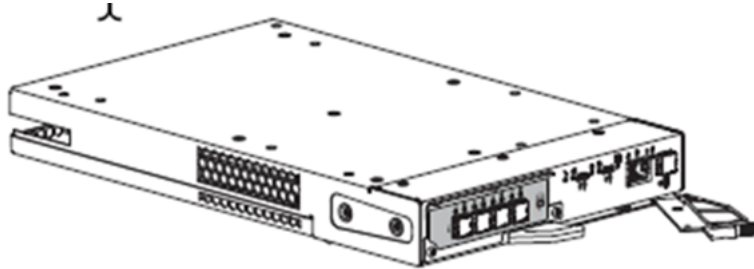

The following figure and table provides component details for the Veritas 5U84 Primary Storage Shelf SAS-3 RAID controller modules.

Figure 2-18 Veritas 5U84 Primary Storage Shelf SAS-3 RAID Controller components and locations

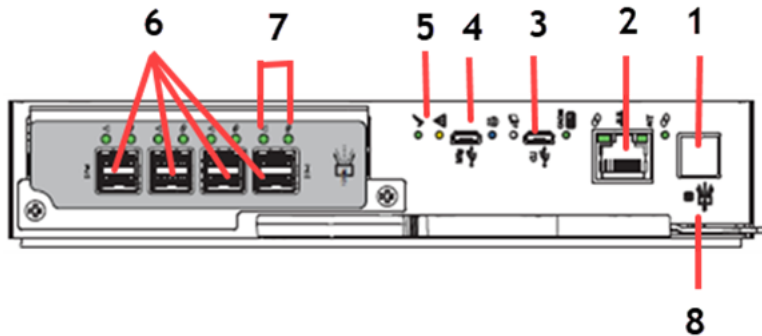

Table 2-10 Veritas 5U84 Primary Storage Shelf SAS-3 RAID Controller components

| Number | Component |
|--------|--------------------|
| 1 | Expansion SAS port |

Table 2-10 Veritas 5U84 Primary Storage Shelf SAS-3 RAID Controller components (*continued*)

| Number | Component |
|--------|----------------------------------------------------------------------------------|
| 2 | Ethernet port Note: Veritas does not use or support the Ethernet port. |
| 3 | USB port |
| 4 | Serial ports (Service only) |
| 5 | Indicator LEDs |
| 6 | SAS-3 RAID ports - connects to the 5360 Appliance compute nodes |
| 7 | Activity LEDs |
| 8 | Expansion SAS port Status |

Figure 2-19 Veritas 5U84 Primary Storage Shelf SAS-3 RAID Controller indicator LED details

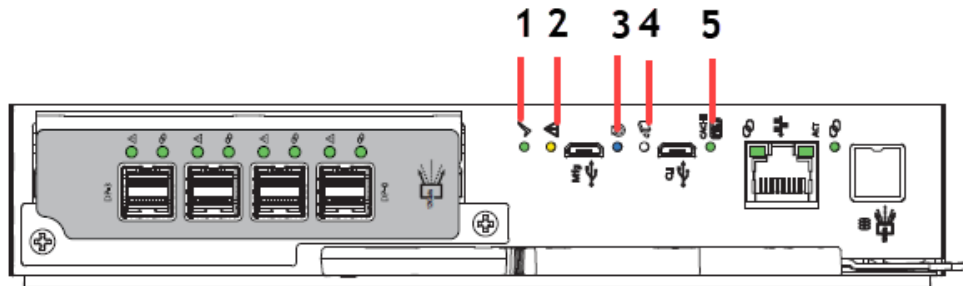

Table 2-11 Veritas 5U84 Primary Storage Shelf SAS-3 RAID Controller indicator LED details

| LED | Description | Color | Definition |
|-----|-----------------|-------|-------------------------------------------------------------------------------------------------------------------------------------------------------------------------------------------------------------------------------------------------|
| 1 | Hardware normal | Green | On - Controller module is functioning properly. Flashing - Part of sequence as Controller module comes online, on standby. Off - Controller module power is off, Controller module is offline, or Controller module has a fault condition |

Table 2-11 Veritas 5U84 Primary Storage Shelf SAS-3 RAID Controller indicator LED details (*continued*)

| LED | Description | Color | Definition |
|-----|----------------|-------|------------------------------------------------------------------------------------------------------------------------------------------------------------------------------------------------------------------------------------------------------------------------------------------|
| 2 | Hardware fault | Amber | On - Controller module hardware fault. Off - Controller module functioning properly. |
| 3 | Identify | Blue | On - Unit identification (UID) active. Off - Normal state, no query for UID active. |
| 4 | OK to remove | White | On - Ready for removal, the cache is clear. Off - Do not remove the Controller module, cache still contains unwritten data. |
| 5 | Cache Status | Green | On - Cache contains unwritten data, Controller module functioning properly. Fast flash (1s on, 1s off) - Cache is active, cache flush in progress Slow flash (3s on, 1s off) - Cache self-refresh in progress after cache flush Off - Cache is clear or System is coming online |

Veritas 5U84 Expansion Storage Shelf Expansion I/O modules

Veritas 5U84 Expansion Storage Shelf Expansion I/O modules provide SAS-3 data throughput and communications between one or more 5U84 Expansion Storage Shelves.

Figure 2-20 Veritas 5U84 Expansion Storage Shelf Expansion I/O module



Figure 2-21 Veritas 5U84 Expansion Storage Shelf Expansion I/O module

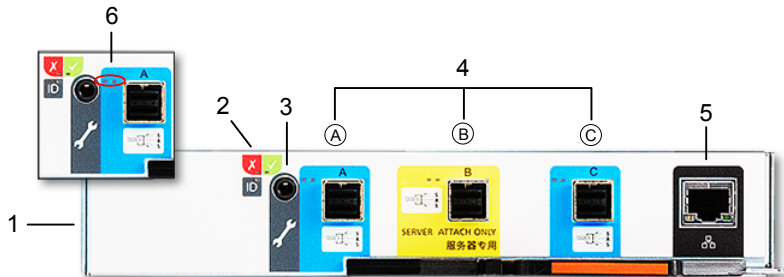

Table 2-12 Expansion I/O module components and locations

| Number | Component |
|--------|----------------------------------------------------------------------------------|
| 1 | Expansion I/O module |
| 2 | Expansion I/O module Status LEDs |
| 3 | RS232 jack (debugging purposes only) |
| 4 | SAS-3 ports - A, B, and C |
| 5 | Ethernet port Note: Veritas does not use or support the Ethernet port. |
| 6 | SAS Activity LEDs |

Expansion I/O module Status LED location and conditions

This section discusses the location of the Status LEDs on the Expansion I/O modules and the Status LED conditions.

Figure 2-22 Expansion I/O module Status indicator LED location

I/O module Status LED location

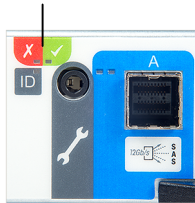





Table 2-13 Expansion I/O module icon and Status LED conditions

| Condition | Activity LED (green) | Fault LED (amber) |
|-----------------------------------------------------------------------------------------------------------|----------------------|----------------------------------------------------------------------------------------------------------------|
|  Module Fault (amber) | On Off | The Expansion I/O module has encountered a fault condition. The Expansion I/O module is operating normally. |
|  Power (green) | On Off | The Expansion I/O module is on. The Expansion I/O module is off. |
|  ID (blue) | On | The Expansion I/O module is being identified. |

Expansion I/O module SAS Activity LED location and conditions

This section discusses the location of the SAS Activity LEDs on the Expansion I/O modules and the SAS Activity LED conditions.

Figure 2-23 Expansion I/O module SAS Activity LED location

SAS Activity LED location

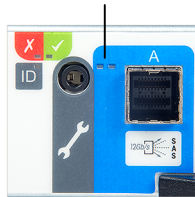

Table 2-14 Expansion I/O module SAS Activity LED conditions

| Condition | Activity LED (green) | Fault LED (amber) |
|---------------------------------------------------------------------------------------------------------------------------------------------------------------------------------------------------------------------------------------------------------|------------------------------------|------------------------------------------|
| No Cable Present | Off | Off |
| Cable Present All links up, no activity. | On | Off |
| Cable Present All links up. | Flash with aggregate port activity | Off |
| Critical Fault <ul style="list-style-type: none"> ■ Any fault which causes operation of the cable to cease or fail to start For example, an OVERCURRENT trip. ■ No connection detected at the opposite end of the SAS cable | Off | On |
| Non-Critical Fault Any fault which does not cause the connection to cease operation. For example, not all links established; OVERTEMPERATURE condition detected. | Flash with aggregate port activity | Flashing - One second on; one second off |

Veritas 5U84 Storage Shelf cooling modules

The Veritas 5U84 Storage Shelves include five cooling modules. The cooling modules provide cooling to the entire unit, which is suitable to maintain the internal component temperatures below each component's maximum temperature limits.

Figure 2-24 Veritas 5U84 Storage Shelf cooling module components

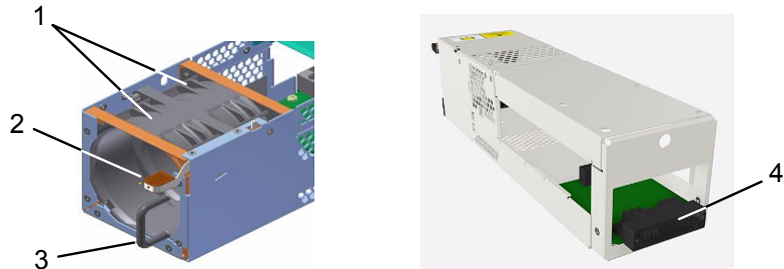

Table 2-15 Veritas 5U84 Storage Shelf cooling module component locations

| Number | Component |
|--------|------------------------------------------------|
| 1 | High performance, contra-rotating cooling fans |
| 2 | Release latch |
| 3 | Handle |
| 4 | Mid-plane connector |

Cooling modules provide the following features:

- Fast removal and replacement times without the need to turn off the storage shelf.
- Electronic fan speed control to the fans.
- Redundant serial interface connections to the rest of the storage shelf system.
- Cooling module redundancy
- Redundancy includes:
 - Maintaining the cooling function of the cooling module in the event of a single fan rotor failure.
 - Maintaining the normal operation of the cooling module if one cooling control or fan controller module fails.

- Automatically switching fan speeds to Full/High mode if the cooling module control unit fails.
- Maintaining the normal operation of the storage shelf for two minutes when a cooling module is swapped out due to a failure.

5U84 Storage Shelf Power Supply Units

Veritas 5U84 Storage Shelves includes dual Power Supply Units (PSU) that provide redundant power to the storage shelves. If one PSU fails, the storage shelves continue to operate as the second PSU continues to supply the storage shelf with power.

PSUs are hot-swappable. You can replace a faulty PSU while the storage shelf is running. However, you must complete the PSU replacement procedure within **two minutes** after you remove the faulty PSU.

Veritas 5U84 Storage Shelf chassis are keyed to prevent PSUs from being inserted upside down.

Figure 2-25 5U84 Storage Shelf Power Supply Unit

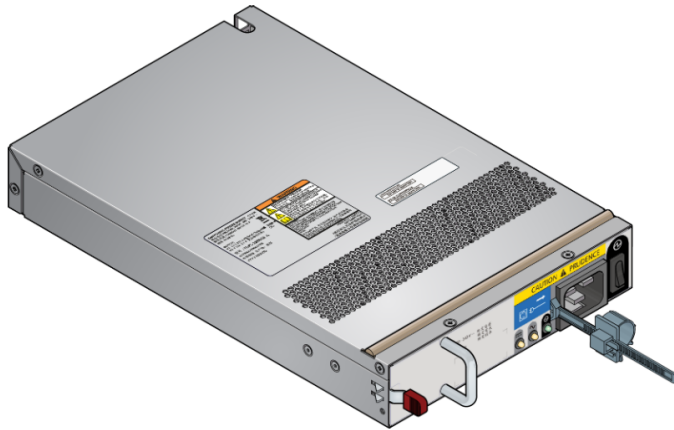

The rear panel of the PSU includes a power switch, three status LEDs, and an AC socket for the power cord. The rear panel also includes a handle that you use during the PSU insertion and removal process.

Figure 2-26 5U84 Storage Shelf Power Supply Unit

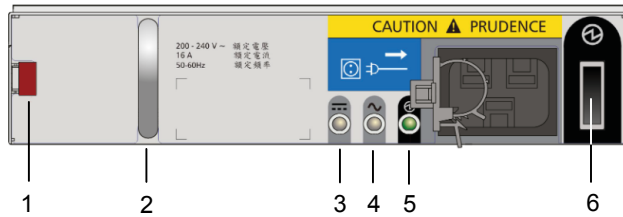

Table 2-16 5U84 Storage Shelf Power Supply Unit component locations

| Number | Component |
|--------|---------------|
| 1 | Release latch |
| 2 | Handle |
| 3 | PSU Fail LED |
| 4 | AC Fail LED |
| 5 | Power OK LED |
| 6 | Power switch |

Veritas 5360 Appliance and 5U84 Storage Shelf cables

This chapter includes the following topics:

- [Power cables](#)
- [Network cable](#)
- [SAS-3 cable](#)
- [Twinaxial copper cables](#)

Power cables

Each of the AC power modules in both the Veritas 5360 Appliance and the required Veritas 5U84 Primary Storage Shelf accept one AC power cable. The optional 5U84 Expansion Storage Shelf also uses one AC power cord in each of its AC power modules. One end of the AC power cable connects to the power supply on the appliance or the storage device. The other end of the cable connects to an external Power Distribution Unit (PDU) on the rack.

Power cables include a live line, a neutral line, and a grounding line.

Veritas 5360 Appliance AC power cable

Figure 3-1 AC power cable - Veritas 5360 Appliance Appliance



- A AC power connector (IEC-60320-C14) to an external power supply such as a Power Distribution Unit (PDU) on a rack.
- B AC power connector (IEC-60320-C13) to an appliance.

Cable rating: 15A 250V

Note: If your power distribution unit is not compatible with the IEC-60320-C14 plug, Veritas recommends that you purchase your power cable locally. Make sure that the power cable meets or exceeds the indicated power rating.

See [“Veritas 5360 compute node technical specifications”](#) on page 66.

Veritas 5U84 Primary Storage Shelf / Expansion Storage Shelf AC power cable

Figure 3-2 AC power cable - Veritas 5U84 Primary Storage Shelf / Expansion Storage Shelf

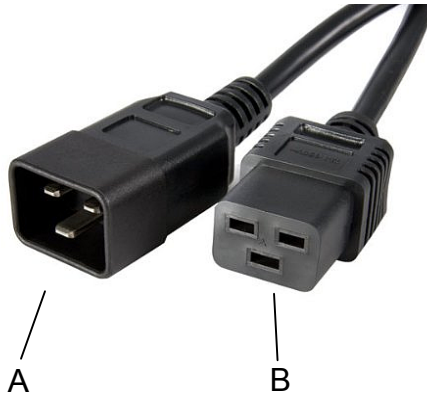

- A AC power connector (IEC-60320-C20) to an external power supply such as a Power Distribution Unit (PDU) on a rack.
- B AC power connector (IEC-60320-C19) to storage shelf.

Cable rating: 20A 250V

Note: If your power distribution unit is not compatible with the IEC-60320-C20 plug, Veritas recommends that you purchase your power cable locally. Make sure that the power cable meets or exceeds the indicated power rating.

See [“Veritas 5U84 Storage Shelf technical specifications”](#) on page 68.

See [“Network cable”](#) on page 61.

See [“SAS-3 cable”](#) on page 62.

See [“Twinaxial copper cables”](#) on page 63.

Network cable

The appliance communicates with the Ethernet networks through an Ethernet network cable. One end of the network cable connects to the management network port or service network port of the appliance. The other end of the cable connects

to the network switch or an external gateway. Both ends of the cable are RJ45 connectors.

Figure 3-3 Network cable

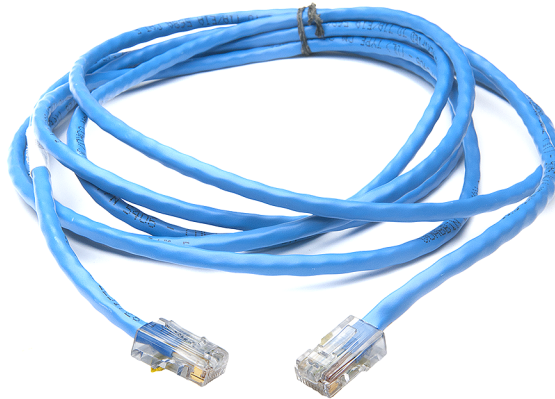

See [“Power cables”](#) on page 59.

See [“SAS-3 cable”](#) on page 62.

See [“Twinaxial copper cables”](#) on page 63.

SAS-3 cable

SAS-3 data cables are used to connect the Veritas 5U84 Primary Storage Shelf to the 5360 Appliance compute nodes. SAS-3 cables also connect multiple 5U84 Expansion Storage Shelves to each other. SAS-3 cables have SAS-3 connectors on both ends. SAS-3 cables ship with each Veritas Appliance, and with each Veritas 5U84 Expansion Storage Shelf.

Figure 3-4

SAS-3 cable



See [“Power cables”](#) on page 59.

See [“Network cable”](#) on page 61.

See [“Twinaxial copper cables”](#) on page 63.

Twinaxial copper cables

The Veritas 5360 Appliance communicates with Ethernet networks through high speed Twinaxial copper cables. If you configure the appliance to communicate with 25 Gb or 10 Gb Ethernet networks, these cables connect to the Ethernet cards in the appliance.

These cables are also known as Direct-Access Copper (DAC) cables, and are available in 1-meter, 3-meter, 5-meter and 7-meter lengths.



See [“Power cables”](#) on page 59.

See [“Network cable”](#) on page 61.

See [“SAS-3 cable”](#) on page 62.

Technical specifications, Environmental/Protocol standards, and Compliance standards

This appendix includes the following topics:

- [Veritas 5360 compute node technical specifications](#)
- [Veritas 5U84 Storage Shelf technical specifications](#)
- [Environmental specifications](#)
- [Protocol standards](#)
- [Regulatory, compliance, and certification information](#)
- [Product regulatory compliance](#)
- [Country approvals](#)
- [Product safety compliance](#)
- [Product EMC Compliance - Class A Compliance](#)
- [Product environmental compliance](#)

Veritas 5360 compute node technical specifications

Table A-1 5360 Appliance compute node technical specifications

| Technical Specification | 5360 Appliance compute node |
|------------------------------------------|-----------------------------------------------------------------------------------------------------------------------------------------------------------------------------------------------------------------------------------------------------------------------------------------------------------------------------------------------------------------------------------------------------------------------------------------------------------------------------------------------|
| Rack information | 19" EIA standard The rack rails that are provided for the 5360 Appliance compute node are extensible to 32" (820mm). The minimum distance or depth allowed between the rack posts is 24.6" (623mm). The maximum distance or depth allowed between the rack posts is 37" (942mm). If the distance between rack posts is longer than 37" (942mm), the rails and the appliance cannot be properly installed. |
| Processor | Third Generation Intel® Xeon® Scalable Processors |
| CPU speed | 2.0 GHz (Turbo: 3.2 GHz) |
| Cores (each appliance compute node) | 64 (32 per processor) |
| Memory type and configuration (RDIMMs) | Base memory capacity: 768 GB, expandable to 1.5 TB Memory type: DDR4 RDIMM Configuration: <ul style="list-style-type: none"> ■ 768 GB: 64 GB x 12 RDIMM modules on capacities less than 960 TB ■ 1536 GB: 64 GB x 24 RDIMM modules on capacities of 960 TB or greater Note: If you want to upgrade your capacity to 960 TB or more, you have to purchase a 768 GB memory upgrade kit. Operating voltage: 1.2V Configured clock speed: 3200 MHz |
| Cache (each appliance compute node) | 96 MB (48 MB per processor) Note: Two processors are installed in a compute node. |
| RAID cache (each appliance compute node) | 32 GB |
| VROC enabled OS RAID | Yes |

Table A-1 5360 Appliance compute node technical specifications (*continued*)

| Technical Specification | 5360 Appliance compute node |
|------------------------------------------------------------------------------|---------------------------------------------------------------------------------------------------------------------------------------------------------------------------------------------------------------------------------------------------------------------------------------------------------------------------------------------------------------------------------------------------------------------------------------------------------------------------------------------------------------------|
| SAS RAID PCIe card installed in a appliance compute node PCIe riser assembly | Yes |
| RAID levels | RAID1: Veritas 5360 Appliance compute node system disks |
| Usable MSDP and AdvancedDisk storage capacity (TB) | AdvancedDisk storage capacity: up to 1,920 TiB (2,112 TB) MSDP storage capacity: up to 960 TiB (1,056 TB) See "Available appliance storage options" on page 31. |
| Maximum number of storage shelves | 4 One Veritas 5U84 Primary Storage Shelf; three Veritas 5U84 Expansion Storage Shelves. |
| Dimensions (IEC rack compliant) | <p>Compute node</p> <ul style="list-style-type: none"> ■ Height: 8.7cm (3.43") (approximately 2U) ■ Width: 44.6cm (17.56") ■ Depth: 77.0cm (30.31") <p>Note: The Veritas 5U84 Primary Storage Shelf and the 5U84 Expansion Storage Shelf are longer than what a standard IEC-compliant rack normally supports. Due to the additional length, the rack-based PDU hardware may need to be installed on the outside of the rack to accommodate the storage shelves.</p> |
| Maximum weight | 16.76 kg (37 lbs) |
| AC power requirements | 110 VAC - 220 VAC @ 3.1 A |
| Power factor | > 90% |
| AC power cable | <p>Specification: IEC-60320-C14 to IEC-60320-C13, 15A/250V, Black, 4ft</p> <p>The IEC-60320-C14 plugs into a Power Distribution Unit. The IEC-60320-C13 plugs into an appliance or storage shelf power supply.</p> <p>Note: If your power distribution unit is not compatible with the IEC-60320-C14 plug, Veritas recommends that you purchase your power cable locally. Make sure the power cable meets or exceed the indicated power rating.</p> <p>See "Power cables" on page 59.</p> |
| AC Frequency range | 50/60Hz |
| Typical power consumption | 400 watts |

Table A-1 5360 Appliance compute node technical specifications (*continued*)

| Technical Specification | 5360 Appliance compute node |
|--------------------------------------------------------------------------------------------------------|---------------------------------------------------------------------------------------------------------------------------------------------------------|
| Maximum power consumption | 1100 watts |
| Typical power consumption with a maximum of four external storage shelves | 4800 watts |
| Maximum power consumption with a maximum of four external storage shelves | 6,700 watts |
| System cooling requirement (heat dissipation) (Appliance with maximum storage shelves attached) | Typical: <ul style="list-style-type: none"> ■ 1365 BTU/hour Maximum: <ul style="list-style-type: none"> ■ 22,861 BTU/hour |
| Operating voltage | 90V – 140 VAC 180V – 264 VAC |
| Power conversion efficiency | 90% + |
| Acoustic noise | 70 dBA |

Veritas 5U84 Storage Shelf technical specifications

The following table provides technical specifications for both the Veritas 5U84 Primary Storage Shelf and the Veritas 5U84 Expansion Storage Shelf.

Table A-2 Veritas 5U84 Primary Storage Shelf / 5U84 Expansion Storage Shelf technical specifications

| Technical specification | Description |
|-------------------------|-----------------------------------------------------------------------------------------------------------------------------------------------------------------------------------------------------------|
| Rack information | The rack installation height is the space occupied by a storage shelf in a rack cabinet. The shelf fits into a 5U rack space. Install the storage shelf in a rack cabinet that is 19 inches (483mm) wide. |

Table A-2 Veritas 5U84 Primary Storage Shelf / 5U84 Expansion Storage Shelf technical specifications (*continued*)

| Technical specification | Description |
|----------------------------------|---------------------------------------------------------------------------------------------------------------------------------------------------------------------------------------------------------------------------------------------------------------------------------------------------------------------------------------------------------------------------------------------------------------------------------------------------------------------------------------------------------------------------------------------------------------------------------------------------------------------------------------------------------------------------------------------------------------------------------------------------------------------------------------------------------------------------------------------------------------------|
| Dimensions (IEC rack compliant) | <p>5U84 Primary and 5U84 Expansion Storage Shelves</p> <ul style="list-style-type: none"> ■ Height: 22.3 cm (8.75") (approximately 5U - shelf, overall) ■ Width: 48.3 cm (19.0") (across the mounting flange) ■ Length/depth: 93.3cm (36.75") (from rear of the front flanges to the rear extremity of the chassis) <p>For more information on rack installation, refer to the <i>Dimensions and determining rack locations</i> section in the <i>Veritas 5360 Hardware Installation Guide</i>.</p> <p>Note: The Veritas 5U84 Primary Storage Shelf and the 5U84 Expansion Storage Shelf are longer than what a standard IEC-compliant rack normally supports. Due to the additional length, the rack-based PDU hardware may need to be installed on the outside of the rack to accommodate the storage shelves.</p> |
| Hot swappable components | Disk drives, power supply units (PSUs), cooling modules, SAS Controllers, Expansion I/O modules |
| Usable storage capacity | <p>Up to 1,920 TiB (2,112 TB), depending on the hardware configuration you purchase</p> <p>See "Available appliance storage options" on page 31.</p> |
| Maximum weight | <p>5U84 Primary Storage Shelf: 135 kg (298 lbs) with drives; no rail kit</p> <p>5U84 Expansion Storage Shelf: 135 kg (298 lbs) with drives; no rail kit</p> |
| Device types supported | Dual ported 12Gb/s SAS |
| Maximum drives per storage shelf | 84 |
| Typical power consumption | <p>1100 watts per storage shelf</p> <p>Note: You can connect a maximum of four storage shelves to the 5360 Appliance compute nodes.</p> |
| Maximum power consumption | 1400 watts per storage shelf |
| Supported RAID level | RAID6 and RAID10: 5U84 Primary Storage Shelf and 5U84 Expansion Storage Shelf data storage disks |

Table A-2 Veritas 5U84 Primary Storage Shelf / 5U84 Expansion Storage Shelf technical specifications (*continued*)

| Technical specification | Description |
|-----------------------------|------------------------------------------------------------------------------------------------------------------------------------------------------------------------------------------------------------------------------------------------------------------------------------------------------------------------------------------------------------------------------------------------------------------------------------------------------------------------------|
| Controllers | <p>5U84 Primary Storage Shelf: Dual RealStor 5005 12Gb SAS RAID controllers per storage shelf</p> <p>5U84 Expansion Storage Shelf: Dual Storage Bridge Bay (SBB) 2.1 compatible Expansion I/O modules per storage shelf</p> |
| Host/Expansion Interface | Three universal x4 12Gb mini-SAS connectors (SFF-8644) per Expansion I/O module |
| Maximum output power | <p>1400 watts maximum continuous output power at high line voltage</p> <p>You can connect up to four storage shelves to the 5360 Appliance compute nodes.</p> |
| AC power requirements | 200 - 240 VAC @ 6.36 A |
| Operating voltage | 200V - 240 VAC |
| AC power cable | <p>Specification: IEC-60320-C20 to IEC-60320-C19, 20A/250V, Black, 4ft</p> <p>The IEC-60320-C20 plugs into a Power Distribution Unit (PDU) on a rack. The IEC-60320-C19 plugs into an appliance or a storage shelf power supply.</p> <p>Note: If your power distribution unit is not compatible with the IEC-60320-C20 plug, Veritas recommends that you purchase your power cable locally. Make sure the power cable meets or exceed the indicated power rating.</p> |
| AC Frequency range | 50/60Hz |
| Power conversion efficiency | <p>81% @ 10% load</p> <p>89% @ 20% load</p> <p>93% @ 50% load</p> <p>90% @ 100% load</p> |
| Temperature range | <p>Operating: 5° to 35°C (de-rate 5°C above 2,133m (7,000')) (41°F TO 95°F)</p> <p>Non-operating: -40°C to 70°C (-40°F TO 158°F)</p> |

Table A-2 Veritas 5U84 Primary Storage Shelf / 5U84 Expansion Storage Shelf technical specifications (*continued*)

| Technical specification | Description |
|----------------------------------------|------------------------------------------------------------------------------------------|
| Relative humidity | Operating: 20%rh to 80%rh non-condensing Non-operating: 5%rh to 100%rh non-condensing |
| Acoustic noise | 82 dBA Sound Power Operating ≤ 8.0 Bels LWAd @ 23° |
| Operating altitude | -30 to 3048m (-100 to 10000ft) De-rate 5°C above 2134m (7000ft) |
| Non-operating altitude | -305 to 12192m (-1000 to 40000ft) |
| Operational vibration | 0.21gRMS 5-500Hz Random |
| Operational shock | 5g10ms ½ Sine |
| Relocation vibration (Non-operational) | 0.3g2-200-2Hz Swept Sine. |
| Non-operational vibration | 1.04 gRMS 2-200Hz Random. |
| Non-operational shock | 30g10ms ½ Sine (Z-axis) 20g10ms ½ Sine(X-and Y-axes) |

See [“Veritas 5360 compute node technical specifications”](#) on page 66.

See [“Environmental specifications”](#) on page 71.

See [“Protocol standards”](#) on page 73.

See [“Regulatory, compliance, and certification information”](#) on page 74.

Environmental specifications

Veritas Appliance compute node environmental specifications

Table A-3 Veritas Appliance compute node environmental specifications

| Specification | 5360 Appliance compute node |
|-----------------------|------------------------------------------|
| Operating temperature | ASHRAE A2 (10°C to 35°C) (50°F to 95°F) |

Table A-3 Veritas Appliance compute node environmental specifications
(continued)

| Specification | 5360 Appliance compute node |
|---------------------------------|---------------------------------------------------------------------------------------------------------------------------------------------------------------------------------------------------------------------------------------------------------------------------------------------------------------------------------------------------------|
| Non-operating temperature | -40 °C to 70 °C (-40 °F to 158 °F) The non-operating temperature is defined as the temperature of the system when the system is turned off. It is also referred to as the storage temperature. Veritas recommends that you do not store the system in an environment where the temperatures fall outside of the listed temperature range. |
| Operating humidity (RH) | 20% RH to 80% RH |
| Non-operating humidity | 8% RH to 90% RH |
| Operating altitude (feet) | 3050 m (10,006 ft) |
| Temperature gradient (per hour) | 10°C/h (50°F/h) |

Veritas 5U84 Primary Storage Shelf / 5U84 Expansion Storage Shelf environmental specifications

Table A-4 Veritas 5U84 Primary Storage Shelf / 5U84 Expansion Storage Shelf environmental specifications

| Specification | Description |
|------------------------|-------------------------------------------------------------------------------------------------------------------------------|
| Temperature range | Operating: 5° to 35°C (de-rate 5°C above 2,133m (7,000')) (41°F to 95°F) Non-operating: -40°C to 70°C (-40°F to 158°F) |
| Relative humidity | Operating: 20%rh to 80%rh non-condensing Non-operating: 5%rh to 100%rh non-condensing |
| Operating altitude | -30 to 3048m (-100 to 10000ft) De-rate 5°C above 2134m (7000ft) |
| Non-operating altitude | -305 to 12192m (-1000 to 40000ft) |

Table A-4 Veritas 5U84 Primary Storage Shelf / 5U84 Expansion Storage Shelf environmental specifications (*continued*)

| Specification | Description |
|------------------|----------------------------------------|
| Maximum wet bulb | Operating: 28°C Non-operating: 29°C |

See [“Veritas 5360 compute node technical specifications”](#) on page 66.

See [“Veritas 5U84 Storage Shelf technical specifications”](#) on page 68.

See [“Protocol standards”](#) on page 73.

See [“Regulatory, compliance, and certification information”](#) on page 74.

Protocol standards

The following table provides standards with which the Veritas 5360 Appliance and the Veritas 5U84 Primary/Expansion Storage Shelf comply.

Table A-5 Veritas Appliance / Veritas 5U84 Primary/Expansion Storage Shelf standards compliance

| Standard | Version |
|----------|-------------------------------------------------------------------------------------------------------|
| IPMI 2.0 | Intelligent Platform Management Interface Specification Second Generation v2.0, Document Revision 1.0 |
| SMBIOS | System Management BIOS (SMBIOS) Reference Specification, Version 3.5.0 |
| SAS | SAS-3 |
| ACPI | Advanced Configuration and Power Interface Specification, Revision 6.3 |
| IP | RFC0791: Internet Protocol |
| PCIe | PCIe 4.0 |

See [“Veritas 5360 compute node technical specifications”](#) on page 66.

See [“Veritas 5U84 Storage Shelf technical specifications”](#) on page 68.

See [“Environmental specifications”](#) on page 71.

See [“Regulatory, compliance, and certification information”](#) on page 74.

Regulatory, compliance, and certification information

The following sections give information about the product regulations and compliance.



WARNING

To ensure regulatory compliance, you must adhere to the assembly instructions in this guide to ensure and maintain compliance with existing product certifications and approvals. Use only the described, regulated components that are specified in this guide. Use of other products or components may void the regulatory approvals of the product. The result is noncompliance with product regulations in the region in which the product is sold.

Alterations to the configuration of your appliance may require additional compliance testing.

This product is an FCC Class A device. Integration of it into a Class B system does not result in a Class B device.

Product regulatory compliance

The appliance, when correctly integrated per this guide, complies with the following safety and electromagnetic compatibility (EMC) regulations.

Intended Application - This product was evaluated as Information Technology Equipment (ITE), which may be installed in offices, schools, computer rooms, and similar commercial type locations. The suitability of this product for other product categories and environments, other than an ITE application, may require further evaluation. Other product categories and environments may include medical, industrial, telecommunications, NEBS, residential, alarm systems, and test equipment.

Country approvals

- US/Canada
- CE - European Union (EU)

- Australia / New Zealand
- KCC South Korea
- IRAM Certification (Argentina)
- CCC Certification (China)
- BIS India
- NOM Mexico
- InMetro Brazil
- NRCS & SABS South Africa
- BSMI Taiwan
- VCCI Japan

Note: Other countries are either based on these requirements or do not require certification. For more regulatory compliance information please refer to this link: [Regulatory Compliance / Homologation](#)

Product safety compliance

The following is a list of product safety compliance norms for different countries:

- EN 62368-1:2014 + AC:2015
- EU Directive: Low Voltage 2014/35/EU
- CSA C22.2 No. 62368-1
- CB Certificate & Report, IEC62368-1 (report to include all country deviations)

Product EMC Compliance - Class A Compliance

The following is a list of EMC compliance norms for different countries:

- EU Directive: EMC 2014/30/EU
- EN 55035:2017 +A11:2020
- EN 55032:2015 +A11:2020
- EN 61000-3-2:2014
- EN 61000-3-3:2013
- FCC /ICES-003 - Emissions (USA/Canada) Verification

- VCCI Emissions (Japan)
- AS/NZS 3548 Emissions (Australia / New Zealand)

Note: For a complete list of regulatory notices please refer to this link:

[Veritas Safety and Compliance Guide](#)

Product environmental compliance

Use of banned substances are restricted in accordance with world-wide regulatory requirements. Restrictions include quantity limitations on the following:

- Quantity limit of 0.1% by mass (1000 PPM) for: Lead, Mercury, Cadmium, Hexavalent Chromium, Polybrominated Biphenyls Diphenyl-Ethers (PBB/PBDE), Bis (2-ethylhexyl) phthalate (DEHP), Benzyl butyl phthalate (BBP), Dibutyl phthalate (DBP), Diisobutyl phthalate (DiBP).
- Quantity limit of 0.01% by mass (100 PPM) for: Cadmium
- California Code of Regulations, Title 22, Division 4.5, Chapter 33: Best Management Practices for Perchlorate Materials
- China - Restriction of Hazardous Substances (China RoHS)
- India RoHS
- EU WEEE Directive
- EU Packaging Directive
- EU Batteries Directive
- EU Commission Regulation (EU) 2019/424 of 15 March 2019
- EU REACH Regulation

Product environmental declarations of compliance are available in this [link](#).