

MS151\MS152 Series

Economical Stylish Gas Spring Monitor Arm

Easily Position Your Monitors
and Boost Productivity



MS151 Series

Economical Stylish Gas Spring Monitor Arm



Gas Spring Mechanism
assists in effortless height adjustments

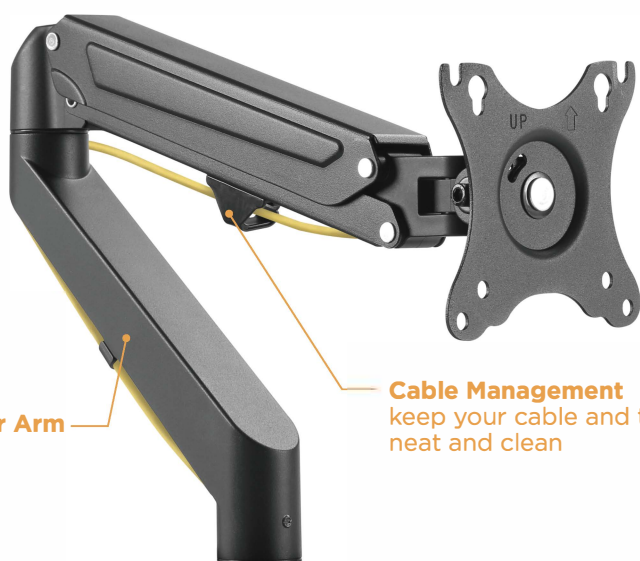

Aluminum Lower Arm
provides a sleek, elegant look

Cable Management
keep your cable and table neat and clean

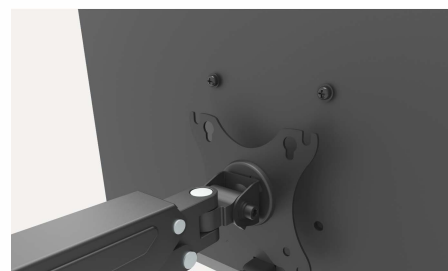

Keyhole Pattern VESA Slot
for quick attachment and detachment



Built-in Spring Tension Gauge
perfectly matches the arm to the monitor



Smooth Arm Insertion
provides an easy installation



MS151 Series

Economical Stylish Gas Spring Monitor Arm

MS151 For Single Monitor

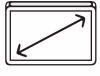

Screen Size
17"-27"

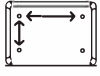

VESA Compatible
75x75 100x100



Weight Capacity
2-6.5kg/4.4-14.3lbs



Tilt Range
+90° - -45°

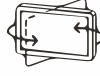

Swivel Range
+90° - -90°



Screen Rotation
+180° - -180°

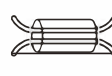

Cable Management



Keyhole Slot



Curved Monitor

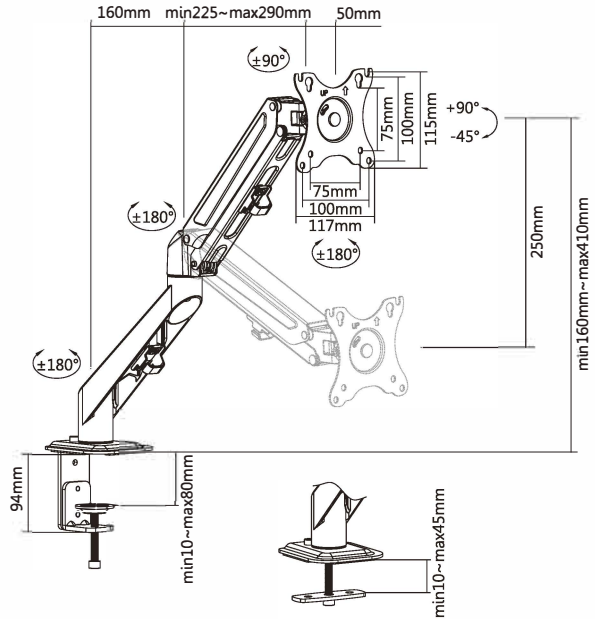

MS152 For Dual Monitors

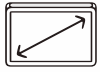

Screen Size
17"-27"

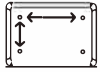

VESA Compatible
75x75 100x100



Weight Capacity
2-6.5kg/
4.4-14.3lbs (x2)



Tilt Range
+90° - -45°

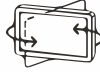

Swivel Range
+90° - -90°



Screen Rotation
+180° - -180°

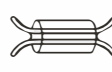

Cable Management



Keyhole Slot



Curved Monitor

