

HURON

Applied Sciences

PRODUCT PORTFOLIO SELECTIONS



43 San Marcos Rd. #B
Santa Barbara, CA 93111
info@HuronAS.com
www.HuronAS.com

2021 Product Catalog

HOBBY/CRAFT TOOLS AND ACCESSORIES

Precision Knives	1
Light Duty Blades	2
Medium and Heavy Duty Blades	3
Utility Knives and Blades	4
Saws and Mitre Boxes	5
Tweezers	6
Sprue Cutters, Files, Pliers, and Other Tools	7
Clamps, Cutting Mats, and Other Tools	8
Sets	9
Hot Glue Guns and Sticks	10
Soldering Irons, Tips, and Solder	11

OFFICE AND SECURITY PRODUCTS

Retail and Restaurant Cash Management Products	12
Security Bags, Pens, and Coin Trays	13
Key Racks, Tags, and Cabinets	14
Tags and Shipping Bags	15
Vinyl Covers and Cable Ties (Black)	16

DESK ORGANIZERS

Bookends and Sorters	17
Organizers	18

HOUSEHOLD ELECTRICAL

Indoor and Outdoor Extension Cords	22
Power Strips and Surge Protector Strips	23
Other Household Electrical	24
Alkaline Batteries	25

AUTOMOTIVE

Electrical Connectors	26
Primary Wire	39
Heat-Shrink Tubing	40
Cable Ties	41

PERSONAL ELECTRICAL ACCESSORIES

USB Cables, Car and Wall Adapters, Flashlights, Cliplights	43
--	-----------

ABOUT HURON APPLIED SCIENCES, LLC	44
--	-----------

Precision Knives

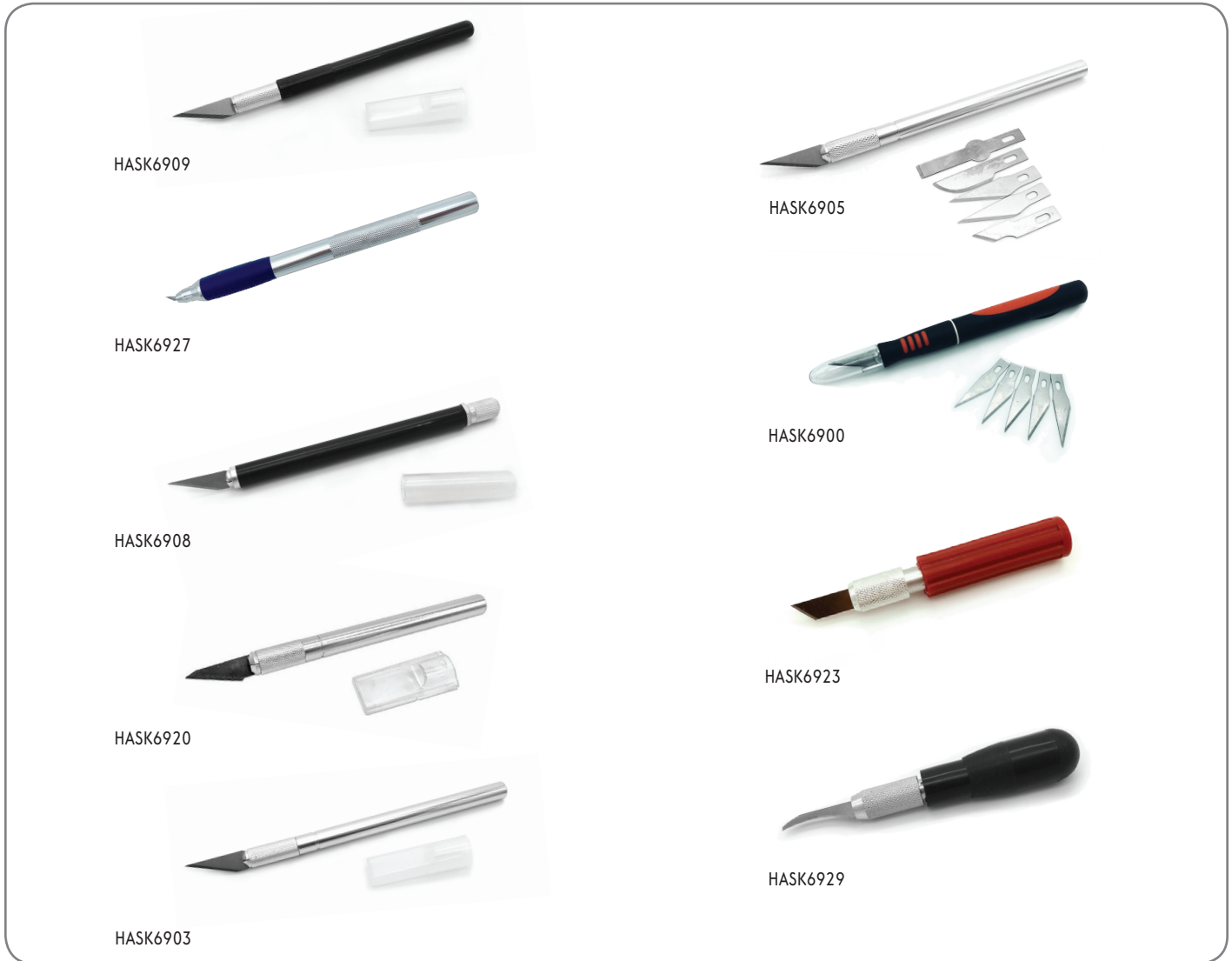

Item No.	Item	Pieces
HASK6909	Light Duty Economy Knife with Safety Cap	1
HASK6901	Light Duty Aluminum Handle Knife (Same knife handle as HASK6905)	1
HASK6903	Light Duty Aluminum Handle Knife with Safety Cap (Same knife handle as HASK6905)	1
HASK6905	Light Duty Aluminum Handle Knife with Blade Assortment	6
HASK6908	Light Duty Soft Grip Knife	1
HASK6900	Premium Soft Handle Designer Knife with Blades, Red/Black	6
HASK0001	Premium Soft Handle Designer Knife with Blades, Teal/Black (Not pictured)	6
HASK6927	360 Degree Swivel Knife	1
HASK6920	Medium Duty Aluminum Knife with Safety Cap	1
HASK6923	Heavy Duty Handle Knife	1
HASK6929	Woodcarving Knife with Gouge	1

Light Duty Blades

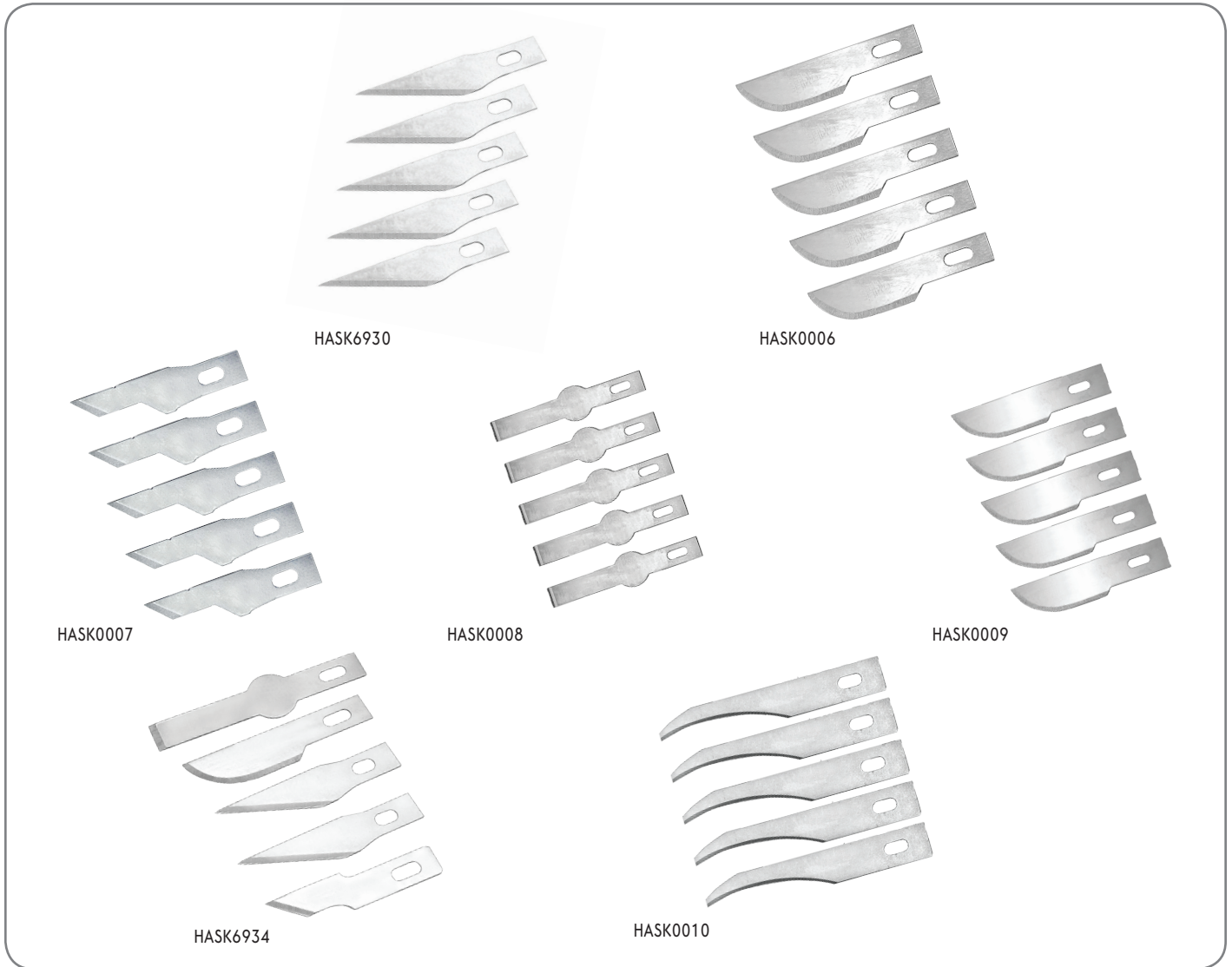

Item No.	Item	Amount
HASK6930	Blades, #11 Light Duty	5
HASK0066	Blades, #11 Light Duty	40
HASK6932	Blades, #11 Light Duty with Dispenser (Dispenser not pictured)	15
HASK0005	Blades, #11 Light Duty, Stainless Steel (Not pictured)	5
HASK0006	Blades, #10 General Purpose	5
HASK0007	Blades, #16 Stencil	5
HASK0008	Blades, #17 Chisel	5
HASK0009	Blades, #22 Curved Edge	5
HASK6934	Blades, Light Duty Assortment	5
HASK0010	Blades, Woodworking Gouged	2

Medium and Heavy Duty Blades



HASK6936



HASK6938



HASK6940



HASK0084



HASK0091



HASK0096

Item No.	Item	Amount
HASK6936	Blades, #2 Medium Duty	5
HASK6938	Blades, Medium Duty Assortment	5
HASK0084	Blades, #18 Heavy Duty Chisel	5
HASK0091	Blades, #25 Curved Carving	5
HASK0096	Blades, #19 Angled Chisel	5
HASK6940	Blades, #24 Deburring	5

Utility Knives and Blades



Item No.	Item	Pieces
HASK0002	Snapoff Knife Plastic, 9mm	1
HASK0003	Snapoff Knife Plastic, 18mm	1
HASK0067	Snapoff Knife Plastic/Metal Slide, 9mm, 2 Extra Blades	1
HASK0068	Snapoff Knife Plastic/Metal Slide, 8mm, 2 Extra Blades	1
HASK6925	Utility Knife with Retractable Blade	1
HASK0004	Utility Knife Aluminum Handle, Safety Back-Lock System	1

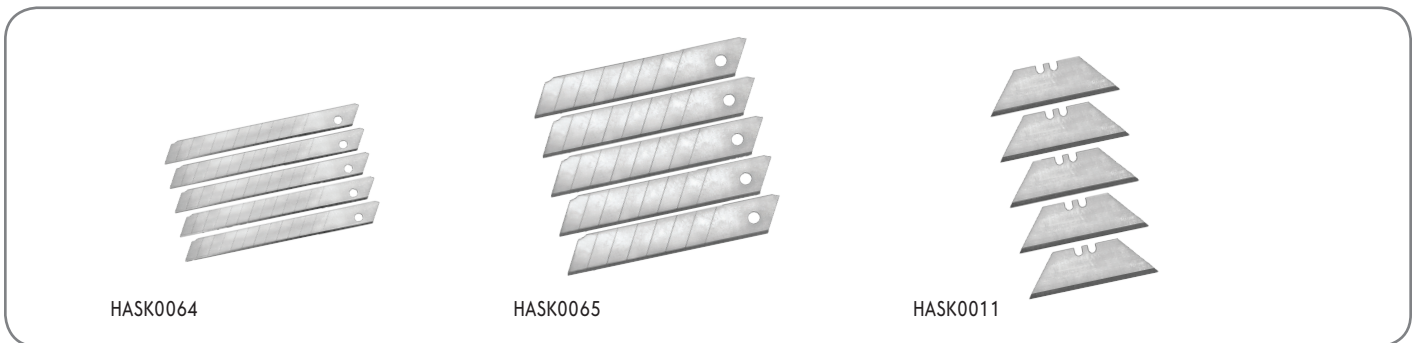

Item No.	Item	Amount
HASK0064	Blades, 9mm Snapoff	5
HASK0065	Blades, 18mm Snapoff	5
HASK0011	Blades, SK7 Utility Knife	5

Saws and Mitre Boxes

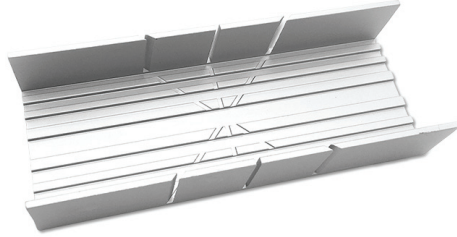

HASK0012



HASK6960

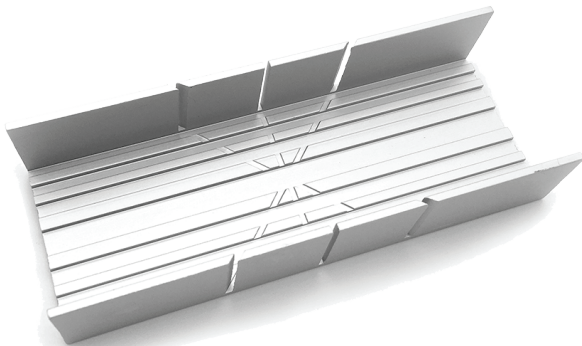

HASK6962



HASK6964

Item No.	Item	Pieces
HASK0012	Mitre Box with Razor Saw	3
HASK6960	Razor Saw Set with Blades	3
HASK6962	Mitre Box	1
HASK6964	Razor Saw Set with Fine Blade	2
HASK6966	Razor Saw Blade 4.5" x .75" 40T (Not pictured)	1
HASK6967	Razor Saw Blade 4.5" x 1" 40T (Not pictured)	1
HASK6968	Razor Saw Blade 5.5" x 1.25" 52T (Not pictured)	1

Tweezers

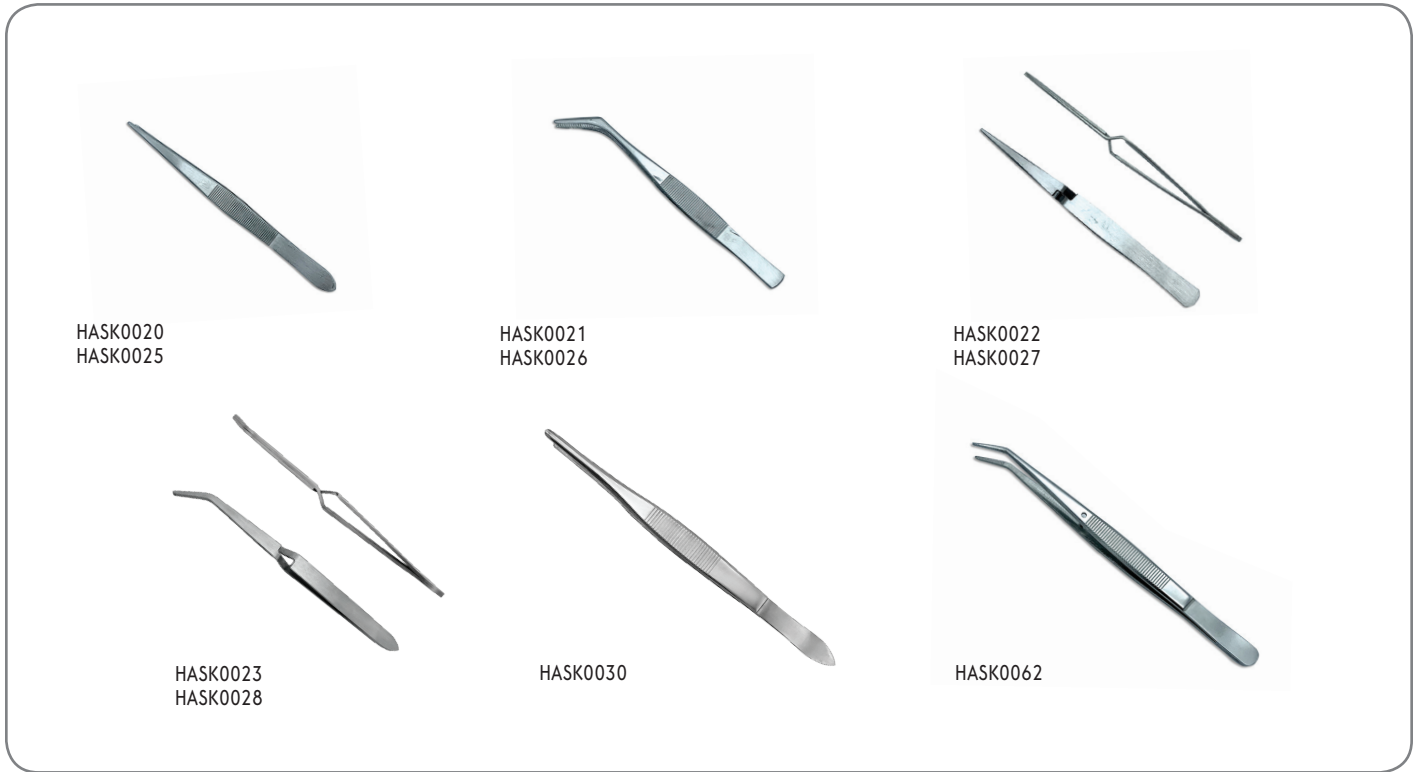

HASK0020
HASK0025

HASK0021
HASK0026

HASK0022
HASK0027

HASK0023
HASK0028

HASK0030

HASK0062

Item No.	Item	Pieces
HASK0020	Tweezer, Straight, 4.7 Inch	1
HASK0021	Tweezer, 45 Degrees	1
HASK0022	Tweezer, Straight, 4.7 Inch Crosslock	1
HASK0023	Tweezer, 45 Degrees, 4.7 Inch Crosslock	1
HASK0024	Tweezers Set (#0020, 0021, 0022, and 0023)	4
HASK0025	Tweezer, Straight, 4.5 Inch, Non-static	1
HASK0026	Tweezer, 45 Degrees, Non-static	1
HASK0027	Tweezer, Straight, 4.5 Inch, Non-static, Crosslock	1
HASK0028	Tweezer, 45 Degrees, Non-static, Crosslock	1
HASK0029	Tweezer Set. Non-static (#0025, 0026, 0027, and 0028)	4
HASK0030	Tweezer, Straight, Polished, Stainless Steel, 6 Inch	1
HASK0062	Tweezer, 45 Degrees, Polished, Stainless Steel, 6 Inch	1

Sprue Cutters, Files, Pliers, and Other Tools



HASK0016



HASK0032

HASK0034



HASK0054

HASK0031

HASK0061

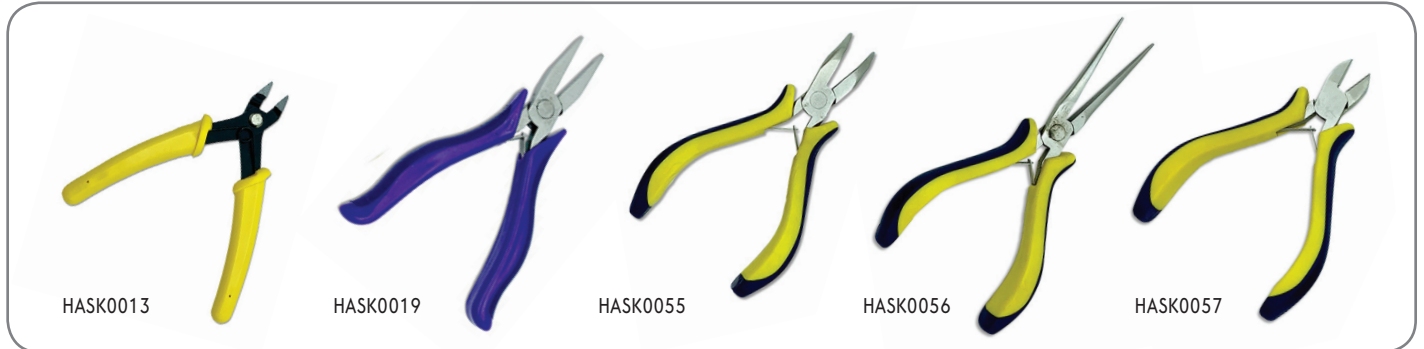

HASK0013

HASK0019

HASK0055

HASK0056

HASK0057

Item No.	Item	Pieces
HASK0015	Needle File Set, 3x140x50mm (Not pictured)	10
HASK0016	Needle File Set, 4x160x50mm	10
HASK0017	Needle File Set, 5x180x70mm (Not pictured)	10
HASK0013	Sprue Cutters	1
HASK0019	Pliers, Springloaded Flat Nose	1
HASK0055	Pliers, Springloaded Bent Nose	1
HASK0056	Pliers, Springloaded Needle Nose	1
HASK0057	Pliers, Springloaded Diagonal	1
HASK0018	Pliers, Springloaded Set (#0019, 0055, 0056, and 0057)	4
HASK0032	Jewelers Screwdriver Set with Box	6
HASK0034	Pin Vice, Swivel End	3 bits
HASK0054	Scissors	1
HASK0031	Hemostat, 5.5 Inch	1
HASK0061	Hemostat, 5.5 Inch, Curved Nose	1

Clamps, Cutting Mats, and Other Tools

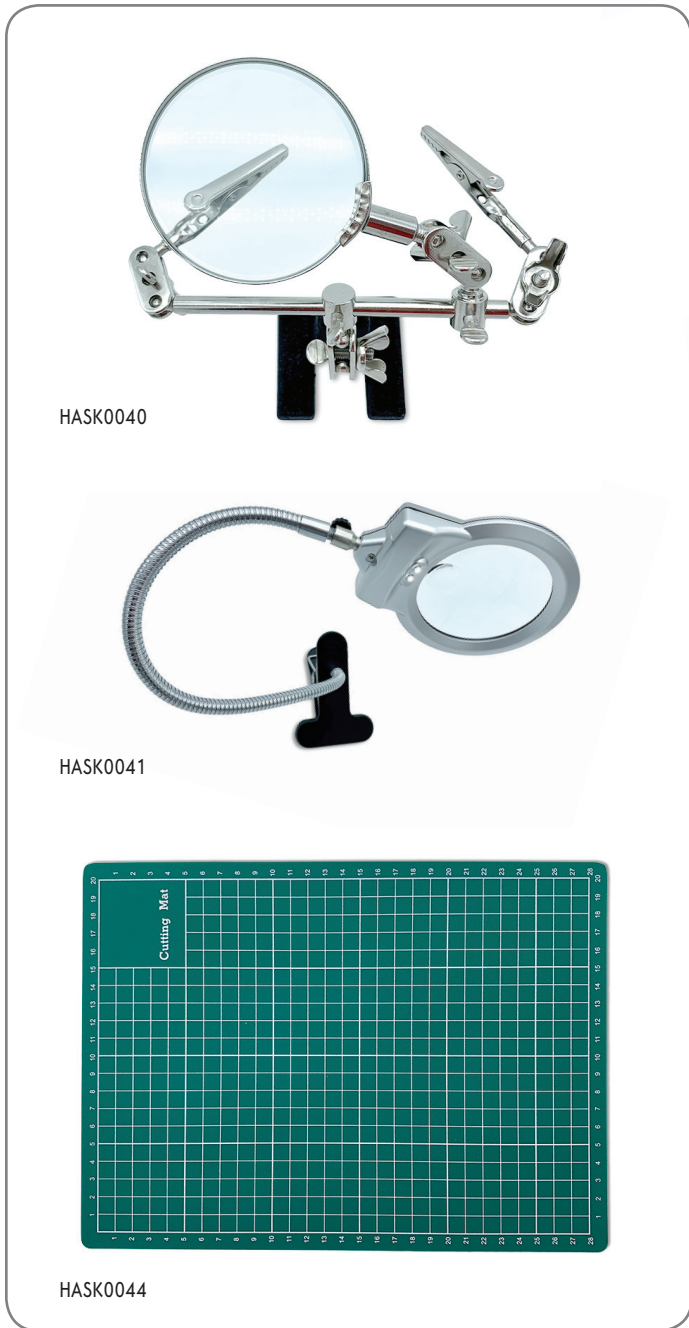

Item No.	Item	Amount
HASK0037	Spring Clamp, 3 Inches	3
HASK0038	Spring Clamp, 4 Inches	3
HASK0039	Quick Clamp, 4 Inches	1
HASK0040	Extra Hands, Double Clamp, Stand, Magnifier	1
HASK0041	Extra Hands, Double Clamp, Stand, Magnifier, Lamp	1
HASK0044	Cutting Mat, 18" x 24"	1
HASK0045	Cutting Mat, 12" x 18" (Not pictured)	1
HASK0046	Cutting Mat, 9" x 12" (Not pictured)	1
HASK0059	Scraper-Scriber Combo Tool	1
HASK0060	Double End Probe	1
HASK0036	Tape Measure, 12 Ft., 13mm, ABS Shell	1
HASK0058	Metal Ruler, 6 Inches	1

Sets



HASK0052



HASK6951



HASK0053



HASK6956

Item No.	Item	Pieces
HASK0047	Cutting Mat Set - Mat, Knife and Blade, File, Tweezers (Not pictured)	5
HASK0052	Designer's Set	12
HASK0053	Modeler's Set	8
HASK6951	Woodcarving Knife Set plus case	13
HASK6956	Standard Knife Set plus case	16

Hot Glue Guns and Sticks

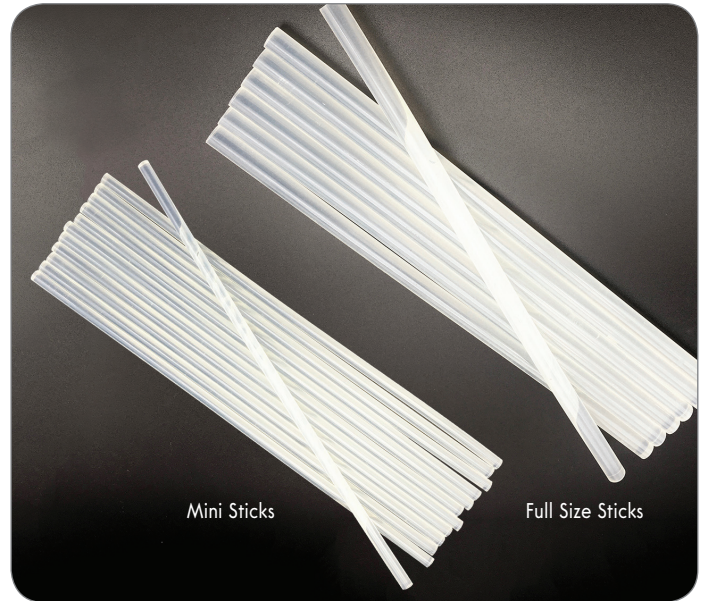
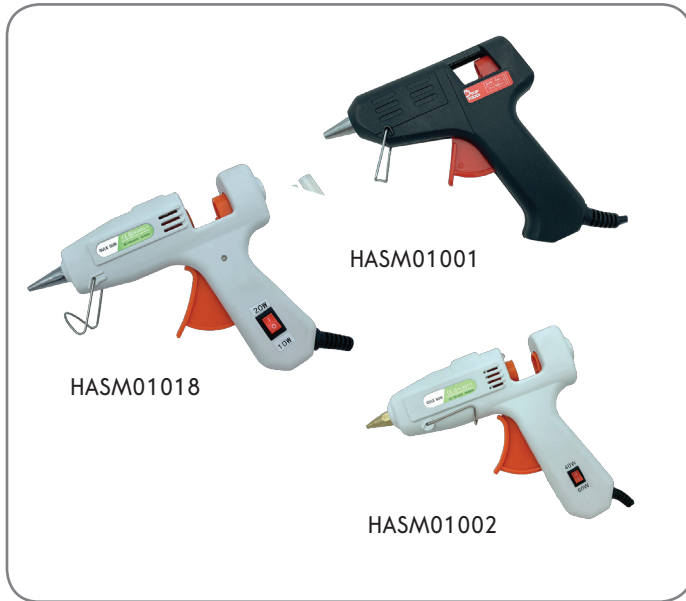

Item No.	Item	Pieces
HASM01001	Hot Glue Gun, mini, 10W	1
HASM01015	Hot Glue Gun, mini, 10W, includes 12 glue sticks	1
HASM01018	Hot Glue Gun, mini, 10-20W dual temp	1
HASM01019	Hot Glue Gun, mini, 10-20W dual temp, includes 12 glue sticks	1
HASM01002	Hot Glue Gun, full size, 40-60W dual temp	1
HASM01022	Hot Glue Gun, full size, 40-60W dual temp, includes 12 glue sticks	1
HASM01003	Hot Glue Sticks, clear, mini, 4"	10
HASM01004	Hot Glue Sticks, clear, mini, 4"	50
HASM01005	Hot Glue Sticks, clear, mini, 4"	120
HASM01006	Hot Glue Sticks, clear, mini, 10"	10
HASM01007	Hot Glue Sticks, clear, mini, 10"	24
HASM01008	Hot Glue Sticks, clear, mini, 10"	100
HASM01009	Hot Glue Sticks, clear, full size, 4"	8
HASM01010	Hot Glue Sticks, clear, full size, 4"	20
HASM01011	Hot Glue Sticks, clear, full size, 4"	60
HASM01012	Hot Glue Sticks, clear, full size, 10"	12
HASM01013	Hot Glue Sticks, clear, full size, 10"	30
HASM01014	Hot Glue Sticks, clear, full size, 10"	100

Soldering Irons, Tips, and Solder



Item No.	Item	Amount
HASM05001	40W Soldering Iron	1
HASM05002	60W Soldering Iron	1
HASM05003	40W Soldering Iron Tips (2 pointed, 1 blade)	3
HASM05004	60W Soldering Iron Tips (2 pointed, 1 blade) (Not pictured)	3
HASM05005	60/40 Rosin Core Solder (Not pictured)	1/2 oz.
HASM05006	60/40 Rosin Core Solder	4 oz.
HASM05007	Lead-free Silver Solder	15g

Retail and Restaurant Cash Management Products

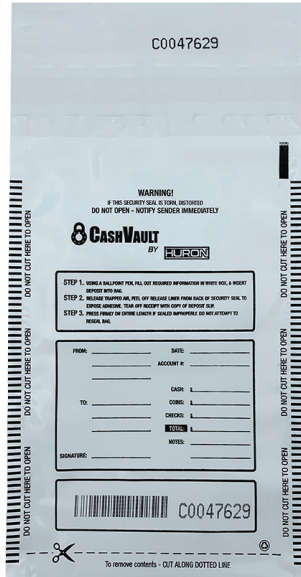

HASZ0077

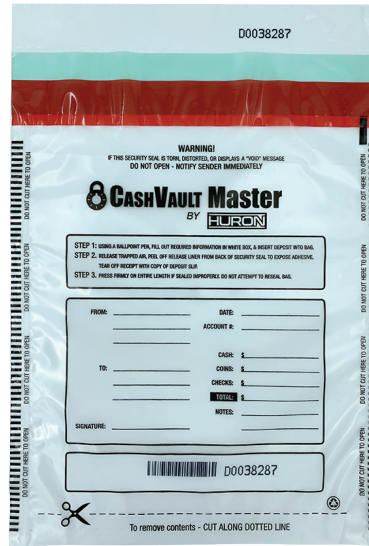

HASZ0071

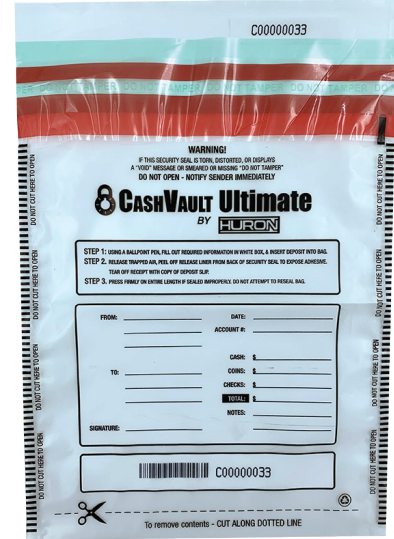

HASZ0061/HASZ0063



HASZ0003

Item No.	Item	Amount
HASZ0077	Cash Transmittal Bag, 6X9, white	100
HASZ0071	Level 2 Tamper-evident Bag, 9X12, clear (Not pictured)	100
HASZ0061	Level 4 Tamper-evident Bag, 9X12, clear	100
HASZ0063	Level 4 Tamper-evident Bag, 12X16, clear	100
HASZ0003	Detector Pen, carded	1
HASZ0006	Detector Pen, bagged	5
HASZ0008	Detector Pen, bagged	20

Security Bags, Pens, and Coin Trays



Item No.	Item	Quantity
HASZ0018	Lock Cash Bag, nylon, blue	1
HASZ0254	Zipper Bag Flat, vinyl, 6X11, black	1
HASZ0082	Zipper Bag Flat, vinyl, 6X11, blue	1
HASZ0084	Zipper Bag Flat, vinyl, 6X11, blue	3
HASZ0112	Coin Aluminum Tray - Penny	1
HASZ0113	Coin Aluminum Tray - Nickel	1
HASZ0114	Coin Aluminum Tray - Dime	1
HASZ0115	Coin Aluminum Tray - Quarter	1
HASZ0240	Coin Aluminum Tray Set (4 trays)	1
HASZ0014	Antimicrobial Pen, chain link, black, bagged	1
HASZ0015	Antimicrobial Pen, chain link, blue, bagged	1
HASZ0016	Antimicrobial Pen, chain link, replacement, black, bagged	1

Key Racks, Tags, and Cabinets



Item No.	Item	Quantity
HASZ0119	Key Rack, 8 key rings, white	1
HASZ0126	Key Cabinet, slotted, 30-key	1
HASZ0128	Key Cabinet, slotted, 60-key	1
HASZ0047	Key Wrist Coils, assorted colors (Not pictured)	10
HASZ0048	Key Wrist Coil, black	1
HASZ0049	Key Wrist Coil, red	1
HASZ0050	Slotted Key Tags, white	20
HASZ0054	Window Key Tags, assorted colors	20

Tags and Shipping Bags

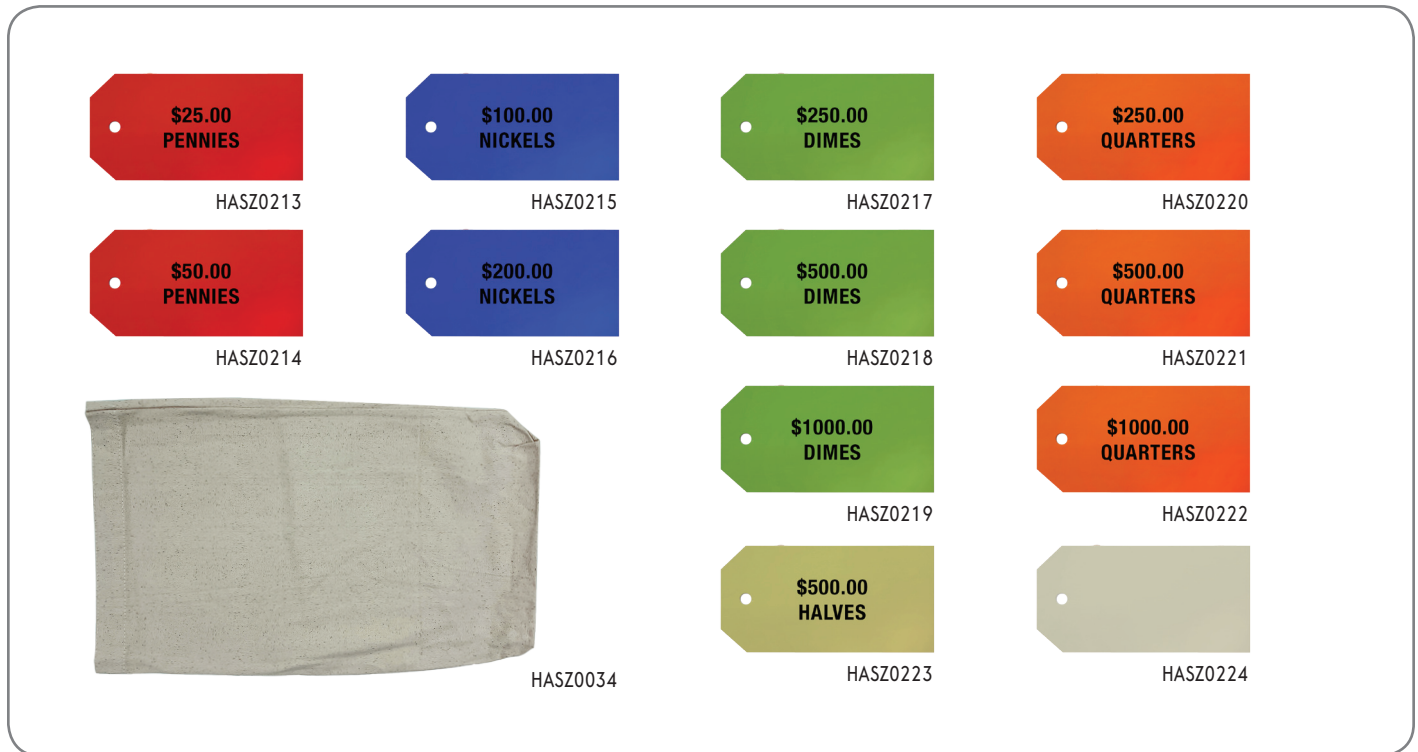

Item No.	Item	Quantity
HASZ0213	Red Penny Tag, \$25	1000
HASZ0214	Red Penny Tag, \$50	1000
HASZ0215	Blue Nickel Tag, \$100	1000
HASZ0216	Blue Nickel Tag, \$200	1000
HASZ0217	Green Dime Tag, \$250	1000
HASZ0218	Green Dime Tag, \$500	1000
HASZ0219	Green Dime Tag, \$1000	1000
HASZ0220	Orange Quarter Tag, \$250	1000
HASZ0221	Orange Quarter Tag, \$500	1000
HASZ0222	Orange Quarter Tag, \$1000	1000
HASZ0223	Putty Half Dollar Tag, \$500	1000
HASZ0224	Buff Blank Tag	1000
HASZ0228	Cable Tie 2-3/8" x .10"	100
HASZ0229	Cable Tie 4" x .14"	100
HASZ0230	Cable Tie 8" x .14"	100
HASZ0034	Duck Shipping Bag 12" x 19" Flat	25

Vinyl Covers and Cable Ties (Black)

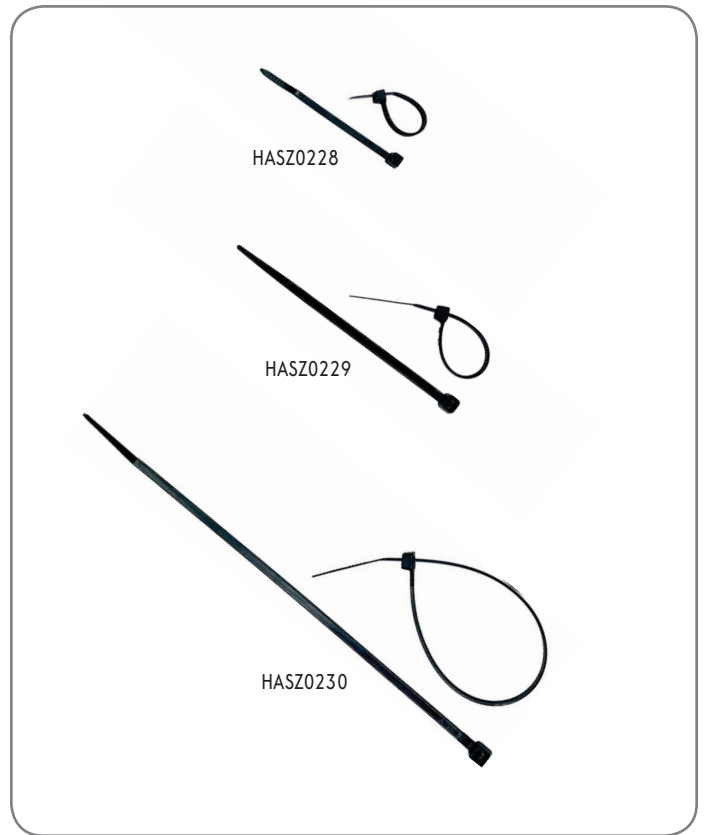
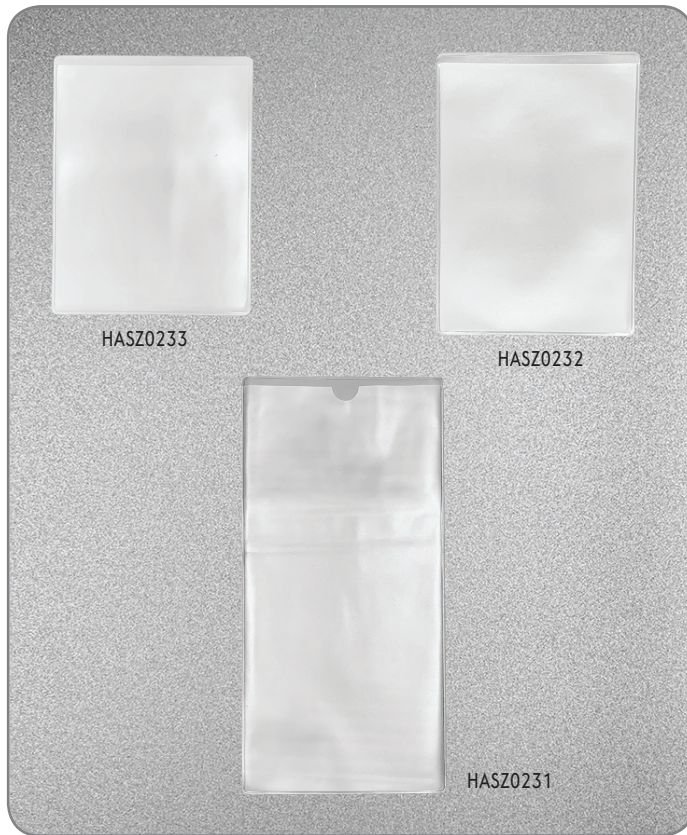

Item No.	Item	Quantity
HASZ0231	Vinyl Document Cover 8-7/8" x 4-3/8", clear	100
HASZ0232	Vinyl Passbook Cover 5-1/4" x 3-3/4", clear	100
HASZ0233	Vinyl Passbook Cover 4-3/4" x 3-3/4", clear	100
HASZ0228	Cable Ties 2-3/8" x .10"	100
HASZ0229	Cable Ties 4" x .14"	100
HASZ0230	Cable Ties 8" x .14"	100

Bookends and Sorters



HASZ0038



HASZ0039



HASZ0094



HASZ0089



HASZ0091



HASZ0095



HASZ0155



HASZ0158

Item No.	Item	Quantity
HASZ0038	Bookends 5 in., nonskid, black	1 pair
HASZ0089	Bookends 7 in., arched, black	1 pair
HASZ0095	Bookends 7 in., fan-hole pattern, gray	1 pair
HASZ0039	Bookends 9 in., nonskid, black	1 pair
HASZ0091	Bookends 9 in., fashion, black	1 pair
HASZ0094	Bookend Sorter 8 in., square, black	1
HASZ0155	Organizer, vertical, 4 slot, adjustable wire	1
HASZ0158	Organizer, vertical, 8 slot, adjustable wire	1

Organizers



HASZ0147



HASZ0145

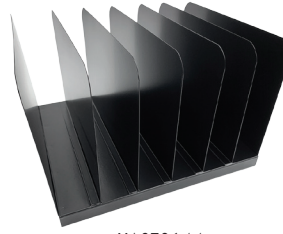

HASZ0144

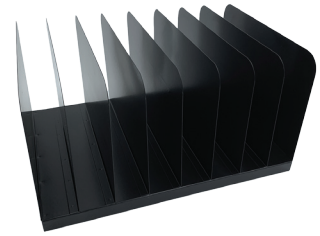

HASZ0146



HASZ0159



HASZ0152



HASZ0149



HASZ0157



HASZ0150



HASZ0151



HASZ0161



HASZ0153



HASZ0160

Item No.	Item	Quantity
HASZ0147	Organizer, vertical, 4 slots	1
HASZ0145	Organizer, vertical, 5 slots	1
HASZ0144	Organizer, vertical, 6 slots	1
HASZ0146	Organizer, vertical, 8 slots	1
HASZ0159	Organizer, horizontal, 3 slots	1
HASZ0152	Organizer, horizontal, 4 slots	1
HASZ0149	Organizer, horizontal, 5 slots	1
HASZ0157	Organizer, horizontal, 6 slots	1
HASZ0150	Organizer, horizontal, 7 slots	1
HASZ0151	Organizer, horizontal, legal, 4 slots	1
HASZ0161	Organizer, horizontal, legal, 5 slots	1
HASZ0153	Organizer, horizontal, legal, 6 slots	1
HASZ0160	Organizer, horizontal, legal, 7 slots	1

Organizers



HASZ0165



HASZ0148



HASZ0171



HASZ0209

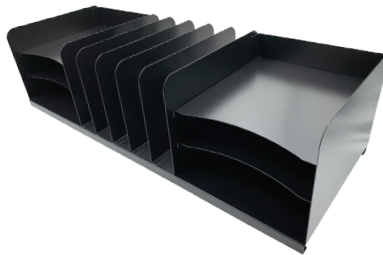

HASZ0170



HASZ0163



HASZ0164



HASZ0177

Item No.	Item	Quantity
HASZ0165	Organizer, vertical, 3 slanted, 4 slots	1
HASZ0148	Organizer, vertical, 3 horizontal, 3 slots	1
HASZ0171	Organizer, vertical, 5 horizontal, 3 slots, compact	1
HASZ0209	Organizer, horizontal, sort rack, 12 slots	1
HASZ0170	Organizer, vertical, 5 horizontal, 6 slots	1
HASZ0163	Organizer, vertical, 4 horizontal, legal, 3 slots	1
HASZ0164	Book rack, 6 slots	1
HASZ0177	Book rack, 2 tier (76cm X 28.5cm X 53cm)	1

Organizers



HASZ0154



HASZ0176

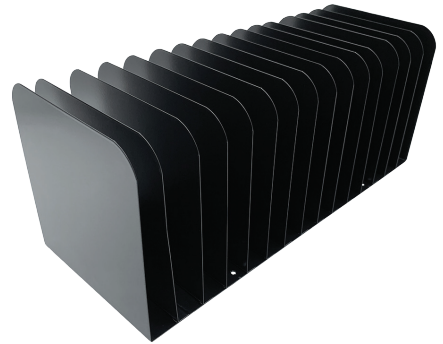

HASZ0178



HASZ0032



HASZ0180



HASZ0162

Item No.	Item	Quantity
HASZ0154	Large inbox	1
HASZ0176	Locking desktop inbox	1
HASZ0178	Message rack, 15 slots	1
HASZ0032	Stationery holder drawer, 3 compartments	1
HASZ0180	Stationery holder drawer, 4 compartments	1
HASZ0162	Stationery holder drawer, 5 compartments	1

Organizers

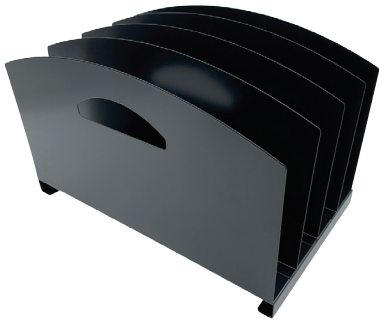

HASZ0169

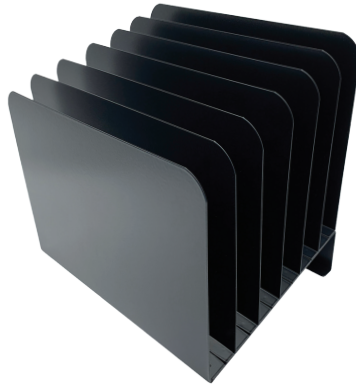

HASZ0174

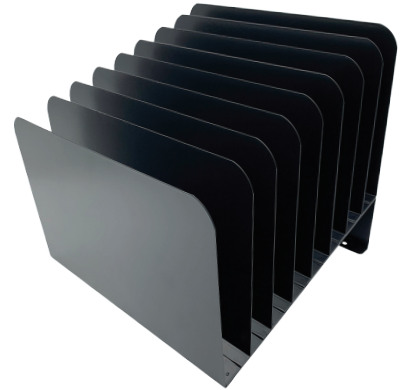

HASZ0156



HASZ0186



HASZ0184

Item No.	Item	Quantity
HASZ0169	Organizer, vertical, 4 slots with handles	1
HASZ0174	Organizer, slanted, 6 slots	1
HASZ0156	Organizer, slanted, 8 slots	1
HASZ0184	Wall sorter, 3 tier	1
HASZ0186	Wall pocket	1

Indoor and Outdoor Extension Cords



Item No.	Item	Color
HASA01002	Indoor Extension Cord, 6 ft., 16/2, 3 outlets, SPT2	White
HASA01003	Indoor Extension Cord, 6 ft., 16/2, 3 outlets, SPT2	Brown
HASA01004	Indoor Extension Cord, 9 ft., 16/2, 3 outlets, SPT2	White
HASA01005	Indoor Extension Cord, 9 ft., 16/2, 3 outlets, SPT2	Brown
HASA01006	Indoor Extension Cord, 9 ft., 16/2, 3 outlets, SPT2	Green
HASA01007	Indoor Extension Cord, 12 ft., 16/2, 3 outlets, SPT2	White
HASA01008	Indoor Extension Cord, 12 ft., 16/2, 3 outlets, SPT2	Brown
HASA01009	Indoor Extension Cord, 15 ft., 16/2, 3 outlets, SPT2	White
HASA01010	Indoor Extension Cord, 15 ft., 16/2, 3 outlets, SPT2	Brown
HASA01011	Indoor Extension Cord, 15 ft., 16/2, 3 outlets, SPT2	Green
HASA01012	Indoor Extension Cord, 15 ft., 16/3, 3 outlets, SPT2	Green
HASA01013	Outdoor Extension Cord, 9 ft., 16/3, 3 outlets, 13A	Green
HASA01014	Outdoor Extension Cord, 25 ft., 16/3, 3 outlets, 13A	Green
HASA01025	Outdoor Extension Cord, 25 ft., 16/3, 13A	Green
HASA01027	Outdoor Extension Cord, 50 ft., 16/3, 13A	Green
HASA01029	Outdoor Extension Cord, 100 ft., 16/3, 13A	Green
HASA01033	Outdoor Extension Cord, 25 ft., 14/3, 15A	Orange
HASA01108	Outdoor Extension Cord, 50 ft., 14/3, 15A	Orange
HASA01040	Outdoor Extension Cord, 100 ft., 14/3, 15A	Orange

Power Strips and Surge Protector Strips



HASA01015
 HASA01016
 HASA01019
 HASA01020

HASA01001
 HASA01018

HASA01017
 HASA01021

Item No.	Item	Amount
HASA01001	Power Strip, 4 outlets/2 USB ports, 2.5 feet, switched, 14/3	1
HASA01015	Power Strip, 6 outlets, 2.5 feet, switched, 14/3	1
HASA01016	Power Strip, 6 outlets, 3 feet, switched, 14/3	1
HASA01017	Power Strip, 6 outlets/2 USB ports, 3 feet, switched, 14/3	1
HASA01018	Surge Strip, 4 outlets/2 USB ports, 2.5 feet, switched	1
HASA01019	Surge Strip, 6 outlets, 2.5 feet, switched, 14/3	1
HASA01020	Surge Strip, 6 outlets, 3 feet, switched, 14/3	1
HASA01021	Surge Strip, 6 outlets/2 USB ports, 3 feet, switched	1

Other Household Electrical

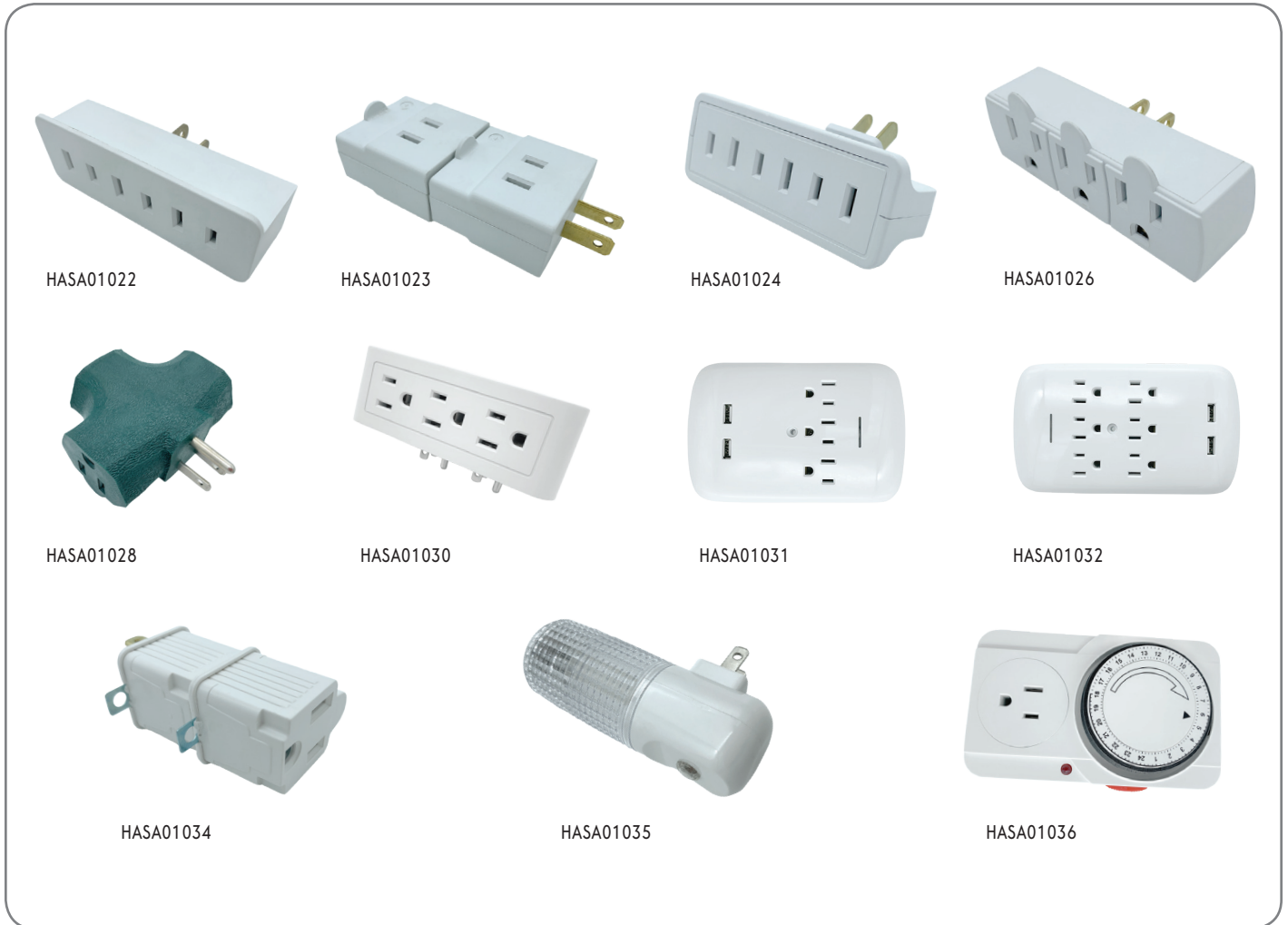

Item No.	Item	Amount
HASA01022	Power Tap, 3 outlets	1
HASA01023	Power Tap, 3 outlets, cube	2
HASA01024	Power Tap, 3 outlets, swivel	1
HASA01026	Power Tap, 3 outlets, grounded	1
HASA01028	Power Tap, 3 outlets, grounded, triangle	1
HASA01030	Power Tap, 6 outlets, 2 lines, grounded	1
HASA01031	Surge Tap, 3 outlets/2 USB ports	1
HASA01032	Surge Tap, 6 outlets/2 USB ports	1
HASA01034	Grounding Adapter, 3-to-2 prong, cube	2
HASA01035	Night Light	1
HASA01036	Mechanical Timer, indoor, 1 outlet	1

Alkaline Batteries

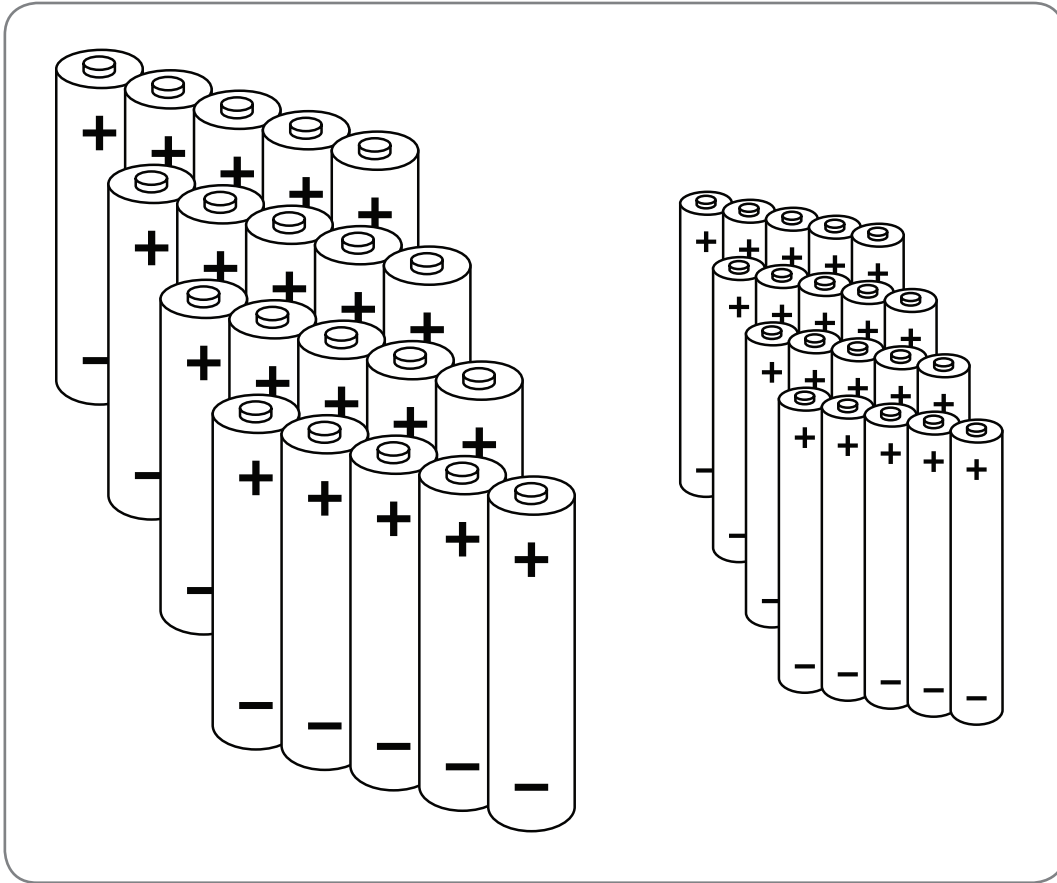

Item No.	Type	Quantity
HASB01004	AA	4
HASB01020	AA	20
HASB02004	AAA	4
HASB02020	AAA	20

Heat-Shrink Ring Terminals

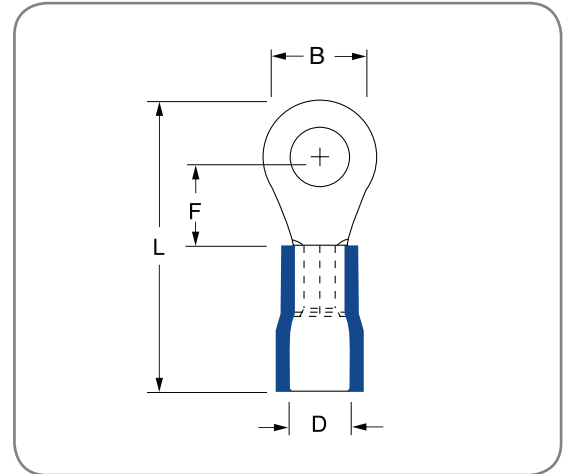

Base metal: pure copper Surface plating: tin plate Insulation: heat-shrink tube										
Item No.	USA Bolt No.	Bolt Diam. d2 (mm)	Dimension (mm)				A.W.G.	Max. Current	Quantity	Color
			B	L	F	D				
HASU02001	#10	5.3	9.5	35	8.3	6.7	12-10	48A	6	Yellow
HASU02002	1/4	6.4	12	43	13	6.7	12-10	48A	6	Yellow
HASU02003	5/16	8.4	15	43	13.7	6.7	12-10	48A	6	Yellow
HASU02004	3/8	10.5	15	43	13.7	6.7	12-10	48A	6	Yellow
HASU02005	1/2	13	19.2	48	16	6.7	12-10	48A	6	Yellow
HASU02007	#8	4.3	8.5	31.5	7.75	5.7	16-14	27A	8	Blue
HASU02008	#10	5.3	9.5	33.5	7.25	5.7	16-14	27A	8	Blue
HASU02009	1/4	6.4	12	39.5	11	5.7	16-14	27A	8	Blue
HASU02010	5/16	8.1	12	39.5	11	5.7	16-14	27A	8	Blue
HASU02006	3/8	10.5	13.6	43	13.9	5.7	16-14	27A	8	Blue
HASU02012	#8	4.3	8	33.5	7	4.7	22-18	19A	10	Red
HASU02013	#10	5.3	8	33.5	7	4.7	22-18	19A	10	Red
HASU02014	1/4	6.4	11.6	39.5	11.1	4.7	22-18	19A	10	Red
HASU02015	5/16	8.1	11.6	39.5	11.1	4.7	22-18	19A	10	Red
HASU02016	Assortment, 22-10 gauge								14	

PVC Ring Terminals

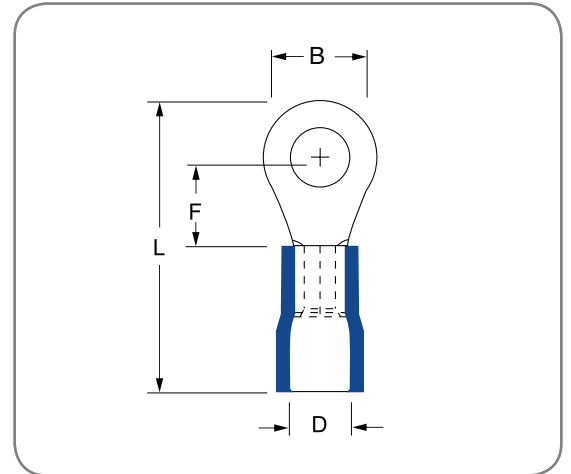

Base metal: pure copper Surface plating: tin plate Insulation: PVC										
Item No.	USA Bolt No.	Bolt Diam. d2 (mm)	Dimension (mm)				A.W.G.	Max. Current	Quantity	Color
			B	L	F	D				
HASU02017	#10	5.3	9.5	25.5	8.3	6.7	12-10	48A	13	Yellow
HASU02018	1/4	6.4	12	31.5	13	6.7	12-10	48A	13	Yellow
HASU02019	5/16	8.4	15	33.7	13.7	6.7	12-10	48A	13	Yellow
HASU02020	3/8	10.5	15	33.7	13.7	6.7	12-10	48A	13	Yellow
HASU02021	1/2	13	19.2	38.1	16	6.7	12-10	48A	13	Yellow
HASU02022	#6	3.7	6.6	21	7	4.9	16-14	27A	20	Blue
HASU02023	#8	4.3	8.5	22.5	7.75	4.9	16-14	27A	20	Blue
HASU02024	#10	5.3	9.5	22.5	7.25	4.9	16-14	27A	20	Blue
HASU02025	1/4	6.4	12	27.6	11	4.9	16-14	27A	20	Blue
HASU02026	5/16	8.4	12	27.6	11	4.9	16-14	27A	20	Blue
HASU02027	3/8	10.5	13.6	30.2	13.9	4.9	22-18	27A	20	Blue
HASU02028	#8	4.3	8	21.5	7	4.3	22-18	19A	20	Red
HASU02029	#10	5.3	9.8	23	8.5	4.3	22-18	19A	20	Red
HASU02030	1/4	6.4	11.6	27.5	11.1	4.3	22-18	19A	20	Red
HASU02031	5/16	8.4	11.6	27.5	11.1	4.3	22-18	19A	20	Red
HASU02032	Assortment includes 2 each of #10, 1/4, 5/16, 3/8, 1/2 (12-10 AWG, yellow); #6, #8, #10, 1/4, 5/16, 3/8 (16-14 AWG, blue; and #8, #10, 1/4, 5/16 (22-18 AWG red).								30	

Heat-Shrink Spade Terminals

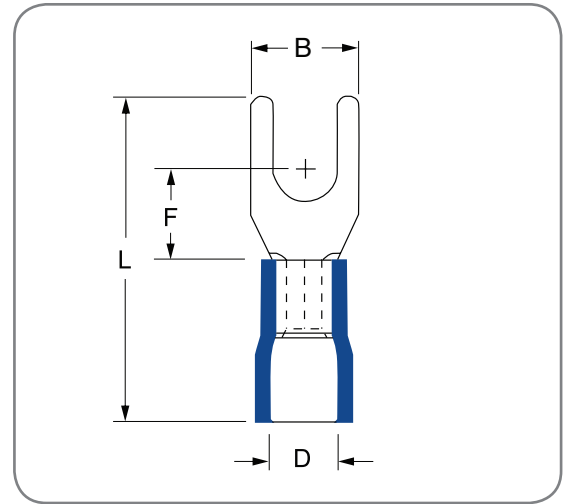

Base metal: pure copper Surface plating: tin plate Insulation: heat-shrink tube										
Item No.	USA Bolt No.	Bolt Diam. d2 (mm)	Dimension (mm)				A.W.G.	Max. Current	Quantity	Color
			B	L	F	D				
HASU02033	#8	4.3	9	35	7.5	6.7	12-10	48A	8	Yellow
HASU02034	#10	5.3	9	35	7.5	6.7	12-10	48A	8	Yellow
HASU02035	#8	4.3	7.2	33	6.5	5.7	16-14	27A	10	Blue
HASU02036	#10	5.3	9.5	33	6.5	5.7	16-14	27A	10	Blue
HASU02037	#6	3.7	6.4	33	6.5	4.7	22-16	19A	12	Red
HASU02038	#8	4.3	7.2	33	6.5	4.7	22-16	19A	12	Red
HASU02039	Assortment includes 2 each of #8, #10 (12-10 AWG yellow); #8, #10 (16-14 AWG blue); and #6, #8 (22-16 AWG red).								12	

PVC Spade Terminals

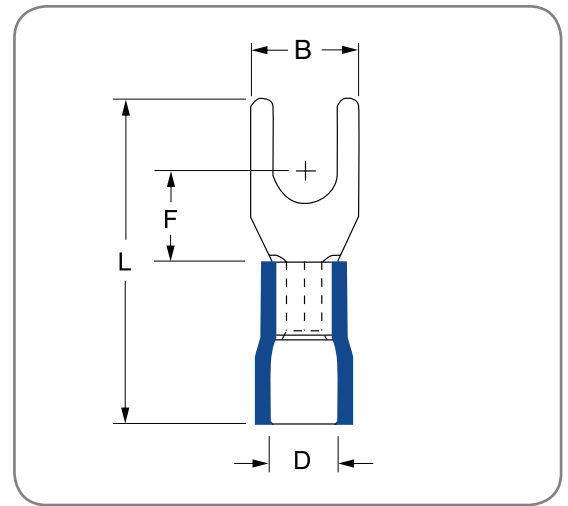
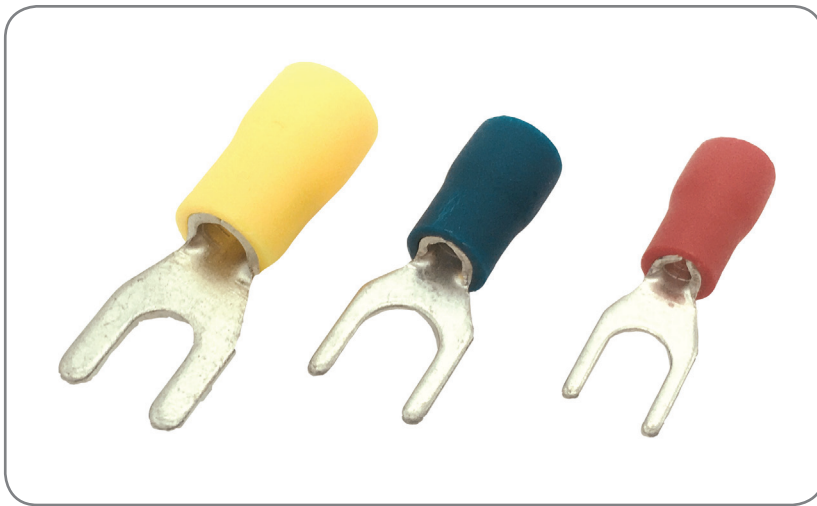

Base metal: pure copper Surface plating: tin plate Insulation: PVC										
Item No.	USA Bolt No.	Bolt Diam. d2 (mm)	Dimension (mm)				A.W.G.	Max. Current	Quantity	Color
			B	L	F	D ϕ				
HASU02040	#8	4.3	9	25.2	7.5	6.7	12-10	48A	15	Yellow
HASU02041	#10	5.3	9	25.2	7.5	6.7	12-10	48A	15	Yellow
HASU02042	#6	3.7	6	21.2	6.5	4.9	16-14	27A	20	Blue
HASU02043	#8	4.3	7.2	21.2	6.5	4.9	16-14	27A	20	Blue
HASU02044	#8	4.3	7.2	21.2	6.5	4.9	16-14	27A	100	Blue
HASU02045	#10	5.3	9.5	21.2	6.5	4.9	16-14	27A	20	Blue
HASU02046	#10	5.3	9.5	21.2	6.5	4.9	16-14	27A	100	Blue
HASU02047	#6	3.7	6.4	21.2	6.5	4.7	22-18	19A	20	Red
HASU02048	#8	4.3	7.2	21.2	6.5	4.3	22-18	19A	20	Red
HASU02049	#10	5.3	9.5	21.2	6.5	4.3	22-18	19A	20	Red
HASU02050	Assortment includes 2 each of #8, #10 (12-10 AWG yellow); #6, #8, #10 (16-14 AWG blue); and #6, #8, #10 (22-18 AWG red).								16	

Heat-Shrink Disconnects

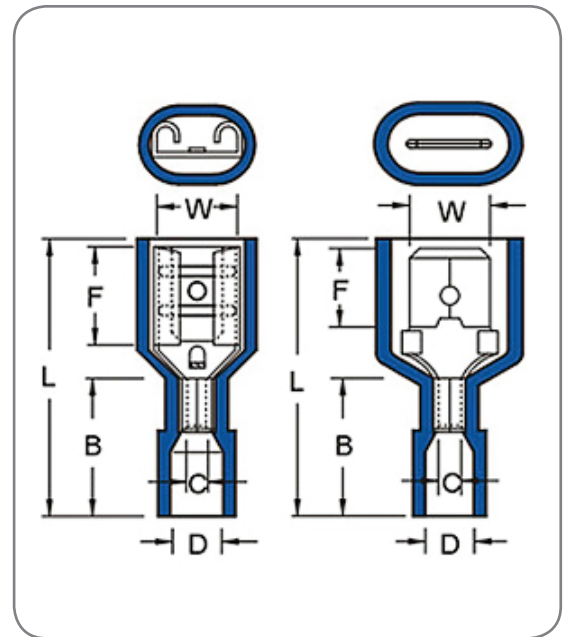

Base metal: brass Surface plating: tin plate Insulation: nylon										
Item No.	Dimension (mm)						A.W.G.	Max. Current	Quantity	Color
	W	F	L	B	D	C				
HASU02051	Pairs of male and female disconnects						12-10	24A	4	Yellow
HASU02052	6.35	7.7	25	13	6.3	3.4	12-10	24A	8	Yellow
HASU02053	6.6	7.3	24	13	6.3	3.4	12-10	24A	8	Yellow
HASU02054	Pairs of male and female disconnects						16-14	15A	5	Blue
HASU02055	6.35	7.7	24	11	4.5	2.3	16-14	15A	10	Blue
HASU02056	6.6	7.3	22	11	4.5	2.3	16-14	15A	10	Blue
HASU02057	Pairs of male and female disconnects						16-14	10A	6	Red
HASU02058	6.35	7.7	23	11	4	1.7	22-18	10A	12	Red
HASU02059	6.6	7.3	22	11	4	1.7	22-18	10A	12	Red

PVC Disconnects

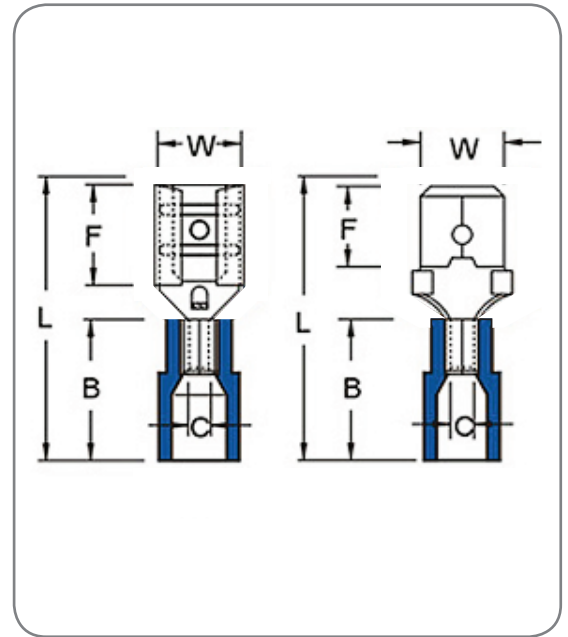

Base metal: brass Surface plating: tin plate Insulation: PVC											
Item No.	Tame Tab (mm)	Thickness of Material	Dimension (mm)					A.W.G.	Max. Current	Quantity	Color
			H	C	W	L	B				
HASU02060	Pairs of male and female joints							12-10	24A	10	Yellow
HASU02061	0.8 x 6.35	0.4	6.35	3.4	5.7	25	13	12-10	24A	20	Yellow
HASU02062	0.8 x 6.35	0.4	7.4	3.4	5.7	25	13	12-10	24A	20	Yellow
HASU02063	0.8 x 6.35	0.4	7.4	3.4	5.7	25	13	12-10	24A	100	Yellow
HASU02064	Pairs of male and female joints							16-14	15A	10	Blue
HASU02065	0.8 x 6.35	0.4	6.35	2.3	4.3	21	10	16-14	15A	20	Blue
HASU02066	0.8 x 6.35	0.4	7.4	2.3	4.3	21	10	16-14	15A	20	Blue
HASU02067	0.8 x 6.35	0.4	7.4	2.3	4.3	21	10	16-14	15A	100	Blue
HASU02068	Pairs of male and female joints							22-18	10A	10	Red
HASU02069	0.8 x 6.35	0.4	6.35	1.7	4.3	21	10	22-18	10A	20	Red
HASU02070	0.8 x 6.35	0.4	7.4	1.7	3.8	21	10	22-18	10A	20	Red
HASU02071	Assortment includes 2 male-female pairs of each of 12-10 AWG yellow, 16-14 AWG blue, and 22-18 AWG red.									12	

Heat-Shrink Bullet Connectors

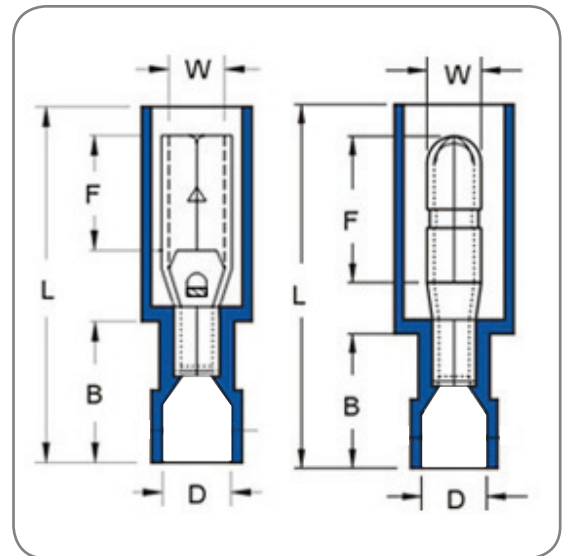

MALES Base metal: brass Surface plating: tin plate Insulation: nylon								
Item No.	Thickness of Material	Dimension (mm)			A.W.G.	Max. Current	Quantity	Color
		W	D	L				
HASU02073	0.4	5	6.7	34	12-10	24A	8	Yellow
HASU02076	0.4	4	5.7	34	16-14	15A	10	Blue
HASU02079	0.4	4	4.7	33	22-18	10A	12	Red

FEMALES Base metal: brass Surface plating: tin plate Insulation: nylon								
Item No.	Thickness of Material	Dimension (mm)			A.W.G.	Max. Current	Quantity	Color
		W	D	L				
HASU02074	0.4	5	6.4	31	12-10	24A	8	Yellow
HASU02077	0.4	4	5.7	29	16-14	15A	10	Blue
HASU02080	0.4	4	5.2	29	22-18	10A	12	Red

MALE AND FEMALE PAIRS Base metal: brass Surface plating: tin plate Insulation: nylon								
Item No.	Thickness of Material	Dimension (mm)			A.W.G.	Max. Current	Quantity	Color
		W	D	L				
HASU02072	Pairs of male and female connectors				12-10	24A	4	Yellow
HASU02075	Pairs of male and female connectors				16-14	15A	5	Blue
HASU02078	Pairs of male and female connectors				22-18	10A	6	Red

PVC Bullet Connectors

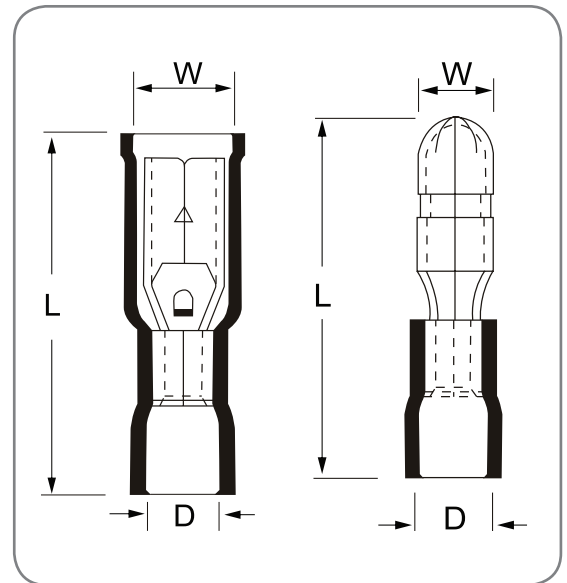

MALES Base metal: brass Surface plating: tin plate Insulation: PVC										
Item No.	Thickness of Material	Dimension (mm)					A.W.G.	Max. Current	Quantity	Color
		W	F	D	B	L				
HASU02082	0.4	5	12	3.4	13	25	12-10	24A	18	Yellow
HASU02085	0.4	4	11	2.3	10	21	16-14	15A	20	Blue
HASU02088	0.4	4	11	1.7	10	21	22-18	10A	22	Red

FEMALES Base metal: brass Surface plating: tin plate Insulation: PVC										
Item No.	Thickness of Material	Dimension (mm)					A.W.G.	Max. Current	Quantity	Color
		W	F	D	B	L				
HASU02083	0.4	5	7	3.4	14	29.5	12-10	24A	18	Yellow
HASU02086	0.4	4	6.3	2.3	14	24.5	16-14	15A	20	Blue
HASU02089	0.4	4	6.3	1.7	13	24.5	22-18	10A	22	Red

MALE AND FEMALE PAIRS Base metal: brass Surface plating: tin plate Insulation: PVC										
Item No.	Thickness of Material	Dimension (mm)					A.W.G.	Max. Current	Quantity	Color
		W	F	D	B	L				
HASU02081		Pairs of male and female conductors					12-10	24A	9	Yellow
HASU02084		Pairs of male and female conductors					16-14	15A	10	Blue
HASU02087		Pairs of male and female conductors					22-18	10A	11	Red

Heat-Shrink Butt Splice Connectors

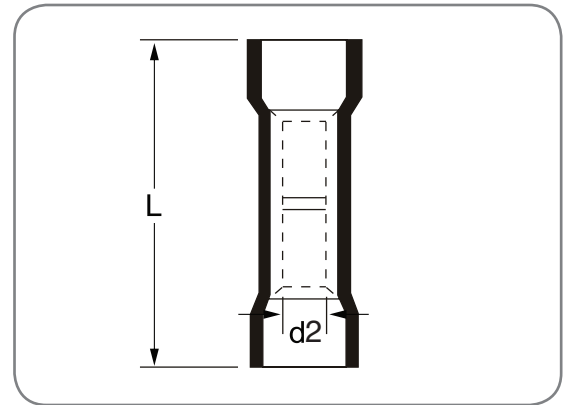

Base metal: copper Surface plating: tin plate Insulation: heat-shrink tube Max. current: same as source wire						
Item No.	Wire Range (mm)	Dimension (mm)		A.W.G.	Quantity	Color
		d2	L			
HASU02161	4-6	3.4	41	12-10	5	Yellow
HASU02162	1.5-2.5	2.3	36	16-14	6	Blue
HASU02163	0.5-1.5	1.7	36	22-16	7	Red
HASU02164	Assortment includes 2 each of 12-10 AWG yellow, 16-14 AWG blue, and 22-16 red.				6	

PVC Butt Splice Connectors

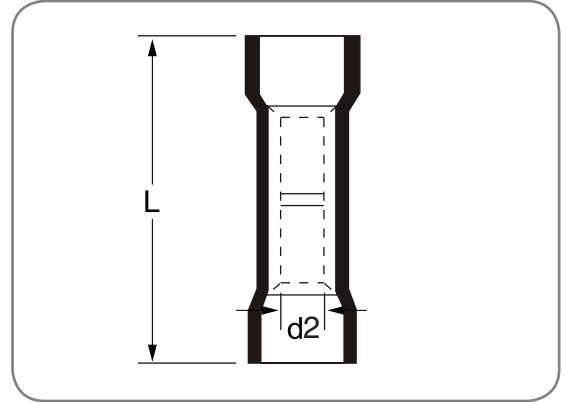

Base metal: copper Surface plating: tin plate Insulation: PVC							
Item No.	Wire Range (mm)	Dimension (mm)		A.W.G.	Max. Current	Quantity	Color
		d2	L				
HASU02165	4-6	3.4	26	12-10	48A	12	Yellow
HASU02166	4-6	3.4	26	12-10	48A	100	Yellow
HASU02167	1.5-2.5	2.3	26	16-14	27A	15	Blue
HASU02168	1.5-2.5	2.3	26	16-14	27A	100	Blue
HASU02169	0.5-1.5	1.7	26	22-16	19A	20	Red
HASU02170	0.5-1.5	1.7	26	22-16	19A	100	Red
HASU02171	Assortment includes 4 each of 12-10 AWG yellow, 16-14 AWG blue, and 22-16 red.					12	

Connector Sets

Item No.	Item	A.W.G.	Quantity	Color
HASU02095	Assorted PVC-insulated terminals	22-10	40	Assorted
HASU02096	Assorted PVC-insulated terminals	22-10	175	Assorted
HASU02097	Assorted PVC-insulated terminals	12-10	28	Yellow
HASU02098	Assorted PVC-insulated terminals	16-14	48	Blue
HASU02099	Assorted PVC-insulated terminals	16-14	46	Red

Pigtail Connectors

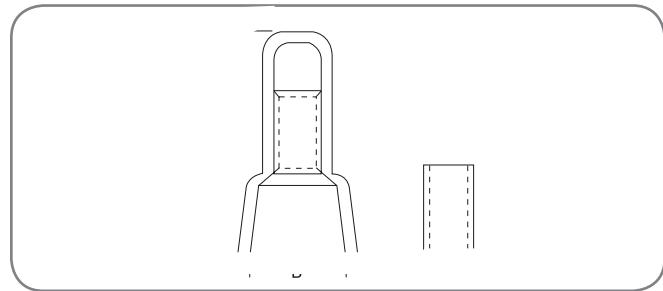

Item No.	A.W.G.	Quantity	Color
HASU02151	22-10	10	Gray
HASU02152	22-14	10	Gray
HASU02153	22-18	15	Gray

Tap Splices

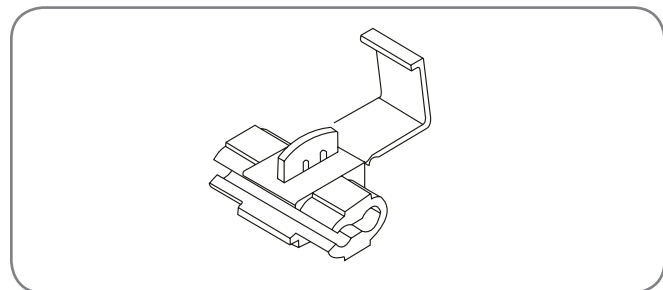
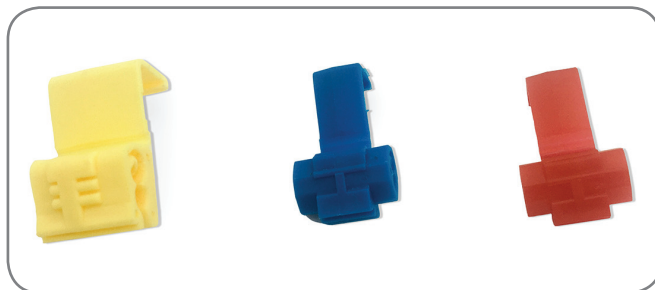

Item No.	A.W.G.	Quantity	Color
HASU02154	12-10	5	Yellow
HASU02155	16-14	6	Blue
HASU02156	22-18	7	Red
HASU02157	Assortment includes 2 each of 12-10 AWG yellow, 16-14 AWG blue, and 22-18 AWG red.		

Wire Nuts

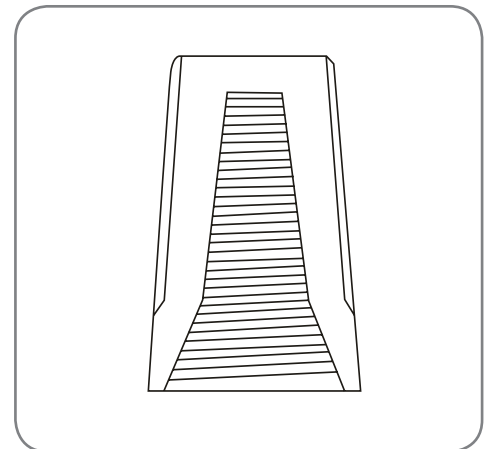

Base metal: stainless steel Insulation: PVC Max. current: same as source wire						
Item No.	Dimension (mm)			A.W.G.	Quantity	Color
	B	C	L			
HASU02201	16	13	26.5	18-8	6	Red
HASU02202	16	13	26.5	18-8	25	Red
HASU02203	16	13	26.5	18-8	50	Red
HASU02204	13.7	10	24.5	18-10	9	Yellow
HASU02205	13.7	10	24.5	18-10	25	Yellow
HASU02206	13.7	10	24.5	18-10	50	Yellow
HASU02207	12.6	9.9	22.1	22-14	12	Orange
HASU02208	12.6	9.9	22.1	22-14	25	Orange
HASU02209	12.6	9.9	22.1	22-14	50	Orange
HASU02210	10.1	7.4	17.5	22-14	14	Blue
HASU02211	10.1	7.4	17.5	22-14	25	Blue
HASU02212	10.1	7.4	17.5	22-14	150	Blue
HASU02213	8.5	6.7	15	22-16	14	Gray
HASU02214	8.5	6.7	15	22-16	25	Gray
HASU02215	8.5	6.7	15	22-16	150	Gray
HASU02216	Assortment includes 2 each of 18-8 AWG red, 22-14 AWG orange, and 22-16 AWG gray; and 3 of 18-10 AWG yellow.				9	
HASU02217	Assortment includes 5 each of 18-8 AWG red, 22-14 AWG orange, and 22-16 AWG gray; 7 of 18-10 AWG yellow; and 3 of 22-14 AWG blue.				25	
HASU02218	Assortment includes 2 each of 22-14 AWG orange, 22-14 AWG blue, and 22-16 AWG gray.				6	
HASU02219	Assortment includes 5 each of 22-14 AWG blue and 22-16 AWG gray.				10	

Winged Wire Nuts

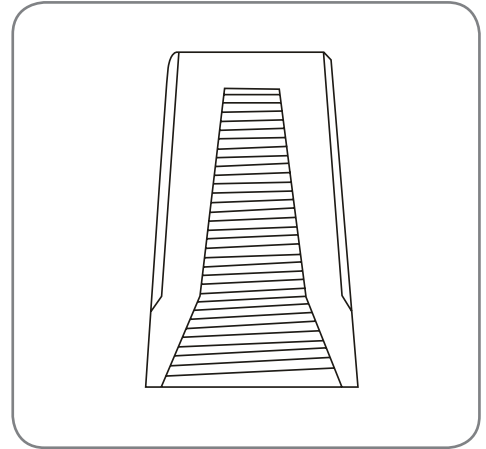
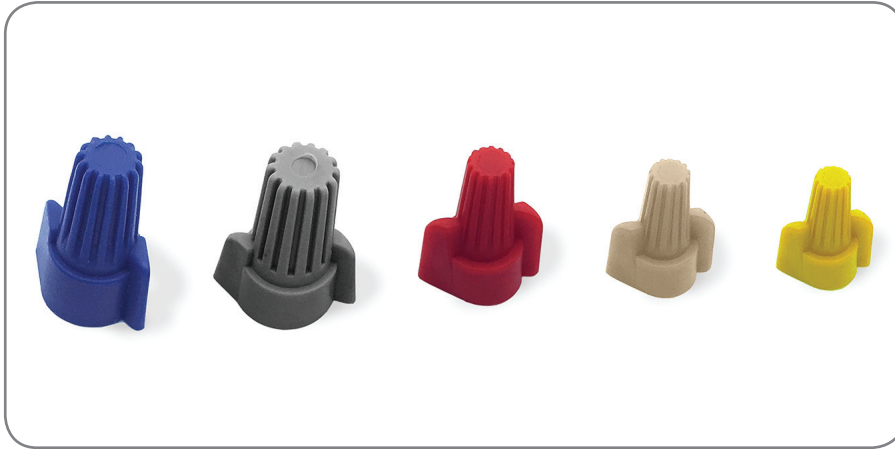

Item No.	A.W.G.	Quantity	Color
HASU02251	22-10	6	Yellow
HASU02252	22-10	25	Yellow
HASU02253	22-8	6	Tan
HASU02254	22-6	6	Red
HASU02255	22-6	25	Red
HASU02256	14-6	2	Gray
HASU02257	14-6	2	Blue
HASU02258	Assortment includes 3 each of 22-10 AWG yellow, 22-6 AWG red, and 14-6 AWG blue.		

Primary Wire



10 GAUGE

Length	Pkg.	Black	White	Red	Brown	Blue	Green	Yellow	Gray
		8 ft.	Coil	HASU03021	HASU03022	HASU03023	HASU03024	HASU03025	HASU03026
100 ft.	Spool	HASU03031	HASU03032	HASU03033	HASU03034	HASU03035	HASU03036	HASU03037	HASU03038

12 GAUGE

Length	Pkg.	Black	White	Red	Brown	Blue	Green	Yellow	Gray
		12 ft.	Coil	HASU03041	HASU03042	HASU03043	HASU03044	HASU03045	HASU03046
100 ft.	Spool	HASU03051	HASU03052	HASU03053	HASU03054	HASU03055	HASU03056	HASU03057	HASU03058

14 GAUGE

Length	Pkg.	Black	White	Red	Brown	Blue	Green	Yellow	Gray
		20 ft.	Coil	HASU03061	HASU03062	HASU03063	HASU03064	HASU03065	HASU03066
100 ft.	Spool	HASU03071	HASU03072	HASU03073	HASU03074	HASU03075	HASU03076	HASU03077	HASU03078

16 GAUGE

Length	Pkg.	Black	White	Red	Brown	Blue	Green	Yellow	Gray
		28 ft.	Coil	HASU03081	HASU03082	HASU03083	HASU03084	HASU03085	HASU03086
100 ft.	Spool	HASU03091	HASU03092	HASU03093	HASU03094	HASU03095	HASU03096	HASU03097	HASU03098

18 GAUGE

Length	Pkg.	Black	White	Red	Brown	Blue	Green	Yellow	Gray
		40 ft.	Coil	HASU03101	HASU03102	HASU03103	HASU03104	HASU03105	HASU03106
100 ft.	Spool	HASU03111	HASU03112	HASU03113	HASU03114	HASU03115	HASU03116	HASU03117	HASU03118

Heat-Shrink Tubing



Item No.	Width (in.)	Length (in.)	Quantity
HASU03140	1/16	4	8
HASU03141	3/32	4	8
HASU03142	1/8	4	8
HASU03143	3/16	4	8
HASU03144	1/4	4	8
HASU03145	3/8	4	8
HASU03146	Assortment	4	8

Cable Ties (White)

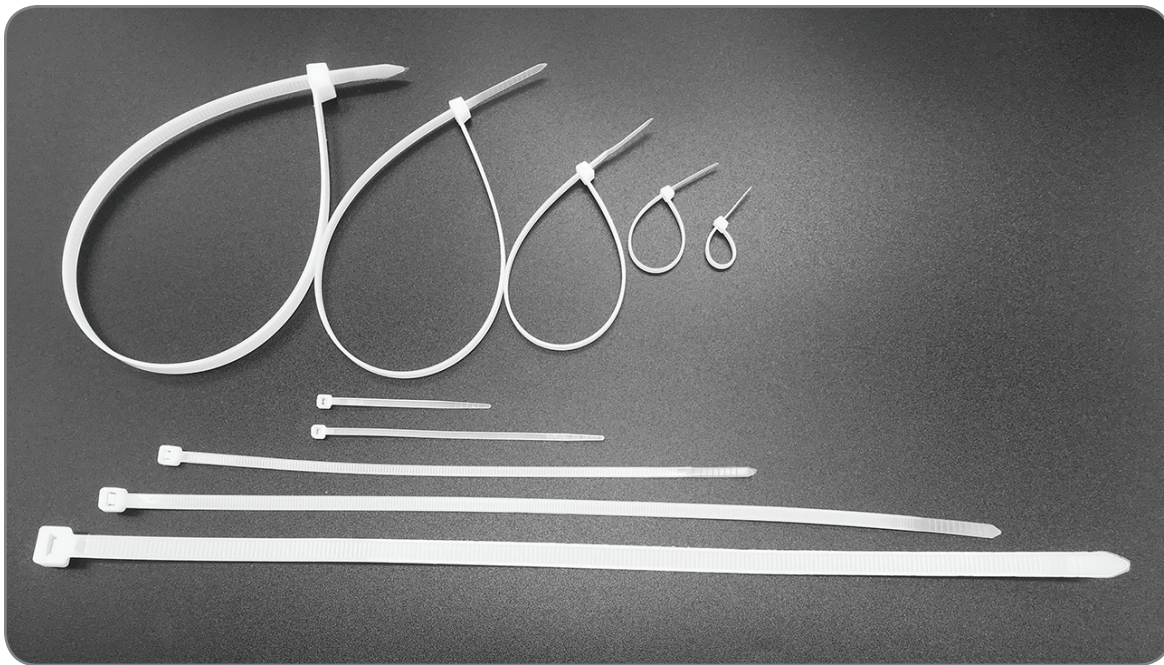

Working Temperature: 14°F–176°F			
Item No.	Dimension (in.)		Quantity
	Width	Length	
HASU02301	.10	2 3/8	100
HASU02302	.10	4	100
HASU02303	.14	4	100
HASU02304	.10	8	100
HASU02305	.14	8	100
HASU02306	.19	8	100
HASU02307	.14	12	100
HASU02308	.19	12	100
HASU02309	.30	12	100
HASU02310	.14	14.5	100
HASU02311	.19	14.5	100
HASU02312	.14	14.5	100

Working Temperature: 32°F–176°F			
Item No.	Dimension (in.)		Quantity
	Width	Length	
HASU02325	.10	4	100
HASU02326	.14	4	100
HASU02327	.10	8	100
HASU02328	.14	8	100
HASU02329	.19	8	100
HASU02330	.28	8	100
HASU02331	.14	12	100
HASU02332	.19	12	100
HASU02333	.28	12	100
HASU02334	.30	12	100
HASU02335	.14	14.5	100
HASU02336	.19	14.5	100
HASU02337	.28	14.5	100
HASU02338	.30	14.5	100

Cable Ties (Black)



Working Temperature: 14°F–176°F			
Item No.	Dimension (in.)		Quantity
	Width	Length	
HASU02313	.10	2 3/8	100
HASU02314	.10	4	100
HASU02315	.14	4	100
HASU02316	.10	8	100
HASU02317	.14	8	100
HASU02318	.19	8	100
HASU02319	.14	12	100
HASU02320	.19	12	100
HASU02321	.30	12	100
HASU02322	.14	14.5	100
HASU02323	.19	14.5	100
HASU02324	.14	14.6	100

Working Temperature: 32°F–176°F			
Item No.	Dimension (in.)		Quantity
	Width	Length	
HASU02339	.10	4	100
HASU02340	.14	4	100
HASU02341	.10	8	100
HASU02342	.14	8	100
HASU02343	.19	8	100
HASU02344	.28	8	100
HASU02345	.14	12	100
HASU02346	.19	12	100
HASU02347	.28	12	100
HASU02348	.30	12	100
HASU02349	.14	14.5	100
HASU02350	.19	14.5	100
HASU02351	.28	14.5	100
HASU02352	.30	14.5	100

USB Cables, Car and Wall Adapters, Flashlights, Cliplights

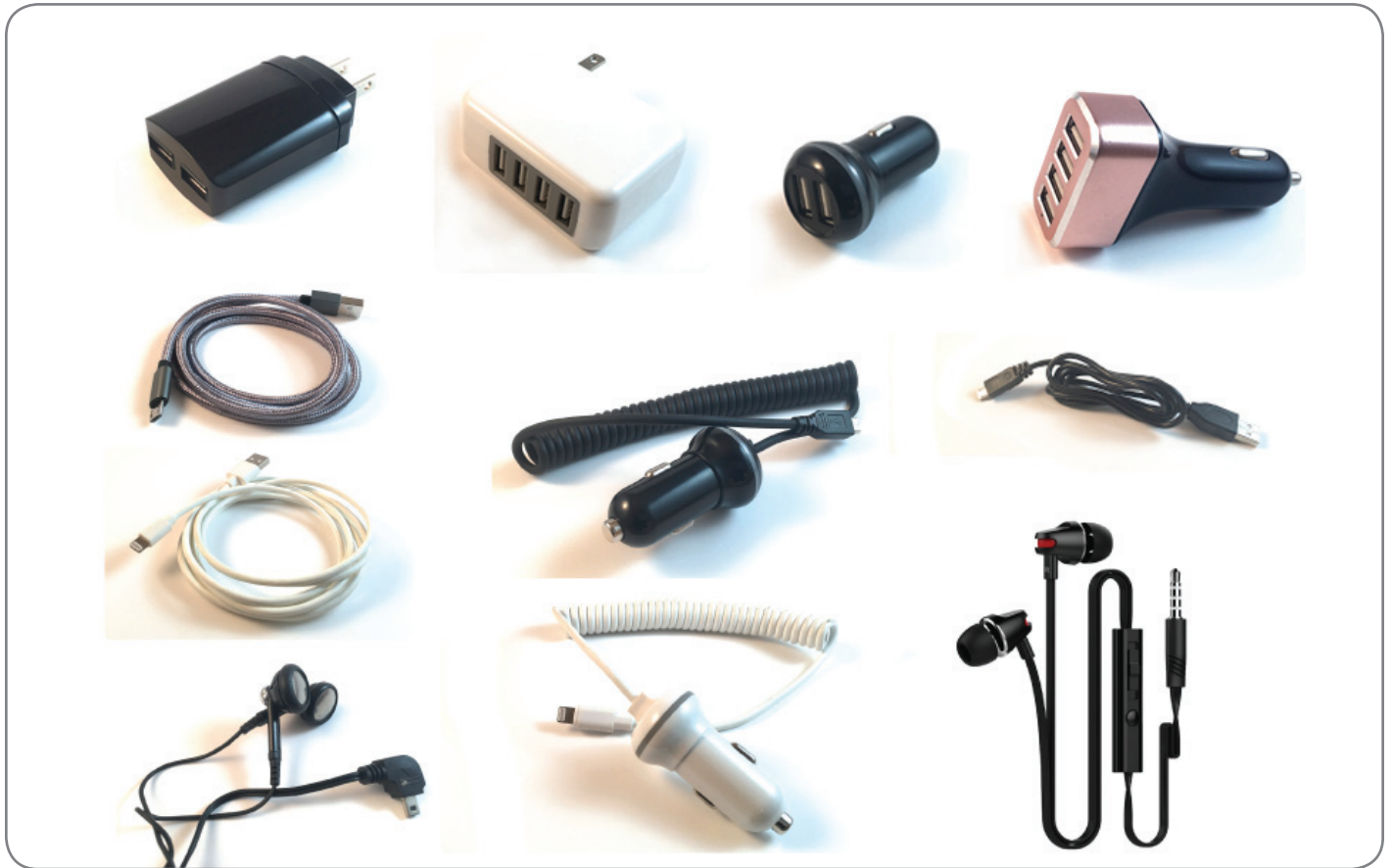

Item No.	Item
HASP01001	Android USB Cable, 2A, unbraided, 3.3'
HASP01002	Android USB Cable, 2A, braided, 6.6'
HASP01004	Lightning USB Cable, MFI, 2A, braided, 6.6'
HASP01005	Car Adapter, 12-24V to 2xUSB, 2.1A
HASP01006	Car Adapter, 12-24V to 2xUSB, 2.4A
HASP01007	Car Adapter, 12-24V to 4xUSB, 5A
HASP01008	Car Adapter, 12-24V Android, 2.1V, 4'
HASP01009	Car Adapter, 12-24V Lightning, 2.1V, 4'
HASP01010	Wall Adapter, 110V to 2xUSB, 2A
HASP01011	Wall Adapter, 110V to 2xUSB, 2.4A
HASP01013	Wall Adapter, 110V to 4xUSB
HASP01016	Premium Ear Buds with Microphone
HASP01028	LED Flashlight, 350 LUM, rechargeable
HASP01029	LED Flashlight, 500 LUM, 1xAAA included
HASP01030	LED Flashlight, 100 LUM, 1xAAA included
HASP01031	Cliplight, 150 LUM, 3xAAA

Huron Applied Sciences, LLC, was formed to supply consumer electrical products, hobby and craft items, tools, and other products to the mass market. The company's aim is to efficiently develop products in segments that are deemed either too small or too far outside of customers' core product development competencies for them to profitably source the products directly themselves. We do this in a manner that is highly collaborative, introducing product that fits the unique needs of each customer with respect to features, pricing and margins, packaging, and branding and graphics.