

## GV-QSD5731-IR (33X) 5MP H.265 Low Lux WDR Pro Outdoor IR IP Speed Dome



- 1/2.8" progressive scan low lux CMOS sensor
- Min. illumination at 0.002 lux
- Quad streams from H.265, H.264 or MJPEG
- Up to 30 fps at 2592 x 1944
- 33x optical zoom and 10x digital zoom
- Day and night function (with removable IR-cut filter)
- Intelligent IR
- IR distance up to 150 m (500 ft)
- Wide Dynamic Range Pro (WDR Pro)
- Temperature tolerance (-40°C ~ 50°C / -40°F ~ 122°F)
- Support for TV-out
- Two-way audio
- Built-in SD card slot (SDHC/SDXC, Class 10) for local storage
- Ingress protection (IP66)
- Vandal resistance (IK10 for housing)
- High PoE (PoE++, 60W) / AC 24V / DC 30V
- Pan 360° endlessly
- Tilt from -20° to 100°
- Pan and tilt speed of up to 280°/sec
- PTZ movement (Preset, Cruise, Auto Pan, Sequence)
- PTZ auto tracking
- Electrical Image Stabilizer (EIS)
- Servo Feedback, returning the camera view to the previous position upon encountering external forces
- 3D noise reduction
- Privacy Mask
- 12 languages on Web interface
- ONVIF (Profile G, S, T) conformant

\*Optional GV-PA902BT Gigabit PoE Adapter is required for applying PoE function.

\*Optional GV-Mount (GV-Mount104-1 / 105-1 / 210-1 / 208-4) is required for installing GV-QSD5731-IR.

### Introduction

GV-IP Speed Dome (GV-QSD5731-IR) is an outdoor network PTZ camera that offers 33x optical zoom and 10x digital zoom, capable of showing smooth live view with great details. This camera can simultaneously deliver four video streams in resolutions up to 2592 x 1944 at 30 fps, which allows up to 150 m (500 ft) effective IR distance. GV-QSD5731-IR supports H.265 video codec to achieve better compression ratio while maintaining high quality pictures at reduced network bandwidths.

Wide surveillance coverage is made possible with 360° endless panning and -20°~100° tilting capacity. PTZ functions such as Preset, Auto Pan, and Patrol can be programmed and activated by schedule. The GV-QSD5731-IR supports pan/tilt speeds ranging from a fast patrol of 280° per second to a slow ramble of 0.1° per second with 0.1° pan accuracy for fast and accurate tracking ability.

GV-QSD5731-IR also features Servo Feedback and Electronic Image Stabilizer (EIS) technology. The Servo Feedback technology ensures the camera view returns to the previous position when encountering external force (e.g. human interference) or environmental vibration. EIS technology can effectively produce stable images by actively sensing directional movement of the images and compensating accordingly; this is particularly useful for cameras installed at places where environmental movement (e.g. strong wind, the passing-by heavy vehicles) is constant, and when high optical zoom is executed.

## Dimensions

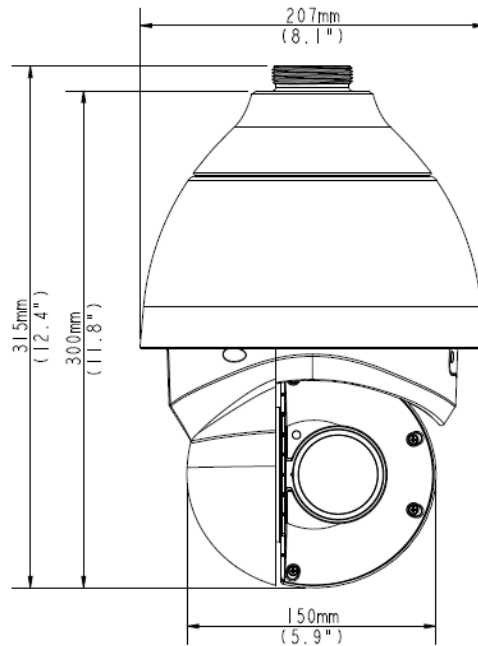

## Specifications

Camera		
Image Sensor	1/2.8" progressive scan low lux CMOS	
Optical Zoom	33x	
Digital Zoom	10x	
Picture Elements	2592 (H) x 1944 (V)	
Minimum Illumination	Color	0.02 Lux
	B/W	0.002 Lux
	IR ON	0 Lux
Shutter Speed	Auto / Manual (1 ~ 1/10000 sec)	
White Balance	Auto / Manual	
Iris Control	Auto / Manual	
WDR Pro	Yes	
Optical Lens		
Megapixel	Yes	
Day / Night	Yes (with removable IR-cut filter)	
Focal Length	4.6 ~ 152 mm	
Maximum Aperture	F/1.6	
Horizontal FOV	55° ~ 2°	
Operation	Focus	Auto / Manual
	Zoom	33x
	Iris	Auto / Manual
IR LED Quantity	16 IR LEDs	
Max. IR Distance	150 m (500 ft)	
Video		
Video Compression	H.265, H.264, MJPEG	
Video Streaming	Quad streams from H.265, H.264 or MJPEG	
Video Resolution	Main Stream	2592 x 1944 (Default), 2560 x 1440, 1920 x 1080, 1280 x 1024, 1280 x 720, 800 x 600
	Sub Stream	1280 x 720, 1024 x 768, 800 x 600, 720 x 480, 640 x 480 (Default), 352 x 240, 320 x 240
	Third Stream (Closed by Default)	1280 x 720, 1024 x 768, 800 x 600, 720 x 480, 640 x 480, 352 x 240, 320 x 240
	Quad Stream (Closed by Default)	1280 x 720, 1024 x 768, 800 x 600, 720 x 480, 640 x 480, 352 x 240, 320 x 240
Frame Rate	30 fps at 2592 x 1944 (60/50 Hz) *The frame rate and performance may vary depending on the number of connections and data bitrates (different scenes).	

Image Setting	Brightness, Contrast, Saturation, Sharpness, Flicker-less, Image Orientation (Flip, Mirror, 0°, 90°, 180°, 270°-including Corridor format)	
<b>Audio</b>		
Audio Compression	G.711	
Audio Support	Two-way Audio (external microphone and speaker required)	
<b>Network</b>		
Interface	10/100 Ethernet	
Protocol	ARP, PPPoE, IPv4/v6, ICMP, IGMP, QoS, TCP, UDP, DHCP, UpnP, SNMP, SMTP, RTP, RTSP, HTTP, HTTPS, FTP, NTP, DDNS, ONVIF (Profile G, S, T)	
Security Feature	<ul style="list-style-type: none"> <li>- No default password</li> <li>- 802.1x authentication</li> <li>- HTTPS with SSL certificate stored within the camera</li> </ul>	
<b>Mechanical</b>		
Connectors	Power	Terminal Block (AC 24V), High PoE (PoE++, 60W)
	Ethernet	10/100 Base-T, RJ-45 connector
	Audio	1 in (Audio In Terminal Block); 1 out (Audio Out Terminal Block) *The Audio In port only supports microphones with power supply.
	Local Storage	SD card slot (SDHC / SDXC, Class 10)
	TV-Out	BNC connector: NTSC (720 x 480 at 30 fps), PAL (720 x 576 at 25 fps)
	Digital I/O	I/O Terminal Block
<b>Operation</b>		
Pan Travel	360° endless	
Tilt Travel	-20° ~ 100°	
Manual Speed	Pan	0.1° ~ 90°/s
	Tilt	0.1° ~ 55°/s
Preset Speed	Pan	280°/s
	Tilt	280°/s
Presets	Max. Number	256
	Accuracy	0.1°
Sequence	Max. Number	8
	Max. Presets Allowed	64
Auto Pan	4	
Automatic Function	Preset, Sequence, Auto Pan, Cruise	
Mechanical Flip	Yes	
Digital Slow Shutter	On / Off	
Motion Detection	On / Off	
Wide Dynamic Range	On / Off	
Day/Night: Mechanical IR Cut Filter	On / Off	
Alarm	Digital I/O	4 Inputs, dry contact, NO / NC
		2 Relay Outputs (120mA 400V DC / 120mA 250V AC)
<b>General</b>		
Operating Temperature	-40°C ~ 50°C (-40°F ~ 122°F)	
Humidity	10% ~ 90% (non-condensing)	
Dimensions	Ø 207 x 300 mm (8.15" x 11.81")	
Weight	3.8 kg (8.38 lb)	
Power Source	30V DC / 24V AC / High PoE (PoE++, 60W)	
Power Consumption	AC24V, 44W Max. DC30V, 43.87W Max.	
Ingress Protection	IP66	
Vandal Resistance	IK10 for housing	
Regulatory	CE, FCC, RoHS compliant	
<b>Power over Ethernet</b>		
PoE Standard	PoE++ (60W) / PD	
PoE Power Supply Type	Mid-span	
PoE Power Output	55V DC, 1.1A (60W Max.)	
<b>Web Interface</b>		
Installation Management	Web-based configuration	
Maintenance	Firmware upgrade through Web Browser or Utility	

Language	Czech, English, French, German, Hungarian, Italian, Japanese, Portuguese, Russian, Spanish, Traditional Chinese, Simplified Chinese
<b>Applications</b>	
Software Supported	GV-VMS (V17.3.0 / V18.1.1), GV-DVR / NVR (V8.8), GV-Control Center (V3.7.0), GV-Recording Server / Video Gateway (V1.4.2), GV-Edge Recording Manager Win version (V1.4.0), GV-Redundant / Failover Server (V1.1.0.0) *It is required to apply patch files to all the supported software.
Smart Device Access	GV-Eye for iOS and Android
Live Viewing	Internet Explorer, Non-IE browser (Edge, Chrome, Firefox, Safari), Mobile App *The non-IE browsers only support displaying live view with MJPEG.

**Note:**

- Do not use clothes or any ordinary material to clean the camera cover since they may result in scratches.
- Mind the following when using an inserted memory card for recording:
  - Recorded data on the memory card can be damaged or lost if the data are accessed while the camera is under physical shock, power interruption, memory card detachment or when the memory card reaches the end of its lifespan. No guarantee is provided for such causes.
  - The stored data can be lost if the memory card is not accessed for a long period of time. Back up your data periodically if you seldom access the memory card.
  - Memory cards are expendable and their durability varies according to the conditions of the installed site and how they are used. Back up your data regularly and replace the memory card annually.
  - To avoid power outage, it is highly suggested to apply a battery backup (UPS).
  - For better performance, it is highly suggested to use SD card of MLC NAND flash, Class 10.
  - Replace the memory card when its read/write speed is lower than 6 MB/s or when the memory card is frequently undetected by the camera.
- Specifications are subject to change without notice.







**Packing List**

- |  |  |
|--|--|
| 1. GV-QSD5731-IR                       | 5. 14-Pin Alarm/Audio I/O Terminal Block |
| 2. M4 Screw with Rubber                | 6. Download Guide                        |
| 3. 3-Pin Power Terminal Block (AC 24V) | 7. Warranty Card                         |
| 4. Pendant cap                         |  |

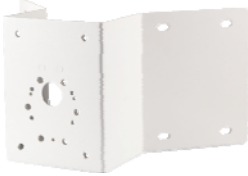
**Note:** GV-PA902BT Gigabit PoE Adapter and GV-Mount104-1 / 105-1 / 210-1 / 208-4 can be purchased upon request.

**Accessories**

Model No.	Name		Details
GV-Mount104-1	Straight Tube Kit		Dimensions: 219 x 125 x 332 mm (8.6" x 4.9" x 13.1") Weight: 1.8 kg (3.97 lb) <b>*non-waterproof</b>
GV-Mount105-1	Straight Tube and Junction Box Kit		Dimensions: 256 x 256 x 297 mm (10.1" x 10.1" x 11.7") Weight: 6.2 kg (13.67 lb)
GV-Mount210-1	Wall Pendant Mount		Dimensions: 200 x 140 x 249 mm (7.9" x 5.5" x 9.80") Weight: 1.1 kg (2.43 lb)

GV-Mount208-4	Swan Neck Mount		Dimensions: 1043 x 519 x 256 mm (41.06 x 20.43 x 10.08") Weight: 10.6 kg (23.37 lb)
GV-Mount300-1	Convex Corner Adapter Kit		Dimensions: 238.6 x 395.2 x 210 mm (9.4" x 15.5" x 8.2") Weight: 4.27 kg (9.41 lb)
GV-Mount310-1	Concave Corner Adapter Kit		Dimensions: 111.2 x 369.9 x 210 mm (4.37" x 14.5" x 8.2") Weight: 2.96 kg (6.53 lb)
GV-Mount400-1	Pole Mount Bracket Kit (Ø 4" ~ 6")		Bracket: 68.4 x 240 x 163 mm (2.69" x 9.44" x 6.41") Weight: 1.70 kg (3.75 lb) Steel Strap Diameter: Ø 4" ~ 6"
GV-Mount410-1	Pole Mount Bracket Kit (Ø 6" ~ 7.5")		Bracket: 68.4 x 240 x 163 mm (2.69" x 9.44" x 6.41") Weight: 1.70 kg (3.75 lb) Steel Strap Diameter: Ø 6" ~ 7.5"
GV-Mount501	Convex Corner Box Mount		Dimensions: 136 x 256 x 256 mm (5.4 x 10.1 x 10.1") Weight: 4.8 kg (10.6 lb)
GV-Mount702	Extension Tube		Dimensions: Ø 5.4 x 10 or 20 or 30 or 50 cm (Ø 2.1" x 3.9" or 7.9" or 11.8" or 19.7") Weight: 180 g or 390 g or 550 g or 800 g (0.4 lb or 0.86 lb or 1.21 lb or 1.76 lb)
GV-PA902BT	Gigabit PoE Adapter		Dimensions: 170 x 102 x 40 mm (6.69" x 2.02" x 1.57") Weight: 950g (2.09 lb)
Power Adapter	Contact our sales representatives for the countries and areas supported.		