

# PS400

Capable of extending 27.6 inches from the wall, the PS400 full motion TV mount offers unparalleled range of motion for screens as large as 70 inches. Extend your TV out of recessed areas or swivel it up to 180° to reach around corners and accommodate angled seating arrangements. A 14° tilt range also helps to reduce glare and further improve line-of-sight with your TV. Sitting 1.9 inches from the wall when fully retracted, the PS400's low-profile design incorporates plastic wall plate covers and integrated cable management to ensure a professional looking setup.

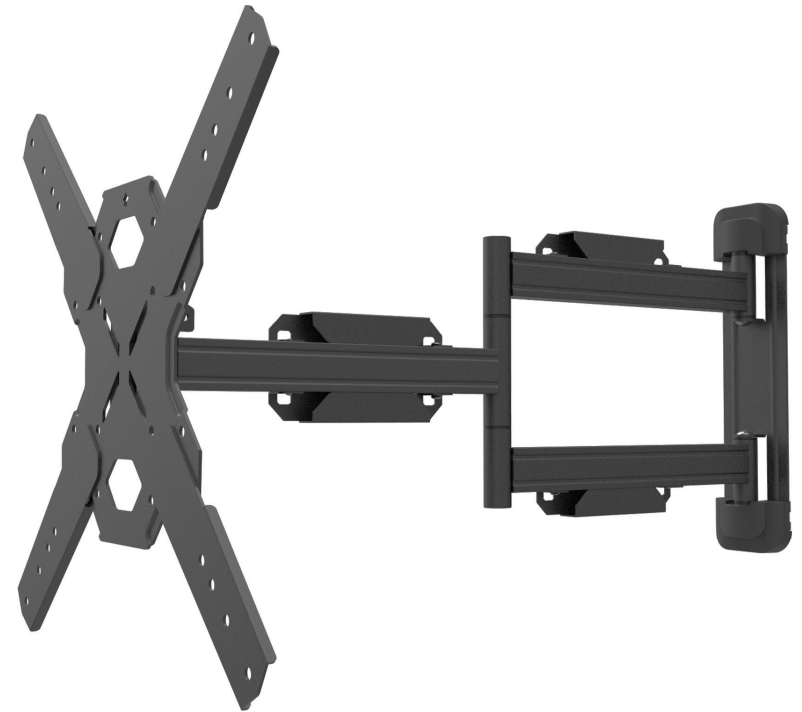

## FEATURES & SPECIFICATIONS

- Fits most flat panel TVs from 30" to 70"
- Supports TVs up to 88 lb (40 kg)
- Accommodates VESA sizes: 100x100, 100x150, 100x200, 150x100, 150x150, 200x100, 200x150, 200x200, 200x250, 200x300, 200x400, 300x200, 300x300, 400x200, 400x300, 400x400
- Accessible tilt mechanism provides 12° of forward tilt and 2° of backward tilt
- 90° of swivel in either direction, depending on screen size
- Sits 1.9" (4.7 cm) and extends up to 27.6" (70 cm) from the wall
- Integrated cable management, adjustable horizontal leveling
- Single stud wall plate, solid steel construction with durable powder coated finish
- Includes manual and all mounting hardware for wood stud and concrete installation
- Five year manufacturer's warranty
- Shipping box weight: 18.1 lb (8.2 kg)
- Shipping Box Dimensions: 20.3" x 15.9" x 2.8" (51.5 x 40.3 x 7 cm)
- Product Weight: 16.1 lb (7.3 kg)
- UPC: 800152718781

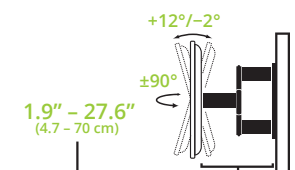
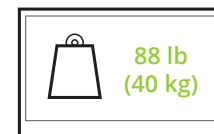
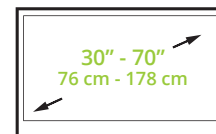

## TECHNICAL ILLUSTRATIONS

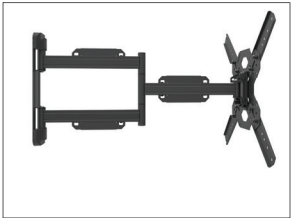

### IMPROVED VIEWING

Extending 27.6" from the wall, the articulating arm gives you the freedom to pan, swivel and tilt your TV exactly where you want it.

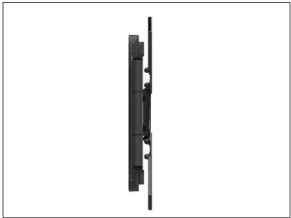

### LOW-PROFILE DESIGN

Achieve an exceptionally low-profile setup by pushing your TV back to sit 1.9" from the wall.

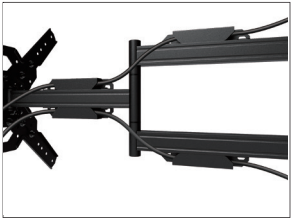

### CLEAN SETUP

Cable management clips are provided to conveniently route your cables, while plastic wall plate covers hide any sign of installation.

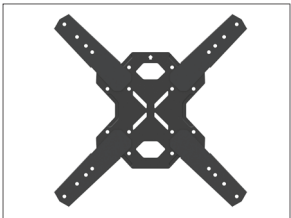

### VESA COMPATIBLE

Along with four extension arms for larger TVs, the PS400 ensures compatibility with a wide range of VESA sizes.



### EVERYTHING YOU NEED

Because every installation is unique, a carefully packaged bolt box is provided, containing all the lag bolts, anchors, washers and spacers you'll need for wood stud and concrete installations.

