

**BLACK BOX**

# Emerald<sup>®</sup> Unified KVM

High-Performance KVM Solutions



The award-winning Emerald® Unified KVM extension and matrix switching platform, developed and manufactured by Black Box®, ushers in a new era in KVM technology – eliminating sacrificed performance, compromised solutions and fractured networks. Emerald can be operated as a point-to-point extension or an IP-based KVM matrix switching system that supports pixel-perfect HD and 4K video signals, high-speed USB 2.0 and bidirectional analog audio. And it provides access to both physical and virtual machines via RDP/RemoteFX or PCoIP. With Emerald, you are ready for the future – no matter what form it takes.



Command and Control Rooms



Broadcast and Post-Production



Medical



Air Traffic Control and ATM



Public Safety



Industrial

### Ideal for a Wide Range of Industries

Emerald's flexibility and scalability make it ideal for various industries, including 24/7 command and control rooms, medical imaging and process monitoring environments.





# Benefits of Emerald

## Point-to-Point Extension or Matrix Switching

Start small with a simple point-to-point extension and grow your system to a high-performance KVM matrix. Combine HD and 4K transmitter and receiver units, connect them to an IP switch and add the Boxilla® KVM Manager to your system as it grows beyond 32 end points.

## Pixel-Perfect 4K 60 Hz Video over IP

Extend and switch pixel-perfect HD (DVI) or 4K (DisplayPort 1.2) video, high-speed USB 2.0, and bidirectional analog audio. Choose from five video compression settings to balance video quality and bandwidth consumption.

## Virtual Machine Access

Provide BIOS-level, high-speed KVM access to virtual machines from all Emerald receiver models. Supports VMware® and Microsoft® using RDP/RemoteFX or PCoIP. Requires no additional hardware.

## Flexible, Redundant Network Connectivity

Emerald® PE and 4K extenders provide redundant network ports that enable signal transmission over CATx, fiber, an IP network or even the internet. Redundant network ports allow for fast, automated switchover in case one connection is lost.

## Award-Winning KVM Management

Centrally manage your complete KVM network through the user-friendly, web-based KVM management platform Boxilla. Monitor bandwidth consumption, control user access and receive automated system alerts - all from your preferred web browser.

## Remote App and ZeroU Transmitters

The Emerald Remote App turns any Windows® 10 device into a software KVM receiver, allowing users to monitor devices remotely and without additional hardware. Or use the USB-powered ZeroU Transmitters to save valuable rack space.

## Rich Set of APIs for Advanced Control

Use ControlBridge®, Lawo VSM, or any third-party control system to switch between sources or to select application presets. This allows simple and flexible operation even within complex control room settings and full management of the Emerald system.

## Reliable System Components

Emerald works with a variety of additional components that can enhance your KVM system, such as 1-, 10-, or 100-Gbps IP switches, SFP(+) modules, a switchable USB 2.0 extender, mounting kits, interface adapters and a central power supply for transmitter units.

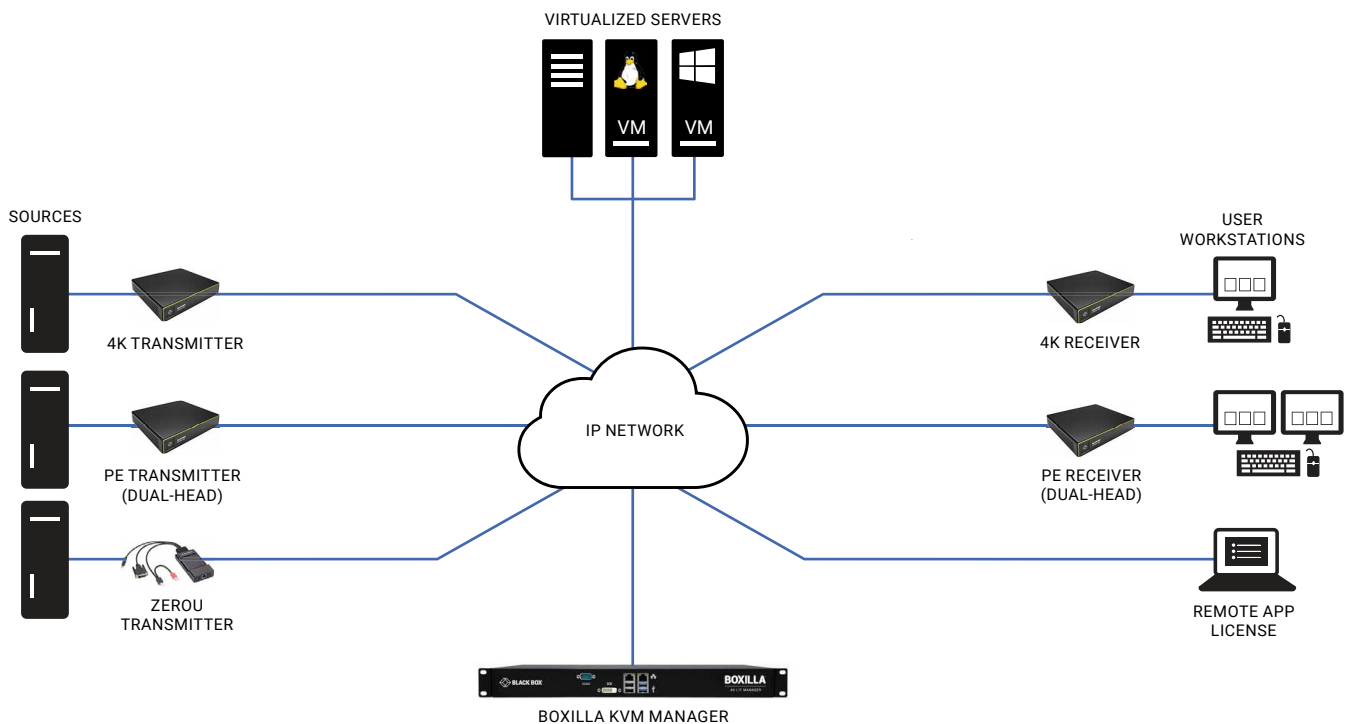

Emerald matrix switching setup that connects multiple source PCs, virtual machines, and user workstations

# Emerald System Highlights

## High-Quality Video with Low-Bandwidth Consumption

Emerald® receivers and transmitters deliver up to pixel-perfect 4K 60 Hz video resolutions. The management GUI lets you choose from five video compression settings, including highly compressed (ca. 35 Mbps, 1080p at 60 fps) and pixel perfect (450 Mbps, 1080p at 60 fps). For pixel-perfect 4K at 60 Hz 4:4:4 video transmission, a 10-Gbps connection is required.

## Virtual Machine Connectivity

With Emerald, VM connectivity is brought to a whole new level. Access VMware® and Microsoft® VMs over RDP 8.1/Remote FX or PCoIP in real time and provide a high-quality user experience across any given distance. By adding the VMs to a matrix setup, multiple users can switch seamlessly between various physical and virtual desktops without being able to tell the difference. Connecting VMs to the Emerald IP Switch eliminates the need for additional transmitter units.

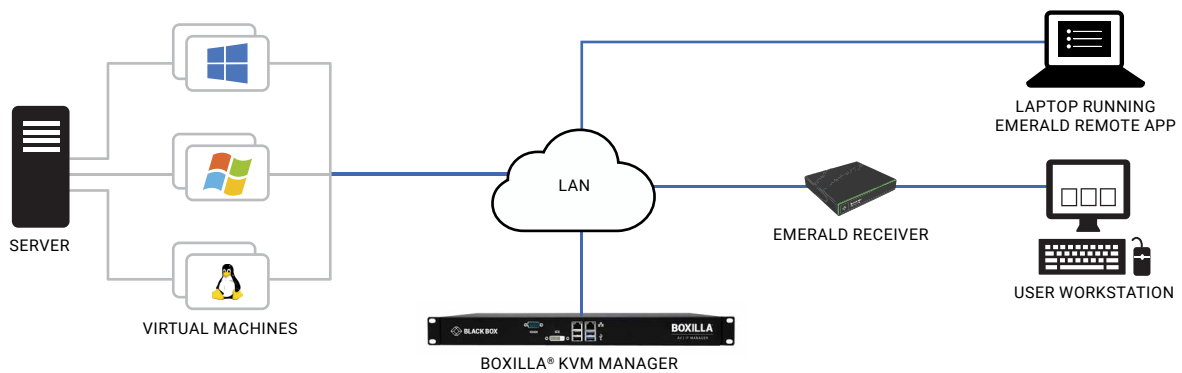

Virtual machines connected in an Emerald KVM Matrix

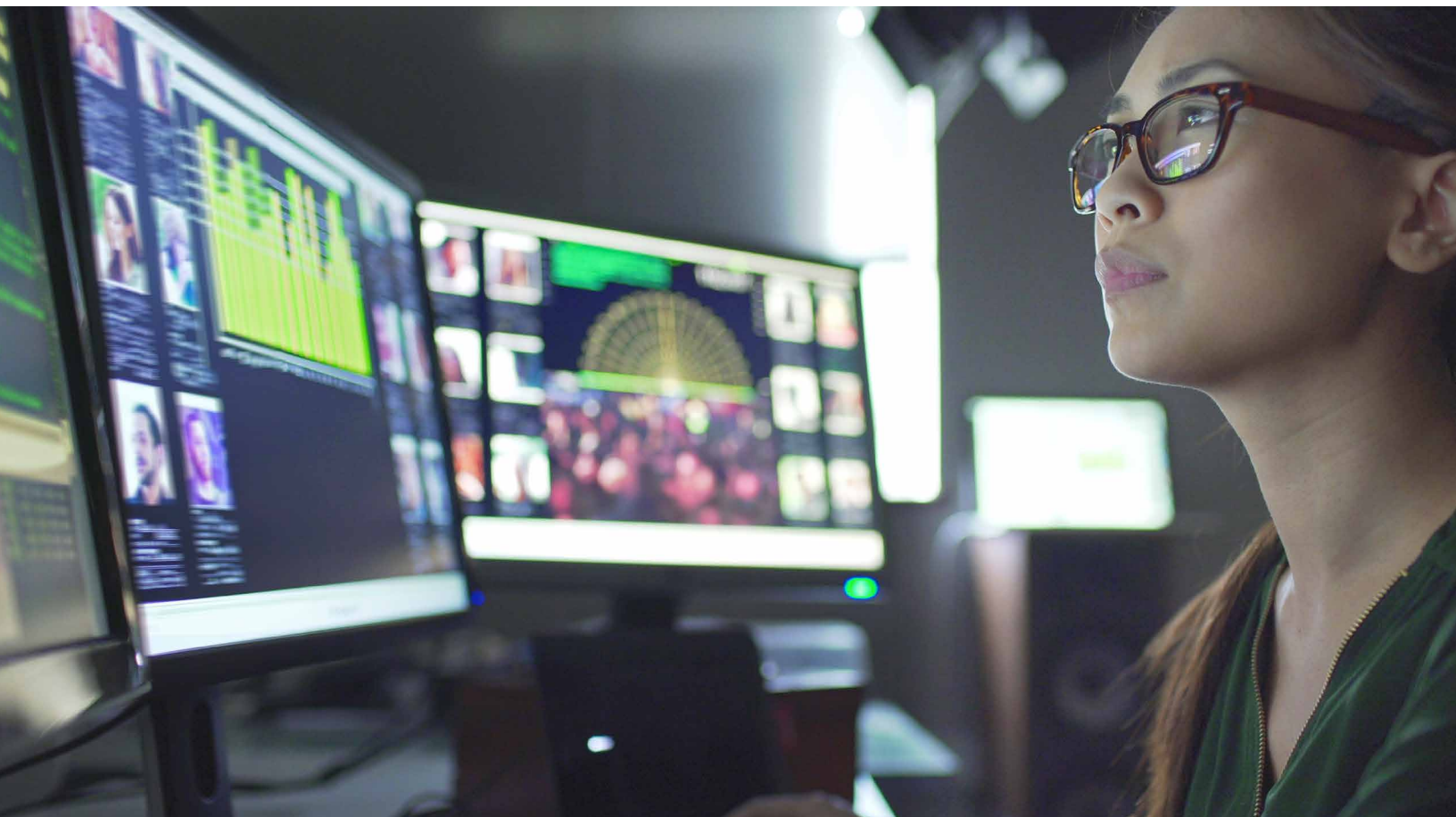



## Resilience and Network Management

For fail-safe operation and maximum uptime, Emerald® provides network resiliency at every level — all the way up to complete switch over from one control room to a backup control room location. If your system requires more ports, simply add or cascade IP switches.

- Redundant network connectors (Emerald PE and 4K) feature instant switchover in case one network connection fails.
- Use the central power supply to keep your devices' power status monitored and provide a redundant power supply.
- Emerald PE Extenders available that support Power over Ethernet (PoE) for additional power redundancy at the extender level.
- Never miss a critical event or run out of bandwidth with Boxilla's extended KVM status dashboard and automated alerts.

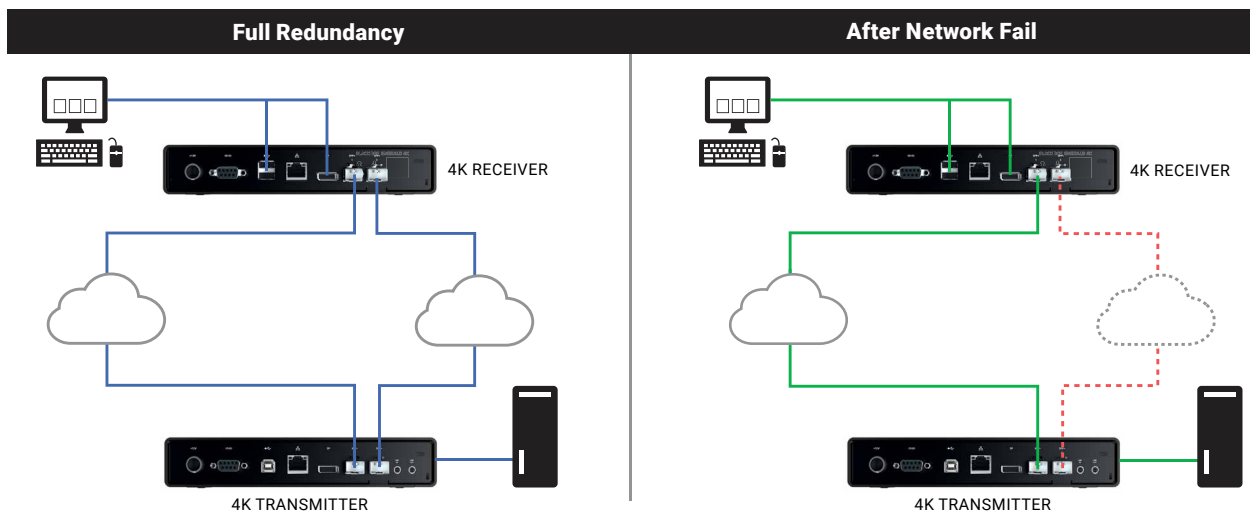

Redundant network paths provide fail-safe operation

# Emerald Unified KVM Product Family

## Emerald 4K

Emerald® 4K transmitters and receivers connect users and computers through a point-to-point connection or an IP-based KVM matrix switching network. The 4K KVM units support various video resolutions up to 4K, high-speed USB 2.0 devices and bidirectional analog stereo audio through redundant SFP+ ports. Emerald enables remote, BIOS-level computer access to both physical and virtual machines.

- Switch and extend up to pixel-perfect 4K video (lossless compression, 10-bit color ready); bidirectional analog audio; and up to four USB devices (HID and/or high-speed, transparent USB 2.0), such as keyboards, mice, Wacom® tablets, touch interfaces and flash drives.
- Connect Emerald 4K Receiver units with any other type of Emerald Transmitter unit (PE, SE, and ZeroU) as well as virtual machines in a single system.
- EDID pass-through feature supports a wide range of resolutions, ensuring video signals display correctly at all times.
- Build a KVM matrix that supports up to 32 end points through the built-in management interface, or use the Boxilla® KVM Manager to create even larger matrices.
- Transmit KVM signals over IP and securely access critical devices over a WAN or the internet.
- Real-time virtual machine access via RDP 8.1/RemoteFX or PCoIP.
- OS-agnostic technology allows you to connect any system, including Windows®, Mac OS® or Linux.
- Connect via dual network ports for fail-safe operation.
- Active Directory support.
- Supports extension distances of up to 100 meters (CATx), 300 meters (multimode fiber) or 10 kilometers (single-mode fiber).
- Combine with Switchable USB Extenders (#EMD100USB) to extend and switch USB 2.0 signals up to 480 Mbps.
- Also available as a TX/RX kit that includes SFP+ modules: #EMD4000-KIT.

### Emerald 4K Transmitter (EMD4000T)

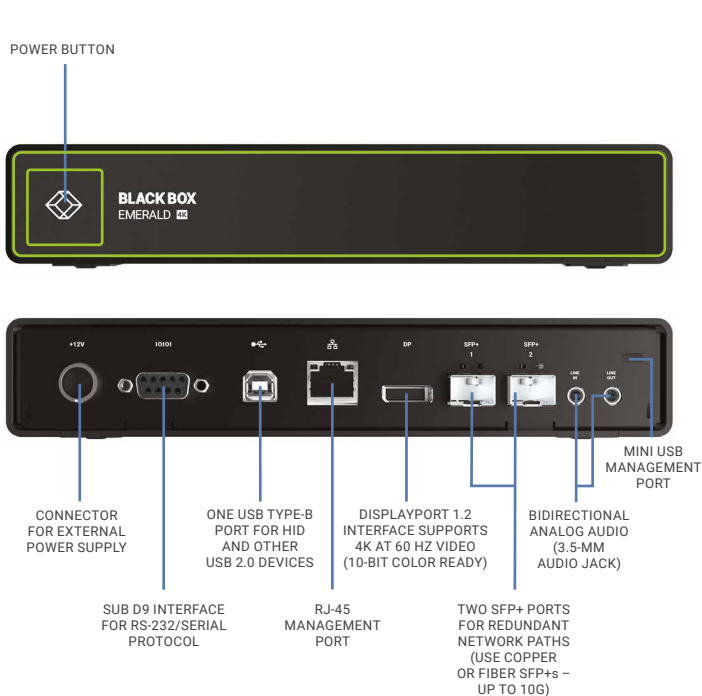

### Emerald 4K Receiver (EMD4000R)

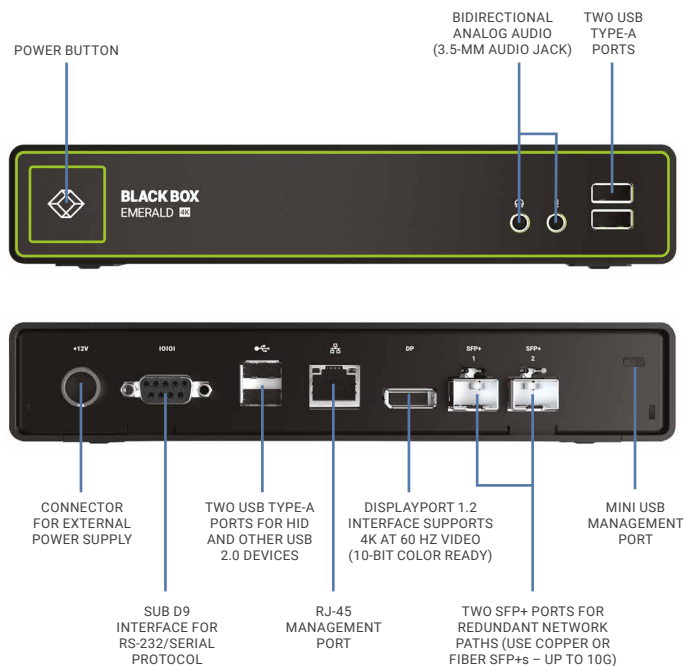

### Emerald 4K Technical Specifications and Interfaces

| Product Code | Video Heads          | Max Resolution       | USB Ports          | Network Ports       | Serial/Analog Audio            | Power Connectors |
|--------------|----------------------|----------------------|--------------------|---------------------|--------------------------------|------------------|
| EMD4000T     | (1) DisplayPort 1.2, | 4096 X 2160 at 60 Hz | (1) USB 2.0 Type B | (1) RJ-45, (2) SFP+ | (1) DB9, (2) 3.5-mm audio jack | (1) 12-VDC, 3A   |
| EMD4000R     | (1) DisplayPort 1.2, | 4096 X 2160 at 60 Hz | (4) USB 2.0 Type A | (1) RJ-45, (2) SFP+ | (1) DB9, (2) 3.5-mm audio jack | (1) 12-VDC, 3A   |



## Emerald PE

Emerald® PE transmitters and receivers are ideal extenders for customers seeking superior KVM performance, system redundancy, and crystal-clear HD video. Extend and switch pixel-perfect DVI video up to 1920 x 1200 at 60 Hz, high-speed USB 2.0 devices and bidirectional analog stereo audio through redundant network ports. With a similar feature set as Emerald 4K units, these extenders are ideal for critical 24/7 applications including process monitoring, broadcast production, and medical imaging. Emerald PE is available as single-head or dual-head version.

- Switch and extend up to pixel-perfect HD video (lossless compression), bidirectional analog audio, and up to four USB devices.
- Optional Power over Ethernet (PoE) support; reduces the number of power connections required and can be used to support full power redundancy for extender units.
- Connect Emerald PE Transmitter units with any other type of Emerald Receiver unit (4K and SE) as well as virtual machines in a single system.
- EDID pass-through feature supports a wide range of resolutions, ensuring video signals display correctly at all times.
- Choose from five video compression settings to balance video quality and bandwidth consumption.
- Transmit KVM signals over IP and securely access critical devices over a WAN or the internet.
- Real-time virtual machine access via RDP 8.1/RemoteFX.
- Connect via dual network ports – (1) RJ-45 and (1) SFP – for fail-safe operation.
- Extend KVM signals 100 meters over CATx, 300 meters over multimode fiber, or 10 kilometers over single-mode fiber.

### Emerald PE Transmitter (EMD2000PE-T)

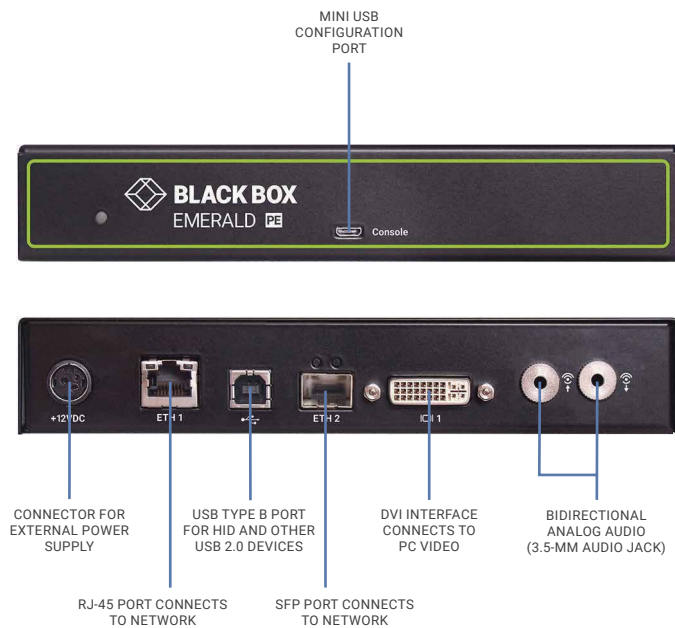

### Emerald PE Receiver (EMD2000-PE-R-P)

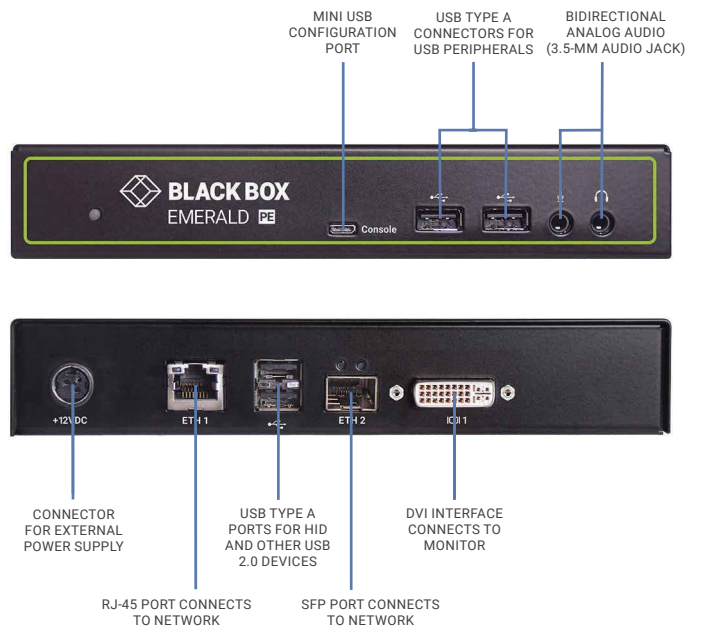

## Emerald PE Technical Specifications and Interfaces

| Product Code  | Video Heads | PoE Support | Max Resolution       | USB Ports          | Network Ports      | Serial/Analog Audio            | Power Connectors |
|---------------|-------------|-------------|----------------------|--------------------|--------------------|--------------------------------|------------------|
| EMD2000PE-T   | (1) DVI     | ✓           | 1920 X 1200 at 60 Hz | (1) USB 2.0 Type B | (1) RJ-45, (1) SFP | (1) DB9, (2) 3.5-mm audio jack | (1) 12-VDC, 3A   |
| EMD2000PE-R-P | (1) DVI     | ✓           | 1920 X 1200 at 60 Hz | (4) USB 2.0 Type A | (1) RJ-45, (1) SFP | (1) DB9, (2) 3.5-mm audio jack | (1) 12-VDC, 3A   |
| EMD2002PE-T   | (2) DVI     | ✓           | 1920 X 1200 at 60 Hz | (1) USB 2.0 Type B | (1) RJ-45, (1) SFP | (1) DB9, (2) 3.5-mm audio jack | (1) 12-VDC, 3A   |
| EMD2002PE-R-P | (2) DVI     | ✓           | 1920 X 1200 at 60 Hz | (4) USB 2.0 Type A | (1) RJ-45, (1) SFP | (1) DB9, (2) 3.5-mm audio jack | (1) 12-VDC, 3A   |

## Emerald SE

Emerald® SE transmitters and receivers are your entry into the world of Unified KVM. Extend and switch DVI video up to HD resolutions, USB 2.0 devices and bidirectional analog stereo audio. Pair transmitter and receiver units to create a P2P connection or build an IP-based KVM matrix switching setup. Take advantage of the USB-powered ZeroU Transmitter that saves valuable rack space. Or add licenses for the Emerald Remote App to connect an Emerald SE transmitter directly to any Windows® 10 device – without the need for an additional hardware receiver unit. Emerald SE is available as single-head or dual-head version.

- Switch and extend up to visually lossless HD video and up to four USB devices (HID and/or high-speed, transparent USB 2.0).
- Connect Emerald SE Transmitter units with any other type of Emerald Receiver unit (4K and PE) as well as virtual machines in a single system.
- Choose from five video compression settings to balance video quality and bandwidth consumption.
- EDID pass-through feature ensures video signals display correctly at all times.
- Build a KVM matrix that supports up to 32 end points through the built-in management interface, or use the Boxilla® KVM Manager to create even larger matrices.
- Transmit signals over IP and securely access critical devices over a WAN or the internet at very low bandwidth consumption.
- OS-agnostic technology allows you to connect any system, including Windows®, Mac OS® or Linux.
- Real-time virtual machine access via RDP 8.1/RemoteFX.
- Supports Active Directory (Boxilla required).
- Supports point-to-point extension distances of up to 100 meters (CATx).
- Remote App KVM Receiver licenses for one, five, 10 or 20 connections available (Boxilla required).
- USB-powered ZeroU Transmitter unit available that saves rack space.
- Combine with Switchable USB Extenders (#EMD100USB) to extend and switch USB 2.0 signals up to 480 Mbps.

### Emerald SE Transmitter (EMD2000SE-T)

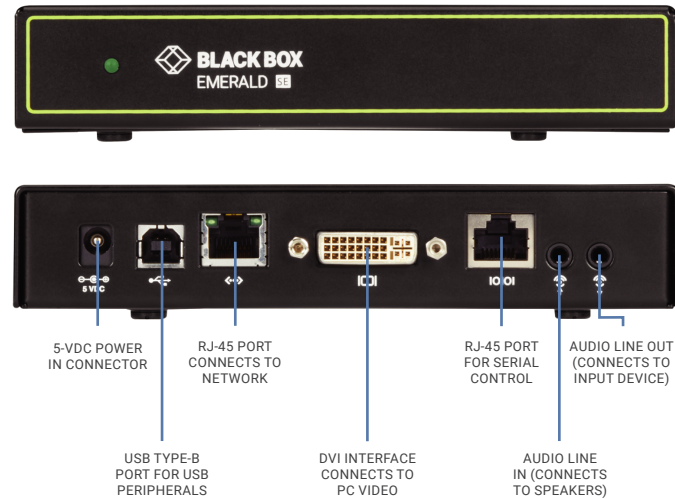

### Emerald SE Receiver (EMD2000SE-R)

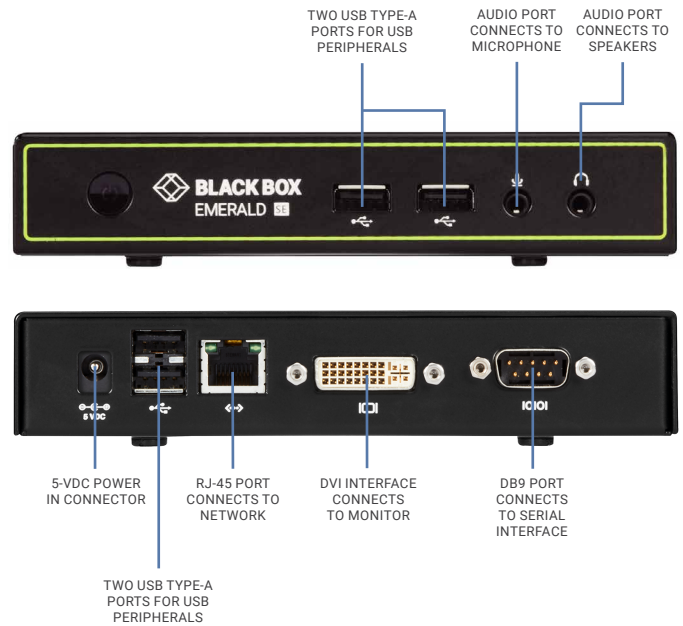

## Emerald SE Technical Specifications and Interfaces

| Product Code | Video Heads | Max Resolution       | USB Ports          | Network Ports | Serial/Analog Audio                      | Power Connectors |
|--------------|-------------|----------------------|--------------------|---------------|--|------------------|
| EMD2000SE-T  | (1) DVI     | 1920 X 1200 at 60 Hz | (1) USB 2.0 Type B | (1) RJ-45     | (1) RJ-45 serial, (2) 3.5-mm audio jacks | (1) 5-VDC, 4A    |
| EMD2000SE-R  | (1) DVI     | 1920 X 1200 at 60 Hz | (4) USB 2.0 Type A | (1) RJ-45     | (1) DB9 serial, (2) 3.5-mm audio jacks   | (1) 5-VDC, 4A    |
| EMD2002SE-T  | (2) DVI     | 1920 X 1200 at 60 Hz | (1) USB 2.0 Type B | (1) RJ-45     | (2) 3.5-mm audio jacks                   | (1) 5-VDC, 4A    |
| EMD2000SE-R  | (2) DVI     | 1920 X 1200 at 60 Hz | (4) USB 2.0 Type A | (1) RJ-45     | (2) 3.5-mm audio jacks                   | (1) 5-VDC, 4A    |



## Emerald ZeroU

The small form factor Emerald® ZeroU DVI or DisplayPort Transmitters consume zero rack space, enabling you to add more critical IT equipment to your data center. These transmitters work with all Emerald receivers to provide a seamless desktop experience anywhere on a TCP/IP network while allowing the actual hardware to be securely housed in a corporate data center. They support visually lossless full HD 1080p video, audio and USB for HID devices. The DisplayPort model supports embedded DisplayPort audio.

- Small form factor transmitters that are barely bigger than today's average cell phone.
- Connect Emerald ZeroU Transmitters with any type of Emerald Receiver unit (4K, PE, and SE) in a single system.
- Support HD DVI or DisplayPort video up to 1920 x 1200 at 60 Hz.
- Power over USB eliminates the need for extra cables.

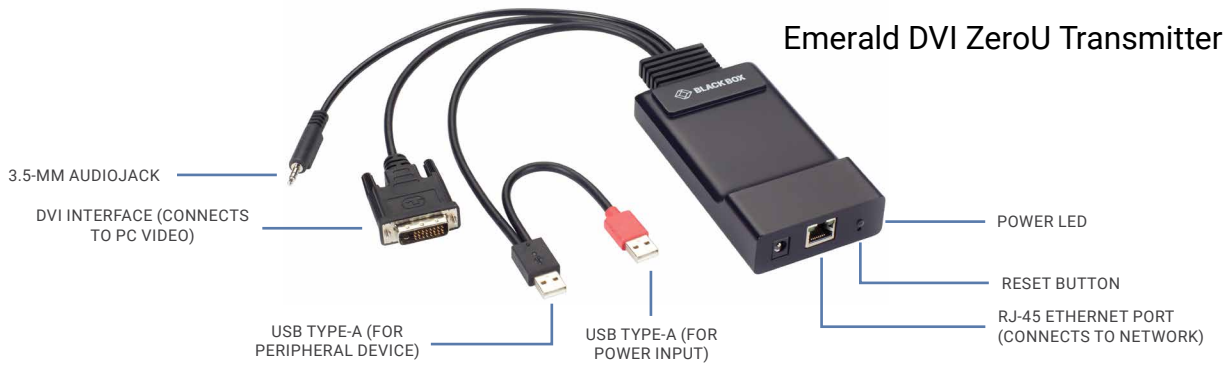

## Emerald ZeroU Transmitters

| Product Code | Video Heads     | Max Resolution       | USB Ports                               | Network Ports | Audio                      | Power Connectors |
|--------------|-----------------|----------------------|---|---------------|----------------------------|------------------|
| EMD200DV-T   | (1) DVI         | 1920 X 1200 at 60 Hz | (1) USB HID and (1) USB for power input | (1) RJ-45     | (1) 3.5-mm audio jack      | (1) 5-VDC, 4A    |
| EMD200DP-T   | (1) DisplayPort | 1920 X 1200 at 60 Hz | (1) USB HID and (1) USB for power input | (1) RJ-45     | Embedded DisplayPort audio | (1) 5-VDC, 4A    |

## Emerald Remote App

The Emerald® Remote App is a license-enabled KVM application that allows remote computer access through Emerald PE and Emerald SE transmitters and the use of virtual machines from any Windows® 10 device in full HD resolution. Through the Remote App, multiple connections can be launched simultaneously, which makes remote monitoring of connected devices even more flexible. Simply add a license for one, five, 10 or 20 connections to your Boxilla® KVM Manager.

- Secure software KVM connection from Windows® 10-based PCs or laptops.
- Supports video resolutions up to 1920 X 1200 and USB HID.
- Open multiple connections simultaneously to manage and view multiple sources.
- Access KVM resources over VPN.
- Connect to Emerald PE, SE, and ZeroU Transmitter units as well as virtual machines.
- OS-agnostic technology allows you to connect any system, including Windows®, Mac OS® or Linux.
- Requires Boxilla KVM Manager for license management.

Download the Remote App for free at [blackbox.com/emerald](http://blackbox.com/emerald).

| Product Code  | Description   |
|---------------|---|
| EMDRM1-LIC    | Emerald Remote App – license for one connection               |
| EMDRM5-LIC    | Emerald Remote App – license for five connections             |
| EMDRM10-LIC   | Emerald Remote App – license for 10 connections               |
| EMDRM20-LIC   | Emerald Remote App – license for 20 connections               |
| EMDRMDEMO-LIC | Emerald Remote App – 30-day demo license for four connections |

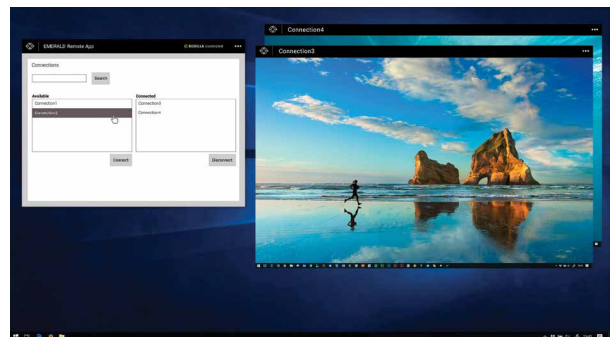

The Remote App runs multiple KVM connections simultaneously

## Boxilla KVM Manager

Boxilla® is a centralized KVM management appliance that enables remote management and monitoring of your complete enterprise KVM network. When connected to an Emerald® KVM Matrix, Boxilla provides a user-friendly web-based GUI that allows users to auto-detect and connect new end points, update firmware, adjust bandwidth consumption, set up automated security alerts and much more. Boxilla comes with multiple license types to accommodate different KVM network sizes.

- Manage deployments and user access rights, monitor KVM status, upgrade firmware, facilitate troubleshooting and provide network security – all from one central command center dashboard.
- Auto device discovery and configuration and advanced user authentication.
- Supports Active Directory for user authentication and mapping to groups.
- Enables connections between multiple Black Box KVM systems, such as DKM and Emerald.
- Dual network ports allow management of Boxilla via a second network.
- Add redundant Boxilla devices to a KVM matrix for enhanced network security.
- Zoning of receivers and connections allows users to access target computers based on the location they login from.

Learn more at [blackbox.com/boxilla](https://blackbox.com/boxilla).

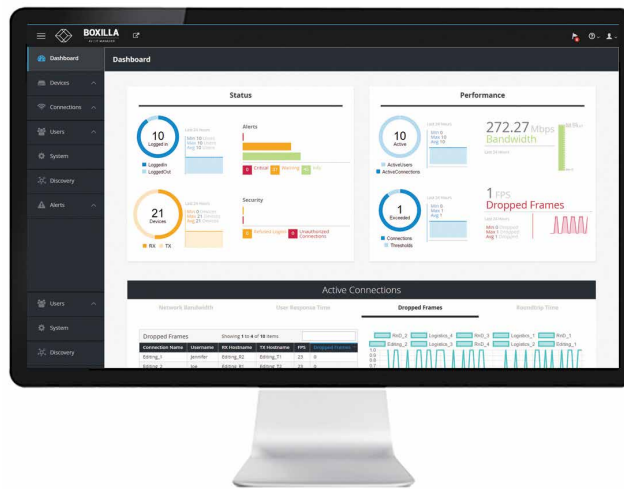

Boxilla's web browser-based user interface

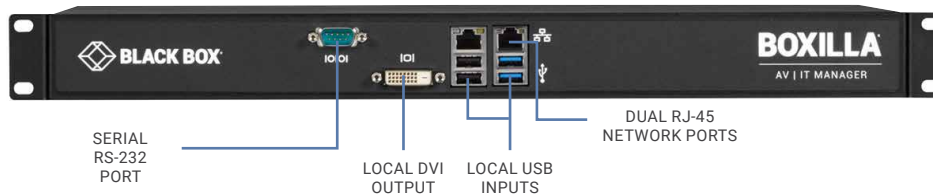

| Product Code                   | Description   |
|--------------------------------|---|
| BXAMGR                         | KVM management platform that supports 25 end points   |
| BXAMGR-X <sup>(1)</sup>        | KVM management platform that supports 75, 125, 225, 325, or unlimited end points                                  |
| BXAMGR-LIC-X <sup>(2)</sup>    | Licenses for 25, 100, 200, 300 or unlimited additional end points on top of what manager already supports         |
| BXAMGR-LICBAK-X <sup>(3)</sup> | Licenses for 25, 100, 200 or 300 additional active and standby end points on top of what manager already supports |

<sup>(1)</sup> X = 50, 100, 200, 300, ULT

<sup>(2)</sup> X = 25, 100, 200, 300, ULT

<sup>(3)</sup> X = 25, 100, 200, 300



# Emerald Comparison Chart

| Product Code                      | Emerald Remote App   | Emerald ZeroU TX   | Emerald SE                                   | Emerald PE   | Emerald 4K                             |
|-----------------------------------|--|--|--|--|--|
| Max Video Resolution              | 1920 x 1200 at 60 Hz   | 1920 x 1200 at 60 Hz (DVI or DisplayPort)                            | 1920 x 1200 at 60 Hz (DVI)                   | 1920 x 1200 at 60 Hz (DVI)   | 4096 x 2160 at 60 Hz (DisplayPort 1.2) |
| Video Quality                     | High quality ~35fps  | Visually lossless  | Visually lossless                            | Pixel perfect  | Pixel perfect                          |
| Dual-Head Version Available       | –  | –  | ✓  | ✓  | –                                      |
| Network Connectors                | –  | (1) RJ-45  | (1) RJ-45                                    | (1) RJ-45, (1) SFP   | (2) SFP+                               |
| USB Support                       | USB HID  | USB HID  | All USB 2.0 devices                          | All USB 2.0 devices  | All USB 2.0 devices                    |
| Max Extension Distance            | Unlimited over IP  | CATx: 100 meters (328 feet)<br>IP: unlimited                         | CATx: 100 meters (328 feet)<br>IP: unlimited | CATx: 100 meters (328 feet)<br>Fiber: up to 10 kilometers (6.2 miles)<br>IP: unlimited |  |
| VM Support                        | RDP/Remote FX, PCoIP   | –  | RDP/RemoteFX                                 | RDP/RemoteFX   | PCoIP, RDP/Remote FX                   |
| Bidirectional Analog Stereo Audio | –  | DVI: speaker only<br>DisplayPort: embedded digital DisplayPort audio | ✓  | ✓  | ✓                                      |
| PoE Support                       | –  | –  | –  | ✓  | –                                      |
| KVM Setup                         | Point-to-point KVM extension that is scalable to a matrix switching setup with unlimited endpoints |  |  |  |  |

## Emerald KVM – Designed and Built By Black Box®

Emerald® has been independently designed and developed by our expert team of engineers in Limerick, Ireland and Pittsburgh, Pennsylvania. The development team combines an impressive number of years of experience in designing new KVM technology. Emerald holds multiple KVM technology patents.

By constantly expanding our R&D Department, our team is well suited to develop new solutions, upgrades and features that provide you with the best KVM user experience on the market. Through our international and local sales and tech support teams, Black Box can provide you with on-site assessment, project planning, and tech support. To learn more, visit [blackbox.com/coe](http://blackbox.com/coe).





# Emerald Accessories

## Switchable High-Speed USB Extenders

This USB extender adds high-speed USB 2.0 support to your Emerald KVM system.

- Switch between high-speed USB 2.0 devices over an IP network.
- Supports full-speed USB 2.0 up to 480 Mbps.
- Supports simultaneous USB sharing that improves collaboration.
- Connect to an Emerald KVM system to automatically switch when target changes.
- Features four USB ports that support USB devices, including USB hubs

Learn more at [blackbox.com/EMD100USB](http://blackbox.com/EMD100USB).



Switchable High-Speed USB Extenders (EMD100USB)

| Product Code | Description             |
|--------------|-------------------------|
| EMD100USB    | Switchable USB Extender |

## Video Cables and Adapters

Use high-quality Black Box® cables and adapters to connect your Emerald KVM System with computers and user consoles. Choose from an extensive product portfolio that includes the following items:

Learn more at [blackbox.com/vca](http://blackbox.com/vca).



VGA to DVI-D Video Converter (KVGA-DVID)

| Product Code                      | Compatible Adapters and Cables                          |
|-----------------------------------|---|
| Video Cables                      |   |
| VCB-DP2 Series (various lengths)  | DisplayPort 1.2 (4K60)                                  |
| EVNDVI02 Series (various lengths) | DVI SL/DL Cable   |
| Video Adapters                    |   |
| KVGA-DVID                         | VGA to DVI-D Video Converter, USB Powered (1920 x 1200) |
| VA-MDP12-DP12                     | Mini DisplayPort-to-DisplayPort Adapter                 |
| VA-DP-DVID-A                      | DisplayPort to DVI (1920 x 1200)                        |
| VA-DP12-HDMI4K-A                  | DisplayPort to HDMI (1920 x 1080)                       |

## Emerald Mounting Kits

Use these 19-inch rackmount kits to mount Emerald® units on or below tables, behind screens or in racks. The 1U mounting kits are ideal for space-saving installations because they provide space for up to two extender units. Emerald was designed with optimal airflow in mind, so the units will not overheat when placed alongside other components in the rackmounting shelf.

Learn more at [blackbox.com/emk](http://blackbox.com/emk).



Emerald 4K Rackmount Kit, 2 units (EMD4000-RMK1)

| Product Code      | Description  |
|-------------------|--|
| EMD4000-RMK1      | Emerald 4K Rackmount Kit for 1 or 2 KVM units (1U) |
| EMD4000-RMK2-SLIM | Spare Rackmount Blanking Plate for EMD4000-RMK1    |
| EMD2000-RMK2      | Emerald PE Rackmount Kit for two KVM units (1U)    |
| DTX1000-RMK1      | Emerald SE Rackmount Kit for one KVM unit (1U)     |
| DTX1000-RMK2      | Emerald SE Rackmount Kit for two KVM units (1U)    |

## Central Power Hub

For improved power management and fail-safe operation, use the optional central power hub for 8 or 16 units.

- Central power feed to 5-volt or 12-volt DC devices with up to 30 watts per port.
- Web UI for configuration and monitoring of system power status.
- Highest resilience when equipped with second, hot-swappable 600-k hours power supply.

Learn more at [blackbox.com/cps](http://blackbox.com/cps).



Central Power Hub, 16 units (ACR1000-CPH16R-R2)

| Product Code       | Description  |
|--------------------|--|
| ACR1000-CPH16R-R2  | Central Power Hub, 16 Ports                                    |
| ACR1000-CPH8R-R2   | Central Power Hub, 8 Ports                                     |
| ACR1000-CPH-PS-R2  | Central Power Hub Redundant Power Supply                       |
| ACR1000-12V5-CBL3M | Central Power Hub Power Converter Cable - 12 VDC to 5 VDC, 3-m |

# Emerald Network Components

## Emerald IP Switches

Emerald® was designed with the needs of IT planners and integrators in mind. To build an Emerald KVM matrix, choose from a variety of Black Box®-tested 1-, 10-, and 100-Gbps switches. Or use your preferred third-party IP switches. Make sure to use managed IP switches that support IP multicast and IGMP at full-wire speed and ensure sufficient bandwidth for the required video quality, resolutions and USB devices.



10G 28-Port IP Switch (EMS10G28)

Learn more at [blackbox.com/ens](http://blackbox.com/ens).

| Product Code          | EMS1G48                             | EMS1G24F                          | EMS10G12                          | EMS10G28                            | EMS100G32-R2                           |
|-----------------------|-------------------------------------|-----------------------------------|-----------------------------------|-------------------------------------|--|
| Speed                 | 1 Gbps                              | 1 Gbps                            | 10 Gbps                           | 10 Gbps                             | 100 Gbps                               |
| Ports                 | (48) 10/100/1000BT RJ-45, 1.25 Gbps | (24) 1-GbE SFP                    | (12) 10-GbE SFP+                  | (28) 10-GbE SFP+                    | (32) 100-GbE SFP+ or (128) 10-GbE SFP+ |
| Cascade Ports         | (4) 10G SFP+                        | (2) 10-GbE SFP+                   | (3) 100G QSFP28                   | (2) 100G QSFP28                     | —                                      |
| Capacity              | 260 Gbps                            | 260 Gbps                          | 850 Gbps                          | 960 Gbps                            | 6.4 Tbps                               |
| Dimensions            | 4.4 (1 RU) x 43.4 x 32 cm (HxWxD)   | 4.4 (1 RU) X 43.4 X 41 cm (HxWxD) | 4.4 (1 RU) x 45 x 20.9 cm (HxWxD) | 4.4 (1 RU) x 43.1 x 45.7 cm (HxWxD) | 4.4 (1 RU) x 43.4 x 46 cm (HxWxD)      |
| Max Power Consumption | 87 W                                | 63 W                              | 180 W                             | 290 W                               | 605 W                                  |
| Power Input           | (2) 90–264 VAC, 50/60 Hz            | 100–240 VAC 50/60 Hz              | (2) 100–240 VAC, 50/60 Hz         | (2) 100–240 VAC, 50/60 Hz           | (2) 100–240 VAC, 50/60 Hz              |

## SFP Modules

Emerald 4K and PE Extenders as well as Emerald IP Switches provide a high level of flexibility by offering SFP (1-Gbps), SFP+ (10-Gbps) and QSFP28 (100-Gbps) ports (depends on the type of extender and system application). Use SFPs for HD signal transmissions. Use SFP+ or QSFP28 modules to transmit 4K 60 signals and aggregate multiple connections through a 100-Gbps IP switch. Emerald Extenders and Switches support connectivity through copper, fiber multimode or fiber single-mode cables using a variety of Black Box and third-party SFP modules.



SFP modules

Learn more at [blackbox.com/sfp](http://blackbox.com/sfp).

| Product Code                | Description                                   | Supported Distance |
|-----------------------------|---|--------------------|
| <b>1-Gbps Connections</b>   |   |                    |
| LFP441                      | SFP, 1250-Mbps, 850-nm Multimode Fiber, LC    | 1804 feet (550 m)  |
| LFP413                      | SFP, 1250-Mbps, 1310-nm Single-Mode Fiber, LC | 6.2 miles (10 km)  |
| LFP442                      | SFP, 1250-Mbps, 1310-nm Single-Mode Fiber, LC | 12.4 miles (20 km) |
| LFP415                      | SFP, 1000-Mbps, SGMII Interface, RJ-45        | 328 feet (100 m)   |
| LFP443                      | SFP, 1250-Mbps, SGMII Interface, RJ-45        | 328 feet (100 m)   |
| <b>10-Gbps Connections</b>  |   |                    |
| LSP441                      | SFP+ 10-Gbps, 850-nm Multimode Fiber, LC      | 984 feet (300 m)   |
| LSP442                      | SFP+ 10-Gbps, 1310-nm Single-Mode Fiber, LC   | 12.4 miles (20 km) |
| LSP443                      | SFP+ 10-Gbps, RJ-45                           | 98 feet (30m)      |
| <b>40-Gbps Connections</b>  |   |                    |
| QSFP541                     | QSFP+ 40-Gbps, 850-nm Multimode Fiber, MPO    | 492 feet (150 m)   |
| <b>100-Gbps Connections</b> |   |                    |
| QSFP441                     | QSFP28 100-Gbps, 850-nm Multimode Fiber, MPO  | 328 feet (100 m)   |
| QSFP442                     | QSFP28 100-Gbps, WDM Single-Mode Fiber, LC    | 6.2 miles (10 km)  |

Notes: (1) All Black Box SFP Modules feature Extended Diagnostics. (2) Black Box Switches also support generic SFP(+) modules.



# Emerald Network Components

## Active Optical and Direct Attach Cables

Black Box Active Optical Cables (AOCs) and Direct Attach Cables (DACs) provide an all-in-one, easy-to-install, and cost-effective solution for connecting Emerald 4K Extender units to a network switch or interconnecting switches through their SFP+ or QSFP network ports.

Learn more at [blackbox.com/sfpaoc](http://blackbox.com/sfpaoc).



SFP-10G-AOC2M-BB

| Product Code        | Description   |
|---------------------|---|
| AOC                 |   |
| SFP-10G-AOCxM-BB    | AOC, SFP+ 10-Gbps, various lengths (in meters); x = 1, 2, 3, 5, 7, or 10    |
| QSFP-100G-AOCxM-BB  | AOC, QSFP 100-Gbps, various lengths (in meters); x = 3, 5, 7, 10, 15, or 30 |
| DAC                 |   |
| SFP-H10GB-CUxxxx-BB | DAC, SFP+ 10-Gbps, various lengths; xxxx = 50CM, 1M5, 1M, 2M, 3M, or 5M     |

## Additional Products

### ControlBridge Control Processor and Touchscreen

ControlBridge® is a versatile control processor and touchscreen-based appliance for room automation and intuitive operations control. It allows you to control all aspects of your workspace or control room, including KVM switching, lighting, window shutters, automated furniture position and video walls.

- Multiple control processors and touchscreen devices (7" and 12") available.
- Bidirectional control of any IP-enabled or I/O device.
- Active matrix touchscreen display offers resolutions of 1280 x 800, 32-bit (true color) images and full-motion streaming video preview.
- Includes built-in microphone, speakers and light and motion sensors.
- Set up through a standard web browser.
- Mobile device support through optional app license.
- Black Box will help you to design a custom interface for your specific requirements.

Learn more at [blackbox.com/controlbridge](http://blackbox.com/controlbridge).



ControlBridge 12" touchscreen

| Product Code | Description  |
|--------------|--|
| CB-TOUCH7-T  | ControlBridge Touch Panel, 7"                            |
| CB-TOUCH12-T | ControlBridge Touch Panel, 12"                           |
| CB-CP100     | Control processor for small-sized applications           |
| CB-CP200     | Control processor for medium to large-sized applications |
| CB-APP-LIC   | ControlBridge Single-Seat Mobile Device License          |





## Freedom II KM Switches

Freedom KM Switches support the powerful Glide and Switch technology that allows operators to switch between up to eight computers by moving a mouse from one screen to another - without pressing hotkeys or additional buttons. Share a single keyboard and mouse, two USB 2.0 devices, and analog audio between all connected systems. Add the monitor identification kit to indicate the active system and monitor through screen-mounted LEDs.

Learn more at [blackbox.com/freedom](http://blackbox.com/freedom).

| Product Code | Description                            |
|--------------|--|
| KV0004A-R2   | Freedom II KM Switch, 4 Ports          |
| KV0008A-R2   | Freedom II KM Switch, 8 Ports          |
| KV0004A-LED  | Freedom LED Monitor Identification Kit |

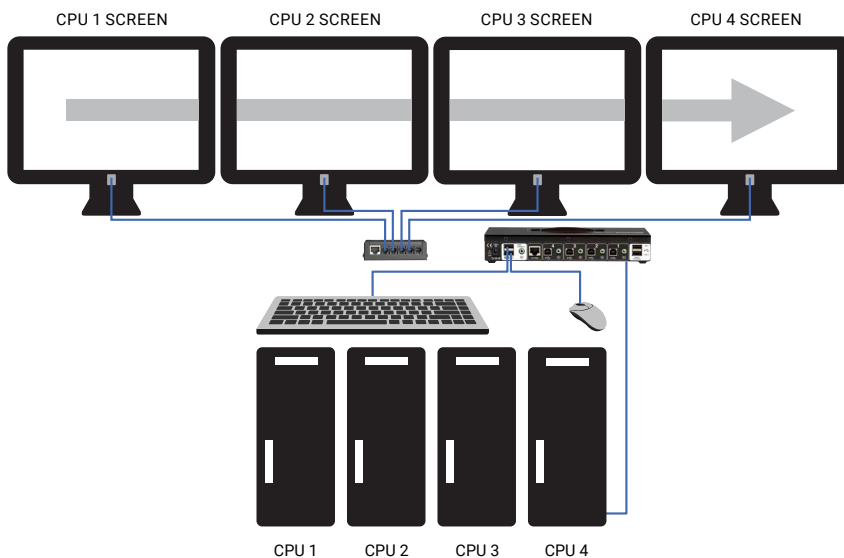

Freedom II Glide and Switch application

# WHY BLACK BOX

## **Expertise**

Black Box project engineers can assist with system assessment, design, deployment and training.

## **Breadth**

Black Box offers the most comprehensive suite of engineered KVM, AV and infrastructure solutions in the industry.

## **Support**

Reflecting our commitment to complete satisfaction, our dedicated team of highly trained support technicians is available by phone free of charge, every day of the year.

## **Service Level Agreements**

Our service level agreements give customers access to technical support, product training, dedicated application engineers and more.

## **Experience**

Providing leading technology solutions since 1976, Black Box helps more than 175,000 customers in 150 countries build, manage, optimize and secure IT infrastructures.

## **Warranties**

Multi-year warranties with multi-year extensions and replacement options are available.

## **Center of Excellence**

Black Box offers a Center of Excellence, featuring professional services and support agreements that help optimize customers' systems and maximize uptime.