

# Designer Contour<sup>®</sup> Manual with CSR

Spring Roller-Type Screen



SPECIFICATION DATA

**SUGGESTED SPECIFICATIONS:** \_\_\_\_\_ projection screen(s), \_\_\_\_\_(H) x \_\_\_\_\_(W), wall or ceiling mounting type. Screen case to be a two piece design made of extruded aluminum. Case to be finished in white, lightly textured powder coat. End caps made of high strength plastic concealing roller ends with integral bearing surface to support roller. To be equipped with Controlled Screen Return (CSR) to control the return speed of the screen into the case. Bottom of fabric shall be mounted securely into a powder coated tubular steel slat. Ends of slat shall be protected by plastic caps. A 3/6" pull cord with plastic knob is included. To have masking borders standard on flame retardant and mildew resistant fiberglass fabric. Fabric shall be mounted into a metal strip in a Camlok<sup>®</sup> roller system without tape, glue, staples, or cords so that fabric may be easily replaced yet cannot be pulled from roller.

## Video (NTSC 4:3) Format Dimensions

Viewing Area (H x W)		Nominal Diagonal		Overall Length of Case		Approx. Ship. Wt.	
In.	Cm	In.	Cm	In.	Cm	Lbs.	Kg
43" x 57"	109 x 145	72"	183	63"	160	25	11.3
50" x 67"	127 x 170	84"	213	73"	185	30	13.6
57" x 77"	145 x 196	96"	244	84"	213	33	15.0
60" x 80"	152 x 203	100"	254	87"	221	37	16.8
69" x 92"	175 x 234	120"	305	99"	251	38	17.2

## HDTV (16:9) Format Dimensions

Viewing Area (H x W)		Nominal Diagonal		Overall Length of Case		Approx. Ship. Wt.	
In.	Cm	In.	Cm	In.	Cm	Lbs.	Kg
37½" x 67"	95 x 170	77"	196	73"	185	30	13.6
45" x 80"	114 x 203	92"	234	87"	221	37	16.8
52" x 92"	132 x 234	106"	269	99"	251	38	17.2

## Square Format Dimensions

Sizes (H x W)		Overall Length of Case		Approx. Ship. Wt.	
In.	Cm	In.	Cm	Lbs.	Kg
60" x 60"	152 x 152	63"	160	25	11.3
70" x 70"	178 x 178	73"	185	30	13.5
84" x 84"	213 x 213	87"	221	37	16.8
6' x 8'	183 x 244	99"	251	38	17.2
8' x 8'	244 x 244	99"	251	39	17.7

**PRODUCT NOTES**

- All surfaces will be seamless in standard sizes.
- Overall case length dimensions +/- 1/4".
- Detail dimensional drawings and installation instructions available upon request.
- Specifications subject to change without notice.
- Custom formats and sizes available upon request.
- **Optional Accessories:** to provide clearance: Furnish 6" heavy extension wall brackets to mount screen. To provide for keystone elimination: Furnish #11 or #23 adjustable extension wall brackets. Furnish magnetic tilt lock for keystone elimination.
- **NOTE:** Brackets also are used for mounting screen across a corner.

**WHEN ORDERING, MARK APPROPRIATE SELECTIONS:**

1. Select size from charts on the other side.
2. Select viewing surface (All Da-Lite surfaces are GREENGUARD GOLD Certified):
 

<input type="checkbox"/> Matte White	<input type="checkbox"/> High Contrast Matte White
<input type="checkbox"/> High Power®	<input type="checkbox"/> Video Spectra 1.5
3. Optional accessories:
 

<input type="checkbox"/> No. 6 Wall Bracket - 6" non-adjustable extension brackets (75# per pair maximum) (black or white).	<input type="checkbox"/> No borders (Black masking borders standard).
<input type="checkbox"/> No. 11 Wall Bracket - 10" or 14" non-adjustable extension brackets (75# per pair maximum) (black or white).	<input type="checkbox"/> Veneer Case Cover (Choose from seven standard veneers):
<input type="checkbox"/> No. 23 Adjustable Wall Bracket - 10", 14", 15 3/4", 18 1/4", 20", or 24" adjustable extension brackets (75# per pair maximum) (black or white).	<input type="checkbox"/> Light Oak
<input type="checkbox"/> Tilt-Lock for Keystone Elimination (used with extension brackets).	<input type="checkbox"/> Medium Oak
<input type="checkbox"/> T-Bar Clip for drop ceilings (50# per pair maximum) (black or white).	<input type="checkbox"/> Natural Walnut
<input type="checkbox"/> Pull Rod - 38".	<input type="checkbox"/> Heritage Walnut
	<input type="checkbox"/> Mahogany
	<input type="checkbox"/> Cherry
	<input type="checkbox"/> Honey Maple
	<input type="checkbox"/> Graphite case color.
	<input type="checkbox"/> Black case (white standard).

**PRODUCT VIEWS**

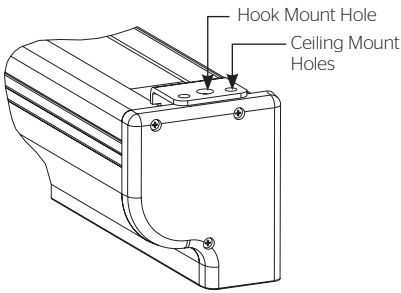
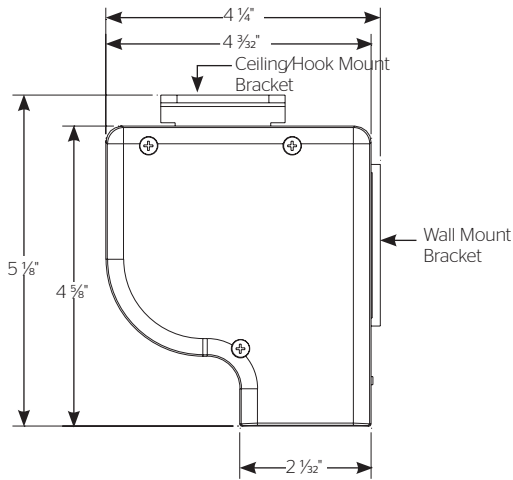

**ACCESSORIES**

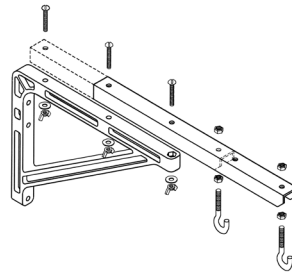

**No. 23 Adjustable Wall Bracket**  
Screen can be extended 10", 14", 15 3/4", 18 1/4", 20" or 24" from wall by wing nut and bolt adjustment.

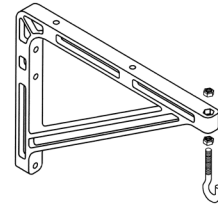

**No. 11 Wall Bracket**  
Screen can be extended 10" or 14" from wall by changing position of bracket.

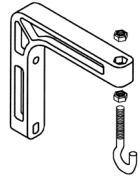

**No. 6 Wall Bracket**  
Screen can be extended 6" from wall.

**Extension Wall Brackets (75# Per Pair Maximum)**

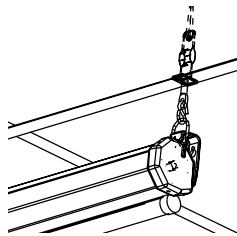

**T-Bar Clip** for drop ceiling, 50 lb. capacity.

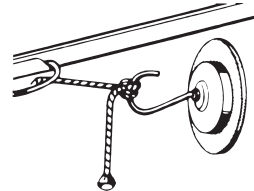

**Tilt Lock** for Keystone elimination. Used with extension brackets.

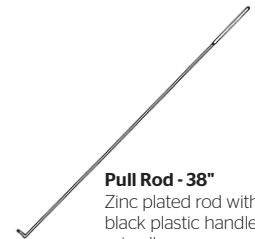

**Pull Rod - 38"**  
Zinc plated rod with black plastic handle grip allows easy access to screen when mounted out of reach. Also can be used as a pointer.



A Milestone AV Technologies Brand

3100 North Detroit Street  
Warsaw, Indiana 46582  
P: 574.267.8101 or 800.622.3737  
F: 574.267.7804 or 877.325.4832  
E: info@da-lite.com  
www.da-lite.com

DL-0213 11.13

© 2013 Milestone AV Technologies LLC. Printed in U.S.A.

Project Name: \_\_\_\_\_  
 Architect: \_\_\_\_\_  
 Contractor: \_\_\_\_\_ Phone: \_\_\_\_\_  
 Reseller: \_\_\_\_\_ Phone: \_\_\_\_\_