

LED FULL HD 1080p

23 INCH HD SDI INPUT MONITOR

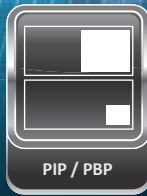

SD · HD · 3G-SDI

23HSDI3G

OVERVIEW

The ORION Images 23HSDI3G incorporates the SD / HD / 3G-SDI formats with latest panel and image processing technology to provide higher contrast and accurate scaler at a price that fits your budget.

FEATURES

- » Full HDTV display that delivers real time broadcast grade images
- » LED backlight to extend the lifetime and save power
- » SD / HD / 3G-SDI (level A) is supported in addition to composite, PC (VGA), Component, DVI-D and HDMI inputs
- » Non-glare surface coating
- » Wireless remote control
- » PIP / PBP multi display function



23HSDI3G

SD / HD / 3G-SDI INPUT MONITOR

SPECIFICATIONS

23HSDI3G	
Display	
Screen Size	23 Inch
Max. Resolution	1920 x 1080 @ 60Hz
Pixel Pitch	0.2652 x 0.2652mm
Surface	Non-glare coating
Brightness	250cd/m ²
Contrast Ratio	1000 : 1
Aspect Ratio	16 : 9
Viewing Angle (H/V)	178° / 178°
Display Color	16.7 Million
Response Time	< 5ms (Gray to Gray)
Video System	NTSC / PAL
Interface	
SDI In / Out	1 In / 1 Out
SD-SDI	480i (59.94) / 575i (50)
HD-SDI	720p (50 / 59.94 / 60) 1080i (50 / 59.94 / 60) 1080p (24 / 25 / 29.97 / 30)
3G-SDI	1080P (50 / 59.94 / 60)
Analog Composite In / Out	2 In / 2 Out
Component (Y, Pb, Pr) In	1 In
DVI-D In / HDMI In	1 In / 2 In
VGA In (15Pin D-Sub)	1 In
Audio In (RCA Type)	2 Left & Right
PC Stereo In	1 In
Transmitter	
Remote Control	Yes
Audio	
Built-in Speakers	Yes (1W x 2)
Features	
Multi Display Function	PIP / PBP
Filter Type	3D Comb Filter is built-in
Deinterlacing	Yes
Noise Reduction	Yes
Advanced Auto Power Recovery	Yes
Trigger Sensor	Yes
Auto Pixel Shift	Yes
Auto Source Sequencing	Yes
Multi Language	English, Spanish, French, German, Italian
General (W x H x D)	
Outline Dimension	21.73" x 13.90" x 3.48"
Net Weight	6.6Kg (14.55 lbs)
Material / Color	Metal / Black
Desk Top Stand	Kick Type
Power	< 33W DC12V / 5A, AC100 ~ 240V(50/60Hz)
Operating Temperature	0 ~ 40° C / 32 ~ 104° F
Optional Mounts	
VESA™ Mount Size	100 x 100mm
Wall	WB-5, WB-10, WB-30, WB-31
Ceiling	CMK-01

*Design and specifications are subject to change without notice

INPUT INTERFACE

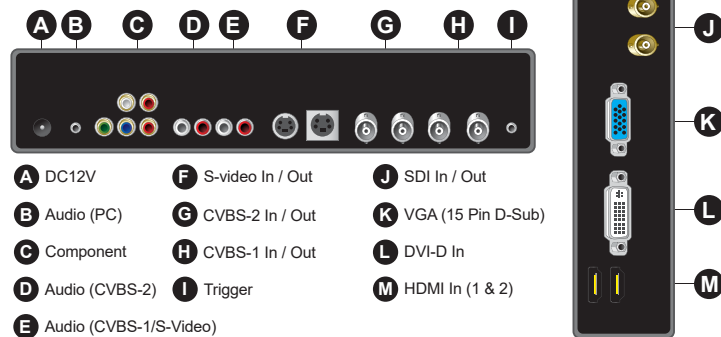

DIMENSIONS

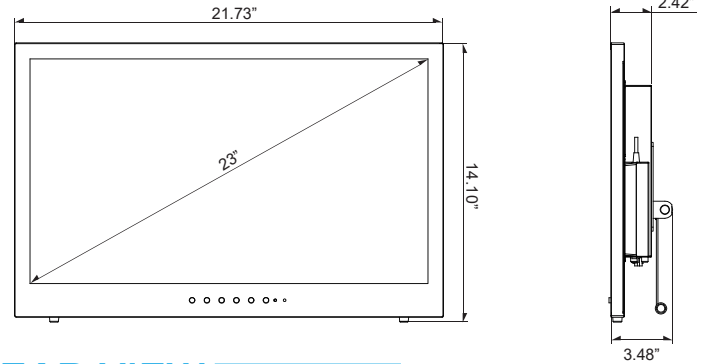

REAR VIEW AC ADAPTER



AVAILABLE ACCESSORY



HD CCTV Cameras

- Full HD (1920 x 1080 30p) Video
- High resolution video with Progressive Scan
- HD Serial Digital Interface Type Video Output
- Minimum illumination 1Lux-Auto Switching Mode at 12 Lux



4CH Digital Splitter (CDS4S)

- Auto System Recovery
- Digital video splitter only for High definition camera (HD-SDI/HDMI)
- Various video output mode (1920x1080, 1280x1024, 1280x960, 1280x720, 1024x768)
- Support RS-232, RS-485



HD Receiver (CSDHRC)

- HDMI device which is receiving HD-SDI video of 2.2M pixel camera
- This box type HD-SDI receiver can connect to monitor directly. (BNC In & DVI Out)





HD Repeater / Distributer (2CH) (CSDRP2)

- Distance extension device for HD-SDI. In addition, there are two outputs from one input. Therefore, user can use two monitors with one HD-CCTV camera. When user uses repeater between HD-CCTV and Receiver, the distance can be increased 300ft per repeater.

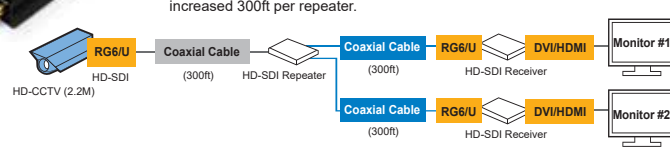



HD Repeater / Distributer (8CH) (CSDRP8)

- Distance extension device for HD-SDI. In addition, there eight outputs from one input

