

GV-MFD1501 1.3MP H.264 Super Low Lux WDR Mini Fixed Dome



- 1.3 Megapixel Progressive Scan super low lux CMOS
 - Min. illumination at 0.01 lux
 - Dual streams from H.264 and MJPEG
 - Up to 30 fps at 1280 x 1024
 - Day and night function (electronic)
 - USB slot for GV-WiFi Adapter or USB hard drive
 - Built-in micro SD card slot (SD/SDHC) for local storage
 - Active Tampering alarm
 - Wide Dynamic Range (WDR)
 - 3D DNR (Digital Noise Reduction)
 - Two-way audio
 - Defog
 - Motion detection
 - Privacy mask
 - IP address filtering
 - iPhone, iPad, Android
 - DC 5V / PoE
 - Megapixel lens
 - Supports iPhone, iPad, Android & 3GPP
 - 31 languages on Web interface
 - ONVIF (Profile S) conformant
- * No Memory card slot & local storage function for Argentina.

Introduction

The GV-MFD1501 Series offers an indoor, fixed, mini-sized network camera with various lens options. The camera is equipped with a Super Low Lux CMOS image sensor with which the camera is capable of providing a color live view in near darkness. The camera's USB port which supports wireless connection through GV-WiFi Adapter (optional) or an external storage using a USB hard drive.

Active Tampering Alarm

Tampered



Focus Change

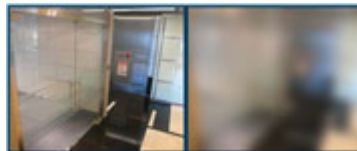

Camera Shift

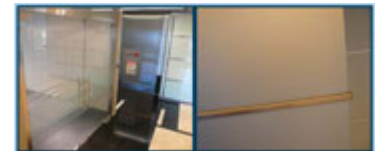

Models

Models	Iris	Focal Length (mm)	Maximum Aperture	Image Format
MFD1501-0F	Fixed	3 mm	F/2.0	1/3"
MFD1501-1F		4 mm	F/1.5	
MFD1501-2F		8 mm	F/1.6	
MFD1501-3F		12 mm		
MFD1501-4F		2.1 mm	F/1.8	

Dimensions

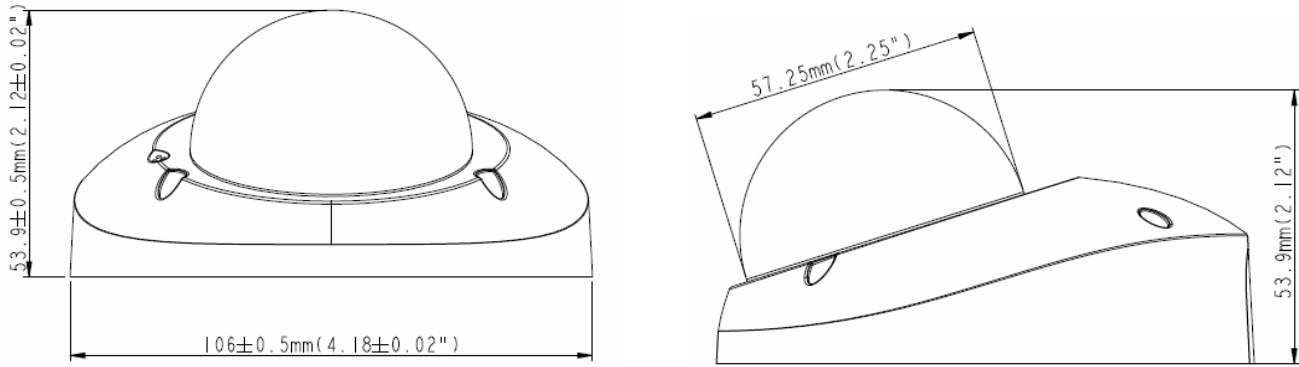

Specifications

Camera		GV-MFD1501-0F	GV-MFD1501-1F	GV-MFD1501-2F	GV-MFD1501-3F	GV-MFD1501-4F
Image Sensor		1/3" progressive scan super low lux CMOS				
Picture Elements		1280 (H) x 1024 (V)				
Minimum Illumination	Color B/W	0.01 Lux				
Shutter Speed		Automatic, Manual (1/5 ~ 1/8000 sec.)				
White Balance		Automatic, Manual (2800K ~ 8500K)				
Gain Control		Automatic				
S/N Ratio		55 dB				
WDR		Yes				
Lens						
Megapixel		Yes				
Day/Night		Yes (Electronic)				
Iris		Fixed				
Focal Length		3 mm	4 mm	8 mm	12 mm	2.1 mm
Maximum Aperture		F/2.0	F/1.5	F/1.6	F/1.6	F/1.8
Mount		M12, Pitch 0.5 mm				
Image Format		1/3"				
Operation	Focus	Fixed				
	Zoom	Fixed				
	Iris	Fixed				
Operation						
Video Compression		H.264, MJPEG				
Video Streaming		Dual streams from H.264 and MJPEG				
Frame Rate		30 fps at 1280 x 1024 * The frame rate and the performance may vary depending on the number of connections and data bitrates (different scenes).				
Image Setting		Brightness, Contrast, Sharpness, Gamma, White Balance, Flicker-less 50/60 Hz, Image Orientation, Shutter Speed, Backlight Compensation, WDR, Defog, Super Low Lux				
Audio Compression		G.711				
Sensor Input		No				
Alarm Output		No				
Video Resolution						
Main Stream	4:3	1280 x 960, 640 x 480, 320 x 240				
	16:9	1280 x 720, 640 x 360, 448 x 252				
	5:4	1280 x 1024, 640 x 512, 320 x 256				
Sub Stream	4:3	640 x 480, 320 x 240				
	16:9	640 x 360, 448 x 252				
	5:4	640 x 512, 320 x 256				

Network		
Interface	10/100 Ethernet	
Ethernet Protocol	DHCP, DynDNS, FTP, HTTP, HTTPS, NTP, ONVIF (Profile S), PSIA, QoS (DSCP), RTSP, SNMP, SMTP, TCP, UDP, UPnP, 3GPP/ISMA	
Mechanical		
Temperature Detector	Yes	
Camera Angle Adjustment	Pan	-45° ~ 45°
	Tilt	0° ~ 90°
Connectors	Power	2-pin terminal block, PoE
	Ethernet	Ethernet (10/100 Base-T), RJ-45
	Audio	1 In (built-in microphone), 1 Out (RCA female for speaker)
	USB	GV-WiFi Adapter or USB hard drive
Local Storage	Micro SD card slot (SD/SDHC, SD version 2.0 only, Class 10) * SDXC and UHS-I card types are not supported.	
LED Indicator	4 LEDs: Link, ACT, Power, Status	
General		
Camera Housing	black, white	
Environment Temperature	0 °C ~ 50 °C (32 °F ~ 122 °F)	
Humidity	10% to 90% (no condensation)	
Power Source	5V DC/PoE (IEEE 802.3af)	
Max. Power Consumption	6 W	
Dimension	∅ 106 x 53.9 mm (4.2" x 2.1")	
Weight	280 g (0.62 lb)	
Regulatory	CE, FCC, C-Tick, RoHS compliant	
Power over Ethernet		
PoE Standard	IEEE 802.3af Class 3 Power over Ethernet / PD	
PoE Power Supply Type	End-Span	
PoE Power Output	Per Port 48V DC, 350mA. Max. 15.4 watts	
Web Interface		
Installation Management	Web-based configuration	
Maintenance	Firmware upgrade through Web Browser or Utility	
Access from Web Browser	Camera Live View, Video Recording, Change Video Quality, Bandwidth Control, Image Snapshot, Digital I/O Control, Audio, Picture in Picture, Picture and Picture, Privacy Mask, Text Overlay, Digital PTZ	
Language	Arabic / Bulgarian / Czech / Danish / Dutch / English / Finnish / French / German / Greek / Hebrew / Hungarian / Indonesian / Italian / Japanese / Lithuanian / Norwegian / Persian / Polish / Portuguese / Romanian / Russian / Serbian / Simplified Chinese / Slovakian / Slovenian / Spanish / Swedish / Thai / Traditional Chinese / Turkish	
Applications		
Network Storage	GV-NVR, GV-System, GV-Backup Center, GV-Recording Server	
Smart Device Access	GV-Eye for Android smartphone, tablet, iPhone, and iPod Touch GV-Eye HD for iPad	
Live Viewing	IE, mobile phone	
CMS Server support	GV-Control Center, GV-Center V2, GV-VSM	





Note:

- Mind the following limitations and requirements for the USB port:
 - The USB hard drive must be of 2.5" or 3.5", version 2.0 or above
 - The USB hard drive's storage capacity must not exceed 2TB
 - USB flash drives and USB hubs are not supported
 - External power supply is required for the USB hard drive
 - To connect the GV-WiFi Adapter, make sure it is connected before the camera is powered on.
- Specifications are subject to change without notice.

Packing List

- | | |
|---------------------------|-------------------------------------|
| 1. Mini Fixed Dome | 7. USB / Audio Y-cable |
| 2. Torx Wrench | 8. GV-IPCAM H.264 Quick Start Guide |
| 3. Self Tapping Screw x 2 | 9. GV-IPCAM H.264 Software CD |
| 4. Screw Anchor x 2 | 10. GV-NVR Quick Start Guide |
| 5. Cable Stopper x 1 | 11. GV-NVR Software DVD |
| 6. Short-Body RJ-45 Plug | |

Accessories

Model No./Name	Details
GV-Mount900 Wall Mount Bracket 	Dimensions: 154 x 108 x 50 mm (6.1" x 4.3" x 2") Weight: 240 g (0.53 lb)
GV-Mount909 Wall Mount Bracket 	Dimensions: 170 x 150 x 110 mm (6.7" x 5.9" x 4.3") Weight: 610 g (1.34 lb)
GV-Mount910 Power Box Mount Bracket 	Dimensions: 112 x 98 x 7.5 mm (4.4" x 3.9" x 0.3") Weight: 105 g (0.23 lb)
GV-Mount913 Power Box Mount Bracket 	Dimensions: \varnothing 146 x 7.5 mm (\varnothing 5.7" x 0.3") Weight: 180 g (0.4 lb)
GV-PA191 PoE Adapter 	Weight: 130 g (0.29 lb) Dimensions (H x W x D): 43 x 69 x 40 mm (1.69" x 2.72" x 1.57")
Power Adapter	Power adapters are available in 4 regions: U.S.A., Australia, U.K and Europe.
GV-POE Switch	The GV-POE Switch is designed to provide power along with network connection for IP devices. The GV-POE Switch is available in various models with different numbers and types of ports.

Model No./Name	Details
<p data-bbox="71 190 239 235">GV-WiFi Adaptor</p> 	<p data-bbox="590 190 798 235">Weight: 20 g (0.04 lb)</p> <p data-bbox="590 224 1101 257">Dimensions: 15 x 15 x 155 mm (0.59" x 0.59" x 6.10")</p> <p data-bbox="590 257 1053 302">Supplied with mini USB to standard USB adapter.</p>