

# Monolith by Monoprice Double Wide XL 3 Tier Audio Stand

STEP 1

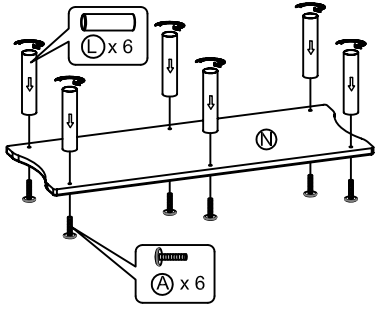

STEP 2

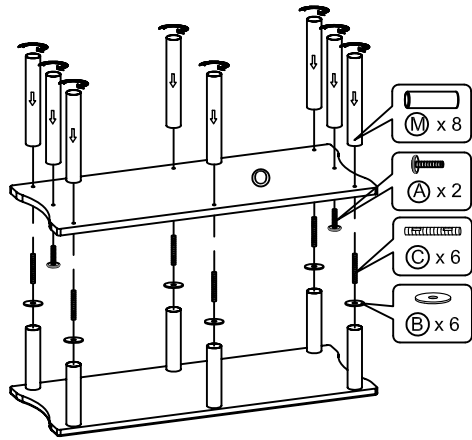

STEP 3

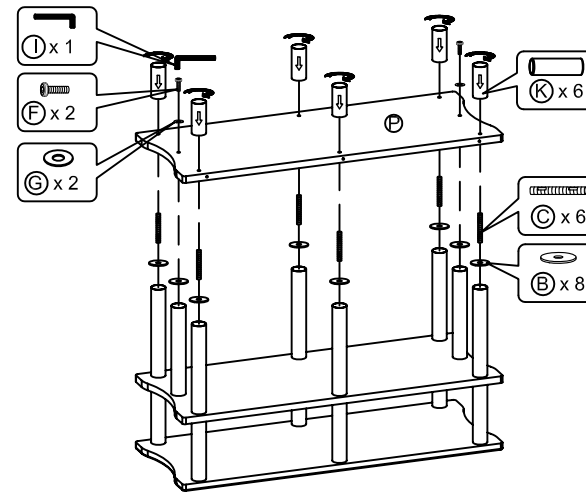

STEP 4

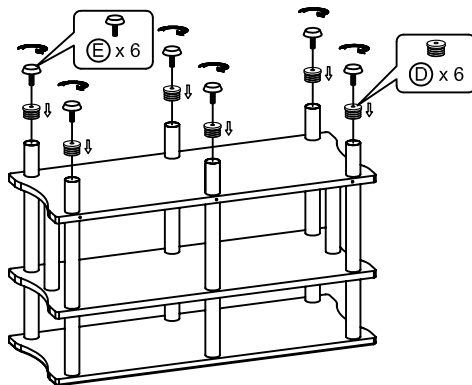



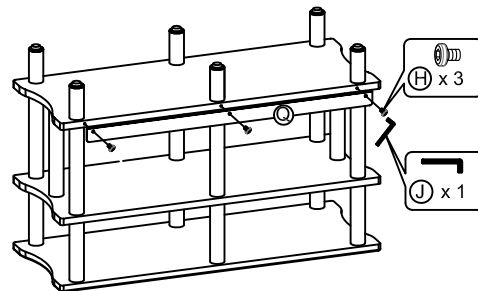



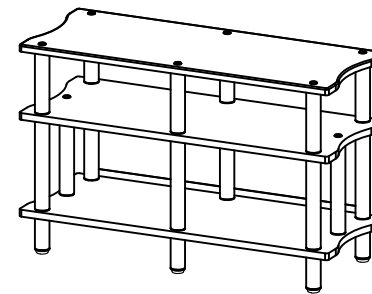







STEP 5

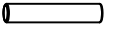
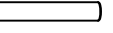

STEP 6



NO.	DESCRIPTION	QTY
A	M8*46 	8
B	∅50*2 	14
C	M8*72 	12
D	∅2" 	6
E	∅38*22 	6
F	M8*50 	2
G	M8*∅18 	2
H	∅1/4"*12 	3
I	5mm 	1
J	4mm 	1
K	L=119 	6
L	L=223 	6
M	L=328 	8
N	T=25mm 	1
O	T=25mm 	1
P	T=25mm 	1
Q	L=1394 	1