

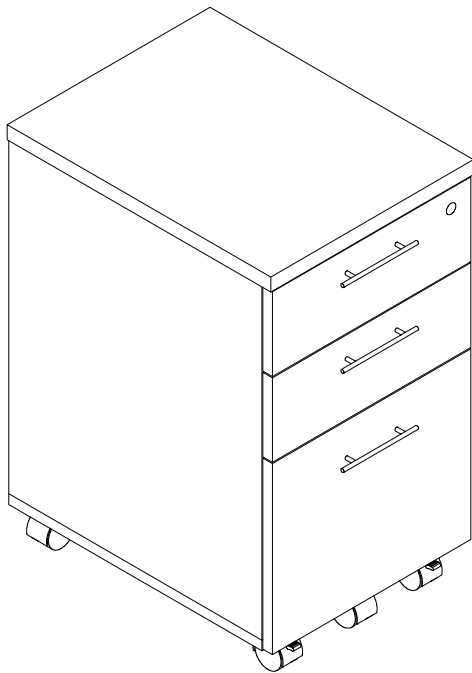





Medina Series™  
 Mobile Pedestal, Box/Box/File  
 Model No. MNBBF

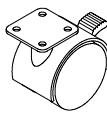
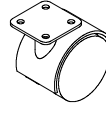
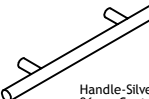

ASSEMBLY INSTRUCTIONS  
 CALL 1-800-822-8037 FOR ASSISTANCE

# PARTS LIST

Name	Part	Qty.	Spare Qty.	Name	Part	Qty.	Spare Qty.
<b>A</b>	 <b>REALS005</b> 4x16mm <small>HB</small>	<b>20</b>	<b>1</b>	<b>D</b>	 <b>REALS052</b> Caster <small>HB</small>	<b>2</b>	
<b>B</b>	 <b>REALS027</b> Caster <small>HB</small>	<b>3</b>		<b>E</b>	 Handle-Silver 96mm Center <small>HB</small>	<b>3</b>	
<b>C</b>	 Keys <small>HB</small>	<b>1</b>		<b>F</b>	 Handle Screw M4x35mm White <b>REALS410</b>	<b>6</b>	

**IMPORTANT!**

**Review ALL instructions before beginning assembly.** These instructions are provided to avoid problems that may occur from improper assembly or installation. Mayline and/or its distributor are not responsible for failure resulting from improper assembly or installation of this product. Moreover, all warranties are void for failure to follow these assembly instructions.

Items with HB are in hardware box.

① Attach Handles (E) to the fronts of Drawer using Screws (F)

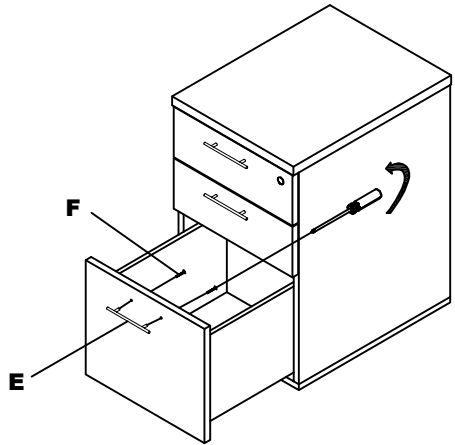

② Attach Casters (B & D) to underside of Pedestal using Screws (A).

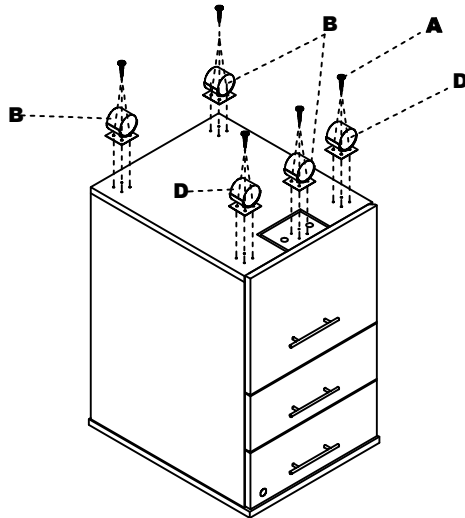

**2**

## Pre-Installed Replacement Parts List

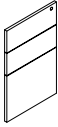
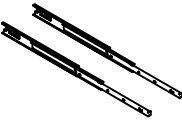
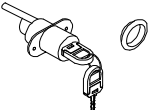
Part	Included Qty.	Part	Included Qty.
 <b>MNBBFDF**</b> Drawer Fronts, Set of 3	<b>1</b>	 <b>REALS422</b> 16" Drawer Slides	<b>3</b>
 <b>REALS401</b> Lock w/ Key	<b>1</b>		

\*\*Denotes Color Code

**3**