

# Assembly Guide



If you're having any difficulty during assembly of this product, don't hesitate to call us at **1-800-950-4782.**

Our customer service experts are trained to provide step-by-step instruction and can easily replace any missing or damaged parts.

**Representatives are available Monday-Friday from 8:30 a.m. to 7:30 p.m. (ET)**

## Shell Desk

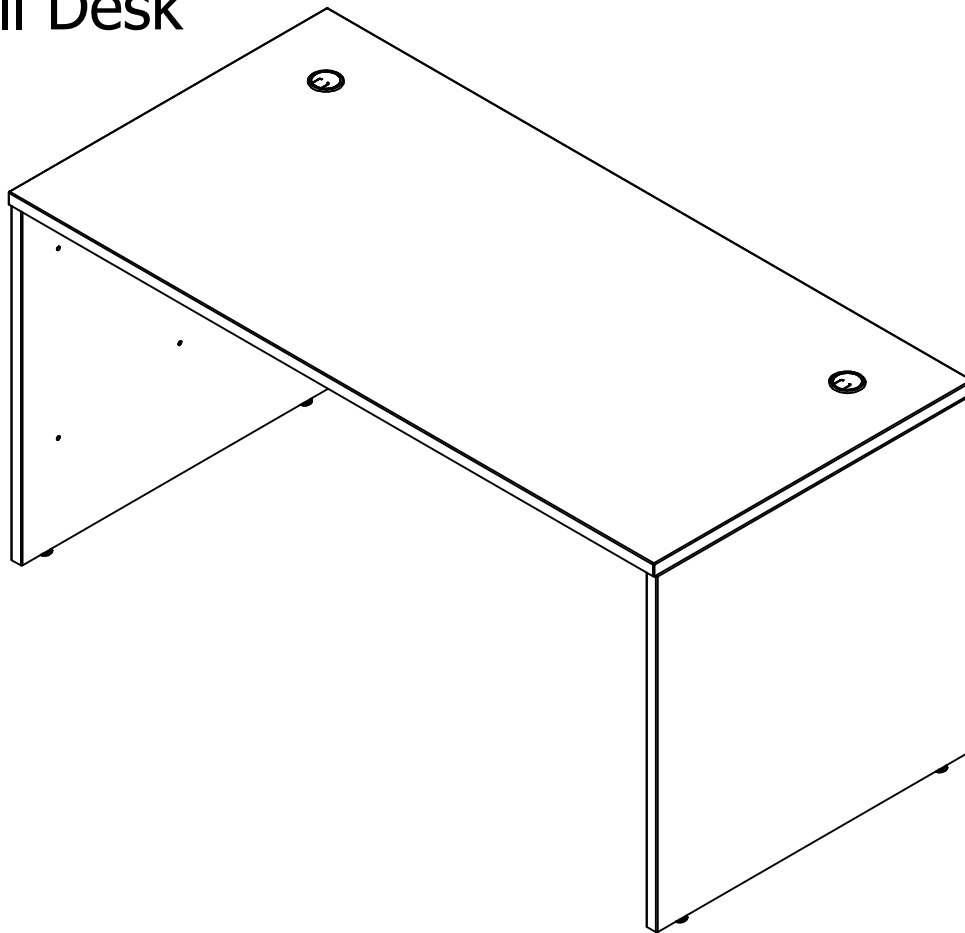

Lot Code #

Part Number A177039F

Keep manual for future reference.

## For best results, keep these tips in mind:

- ① We know you want to finish this assembly as quickly as possible, but trust us: you'll have a better experience if you take it one step at a time.
- ② Give yourself some room to work near where you want the fully assembled product.
- ③ If your floor isn't carpeted, assemble this product on the empty carton to avoid scratching.
- ④ Do you have a friend who owes you a favor? Some steps may go a little easier with a second set of hands.

### DOs

- ✔ Use a #2 Phillips head screwdriver (or other handheld tools as indicated)
- ✔ Wear safety glasses at all times during assembly
- ✔ Carefully follow the instructions in this guide and complete all steps in order
- ✔ Give us a call if you're having trouble with a particularly tricky step

### DON'Ts

- ✘ We know power tools are quick and easy, but you shouldn't use them when assembling this product (unless otherwise specified)
- ✘ Never move your furniture with items inside or resting on the surface
- ✘ Do not attempt to use this product before all steps have been completed



## Watch assembly videos right on your phone or computer!



Some steps include QR codes that link to helpful videos. Watch out for the icon below! Simply open up your smartphone camera to scan the code.

*(Users of older smartphones may need to install a QR Reader.)*

**SCAN HERE**



**FOR VIDEOS**

Or visit <https://www.bushbusinessfurniture.com/CustomerService/HowtoAssemble.aspx>

# IMPORTANT SAFETY INFORMATION



## PLEASE READ WARNINGS

Improper use can cause safety hazards, or damage to your furniture and household items.

Warning	Do	Don't	Why it's important
<b>Serious injury may occur.</b>	<ul style="list-style-type: none"><li>Assemble following all instructions using all indicated parts and hardware provided.</li></ul>	<ul style="list-style-type: none"><li>Do not move unit when loaded.</li><li>Do not load with a television or other heavy equipment.</li><li>Do not exceed the maximum load limits stated in the instructions.</li></ul>	Improper assembly, use or loading can lead to product instability, tip-over or collapse.

Advertencia	Hacer	No	Por qué es importante
<b>Se pueden producir lesiones graves.</b>	<ul style="list-style-type: none"><li>Ensamble siguiendo todas las instrucciones utilizando todas las piezas y ferretería indicados provistos.</li></ul>	<ul style="list-style-type: none"><li>No mueva la unidad cuando esté cargada.</li><li>No cargue con un televisor u otro equipo pesado.</li><li>No exceda los límites máximos de carga establecidos en las instrucciones.</li></ul>	El ensamblaje, uso o carga inadecuados pueden provocar inestabilidad del producto, vuelco o colapso.

Avertissement	Faire	Ne le fais pas	Pourquoi c'est important
<b>Des blessures graves peuvent survenir.</b>	<ul style="list-style-type: none"><li>Assemblez en suivant toutes les instructions en utilisant toutes les pièces et le matériel indiqués fournis.</li></ul>	<ul style="list-style-type: none"><li>Ne déplacez pas l'unité lorsqu'elle est chargée.</li><li>Ne chargez pas avec un téléviseur ou un autre équipement lourd.</li><li>Ne dépassez pas les limites de charge maximale indiquées dans les instructions.</li></ul>	Un assemblage, une utilisation ou un chargement incorrects peuvent entraîner une instabilité du produit, un renversement ou un effondrement.

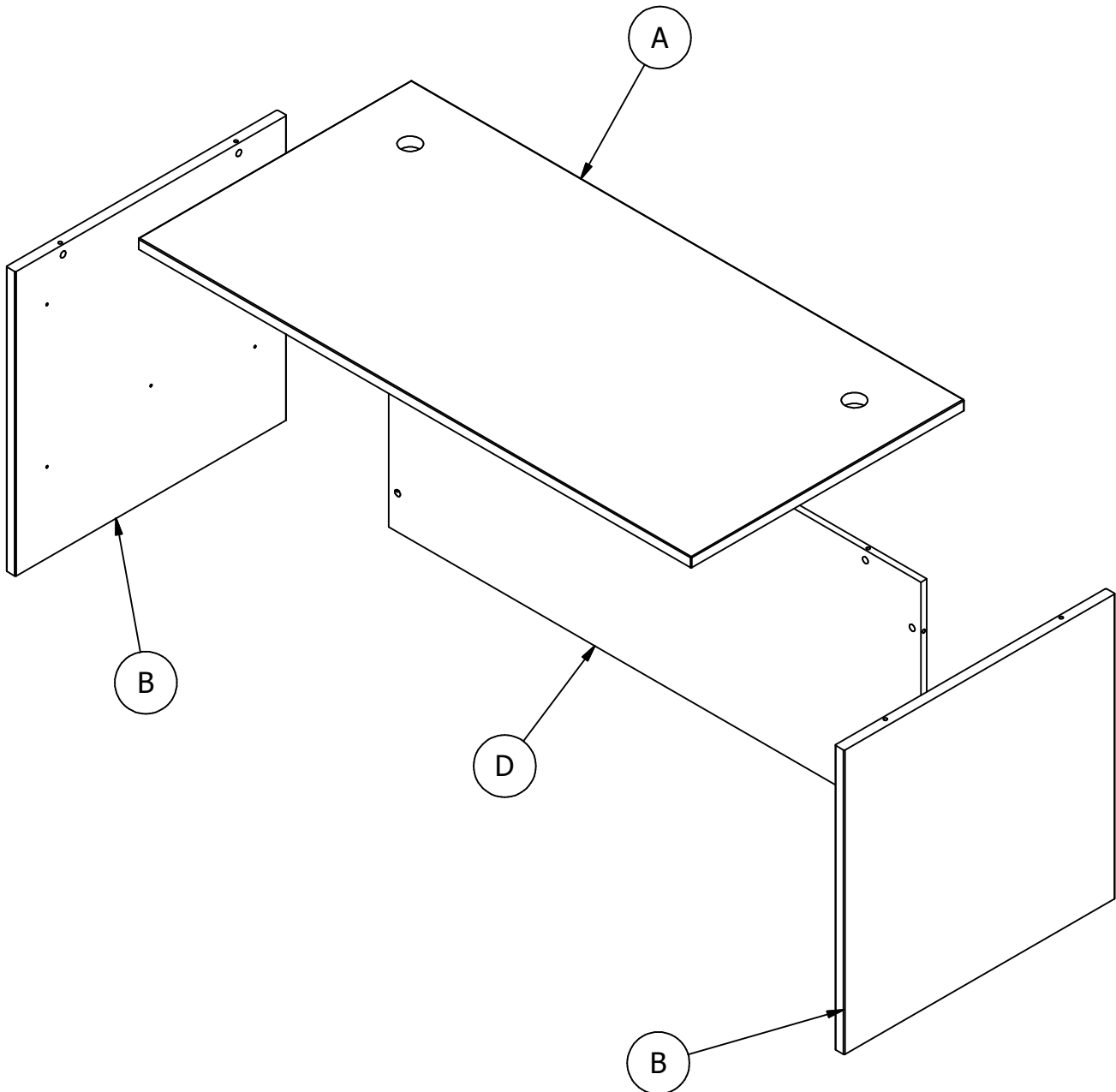
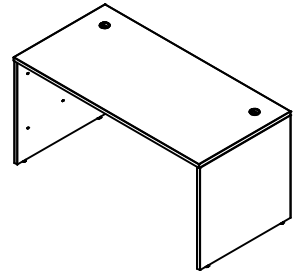

Have an assembly question or need a replacement part? Just call  
**1-800-950-4782**, we are here to help.

Fasteners are shown actual size.

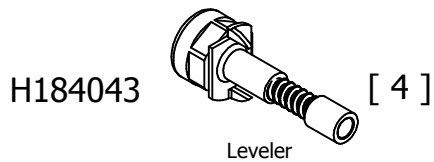
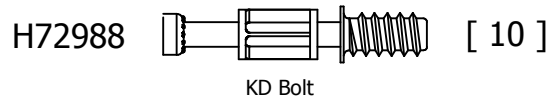
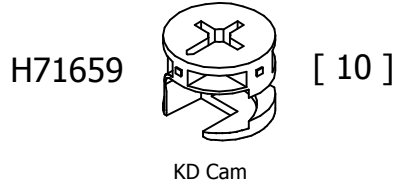
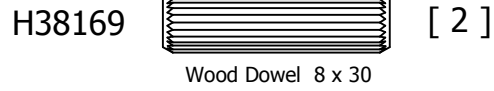

Have an assembly question or need a replacement part? Just call  
**1-800-950-4782**, we are here to help.

Hardware not to scale.

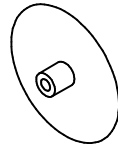

[ 10 ]

Cover Cap



[ 6 ]

5mm Hole Plug

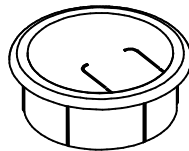

[ 2 ]

Grommet

# STEP 1

## Prepare Panel

A177039F

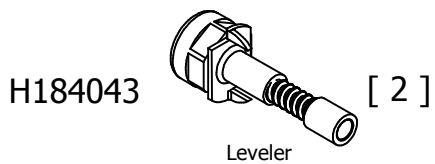
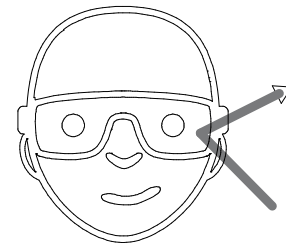
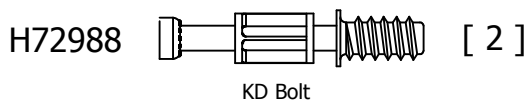

Safety glasses  
Gafas de seguridad  
Lunettes de protection

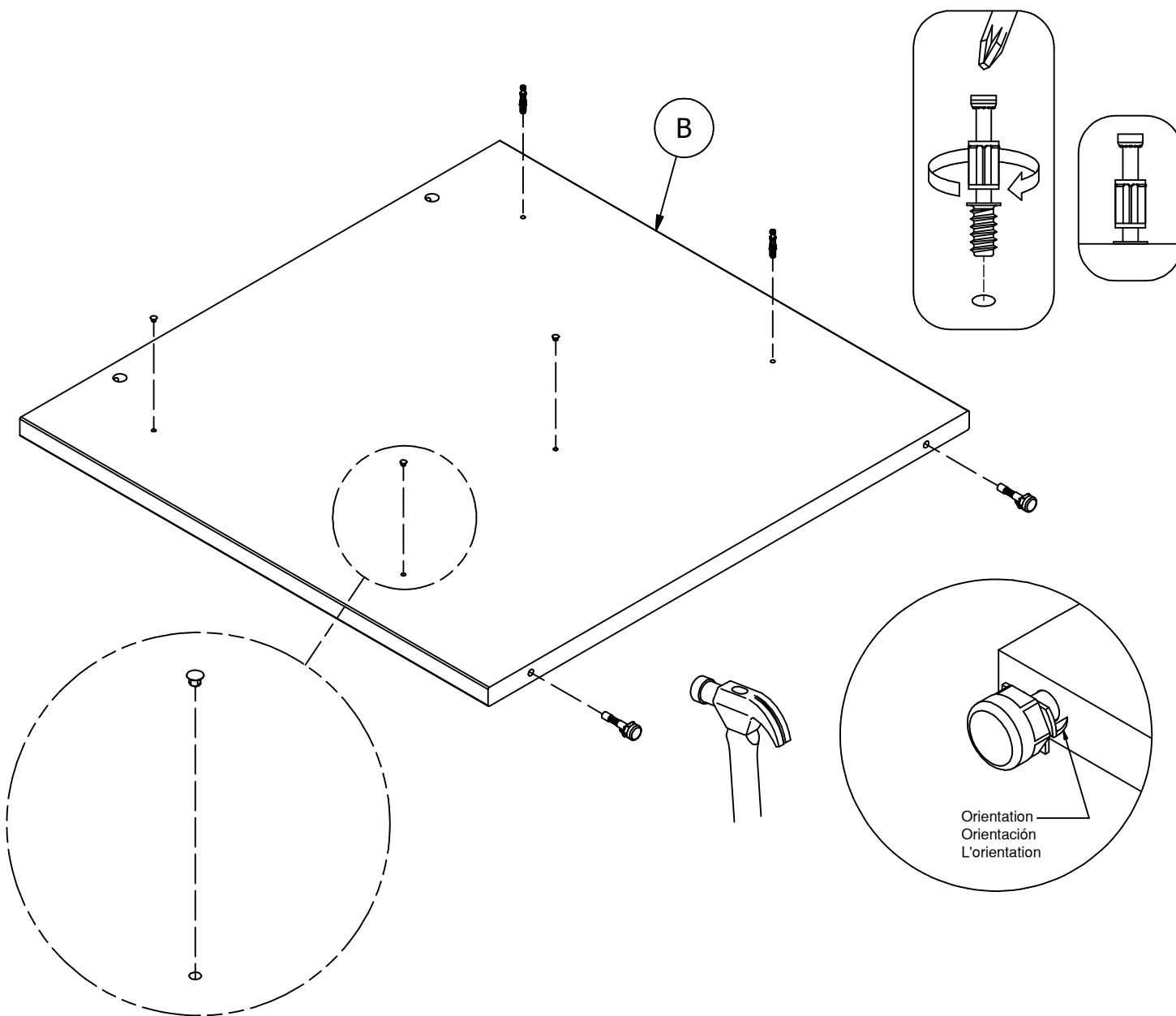

Have an assembly question or need a replacement part? Just call  
**1-800-950-4782**, we are here to help.

# STEP 2

# Prepare Panel

A177039F

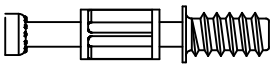
H72988  [ 2 ]  
KD Bolt

 [ 3 ]  
5mm

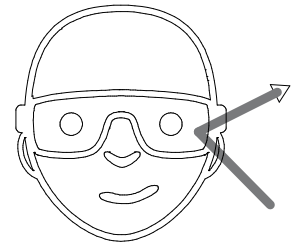

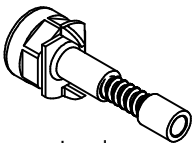
H184043  [ 2 ]  
Leveler

Safety glasses  
Gafas de seguridad  
Lunettes de protection

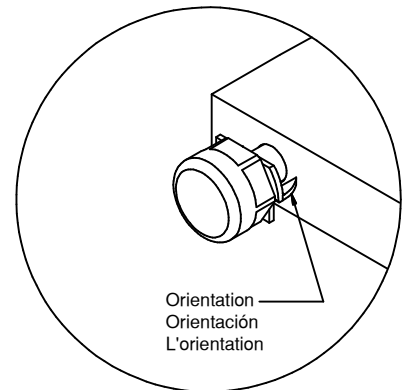
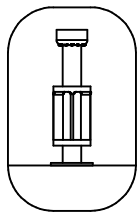
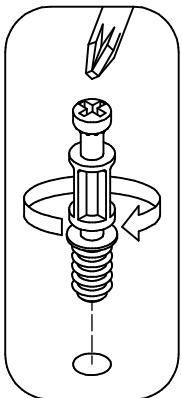
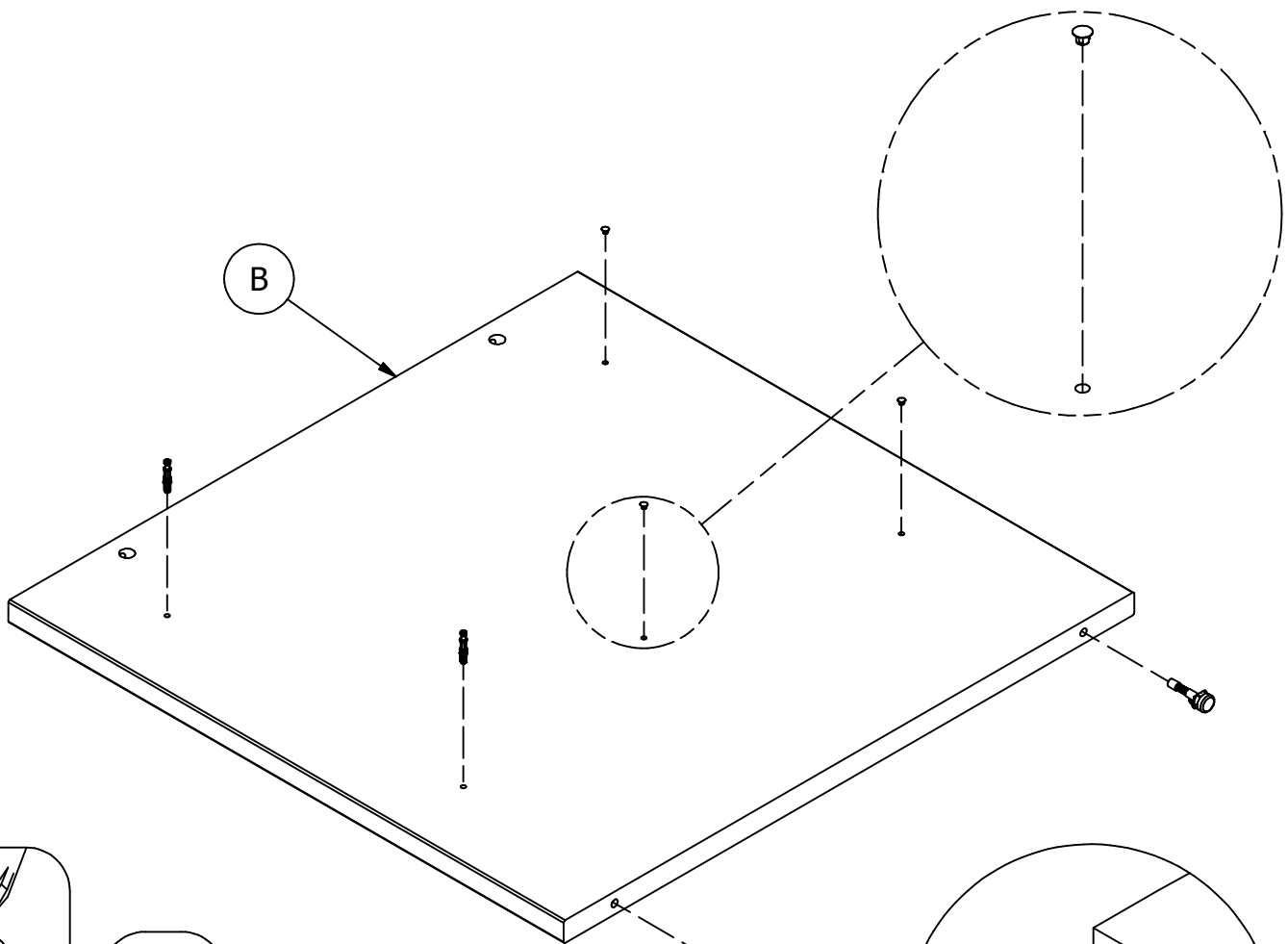

Have an assembly question or need a replacement part? Just call  
**1-800-950-4782**, we are here to help.



# STEP 3

# Assemble Modesty Panel

A177039F

Scan QR Code to Watch Video on:



How to Tighten KD Cams

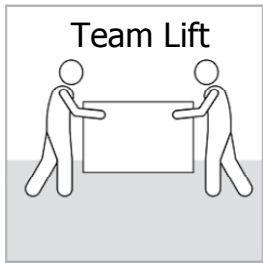

H38169  [ 2 ]  
Wood Dowel 8 x 30

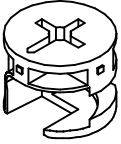
H71659  [ 2 ]  
KD Cam

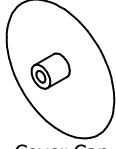
 [ 2 ]  
Cover Cap

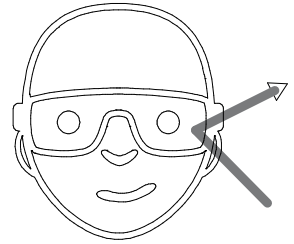

Safety glasses  
Gafas de seguridad  
Lunettes de protection

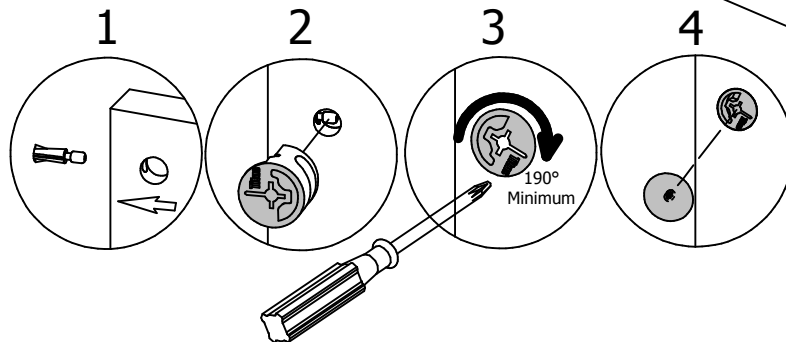
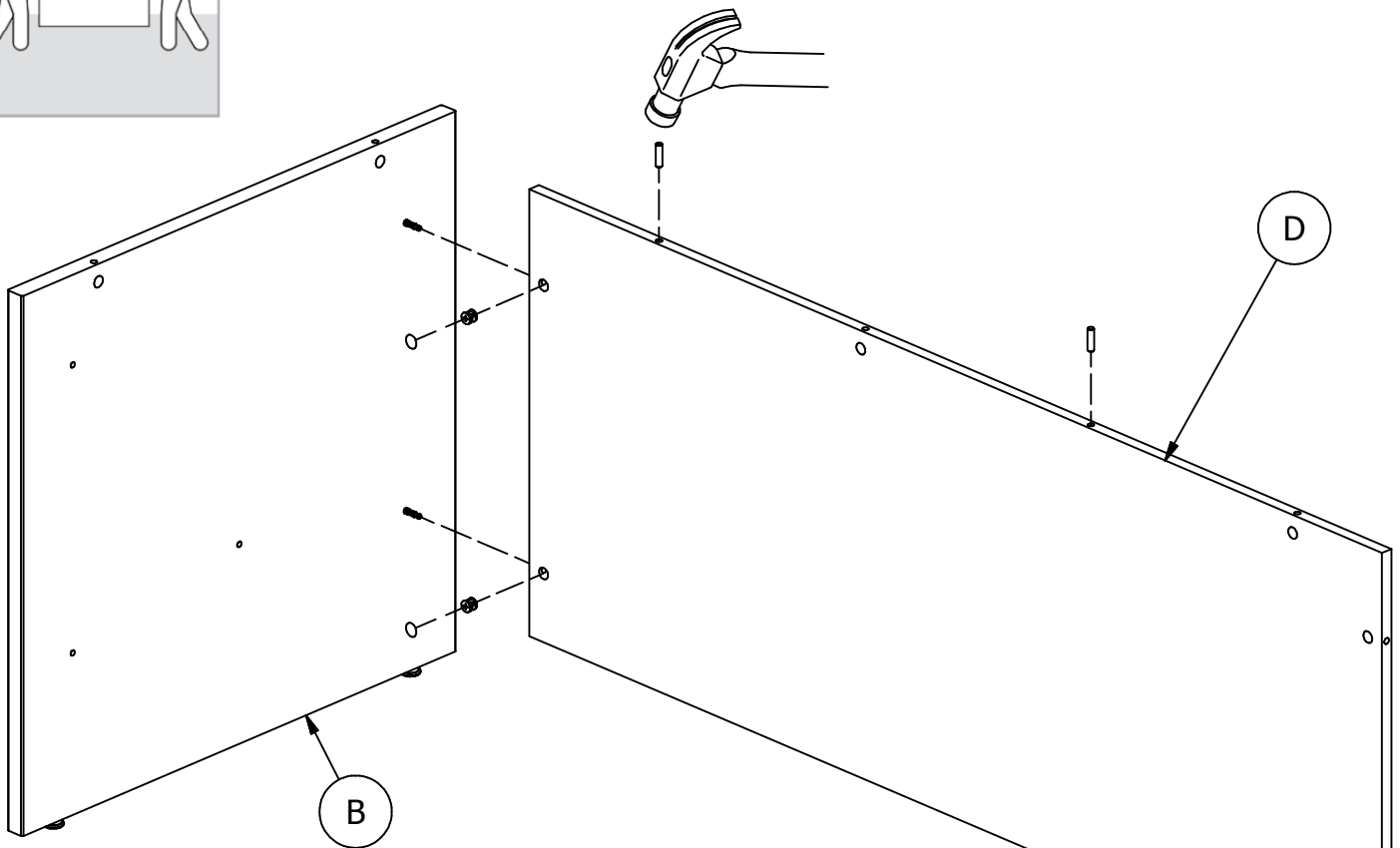

Have an assembly question or need a replacement part? Just call **1-800-950-4782**, we are here to help.

# STEP 4

# Assemble Modesty Panel

A177039F

Scan QR Code to Watch Video on:



How to Tighten KD Cams

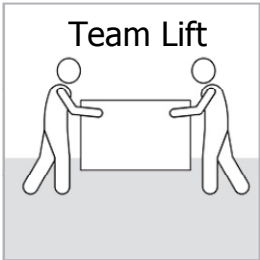

H71659

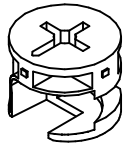

[ 2 ]

KD Cam

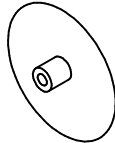

[ 2 ]

Cover Cap

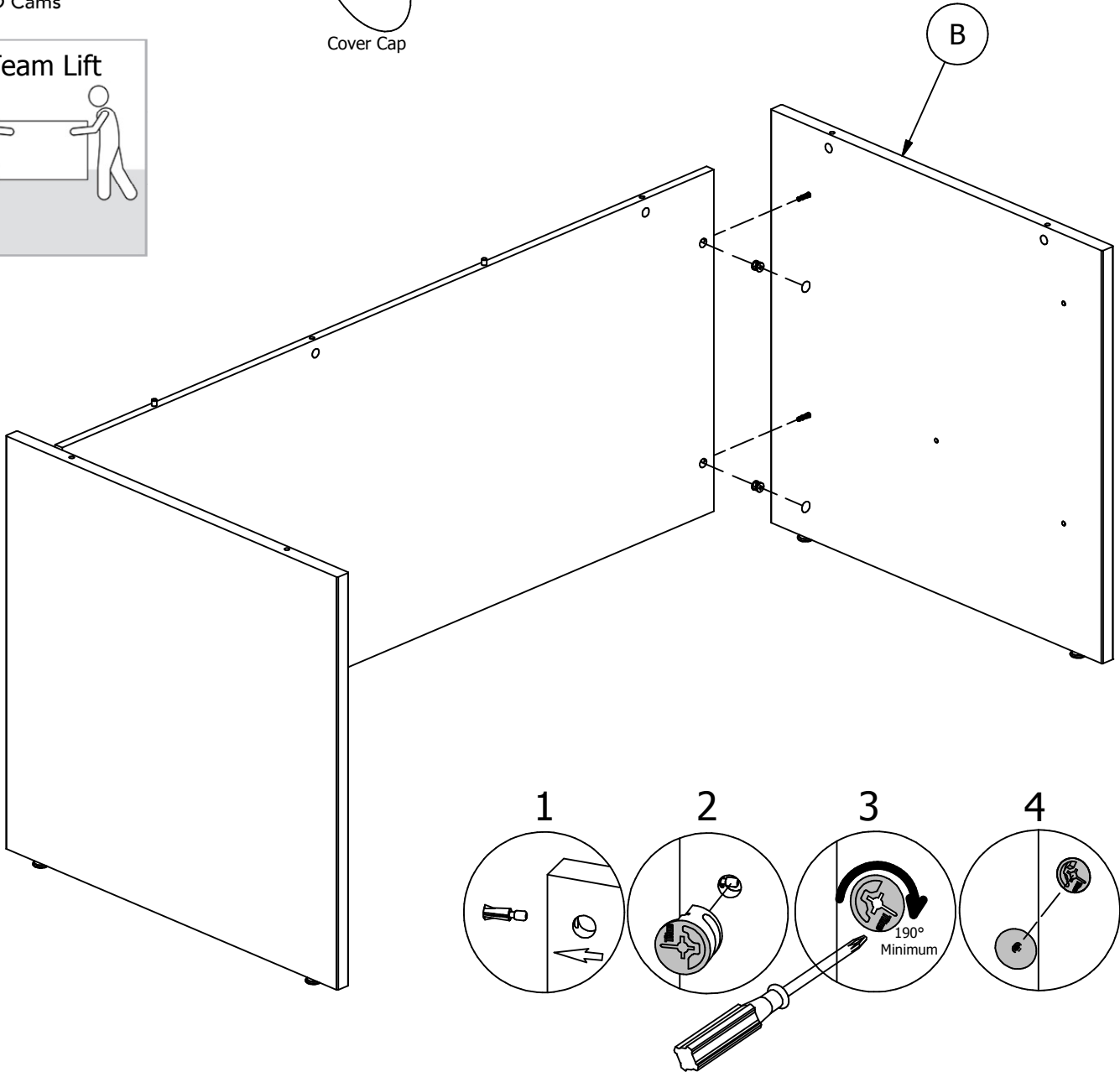

Have an assembly question or need a replacement part? Just call **1-800-950-4782**, we are here to help.

# STEP 5

# Prepare Top

A177039F

H72988 [ 6 ]  
KD Bolt

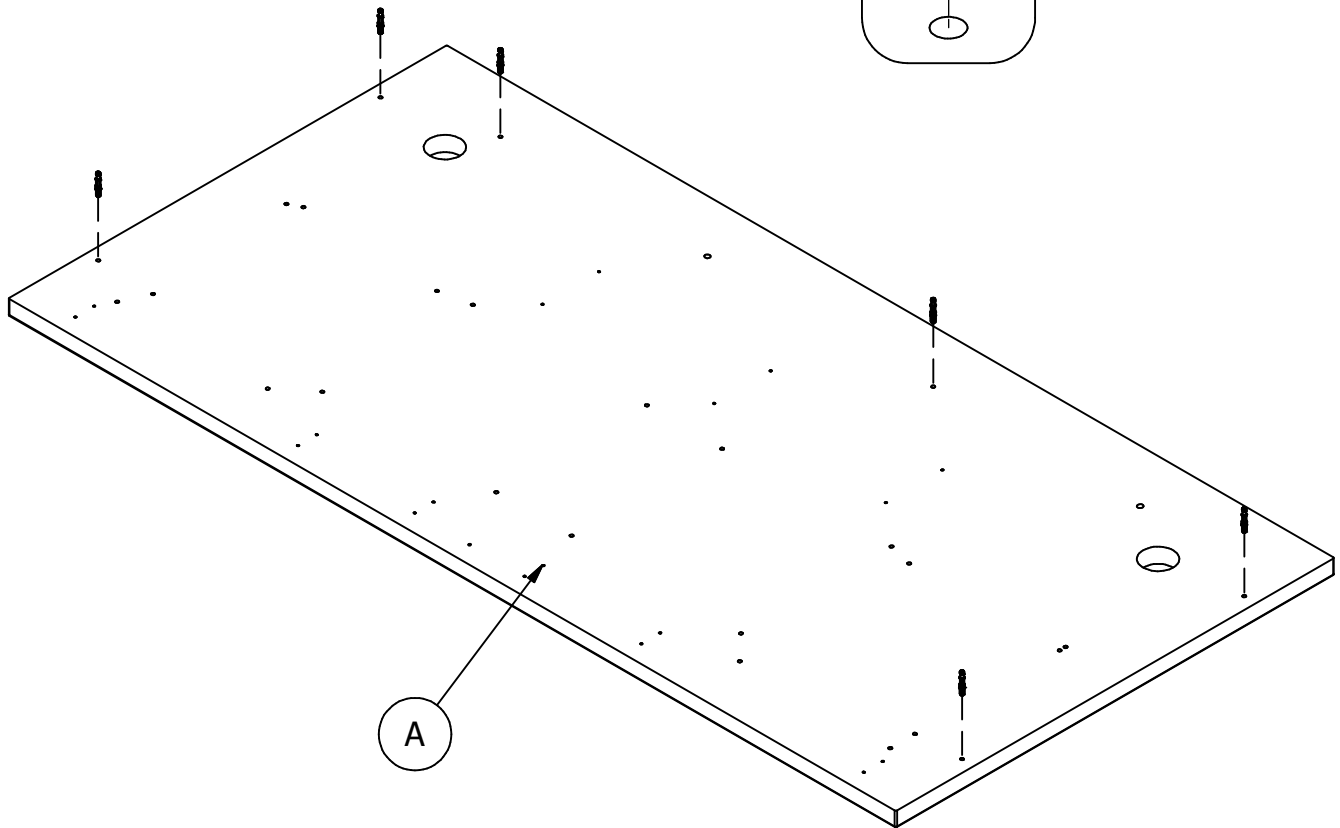
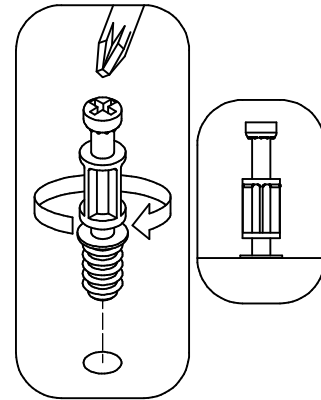

Have an assembly question or need a replacement part? Just call  
**1-800-950-4782**, we are here to help.

# STEP 6

# Attach Top

A177039F

Scan QR Code to Watch Video on:



How to Tighten KD Cams

H71659

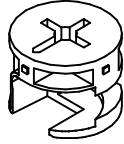

[ 6 ]

KD Cam

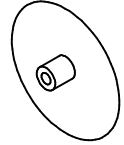

[ 6 ]

Cover Cap

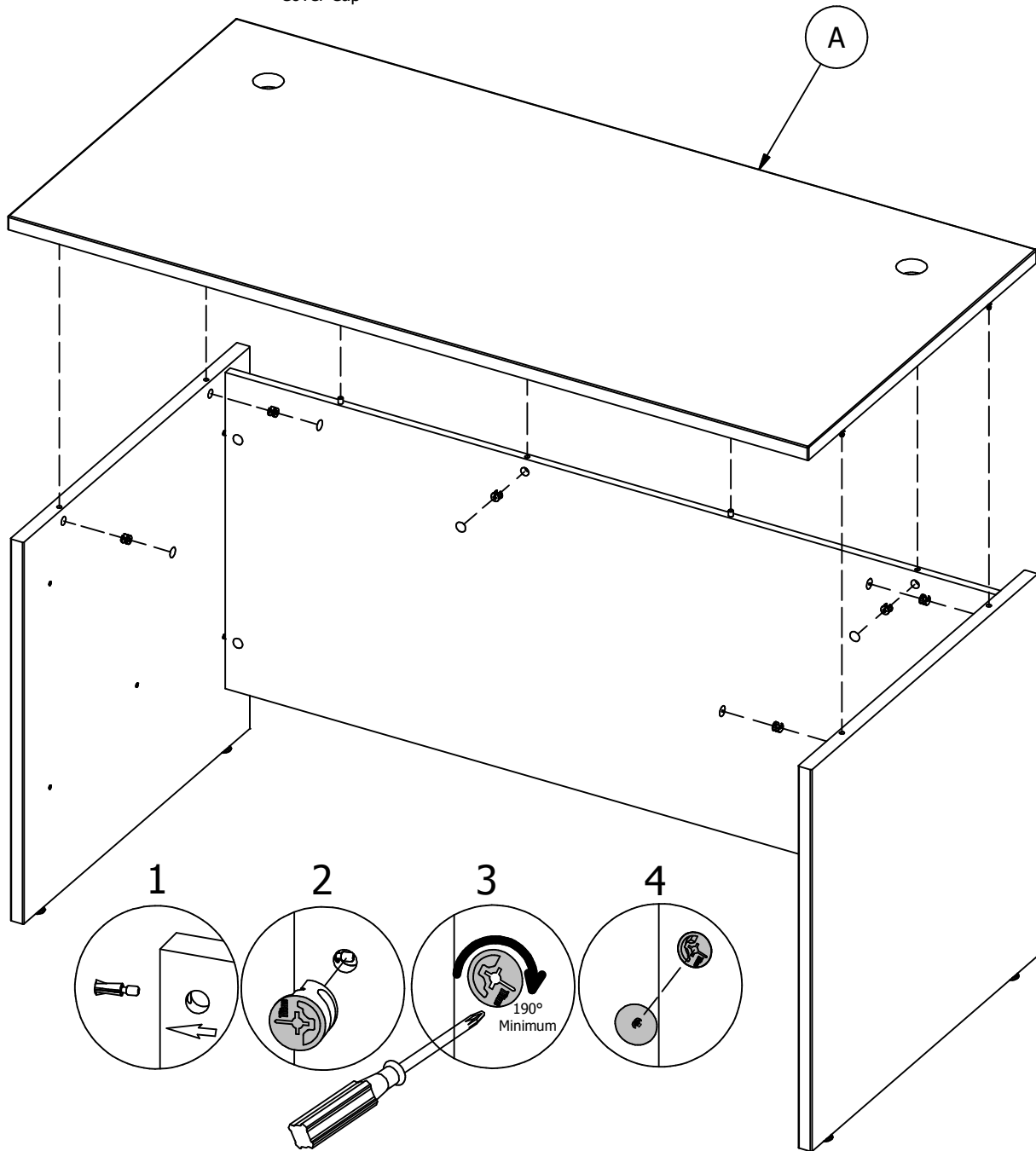
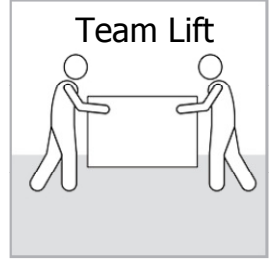

Have an assembly question or need a replacement part? Just call **1-800-950-4782**, we are here to help.

Scan QR Code to Watch Video on:



How to Clean the Surface

Gently clean surfaces with a damp sponge eraser.

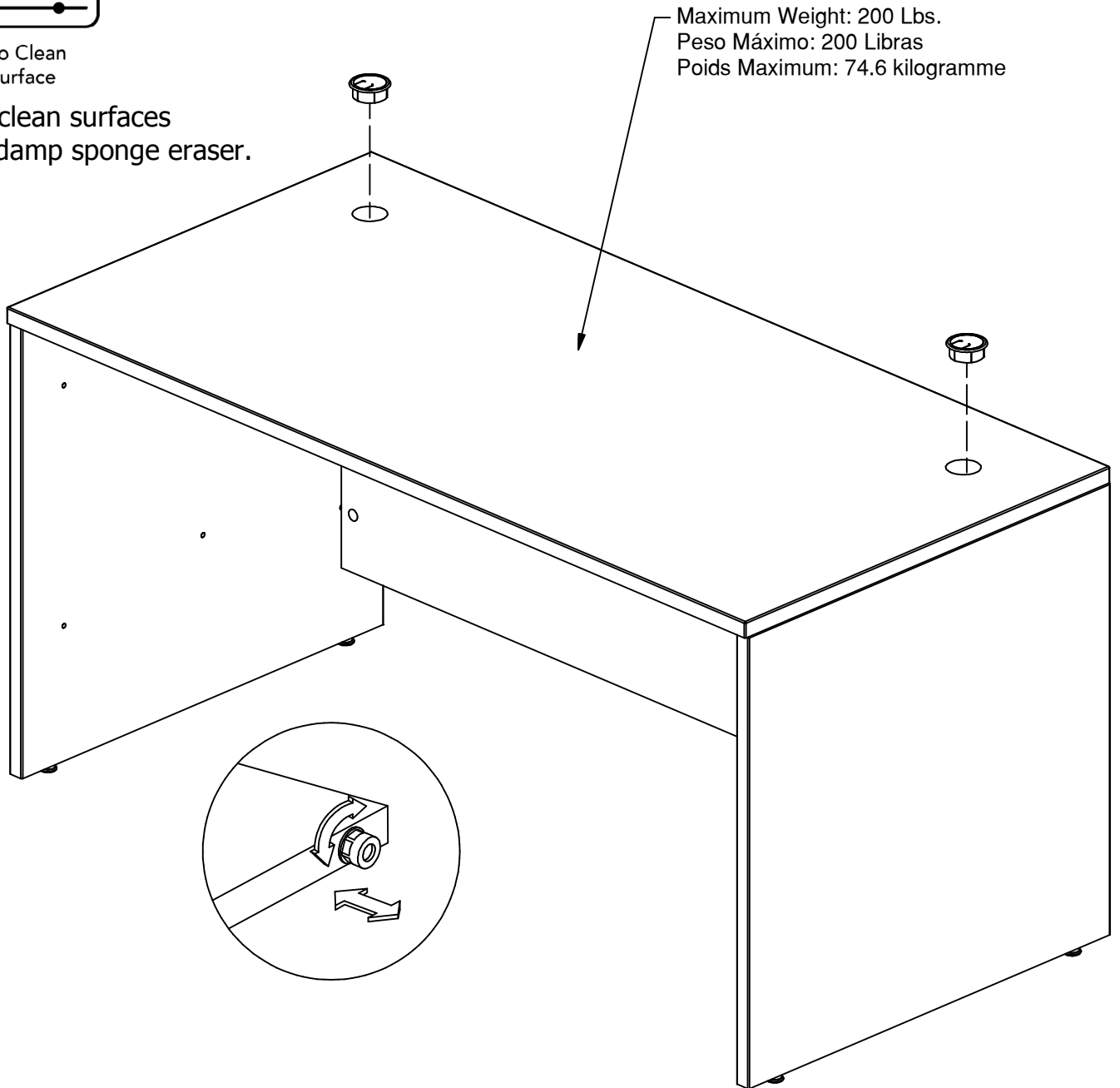
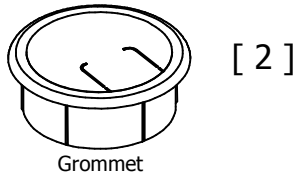

Congratulations! You are all done. If you have any questions or concerns, please call.

Have an assembly question or need a replacement part? Just call **1-800-950-4782**, we are here to help.

## WC12931

- A [ 1 ] W177040
- B [ 2 ] W186429
- D [ 1 ] W177028

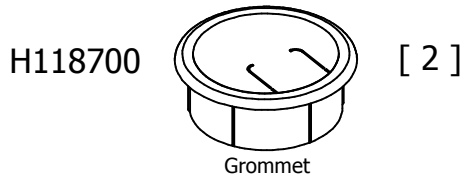
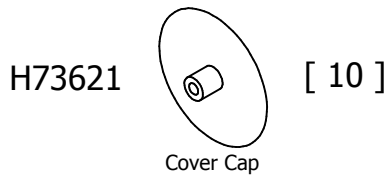

## WC24431

- A [ 1 ] W176078
- B [ 2 ] W186431
- D [ 1 ] W177030

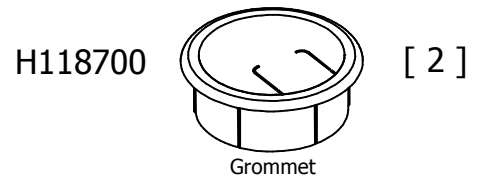
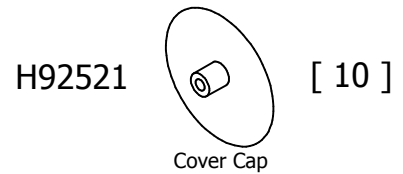

## WC24531

- A [ 1 ] W176078
- B [ 2 ] W186430
- D [ 1 ] W176077

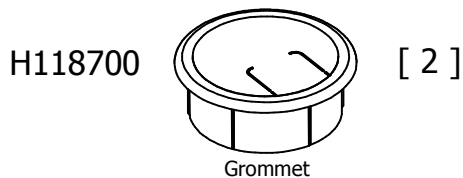
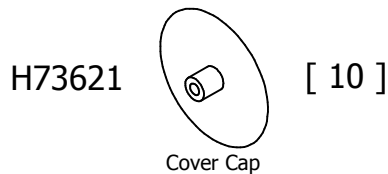

## WC36731

- A [ 1 ] W195411
- B [ 2 ] W186432
- D [ 1 ] W177032

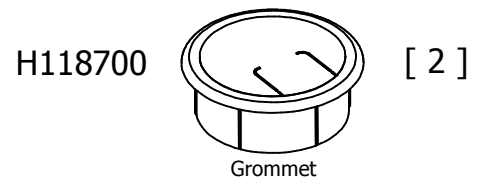
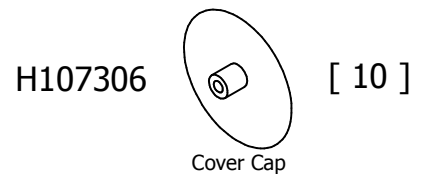

Have an assembly question or need a replacement part? Just call  
**1-800-950-4782**, we are here to help.

## WC72431

A	[ 1 ]	W195414
B	[ 2 ]	W186431
D	[ 1 ]	W177030

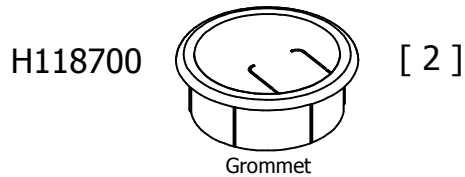
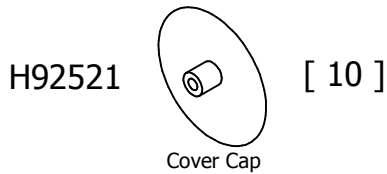

## SCD260WH

A	[ 1 ]	W184341
B	[ 2 ]	W191867
D	[ 1 ]	W191870

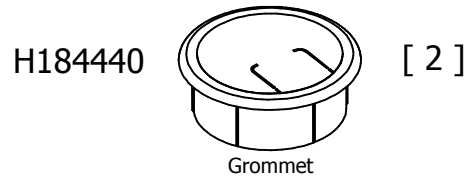
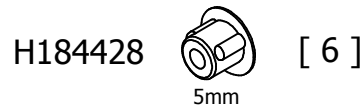
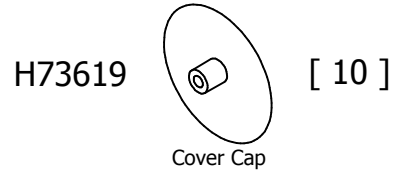

## SCD260SG

A	[ 1 ]	W184387
B	[ 2 ]	W189354
D	[ 1 ]	W189319

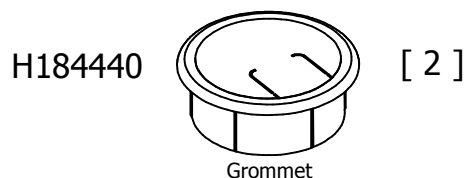
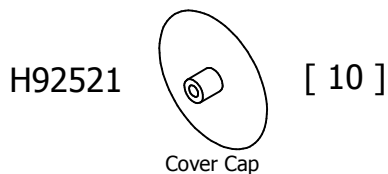

## SCD260PG

A	[ 1 ]	W191640
B	[ 2 ]	W191641
D	[ 1 ]	W191636

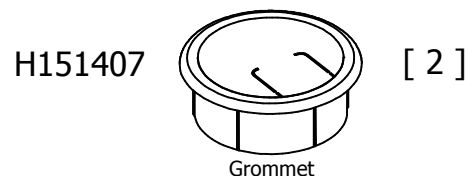
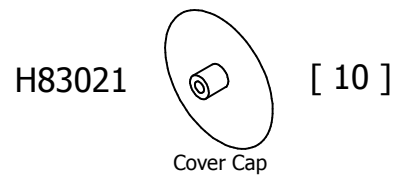

Have an assembly question or need a replacement part? Just call  
**1-800-950-4782**, we are here to help.

## SCD260CS

- A [ 1 ] W189698
- B [ 2 ] W189699
- D [ 1 ] W189695

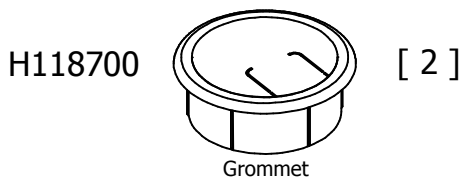
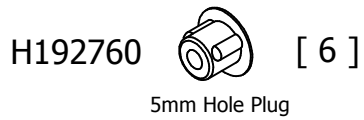
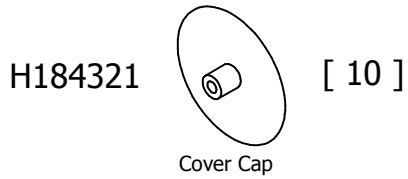

## SCD260AC

- A [ 1 ] W189743
- B [ 2 ] W189744
- D [ 1 ] W189740

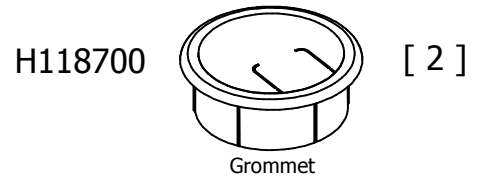
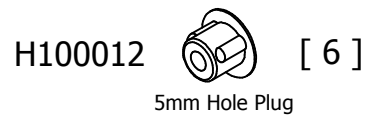
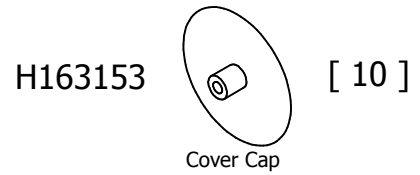

## SCD260SO

- A [ 1 ] W192820
- B [ 2 ] W192821
- D [ 1 ] W192817

