







**IMPORTANT NOTICE:
HARDWARE PACKAGE IS ATTACHED
ON THE BOTTOM OF SEAT CUSHION.**

MODEL : B516C

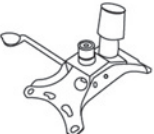
(1)x1		(2)x5	
 Cushion		 Caster	
(3)x1	(4)x1	(5)x1	
 Mechanism	 Gas Lift	 Base	
(A)x4		 M8x22 MECHANISM SCREW	

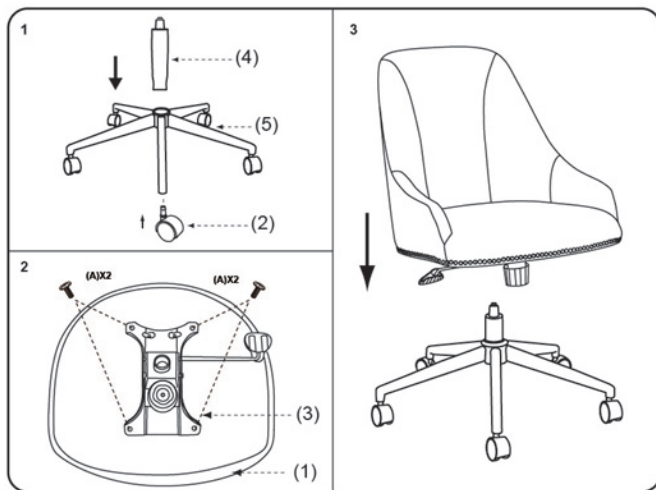

Insert and loosely tighten all screws. When assembly is completed, fully tighten all screws before using. This chair is only intended for sitting. Any other use will void the warranty.

