







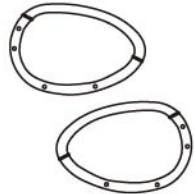
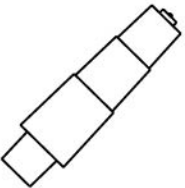

**Please unscrew all hardware from cushion before assembly.**  
**Por favor de destornillar todos los tornillos del cojín antes de ensamblar la silla.**

**MODEL : 6406**

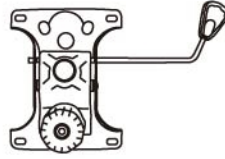
(1)x1  Back Cushion	(2)x1  Seat Cushion	(3)x1 (L)x1 (R)  Left-Arm-L Right-Arm-R
(4)x1  Gas Lift W/ Cover	(5)x1  Base	(6)x1  Mechanism
(7)x5  Caster		

- (A)x4  **M8 X 22 Mechanism Screws**
- (B)x8  **M6 X 25 Arm Screws**
- (C)x1  **ALLEN KEY (Provided in separate bag)**

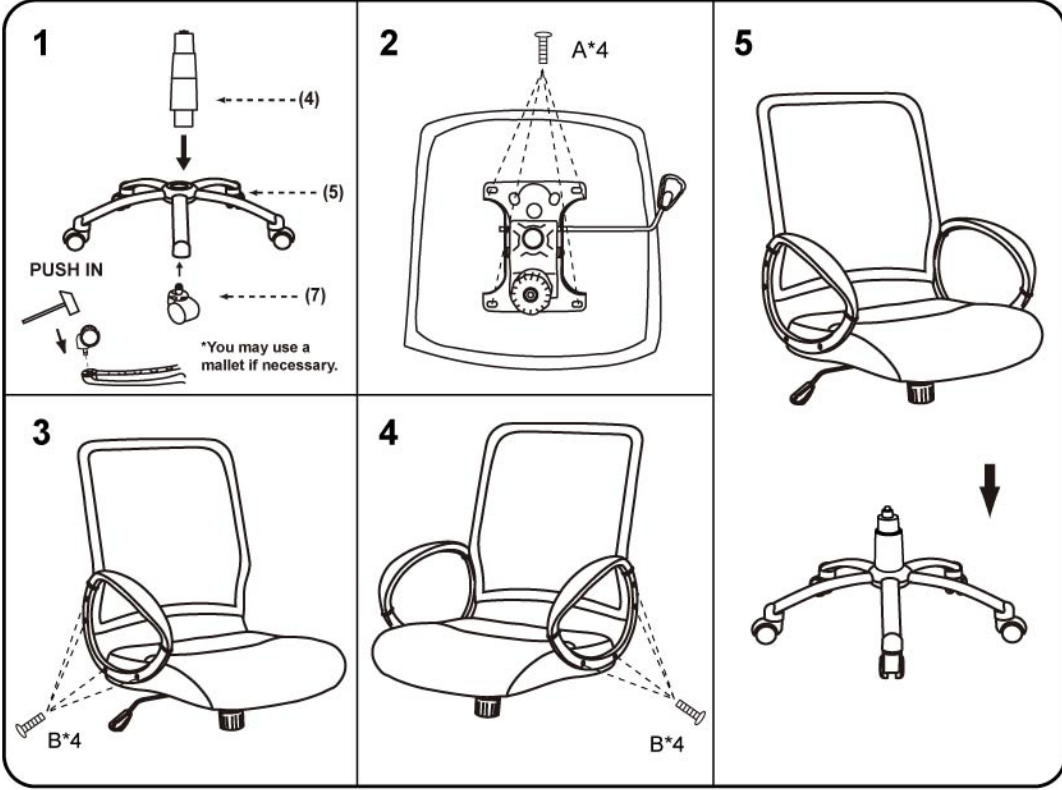

**Insert and loosely tighten all screws. When assembly is completed, fully tighten all screws before using. This chair is only intended for sitting. Any other use will void the warranty.**

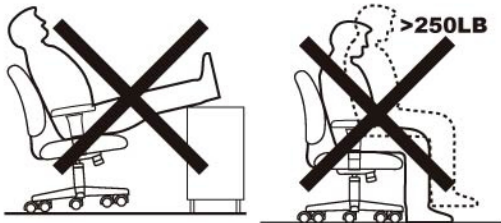

**Customer Service Hotline: 1-800-593-1888**  
**For further assembly instructions,**  
**please visit our website at [www.bosschair.com](http://www.bosschair.com)**

