

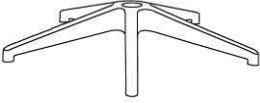





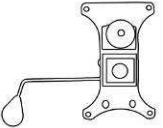
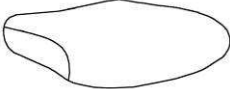
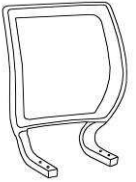

VL521 Assembly Instruction

(A) Caster x 5PCS 	(B) Base x 1PC 
(C) Gas Lift x 1PC 	(D) Seat Plate x 1PC 
(E) Seat Cushion x 1PC 	(F) Back Cushion x 1PC 
(G) Left Armrest x 1PC 	(H) Right Armrest x 1PC 
(I) Flat Washer x 14PCS 	(J) Screws for armrest inner holes and seat plate rear holes D5/16" x L1-1/10" x 4PCS 
(K) Screws for seat plate front holes D5/16" x L1-1/4" x 2PCS 	(L) Screws for armrest outer holes D5/16" x L1-1/2" x 4PCS 
(M) Screws for back cushion to seat cushion D5/16" x L1-3/4" x 4PCS 	(N) Allen Wrench x 1PC 

ATTENTION: Make sure all bolts and screws are fully tightened before using chair. Lubricate all moving parts and tighten all bolts/screws every 6 month or whenever needed.

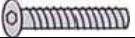
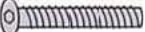
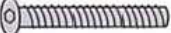
Step 1: Turn Base (B) upside down. Insert Caster (A) to Base (B).

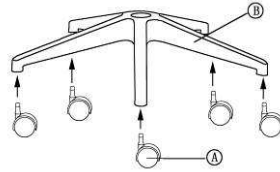

Step 2: Insert Gas Lift (C) to Base (B).

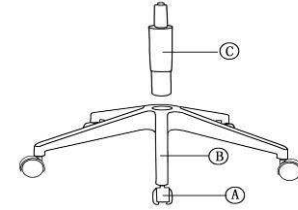

Step 3: Attach Left and Right Armrest (G/H) to Seat Cushion (E) by using Screws (J) for inner holes, Screws (L) for outer holes, Flat Washer (I) and Allen Wrench (N).

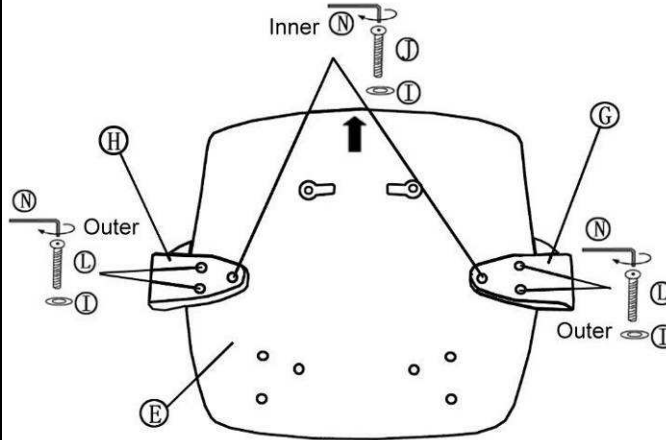

Step 4: Attach Seat Plate (D) to Seat Cushion (E) by using Screws (J) for rear holes, Screw (K) for front holes, Flat Washer (I) and Allen Wrench (N).

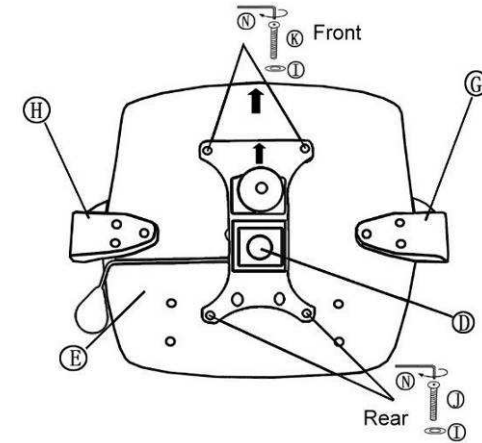



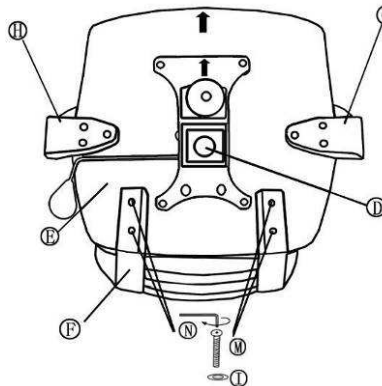



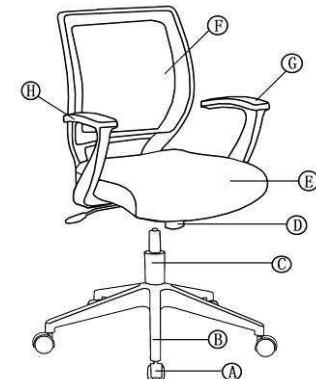



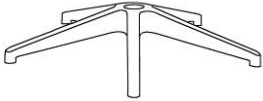

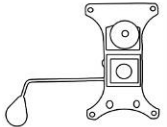
Step 5: Attach Back Cushion (F) to Seat Cushion (E) by using Screws (M), Flat Washer (I) and Allen Wrench (N).



Step 6: Put Seat/Back assembly to top of Gas Lift (C) by aligning hole in center of Seat Plate (D). Complete.

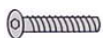
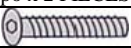

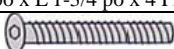
VL521 Instructions d'assemblage

(A) Roulette x 5 PIÈCES	(B) Socle x 1 PIÈCE
	
(C) Vérin à gaz x 1 PIÈCE	(D) Assise du siège x 1 PIÈCE
	
(E) Coussin de siège x 1 PIÈCE	(F) Coussin de dossier x 1 PIÈCE
	
(G) Accoudoir gauche x 1 PIÈCE	(H) Accoudoir droit x 1 PIÈCE
	
(I) Rondelle plate x 14 PIÈCES	(J) Vis pour les trous intérieurs d'accoudoir et l'assise du siège trous arrière D 5/16 po x L 1-1/10 po x 4 PIÈCES
	
(K) Vis pour l'assise du siège trous avant D 5/16 po x L 1-1/4 po x 2 PIÈCES	(L) Vis pour les trous extérieurs d'accoudoir D 5/16 po x L 1-1/2 po x 4 PIÈCES
	
(M) Vis entre le coussin de dossier et le coussin de siège D 5/16 po x L 1-3/4 po x 4 PIÈCES	(N) Clé Allen x 1 PIÈCE
	

ATTENTION : S'assurer que tous les boulons et vis sont serrés à fond avant d'utiliser la chaise. Lubrifier toutes les pièces mobiles et serrer tous les boulons/vis tous les 6 mois ou selon le besoin.

Étape 1 : Mettre le socle (B) à l'envers. Introduire la roulette (A) dans le socle (B).

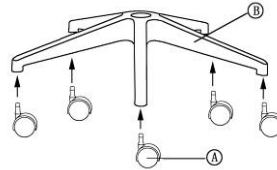

Étape 2 : Introduire le vérin à gaz (C) dans le socle (B).

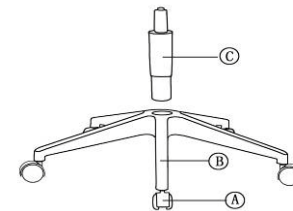

Étape 3 : Fixer les accoudoirs de gauche et de droite (G/H) sur le coussin de siège (E) à l'aide des vis (J) pour les trous intérieurs, des vis (L) pour les trous extérieurs, de la rondelle plate (I) et de la clé Allen (N).

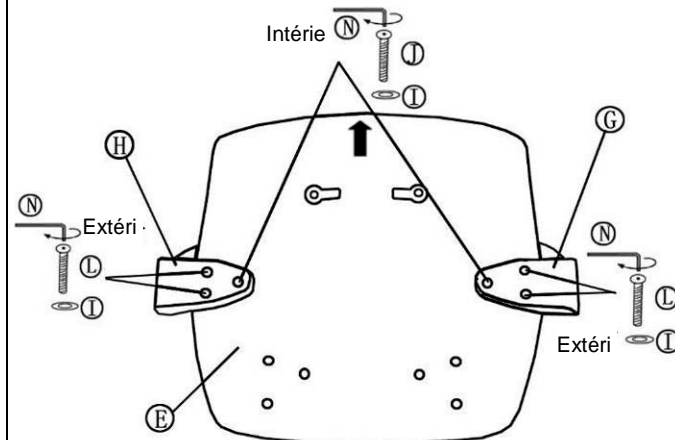

Étape 4 : Fixer l'assise du siège (D) sur le coussin de siège (E) à l'aide des vis (J) pour les trous arrière, des vis (K) pour les trous avant, de la rondelle plate (I) et de la clé Allen (N).

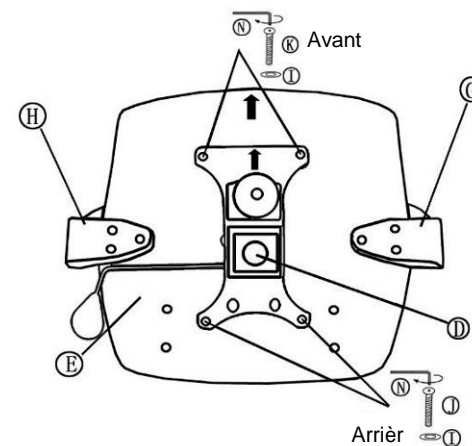

Étape 5 : Fixer le coussin de dossier (F) sur le coussin de siège (E) à l'aide des vis (M), de la rondelle plate (I) et de la clé Allen (N).

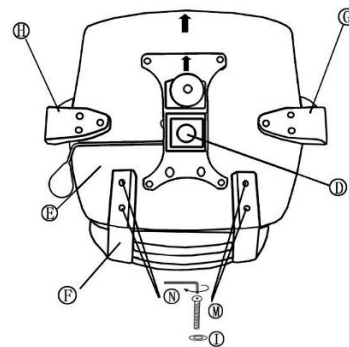

Étape 6 : Poser l'ensemble siège/dossier sur le haut du vérin à gaz (C) en alignant le trou au centre de l'assise du siège (D). Terminé.

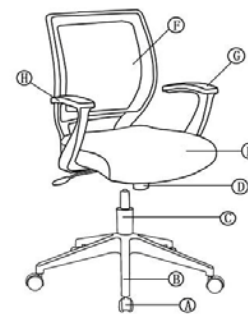

Instrucciones de armado de VL521

(A) Rueda orientable x 5 PIEZAS	(B) Base x 1 PIEZA
(C) Cilindro de regulación de altura a gas x 1 PIEZA	(D) Placa de asiento x 1 PIEZA
(E) Cojín de asiento x 1 PIEZA	(F) Cojín de respaldo x 1 PIEZA
(G) Apoyabrazos izquierdo x 1 PIEZA	(H) Apoyabrazos derecho x 1 PIEZA
(I) Arandela plana x 14 PIEZAS	(J) Tornillos para agujeros interiores de apoyabrazos y agujeros traseros de placa de asiento 5/16 pulg diám. x 1-1/10 pulg largo x 4 PIEZAS
(K) Tornillos para agujeros delanteros de placa de asiento 5/16 pulg diám. x 1-1/4 pulg largo x 2 PIEZAS	(L) Tornillos para agujeros exteriores de apoyabrazos 5/16 pulg diám. x 1-1/2 pulg largo x 4 PIEZAS
(M) Tornillos para cojín de respaldo a cojín de asiento 5/16 pulg diám. x 1-3/4 pulg largo x 4 PIEZAS	(N) Llave Allen x 1 PIEZA

ATENCIÓN: Asegúrese que todos los pernos y tornillos estén completamente apretados antes de usar la silla. Lubrique todas las piezas móviles y apriete todos los pernos/tornillos cada 6 meses o como sea necesario.

Paso 1: Invierta la base (B). Inserte la rueda orientable (A) en la base (B).

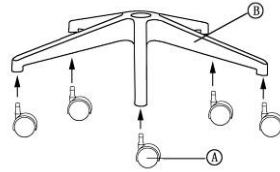

Paso 2: Inserte el cilindro de regulación de altura a gas (C) en la base (B).

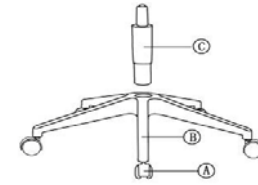

Paso 3: Fije los apoyabrazos izquierdo y derecho (G/H) al cojín de asiento (E) usando los tornillos (J) para los agujeros interiores, los tornillos (L) para los agujeros exteriores, arandela plana (I) y llave Allen (N).

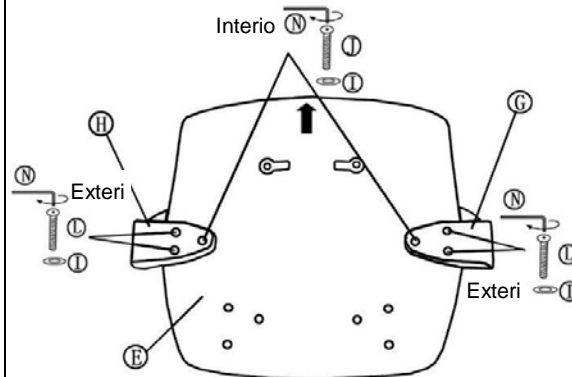

Paso 4: Fije la placa de asiento (D) al cojín de asiento (E) usando los tornillos (J) para los agujeros traseros, tornillo (K) para los agujeros delanteros, arandela plana (I) y llave Allen (N).

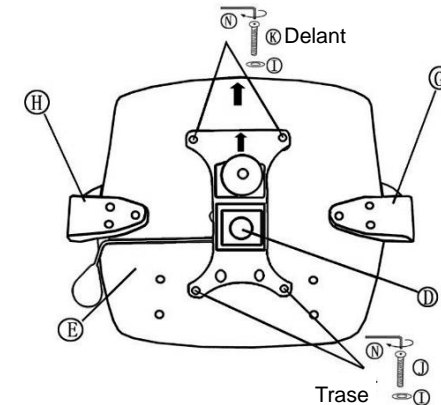

Paso 5: Fije el cojín de respaldo (F) al cojín de asiento (E) usando los tornillos (M), arandela plana (I) y llave Allen (N).

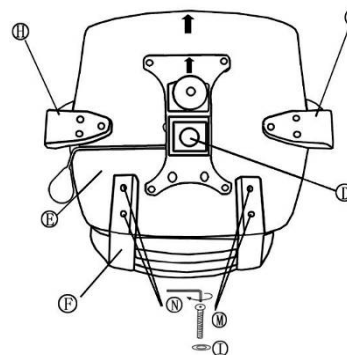

Paso 6: Coloque el conjunto de asiento/respaldo en la parte superior del cilindro de regulación de altura a gas (C) alineando el agujero en el centro de la placa de asiento (D). Terminada.

