



USER GUIDE

6.1.0 | August 2019 | 3725-48813-004A

Polycom[®] VVX[®] Business IP Phones



Copyright© 2019, Polycom, Inc. All rights reserved. No part of this document may be reproduced, translated into another language or format, or transmitted in any form or by any means, electronic or mechanical, for any purpose, without the express written permission of Polycom, Inc.

6001 America Center Drive
San Jose, CA 95002
USA

Trademarks Polycom®, the Polycom logo and the names and marks associated with Polycom products are trademarks and/or service marks of Polycom, Inc. and are registered and/or common law marks in the United States and various other countries.



All other trademarks are property of their respective owners. No portion hereof may be reproduced or transmitted in any form or by any means, for any purpose other than the recipient's personal use, without the express written permission of Polycom.

End User License Agreement By installing, copying, or otherwise using this product, you acknowledge that you have read, understand and agree to be bound by the terms and conditions of the End User License Agreement for this product. The EULA for this product is available on the Polycom Support page for the product.

Patent Information The accompanying product may be protected by one or more U.S. and foreign patents and/or pending patent applications held by Polycom, Inc.

Open Source Software Used in this Product This product may contain open source software. You may receive the open source software from Polycom up to three (3) years after the distribution date of the applicable product or software at a charge not greater than the cost to Polycom of shipping or distributing the software to you. To receive software information, as well as the open source software code used in this product, contact Polycom by email at OpenSourceVideo@polycom.com (for video products) or OpenSourceVoice@polycom.com (for voice products).

Disclaimer While Polycom uses reasonable efforts to include accurate and up-to-date information in this document, Polycom makes no warranties or representations as to its accuracy. Polycom assumes no liability or responsibility for any typographical or other errors or omissions in the content of this document.

Limitation of Liability Polycom and/or its respective suppliers make no representations about the suitability of the information contained in this document for any purpose. Information is provided "as is" without warranty of any kind and is subject to change without notice. The entire risk arising out of its use remains with the recipient. In no event shall Polycom and/or its respective suppliers be liable for any direct, consequential, incidental, special, punitive or other damages whatsoever (including without limitation, damages for loss of business profits, business interruption, or loss of business information), even if Polycom has been advised of the possibility of such damages.

Customer Feedback We are striving to improve our documentation quality and we appreciate your feedback. Email your opinions and comments to DocumentationFeedback@polycom.com.

Polycom Support Visit the [Polycom Support Center](#) for End User License Agreements, software downloads, product documents, product licenses, troubleshooting tips, service requests, and more.

Contents

Before You Begin.....	10
Audience, Purpose, and Required Skills.....	10
Related Documentation.....	10
Getting Started with Poly VVX® Business IP Phones.....	11
Overview of Phone Hardware and Keys.....	11
VVX 150 Hardware.....	11
VVX 250 Hardware.....	13
VVX 350 Hardware.....	15
VVX 450 Hardware.....	17
Securing Your Phone with the Security Slot.....	19
Accessing Screens on VVX Business IP Phones	19
Access the Main Menu.....	20
Access the Calls Screen.....	20
Access the Lines Screen.....	21
Switch Among Phone Screens.....	21
Icons and Status Indicators on VVX Business IP Phones.....	22
Entering Information in Data Fields.....	23
Entering Information Using the Dial Pad.....	23
Entering Chinese Characters with PinYin.....	24
Logging in to and Locking Your Phone.....	26
Logging in to Poly VVX® Business IP Phones.....	26
Log In to a Phone.....	26
Log Out of the Phone.....	27
Change Your Login Password.....	27
Log In to a Visitor Desk Phone.....	27
Log Out of a Visitor Desk Phone.....	27
Log In to a Host Phone.....	28
Log Out of a Host Phone.....	28
Log In to a Guest ACD Phone.....	29
Log Out of a Guest ACD Phone.....	29
Sign In Using Your BroadSoft UC-One Credentials.....	29
Locking Your Phone.....	29
Lock Your Phone.....	30
Unlock the Phone.....	30
Change Your User Password.....	31

Audio Calls.....	32
Placing and Answering Audio Calls.....	32
Placing Audio Calls.....	33
Redial a Number.....	36
Redial a Contact when the Contact is Available.....	36
Answering Audio Calls.....	37
Switch Among the Handset, Headset, and Speakerphone.....	39
Mute and Unmute Audio.....	39
Holding and Resuming Calls.....	39
Hold a Call.....	39
Resume a Call.....	40
Resume a Call on an Expansion Module.....	40
Ending Calls.....	40
End an Active Audio Call.....	40
End a Held Call.....	40
Transferring Calls.....	40
Choose a Default Transfer Type.....	41
Transfer a Call.....	41
Cancel a Transfer.....	41
Parking and Retrieving Calls on the BroadSoft BroadWorks Server.....	41
Park a BroadSoft Call.....	42
Retrieve a Parked BroadSoft Call.....	42
Retrieve a Parked BroadSoft Call on Another Phone.....	42
Ignore a Parked Call.....	43
Managing Calls.....	43
Display Calls from the Lines Screen.....	43
Display Calls from the Calls Screen.....	44
Manage a Call from the Calls Screen.....	44
Managing Calls Remotely.....	44
Managing Calls with BroadSoft UC-One BroadWorks Anywhere.....	44
Managing Calls with BroadSoft UC-One Remote Office.....	46
Ignoring or Rejecting Incoming Calls.....	47
Ignore or Silence an Incoming Call.....	47
Reject Incoming Calls.....	47
Reject Calls from a Contact.....	47
Rejecting Calls with Do Not Disturb.....	47
Reject Anonymous Calls.....	49
Redirecting Incoming Calls.....	49
Forwarding Incoming Calls to a Contact.....	49
Divert Calls to a Contact.....	50

Call Precedence and Preemption.....	50
Conference Calls.....	52
Tips for Conference Calls.....	52
Audio Conference Calls.....	52
Initiate a Conference Call.....	52
Join Calls to Create a Conference Call.....	53
End a Conference Call.....	53
Hold a Conference Call.....	53
Resume a Conference Call.....	53
Split a Conference Call.....	53
Manage Conference Call Participants.....	54
Alcatel-Lucent Advanced Conference Calls.....	54
Initiate an Advanced Conference Call.....	54
Initiate an Advanced Conference Call During a Call.....	55
Add Contacts to an Advanced Conference Call.....	55
Add Incoming Calls to an Advanced Conference Call.....	55
Join Two Calls into an Advanced Conference Call.....	55
Viewing a Roster of Conference Participants.....	56
Managing Advanced Conference Participants.....	56
Shared Lines.....	57
Shared Line Limitations.....	57
Answering Calls on Shared Lines.....	57
Missed and Received Calls on Shared Lines.....	57
Hold a Call Privately on a Shared Line.....	58
Barge In on Calls for Busy Lamp Field Lines.....	58
Access the Call Actions for BroadWorks Dynamic Busy Lamp Field (BLF).....	59
Ribbon Communications Multiple Appearance Directory Number - Single Call Appearance.....	59
Placing a MADN Call.....	59
Answering a MADN Call.....	60
Barge In on an Active Call.....	60
Leave a Bridge Call.....	60
Resume a Held MADN Call.....	60
Enabling Privacy for MADN Calls.....	61
Alcatel-Lucent Shared Call Appearance.....	62
Placing a SCAP Call.....	62
Answering a SCAP Call.....	62
Bridge In to an Active SCAP Call.....	62
Leave a Bridge SCAP Call.....	63

Make an Active SCAP Call Public.....	63
Make an Active SCAP Call Private.....	63
Holding or Passing SCAP Calls.....	63
BroadSoft UC-One Simultaneous Ring.....	64
Create a Personal Ring Group.....	64
Add Numbers to Your Simultaneous Ring List.....	64
Delete Numbers from the Simultaneous Ring List.....	65
BroadSoft Executive-Assistant.....	65
Executive Options.....	65
Assistant Options.....	66
Pick Up a Held Executive Call on a Shared Line.....	67
Pick Up a Held Executive Call on a Private Line.....	68
Barge In on an Executive Call.....	68
Recording Audio Calls.....	69
Guidelines when Recording Calls.....	69
Record a Call.....	70
Manage a Call while Recording.....	70
Pause a Recording.....	70
Resume a Recording.....	70
Stop Recording.....	70
Record a Conference Call.....	71
Browse Recorded Calls.....	71
Play a Recorded Call.....	71
Pause and Resume Played Recordings.....	72
Stop Playing a Recording.....	72
Rename a Recording.....	72
Delete a Recording.....	72
Call Lists and Directories.....	73
Recent Calls.....	73
View Recent Calls.....	73
Sort Recent Call Entries.....	73
Sort Entries by Call Type.....	74
View Call Details.....	74
Edit a Recent Call Entry.....	74
Delete a Recent Call Entry.....	74
Save a Recent Call Entry.....	74
Contact Directory.....	75
Search for a Contact in the Contact Directory.....	75
Add a Contact to the Contact Directory.....	75

View Contact Information.....	76
Update a Contact's Information.....	76
Delete a Contact from the Contact Directory.....	76
Corporate Directory.....	76
Searching the Corporate Directory.....	76
Add Corporate Directory Contacts to the Contact Directory.....	77
BroadSoft Directories on Poly VVX® Business IP Phones.....	78
View a List of BroadSoft Contacts.....	78
Searching the BroadSoft Directory.....	78
Add BroadSoft Contacts to the Contact Directory.....	79
Managing a Personal BroadSoft Directory.....	79
Managing the Ribbon Communications Address Books.....	80
Using the Global Address Book.....	80
Using the Personal Address Book.....	81
Favorites and Contact Lists.....	84
Managing Favorites.....	84
Add Favorites.....	84
Viewing Favorites.....	84
Reorder Favorites.....	85
Delete Favorites.....	85
Using Buddy Lists.....	85
Add Contacts to Your Buddy List.....	85
View Your Buddy List.....	86
Monitor Contacts on Your Buddy List.....	86
View Your Watcher List.....	87
Block Contacts from Viewing Your Status.....	87
View a List of Blocked Contacts.....	87
Unblock a Contact.....	87
Managing BroadSoft UC-One Favorites and Contacts.....	87
BroadSoft UC-One Contacts' Presence Information.....	88
Viewing BroadSoft UC-One Contacts and Favorites.....	88
View Aggregated Self-Presence for BroadSoft Lines.....	89
Filter BroadSoft UC-One Favorites.....	89
Search for BroadSoft UC-One Contacts.....	89
Accessing, Sending, and Broadcasting Messages.....	91
Accessing Voice Messages.....	91
Access Voicemail Messages.....	91
Remove the Message Alert.....	92
Instant Messaging.....	92

Send Instant Messages.....	92
Read Instant Messages.....	92
Reply to Instant Messages.....	93
Delete Instant Messages.....	93
Broadcasting Messages with Group Paging.....	93
Send a Group Page.....	93
Receiving Pages.....	94
Group Paging Settings.....	95
Broadcasting Messages with Push to Talk.....	95
Send a PTT Broadcast.....	96
Receiving PTT Broadcasts.....	97
Reply to PTT Broadcasts.....	97
End PTT Broadcasts.....	97
Push To Talk Settings.....	98
Phone Applications.....	100
Using the Calendar.....	100
Open the Calendar.....	100
Navigate Day View.....	100
Navigate to Other Views.....	101
Navigate Month View.....	101
Display Meeting View on the Calendar.....	101
Return to Day View.....	101
Meeting Reminders.....	101
Joining Calendar Meetings.....	103
Navigating the Web and Idle Browsers.....	103
View the Idle Browser.....	104
Open the Web Browser.....	104
Customizing the Font Size.....	104
Change the Font Size.....	105
Connecting to a Wireless Network.....	106
Add a Wireless Network.....	106
Enable Wireless Network Connectivity.....	106
Connect to a Secured Wireless Network.....	107
Disconnect from a Wireless Network.....	107
Remove a Wireless Network.....	107
Poly VVX[®] Business IP Phones Settings.....	108
Password Required to Access Basic Settings.....	108

Choose a Theme for Your Phone.....	108
Set the Language.....	109
Disable Call Waiting.....	109
Time and Date Display.....	110
Change the Time and Date Format.....	110
Disable the Time and Date Display.....	110
Backlight Intensity and Timeout.....	110
Set the Backlight Intensity.....	111
Set the Backlight Timeout.....	111
Changing Your Background.....	111
Change the Background Picture.....	111
Adding Personal Photos as Your Background.....	112
Reset Your Background.....	113
Screen Savers.....	113
Enable Screen Savers.....	113
Use Personal Photos as Screen Savers.....	114
Disable the Screen Saver.....	115
Use Your Phone as a Digital Picture Frame.....	115
Picture Frame Icons.....	115
Power-Saving Mode.....	116
Change Your Office Hours for Power-Saving Mode.....	116
Change Idle Timeouts for Power-Saving Mode.....	117
Changing Audio Settings.....	117
Change Incoming Call Notifications.....	117
Set a Ringtone for Incoming Calls.....	117
Set a Ringtone for Individual Contacts.....	118
Change the Volume.....	118
Enable Acoustic Fence.....	118
Updating Your Buddy Status.....	118
Update Your Buddy Status.....	119
Automatically Update Your Buddy Status.....	119
Security Classification.....	119
View the Security Classification for Your Phone.....	119
Modify Security Classification Level.....	120
Clear Call Logs and Contacts.....	120
Restrict Call Log and Contact Uploads.....	120
Plantronics Headset Settings.....	120
Set the Answering Call Alert.....	121
Set the Mute On or Off Alert.....	121
Set the Mute Reminder.....	121
Set the Mute Reminder Interval.....	122
Set the Volume Level Indicator Tones.....	122

Adjust the Headset Speaker Bass and Treble.....	122
View Voice Visual Feedback.....	123
Record and Play the call.....	123
Adjust the Microphone Gain.....	123
Set the Dial Tone.....	124
Set the Decibel Spike Limit.....	124
Set the Decibel Threshold Limit.....	124
Set the Hours on Phone Per Day.....	124
Restore Default Settings.....	125
Features Compatibility Chart.....	125
Phone Accessories and Computer Applications.....	126
Using a Headset with Your Phone.....	126
Connecting a Headset.....	126
Use Your Headset for All Calls.....	127
Reactivate Headset Memory Mode.....	127
Using Electronic Hookswitch.....	127
Disconnect Your Headset.....	129
Controlling Your Phone with Polycom Desktop Connector.....	129
Setting Up and Enabling the Polycom Desktop Connector.....	129
Using the Polycom Desktop Connector.....	131
Polycom VVX EM50 Expansion Modules.....	134
VVX EM50 Expansion Module Hardware Features.....	134
Connect a VVX EM50 Expansion Module.....	136
Disconnect a VVX EM50 Expansion Module.....	137
Connect an Additional VVX EM50 Expansion Module.....	137
Disconnect an Additional VVX EM50 Expansion Module.....	138
Assigning Contacts and Favorites to VVX EM50 Expansion Modules.....	139
Assign Favorites to Expansion Modules.....	139
Identify Line Key Assignments.....	139
Navigate Expansion Module Paging.....	140
Smart Paging on VVX EM50 Expansion Modules.....	140
Alternate Paging.....	141
Changing the Backlight Intensity on the Expansion Module.....	141
Accessibility Features.....	142
Features for Hearing-Impaired Users.....	142
Features for Mobility-Impaired Users.....	143
Features for Vision-Impaired and Blind Users.....	144

Maintaining Poly VVX® Business IP Phones.....	145
Investigate Warnings.....	145
Remove Warnings.....	145
Restart Your Phone.....	146
Update the Phone's Configuration	146
Test the Hardware.....	146
Cleaning the Screen.....	147
View Software Details.....	147
Updating the Phone Software.....	147
Update the Phone Software.....	147
Update Software Later.....	147
Postpone Software Updates.....	148
Exit the Software Update Notification.....	148
Troubleshooting.....	149
Speakerphone.....	149
USB Port.....	149
Check the Status of the Calendar.....	149
Ribbon Communications Address Book.....	150
View the Status of the Personal Address Book.....	150
Polycom Desktop Connector.....	150
Troubleshoot Audio and Echo Issues.....	151
Recording Issues and Solutions.....	151
Reset the Phone to Factory Defaults.....	152
Using an Approved Power Source.....	152

Before You Begin

Topics:

- [Audience, Purpose, and Required Skills](#)
- [Related Documentation](#)

This *Poly VVX Business IP Phones User Guide* contains overview information for navigating and performing tasks on Poly VVX® Business IP Phones.

This user guide contains information for the following Polycom® VVX® products and accessories:

- VVX 150 business IP phones
- VVX 250 business IP phones
- VVX 350 business IP phones
- VVX 450 business IP phones
- VVX EM50 expansion module

Audience, Purpose, and Required Skills

This guide is intended for beginning users, as well as intermediate and advanced users, who want to learn more about the features available with VVX business IP phones.

Related Documentation

You can view the following types of documents on each product support page on [Polycom Voice Support](#):

- Quick Tips—A quick reference on how to use the phone's most basic features.
- Setup Sheet—This guide describes the contents of your package, how to assemble the phone or accessory, and how to connect the phone to the network. This guide is included in your phone package.
- Wallmount Instructions—This document provides detailed instructions for mounting your phone on the wall. To install your phone on the wall, you need the optional wallmount package, which includes the wallmount instructions.
- Administrator Guide—This guide provides detailed information about setting up your network and configuring features.
- Regulatory Notice—This guide provides information for all regulatory and safety guidance.

You can also view Feature Descriptions and Technical Notifications that describe workarounds to existing issues and provide expanded descriptions and examples for phone settings and features. You can find these documents on the [Polycom Profiled UC Software Features](#) and [Polycom Engineering Advisories and Technical Notifications](#) support pages.

Getting Started with Poly VVX[®] Business IP Phones

Topics:

- [Overview of Phone Hardware and Keys](#)
- [Accessing Screens on VVX Business IP Phones](#)
- [Icons and Status Indicators on VVX Business IP Phones](#)
- [Entering Information in Data Fields](#)

Before you use your phone, take a few moments to familiarize yourself with its features and user interface.

The terms “the phone” and “your phone” refer to any of the VVX business IP phones. Unless specifically noted in this guide, especially with regard to phone graphics, all phone models operate in similar ways.

Note: As you read this guide, keep in mind that your system administrator configures certain features or your network environment may determine them. As a result, some features may not be enabled or may operate differently on your device. Additionally, the examples and graphics in this guide may not directly reflect available options or what your device screen displays.

Overview of Phone Hardware and Keys

Use the following figures and tables to understand hardware features available on VVX business IP phones. For more information about attaching phone hardware, including how to connect your phone to the network, see the Setup Sheet for your phone available on your phone's support page on [Polycom Voice Support](#).

Related Links

[VVX EM50 Expansion Module Hardware Features](#) on page 134

VVX 150 Hardware

The following figure displays the hardware features on the VVX 150 business IP phones. The table lists each feature numbered in the figure.

Figure 1: VVX 150 hardware features

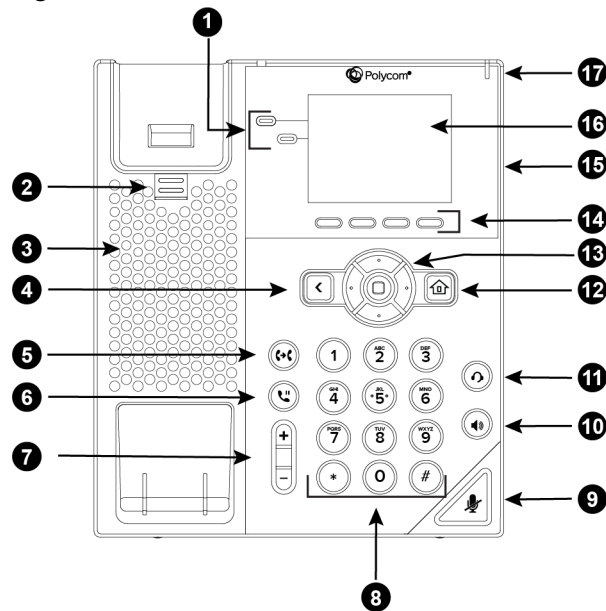

VVX 150 Hardware Feature Descriptions

Reference Number	Feature	Feature Description
1	Line keys	Enable you to select a phone line, view calls on a line, or quickly call a favorite contact.
2	Reversible tab	Secures the handset in the cradle when your phone stand is positioned at a high angle. To secure the handset, remove the tab, reverse it so the protrusion points up, and re-insert it. Position the handset so the protrusion on the tab fits into the slot on the handset.
3	Speaker	Provides ringer and speakerphone audio output.
4	Back key	Enables you to return to the previous screen.
5	Transfer key	Transfers an active call to a contact.
6	Hold key	Holds an active call or resumes a held call.
7	Volume keys	Adjust the volume of the handset, headset, speaker, and ringer.
8	Dial pad	Enables you to enter numbers, letters, and special characters. You can also use the dial pad keys to select menu items that have index numbers.
9	Mute key	Mutes local audio during calls and conferences.

Reference Number	Feature	Feature Description
10	Speakerphone key	Enables you to place and receive calls using the speakerphone.
11	Headset key	Enables you to place and receive calls through a headset.
12	Home key	Displays the Home screen from other screens and displays the Lines and Calls screen from the Home screen.
13	Navigation keys / Select key	Scrolls through information or options displayed on the phone's screen. Selects a field of displayed data.
14	Soft keys	Enable you to select context sensitive keys that display along the bottom of the screen.
15	Security slot (on back)	Enables you to attach a universal security cable lock to your phone so you can secure it to a desktop.
16	Screen	Shows a 6.35 cm (2.5-inch) monochrome display that enables you to view menu options and data.
17	Message Waiting Indicator	Flashes red to indicate when you have new messages.

VVX 250 Hardware

The following figure displays the hardware features on VVX 250 business IP phones. The table lists each feature numbered in the figure.

Figure 2: VVX 250 hardware features

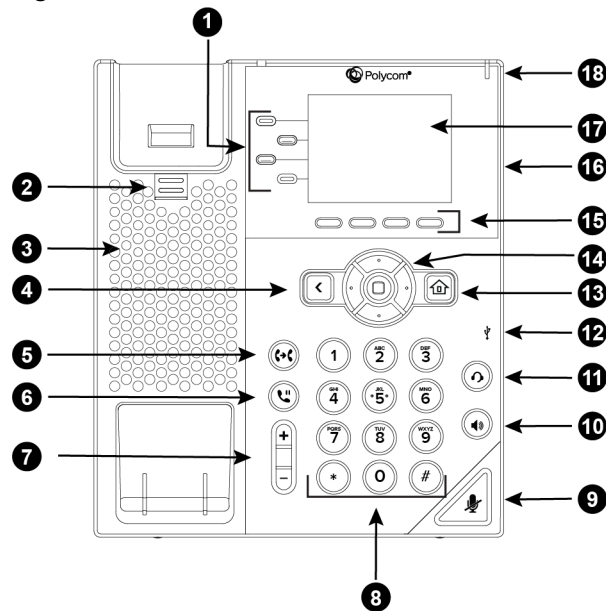

VVX 250 Hardware Features

Reference Number	Feature	Feature Description
1	Line keys	Enable you to select a phone line, view calls on a line, or quickly call a favorite contact.
2	Reversible tab	Secures the handset in the cradle when your phone stand is positioned at a high angle. To secure the handset, remove the tab, reverse it so the protrusion points up, and re-insert it. Position the handset so the protrusion on the tab fits into the slot on the handset.
3	Speaker	Provides ringer and speakerphone audio output.
4	Back key	Enables you to return to the previous screen.
5	Transfer key	Transfers an active call to a contact.
6	Hold key	Holds an active call or resumes a held call.
7	Volume keys	Adjust the volume of the handset, headset, speaker, and ringer.
8	Dial pad	Enables you to enter numbers, letters, and special characters. You can also use the dial pad keys to select menu items that have index numbers.
9	Mute key	Mutes local audio during calls and conferences.

Reference Number	Feature	Feature Description
10	Speakerphone key	Enables you to place and receive calls using the speakerphone.
11	Headset key	Enables you to place and receive calls through a headset.
12	USB Port	Enables you to attach a USB flash drive or USB headset.
13	Home key	Displays the Home screen from other screens and displays the Lines and Calls screen from the Home screen.
14	Navigation keys / Select key	Scrolls through information or options displayed on the phone's screen. Selects a field of displayed data.
15	Soft keys	Enable you to select context sensitive keys that display along the bottom of the screen.
16	Security slot (on back)	Enables you to attach a universal security cable lock to your phone so you can secure it to a desktop.
17	Screen	Shows a 7.1 cm (2.8 in) color display that enables you to view menu options and data.
18	Message Waiting Indicator	Flashes red to indicate when you have new messages.

VVX 350 Hardware

The following figure displays the hardware features on VVX 350 business IP phones. The table lists each feature numbered in the figure.

Figure 3: VVX 350 hardware features

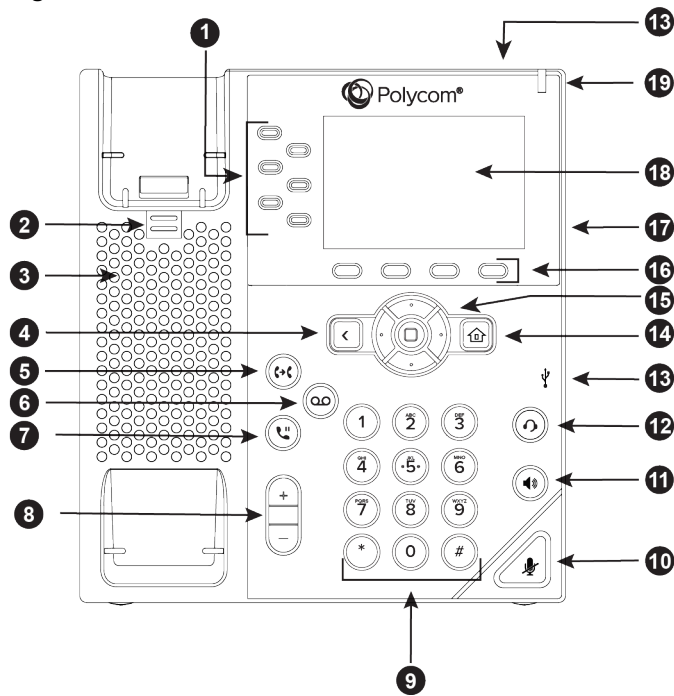

VVX 350 Hardware Feature Descriptions

Reference Number	Feature	Feature Description
1	Line keys	Enable you to select a phone line, view calls on a line, or quickly call a favorite contact.
2	Reversible tab	Secures the handset in the cradle when your phone stand is positioned at a high angle. To secure the handset, remove the tab, reverse it so the protrusion points up, and re-insert it. Position the handset so the protrusion on the tab fits into the slot on the handset.
3	Speaker	Provides ringer and speakerphone audio output.
4	Back key	Enables you to return to the previous screen.
5	Transfer key	Transfers an active call to a contact.
6	Messages key	Enables you to access and manage instant and voice messages.
7	Hold key	Holds an active call or resumes a held call.
8	Volume keys	Adjust the volume of the handset, headset, speaker, and ringer.

Reference Number	Feature	Feature Description
9	Dial pad	Enables you to enter numbers, letters, and special characters. You can also use the dial pad keys to select menu items that have index numbers.
10	Mute key	Mutes local audio during calls and conferences.
11	Speakerphone key	Enables you to place and receive calls using the speakerphone.
12	Headset key	Enables you to place and receive calls through a headset.
13	USB Port	Enables you to attach a USB flash drive or USB headset.
14	Home key	Displays the Home screen from other screens and displays the Lines and Calls screen from the Home screen.
15	Navigation keys / Select key	Scrolls through information or options displayed on the phone's screen. Selects a field of displayed data.
16	Soft keys	Enable you to select context sensitive keys that display along the bottom of the screen.
17	Security slot (on back)	Enables you to attach a universal security cable lock to your phone so you can secure it to a desktop.
18	Screen	Shows a 8.89 cm (3.5 in) color screen with a backlight that enables you to view menu options and data.
19	Message Waiting Indicator	Flashes red to indicate when you have new messages.

VVX 450 Hardware

The following figure displays the hardware features on VVX 450 business IP phones. The table lists each feature numbered in the figure.

Figure 4: VVX 450 hardware features

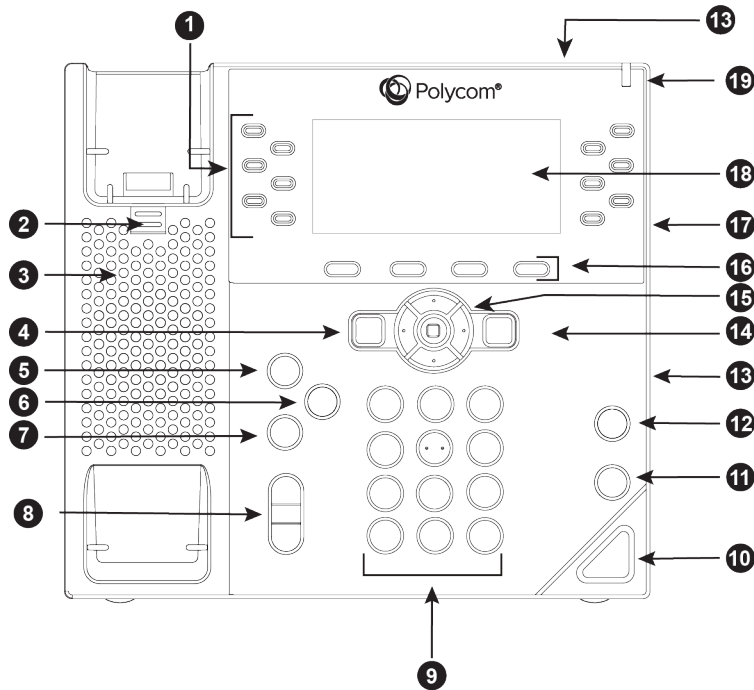

VVX 450 Hardware Feature Descriptions

Reference Number	Feature	Feature Description
1	Line keys	Enable you to select a phone line, view calls on a line, or quickly call a favorite contact.
2	Reversible tab	Secures the handset in the cradle when your phone stand is positioned at a high angle. To secure the handset, remove the tab, reverse it so the protrusion points up, and re-insert it. Position the handset so the protrusion on the tab fits into the slot on the handset.
3	Speaker	Provides ringer and speakerphone audio output.
4	Back key	Enables you to return to the previous screen.
5	Transfer key	Transfers an active call to a contact.
6	Messages key	Enables you to access and manage instant and voice messages.
7	Hold key	Holds an active call or resumes a held call.
8	Volume keys	Adjust the volume of the handset, headset, speaker, and ringer.

Reference Number	Feature	Feature Description
9	Dial pad	Enables you to enter numbers, letters, and special characters. You can also use the dial pad keys to select menu items that have index numbers.
10	Mute key	Mutes local audio during calls and conferences.
11	Speakerphone key	Enables you to place and receive calls using the speakerphone.
12	Headset key	Enables you to place and receive calls through a headset.
13	USB Port	Enables you to attach a USB flash drive or USB headset.
14	Home key	Displays the Home screen from other screens and displays the Lines and Calls screen from the Home screen.
15	Navigation keys / Select key	Scrolls through information or options displayed on the phone's screen. Selects a field of displayed data.
16	Soft keys	Enable you to select context sensitive keys that display along the bottom of the screen.
17	Security slot (on back)	Enables you to attach a universal security cable lock to your phone so you can secure it to a desktop.
18	Screen	Shows a 10.9 cm (4.3 in) color display with a backlight that enables you to view menu options and data.
19	Message Waiting Indicator	Flashes red to indicate when you have new messages.

Securing Your Phone with the Security Slot

By fastening one end of a universal security cable to a desk or table and the other end to the security slot available on VVX business IP phones, you can prevent your phone from being removed.

See the hardware figure for your phone for the location of the security slot . Refer to the universal security documentation for more information on securing your phone.

Accessing Screens on VVX Business IP Phones

You can access the following screens on your phone:

- Main Menu—Displays menu options for settings and device information.
- Calls Screen—Displays all active and held calls on your line.

- Lines Screen—Displays your phone lines, favorites, and conditional soft keys.

Access the Main Menu

On VVX business IP phones, you can access phone features and settings from the Main Menu screen.

Figure 5: Main Menu on VVX 250 Phones

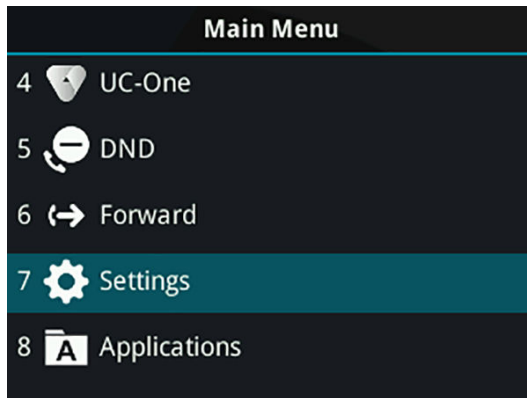

Procedure

- » Press the Home key .

Access the Calls Screen

You can access the Calls screen when you have one held call or an active and held call in progress on your phone.

The Calls screen is automatically displayed when you have an active call and one or more held calls on your phone. The total number of calls is displayed on your line. If you have multiple lines on your phone, the calls display under the associated line, as shown next.

Figure 6: Call Screen on VVX 250

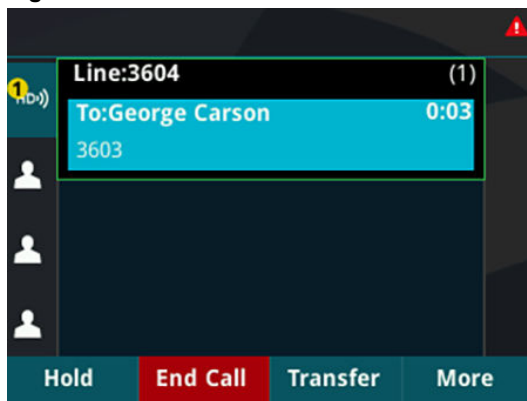

Procedure

- » During a call, do one of the following:
 - Press the Home key .
 - From the Lines screen, press the **Calls** soft key.

Access the Lines Screen

The Lines screen is the default screen that displays when VVX business IP phones are not in use.

When you have multiple calls on your phone, the number of calls is displayed next to the line number. You can view your phone lines, favorites, and soft keys on the Lines screen, as shown next.

Figure 7: Phone line, favorites, and soft keys on the Lines screen



Procedure

- » Do one of the following:
 - Press the Home key (🏠).
 - During a call, select the **Lines** soft key.
 - When off-hook on a VVX 150 phone, select the **New Call** soft key.

Switch Among Phone Screens

You can see any phone screen by pressing the Home key (🏠). Although you can access any phone screen from whatever screen you are on, certain screens are only accessible if your phone is idle or has one or more calls in progress.

You can access these screens in the following scenarios:

- If your phone is not in use, you can access the Main Menu and Lines screens.
- If your phone has an active call, you can access all screens.
- If your phone has one active call only, you can access the Main Menu, Lines, and Call screens.
- If your phone has multiple calls, or one held call, you can access the Main Menu, Lines, and Calls screens.
- If your phone is off-hook but not in a call, you can access Main Menu and Lines screens.

Procedure

























- » Do one of the following:
 - From the **Main Menu** screen, press the Home key (🏠) to display either the Lines or Call screen.
 - The Call screen displays only when an active or held call is in progress on your phone.
 - Press the Home key (🏠) to display the Main Menu screen from the Lines or Call screen.
 - Press the **Lines** soft key to access the Lines screen from the Calls or New Call screen.
 - Press the **Calls** soft key to access the Calls screen from the Lines screen.

- When off-hook, press the **New Call** soft key to access the Lines screen.

Icons and Status Indicators on VVX Business IP Phones

have various icons and status indicators that display the status of the phone whether you are in a call or the phone is idle and not in use.

Icons and Status Indicators

Icon	Description	Icon	Description
	Registered line		Phone warning
	Unregistered line		Login credentials invalid
	Outgoing call		Shared line
	Active call using Polycom HD Voice		USB flash drive attached Not supported on VVX 150
	Held call		Call forwarding enabled
	Incoming call		Presence status (Available)
	Active conference		Presence status (Busy or In a Call)
	Do Not Disturb enabled		Presence status (Away)
	Favorite		Presence status (Do Not Disturb)
	Placed call		Presence status (Offline)
	Received call		Presence status (Offline)
	Missed call		New message
	Wireless network		

Related Links

[Features for Hearing-Impaired Users](#) on page 142

Entering Information in Data Fields

You can enter information and edit fields using the dial pad keys on the phone console.

Before you enter information into fields, you can choose how to enter the information using the following soft keys:

- **Mode**—Enables you to enter just numbers or text in title case, lowercase, or uppercase characters.
- **Encoding**—Enables you to enter alphanumeric and special characters as well as characters in special languages.

The following table lists the Mode and Encoding options for the dial pad and the onscreen keyboard.

Mode and Encoding Options

Mode Options	Encoding Options
Abc (to capitalize the first letter only and use lowercase for the remaining letters)	Abc
ABC (to enter uppercase only)	ABC
abc (to enter lowercase only)	abc
123 (to enter numbers only)	123
	ASCII (for regular text)
	Latin (to enter accented characters)
	Katakana (for Japanese characters)
	Unicode (to store characters as double bytes)
	Cyrillic (for Russian characters)

Entering Information Using the Dial Pad

You can use the dial pad keys on VVX business IP phones to edit or update field information.

The following table describes how to enter different types of data on your phone using the dial pad.

Using the Dial Pad Keys to Enter Information

Task	Action
Enter numbers or characters in uppercase, lowercase, or title case mode	Select Encoding or Mode , and select ABC,abc , or Abc .
Enter only numbers	Select Encoding or Mode , and select 123 .
Enter text in another language	Select Encoding , and select one of the language options.

Task	Action
Enter a character	Press a dial pad key repeatedly to view the character options and stop when the character you want to enter is displayed in the field. Wait one second, and enter the next character.
Enter a number	Select Encoding or Mode , and select 123 , or press a dial pad key repeatedly to enter the number that displays on that key.
Enter a special character	Select Encoding , and select Abc , ABC , or abc . Press either the 1 , 0 , asterisk , * , or pound # key one or more times to enter one of the following special characters: <ul style="list-style-type: none"> • 1 key: ! ' ^ \ @ : 1 • * key: * - & % + ; () • 0 key: / , _ \$ ~ = ? 0 • # key: # > < { } [] " ' ` <p>You cannot access special characters when you are in numerical (123) mode.</p>
Enter a space	Select Encoding , and select one of the alphabetic Abc , ABC , or abc . Press the 0 key. <p>You cannot enter a space when you are in numerical (123) mode.</p>
Delete one or more characters	Use the arrow keys to position the cursor to the right of the character, or drag your finger across the characters until the cursor is positioned to the right of the character(s) you want to delete. Press the Delete key or press the << soft key.

Entering Chinese Characters with PinYin

The PinYin text input feature on VVX business IP phones uses Nuance XT9® Smart Input to enable you to enter Chinese characters into text fields using the phone's dial pad keys.

You can use the PinYin input widget to enter Chinese characters in the contact directory, corporate directory, and browser using the the dial pad keys on VVX phones. When you select a data field to edit, the PinYin input widget is automatically displayed when Simplified or Traditional Chinese is set as the displayed language on your phone.

Note: For more information on the PinYin text input method, see the [Nuance's XT9 Smart Input](#) website.

Enter Chinese Characters with the Dial Pad Keys

You can use the dial pad keys and the PinYin input widget to enter Chinese characters on VVX business IP phones.

The PinYin input widget disappears if you press the Pound key  or no keys are pressed for 5 seconds.

Procedure

1. Enter the PinYin text that corresponds with the digits on the phone's dial pad.

For example, press 7464.

The possible PinYin matches display in the text field with the first match highlighted.

2. Press the Star key  to toggle between selections.

The recommendation area shows the possible character matches. A navigation indicator is displayed if more matches are available.

3. Use the left and right arrow keys or swipe the recommendation area on the touch screen to change the selected character.
4. Press the **Select** key to select the character from the recommendation area.
5. After the character is selected, it is displayed in the input field at the cursor location.

Logging in to and Locking Your Phone

Topics:

- [Logging in to Poly VVX Business IP Phones](#)
- [Log In to a Visitor Desk Phone](#)
- [Log In to a Host Phone](#)
- [Log In to a Guest ACD Phone](#)
- [Sign In Using Your BroadSoft UC-One Credentials](#)
- [Locking Your Phone](#)

VVX business IP phones enable you to log in to your phone with login credentials, sign in to the phone with your BroadSoft UC-One credentials or lock your phone.

Logging in to Poly VVX[®] Business IP Phones

If your system administrator has set up user credentials for your phone, you can log in to a phone and access your contacts or favorites, settings, and calendar, if enabled.

You can view your personal settings from any phone or system within your organization. Contact your system administrator for your user credentials.

Note: Some of the features described in this section require access to the Basic settings menu. If your phone requires a password to access the Basic settings menu, contact your system administrator for assistance.

Log In to a Phone

Depending on how your system administrator set up the User Login feature, you may need to log in to a Poly phone before you can use one.

By default, Poly devices do not require you to log in before you can use them. However, if you do not log in, you see the default profile. When you log in, you have full access to your personal settings and your directory. Any settings you change while logged in to a public phone are saved and displayed the next time you log in to any phone.

Procedure

1. Do one of the following:
 - If you see the **User Login** screen.
 - If you do not see the **User Login** screen, navigate to **Settings > Features > User Login > Log In**.
2. From the **User Login** screen, enter your user ID and password, and select **Log In**.

When your login credentials are accepted, your personal profile displays. If your credentials are not accepted, a message indicating your log in failed is displayed, and the User Login screen is displayed again. Check with your system administrator to confirm your login credentials.

Log Out of the Phone

After you finish using a public phone, make sure you log out to prevent access to your personal settings.

Procedure

1. Select **Log Out** or navigate to **Settings > Features > User Login > Log Out**.

The Log Out screen is displayed with a confirmation message.

2. Select **Yes**.

Your personal profile is no longer accessible, and either the User Login screen displays for the next user or the default profile displays.

Change Your Login Password

You can change your login password from any phone on your network.

Procedure

1. Log in to a phone on your network.
2. Navigate to **Settings > Features > User Login > Change User Login Password**.
3. On the **Change User Login Password** screen, enter your old and new password information and select **Enter**.

Your password is changed. The next time you log in to a phone, you need to enter your new password.

Log In to a Visitor Desk Phone

When you are registered with the Alcatel-Lucent Converged Telephony Server (CTS), you can log in to VVX business IP phones as a visitor desk phone, which is a shared public phone, to make calls to contacts or access and change your personal settings.

When you log in to a visitor desk phone, you have full access to your personal phone settings and your directory. Your system administrator provides you with login credentials that you can use to log in to a visitor desk phone. By default, Polycom phones do not require you to log in before you can use them. However, if you do not log in, you see only the phone's default profile.

Procedure

1. Do one of the following:
 - If you see the **Visitor Login** screen.
 - If you do not see the **Visitor Login** screen, press the **Visitor Login** soft key or navigate to **Settings > Features > Visitor Desk Phone > Visitor Login**.
2. From the **Visitor Login** screen, enter your user ID and password, and select **Log in**.

When your login credentials are accepted, the phone updates to display your personal phone profile. When your credentials are not accepted, the message "User login failed" is displayed, and the Login screen is displayed again. Check with your system administrator to confirm that your login credentials are correct.

Log Out of a Visitor Desk Phone

After you use a phone, make sure you log out to prevent access to your personal settings.

Procedure

- » Select the **Log out** soft key or navigate to **Settings > Features > Visitor Desk Phone > Visitor Log out**.

Your personal profile is no longer accessible, and the phone displays the default phone profile.

Log In to a Host Phone

When VVX business IP phones are registered with the BroadSoft BroadWorks server and your system administrator has enabled the Flexible Seating feature, you can log in to your guest profile on a host phone, which is a shared public phone, to place calls to emergency numbers as defined by your system administrator.

Your system administrator provides you with login credentials that you can use to log in to a host phone. When you log in to a host phone, you have limited access to your personal phone settings and your directory. You can access the BroadSoft Directory and BroadSoft UC-One Favorites, but you cannot access your Contact Directory or general favorites from a host phone.

Procedure

1. Do one of the following:
 - If you see the **Guest In** screen.
 - If you do not see the **Guest In** screen, press the **Guest In** soft key.
2. From the **Guest In** screen, enter your username and password and select **OK**.

When your login credentials are accepted, the phone updates to display your personal phone profile. If your credentials are not accepted, a message indicating that your login credentials are invalid is displayed, and the phone displays the Lines screen. Check with your system administrator to confirm that your login credentials are correct.

Log Out of a Host Phone

After you use a phone, make sure you log out to prevent unauthorized users from using your guest profile to place calls or access your personal settings.

After you log out of the host phone, you can no longer view your guest profile information nor view any changes or call history made on the host phone on your personal phone. If you are logged into your ACD account when you log out of the host phone, you are automatically logged out of your ACD account.

If your system administrator has set a guest PIN for your account, you must enter your PIN to log out of a host phone. If you do not sign out of a host phone after a designated time set by your system administrator, you are automatically logged out of the host phone.

Procedure

1. Select the **Guest Out** soft key.
2. If prompted, enter your guest PIN.

Your personal profile is no longer accessible, and the phone displays the default host profile.

Log In to a Guest ACD Phone

If your system administrator has enabled the Flexible Seating with the Automatic Call Distribution (ACD) feature, you can log in to your ACD account after you log in as a guest on VVX business IP phones set as a host phone.

If Hoteling is enabled, you do not need to log in as a guest before you can log in to your ACD account.

When you are logged in to a guest ACD phone, you can answer incoming calls from call center customers, update your presence status, view incoming call center information, and transfer a call.

Note: When logging into a host phone as a guest user, the Use Host soft key is not available.

Procedure

- » Do one of the following:
 - If you see the **Agent Sign In** screen.
 - If you do not see the **Agent Sign In** screen, press the **ASignIn** soft key or navigate to **Settings > Features > Agent Sign In > Sign In**.

Log Out of a Guest ACD Phone

After you use a phone, make sure you log out to prevent access to your personal settings.

Procedure

- » Select the **ASignOut** soft key or navigate to **Settings > Features > Agent Sign In > Sign Out**.
The phone displays the default guest profile.

Sign In Using Your BroadSoft UC-One Credentials

You can enter your BroadSoft UC-One credentials on VVX business IP phones and view your line registered with the BroadWorks server.

Your system administrator provides you with your BroadSoft UC-One credentials.

Procedure

1. Navigate to **Settings > Basic > UC-One Credentials**.
2. Enter the **Server Address**.
3. For **User**, enter the username for your account.
4. For **Password**, enter your password for your account.

Locking Your Phone

Your system administrator provides you with a user password that you can use to unlock VVX business IP phones.

Consider locking your phone if you want to:

- Prevent unauthorized outgoing calls.
- Allow only authorized people to answer calls.

- Prevent people from viewing or modifying phone information, such as your directory, call lists, or favorites.

When your phone is locked, you can:

- Place outgoing calls to emergency and authorized numbers only.
- Enter a password to answer incoming calls.
- View the browser, if enabled.

When your phone is locked, a message displays on the status bar informing you that the phone is locked and that only authorized calls are allowed. Any messages that displayed before the phone was locked do not display.

Related Links

[Answer a Call on a Locked Phone](#) on page 38

[Place a Call from a Locked Phone](#) on page 35

Lock Your Phone

You can choose how you want your phone to handle incoming calls when it is locked. When you set up your phone to receive incoming calls when locked (the default setting), incoming calls ring on your phone, and you can answer calls by entering your user password.

When you set up your phone to ignore incoming calls, Do Not Disturb applies to all lines on your phone, and your phone does not ring.

-
- Note:**
- When the Flexible Seating feature is enabled and you are logged in as a guest on a host phone, the Phone Lock feature is only available if your system administrator has set a 4 - 10 digit guest PIN for your user account. If you do not see the Lock soft key or menu option, check with your system administrator to see if this feature is available on your phone.
 - There will be no response when you press the Back key if the phone is locked.
-

Procedure

1. Select **Lock** or navigate to **Settings > Basic > Lock Phone**.
2. From the **Lock Phone** screen, select **Allow ringing when locked** (the default setting) if you want your phone to ring when you have an incoming call.

When you choose this option, you can answer a call by entering your user password or guest PIN.

3. Select **Lock**.

Your phone is locked.

- Tip:** You can quickly lock your phone by selecting the Lock soft key. When you do this, you cannot choose how to handle incoming calls. Your phone uses the default setting or the last setting selected.
-

Unlock the Phone

Your system administrator provides you with a user password that you can use to unlock VVX business IP phones.

Procedure

1. Select **Unlock**.

2. Enter your user password, or guest PIN if signed in as a guest on a host phone, and select **Unlock**.

Change Your User Password

You can change your user password at any time from the Advanced settings menu on VVX business IP phones.

The Advanced settings menu requires a password to access the menu options. Ask your system administrator for the password if you cannot access menu.

Procedure

1. Navigate to **Settings > Advanced**.
2. Enter your user password and select **Enter**.
3. On the **Advanced** screen, select **Change User Password**.
4. On the **Change User Password** screen, enter your old and new user password and select **Enter**.

Audio Calls

Topics:

- [Placing and Answering Audio Calls](#)
- [Switch Among the Handset, Headset, and Speakerphone](#)
- [Mute and Unmute Audio](#)
- [Holding and Resuming Calls](#)
- [Ending Calls](#)
- [Transferring Calls](#)
- [Parking and Retrieving Calls on the BroadSoft BroadWorks Server](#)
- [Managing Calls](#)
- [Managing Calls Remotely](#)
- [Ignoring or Rejecting Incoming Calls](#)
- [Redirecting Incoming Calls](#)
- [Call Precedence and Preemption](#)

VVX business IP phones enable you to place and answer SIP and H.323 calls, ignore incoming calls from all or individual contacts, and perform server-dependent tasks.

Note: Some of the audio features available on VVX business IP phones require access to the Basic settings menu. If your phone requires a password to access the Basic settings menu, contact your system administrator for assistance customizing your phone.

Placing and Answering Audio Calls

VVX business IP phones can manage between eight and 24 audio calls depending on the model.

VVX 150 phones can manage a maximum of eight active, incoming, and held audio calls at a time. VVX 250, 350, and 450 phones can manage a maximum of 24 active, incoming, and held audio calls at a time.

However, you can have only one active call in progress with numerous other incoming calls or calls on hold on all phones. Additionally, your system administrator can set up your phone to have up to six lines with unique extension numbers or the same extension number as other lines on your network.

Placing Audio Calls

You can place calls on VVX business IP phones in numerous ways, including local and international calls, calls from Recent Calls or directories, calls to contacts or favorites, or calls to authorized numbers on a locked phone.

Call Charges for Outgoing Calls

If your service provider charges for outgoing calls, a notification displays on VVX business IP phones informing you of the potential charges of an outgoing call.

If enabled by your service provider, a tone plays on your phone when call information displays. Check with your system administrator to find out if this feature is enabled for your phone.

The following call charge information displays on your phone for outgoing calls:



- **Call initiation costs**—the initial cost for placing a call.
- **Cumulative call costs**—the accruing cost of the ongoing call.
- **Completed call costs**—the total cost of the call after the call ends.

Place a Call from the Dialer

The Dialer on VVX business IP phones enables you to enter a phone number to place a call, and it displays a list of previously placed calls.

Note: Your system administrator can set up your phone to automatically place the call after you enter a certain number of digits. If a call is placed before you enter all the digits, add the number to your Contact Directory and dial the number from the Contact Information screen.

Procedure

1. Do one of the following:
 - Start typing a phone number.
 - Select **New Call**.
 - Press a line key.
 - Pick up the handset, press the Handset key , or press the Speakerphone key .
2. Enter a number or select a recent contact.
3. Select **Dial**.

Place an International Call

You can place calls to international phone numbers on VVX business IP phones.

Procedure

1. On the dial pad, quickly press the **star key** * twice.
A plus sign + is displayed.
 2. Enter the phone number with the country code and select **Dial** .
- The phone plays a tone and the call is answered automatically on the contact's phone.

Place a Call from Recent Calls

You can place calls to contacts from the Recent Calls list, which contains calls that were recently placed, answered, or missed.

Procedure

1. Navigate to **Directories** and select **Recent** or **Recent Calls**.
2. From the **Calls List** screen, select a contact and select **Dial**.

Calling Favorites

You can call your favorites from the Favorites list or by selecting a favorite on your Home or Lines screen.

Call Favorites from the Favorites List

When you add a contact as a favorite on VVX business IP phones, the contact is added to your Favorites list. You can call contacts directly from the Favorites list.

Procedure

1. Select **New Call**.
2. From the Dialer, select **Favorites**.
3. Select a favorite, and select **Dial**.

Call Favorites from the Lines Screen

You can quickly call favorites from the Lines screen on VVX business IP phones.

Procedure

- » Select a line key associated with a favorite on the Lines screen.
A call is placed to the favorite automatically.

Calling Contacts from the Directory

On VVX business IP phones, you can search for and call contacts in your Contact Directory, the Corporate Directory, and the BroadSoft Directory, if enabled.

Call a Contact from a Directory

On VVX business IP phones, you can place a call to a contact directly from your directory or you can select contacts in your directory to call from the New Call screen.

Procedure

1. Do one of the following:
 - Select **Directories**.
 - Navigate to **New Call** > **Directory**.
2. Choose a directory.
3. From your directory, select or search for a contact.
4. Select the contact's phone number.
5. If the call is not placed automatically, select **Dial**.

Call a Contact from the Directory Search Screen

You can search for and call contacts from the Search screen in your directory on VVX business IP phones.

Procedure

1. Navigate to **Directories** and select a directory.
2. Select **Search**, enter your contact's first or last name, and select **Search**.
3. Select your contact.
4. In the **Contact Information** screen, select the contact's number, and select **Dial**.

Place a Call from a Locked Phone

When the phone is locked, you can place outgoing calls only to emergency numbers, such as 911 and authorized numbers that your system administrator can set up. You cannot call any other numbers from a locked phone.

Procedure

1. Select **New Call**.
2. From the **Place an Authorized Call** screen, select a number and select **Dial**.

Related Links

[Locking Your Phone](#) on page 29

Placing Intercom Calls

The Intercom feature enables you to place a call to a contact that is answered automatically on the contact's phone as long as the contact is not in an active call.

If the contact is in an active call, the contact can choose to answer the intercom call, or the intercom call is answered automatically after the active call ends.

Check with your system administrator to find out if this feature is available on your phone.

Place an Intercom Call

You can place an intercom call from VVX business IP phones to quickly relay a message to a contact.

Tip: Your system administrator can set up your phone to automatically call a specific contact when you select **Intercom**. If your phone is set up this way, select **Intercom** and wait for your contact to answer before speaking your message.

Procedure

1. Select **Intercom**.
2. Enter a number or select a contact.
3. Select **Dial**.
The phone plays a tone and the call is answered automatically on the contact's phone.
4. After the call is answered, speak your message then select **End Call**.

Place an Intercom Call During a Call

You can place an intercom call to another contact during an active call.

Procedure

1. Select **Hold > Intercom**.

The active call is placed on hold and the dialpad is displayed.

2. Enter a number or select a contact.
3. Select **Dial**.

The phone plays a tone and the call is answered automatically on the contact's phone.

4. After the call is answered, speak your message and select **End Call**.
5. Select **Resume**.

Place a Call with a Hidden Number

When your phone is registered with the BroadSoft BroadWorks server, you can choose to hide your phone number when you place a call.

Check with your system administrator to find out if this feature is available on your phone.

Procedure

1. Select **UC-One** on the Home screen or go to **Settings > Features > UC-One Call Settings**.
2. If you have more than one line registered, select a line.
3. Select **Line ID Delivery Blocking** and select **Enabled**.

Your number does not display when you place calls to contacts.

Place a Call from an Expansion Module

You can place a call using the line keys on expansion modules connected to supported VVX business IP phones.

VVX EM50 expansion modules are supported on VVX 450 business IP phones only.

Procedure

- » Do one of the following:
 - Press a line key corresponding to an available line and dial the number.
 - Press the line key of the assigned favorite you want to call.

The call is placed and is displayed on your phone's screen.

Related Links

[Polycom VVX EM50 Expansion Modules](#) on page 134

Redial a Number

VVX business IP phones automatically keep a record of all calls placed. You can recall the last contact you called using Redial, if enabled by your system administrator.

Procedure

- » Select **Redial**

Redial a Contact when the Contact is Available

When you place a call to a contact and the contact's line is unavailable due to an unregistered line or a service outage, a notification displays on your phone when the contact's line is available again, and you can choose to call the contact from the notification.

Check with your system administrator to find out if this feature is available on your phone.

Procedure

- » When the contact availability notification displays, select **Dial**.

Answering Audio Calls



When you receive an incoming call on a VVX business IP phones, you can choose to answer the call in various ways, including answering calls automatically, in the Incoming Calls screen, in the Calls screen, and during a call.

Answer an Incoming Call

When you receive an incoming call, the phone rings and an Incoming Call screen is displayed. In the Incoming Call screen, you can choose to answer or reject the incoming call.

Note: Your system administrator can enable the screen to flash bright orange when you have an incoming call. The screen continues to flash until the Home or Calls screen displays the incoming call. For more information about this feature, contact your system administrator.

Procedure

- » Do one of the following:
 - Pick up the handset.
 - Press the Speakerphone key ) or select **Answer**.
 - Press the Headset key .

After you answer the incoming call, the call becomes active.

Answer a Call from the Calls Screen

When you don't answer an incoming call within 10 seconds, the Incoming Call screen disappears and the Calls screen is displayed.

Procedure

- » Select the incoming call, and select **Answer**.

Answer a Call When in a Call

When you're in an active call and an incoming call arrives on the same or a different line, a call waiting tone beeps, and the Incoming Call screen is displayed.

If you don't answer the call within 10 seconds, the Incoming Call screen disappears, and the Calls screen is displayed.

Procedure

- » Select **Answer**.

This places the active call on hold, and the incoming call becomes active.

Answer Calls Automatically

You can set up VVX business IP phones to automatically answer calls using the Auto Answer feature.

When enabled, the phone automatically answers all incoming calls using the speakerphone. Your system administrator sets how many times the phone rings before the call is automatically answered.

When Auto Answer is enabled and you receive an incoming call while in a call, the incoming call is not answered until you end or hold the current call.

Procedure

1. Go to **Settings > Basic > Preferences**.
2. Select **Auto Answer**.
3. Select **Auto Answer SIP Calls** and select **Yes**.
4. If your phone supports H.323 protocol, select **Auto Answer H.323 Calls** and select **Yes**.
This option is displayed only if your phone supports the H.323 protocol.
5. Select **Microphone Mute** and choose **Yes** (the default setting) to mute the microphone for auto-answered calls.
6. Select **Save**.

Related Links

[Features for Mobility-Impaired Users](#) on page 143

Answer a Call on a Locked Phone

When you set up your phone to accept incoming calls when it is locked, you can answer the calls by entering a user password.

Procedure

1. On the Incoming Call screen, select **Answer**.
2. Enter your user password or guest PIN and select **Enter**.
The call connects.

Related Links

[Locking Your Phone](#) on page 29

Answer an Intercom Call

When you receive an intercom call, the call is answered automatically using the speakerphone.

If the phone is set up to answer intercom calls with your microphone muted, you need to unmute your microphone before responding to the call.

Procedure

- » After the call is answered, press **Mute**  and reply.

Answer a Call from an Expansion Module

You can answer calls using the line keys on your VVX phone or from your connected expansion module.

Procedure



- » Press the expansion module line key that has the flashing green LED indicator.

Related Links





[Polycom VVX EM50 Expansion Modules](#) on page 134

Switch Among the Handset, Headset, and Speakerphone

You can place and answer calls on your phone using the handset, headset, or speakerphone, and you can alternate among the three modes during calls, if available.

When using the speakerphone, the Speakerphone key  glows green. When using the headset, the Headset key  glows green if an analog headset is connected or blue if a USB headset is connected. For VVX 150 phones, the headset and speakerphone keys do not glow and the Headset  icon displays in the status bar.

Procedure

- » During a call, pick up the handset, press the Headset key  or press the Speakerphone key .
- For example, if you're using the handset, press the Headset key  to switch to the headset, or press the Speakerphone key  to switch to the speakerphone.

Related Links



[Use Your Headset for All Calls](#) on page 127

Mute and Unmute Audio

You can mute the microphone so other parties cannot hear you.

Microphone Mute applies to the handset, headset, and speakerphone. You can still hear all other parties when you mute your microphone. When your audio is muted, the Mute icon is displayed and the Mute key glows red, excluding VVX 150 phones.

Procedure

1. During a call, including a conference call, press **Mute** .
- The other parties cannot hear you.
2. Press **Mute**  again to unmute the microphone.

Holding and Resuming Calls

When you are in a call, you can place an active audio call on hold and resume the call.

Hold a Call

You can place any active call on hold on VVX business IP phones.

Procedure

- » During an active call, select **Hold**.
- If you're in the Calls screen, select the call first.
- A hold icon  is displayed on the line of the held call, and a red LED light flashes on the line key for all phones except VVX 150 phones.

Resume a Call

You can view and resume all held calls on the phone.

Procedure

- » Do one of the following:
 - Select **Resume**.
 - From the Calls screen, select the call and select **Resume**.

Resume a Call on an Expansion Module

You can resume calls placed on hold by other contacts from your expansion module connected to supported VVX business IP phones.

A flashing red LED light on a line key on the expansion module indicates a call is on hold on the contact's line.

Procedure

- » Press the line key corresponding to the line with the held call.

Related Links

[Polycom VVX EM50 Expansion Modules](#) on page 134

Ending Calls

You can end active calls at any time, however, you must resume held calls before you can end the call.

End an Active Audio Call

You can end an active call on your phone at any time.

Procedure

- » Do one of the following:
 - Place the handset on the cradle.
 - Press **End Call**.
 - In the Calls screen, highlight the call and press **End Call**.

End a Held Call

You can end active calls at any time, however, you must resume held calls before you can end a call.

Procedure

- » From the Calls screen, select the held call and press **Resume > End Call**.

Transferring Calls

You can transfer active or held calls to another person using the following transfer types:

- Blind transfer—Transfers the call directly to another line without speaking with the other party first.
- Consultative transfer—Enables you to speak with the other party before completing the transfer.

Choose a Default Transfer Type

You can choose a default transfer type to use for all calls on VVX business IP phones.

When you choose a default transfer type, the phone uses the selected transfer type for all calls. Consultative is the default transfer type.

Procedure

1. Go to **Settings > Basic > Preferences**.
2. Select **Default Transfer Type** and choose a transfer type.

The selected transfer type is used for all calls.

Transfer a Call

You can transfer a call to another contact and choose the transfer type you want to use for the call.

Procedure

1. During a call, do one of the following.
 - Press **Transfer** to use the default transfer type.
 - Press and hold **Transfer** to use the non-default transfer type.
For example, if Blind is the default, press and hold Transfer to perform a Consultative transfer.
 - Press **Transfer > More**, and select **Blind** or **Consultative**.
Depending on the default transfer type, either the Blind or Consultative option displays. For example, if the default transfer type is Blind, then you can select Consultative.
2. Dial a number or choose a contact from the Recent Calls or a directory.
If the transfer type is set to Blind, the call is transferred immediately.
3. If the transfer type is set to Consultative, select **Transfer** after speaking with your contact.

Cancel a Transfer

If a contact does not answer the transfer or you want to remain speaking with the contact on your line, you can cancel the transfer before it is complete.

Procedure

- » Select **Cancel**.

The call is not transferred and becomes active.

Parking and Retrieving Calls on the BroadSoft BroadWorks Server

When your phone is registered with a BroadSoft BroadWorks server, you can use Call Park to park a call directly to a contact's line.

Call Park is different from call hold in that the call is parked on another contact's line, which enables you to continue using your phone to place other calls. Call Park is also available for shared lines. Check with your system administrator to find out if this feature is available on your phone.

Park a BroadSoft Call

You can park a call directly on a contact's line. When you park a call on a contact's line, the call is removed from your phone and the contact is notified that a call is parked on his or her line.

When a contact sends a parked call to your extension, the following notifications are displayed or played on your phone:

- The Call Park icon .
- The message “Call is parked” in the status bar.
- An audio notification plays, if enabled by your system administrator. Audio notifications are not available for BLF monitored contacts.

The Call Park icon  also displays for shared lines, monitored contacts, and for lines and monitored contacts on connected expansion modules.

Procedure

- » During a call, press **Hold** and dial ***68** and the contact's line extension.
For example, dial *684144.

Retrieve a Parked BroadSoft Call

When a contact parks a call on your line, the status message and the Call Park icon display on your phone until the parked call is either retrieved, ignored, or the parked caller ends the call.

If a parked call is not answered after a period of time, which is set by your system administrator, the call is returned to the parker—the person who parked the call. If the parker answers the returned call, the parked call is removed from the parked extension. If the parker rejects the returned call, the parked call remains on the parked extension until the call is returned to the parker and answered or the parked caller ends the call.

Procedure

1. Press and hold the line key with the parked call.
The **Park Info** soft key is displayed.
2. Press the **Park Info** soft key.
The **Parked Call** screen is displayed.
3. Press **Retrieve**.

Retrieve a Parked BroadSoft Call on Another Phone

You can retrieve a parked call from any phone within your network.

When a parked call is retrieved by a contact monitoring your line, the Call Park icon  and status message is removed from the line.

Procedure

- » Press **New Call** and dial ***88** and the extension the call was parked on.
For example, dial *884144.

Ignore a Parked Call

You can choose to ignore a parked call instead of retrieving the call.

Ignoring the parked call removes the parked call icon, but the call remains parked on your line until the call is retrieved, the retrieval time expires, or the call is ended.

Procedure

1. Press and hold the line key with the parked call.
The **Park Info** soft key is displayed.
2. Press the **Park Info** soft key.
The **Parked Call** screen is displayed.
3. Press **Ignore**.
The phone exits the Parked Call screen, and the Call Park icon (P) and status message is removed from the line.

Managing Calls

On VVX business IP phones, you can see the number of calls on the line from the Lines screen, as shown next. A green light on the line key indicates a line with an active call, and a red light indicates a line with one or more held calls.

Figure 8: Multiple Calls on phone lines on the Lines screen

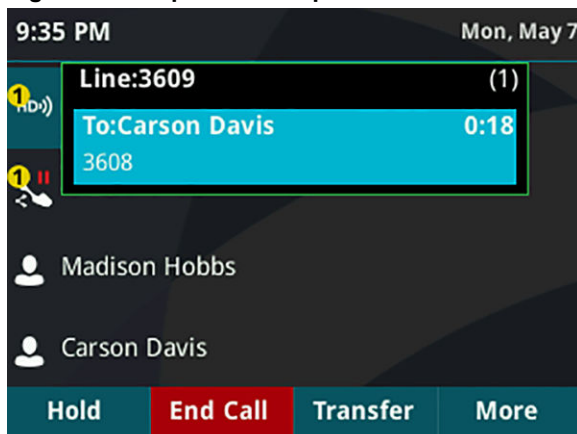

Display Calls from the Lines Screen

You can display the calls for each line from the Lines screen.

When you select a phone line that has a held call, the first held call on that line is automatically resumed, even if you already have an active call on a different line.

Procedure

- » Press and hold the line key.

Display Calls from the Calls Screen

You can view multiple calls on your line from the Calls screen.

Procedure

- » Do one of the following:
 - Press the Home key .
 - From the Lines screen, press the **Calls** soft key.

The Calls screen is displayed with the list of active and held calls for each line on the phone.

Manage a Call from the Calls Screen

From the Calls screen, you can manage a call by holding, resuming, or transferring the call.

Procedure

1. Select a call.
2. Do one of the following:
 - Select **Hold** to place an active call on hold.
 - Select **Resume** to make a held call active.
 - Select **End Call** to end a call with a contact. You can end active calls only, so resume the held call first before ending it.
 - Select **Transfer** to send the call to another contact.
 - Select **Conference** to initiate a conference call.

Managing Calls Remotely

When your VVX phone is registered with a BroadWorks server and you are signed in to the phone with your BroadSoft UC-One credentials, you can manage calls to your line remotely from any of your phones using the BroadWorks Anywhere or Remote Office features.

With these features, you can handle any incoming calls to your office phone on other phones or mobile devices and move calls from your mobile device to your desk phone without ending the call.

Check with your system administrator to find out if these features are available on your phone.

Managing Calls with BroadSoft UC-One BroadWorks Anywhere

BroadWorks Anywhere is a BroadSoft UC-One feature that enables you to use one phone number to receive calls on your desk phone, mobile phone, or home office phone and place calls from any of these phones using one number.

BroadWorks Anywhere also enables you to move calls between your desk phone and mobile phone as well as perform any additional functions, such as intercom calls that you would make from your desk phone.

Contact your system administrator or service provider for more information on using BroadWorks Anywhere.

Enable BroadWorks Anywhere

You can enable BroadWorks Anywhere on VVX phones, add locations that act as duplicates of your desk phone, and manage all your calls from those locations. VVX phones support up to 10 phone numbers added as BWA locations for each registered line.

You can save a location name, primary number, and alternate number for each location you add. When you add a location, you can also choose to enable the following settings:

- Diversion Inhibitor—Determines if diversion inhibitor must be enabled when extending a call to the remote BWA location.
- Answer Confirmation Required —Requires confirmation when a call is answered by a remote location.
- Call Control—Determines if call control is handled by the BWA location or by the BroadWorks server.

Procedure

1. Select **UC-One** on the Home screen or go to **Settings > Features > UC-One Call Settings**.
2. Select a line.
3. Select **BroadWorks Anywhere** and press **Add**.
4. Enter information for the **Status**, **Name**, **Primary Number**, and **Alt. Number/SIP URI** fields, if applicable.
5. Choose the settings you want to enable.
6. Select **Save**.

Edit BroadWorks Anywhere Locations

After you enable BroadWorks Anywhere and add locations on phone, you can edit the added locations.

Procedure

1. Select **UC-One** on the Home screen or go to **Settings > Features > UC-One Call Settings**.
2. Select a line.
3. Select **BroadWorks Anywhere** and select a location.
4. Edit the selection.
5. Select **Save**.

Disable BroadWorks Anywhere Locations

When you return to the office or want to stop remotely managing your calls, you can disable BWA locations.

Procedure

1. Select **UC-One** on the Home screen or go to **Settings > Features > UC-One Call Settings**.
2. Select a line.
3. Select **BroadWorks Anywhere** and select a location.
4. Select **Status > Disabled**.
5. Select **Save**.

Remove BroadWorks Anywhere Locations

You can choose to remove BroadWorks Anywhere locations that you do not want to manage remote calls from anymore.

Procedure

1. Select **UC-One** on the Home screen or go to **Settings > Features > UC-One Call Settings**.
2. Select a line.
3. Select **BroadWorks Anywhere** and select a location.
4. Select **Delete**.

Managing Calls with BroadSoft UC-One Remote Office

With the Remote Office feature, you can forward all incoming calls to VVX business IP phones to a remote office number, such as your mobile or home office number, when you are away from the office.

You can answer all incoming calls to your desk phone on your mobile phone or home office phone. Any calls you place to contacts from your remote office number show your desk phone number on the caller ID.

Contact your system administrator or service provider for more information on using Remote Office.

Add a Remote Office Number

You can add one number only as your remote office number.

Procedure

1. Select **UC-One** on the Home screen or go to **Settings > Features > UC-One Call Settings**.
2. Select a line.
3. Select **Remote Office**.
4. Enter your remote office number and press **Enabled**.
5. Select **Save**.

All calls made to your desk phone are forwarded to the remote office number.

Disable Remote Office

When you return to the office or want to stop forwarding your calls, make sure you disable Remote Office.

Procedure

1. Select **UC-One** on the Home screen or go to **Settings > Features > UC-One Call Settings**.
2. Select a line.
3. Select **Remote Office > Disabled**.
4. Select **Save**.

Edit Your Remote Office Number

You can edit your remote office number to add a different number for forwarding your calls.

Procedure

1. Select **UC-One** on the Home screen or go to **Settings > Features > UC-One Call Settings**.
2. Select a line.
3. Select **Remote Office**.
4. Enter the new number and select **Save**.

Ignoring or Rejecting Incoming Calls

When you receive an incoming call, you can choose to ignore or reject the call instead of answering. You can reject or ignore incoming calls, reject incoming calls from a specific contact, or enable Do Not Disturb to reject all calls for a brief period of time.

Note: You cannot reject calls on shared lines. You can only silence the ringer.

Ignore or Silence an Incoming Call

You can ignore or silence a call to stop your phone from ringing. Even if you ignore the call and silence the ringer, an incoming call notification continues to display on your phone.

Procedure

- » From the **Incoming Call** screen, do one of the following:
 - Select **Ignore** for private lines.
 - Select **Silence** for shared lines.

The **Incoming Call** screen disappears, your phone stops ringing, and either the Home or Calls screen is displayed.

Reject Incoming Calls

You can reject a call and send the call directly to voicemail. Rejected calls display in the Missed Calls list in your Recent Calls list. Rejecting calls is not available for shared lines.

Procedure

- » On the **Incoming Call** screen, select **Reject**.

Reject Calls from a Contact

You can send incoming calls from a particular contact directly to your voicemail.

Procedure

1. Navigate to **Directories > Contact Directory**.
2. From your **Contact Directory**, select a contact.
3. From the **Contact Information** screen, select **Edit** .
4. From the **Edit Contact** screen, select **Auto Reject > Enabled** and select **Save**.



Calls from the contact are sent directly to voicemail when the contact calls.

Rejecting Calls with Do Not Disturb

Do Not Disturb (DND) enables you to set your phone to automatically reject calls when you don't want to be interrupted.

When you enable DND, you see the following:

- The DND icon  displays in the status bar.
- When the phone is idle, the DND icon displays next to your phone line.

- When the administrator enables hybrid line registration on the phone, you can choose **All** to enable DND on all the registered lines.
- If you have new messages or you have enabled call forwarding, the messages or forwarding icon display instead of the DND icon.
- The message **Do Not Disturb** displays in the status bar on all phones.
- The DND icon on the Home screen changes from  to .

For VVX 150 phones, the line icon changes to .

Note: When you set your presence status to Do Not Disturb and enable DND on your phone, a message stating that your status is set to Do Not Disturb scrolls under the time display, and the DND icon does not display in the status bar.

Enable Do Not Disturb

You can enable DND to prevent your phone from ringing and to send all incoming calls directly to voicemail. All calls you receive while DND is enabled are logged in the Recent Calls list.

Enabling DND on shared lines disables ringing only. A visual notification of the call still displays, and you have the option to answer or ignore the call.

Note: When you are signed into a host phone as a guest, you can only enable Do Not Disturb if the server-based Do Not Disturb feature is enabled on the phone. If server-based DND is disabled on the phone, you cannot use DND on the host phone. Contact your system administrator for help enabling this feature.

Procedure

- » Select **DND**.

Reject Calls with Do Not Disturb on Multiple Lines

By default, the Do Not Disturb feature applies to all lines on your phone. Your system administrator can set up your phone so that you can enable the feature on a per-line basis.

Procedure

1. Select **DND**.
2. Select **Set All** to enable DND for all lines.

Reject Calls with Do Not Disturb on One Line

If you have more than one line, you can choose to enable DND for a particular line and not all lines, if enabled.

Procedure

1. Select **DND**.
2. From the **Line Select** screen, select a line.
3. From the **Do Not Disturb** screen, select **Enable**.

Disable Do Not Disturb

You can disable DND when you are ready to resume receiving calls again.

Procedure

- » Select **DND**.

Reject Anonymous Calls

When your phone is registered with a BroadWorks server and you are signed into the phone with your BroadSoft UC-One credentials, you can use the Anonymous Call Reject (ACR) feature to automatically reject anonymous calls to your line from callers who have restricted their caller identification.

Check with your system administrator to find out if this feature is available on your phone.

Procedure

1. Select **UC-One** on the Home screen or go to **Settings > Features > UC-One Call Settings**.
2. If your phone has multiple lines, select a phone line.
3. Select **Anonymous Call Reject**.
4. On the **Anonymous Call Reject** screen, select **Enabled**.

When an anonymous call is placed to your phone number, the call is automatically rejected and the caller hears a message stating that you do not accept calls from unidentified numbers. Your phone does not ring, and you are not notified of an attempted call.

Redirecting Incoming Calls

You can redirect incoming calls by forwarding an incoming call to a contact, forwarding all incoming calls to a contact, or diverting calls from a specific contact to another contact.

Forwarding Incoming Calls to a Contact

You can choose to forward an incoming call to a contact or forward all incoming calls to one of your contacts.

Note: When you are signed into a host phone as a guest, you can only forward calls if the server-based Call Forwarding feature is enabled. If server-based Call Forwarding is disabled, you cannot forward calls to a contact from the host phone. Contact your system administrator for help enabling this feature.

Forward an Incoming Call to a Contact

You can forward an incoming call directly to a contact without answering the call.

You cannot forward calls without answering on shared lines.

Procedure

1. In the **Incoming Call** screen, select **Forward**.
2. From the **Call Forwarding** screen, enter the forwarding number, and select **Forward**.

Forward All Incoming Calls to a Contact

You can set up your phone to forward all incoming calls to a contact using one of the following forwarding types:

- **Always**—Forwards all incoming calls.

- **No Answer**—Forwards all unanswered incoming calls.
- **Busy**—Forwards incoming calls when you're in a call.

For shared lines, you can only choose **Always** as your forwarding type; the other forwarding options are not available for shared lines.

Procedure

1. Select **Forward** or navigate to **Settings > Features > Forward**.
2. If your phone has multiple lines, select a line.
3. On the **Forwarding Type Select** screen, select a forwarding type.
4. Enter a contact's number or IP address, if enabled, and select **Enable**.
5. If you selected the **No Answer** option, enter the number of rings before the call is forwarded.

The forwarding number or name of the contact you chose scrolls in the status bar. When you select **Always** as your forwarding option, the Forwarding icon  is displayed on the line.

Disable Call Forwarding

You can disable call forwarding when you no longer want to forward your calls.

Procedure

1. Select **Forward**.
2. If your phone has multiple lines, select a line.
3. From the **Forwarding Type Select** screen, select your forwarding type, and select **Disable**.

Divert Calls to a Contact

You can divert all incoming calls from a particular contact to another contact.

Procedure

1. Select **Directories > Contact Directory**.
2. From the **Contact Directory**, select a contact.
3. From the **Contact Information** screen, select **Edit**.
4. From the **Edit Contact** screen, select **Divert Contact**, and enter a contact's number.
5. Select **Auto Divert > Enabled**.
6. Select **Save**.

Call Precedence and Preemption

If your administrator has enabled call precedence and preemption, your outgoing calls are assigned a precedence level.

If you are in an active call and receive a new call with a higher precedence, your active call is preempted—ended. If your call is preempted, your phone plays a preemption tone and displays a preemption screen. The preemption screen is shown both for caller and callee. After you acknowledge the preemption screen, you can answer, reject, or ignore it. The notification screen disappears if you do not acknowledge the preemption notification after the display time out as defined by your admin.

When you receive higher precedence call, the lower precedence call gets disconnected, private line and shared line preemption screen displays as below.

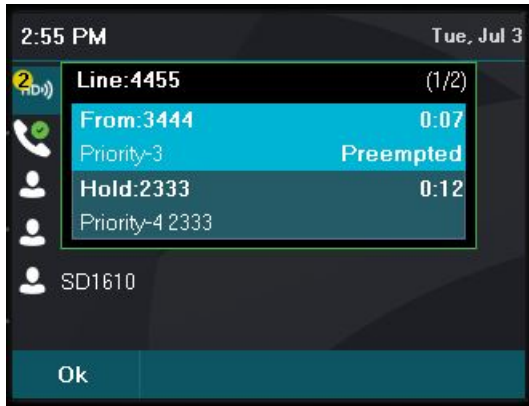

Conference Calls

Topics:

- [Tips for Conference Calls](#)
- [Audio Conference Calls](#)
- [Alcatel-Lucent Advanced Conference Calls](#)

When you initiate a conference call, you can hear audio for two or more contacts, manage conference participants, and join calls into a conference or split a conference into individual calls.

Tips for Conference Calls

When you are in a conference call, follow these tips:

- Use the handset or a headset if you're in an open environment.
- Mute your microphone when you are not speaking, especially in noisy environments.
- Avoid tapping or rustling papers near the microphone.
- Speak in your normal voice without shouting.

Audio Conference Calls

You can initiate an audio conference call with two contacts and hold, resume, or split a conference call on VVX business IP phones.

VVX 150 phones can manage a maximum of four active or held conference calls at a time. All other VVX business IP phones can manage a maximum of 12 active or held conference calls at a time. However, you can have only one active conference call in progress with numerous other conference calls on hold.

If your system administrator enables the Conference Management feature on your phone, you can manage each participant in the call. With the Conference Management feature, you can mute, hold, and remove individual participants in a conference call.

Note: If your phone is registered with Alcatel-Lucent CTS, you have different options for initiating and managing conference calls.

Initiate a Conference Call

You can initiate a conference call with up to two contacts.

Note: When your phone is set up for single key press conferences, you do not need to select the Conference soft key a second time to join parties to a conference call.

Procedure

1. Call a contact.
2. When the contact answers, select the **Conference** soft key.

The call is held.

3. Enter another contact's number or select a contact from the directory or the call lists.
4. When the contact answers, select the **Conference** soft key.

All call participants are added to a conference call.

Join Calls to Create a Conference Call

You can join one active call and one held call into a conference call.

Procedure

- » Do one of the following:
 - When you have an active call and a held call, select the **Join** soft key.
 - When you have an active call and more than one held call, select a held call and then select the **Join** soft key.

The active call and the selected held call are joined into a conference. If you have multiple held calls, the other held calls on the line remain held.

End a Conference Call

By default, when you end a conference call, your connection to the call ends and the other participants in the conference remain in the call.

However, your system administrator can set up your phone so that all connections terminate when you end a conference call.

Procedure

- » During a conference call, select **End Call**.

Hold a Conference Call

When you place a conference call on hold, you place all conference participants on hold.

Procedure

- » Select **Hold** .

Resume a Conference Call

Resuming a held conference call enables all participants to hear the audio of everyone on the call.

Procedure

- » Select **Resume**.

Split a Conference Call

When you split a conference, you end the conference call and place the other two people on hold. You can split an active or held conference call. After you split a conference call, you can resume one of the held calls.

Procedure

- » During a conference call, select the **Split** soft key.

The conference call ends and the two participants are held in two separate calls.

Manage Conference Call Participants

If your system administrator enables the Conference Management feature on your phone, you can manage conference call participants in the following ways:

- Mute a participant.
- Hold a participant.
- Remove a participant from the conference.
- List information about a participant, such as the participant's name, number, and call details, including whether the call is muted, held, or is video-enabled.

This feature is not available for VVX 150 phones. Check with your system administrator to find out if this feature is available on your phone.

Procedure

1. Initiate a conference call.
2. Select **Manage**.
If you're in the Calls screen, highlight the conference first.
3. Select the participant you want to manage.
4. Do one of the following:
 - Select **Far Mute** to mute the participant. The muted participant can hear everyone, but no one can hear the muted participant.
 - Select **Hold** to hold the participant. The held participant cannot hear anyone, and no one can hear the held participant.
 - Select **Remove** to remove the participant from the conference, end the conference call, and create an active call between you and the participant still in the call.
 - Select **Information** to view information about the participant's call status. When you select **Information**, a screen is displayed listing the person's information.
5. Select **Back** to exit the conference management function.

Alcatel-Lucent Advanced Conference Calls

When you are registered with the Alcatel-Lucent CTS on your VVX phone, you can initiate impromptu audio conference calls with two or more contacts from your phone.

You can also create a participant list and manage conference participants. You can manage a maximum of 24 advanced conference calls at a time on your phone, if enabled on the server. However, you can have only one active conference call in progress on your phone.

This feature is not supported on VVX 150 phones. Check with your system administrator to find out if this feature is available on your phone.

Initiate an Advanced Conference Call

You can initiate an advanced audio conference call, add and invite contacts to the audio conference call, and have up to 24 audio conference calls on your phone. You can also initiate an audio conference call from an active call.

Procedure

1. Press **Meet Now**.

2. Press **Invite** and choose the contacts you want to add to the conference from a directory, Recent Calls, or Favorites.
3. Press **Invite**.

The Roster screen displays with a list of participants in the conference.

Initiate an Advanced Conference Call During a Call

During an active call on your phone, you can add contacts to the call to initiate a conference call.

Procedure

1. During an active call, select the **Conference** soft key.
The call is held.
2. Enter another contact's number or select a contact from the directory or the call lists.
3. When the contact answers, select the **Conference** soft key.
All call participants are added to a conference call.

Add Contacts to an Advanced Conference Call

During a conference call, the chairperson—the person who initiated the conference call—can invite additional contacts to the call.

Procedure

1. During a conference call, press **Invite**.
2. Select a contact to join the meeting.

Add Incoming Calls to an Advanced Conference Call

The conference host can join incoming calls in to a conference. Conference participants cannot add incoming calls to a conference.

Procedure

1. During a conference call, answer the incoming call.
2. Press the **Join** soft key.
The call is joined to the conference call.

Join Two Calls into an Advanced Conference Call

You can join an active call and a held call into an advanced conference call.

Procedure

- » Do one of the following:
 - When you have an active call and a held call, select the **Join** soft key.
 - When you have an active call and more than one held call, select a held call, and select the **Join** soft key.

The active call and the selected held call are joined into a conference. If you have multiple held calls, the other held calls on the line remain held.

Viewing a Roster of Conference Participants

When you initiate or join a conference call, all conference participants automatically display in a roster. The roster only displays participants in the conference call; it does not display any calls on hold.

Exit Participant Roster

When you exit the roster, you cannot view the list of conference participants.

Procedure

- » Press **Exit**.

Return to Participant Roster

You can return to the roster at anytime during an active conference.

Procedure

- » Press **Roster**.

Managing Advanced Conference Participants

From the roster, the chairperson (the person who initiated the conference call) can mute and remove individual participants from the conference.

Muting Advance Conference Participants

Chairpersons can mute all conference participants at one time or mute an individual participant.

Only chairpersons can mute and unmute conference participants. If a chairperson mutes a participant's audio, a mute icon is displayed in the roster next to each person who is muted.

Mute and Unmute All Advanced Conference Participants

Chairpersons can mute and unmute all conference participants at one time.

Procedure

1. Press **Mute All**.
2. Press **Unmute** to enable participants to speak in the conference.

Mute and Unmute Individual Advance Conference Participants

Chairpersons can choose to mute and unmute individual participants during conferences.

Procedure

1. Select a participant and press **Far Mute**.
2. Select the muted participant and press **Unmute**.

Remove Advanced Conference Participants

A chairperson can remove any participant from the conference call.

Procedure

- » In the roster, select a participant and select **Remove**.

Shared Lines

Topics:

- [Shared Line Limitations](#)
- [Answering Calls on Shared Lines](#)
- [Missed and Received Calls on Shared Lines](#)
- [Hold a Call Privately on a Shared Line](#)
- [Barge In on Calls for Busy Lamp Field Lines](#)
- [Access the Call Actions for BroadWorks Dynamic Busy Lamp Field \(BLF\)](#)
- [Ribbon Communications Multiple Appearance Directory Number - Single Call Appearance](#)
- [Alcatel-Lucent Shared Call Appearance](#)
- [BroadSoft UC-One Simultaneous Ring](#)
- [BroadSoft Executive-Assistant](#)

All VVX business IP phones support multiple and shared lines. Your administrator can customize your phone so that you have multiple shared lines enabled.

Related Links

[Missed and Received Calls on Shared Lines](#) on page 57

Shared Line Limitations

The following features are not available or have limitations on VVX business IP phones with shared lines:

- Forwarding an incoming call is not available.
- Ignoring or rejecting an incoming call on shared lines disables ringing only.
- Enabling Do Not Disturb on shared lines disables ringing only and a visual notification of the call is displayed with the option to answer the call.

Answering Calls on Shared Lines

Incoming calls to a shared line cause all registered phones to ring, and the call can be answered on any of the phones.

When you or another person answers the incoming call, a green indicator light is displayed on the line key on all phones for the shared line.

Missed and Received Calls on Shared Lines

When you have an incoming call on a shared line, which none of the phones answer, the call is displayed in the Missed Calls list on all the phones. If you have an incoming call on a shared line and you or any of the other phones answer the call, the call is not logged as missed on any phone.

Your administrator can configure the phones so that if you have an incoming call on a shared line and one phone answers, the other phones log the call as a received call. That way, if another phone on a shared line answers an incoming call, you can still view the call information from your phone's call lists even if you did not answer the call.

Related Links

[Shared Lines](#) on page 57

Hold a Call Privately on a Shared Line

You can hold a call privately on a shared line using the Private Hold feature, which places the call on hold and displays the line as busy on the other phones on the shared line.

By default, when you place a call on hold on a shared line, all of the phones registered with that line are notified of the call's held status. When the Private Hold feature is enabled, the Pvt Hold soft key is displayed, and you can hold a call privately, transfer a call, or initiate a conference call without notifying others on the shared line of the call's held state.

Check with your system administrator to find out if this feature is available on your phone.

Procedure

- » During a call, press **More > Pvt Hold**.

The call is held on your phone, and the line shows as busy on the other shared line users' phones.

When you hold a call privately, other users on the shared line cannot resume or pick up the call. However, users on the shared line can barge in on privately held calls. In order to allow other users to resume the call, you have to publicly hold the call by pressing the Hold key or soft key.

When Private Hold is enabled, you can also transfer a call or initiate a conference call without the other shared line users being notified of the call's status. When you press the Transfer or Conference soft key on the shared line, the call is held privately. If you press Hold before you transfer a call or initiate a conference, the other users on the shared line are notified of the call's held status.

Barge In on Calls for Busy Lamp Field Lines

When your phone is registered with the Alcatel-Lucent CTS, you and other contacts can barge in on active calls for Busy Lamp Field (BLF) lines you all are monitoring.

Only one contact can barge in on a call at a time. Contacts can barge in on remote held calls using the Normal barge in mode but cannot barge in on parked calls.

This feature is not supported on VVX 150 phones. Check with your system administrator to find out if this feature is available on your phone.

You can barge in on a call using one of the following modes:

- **Normal (audio and video calls)**—Initiates a conference call with you and the contacts currently in the call.
- **Whisper (audio-only)**—Enables you to barge in on audio calls only to talk to a contact in the call without the far-end hearing your audio. This mode is not available for video calls.
- **Listen (audio-only)**—Enables you to barge in to audio calls only and listen to the other parties' conversation without anyone hearing your audio. This mode is not available for video calls.

Procedure

1. During an active call, select **Barge In**.
2. On the **Barge In** screen, select a mode.

If enabled, a tone plays when you barge in to a call using any of the modes.

Access the Call Actions for BroadWorks Dynamic Busy Lamp Field (BLF)

You can access the call actions settings on the phone and modify the settings from the **Attendant Call Action** menu when dynamic BLF is configured on the phone.

You can one touch the following BLF actions on the phone:

- Dial-Pickup - Indicates the single-press action to use the BLF as a speed dial except the alerting state.
- Blind - Enables the active call to blind transfer to another user with one press of the associated BLF key.
- Park - Enables one-touch call park and retrieve using the BLF keys.

Procedure

1. On the Home Screen, go to **Settings > Basic > Preferences**.
2. Select the **Attendant Call Action** menu.
3. On the **Attendant Call Action** screen, select one of the following options:
 - Dial-Pickup
 - Blind
 - Park

Ribbon Communications Multiple Appearance Directory Number - Single Call Appearance

When your VVX phone is registered with the Ribbon Communications server, you can use the Multiple Appearance Directory Number - Single Call Appearance (MADN-SCA) feature to share a single line with other contacts as a member of a Multiple Appearance Directory Number (MADN) group.

System administrators assign members to MADN groups, which can have a maximum of 32 members. Any MADN group member can place, answer, hold, resume, or barge in on a call on a shared line. Additionally, all group members can view the status of a call on the shared line on their phones.

Check with your system administrator to find out if this feature is available on your phone.

Placing a MADN Call

Any MADN member can place a call on the shared line. When a member places a call on the shared line, the other members are notified with a steady red LED light on the line key of the members' phones.

Only one call at a time can be active on the shared line. If a call is placed to the shared line with an active call in place, the incoming call is sent to voicemail.

Answering a MADN Call

Any incoming call to the shared line rings on all group members' phones simultaneously. The call is displayed on all members' screens, and a green LED light flashes on the line's line key.

Any MADN member can respond to an incoming call to the shared line. When a MADN member answers an incoming call, the LED indicator on the line key for all phones changes to a steady red light to indicate the call was answered. Members can also view the status of a call on the shared line by pressing and holding the corresponding line key for one second. The call's status and the Barge In soft key display for five seconds.

If bridging is disabled and privacy is enabled for the shared line, you cannot barge in on active calls answered by other MADN members.

Barge In on an Active Call

After a call is answered, any group member can barge in on the active call on a public shared line, which becomes a bridge call—a call between two or more MADN members and another party.

Ask your system administrator about the maximum number of participants allowed on a bridge call.

Procedure

1. Press and hold the corresponding line key for the shared line for one second.
2. Select the **Barge In** soft key.

A bridge tone plays notifying the other call participants that you are barging in on the call.

Leave a Bridge Call

Any member in a bridge call can leave the call, and the call remains active.

After you leave a bridge call, you can rejoin by pressing the Barge In soft key again.

Procedure

- » Select the **End Call** soft key, or place the handset in the cradle.

Your connection to the bridge call is ended, and the other call participants remain on the call.

Resume a Held MADN Call

Any MADN member can resume a held call on the shared line. When an active call is placed on hold on the shared line, all group members are notified of the call's new status by a flashing red LED light on the line key on all members' phones, if enabled by your system administrator.

When a held call is resumed by another MADN member, the other group members are notified of the call's new status with a steady red LED light on the line key on the members' phone.

Procedure

- » Do one of the following:
 - Select the corresponding line key and lift the handset.
 - Press and hold the corresponding line key and select **Resume**.

Enabling Privacy for MADN Calls

Any MADN member can temporarily enable privacy for an active or bridge call on a public shared line using privacy codes or privacy soft keys configured by your system administrator.

Additionally, MADN members can use privacy codes and soft keys to temporarily disable privacy on an active call on a private shared line.

The following are three types of privacy codes that you can use to enable and disable privacy on a shared line:

- **Privacy Access (PRV) code**—Enables privacy for an active call on a public line.
- **Privacy Release Activation (PRLA) code**—Disables privacy for an active call on a private shared line.
- **Privacy Release Cancel (PRLC) code**—Re-enables privacy for an active call on a private shared line.

When a shared line is configured as private or when privacy is enabled on an active call, bridging is disabled and other MADN members cannot barge in on an active call on the shared line.

Enable Privacy

After you enable privacy for an active call on a public shared line, you cannot disable privacy for the call. You can allow other MADN members to join the active call by transferring the call or initiating a conference call.

Procedure

- » During an active call, do one of the following:
 - Select **Transfer** and dial the PRV code given to you by your administrator
For example, dial *91.
 - Select the **Priv** soft key, if enabled.

A confirmation tone plays and the call is resumed automatically.

Disable Privacy Temporarily

You can temporarily disable privacy for an active call on a private shared line to allow other MADN members to join the call.

Procedure

1. During an active call, press the **PRLA** soft key or select **Hold** and dial the PRLA code given to you by your administrator.
For example, dial *921.
A confirmation tone plays, and the call is resumed automatically. Privacy is disabled for the call and any member can barge in on the call.
2. After other MADN members have joined the call, press the **PRLA** soft key or select **Hold** and dial the PRLC code given to you by your administrator.
For example, dial *922.
A confirmation tone plays, and the call is resumed automatically.

Enable Privacy on a Bridge Call

You can enable privacy on a bridge call to prevent additional MADN members from barging in to the call.

Procedure

- » During a bridge call, select **Transfer** and dial the PRV code or select the **Privacy** soft key, if enabled.

A confirmation tone plays when privacy is enabled and the call is resumed automatically. The bridge call is now private and additional MADN members are not allowed to join the call.

Alcatel-Lucent Shared Call Appearance

When your phone is registered with the Alcatel-Lucent CTS, you can use the Shared Call Appearance (SCAP) feature to share a single line with other contacts as a member of a group. System administrators assign members to SCAP groups.

Any SCAP group member can place, answer, hold, or resume calls on the line. SCAP group members can also bridge in on a call on the shared line. Additionally, all group members can view the status of a call on the shared line on their phones. Each line supports up to 21 call appearances.

Placing a SCAP Call

Any group member can place a call on the Shared Call Appearance line.

When a member places a call on the shared line, the other members are notified with a steady red LED light on the line key on members' phones. Multiple group members can place outgoing calls while a call is in progress on the shared line.

Answering a SCAP Call

Any incoming call to the shared line rings on all group members' phones simultaneously; the call is displayed on all members' screens, and a green LED light flashes on the line key.

Any group member can respond to an incoming call to the shared line. When a group member answers an incoming call, the line key's LED indicator on all phones changes to a steady red light to indicate the call was answered. Members can also view the status of a call on the shared line by pressing and holding the corresponding line key for one second. The call's status and the Bridge In soft key display for five seconds.

Bridge In to an Active SCAP Call

Multiple group members can bridge in to one call if the call is public. After a group member bridges in to a call, the call becomes a bridge call—a call between two or more SCAP members and another party.

Ask your system administrator about the maximum number of participants allowed on a bridge call.

If the call is private or if bridging is disabled, the Bridge In soft key does not display or you cannot bridge in to active calls answered by other group members.

Procedure

1. Press and hold the line key with the active call for one second.
2. Select **Bridge In**.

If enabled, a bridge tone plays notifying the other call participants that you are bridging in on the call.

Leave a Bridge SCAP Call

Any member in a bridge call can leave the call, and the call remains active.

Procedure

- » Select the **End Call** soft key or place the handset in the cradle.
Your connection to the bridge call is ended, and the other call participants remain on the call.
You can rejoin a bridge call after leaving by pressing the **Bridge In** soft key again.

Make an Active SCAP Call Public

By default, all active calls on the shared line are private. After a call is answered, you can make the call public and enable other SCAP members to bridge in to the active call.

Procedure

- » During an active call, select **Share**.
The call is now public, the Private soft key is displayed, and other group members can bridge into the call.

Make an Active SCAP Call Private

After you make a call public and allow group members to bridge in to the call, you can make the call private to prevent more group members from bridging in to the call.

Procedure

- » During an active bridge call, select **Private**.
The call is now private and other group members cannot bridge in to the call.

Holding or Passing SCAP Calls

You can choose to hold or pass a call on the shared SCAP line. When you place a call on hold, the call is held on your phone. You are the only one that can view the held status of the call and resume the call.

Passing a call enables other group members to resume the call on the shared line.

Pass an SCAP Call

When you pass a call, you enable SCAP group members to view the held status of the call and resume the call.

You cannot pass active bridge calls on the shared line.

Procedure

- » During an active call, select **Pass**.
The call is placed on hold and all members on the shared line can view and resume the passed call.

Resume a Passed SCAP Call

Any group member can resume a passed call on the shared line.

When an active call is passed on the shared line, all group members are notified of the call's new status by a flashing red LED light on the line key on all members' phones, if enabled by your system administrator.

When a passed call is resumed by another group member, the other group members are notified of the call's new status with a steady red LED light on the line key on the members' phone.

Procedure

- » Do one of the following:
 - Select the corresponding line key and lift the handset.
 - Press and hold the corresponding line key and select **Resume**.

BroadSoft UC-One Simultaneous Ring

When your phone is registered with a BroadWorks server and you are signed into the phone with your BroadSoft UC-One credentials, you can use the Simultaneous Ring feature to add a list of up to 10 extensions and phone numbers that will ring simultaneously when you receive an incoming call on your line.

When the incoming call is answered on one of the phones added to your Simultaneous Ring list, the call is logged in the Missed Calls list on the other phones. Unanswered incoming calls are logged in the Missed Calls lists on all connected phones.

Check with your system administrator to find out if this feature is available on your phone.

Create a Personal Ring Group

Before you can add numbers to your personal ring group, you need to enable the Simultaneous Ring feature on your phone.

Procedure

1. Select **UC-One** on the Home screen or go to **Settings > Features > UC-One Call Settings**.
2. Select a line.
3. Select **Simultaneous Ring Personal**.
4. Select **Status > Enabled**.

Add Numbers to Your Simultaneous Ring List

You can add up to 10 extensions and phone numbers to the Simultaneous Ring list.

When you add an extension or a phone number, you can choose to enable Answer Confirmation Required, which notifies you when a call is answered on one of the added numbers.

Procedure

1. Select **UC-One** on the Home screen or go to **Settings > Features > UC-One Call Settings**.
2. Select a line.
3. Select **Simultaneous Ring Personal > Add**.
4. Enter an extension or phone number.
5. Select **Answer Confirmation Required** to receive confirmation that the call was answered.
6. Select **Save**.

You cannot pick up or barge in on calls answered on another phone. The contact who answers the call must transfer the call to your phone or park the call on your line for you to speak with the caller.

Delete Numbers from the Simultaneous Ring List



You can delete a number added to your Simultaneous Ring list at any time.

Procedure

1. Select **UC-One** on the Home screen or go to **Settings > Features > UC-One Call Settings**.
2. Select a line.
3. Select **Simultaneous Ring Personal**.
4. Select the numbers you want to remove and press **Delete**.

BroadSoft Executive-Assistant

The BroadSoft Executive-Assistant feature enables assistants to monitor and manage calls on an assigned executive's line and enables executives to filter calls to assigned assistants and set criteria for filtered calls.

When your system administrator assigns you as an executive or assistant, the Executive  or Assistant  menu icons and soft keys display on your phone.

Private and Shared Lines for Executives and Assistants

Executives and assistants can both have a private and shared line on their phone. Executives can have private and shared lines that are not managed by an assistant.

The following conditions apply to private or shared lines set as Executive or Assistant:

- For shared lines, the status of any executive calls display on the shared line of the executive and assistant's phone.
- Assistants can use their private line to place a call or answer calls on behalf of an executive, but neither an assistant nor executive can view the status of calls on a private line.
- For private lines, executives and assistants can pick up held calls on the executive's phone, but neither can choose which held call is picked up.

Executive Options

As an executive, you can view a list of assigned assistants, filter calls to assistants assigned to your line, and set criteria for filtered calls on your line.

Filter Executive Calls

Executives can enable Call Filtering on their phones to send all executive calls directly to an assistant to answer, and the executive is not alerted of the incoming call.

Procedure

1. On the Home screen of the executive's phone, select **Executive**.
2. Select **Call Filtering** then select **On**.

Set a Filter Criteria for Filtered Calls

Executives can determine which types of calls are filtered to an assistant by choosing whether to filter all calls, internal calls, external calls, or calls as specified in an extended filter, which executives can create and edit in the BroadSoft BroadCloud portal.

Procedure

1. On the Home screen of the executive's phone, select **Executive**.
2. Select **Filter Criteria**.
3. Choose one of the following:
 - **All Calls**
 - **Internal Calls**
 - **External Calls**
 - **Extended Filter**

Screen Executive Calls

Executives can enable Call Screening, which displays the incoming call notification for all filtered executive calls on the executive's phone.

Call Screening is only available when Call Filtering is enabled.

Procedure

1. On the Home screen of the executive's phone, select **Executive**.
2. Select **Call Screen** then select **On**.

View a List of Assigned Assistants

Executives can view a list of assigned assistants and see which assistants have opted-in or out of accepting filtered calls for the executive.

Procedure

1. On the Home screen of the executive's phone, select **Executive**.
2. Select **Assigned Assistants**.

Assistant Options

Assistants can monitor an executive's calls, place calls on behalf of an executive, filter and divert executive calls, and opt-in or out of monitoring calls for an executive.

Answering Executive Calls

When a call is placed to an executive's line and Call Filtering is enabled, the call is displayed on the assistant's phone only. Incoming call notifications for an executive call display with the executive's name in the notification on the assistant's phone. Assistants can answer, reject, or ignore any executive calls.

When Call Screening is enabled, incoming call notifications also display on the executive's phone, and the executive can choose to answer the call.

Place a Call on Behalf of an Executive

As an assistant, you can make calls on behalf of any of your assigned executives.

When a call is made on behalf of an executive, a solid red bar displays on the executive's line key, if the executive's line is a shared line.

Procedure

1. On the Home screen of the assistant's phone, select **Assistant**.
2. On the **Overview Executive** screen, select **Executives** then choose an executive.

3. Select **On behalf** and enter the contact's number or choose a contact from Recent Calls or the directory.
4. Select **Dial**.

The executive's caller information displays on the third-party's phone.

Push a Call to the Executives Phone

As an assistant, after you answer an executive call, you can push the call to the executive's phone.

You can only push a call to an executive you are assigned to. You cannot push executive calls to other assistants or contacts.

Procedure

- » During an executive call, select **Push**.

The call is sent to the executive's phone, which rings to alert the executive of the pushed call. If the executive is unavailable to answer the call, the call is returned to the assistant's phone.

Opt In or Opt Out of being an Assistant for an Executive

As an assistant, you can choose to opt in or opt out of being an assistant and monitoring calls for an executive.

When you opt in to being an assistant, you can monitor and manage all filter calls to the executive. When you opt out, you no longer receive filtered executive calls and cannot manage or monitor executive calls.

Procedure

1. On the Home screen of the assistant's phone, select **Assistant**.
2. Select **Executives** then choose an executive.
3. Select **Status** then do one of the following:
 - Select **On** to opt in to being an assistant for an executive.
 - Select **Off** to opt out of being an assistant for an executive.

Divert Filtered Executive Calls

As an assistant, you can choose to divert filtered calls for all assigned executives to another assistant, contact, or phone.

Procedure

1. On the Home screen of the assistant's phone, select **Assistant**.
2. Select **Call Diversion** then select **On**.
3. Enter the number where you want to divert executive calls.

Pick Up a Held Executive Call on a Shared Line

Executives and assistants can both pick up held calls on shared or private executive lines.

On shared lines, the executive and assistant can view the status of calls on both phones and choose which call to pick up.

Procedure

1. Press and hold the line key with the held call.
2. Select the held call, and select the **Pick Call** soft key.

Pick Up a Held Executive Call on a Private Line

On private lines, the executives and assistants can pick up held calls on each other's phones, but they cannot view the status of a call or choose which held call to pick up.

Procedure

1. On the Home screen of the assistant's phone, select **Assistant**.
2. Select an executive, then select **Pick Call**.

Barge In on an Executive Call

When there is a call on the executive's line, the executive or the assistant can barge in on the call.

When you barge in on the call, all parties are notified that you have barged in on the call, and you can talk with the other parties on the call.

Procedure

1. During an active call on the executive's line, press and hold the executive line key.
2. Select the **Barge In** soft key.

Silently Barge In on an Executive Call

In addition to barging in on a call, executives can silently barge in on the call and listen to the call without anyone knowing the executive is on the call.

When an executive silently barges in on a call, the other parties are not notified, no one can hear the executive's audio, and the executive cannot talk to the other parties on the call.

Assistants cannot silently barge in on executive calls.

Procedure

1. During an active call on the executive's line, press and hold the executive line key.
2. Select the **S-Barge In** soft key.

Recording Audio Calls

Topics:

- [Guidelines when Recording Calls](#)
- [Record a Call](#)
- [Manage a Call while Recording](#)
- [Pause a Recording](#)
- [Resume a Recording](#)
- [Stop Recording](#)
- [Record a Conference Call](#)
- [Browse Recorded Calls](#)
- [Play a Recorded Call](#)
- [Pause and Resume Played Recordings](#)
- [Stop Playing a Recording](#)
- [Rename a Recording](#)
- [Delete a Recording](#)

On VVX 250, 350, and 450 phones, you can record audio calls onto a USB flash drive connected to your phone.

Recordings are stored as .wav files on the USB flash drive, and you can record up to four hours in one file. You can replay recordings on the system or on a computer.

For a list of supported USB flash drives to record phone audio, see *Technical Bulletin 38084: Supported USB Devices* on [Polycom Support](#).

Note: If your phone doesn't detect the USB device when you insert it into the USB port, the USB port on your phone may be disabled. Contact your system administrator for assistance using the USB port.

Guidelines when Recording Calls

The following is a list of guidelines to follow when recording audio calls:

- Inform contacts when you are recording a call.
- Make sure you mute your audio when you are placed on hold while recording the call. When you place a call on hold while recording, the recording pauses. However, when another person places you on hold, the recording continues.
- During an active call, pause your recording before answering incoming calls. All incoming calls you answer after you start recording are also recorded in the same file. For example, on June 22, 2012, at 11:22 a.m., you answer a call from person A. During your call with person A, you answer calls from person B and person C. All three calls are recorded in the same file.

Record a Call

You can record all active audio calls on the phone.

You cannot record calls when there are no connected calls, when you place a new call to transfer a call or initiate a conference, or when you have an incoming call. Make sure to inform your contacts on the call before you begin recording.

Note that some tones made on your contact's phone are recorded. When you mute the microphone while recording, your audio is muted and only other participants' audio in the call is recorded.

Procedure

- » During an active call, select **Record > Start**.
The message "Recording in progress" is displayed in the status bar.

Manage a Call while Recording

You can hold, end, transfer, or set up a conference call while you record or while a recording is paused.

Procedure

1. During a recording, select **Back** and choose a task to perform.
2. Select **Record** to view the Recording options.

Pause a Recording

During a call, you can pause a recording while the call is active.

Procedure

- » Select **Pause**.
The message "Recording Paused" is displayed in the status bar.

Resume a Recording

After you pause and then resume recording, recording continues in the same file.

Procedure

- » Select **Resume**.

Stop Recording

You can stop recording a call before the call ends. The recording also stops when the active call ends, no matter who ended the call.

Caution: Do not remove the USB flash drive while recording. The file being recorded will be incomplete and cannot be played back later. Removing the USB flash drive while recording can also damage the flash drive.

Procedure

- » Do one of the following:
 - Select **Stop**.
 - Select **Back > End Call**.

When you stop recording, the USB icon is displayed in the status bar.

Record a Conference Call

You can record a conference call in the same way as an active call with the following exceptions:

- All conference call participants are recorded. When a conference participant mutes their audio, that participant is not recorded.
- When you place a conference call on hold, the recording pauses. You can place or answer other calls, which are recorded in the same file. When you resume the conference call, the recording resumes.

Procedure

- » During an active call, select **Record > Start**.
The message “Recording in progress” is displayed in the status bar.

Browse Recorded Calls

You can browse recorded files stored on the USB drive connected to supported Poly VVX[®] Business IP Phones.

Procedure

- » Go to **Settings > Features > Removable Storage Media > Browse Recordings**.
A list of recordings display.

Play a Recorded Call

You can play back calls that you recorded on a USB drive connected to Poly VVX[®] Business IP Phones.

If the handset is off-hook when you play a recording, the audio plays through the handset. If the handset is on-hook when you play a recording, the audio plays through the speaker.

Note: You cannot open and play recordings when you are in an active call or if you're recording a call. If you try to, a message indicating that the action was canceled is displayed. Place the call on hold before playing the recordings. The recording stops playing when you resume the call.

Procedure

1. Go to **Settings > Features > Removable Storage Media > Browse Recordings**.
A list of recordings display.
2. Select a recording.
3. Select **Open > Play**.
The length of the recording and a progress bar is displayed as the recording plays.

Pause and Resume Played Recordings

While playing a recording, you can pause the recording, perform another task on the phone, and resume the recording at any time.

When you receive an incoming call while playing a recording, the recording is paused automatically. If you do not answer or reject the incoming call, the recording remains paused until you select **Resume**.

Procedure

1. While the recording plays, select **Pause**.
2. Select **Resume** to continue playing the recording.

Stop Playing a Recording

When you are finished listening to a recording, you can stop playing it by exiting the recording.

Procedure

- » Select **Exit**.

Rename a Recording

By default, recordings are labeled with the date of the recording. You can rename recordings to provide them with more meaningful names.

Procedure

1. Go to **Settings > Features > Removable Storage Media > Browse Recordings**.
A list of recordings display.
2. Select a recording.
3. Select **Rename**, update the file name, and select **OK**.

Delete a Recording

When you have played a recording or need additional space on your USB drive, you can delete recordings from the phone.

Procedure

1. Go to **Settings > Features > Removable Storage Media > Browse Recordings**.
A list of recordings display.
2. Select a recording.
3. Select **Delete**.

Call Lists and Directories

Topics:

- [Recent Calls](#)
- [Contact Directory](#)
- [Corporate Directory](#)
- [BroadSoft Directories on Poly VVX Business IP Phones](#)
- [Managing the Ribbon Communications Address Books](#)

All VVX phones support a Recent Calls list, a Contact Directory and a Corporate Directory.

The phones can also support a BroadSoft Directory and the Ribbon Communications Address Books depending on your server and if enabled by your system administrator.

Note: Your phone may not support all of the features described in this section. Check with your system administrator to find out which features are available on your device.

Recent Calls

The Recent Calls list on VVX business IP phones includes missed, received, and placed calls. Each list holds up to 100 entries.

You can perform the following tasks from the Recent Calls list:

- Sort, order, and filter calls. By default, the list displays all call types with the most recent call displaying first.
- Remove calls from the list.
- Select a call record to view call details.
- Select a call record to automatically call a contact.

View Recent Calls

In the Recent Calls list on VVX phones, you can view a list of up to 100 missed, received, and placed call entries.

Procedure

- » Navigate to **Directories > Recent Calls**.

Sort Recent Call Entries

You can sort the Recent Calls list to view calls by call type, time, and call name.

When you sort calls by the time of the call, you can order them in ascending (oldest call first) or descending (most recent call first) order. When you sort calls by name, you can order them in ascending (alphabetical) or descending (reverse-alphabetical) order.

Procedure

1. Select **Sort**.
2. Under **Sort**, choose **Time** or **Name**.
3. Under **Order**, choose **Ascending** or **Descending**.

Sort Entries by Call Type

When you filter calls, you can choose to display only missed, received, or placed calls. You can also choose to display all call types (the default).

Note: You cannot save your filtered call list results. If you filter your Recent Calls list so that only a certain call type displays, the next time you display the list, all call types display in the default filter.

Procedure

1. Select **Type**.
2. Choose **Missed Calls**, **Received Calls**, or **Placed Calls**.

View Call Details

In the Recent Calls list, you can view call details, edit call details before calling a contact, save a contact to your directory, and delete call entries.

Procedure

- » Select **Info** next to a call record.

Edit a Recent Call Entry

You can edit a contact's phone number stored in your Recent Calls list before returning the contact's call.

Procedure

1. Select **Info** next to a call record.
2. Select **Edit**.
3. Edit the number and select **Dial**.

Delete a Recent Call Entry

You can delete any recent call entry from the Recent Calls list.

Procedure

1. Select **Info** next to a call record.
2. Select **Delete**.

Save a Recent Call Entry

You can save a recent call entry to the Contact Directory.

Procedure

1. Select **Info** next to a call record.
2. From the **Call Details** screen, select **Save**.

If the person is already in your Contact Directory but is not a favorite, **Add to Favorites** is displayed.

Contact Directory

You can store a large number of contacts in the Contact Directory on VVX business IP phones, as well as add additional contacts, view and update a contact's information, and delete contacts from the directory.

Contact your system administrator for the exact number of contacts you can store in the Contact Directory for your phone model.

Note: If you cannot add or edit contacts in the Contact Directory, your system administrator has set the directory as read-only. Contact your system administrator for assistance making any changes to the contacts stored in the directory.

Search for a Contact in the Contact Directory

You can search for your desired contact in the Contact Directory.

Procedure

1. Navigate to **Directories > Contact Directory**.
2. In the **Contact Directory**, select **Search**.
3. In the search field, enter your search criteria and select **Submit**.

Add a Contact to the Contact Directory

When you add a contact to your Contact directory, you can choose how much information you want to enter for your contact. You are required to only enter a contact number for each new contact.

The following is a list of information you can enter for each contact:

- First and Last Name—The name of your contact
- Contact—Your contact's phone number
- Job Title—Your contact's position
- Email—Your contact's personal or work email address
- Favorite Index—An index number that displays in your Favorites list
- Label—A label or title for your contact

Note: If your phone does not display all of these contact fields, contact your system administrator. The only required field in the Contact Directory is the Contact field, which includes the contact's phone number.

Procedure

1. Navigate to **Directories > Contact Directory**.
2. In the **Contact Directory**, select **Add**.
3. From the **Add Contact** screen, enter your contact's information in the available fields.
You are required to only enter a number in the **Contact** field when adding a new contact to the directory. You can choose to enter additional information.
4. Select **Save**.

View Contact Information

From your Contact Directory, you can view information, such as name and phone number, for any contacts saved to the directory. You can also view additional information, such as a job title, label, or email address.

Procedure

1. Navigate to **Directories > Contact Directory**.
2. From the **Contact Directory**, select a contact.

Update a Contact's Information

After you add a contact to your Contact Directory, you can update the contact's information.

Procedure

1. From the **Contact Directory**, select a contact.
2. From the **Contact Information** screen, select **Edit**.
3. On the Edit Contact screen, update the contact's information.
4. Select **Save**.

Delete a Contact from the Contact Directory

You can delete any contact from the Contact Directory.

Procedure

1. Navigate to **Directories > Contact Directory**.
2. From the **Contact Directory**, select a contact.
3. From the **Contact Information** screen, select **Delete**.
A confirmation message is displayed, confirming that you want to delete the contact.
4. Select **Yes** to delete the contact.

Corporate Directory

Your system administrator can set up your phone so that you can access a Corporate Directory, which lists contacts and groups within your company.

However, you cannot update the Corporate Directory, and your system administrator determines which contacts you can see. Check with your system administrator to find out if this feature is available.

Note: You may need to enter your user credentials to access the directory for the first time, if set by your system administrator.

Searching the Corporate Directory

In the Corporate Directory, you can perform a quick or advanced contact search.

Search the Corporate Directory

You can search for contacts in the Corporate Directory using either their first name or last name.

Procedure

1. Navigate to **Directories > Contact Directory**.
2. In the search field, enter your search criteria and select **Submit**.
3. Select a contact and select **View** to view the contact's information.

Perform an Advanced Search of the Corporate Directory

An advanced search enables you to choose to search for contacts by first name, last name, or phone number.

Procedure

1. Navigate to **Directories > Corporate Directory**.
2. In the **Corporate Directory**, select **AdvFind**.
3. In the search field, enter your search criteria and select **Submit**.
4. Select a contact and select **View** to view the contact's information.

Save Corporate Directory Search Results

Save your last search results if you would like to see them displayed in the Corporate Directory the next time you view it.

Procedure

1. Go to **Settings > Basic > Preferences**.
2. Select **Corporate Directory > View Persistency** and select **Enabled**.

Each time you view the Corporate Directory, your last search results automatically display.

Clear Corporate Directory Search Results

After you search for a contact, you can clear your search results and start a new search.

Procedure

- » On the **Search** screen, select **Clear**.

Add Corporate Directory Contacts to the Contact Directory

You can add contacts in the Corporate Directory to the Contact Directory.

When you save a Corporate Directory contact to the Contact Directory, the first name, last name, and phone number of the contact are automatically saved to the directory. You can add additional contact information after the contact is saved to the directory.

Procedure

1. In the **Corporate Directory**, search for a contact.
2. From the search results, select the contact and select **View**.
3. Select **Save**.
4. Enter any additional contact information and select **Save**.

BroadSoft Directories on Poly VVX[®] Business IP Phones

If enabled by your system administrator, you can access, search for, and call contacts in any of your company's BroadSoft directories from any phone.

You can access the following BroadSoft directories from you phone:

- **Enterprise Directory**—contains a list of all contacts within the organization and enables you to search for contacts by name or department.
- **Enterprise Common Directory**—contains a list of common contacts within the organization.
- **Group Directory**—contains a list of groups within an organization and enables you to view and search for contacts within those groups.
- **Group Common Directory**—contains a list of contacts that are common across various groups within the organization.
- **Personal Directory**—contains a list of contacts saved in your personal directory on the BroadSoft server.

View a List of BroadSoft Contacts

You can view a list of contacts within your organization from any BroadSoft Directories available on your phone.

Within the directories, you can view a contact's name, job title, and any available phone numbers or extensions.

Procedure

1. Navigate to **Directories**.
2. Select one of the following BroadSoft directories:
 - **Enterprise Directory**
 - **Enterprise Common Directory**
 - **Group Directory**
 - **Group Common Directory**
 - **Personal Directory**

Searching the BroadSoft Directory

You can access and search the BroadSoft Directory on the phone, and you can choose to perform a simple or advanced search for contacts.

After the system administrator configures the Enterprise directory, you can view a list of contacts by default in the BroadSoft directory. The default contacts list is displayed even when no text is entered in the search box of the directory.

The BroadSoft Directory is not supported on VVX150 phones. Check with your system administrator to find out if this feature is available on your phone.

Perform a Simple Search of the BroadSoft Directory

A simple search enables you to search for contacts using either their first name, last name, or by typing a few letters of their name. A maximum of 50 contacts are available for viewing at one time.

Procedure

1. Navigate to **Directories** and select a BroadSoft directory.
A default list of contacts is displayed.
2. In the search field, enter your search criteria and select **Submit**.

Perform an Advanced Search of the BroadSoft Directory

An advanced search enables you to choose to search for contacts by first name, last name, or phone number.

Procedure

1. Navigate to **Directories** and select a BroadSoft directory.
A default list of contacts is displayed.
2. Select **Advanced Search** in the BroadSoft Directory.
3. On the **Advanced Search** screen, choose to search for a contact by first name, last name, or a contact number.
4. Optional: Do one of the following:
 - Select **Cs.Sn** to make the search case-sensitive.
 - Select **Cs.In** to make the search case-insensitive.
5. In the search field, enter your search criteria and select **Submit**.
6. Choose your contact.
A contact details screen is displayed.

Add BroadSoft Contacts to the Contact Directory

After you find your BroadSoft contact, you can add the contact to the Contact Directory.

The first and last name and phone number of the contact are saved to the Contact Directory. You can go to the Contact Directory to see if the contact was saved correctly and to add additional contact information.

Procedure

- » In the contact details screen, select **Save**.

Managing a Personal BroadSoft Directory

If enabled by your system administrator, you can view and edit contacts in your Personal Directory on the BroadSoft Server from supported VVX business IP phones .

Add a Contact to the Personal BroadSoft Directory

You can add a new contact to the Personal Directory from your phone and store the contact's name and phone number to the directory on the phone and the BroadSoft server.

When you add a new contact to the Personal Directory, you are only required to add a phone number for the contact in the Contact field.

Procedure

1. Navigate to **Directories > Personal Directory**.
2. On the **Add Contact** screen, enter your contact's information in the available fields.
3. Select **Save**.

Update a Contact's Information in the Personal BroadSoft Directory

If your contact's name or phone number changes, you can update your contact's information stored in the Personal Directory.

Procedure

1. Navigate to **Directories > Personal Directory**.
2. Select a contact.
3. From the **Contact Information** screen, select **Edit**.
4. Edit your contact's name or number.
5. Select **Save**.

Delete a BroadSoft Contact from the Personal Directory

You can delete any contact from the Personal Directory.

Procedure

1. Navigate to **Directories > Personal Directory**.
2. From the **Contact Information** screen, select **Delete**.
A confirmation message is displayed, confirming that you want to delete the contact.
3. Select **Yes** to delete the contact.

Managing the Ribbon Communications Address Books

When your phone is registered with the Ribbon Communications server, you can access your Global Address Book and Personal Address Book on your VVX phone.

Check with your system administrator to find out if this feature is available on your phone.

Using the Global Address Book

Ribbon Communications Global Address Book (GAB) is a read-only directory similar to the Corporate Directory, which is a company directory enabled and populated with contacts by your system administrator.

Using the GAB, you can perform simple and advanced searches and save contacts to the Contact Directory or Personal Address Book (PAB). You can access the GAB from the Features and Directory menu on all VVX phones.

Perform a Simple Search of the Global Address Book

A simple search enables you to search for contacts using either their first or last name or by typing a few letters or their name.

Procedure

1. Navigate to **Directories > Global Address Book**.

2. In the search field, enter your search criteria and select **Submit**.

Perform an Advanced Search of the Global Address Book

An advanced search lets you search for contacts by first or last name or phone number.

Procedure

1. Navigate to **Directories > Global Address Book**.
2. In the Global Address Book screen, select **AdvFind**.
3. Select a search option and select **Next**. You can choose to search by a contact's last name, first name, or phone number.
4. Enter your search criteria and press **Next**.

Your search results display with the contact's name and phone number.

Save a Global Address Book Contact to the Contact Directory

If you want to modify a GAB contact's information, you need to save the contact to the Contact Directory or the Personal Address Book, if enabled.

When you save a contact to the Contact Directory or PAB, you can modify and save the contact's information in the PAB or Contact Directory.

Procedure

1. After you find your contact, select **View**.
2. In the **Edit Contact** screen, select **Save**.

The contact is saved to the Contact Directory or your Personal Address Book.

Save Global Address Book Search Results

For the GAB, you can also enable View Persistency, which lets you view your most recent search results in the GAB after you have left the Directory screen.

Procedure

1. Go to **Settings > Basic > Preferences**.
2. Select **Global Address Book > View Persistency** and select **Enable**.

View Persistency is enabled and you can view your most recent search each time you return to the GAB.

Using the Personal Address Book

Additionally, you can search for contacts, edit contact information, and save contacts to the PAB. You can access the PAB from the Features or Directory menu on all VVX phones.

Note: Before importing contacts to your Polycom phone, make sure you save all of your contacts to your PAB using your Ribbon Communications Personal Agent on your computer. Saving all of your contacts to the PAB ensures that your contacts are downloaded to the Contact Directory on your phone.

View Contacts in the Personal Address Book

Contacts saved to your PAB display in the Contact Directory on VVX phones.

Procedure

1. Navigate to **Directories > Contact Directory**.
2. Select a contact and select **Edit**.

The contact's information, including first and last name, directory number, nickname, and other details are displayed.

Search Your Personal Address Book

You can search for contacts in the PAB by first name or last name.

Procedure

1. In the **Contact Directory** screen, select **Search**.
Select **More** if you do not see the Search soft key.
2. In the search field, enter your search criteria and select **Submit**.

Add Contacts to the Personal Address Book

When you add a new contact to the PAB, you must enter a unique nickname that is at least one character long for each new contact. If you try to save a contact without a nickname, a message asking you to enter a nickname is displayed.

Procedure

1. In the **Contact Directory**, select **Add**.
2. Enter your contact's information, create a nickname for the contact, and select **Save**.
The contact is added to the Contact Directory on your phone and to the PAB on the server.

Delete Contacts from the Personal Address Book

When you delete a contact, the contact is deleted from your PAB on your phone and the Ribbon Communications Personal Agent.

Procedure

1. In the **Contact Directory** screen, select a contact and select **Delete**.
A message asking for confirmation to delete the contact is displayed.
2. Select **Yes** to delete the contact.

Editing Contacts in the Personal Address Book

You can edit contacts in the PAB on your phone or in your Ribbon Communications Personal Agent on your computer.

If you modify a contact's information on your phone or computer, the changes are automatically updated in the Ribbon Communications Personal Agent and in the PAB on your phone.

Edit Contacts Locally

You can edit PAB contacts locally on your phone. When you edit contacts on your phone, your contact's information is updated in the Ribbon Communications Personal Agent as well.

Procedure

1. In the **Contact Directory** screen, select a contact and select **Edit**.

2. Edit the information in the contact fields and select **Save**.

Note: If adding, editing, or deleting a contact fails, a message is displayed with the reason the modification failed. Depending on the reason for the failure, the database state can change to “out of sync”. Contact your system administrator if an “out of sync” message is displayed.

Editing Contacts Remotely

When you edit a contact's information in the Ribbon Communications Personal Agent on your computer, the contact's information is updated on the Ribbon Communications Server.

After the contact information is updated on the server, your PAB contact's information is updated immediately on your phone, and a notification with the nickname of the modified contact is displayed on the phone. When a contact is deleted, the phone deletes the contact from the PAB without any notification.

Favorites and Contact Lists

Topics:

- [Managing Favorites](#)
- [Using Buddy Lists](#)
- [Managing BroadSoft UC-One Favorites and Contacts](#)

On your VVX phone, you can add contacts as favorites, view and manage BroadSoft UC-One contacts, and watch contacts in your Buddy list.

Note: Your phone may not support all of the features described in this section. Check with your system administrator to find out which features are available on your phone.

Related Links

[Assigning Contacts and Favorites to VVX EM50 Expansion Modules](#) on page 139

Managing Favorites

Favorites are the contacts in your Contact Directory that you will call most often. You can add contacts as favorites from the Contact Directory, designate an index number for favorites, view favorites on the Home or Lines screen depending on your phone, and delete favorites.

Add Favorites

Contacts that you add as favorites display in the Lines screen and in the Favorites list on all VVX phones. A star displays in the Contact Directory for contacts saved as favorites.

Procedure

1. Navigate to **Directories > Contact Directory**.
2. From the **Contact Directory**, select a contact.
3. Select **Add** or **Add to Favorites**.

A notification is displayed asking if you want to automatically accept the next available index number or manually enter your own.

4. Select **Yes** to automatically accept an index number or select **Edit Index** to enter a unique index number.

You can enter a number up to 99 for VVX 150 phones or 9999 for all other VVX phones.

Viewing Favorites

You can view favorites on your VVX phone in the Favorites list in the Directory or the New Call screen. Favorites display consecutively according to their index number. The contact with the lowest number is displayed first.

View Favorites

You can view favorites in the Favorites lists from the New Call screen on your VVX phone.

Procedure

- » Select **New Call > Favorites**.

View Favorites from the Lines Screen

You can view a list of favorites on the Lines screen on all VVX phones.

Procedure

- » From the **Home** screen, press the Home key .

Reorder Favorites

You can change the order in which your favorites display on the Home or Lines screen.

Procedure

1. From your **Contact Directory**, select a contact.
2. From the **Contact Information** screen, select **Edit**.
3. From the **Edit Contact** screen, select **Favorite Index** and enter a new favorite index number.
4. Select **Save**.

Delete Favorites

You can delete favorites to make room for new favorites.

Procedure

1. From the **Contact Directory**, select a contact.
2. From the **Contact Information** screen, select **Edit**.
3. From the **Edit Contact** screen, select **Favorite Index**, and delete the favorite index number.
4. Select **Save**.

Tip: To quickly delete a contact, on the Lines screen, press and hold the favorite until the Contact Information screen is displayed. Select **Delete**. The contact remains in your directory, but is no longer a favorite.

Using Buddy Lists

A Buddy list is a list of users whose status or presence you can monitor. Users can update their presence setting to a status such as “Be right back”, “Out to lunch”, or “Busy”, and you can view their status in real time from your Buddy list. You can also view your buddies' status from the Lines and Home screens, if your buddy is a favorite.

Add Contacts to Your Buddy List

If you want to monitor contacts' status, add them to your Buddy list.

You add people to your Buddy list from your Contact Directory, so you must first add them to your Contact Directory before adding them to your Buddy list.

Procedure

1. From the **Contact Directory**, select a contact.
2. From the **Contact Information** screen, select **Edit**.
3. From the **Edit Contact** screen, select **Watch Buddy > Enabled**.

The default setting is Disabled. When enabled, the contact is added to your Buddy list so you can monitor the contact's status.

4. Select **Save**.

View Your Buddy List

When you enable the Watch Buddy setting for a contact, the contact is displayed in your Buddy list.

Procedure

- » From the Lines screen, select **Buddies**.

Tip: You can quickly dial a buddy from your Buddy list. From the Lines screen, select **Buddies**, select the buddy you want to call, and select **Dial**.

Monitor Contacts on Your Buddy List

You can monitor your buddies from your Buddy list. If a buddy is a favorite, you can also monitor the buddy from the Home and Lines screen.

Procedure





- » Do one of the following:
 - Select **Buddies** or navigate to **Settings > Features > Presence > Buddy Status**.
 - Press the Home key  to navigate to the Lines screen.

Buddies' Presence Information

Your buddies display an icon next to their name to indicate their status.

The following table shows the general icons and the status they represent.

Buddy Status and Icons

Buddy Status	Icon
Available	
Busy	
Away	
Do Not Disturb	
Offline	

View Your Watcher List

Contacts who can monitor your phone's status are added to the Watcher list.

Procedure

1. Navigate to **Settings > Features > Presence**.
A list of contacts that can monitor your status is displayed.
2. Select **Watcher List**.

Block Contacts from Viewing Your Status

You can prevent someone from monitoring you by blocking the contact in your Contact Directory.

If you unblock the contact, the contact can add you to their Buddy list and monitor you.

Procedure

1. From the **Contact Directory**, select a contact.
2. From the **Contact Information** screen, select **Edit**.
3. From the **Edit Contact** screen, select **Block Buddy > Enabled**.
The default setting is Disabled. When enabled, the contact cannot watch your status, and the contact is displayed in your Blocked List.
4. Select **Save**.

View a List of Blocked Contacts

Contacts who cannot monitor your phone's status are added to the Blocked List.

Procedure

1. Navigate to **Settings > Features > Presence**.
A list of contacts that cannot monitor your status is displayed.
2. Select **Blocked List**.

Unblock a Contact

From the Blocked list, you can unblock contacts and allow them to monitor your phone's status.

Procedure

1. Navigate to **Settings > Features > Presence**.
2. Select **Blocked List**.
3. From the **Blocked List** screen, select a contact.
4. Select **Unblock**.
The contact can now monitor your status and is displayed in the Watcher list.

Managing BroadSoft UC-One Favorites and Contacts

You can see your BroadSoft UC-One contacts marked as favorites in the UC-One Contacts list and on the Lines screen on VVX business IP phones.

The VVX 150 phones do not support BroadSoft UC-One favorites. Contact your system administrator to find out if this feature is available on your phone.







BroadSoft UC-One Contacts' Presence Information

UC-One contacts are Enterprise Directory contacts that have Instant Messaging and Presence (IM&P) enabled, and you can view their presence information on your phone.

While you can view UC-One contacts presence information on the Lines screen, you cannot change your presence status on the phone. You can change your presence status only in the BroadSoft UC-One client on your computer.

The following table shows the presence icons that display for BroadSoft UC-One contacts on your phone.

BroadSoft UC-One Contact Presence Icons

Icon	Description
	Available
	Available - In a call
	Away
	Busy
	Unavailable
	Offline, Unknown

Viewing BroadSoft UC-One Contacts and Favorites

You can view UC-One contacts and favorites from your phone on the Home and Lines screen and in the Contacts list. You can also view BroadSoft UC-One groups and contacts in each group.

You cannot mark UC-One contacts as favorites on your phone. You must mark contacts as favorites in the BroadSoft UC-One client on your computer. Contacts marked as favorites in the BroadSoft UC-One client display on your phone after one minute.

Note: If the message “Authentication failure” is displayed when you try to view UC-One contacts, make sure you entered the correct BroadSoft UC-One credentials on your phone.

View BroadSoft UC-One Contacts and Favorites

You can view UC-One contacts with presence information and other UC-One contacts marked as favorites on the Lines screen.

Procedure

- » From the **Home** screen, press the Home key .

UC-One contacts and favorites display on the Lines screen.

View BroadSoft UC-One Favorites in the Contact List

In addition to viewing UC-One favorites on the Lines screen, you can also view your favorites in the UC-One Contacts list.

Procedure

1. Select **Directories > UC-One Contacts**.
2. Select the group name to view the list of contacts for that group.

View BroadSoft UC-One Groups

You can access your BroadSoft UC-One groups on your phone, but you cannot create new groups, delete existing groups, or move contacts from one group to another on your phone. You can alter groups only in the BroadSoft UC-One client on your computer.

Procedure

- » Select **Directories > UC-One Contacts**.
Your UC-One groups display. If there are no user-defined groups, contacts display under the **All Contacts** group.

View Aggregated Self-Presence for BroadSoft Lines

You can view the aggregated self-presence received from the BroadSoft Messaging Server (UMS) on the VVX phone's home screen.

Procedure

- » From the **Home** screen, press the Home key .

Filter BroadSoft UC-One Favorites

You can filter your list of contacts either by Favorites or by your contact's status.

Procedure

1. Select **Directories > UC-One Contacts**.
2. Select **Filter**.
A filter selection screen is displayed.
3. Choose your desired filter selection:
 - Select **Favorites** to display only your BroadSoft UC-One Favorites on the Home screen and in the UC-One Contacts list.
 - Select **Online** to display only the BroadSoft UC-One contacts that are currently online on the Home screen and in the UC-One Contacts list.

Search for BroadSoft UC-One Contacts

You can search for UC-One contacts from the UC-One Contacts screen.

Note: For more information on Using BroadSoft applications, refer to web pages [BroadSoft UC-One](#) and [BroadSoft Instant Messaging & Presence](#).

Procedure

1. Select **Directories > UC-One Contacts**.

2. Select **Search**.
3. Enter your contact's first or last name.
A list of search results display.

Accessing, Sending, and Broadcasting Messages

Topics:

- [Accessing Voice Messages](#)
- [Instant Messaging](#)
- [Broadcasting Messages with Group Paging](#)
- [Broadcasting Messages with Push to Talk](#)

You can access, send, and broadcast a variety of audio and written messages.

Note: Your phone may not support all of the features described in this section. Check with your system administrator to find out which features are available on your phone.

Accessing Voice Messages

Your phone indicates when you have new voicemail and video messages in the following ways:

- The Message icon on the Home screen displays the number of new messages you have.
 - A Message icon with the number of messages is displayed in the status bar.
 - The Message icon is displayed next to the phone line on the Lines screen.
 - A red flashing Message Waiting Indicator, located at the top-right of your phone.
 - An audible alert.
-

Note: Contact your system administrator or service provider for information on setting or changing your voicemail greeting.

Access Voicemail Messages

Voicemail is available on all Polycom VVX phones.

Note: For information on remotely accessing your voicemail, contact your system administrator or service provider.

Procedure

1. Go to **Messages**.
2. Select **Message Center**.
3. If you have multiple lines on your phone, select the line that has the new message.
4. From the **Messages** screen, select **Connect** and follow the prompts to access your messages.

Remove the Message Alert

If you are not ready to listen to your messages when you receive new messages, you can temporarily remove the message alert.

Procedure

1. Go to **Messages**.
2. Select **Message Center**.
3. Select **Clear**.

All message indicators are removed for approximately one to two hours.

Instant Messaging

You can send and receive instant messages from your phone to other phones on your network.

Instant messaging is an optional feature. Contact your system administrator to find out whether instant messaging is enabled on your phone.

Send Instant Messages

When you send a message, you can either select a message from a preset list of short messages, or you can use the dial pad or onscreen keyboard to enter a custom message.

Procedure

1. Go to **Messages**.
2. Select **Instant Messages**.
3. If you have multiple lines on your phone, select a line.
4. From the **Instant Messages** screen, select the **New** soft key.
5. Enter a contact's phone number, URL, or IP address and select **OK**.
The phone number, URL, or IP address you entered is displayed on the screen.
6. Do one of the following:
 - Press **Select** to choose a pre-scripted message from the **Message Select** screen.
 - Select **Edit** to compose a custom message, and enter your message.
7. Select **Send**.

Read Instant Messages

Instant messages display in the order they are received with the first message received displaying first.

Procedure

1. Go to **Messages**.
2. Select **Instant Messages**.
3. If you have multiple lines on your phone, select a line.
The first message received is displayed.
4. Select the **Next** or **Previous** soft key to read additional messages, if available.

Reply to Instant Messages

After you read an instant message on your phone, you can send a reply to the message.

Procedure

1. Go to **Messages**.
2. Select **Instant Messages**.
3. From the **Instant Messages** screen, select a message and select **Reply**.
4. Enter a message and select **Send**.

Delete Instant Messages

You can choose to delete instant messages from your phone.

Procedure

1. Go to **Messages**.
2. Select **Instant Messages**.
3. Select a message and select **Delete**.

Broadcasting Messages with Group Paging

Group Paging enables you to send pages—one-way audio announcements—to contacts subscribed to a page group.

Your administrator can enable VVX business IP phones to operate in a broadcast mode called Group Paging mode. In this mode, you can broadcast one-way announcements to a specified group of phones, called a Paging Group.

Your system administrator can define up to 25 paging groups and assign a label to each group to identify the phones in the group, such as All, HR Dept, Shipping Staff, or Executives.

Each group has one of the following priorities:

- **Normal**—By default, broadcasts sent to groups 1 to 23 are considered Normal broadcasts. By default, all phones are configured to receive broadcasts sent to group 1.
- **Priority**—By default, broadcasts sent to group 24 are considered Priority broadcasts. A Priority broadcast interrupts Normal broadcasts or active calls. All phones receive Priority broadcasts unless Do Not Disturb is enabled.
- **Emergency**—By default, broadcasts sent to group 25 are considered Emergency broadcasts. An Emergency broadcast interrupts Normal broadcasts, Priority broadcasts, and active calls and plays out at near maximum volume even if Do Not Disturb is enabled.

To send and receive pages, you need to subscribe to certain paging groups. By default, you are subscribed to paging groups 1, 24, and 25, and you can send and receive pages to those paging groups. Contact your system administrator to find out which paging group you are subscribed to.

Send a Group Page

When you send a group page without selecting a page group, it is automatically sent to the default paging group, which is group 1. You cannot send a page while you are in an active call.

Procedure

1. From the Lines screen, select the **Paging** soft key.

2. From the **Paging Groups** screen, select a paging group.
3. To begin a page, select **Page**.
Just before the page starts, you'll hear an alert tone, and then the page begins.
4. Begin speaking.
5. To end the page, select **End Page**.

Receiving Pages

You receive pages on the paging groups you are subscribed to as well as Group 24 (Priority pages), and Group 25 (Emergency pages). When you enable Do Not Disturb, you only receive Emergency pages. Non-emergency pages do not display or play on your phone.

How you receive a page depends on the priority of the page, whether you are in an active call, and whether your phone is set to receive a page during an active call. When you receive a page, the page is always played through the phone's speakerphone. You cannot play a page through your handset or headset.

When you enable Do Not Disturb on your phone, you receive only Emergency broadcasts. Non-emergency broadcasts do not display or play on your phone.

Listen to a Page during an Active Call

How you handle a page when you are in an active call depends on the page priority and whether the phone is set up to receive a page during active calls.

The following occurs when you receive a page during a call:

- For Normal pages, the page immediately plays, and you hear audio from both the active call and the page.
- For Priority or Emergency page, the page immediately plays. You hear audio from the active call and the page.
- If the phone is not set up to receive Normal pages during active calls, the page is displayed as Pending.

Note: You adjust the volume of a Normal, non-emergency page while it plays, and the phone uses the adjusted volume for all subsequent non-emergency pages. However, only your system administrator can change the volume of an Emergency page.

Procedure

- » Do one of the following:
 - For pages that play automatically during a call, hold the call to hear only the page.
 - For Pending pages, select **Accept** or hold the call.

Receiving Pages When You're Not in an Active Call

When you receive a page and you are not in an active call, the page immediately plays, regardless of the paging priority.

While a page plays, you can:

- Hold the page.
- End the page. This ends the page at your phone only.
- Place a new call.

Group Paging Settings

You can change your default paging group, update page group subscriptions, and enable pages to play during active calls on your phone.

Note: The features described in this section require access to the Basic settings menu on the phone. If your phone requires a password to access the Basic settings menu, contact your system administrator for assistance customizing your phone.

Change the Default Paging Group

You can change the default paging group to any group you want.

The default paging group is group 1. If you change the default paging group, you are automatically subscribed to the group you selected.

Procedure

1. Go to **Settings > Basic > Preferences > Paging/PTT Configuration**.
2. Select **Group Paging > Default Group**, and select a new paging group number.

When you press Paging, your phone sends pages using the new group.

Update Paging Group Subscriptions

By default, you are subscribed to Paging Groups 1, 24, and 25. This means that you can send pages to and receive pages sent from these groups. You can change which groups you are subscribed to. However, you cannot disable your subscriptions to Paging Groups 24 and 25.

Procedure

1. Go to **Settings > Basic > Preferences > Paging/PTT Configuration**.
2. Select **Group Paging > Group Subscriptions**.
3. From the **Group Subscriptions** screen, select the group you want to subscribe to and select **Yes**.

Enable Pages to Play during Active Calls

The Accept While Busy setting determines what happens when you are in a call and receive a page. This setting is disabled by default. When disabled, the incoming page is held in a pending state, it does not disrupt the call, and you cannot hear the page.

When you enable the Accept While Busy setting, a page interrupts calls and you hear the audio of the call and the page.

Procedure

1. Go to **Settings > Basic > Preferences > Paging/PTT Configuration**.
2. Select **Group Paging > Accept While Busy** and select **Enable** or **Disable**.

Broadcasting Messages with Push to Talk

The Push to Talk (PTT) feature enables you to transmit messages and listen to replies much like a walkie-talkie.

Your system administrator sets up the feature, defines up to 25 channels for PTT mode, and assigns a label to each channel that easily identifies the channel, such as All, HR Dept, Shipping Staff, or



Executives. By default, you are subscribed to Channels 1, 24, and 25. This means that you can send and receive PTT broadcasts on Channels 1, 24, and 25.

Each group or channel has one of the following priorities:

- **Normal**—By default, broadcasts sent to channels 1 to 23 are considered Normal broadcasts. If two users begin a broadcast on the same group/channel at the same time, the phone with the lower serial number continues to transmit while the other phone enters the receiving state. By default, all phones are configured to receive broadcasts sent to channel 1.
- **Priority**—By default, broadcasts sent to channel 24 are considered Priority broadcasts. A Priority broadcast interrupts Normal broadcasts or active calls. All phones receive Priority broadcasts unless Do Not Disturb is enabled. Phones play Priority broadcasts at the phone's current audio level.
- **Emergency**—By default, broadcasts sent to channel 25 are considered Emergency broadcasts. An Emergency broadcast interrupts Normal broadcasts, Priority broadcasts, and active calls and plays out at near maximum volume even if Do Not Disturb is enabled.

Send a PTT Broadcast

You can choose a channel to broadcast on before you send a PTT broadcast, or you can hold the Talk soft key to immediately begin broadcasting on Channel 1, the default channel.

While you send a broadcast, you can pick up the handset, or press the Speakerphone  or Headset  key and continue speaking. You can also press the Mute key  to mute your audio so the people receiving your broadcast do not hear anything. This behavior is similar to a phone call.

Tip: To automatically send a PTT broadcast on the default channel, press and hold **Talk**. After the transmitting beep, begin speaking.

Procedure

1. Select **Talk**.
2. From the **PTT Channels** screen, select a channel.

A list is displayed with the default channel, the most recent channel you sent a broadcast on, and other channels you can broadcast on.
3. Press and hold **Talk** to start the broadcast.

Be sure to hold **Talk** throughout the entire broadcast.

A transmitting beep is played and the phone displays the channel information.
4. Begin speaking.
5. When you finish your broadcast, do one of the following:
 - **Release Talk.**

When you release Talk while sending the broadcast, the broadcast temporarily stops and enters a 10-second waiting period. During this period, the channel remains open to give others a chance to reply. At any time during the waiting period, you can resume your broadcast by pressing and holding Talk. If no one broadcasts during the waiting period, the channel closes and the broadcast ends.
 - **Select End PTT.**

After you select End PTT, you can immediately initiate another broadcast on another channel, even if the previous broadcast is in the waiting period.

Receiving PTT Broadcasts

To receive a broadcast sent on a particular channel, you need to be subscribed to that channel.

How you receive a PTT broadcast depends on the broadcast priority, whether you are in an active call, and whether your phone is set up to receive broadcasts during active calls.

When you enable Do Not Disturb on your phone, you receive only Emergency broadcasts. Non-emergency broadcasts do not display or play on your phone.

Listen to a PTT Broadcast during an Active Call

How you handle a broadcast when you are in an active call depends on the broadcast priority and if your phone is set up to receive a broadcast when you are in an active call.

The following occurs when you receive a broadcast during an active call:

- When your phone is set up to receive Normal broadcasts during an active call, the broadcast immediately plays. You hear both the active call and the broadcast.
- When your phone is not set up to receive broadcasts during active calls, the broadcast is displayed as a Pending broadcast.
- When the broadcast is a Priority or Emergency broadcast, the broadcast plays immediately. You hear the active call and the broadcast.

Procedure

- » Do one of the following,
 - For broadcasts that play automatically during a call, hold the call to hear only the broadcast.
 - For Pending broadcasts, select **Accept** or hold the call.

Receiving PTT Broadcasts When Not in an Active Call

When you receive a broadcast and you are not in an active call, the broadcast immediately plays, regardless of the broadcast priority.

When you adjust the volume of a non-emergency broadcast, your phone retains the adjusted volume for all subsequent non-emergency broadcasts. However, only system administrators can adjust the volume level of an Emergency broadcast.

Reply to PTT Broadcasts

When a broadcast ends, the broadcast enters a 10-second waiting period. During this period, the channel remains open to receive or send additional broadcasts.

Procedure

1. During the 10-second waiting period, press and hold **Talk**.
2. Begin talking.
The broadcast is sent to all people listening on the channel.
3. When you finish talking, release **Talk**.
The broadcast enters another waiting period until someone broadcasts again. If no activity occurs within the waiting period, the channel closes and no more broadcasts can take place.

End PTT Broadcasts

After you end a broadcast, the channel remains open so others can respond.

Procedure

» Do one of the following:

- Release **Talk**.

The broadcast enters a waiting period. You can initiate another broadcast on another channel when the waiting period ends.

- Select **End PTT**.

The broadcast ends. You cannot resume the broadcast by pressing and holding Talk on the same channel. You can immediately initiate another broadcast on another channel.

Push To Talk Settings

This section provides information on changing your default channel, updating channel subscriptions, and enabling broadcasts to play during active calls.

Note: The features described in this section require access to the Basic settings menu on the phone. If your phone requires a password to access the Basic settings menu, contact your system administrator for assistance customizing your phone.

Change the Default Channel

When you press and hold Talk, your broadcast automatically transmits on the default channel 1. You can change your default channel to any other channel. When you change the default channel, you are automatically subscribed to the channel you selected.

Procedure

1. Go to **Settings > Basic > Preferences > Paging/PTT Configuration**.
2. Select **PTT Push to Talk > Default Channel** and select the number of the channel you want to use.

Update Channel Subscriptions

You can subscribe to any channel that has been enabled by your system administrator and appears in your channels list.

When you subscribe to a channel, you can send and receive PTT broadcasts on that channel.

Procedure

1. Go to **Settings > Basic > Preferences > Paging/PTT Configuration**.
2. Select **PTT Push to Talk > Channel Subscriptions**.
3. From the **Channel Subscriptions** screen, select the channel you want to subscribe to and select **Yes**.

Enable PTT Broadcasts to Play During Active Calls

The Accept While Busy setting determines what happens when you are in a call and receive a PTT broadcast. The setting is disabled by default, and when disabled, your phone does not play broadcasts while you are in a call but holds them in a pending state instead. When you enable the Accept While Busy setting, a PTT broadcast interrupts active calls and you hear the audio of the call and the broadcast.

Procedure

1. Go to **Settings > Basic > Preferences > Paging/PTT Configuration**.

2. Select **PTT Push to Talk > Accept While Busy** and select **Enable**.

Phone Applications

Topics:

- [Using the Calendar](#)
- [Navigating the Web and Idle Browsers](#)
- [Customizing the Font Size](#)

VVX phones can support optional applications configured by your system administrator.

Ask your system administrator if your phone supports any of the applications discussed in this section.

Note: Some of the features described in this section require access to the Basic settings menu. If your phone requires a password to access the Basic settings menu, contact your system administrator for assistance.

Using the Calendar

When connected to Microsoft Exchange Server, you can view and join meetings scheduled in Microsoft Outlook from VVX business IP phones.

Open the Calendar

You can access the calendar on to view and join scheduled meetings.

Procedure

- » Select **Calendar** from the Home screen or navigate to **Settings > Features > Calendar**.

The calendar displays your meetings for the day.

Note: If you do not see the Calendar icon on the Home screen or the Calendar does not display when selected, it is possible your login credentials are incorrect or the Calendar is not connected.

Related Links

[Check the Status of the Calendar](#) on page 149

Navigate Day View

In Day view, you can see your scheduled meetings for the day, and you can navigate to a previous or upcoming day.

Procedure

- » Do one of the following:
 - To view a meeting, use the Navigation keys to select a meeting or tap the meeting.
 - To view the previous day, select **Previous**.
 - To view an upcoming day, select **Next**.

Navigate to Other Views

From Day view, you can also access Month and Meeting view.

Procedure

- » Do one of the following:
 - Select **Month** to access Month view.
 - Select a meeting to display Meeting view.

Navigate Month View

From Month view, you can select a date to view meetings for that day, and you can also view meetings for previous and upcoming months.

Month view displays all the days in the month, with a dot next to the days that have meetings. The current day is displayed in a darker color, and days you select display in gray.

This feature is not available on VVX 150 phones. Check with your system administrator to find out if this feature is available on your phone.

Procedure

- » Do one of the following:
 - To view a meeting, use the Navigation keys to select a meeting or tap the meeting.
 - To view the previous day, select **Previous**.
 - To view an upcoming day, select **Next**.

Display Meeting View on the Calendar

Meeting view displays the details for a chosen meeting.

From Meeting view, you can view the meeting's start and end time, location, organizer, required attendees, and meeting description; view meeting numbers that you can call to join meetings; and join meetings.

Procedure

- » Do one of the following:
 - From **Day** view, select a meeting.
 - From **Month** view, select a date and select a meeting.

Return to Day View

Day view is the default Calendar view. You can return to Day view from Month or Meeting view.

Procedure

- » Select **Exit** or select **Back** < .

Meeting Reminders

When you have a scheduled meeting on the calendar, a meeting reminder displays and an alert tone plays 5 to 15 minutes before a meeting starts.

From the meeting reminder, you can view meeting details and join the meeting. The following figure shows a meeting reminder that displays before a meeting starts.

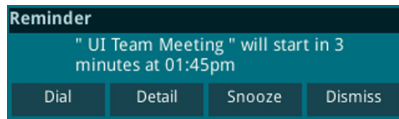
Figure 9: Meeting Reminder

Note: If you have enabled meeting reminders but the reminders do not display before meetings, make sure that your login credentials are correct.

Respond to Meeting Reminders

From the meeting reminder, you can join a meeting, view meeting details, snooze the reminder to temporarily remove it from the screen, and dismiss the reminder to permanently remove it from the screen and stop all future reminders for the meeting.

Procedure

- » Do one of the following:
 - Select **Dial** to join the meeting.
 - Select **Detail** to view information for the meeting.
 - Select **Snooze** to temporarily remove the meeting reminder from your screen for one minute.
 - Select **Dismiss** to permanently remove the reminder for the meeting.

Choose a Meeting Reminder Type

You can choose a meeting reminder type that determines if an alert tone plays each time a meeting reminder displays.

The following options are available for meeting reminders:

- **Silent**—The meeting reminder displays without an alert tone.
- **Audible Once**—An alert tone plays the first time a meeting reminder displays but does not play for any additional reminders.
- **Audible Always (default)**—An alert tone plays each time a meeting reminder displays.

Procedure

1. Go to **Settings > Basic > Preferences**.
2. Select **Calendar Settings > Reminder Settings**.
3. Select **Reminder Type** and choose a meeting reminder type.

Choose a Meeting Alert Tone

You can choose the alert tone that plays for meeting reminders.

Procedure

1. Go to **Settings > Basic > Preferences**.
2. Select **Calendar Settings > Alert Tone**.
3. Choose an alert tone and select **Play** to hear the tone.

Disable Meeting Reminders

Meeting reminders are enabled by default and display reminders for all meetings. You can choose to disable meeting reminders so they do not display for any meetings.

Procedure

1. Go to **Settings > Basic > Preferences**.
2. Select **Calendar Settings > Reminder Settings**.
3. Select **Reminder > Disable**.

Joining Calendar Meetings

You can join any scheduled meeting from the calendar or from a meeting reminder.

Join Meetings from the Calendar

You can join meetings on VVX business IP phones from the Calendar in Meeting view.

Procedure

1. From **Day** view, select the meeting.
2. In **Meeting** view, select **Dial**.

Join a Meeting from a Meeting Reminder

You can join a meeting from the meeting reminder when it displays before a meeting, if enabled.

Procedure

- » Select the meeting number that displays on the reminder.

Join a Meeting with an Alternate Number

If the meeting organizer has provided alternate numbers you can use to join the meeting, you can view and use alternate numbers to join the meeting.

Procedure

- » Do one of the following:
 - From **Meeting** view, select **More Actions** and select a number.
 - From the meeting reminder, select **Details > More Actions** and select a number.

Navigating the Web and Idle Browsers

VVX phones support the following types of browsers:

- Idle Browser—Displays non-interactive web content

The Idle Browser shows non-interactive web content on the Lines screen when your phone doesn't have any calls in progress. Your system administrator determines what displays on the Idle Browser for your phone.

- Web Browser—Enables you to search and navigate web pages (not supported on VVX 101 phones)

The Web Browser is an interactive browser that you can use to search the Internet and view web pages. From the Web Browser, you can select hyperlinks to view more web pages, enter information into text boxes, and scroll through web pages. There are scrolling indicators on the screen that indicate your position on the web page.

Ask your system administrator if the Idle and Web browsers are available on your phone.

View the Idle Browser

When your phone is idle, you can view an Idle Browser when you switch between the Home and Lines screens. To see the Idle Browser, you need to enable the screen saver.

Procedure

- » When your phone is not in a call, press the Home key .

Open the Web Browser

When you open the Web Browser, a toolbar with navigation and editing soft keys display for three seconds along the bottom of the screen, as shown next. You can use the navigation and editing soft keys to navigate between web pages and enter information into text boxes in the Web Browser.

Figure 10: Navigation bar in the Web Browser



Procedure







- » From the **Home** screen, select **Applications**.

Browser Navigation Soft Keys

The navigation soft keys in the Web Browser enable you to view previous web pages, refresh the current page, return to the browser's Home page, or return to your phone's Home screen.

The following table lists the navigation soft keys that display in the Web Browser.

Navigating the Web Browser

Icon	Action
	Returns to the previous web page.
	Refreshes the current web page.
	Returns to the browser's home page.
	Displays the toolbar permanently so it does not hide every three seconds.
	Enables the toolbar to hide every three seconds. To display a hidden toolbar, you have to press the touchscreen until the toolbar displays.
	Exits the Web Browser and returns to the phone's Home screen.

Customizing the Font Size

You can customize the font size on VVX 250, 350 and 450 business IP phones.

The following font size options are available:

- Normal
- Large

Note: This feature is only applicable for English (default) language.

Change the Font Size

You can customize the font size from the available options.

Procedure

1. Navigate to **Settings > Basic > Preferences > Font Size**.
2. Select a font size.
3. Select **Save**.

A notification displays to reboot the phone to make the changes effective.

4. Select **Yes**.

Connecting to a Wireless Network

Topics:

- [Add a Wireless Network](#)
- [Enable Wireless Network Connectivity](#)
- [Connect to a Secured Wireless Network](#)
- [Disconnect from a Wireless Network](#)
- [Remove a Wireless Network](#)

You can connect to a wireless network from your USB-enabled VVX phone using the Polycom® Wi-Fi wireless network adapter to access all phone services over the wireless network.

You cannot use a wireless network and Ethernet simultaneously to connect VVX phones to your network. Enabling wireless connectivity automatically disables the Ethernet port.

Add a Wireless Network

You can manually add a new wireless network on VVX phone from the **Basic** menu.

Procedure

1. Go to **Settings > Basic > Wi-Fi**.
2. Select **Add Network** to manually add a wireless network.
3. Enter the wireless network in SSID.
4. From **Security** select the network security type and other relevant security parameters along with any other wireless settings.
5. Save these selected settings. After saving these settings, phone will try to connect to the saved network.

Enable Wireless Network Connectivity

You can enable wireless connectivity for your USB-enabled VVX phone using the Polycom® Wi-Fi wireless network adapter.

Before setting up a wireless network, make sure that you connect the VVX phone to its power adapter.

Note: VVX phones do not support WEP.

Procedure

1. Insert the Polycom Wi-Fi wireless network adapter into the USB port of your VVX phone.
2. Select **Start**.
3. Select **Wi-Fi**, then select **On**.
4. Select **Yes** to reboot the phone.

After the phone reboots, Wi-Fi is enabled.

The phone scans for wireless networks and lists any that are available. If the phone does not automatically scan, select **Scan** to manually initiate a Wi-Fi network scan.

Note: The administrator can configure the regulatory domain for your location and radio frequency bands on which the wireless network operates. If not configured, the phone uses the Global regulatory domain and 2.4 GHz and 5 GHz default radio bands.

Connect to a Secured Wireless Network

You can select a PSK or an enterprise-based security option to connect your VVX phone to a secured wireless network.

Procedure

1. Go to **Settings > Basic**.
 2. Select **Wi-Fi**.
 3. Do one of the following:
 - For a WPA(2)-PSK network, enter the **Password**.
 - For a WPA2-enterprise network, enter **User ID** and **Password**.
-

Note: Your administrator sets the appropriate EAP method to connect to an enterprise-based network.

4. Select **Connect**.

The phone connects to the Wi-Fi network and displays the Wi-Fi connection status on the **Menu** and **Home** screens.

Disconnect from a Wireless Network

You can disconnect from a wireless network connection on your VVX phone.

Procedure

1. Go to **Settings > Basic**.
2. Select **Wi-Fi**.
3. Select the connected wireless network SSID from the list.
4. Select **Disconnect**.

Remove a Wireless Network

You can remove a saved wireless network connection on your VVX phone.

Procedure

1. Go to **Settings > Basic**.
2. Select **Wi-Fi**.
3. Select the connected wireless network SSID from the list.
4. Select **Forget**.

Poly VVX[®] Business IP Phones Settings

Topics:

- [Password Required to Access Basic Settings](#)
- [Choose a Theme for Your Phone](#)
- [Set the Language](#)
- [Disable Call Waiting](#)
- [Time and Date Display](#)
- [Backlight Intensity and Timeout](#)
- [Changing Your Background](#)
- [Screen Savers](#)
- [Use Your Phone as a Digital Picture Frame](#)
- [Power-Saving Mode](#)
- [Changing Audio Settings](#)
- [Updating Your Buddy Status](#)
- [Security Classification](#)
- [Clear Call Logs and Contacts](#)
- [Restrict Call Log and Contact Uploads](#)
- [Plantronics Headset Settings](#)

You can make some basic customizations on the phone, which includes changing the time and date format, setting a language, and adjusting the screen brightness.

Password Required to Access Basic Settings

Many of the features available on VVX business IP phones can be enabled or customized from the Basic settings menu. However, if your system administrator has set up the phone to require a password to access the Basic settings menu, you cannot change settings without the permission of your system administrator. Contact your system administrator for assistance enabling or customizing features.

Choose a Theme for Your Phone

On the VVX 250, 350, and 450 business IP phones, you can choose a theme for your phone.

The theme controls the way the icons and screens display on your phone. You can choose between the following themes, as shown in the following figures:

- Classic
- BroadSoft (available when signed into your BroadSoft account)

Figure 11: Phone Themes on VVX 250 phones

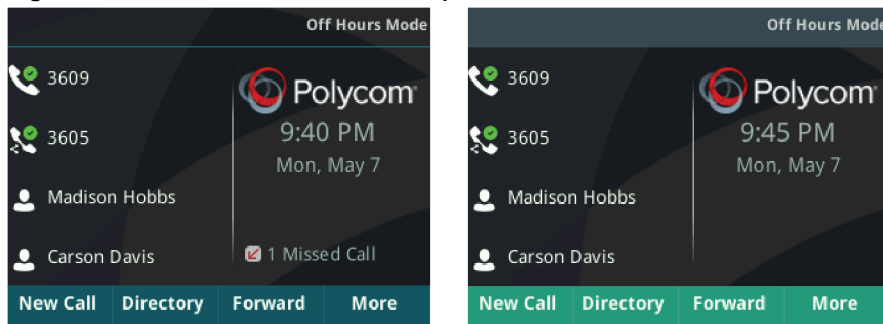

Classic

BroadSoft

Procedure

1. Go to **Settings > Basic > Preferences**.
2. Select **Themes**.
3. Select a theme and select **Save**.
A screen displays informing you that the phone needs to reboot.
4. Select **Yes** to reboot your phone and apply the changes.

Set the Language

Poly phones support several languages that you can choose to display on the phone.

Check with your system administrator to find out exactly which languages are supported on your phone.

Procedure

1. Go to **Settings > Basic > Preferences**.
2. Select **Language** and select a language.
The language on the phone updates immediately.

Disable Call Waiting

The Call Waiting feature is enabled by default. If enabled by your system administrator, you can disable Call Waiting.

If you disable Call Waiting, any incoming calls received on your phone while you are in a call are automatically sent to voicemail.

Procedure

1. Go to **Settings > Basic > Preferences**.
2. Select **Call Waiting** and select **Disable**.

Time and Date Display

The time and date display in the status bar on VVX business IP phones. When the phone cannot obtain a time and date, the time and date display flashes. If this happens, or if the time and date are incorrect, contact your system administrator.

Change the Time and Date Format

You can customize the time and date by choosing between a variety of time and date formats, including options to display the day, month, or year.

Procedure

1. Go to **Settings > Basic > Preferences**.
2. Select **Time & Date** and select one of the following:
 - Select **Clock Date** to change the date format.
 - Select **Clock Time** to change the time format.
 - Select **Clock Order** to change the order of the time and date display. (not available on VVX 150 phones)
3. From the **Clock Date**, **Clock Time**, or **Clock Order** screen, select the format you want.

Disable the Time and Date Display

You can turn off the time and date display so that they do not display at all.

Procedure

1. Go to **Settings > Basic > Preferences**.
2. Select **Time & Date** and select **Disable**.

Backlight Intensity and Timeout

You can change settings for the following backlight components:

- **Backlight Intensity**—The brightness of the screen during phone activity and inactivity.
- **Backlight Timeout**—The number of seconds the phone is inactive before the backlight dims to its Backlight Idle intensity. The backlight timeout period begins after your last activity, such as an incoming call.

Backlight Intensity includes the following settings you can choose from:

- **Backlight On**—The brightness of the screen when there is activity.
- **Backlight Idle**—The brightness of the screen when there is no activity.
- **Maximum Intensity**—The brightness scale that applies to both Backlight On and Backlight Idle intensities.

Related Links

[Changing the Backlight Intensity on the Expansion Module](#) on page 141

Set the Backlight Intensity

You can change the Backlight On intensity and the Backlight Idle intensity separately. You can also choose a high, medium, or low intensity, or turn off the backlight entirely. When you change the Maximum Intensity, you modify the entire backlight intensity scale. For example, if you decrease the Maximum Intensity, the low, medium, and high levels for both Backlight On and Backlight Idle intensities decrease.

Procedure

1. Go to **Settings > Basic**.
2. Select **Backlight Intensity > Backlight On Intensity**.
3. Select the intensity you want, and select **Back**.
4. From the **Backlight Intensity** screen, select **Backlight Idle Intensity**.
5. Select the intensity you want, and select **Back**.
6. From the **Backlight Intensity** screen, select **Maximum Intensity**.
7. Select **Up** or **Down**, or drag your finger along the slider to increase or decrease the maximum intensity.

Set the Backlight Timeout

The backlight automatically turns on with any phone activity. By setting the Backlight Timeout, you can determine how long the phone should be idle before the backlight dims to its Backlight Idle intensity. By default, the backlight dims after the phone is idle for 40 seconds.

Procedure

1. Go to **Settings > Basic**.
2. Select **Backlight Timeout**.
3. Select the number of seconds the phone is idle before the backlight dims.

Changing Your Background

You can change the background picture that is displayed on your phone to any image set up by your system administrator.

By default, your screen displays a blue background named Default. If no background images are set up, only the Default is available.

You can also add personal photos on your phone using the Web Configuration Utility or a USB flash drive.

Change the Background Picture

If your system administrator has pre-loaded your phone with background pictures or you have added personal photos onto the phone, you can choose to display a background other than the default.

Procedure

1. Go to **Settings > Basic > Preferences**.
2. Select **Background** and select a background image.

Depending how your system is set up, you might have to select **Background > Select Background**. The **Select Background** screen is displayed.

Adding Personal Photos as Your Background

You can upload a personal photo to use as your background using the Web Configuration Utility or using a USB flash drive. When you set one of your photos as the background picture, the picture is displayed as **Local File** in the Backgrounds list.

Keep in mind the following when you use a personal photo as the background image:

- Progressive or multiscan JPEG images are not supported.
- The phone screen sizes vary by phone:
 - VVX 150 phone screens are 132 x 64 pixels.
 - VVX 250 phone screens are 320 x 240 pixels.
 - VVX 350 phone screens are 320 x 240 pixels.
 - VVX 450 phone screens are 480 x 272 pixels.
- Smaller images are centered and surrounded with black space.
- Larger images are scaled proportionally to fit the screen.
- Horizontal or vertical black bars are added to preserve the original aspect ratio.

Add a Background Using the Web Configuration Utility

You can add one or multiple images for your phone background using the Web Configuration Utility.

Procedure

1. Find your phone's IP address by navigating to **Settings > Status > Platform > Phone**.
2. Enter your phone's IP address into the web browser on your computer.
3. Select **User** and enter your assigned password or the default (**123**) password.
4. From the menu bar, select **Preferences > Background**.
5. Click **+ Add a new background image**.
6. Click **Select a file from PC/Desktop**, and click **Choose File for Phone Image**.
7. Choose your picture file and click **Open**.
8. Click **Save**.
The file is added to the list of available backgrounds.
9. Go to **Settings > Basic > Preferences**.
10. Select **Background** and select a background image.
The image is displayed as your background.

Use a USB Flash Drive to Add a Background

You can add personal photos as your background using a USB drive on .

Before you can set a photo on your USB flash drive as the background picture, make sure the photo is on a USB flash drive and is not in a folder on the drive.

Note: If your phone doesn't detect the USB device when you insert it into the USB port, the USB port on your phone may be disabled. Contact your system administrator for assistance using the USB port.

Procedure

1. Attach a USB flash drive to the USB port on your phone.

2. Navigate to **Settings > Features > Removable Storage Media > Picture Frame**.

Your pictures display one-by-one.

3. Use the arrow keys to find your picture and then select the **Set Background** icon .

The picture you selected is displayed on the Home and Lines screens.

Note: If your pictures on the flash drive are in a subfolder and not in the root directory, the phone displays a message stating that there are no available photos. Make sure the picture you want to display on your phone is not in a subfolder on the flash drive.

Reset Your Background

You can reset your background to display the default image.

Procedure

1. Go to **Settings > Basic > Preferences**.
2. Select **Background > Default**.

Screen Savers

Another way to personalize your phone is to enable a screen saver that can either show default pictures stored on your phone, the idle browser, or pictures stored on a USB flash drive.

For VVX 450 phones with connected VVX EM50 expansion modules, the screen saver settings you apply to the phone also apply to the connected expansion modules. Ask your system administrator if this feature is available on your phone.

Enable Screen Savers

When you enable the screen saver, you can choose to have your phone display default photos stored on the phone or photos stored on a USB flash drive.

The screen saver automatically starts each time your phone is idle for a certain amount of time. You can stop the screen saver at any time by pressing any key or touching the screen. When your phone is idle again for a specified period of time, the screen saver starts again.

Procedure

1. Go to **Settings > Basic > Preferences**.
2. Select **Screen Saver > Screen Saver** screen and select **Enabled**.
3. Select **Wait Time**, and enter the number of minutes the phone should wait after no activity before displaying the screen saver.

You can enter any time between 1 and 9999 minutes. The default is 15 minutes.

4. Select **Type** and select either **Default** or **Idle Browser**.
5. Select **Save**.

Use Personal Photos as Screen Savers

On VVX 250, 350, and 450 phones, you can enable your phone to display your personal photos on a USB flash drive as a screen saver.

To set up a screen saver of your photos, you must set up certain screen saver settings, place your photos on a USB flash drive, and attach the USB flash drive to the phone.

The photos you use must have the following file type and size properties:

- File type: BMP, JPEG, or PNG
- Maximum size: 9999 x 9999 pixels

The phone can only display the photos as your screen saver when the USB flash drive is attached to the phone. You can set up your phone to use a single photo to display or have all photos display in slide-show style. This is an alternative to setting up a screen saver, and it automatically starts each time your phone is idle a certain amount of time.

For VVX 450 phones with connected expansion modules, you can connect a USB drive to the side USB port on the expansion module to display a slideshow for the screen saver. However, the VVX EM50 expansion module doesn't support the slideshow feature. The expansion module will display the default screen saver images while the phone displays the slideshow images.

Procedure

1. Place one or more photos onto a USB flash drive, either in the root directory or in a folder.
2. Attach the USB flash drive to your phone.

The USB icon  is displayed on the status bar.

3. Go to **Settings > Basic > Preferences**.
4. Select **Picture Frame > Folder**, and enter the name of the folder you placed your photos in on the USB flash drive.

If you placed the photos in the root directory of your USB flash drive instead of a folder, do not enter a folder name.

5. Select **Time Per Image**, and enter the number of seconds you want each photo to display.
You can enter a minimum of 3 seconds and a maximum of 300 seconds. The default is 5 seconds.
6. Select **Save**.

If the message "No pictures found" displays after you select **Save**, there are no photos in the folder you specified or in the root directory. Go back and make sure the information you entered is correct.

7. Go to **Settings > Basic > Preferences**.
8. Select **Screen Saver > Screen Saver** screen and select **Enabled**.
9. Select **Wait Time**, and enter the number of minutes the phone should wait after no activity before displaying the screen saver.

You can enter any time between 1 and 9999 minutes. The default is 15 minutes.

10. Select **Save**.

Your phone displays the screen saver after the number of minutes you specified in the Wait Time field.

Note: If your phone doesn't detect the USB device when you insert it into the USB port, the USB port on your phone may be disabled. Contact your system administrator for assistance using the USB port.

Disable the Screen Saver

You can stop a screen saver at any time by touching the screen. After your phone is idle for the specified period of time, the screen saver starts again.

You can disable a screen saver—prevent it from starting, even if your phone has been idle for the specified period of time—by doing the following:

- Disabling the Screen Saver setting. When you disable the setting, the screen saver does not display, even though the USB flash drive is still attached.
- Removing the USB flash drive. The screen saver does not display until you attach the USB flash drive again and your phone is idle for the period of time you specified.

Procedure

1. Go to **Settings > Basic > Preferences**.
2. Select **Screen Saver > Screen Saver** then select **Disabled**.
3. Select **Save**.

Use Your Phone as a Digital Picture Frame

On VVX 250, 350, and 450 phones, you can use the Picture Frame feature to view pictures stored on your USB flash drive at any time without setting up a screen saver. You can display your pictures as thumbnails, as a slide show, or a single picture.

Before you can display your pictures, confirm that your pictures are on the USB flash drive and that the USB flash drive is attached to your phone.

Note: If your phone does not detect the USB flash drive when you attach it to your phone, the USB port on your phone may be disabled. Contact your system administrator.

Procedure

- » Select **Settings > Features > Removable Storage Media > Picture Frame**.

Your pictures display one-by-one, like a slide show, and navigation icons display beneath your pictures, as shown next.









Picture Frame Icons

Use the icons in the following table to perform actions in the Picture Frame.

Picture Frame Icons

Icon	Label	Action
------	-------	--------

	Thumbnail	View thumbnails of your pictures.
	Back	View the previous picture.
	Forward	View the next picture.
	Pause	Pause and display the current picture only.
	Start	Starts the display of pictures one-by-one again.
	Stop	Stop displaying the pictures. The pictures do not display again until you access the Picture Frame feature (unless you have a screen saver enabled).
	Background Image	Set the picture that currently displays as the background picture for your phone.

Power-Saving Mode

By default, Poly phones are set to enter power-saving mode and turn off the screen after being idle for a certain period of time to conserve energy.

You can determine the period of time that the phone is idle before the screen turns off, and you can set different idle timeouts for office hours and off hours, such as evenings and weekends. When power-saving mode is activated, the phone exits power-saving mode if an event occurs—for example, if there is an incoming call or message. If a screen saver is enabled, power-saving mode still occurs.

You can update the following power-saving settings:

- **Office Hours**—When you start work and how long you're in the office each day.
- **Timeouts**—The period of time the phone should be idle before the screen turns off.

Change Your Office Hours for Power-Saving Mode

When you update your office hours, you specify when you start and how long you work each day. After your work hours, the phone is idle and goes into power-saving mode.

Procedure

1. Go to **Settings > Basic**.
2. Select **Power Saving > Office Hours** and select **Start Hour**.
3. Select a day of the week, and using the 24-hour clock, enter a start time from 0 to 23.
4. Select **Save**.
5. From the **Office Hours** screen, select **Duration**.
6. Select a day of the week and enter a duration of 0 to 12 hours per day.
7. Select **Save**.

Change Idle Timeouts for Power-Saving Mode

You can update the period of time the phone is idle before the screen turns off.

You can specify different timeouts for office hours (Office Hours Idle Timeout) and non-office hours (Off Hours Idle Timeout). By default, the Office Hours Idle Timeout is much longer than the Off Hours Idle Timeout.

You can also specify a separate timeout period that applies after you press a key or tap the screen (on touchscreen models). This is called the User Input Idle Timeout. You can choose to set a higher User Input Idle Timeout than the Office Hours and Off Hours Idle Timeouts so that when you're actively using the phone, power-saving mode doesn't initiate as often.

Tip: If you press a key or tap the screen (on touchscreen models), the idle timeout period that applies (User Input Idle Timeout or Office Hours/Off Hours Idle Timeout) is the timeout with the highest value.

Procedure

1. Go to **Settings > Basic**.
2. Select **Power Saving > Timeouts**.
3. Select **Office Hours Idle Timeout** and enter the number of minutes (1 to 600 minutes) the phone should wait during office hours before starting power-saving mode.
4. Select **Off Hours Idle Timeout** and enter the number of minutes (1 to 10 minutes) the phone should wait during off-hours before starting power-saving mode.
5. Select **User Input Idle Timeout** and enter the number of minutes (1 to 10 minutes) the phone should wait after a key press or screen select before starting power-saving mode.
6. Select **Save**.

Changing Audio Settings

You control certain audio settings on your phone, including the ringtone for incoming calls from all contacts or a specific contact, where call notifications play, and the volume of the ringtone or call audio.

Change Incoming Call Notifications

You can choose whether you hear sound effects—all phone sounds except call audio—from the handset, headset, speaker, or the active audio device you set.

For example, you can configure your phone to ring on your headset instead of the speaker. By default, you hear all sound effects from the speaker.

Procedure

1. Go to **Settings > Basic > Preferences**.
2. Select **Audible Ringer** and select a location to hear sound effects.

Set a Ringtone for Incoming Calls

A simple way to personalize your phone is to change the ringtone. You can pick unique ringtones for the different lines on the phone. The default ringtone is Low Trill.

Procedure

1. Go to **Settings > Basic > Preferences**.
2. Select **Ring Type**.
3. If there are multiple lines on your phone, select a line.
4. From the **Ring Type** screen, select a ringtone.
5. Select **Play** to hear the ringtone.

Set a Ringtone for Individual Contacts

To help you quickly identify callers, you can select unique ringtones for contacts in your directory.

Procedure

1. Navigate to **Directories > Contact Directory**.
2. From the **Contact Directory**, select a contact.
3. From the **Contact Information** screen, select **Edit**.
4. From the **Edit Contact** screen, select **Ring Type** and select a ringtone.
5. Select **Play** to hear the ringtone.
6. Select **Save**.

Change the Volume

You can increase the volume of your ringtone and the audio during a call.

Procedure

- » Press one of the Volume keys  to increase or decrease the audio.

Enable Acoustic Fence

Acoustic Fence suppresses background noise while you are on a call, which enhances call audio quality for call participants.

The Acoustic Fence setting does not display on the phone by default, so if your system administrator has enabled the feature option to display on your phone, you can enable or disable Acoustic Fence.

Acoustic Fence works with handsets or headsets. However, only headsets connected to the RJ-9 port on the phone support Acoustic Fence. Acoustic Fence is enabled by default on the handset, disabled by default for a connected headset, and not supported with USB or Bluetooth headsets.

Procedure

1. Go to **Settings > Basic > Preferences**.
2. Select **Acoustic Fence** and select **Enable**.

Updating Your Buddy Status

Polycom phones enable you to sign into and update your presence status on your phone to let contacts know when you are busy or available.

You can update your status to one of the following:

- Online
- Busy
- Be right back

- Away
- On the phone
- Out to lunch
- Do not disturb

Your phone also sends certain status information automatically to the people watching you—such as if you are in a call, if you enabled Do Not Disturb on your phone, or if your phone is offline because you restarted it.

Update Your Buddy Status

You can update your status on your phone so that contacts can monitor your status from their phones.

Your updated status is displayed in the status bar on your phone, and your contacts are automatically notified of your new status.

Note: If your status is set to Do Not Disturb, when you enable then disable the Do Not Disturb feature on your phone, your status changes to Online.

Procedure

1. Select **My Status** or navigate to **Settings > Features > Presence > My Status**.
2. From the **My Status** screen, select your desired status.

Automatically Update Your Buddy Status

You can enable your phone to automatically set your status to Away when your phone is idle for a certain length of time.

After you touch the screen or press a key on your phone, your status changes to Available again.

Procedure

1. Go to **Settings > Basic > Preferences**.
2. Select **Presence > Idle Timeout**.
3. Enable **Office Hours** and **Off Hours**, and enter the number of minutes your phone should be idle before your status changes to Away.

Security Classification

For VVX business IP phones registered with the BroadSoft BroadWorks Server, you can view and modify the security classification level for your phone, if enabled by your system administrator.

View the Security Classification for Your Phone

If you are unsure of your security classification, you can view your assigned classification for all lines on your phone.

Procedure

1. Navigate to **Settings > Status > Lines**.
If you have only one line, the security classification displays for that line.
2. If you have more than one registered line, select a line.

The security classification displays for the selected line.

Modify Security Classification Level

You can modify your security classification level to choose a lower level during a call to allow users with a lower classification to join a call or to a higher level to restrict who can join the call.

For example, if you are classified as a Top Secret user, you can lower your classification level to Secret or Restricted during a call. You cannot change the security classification when the phone is idle and not in a call.

Procedure

1. During a call, select **Security**.
2. On the Security Classification screen, choose one of the following options:
 - Top Secret
 - Secret
 - Restricted
 - Classified

A notification displays on all call participants' phones informing them that the classification level of the call has changed.

Clear Call Logs and Contacts

By default, your call logs and contacts you save are stored on the phone and a server. You can clear your personal history of stored call logs and contacts from the phone.

Procedure

1. On the phone, go to **Settings > Basic > Clear Personal Information**.
2. Select **Yes**.

Restrict Call Log and Contact Uploads

By default, your call logs and contacts you save are stored on the phone and uploaded to a server. You can restrict the phone from uploading your call logs and contacts to the server.

Procedure

1. On the phone, go to **Settings > Basic > Preferences > Restrict Personal Data Upload**.
2. Select **Enable**.

Plantronics Headset Settings

Polycom UC software supports the following Plantronics headsets and the PLT Hub software on VVX 250, 350, and 450 business IP phones:

- Plantronics Blackwire C5220 Stereo USB-A headset
- Plantronics Blackwire 3225 USB Headset

Note: The features list in PLT Hub varies based on the Plantronics headset you use. To know your headset supporting features, refer to [Features Compatibility Chart](#).

You can access the following headset settings from the **PLT Hub** menu when you connect a Plantronics headset to the VVX phone:

- General Settings
- Ringtone & Volume Settings
- Wireless Settings
- Softphone Settings
- Audio Tuning Settings
- Advanced Settings
- Restore Defaults settings

Set the Answering Call Alert

You can configure the headset to alert you on incoming calls to the phone.

Procedure

1. Do one of the following:
 - Go to **Settings > Basic > PLT Hub > General**.
 - Go to **PLT Hub > General**.
2. Select **Answering Call Alert**.
3. Select **On** to enable the call alert and **Off** to disable the call alert.

Set the Mute On or Off Alert

You can set the headset to notify you when the headset's microphone is muted. You can choose to hear a voice alert, a single tone, or a double tone.

Procedure

1. Do one of the following:
 - Go to **Settings > Basic > PLT Hub > General**.
 - Go to **PLT Hub > General**.
2. Select **Mute On/Off Alert**.
3. Select one of the following alerts:
 - **Voice**
 - **Single Tone**
 - **Double Tone**

Set the Mute Reminder

You can set the headset to notify when the headset's microphone is muted in an active call.

Procedure

1. Do one of the following:
 - Go to **Settings > Basic > PLT Hub > General**.

- Go to **PLT Hub > General**.
2. Select **Mute Reminder**.
 3. Select one of the following reminders:
 - **Off**
 - **Audible Reminder**
 - **On-Screen Reminder**
 - **On-Screen & Audible Reminders**

Set the Mute Reminder Interval

You can set the headset to notify at set intervals when you are on mute.

You must set **Mute Reminder** to **Audible Reminder** to use the mute reminder interval option.

Procedure

1. Do one of the following:
 - Go to **Settings > Basic > PLT Hub > General**.
 - Go to **PLT Hub > General**.
2. Select **Mute Reminder Interval**.
3. Choose the mute interval time frame.

Set the Volume Level Indicator Tones

You can set the headset to play a tone when you increase or decrease the volume to any level or to play a tone when the volume has reached the minimum and maximum level.

Procedure

1. Do one of the following:
 - Go to **Settings > Basic > PLT Hub > Ringtone & Volume**.
 - Go to **PLT Hub > Ringtone & Volume**.
2. Select **Volume Level Tones**.
3. Select one of the following options:
 - **At Every Level**: Hear a tone every time you increase or decrease the volume.
 - **Minimum & Maximum Only**: Hear a tone only when you hit the minimum or maximum volume level.

Adjust the Headset Speaker Bass and Treble

You can adjust the bass and treble settings for the headset speaker from your VVX phone.

Procedure

1. Do one of the following:
 - Go to **Settings > Basic > PLT Hub > Audio Tuning**.
 - Go to **PLT Hub > Audio Tuning**.
2. Select **Speaker**.
3. Adjust the bass settings:
 - a. Select **Bass Equalizer**.

- b. Press **Up** or **Down** to adjust the settings.
4. Adjust the treble settings:
 - a. Select **Treble Equalizer**.
 - b. Press **Up** or **Down** to adjust the settings.

View Voice Visual Feedback

You can speak to view the graphical representation of the audio from your VVX phone.

Procedure

1. Do one of the following:
 - Go to **Settings > Basic > PLT Hub > Audio Tuning**.
 - Go to **PLT Hub > Audio Tuning**.
2. Select **Microphone**.
3. Select **Voice Visual Feedback**.

Record and Play the call

You can record the call, stop, and play the recording to test your microphone.

Procedure

1. Do one of the following:
 - Go to **Settings > Basic > PLT Hub > Audio Tuning**.
 - Go to **PLT Hub > Audio Tuning**.
2. Select **Microphone**.
3. Select **Record and Play**.
 - a. Select **Record** to start recording the voice.
 - b. Select **Stop** to stop recording.
 - c. Select **Play** to listen to the recorded voice.
 - d. Select **Back** to return to the previous page.

Note: Once you press **Back**, the recorded audio deletes automatically.

Adjust the Microphone Gain

You can adjust the headset microphone gain from your VVX phone.

Procedure

1. Do one of the following:
 - Go to **Settings > Basic > PLT Hub > Audio Tuning**.
 - Go to **PLT Hub > Audio Tuning**.
2. Select **Microphone**.
3. Select **Gain**.
 - a. Press **Up** or **Down** to adjust the settings.

Set the Dial Tone

You can set the dial tone of the softphone to alert for an outgoing call.

Procedure

1. Do one of the following:
 - Go to **Settings > Basic > PLT Hub > Softphone.**
 - Go to **PLT Hub > Softphone.**
2. Select **Dial Tone.**
3. Select **On** to enable the dial tone and select **Off** to disable dial tone.

Set the Decibel Spike Limit

You can limit the decibel spike threshold on the headset to eliminate sudden loud and acoustic sounds.

Procedure

1. Do one of the following:
 - Go to **Settings > Basic > PLT Hub > Advanced.**
 - Go to **PLT Hub > Advanced.**
2. Select **Anti-Startle.**
3. Select one of the following:
 - **Off:** Headset limits the sound level to 118 dBA.
 - **G616:** Protects from acoustic shock and limits the sound levels to 102 dBA.

Set the Decibel Threshold Limit

You can set the headset with a noise exposure setting to limit how loud the sound levels can become. If you disable this setting, the headset limits the sound level to 118 dBA.

Procedure

1. Do one of the following:
 - Go to **Settings > Basic > PLT Hub > Advanced.**
 - Go to **PLT Hub > Advanced.**
2. Select **Noise Exposure.**
3. Select one of the following:
 - **No Limiting**
 - **Limited at 80 dBA**
 - **Limited at 85 dBA**

Set the Hours on Phone Per Day

You can set the headset with the number of hours on the phone per day to optimize the decibel limits.

Procedure

1. Do one of the following:
 - Go to **Settings > Basic > PLT Hub > Advanced.**
 - Go to **PLT Hub > Advanced.**

2. Select **Hours on Phone Per Day**.
3. Select the number of desired hours.

Restore Default Settings

You can restore the headset default settings from your VVX phone.

Procedure

1. Do one of the following:
 - Go to **Settings > Basic > PLT Hub > Restore Defaults**.
 - Go to **PLT Hub > Restore Defaults**.
2. Select **Yes**.

Features Compatibility Chart

Use the following table to know the features that are compatible to your headset.

Features Compatibility Chart

Features	Blackwire C5220 Stereo USB-A headset	Blackwire 3225 Series USB Headset
Answering Call Alert	Yes	No
Mute On/Off Alerts	Yes	Yes
Mute Reminder	Yes	Yes
Mute Reminder Interval	Yes	Yes
Volume Level Tones	Yes	Yes
Speaker Setting	Yes	Yes
Micrphone Setting	Yes	Yes
Dial Tone	No	Yes
Anti-startle	Yes	No
Noise Exposure	Yes	No
Hours on Phone per Day	Yes	No
Restore Default Settings	Yes	No

Phone Accessories and Computer Applications

Topics:

- [Using a Headset with Your Phone](#)
- [Controlling Your Phone with Polycom Desktop Connector](#)

VVX business IP phones support accessories and computer applications that you can use to extend your phone's capabilities.

Your phone may not support all of the accessories or applications described in this section. Check with your system administrator to find out which of these applications or accessories are available on your phone.

Note: Some of the features described in this section require access to the Basic settings menu. If your phone requires a password to access the Basic settings menu, contact your system administrator for assistance.

Using a Headset with Your Phone

You can connect a headset to your VVX phone and use the headset to place and answer calls, handle all calls using a headset, and use electronic hookswitch (EHS).

You can connect an analog headset to all VVX phones or a USB headset to VVX 250, 350, and 450 phones.

See *Feature Profile 37477: Using Headsets with Polycom Phones* on [Polycom Support](#) for a list of compatible headsets.

Note: For information on your headset's features, as well as how to sync your headset with your phone, see your headset's documentation.

Connecting a Headset

Your phone does the following when connected to analog and USB headsets:

- When an analog headset is connected and in use, the headset key glows green. Note that the headset key does not glow on VVX 150 phones.
- When a USB headset is connected and in use, the headset key glows blue.
- When both an analog and USB headset are connected, the USB headset is used automatically for all calls.
- When two USB headsets are connected, the headset you connected first is used automatically for all calls.

After you connect a headset to your phone, you can set up your phone to use the headset automatically when answering and placing calls.

For setup information on how to connect a headset to your phone, see the Setup Sheet for your phone on the [Polycom Voice Support](#) page.

Note: If your phone does not detect the USB headset when you attach it to your phone, the USB port on your phone may be disabled. Contact your system administrator.

Use Your Headset for All Calls

Using the Headset Memory Mode feature, you can enable your phone so that all incoming and outgoing calls automatically use your headset.

Procedure

1. Go to **Settings > Basic > Preferences**.
2. Select **Headset > Headset Memory Mode** and select **Enabled**.
3. Press the headset key twice.

The headset key flashes to indicate that Headset Memory Mode is now activated. All calls placed or answered on your phone use your headset automatically.

Note: If you or your contacts experience audio or echo issues during calls, such as feedback of your voice or of their own voice, you need to enable echo cancellation on your phone.

Related Links

[Switch Among the Handset, Headset, and Speakerphone](#) on page 39

Reactivate Headset Memory Mode

Switching to the speakerphone or the handset deactivates Headset Memory Mode.

Procedure

- » Press the headset key twice.

Using Electronic Hookswitch

When you use a headset that supports electronic hookswitch (EHS), you can place, answer, and end calls by using the controls on your headset.

To use EHS, you need a headset that includes a serial control interface in addition to the standard analog headset jack (RJ-9) interface. The serial control interface requires an EHS adapter that you can purchase from your headset manufacturer.

Headsets that support EHS include a base unit that connects to your phone. The headset connects to the base unit wirelessly, which enables you to use your headset even if you're some distance away from your phone. Typically, you can work wirelessly up to 300 feet (91 meters) from your phone and still use the EHS controls. Check with your headset's user guide for the precise range restrictions.

See *Feature Profile 37477: Using Headsets with Polycom Phones* on [Polycom Support](#) for a list of compatible headsets.

Setting the Headset Base Unit Options

Before you connect your headset to your phone and use EHS, you need to set the following options for your specific headset model:

- For Jabra headsets, change the headset mode to **DHSG** on the headset base unit. For details, refer to your headset documentation or contact Jabra support.
- For Plantronics headsets, change the coarse receive level to **3** and the transmit level to **B** on the headset base unit. For details, refer to the guide that comes with your headset.
- For Sennheiser headsets, set the first DIP switch labeled **1** (DHSG) to the down position on the back of the headset base unit. For additional details, see your headset's documentation or contact Sennheiser support.

Enable Electronic Hookswitch

After you set the base unit options for your headset and connect your headset to your phone, you can enable EHS.

Procedure

1. Connect your headset and EHS adapter to your phone.
See the Quick Start Guide for your phone on [Polycom Voice Support](#) for information on connecting a headset to your phone.
2. Go to **Settings > Basic > Preferences**.
3. Select **Headset > Hookswitch Mode**.
4. Select one of the below modes for your specific headset:
 - Choose **Jabra** if an EHS-compatible Jabra headset is attached with an EHS cable or adapter.
 - Choose **Plantronics** if an EHS-compatible Plantronics headset is attached with an EHS cable or adapter.
 - Choose **Sennheiser** if an EHS-compatible Sennheiser headset is attached with an EHS cable or adapter. If your phone does not have a menu selection for Sennheiser, select **Jabra** instead.
 - Choose **Regular Mode** (default) if another headset is attached.

Change the Headset Mode

To control your phone using your headset, the headset must be in soft phone mode.

Headsets that come with a docking station have two modes: soft phone and desk phone mode. If you cannot operate the phone from your headset, it is possible your headset is in desk phone mode.

Procedure

- » Press and hold the headset hookswitch until you hear a sound or message on the headset.

Controlling Calls with Electronic Hookswitch

After you have followed the procedures for connecting your headset and enabled EHS, you can use the controls on your headset to answer, mute, and end calls. If supported on your headset, you can also place calls on hold. See your headset's user documentation for information on controlling calls from your headset.

When you are in an active call and you receive an incoming call, you cannot use the hookswitch control on your headset to place the active call on hold and answer the incoming call. Pressing the hookswitch control on the headset ends the active call and answers the incoming call. To place the existing call on hold and answer the incoming call, answer the call on your phone.

Disconnect Your Headset

If you want to disconnect or change your headset, you need to properly detach your headset from your phone.

Procedure

1. Go to **Settings > Basic > Preferences**.
2. Select **Headset > Hookswitch Mode**.
3. Select **Regular Mode**.
4. Remove the EHS adapter from the serial port on the back of the phone.

Controlling Your Phone with Polycom Desktop Connector

The Polycom Desktop Connector (PDC) enables you to use your computer mouse and keyboard to navigate and enter information on your phone.

The PDC is compatible with any language your phone and computer supports. Contact your system administrator to find out if your phone supports the PDC.

This feature is not available on VVX 150 phones. Check with your system administrator to find out if this feature is available on your phone.

Setting Up and Enabling the Polycom Desktop Connector

Before you can enable and use the PDC, you need to download the PDC application from the [Polycom Voice Applications](#) website, install the application on your computer, and activate PDC on your phone.

To enable the PDC, you need to enter your computer access credentials to the phone. You can provide this information to your phone using one of two methods: direct or indirect. The method you use depends on how your phone and computer are set up.

After you install the software, you need to make changes to your phone to establish a connection to your computer and provide an exception to your firewall or anti-virus software to unblock the PDC program.

Connect Using the Direct Method

If your phone and computer are connected using an Ethernet cable, use the direct method to enable the PDC. Using this method, your phone automatically detects your computer's access credentials.

Procedure

1. On your computer, select **Start > Polycom > Polycom Desktop Connector**.

The PDC icon displays as an active program on your taskbar.



2. On your phone, go to **Settings > Basic > PDC Configuration**.
3. On the **PDC Configuration** screen, set the **Status** field to **Enabled** and select **Save**.

Your settings are saved and the Basic screen is displayed.

4. On the **PDC Configuration** screen, select **Reconnect**.

A dialog box is displayed on your phone screen asking if you wish to share your remote keyboard and mouse.

5. Select **Yes**.

A dialog box is displayed asking you to specify your phone's position.

6. Specify whether your phone is to the left or right of your computer monitor.

A dialog box is displayed on your computer asking to allow remote control of your phone.

7. Select **OK** to complete the setup process.

The PDC icon turns red, indicating that you successfully enabled the PDC program.

Connect Using the Indirect Method

If your phone and computer are connected through a switch, use the indirect method to enable the PDC. This method requires you to find your computer's IP address and manually enter your computer access credentials.

After you find your phone's IP address, you can start the PDC program and connect your phone to your computer using the indirect method.

Procedure

1. On your computer, select **Start > Polycom > Polycom Desktop Connector**.

The PDC icon displays as an active program on your taskbar.



2. On your phone, go to **Settings > Basic > PDC Configuration**.
3. From the **PDC Configuration** screen, set the **Status** field to **Enabled**.
4. In the **Phone Orientation** field, specify whether your phone is to the left or right of your computer monitor.
5. In the **Desktop User** field, enter your Windows login name.
6. In the **Server Address** field, enter your computer's IP address or FQDN.

The IP address enables your phone to locate and identify your computer on the network.

7. Select **Save**.

Your settings are saved and the Basic screen is displayed with a message prompting you to allow sharing with your computer.

8. Select **Yes**.

A dialog box is displayed on your computer asking if you wish to allow remote control of your phone.

9. Select **OK** to complete the setup process.

The PDC icon turns red, indicating that you successfully enabled the PDC program.

Disable the Polycom Desktop Connector

If you disable the PDC, you can no longer use your mouse and keyboard to control and enter information on your phone.

Procedure

- » Do one of the following:
 - On your computer, right-click the PDC icon on your taskbar and click **Exit**.
 - On your phone, navigate to the PDC Configuration menu and set the **Status** to **Disabled**.

In the system tray, the PDC icon turns grey.

Using the Polycom Desktop Connector

After you've configured and enabled the PDC, you can use your computer mouse and keyboard to click menus and enter text in the editable fields—the fields with a flashing cursor—on your phone.

Access Your Phone Screens

You can use your mouse to navigate your phone and access your phone's screens.

Procedure

- » Move your mouse pointer off the edge of your computer monitor in the direction of your phone—left or right—that you indicated in the setup process.

The pointer leaves your computer monitor and displays on the phone's screen.

Note: If your computer taskbar is on the same side as your phone, the taskbar will block your cursor from accessing your phone. Move your computer taskbar elsewhere to allow your cursor to access the phone.

Using Keyboard Shortcuts to Perform Tasks on Your Phone

The Polycom Desktop Connector application extends your keyboard and mouse functionality from your computer onto your phone.

You can perform the following tasks using the application:





- You can right-click a field on your computer and select the cut or copy information and paste the information onto your phone. You can also cut, copy, and paste text from your computer onto your phone using keyboard shortcuts.
- Copy and paste information between fields on your phone screen by right-clicking the field and choosing a clipboard command.
- Delete information on your phone by highlighting the information using your mouse and pressing the Delete or Backspace key on your keyboard.
- Use the Home and End keys on your keyboard to position your cursor at the beginning or the end of fields on your phone.
- Enter numeric information such as phone numbers using the number keys on your keyboard.
- Use the Arrow keys to move within and between text fields.
- Use your mouse scroll wheel to navigate through menus.
- Adjust the volume level on your phone by holding Alt + Up arrow key or Alt + Down arrow key.

Note: When you use PDC, you cannot enter information in phone fields that don't have a flashing cursor, and you cannot place calls using the New Call soft key.

Your keyboard function keys are also mapped to specific phone keys and soft keys, as outlined in the following tables. The key mappings vary by phone model.

To use the Function and Alt key mappings, your cursor must be on the phone's display screen.

Function and Alt Key Mappings for VVX Phones

Function Key	Phone Key	Alt Key	Phone Key
F1	Left-most soft key	Alt + F1	N/A
F2	Second soft key from the left	Alt + F2	Redial
F3	Third soft key from the left	Alt + F3	Transfer
F4	Fourth soft key from the left	Alt + F4	Conference
F6	Home key 	Alt + F6	Do Not Disturb
F7	Directories menu	Alt + F7	Mute key 
F8	Messages menu	Alt + F8	New Call soft key
F9	Talk soft key (if PTT is enabled)	Alt + F9	End Call soft key
F10	ACD Sign In (if enabled)	Alt + F10	Settings.
F11	Applications	Alt + F11	Speakerphone key 
F12	Headset 	Alt + F12	ACD Sign Out (if enabled)

Enter Text in a Different Language

You can enter text in different languages onto your phone using your computer's keyboard.

Note: The PDC does not allow you to type Chinese characters into fields on your phone using the PinYin character entry method on your computer keyboard. Instead, copy and paste these Chinese characters from a computer document into the applicable phone fields using clipboard functions.

Procedure

1. On your computer, click **Start > Control Panel > Region and Language > Keyboard and Languages > Change keyboards**.
2. Choose a computer keyboard language, as shown next.

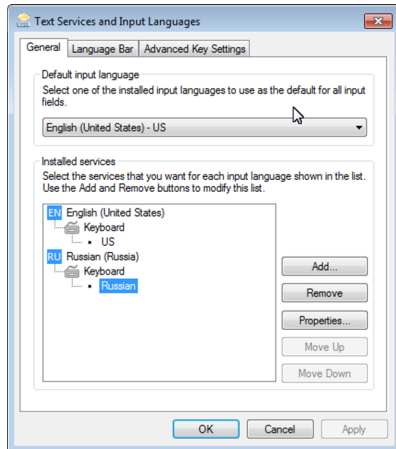

3. Move your cursor onto your phone's display screen.
The PDC program changes your keyboard language when you move your cursor onto your phone's screen.
4. On the phone, enter text in your chosen language.
The following graphic shows Russian characters entered on a VVX phone.

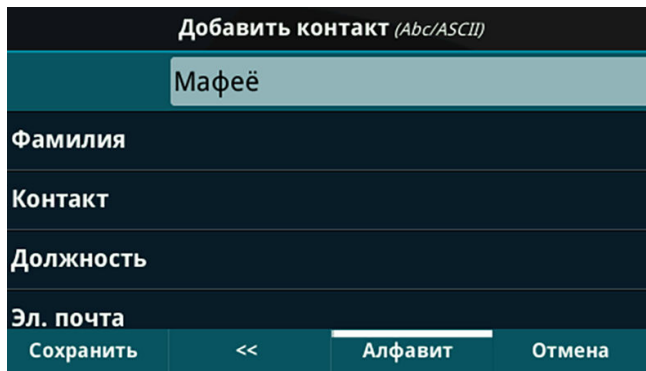

Tip: To change your keyboard language back to the original, press the keyboard shortcut **Left Alt + Left Shift** to toggle your keyboard language.

Polycom VVX EM50 Expansion Modules

Topics:

- [VVX EM50 Expansion Module Hardware Features](#)
- [Connect a VVX EM50 Expansion Module](#)
- [Disconnect a VVX EM50 Expansion Module](#)
- [Connect an Additional VVX EM50 Expansion Module](#)
- [Disconnect an Additional VVX EM50 Expansion Module](#)
- [Assigning Contacts and Favorites to VVX EM50 Expansion Modules](#)
- [Navigate Expansion Module Paging](#)
- [Changing the Backlight Intensity on the Expansion Module](#)

The Polycom VVX EM50 expansion module is a console supported on VVX 450 business IP phones and enables you to add additional lines to your phone.

Expansion modules enable you to handle large call volumes on a daily basis and expand the functions of your phone.

Note: VVX 150, 250, and 350 phones do not support expansion modules. The VVX EM50 expansion module is only supported on VVX 450 business IP phones, running UC Software 5.8.2 or later.

Related Links

[Answer a Call from an Expansion Module](#) on page 38

[Resume a Call on an Expansion Module](#) on page 40

[Place a Call from an Expansion Module](#) on page 36

VVX EM50 Expansion Module Hardware Features

The following features are available on the VVX EM50 expansion module:

- 480 x 800 pixel, color LCD display
- 30 line keys and three display pages, which support a total of 90 lines that you can set up with registrations, favorites, or presence contacts.
- Support for up to two expansion modules connected to a VVX 450 business IP phone to support an additional 180 line keys per phone.

The following figure illustrates the features, components, and keys available on the VVX EM50 expansion module. The table lists each numbered feature shown below.

Figure 12: VVX EM50 Hardware Features

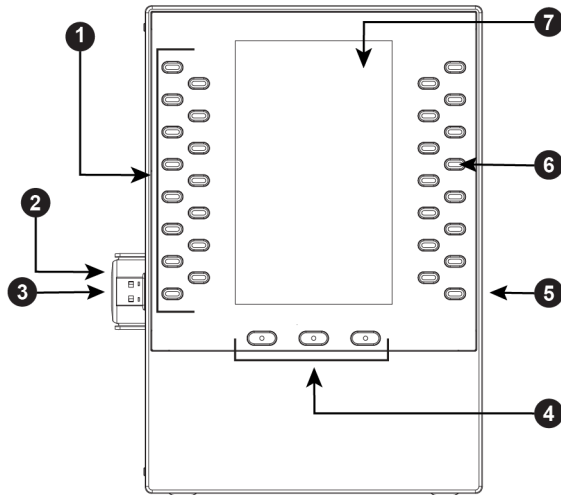

VVX EM50 Hardware Description

Reference Number	Feature	Feature Description
1	Line keys	Selects available line key contacts, functions, and assignments.
2	Bracket	Secures the expansion module to the phone.
3	USB plug	Connects the expansion module to the phone.
4	Page keys and LED indicators	<p>Navigates between pages on the expansion module.</p> <ul style="list-style-type: none"> ▪ Fast-Flashing Green—Indicates an incoming call on a page not currently displayed. Press the page key that has a fast-flashing green LED indicator to view the contact with an incoming call. ▪ Slow-Flashing Green—Indicates a monitored busy lamp field contact on a page not currently displayed is receiving an incoming call. ▪ Solid Red—Indicates the current page displayed.
5	USB port (on side)	Enables you to connect USB devices to the expansion module, such as an additional expansion module or a USB flash drive.

Reference Number	Feature	Feature Description
6	Line key LED indicators	<p>Indicates a line or busy lamp field contact's status. The following lists the LED Indicator behaviors shown on the expansion modules:</p> <ul style="list-style-type: none"> ▪ Solid Green—Indicates an active call in progress. ▪ Fast-Flashing Green—Indicates an incoming call. ▪ Flashing Green—Indicates the remote party placed the call on hold. ▪ Solid Red—Indicates the phone of a monitored busy lamp field contact is placing a call or is in a call. ▪ Flashing Red—Indicates a held call. ▪ Flashing Green and Red—Indicates the phone of a monitored busy lamp field contact is on an active call or is receiving an incoming call.
7	Color Display	Displays line numbers, monitored contacts, contacts' presence, and favorites.

Related Links

[Overview of Phone Hardware and Keys](#) on page 11

Connect a VVX EM50 Expansion Module

Expansion modules are powered and signaled by the connected VVX phone and require minimal setup. After you connect an expansion module to a phone, the module is automatically configured to work with the phone.

Procedure

1. Power off the VVX 450 business IP phone.
2. Insert the USB plug on the VVX EM50 expansion module into the side USB port on the VVX 450.
3. Lay the connected phone and expansion module face-down on the table.
4. Insert the supplied screw into the bracket screw hole and, using a screwdriver, secure the expansion module to the phone, as shown.

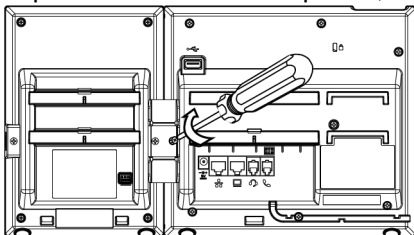

The LED lights on the module's line keys flash red and green as the module starts up.

Disconnect a VVX EM50 Expansion Module

You can disconnect a VVX EM50 expansion module from an IP phone.

Procedure

1. Power off the VVX 450 business IP phone.
2. Lay the connected phone and expansion module face-down on the table.
3. Using the screwdriver, remove the supplied screw from the bracket screw hole, as shown. 
4. Detach the USB plug on the VVX EM50 expansion module from the phone.

Connect an Additional VVX EM50 Expansion Module

You can connect up to two VVX EM50 expansion modules to a VVX 450 business IP phone.

Note: When you connect expansion modules to a VVX 450 phone, you can connect additional USB devices to the rear port of the phone and the side port on the second connected expansion module. The side USB port on the expansion module can support low-powered devices, such as headsets, USB flash drives, or a smartphone to charge the phone.

Procedure

1. Power off the VVX 450 business IP phone.
2. Lay the VVX 450 phone with the connected expansion module face-down on the table.
3. Remove the screw from the left side of the connected expansion module, as shown.

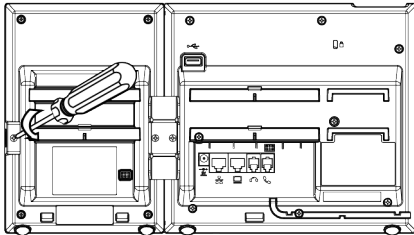

4. Insert the USB plug on the second VVX EM50 expansion module into the side USB port on the first connected expansion module.
5. Using the screw you removed from the first expansion module, use a screwdriver and the screw to secure the second expansion module to the first, as shown.

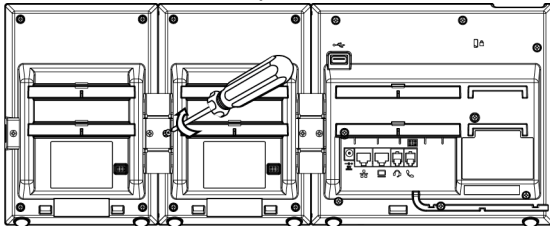

The LED lights on the module's line keys flash red and green as the module starts up.

Disconnect an Additional VVX EM50 Expansion Module

You can disconnect additional VVX EM50 expansion modules from an IP phone.

Procedure

1. Power off the VVX 450 business IP phone.
2. Lay the connected phone and the expansion modules face-down on the table.
3. Using the screwdriver, remove the secured screw from the bracket screw connecting both the expansion modules, as shown.

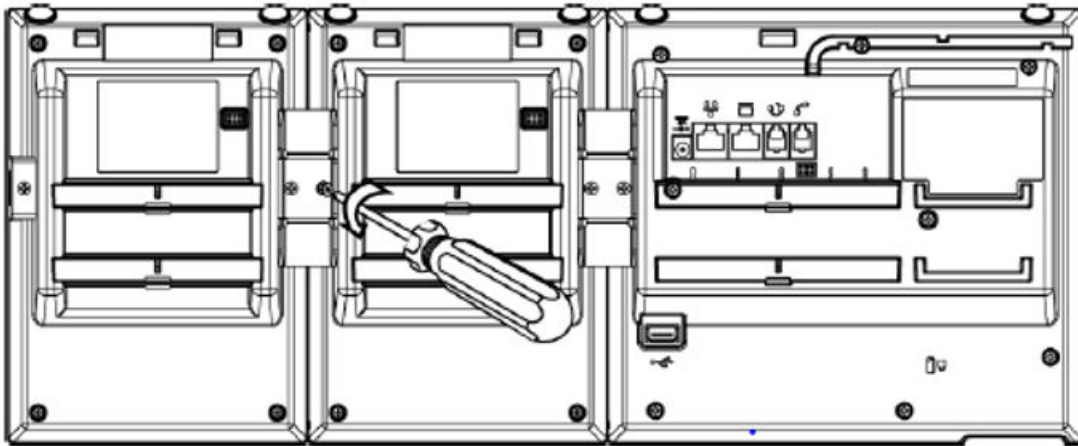

4. Detach the USB plug of the second VVX EM50 expansion module from the side USB port of the first connected expansion module.
5. Using the screwdriver, remove the supplied screw from the bracket screw hole between the phone and the first expansion module, as shown.

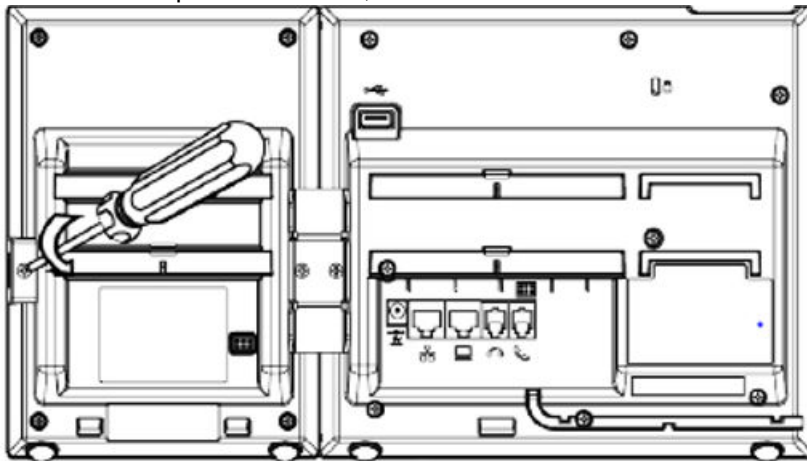

6. Detach the USB plug on the first VVX EM50 expansion module from the phone.

Assigning Contacts and Favorites to VVX EM50 Expansion Modules

You can assign contacts to line keys on your expansion module after the line keys on your phone are full.

The default view on your phone screen, which is the Lines screen, displays line registrations, monitored and presence contacts, and favorites. Each function occupies a display space on the Lines screen. When you reach the maximum number of display spaces on your phone, the next function you add is assigned to the first available line key on your expansion module.

The following table shows the maximum display spaces available on the VVX 450 phone and each connected expansion module.

Maximum Display Spaces on Phone and connected Expansion Modules

VVX 450 Phone	with Expansion Module 1	with Expansion Module 2
12	102	192

Note: After you fill all the display spaces on your phone and assign functions to all the lines on your expansion module, you can find additional favorites and contacts in the Contact Directory.

Related Links

[Favorites and Contact Lists](#) on page 84

Assign Favorites to Expansion Modules

You can assign favorites to line keys on connected expansion modules and automatically call contacts using the line keys on the expansion modules. When you assign favorites on your phone, favorites are assigned to the next available line key on the expansion module regardless of the index number. You can reorder your favorites once they are created by changing the value of their index number.

Procedure

1. Press and hold an available line key on your expansion module.
2. From the **Add Contact** screen, enter the contact's information, including a unique favorite index, and select **Save**.

Identify Line Key Assignments

You can identify which registrations, monitored or presence contacts, and favorites are assigned to each line key on your expansion module in the Status menu on your phone.

Procedure

1. Navigate to **Settings > Status > Line Key Information**.
2. Press a line key on the expansion module.
The assignment and line number for the line key you pressed are displayed on your phone's screen.
3. Press the line key twice to return to the previous menu or select **Back**.

Navigate Expansion Module Paging

The Polycom expansion modules with color displays support three pages of line information on the LCD screen for each module connected to a supported VVX phone. Each page of the expansion module contains line registrations, monitored contacts, contacts' presence, or favorites assigned to line keys.

Procedure

- » Press a Page key beneath the screen on the expansion module.

Smart Paging on VVX EM50 Expansion Modules

The Smart Paging feature arranges line key assignments and distributes pages on VVX EM50 expansion modules when two expansion modules are connected to a VVX 450 phone. This feature is enabled by default.

Note: If you assigned functions to line keys using the Flexible Line Key feature, the line key assignments display on the designated line key on the expansion module and are not affected by Smart Paging.

When Smart Paging is enabled, the pages on the expansion module are distributed across all connected expansion modules. This feature is described and shown in the following scenarios:

- If you only have one expansion module connected to your phone, the pages are ordered sequentially on the module, as shown next. Press the first, second, or third **Page** key to view the corresponding pages.

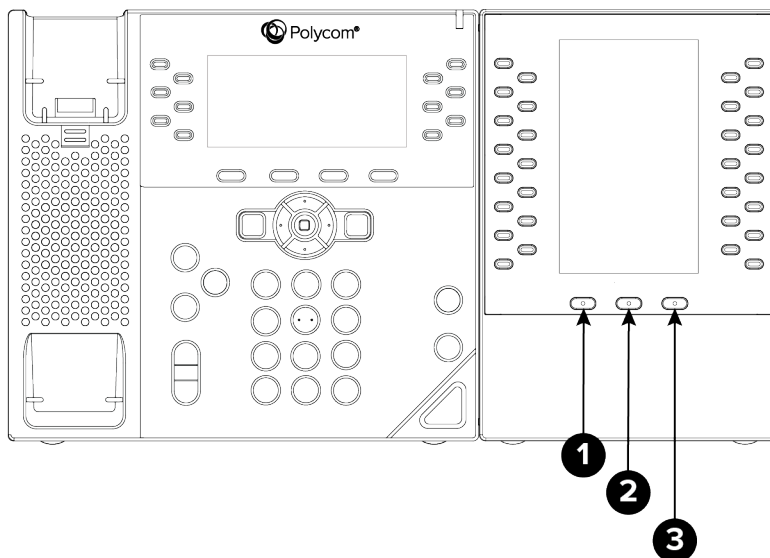

- If you have two expansion modules connected to your VVX phone, the pages are ordered non-sequentially. As shown in the next figure, the pages display on the two expansion modules in the following order:
 - Pages 1, 3, and 4 display on the first expansion module.
 - Pages 2, 5, and 6 display on the second expansion module.

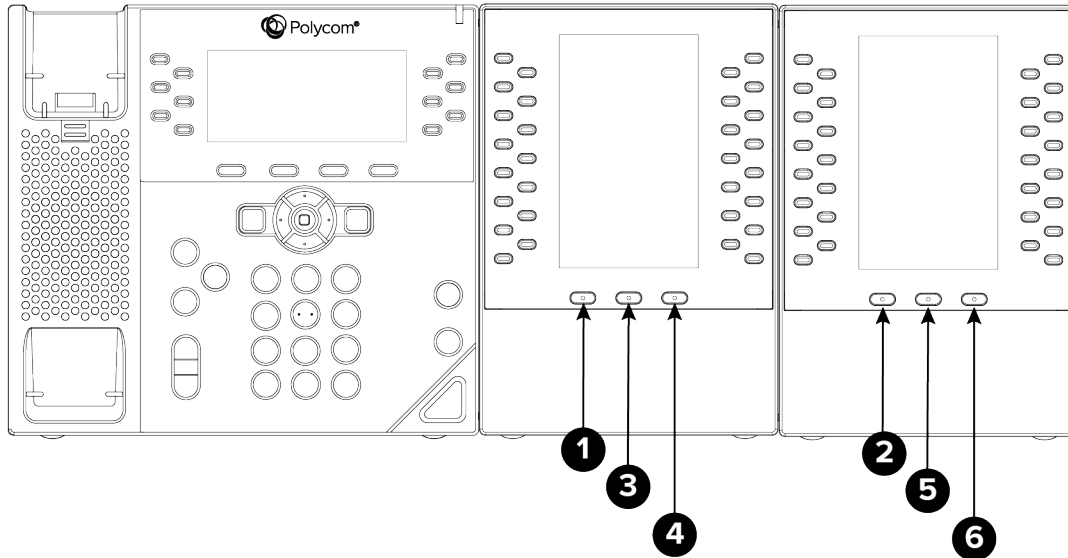

Alternate Paging

When Smart Paging is disabled, the ordering of the pages on the expansion modules is not affected by the number of expansion modules connected to your VVX phone. With Alternate Paging, the expansion modules' pages are ordered sequentially.

Changing the Backlight Intensity on the Expansion Module

When you change the backlight intensity settings on your VVX phone, the backlight on your connected expansion module automatically changes to match the new settings.

Related Links

[Backlight Intensity and Timeout](#) on page 110

Accessibility Features

Topics:

- [Features for Hearing-Impaired Users](#)
- [Features for Mobility-Impaired Users](#)
- [Features for Vision-Impaired and Blind Users](#)

Poly products include a number of features to accommodate hearing-, vision-, mobility-, or cognitively-impaired users.

Features for Hearing-Impaired Users

Poly phones include many features that enable users with hearing impairments to use various features on the phone.

The following table lists the accessibility features for hearing-impaired users.

Accessibility Features for Hearing-Impaired Users

Accessibility Feature	Description
Visual message indicators	An indicator light on the phone indicates that new messages are waiting. Icons on the screen also indicate that the phone has new messages.
Adjustable ring tone and volume	You can choose from a variety of ring tones for the phone. You can also change the volume of the ringer to suit your needs and choose different ring tones for contacts.
Adjustable call volume	While in a call, you can raise or lower the volume of the device.
Visual notifications	Status and icon indicators let you know when you have incoming, outgoing, active, or held calls. Indicators also alert you of the device's status and when features are enabled.
Visual ringing	Certain VVX models have visual ringing that enables the screen to flash bright orange for incoming calls (contact your system administrator to enable this feature).
Electronic hookswitch	If you use a headset that supports electronic hookswitch (EHS), you can use the controls on your headset to answer and end calls. Additionally, you may be able to mute calls and control volume from your headset.
Headset memory mode	If you use a headset, you can set up your phone to use your headset for all calls.

Accessibility Feature	Description
Hearing Aid Compatible (HAC) handsets	All phones are Hearing Aid Compatible (HAC) and have telecoils that magnetically couple to most forms of wearable hearing aids per FCC section 508 (compliant to ADA Section 508 Recommendations: Subpart B 1194.23).
TTY support	The phones supports commercial TTY devices such as Ultratec Superprint. Additionally, the phones provide acoustic coupled TTY support.

Related Links

[Icons and Status Indicators on VVX Business IP Phones](#) on page 22

Features for Mobility-Impaired Users

Poly phones include features that enable users with mobility impairments to perform various functions on the phone.

The following table lists the accessibility features for mobility-impaired users.

Accessibility Features for Mobility-Impaired Users

Accessibility Feature	Description
Auto-answering	You can enable the system to auto-answer calls.
Touchscreen	The large touchscreen enables you to select, swipe, and press the screen to perform functions and activate features.
Large keys	The large keys on the phone console enable you to access phone features and functions.
Built-in speakerphone	A built-in speakerphone allows you to hear audio on the device without having to use a handset or headset.
Adjustable phone stand	You can adjust the phone stand to various angles so your phone sits at a comfortable angle on your desktop (see your phone's <i>Quick Start Guide</i> on Polycom Voice Support web page).
Polycom Desktop Connector application	You can use your computer's mouse and keyboard to enter information and navigate screens on your phone.

Related Links

[Answer Calls Automatically](#) on page 37

Features for Vision-Impaired and Blind Users

Poly phones include various features that enable users with visual impairments to use many of the features on the phone.

The following table lists the accessibility features for visually-impaired and blind users.

Accessibility Features for Vision-Impaired and Blind Users

Accessibility Feature	Description
Adjustable backlight settings	You can change the brightness of the screen by adjusting backlight intensity settings.
Auto-answering	You can enable the system to auto-answer calls.
Tactile “5” key with raised bumps	The “5” key has two bumps that enable you discern the position of other keys on the keypad.
Large keys	The large keys on the phone console enable you to access phone features and functions.
Physical line keys	VVX phones have physical line keys that you can press to answer and end calls.
Physical feature keys	Many features on the phones are accessible by pressing feature keys on the phone console.
Tactile-discernible number, feature, and navigation keys	Keys on the phone console are discernible by their size and shape.
Illuminated feature keys	Many feature keys illuminate when activated to alert you when a feature is enabled.

Maintaining Poly VVX[®] Business IP Phones

Topics:

- [Investigate Warnings](#)
- [Remove Warnings](#)
- [Restart Your Phone](#)
- [Update the Phone's Configuration](#)
- [Test the Hardware](#)
- [Cleaning the Screen](#)
- [View Software Details](#)
- [Updating the Phone Software](#)

When the phone is not operating properly, you can investigate or troubleshoot issues along with any other tasks your administrator may ask you to perform.

Investigate Warnings

When a phone is unable to perform certain tasks, a Warning icon  displays in the status bar.

The warning icon lets you know that your phone has one or more important issues. You can view details about the issues from the Warnings screen.

Procedure

1. Go to **Settings > Status > Diagnostics**.
2. Select **Warnings**.

The **Warnings** screen is displayed listing any issues.

Remove Warnings

After you view phone warnings, you can temporarily remove the Warning icon from the status bar. However, the warning still displays in the Warnings list until the issue is fixed. The Warning icon is displayed each time your phone has a warning that you haven't viewed.

Procedure

- » In the **Warnings** screen, select **Clear Icon** to remove the Warning icon from the status bar.

Restart Your Phone

Your system administrator may ask you to restart the phone if it malfunctions or to assist in troubleshooting.

Caution: Before you restart the phone, contact your system administrator. If the phone is malfunctioning, you may be able to restore normal operation without restarting it. Additionally, your system administrator may want to troubleshoot the phone before you restart it. You do not need to restart the phone to update its configuration.

Procedure

1. Go to **Settings > Basic**.
2. Select **Restart Phone**.
A confirmation message is displayed.
3. Select **Yes**.
The restart process begins, and the process ends when the Home screen is displayed.

Update the Phone's Configuration

Your system administrator may ask you to update the configuration for your phone to apply any changes to system settings, which you can do without restarting it.

Procedure

1. Go to **Settings > Basic**.
2. Select **Update Configuration**.
A confirmation message is displayed.
3. Select **Yes**.
The configuration is updated. The phone may restart, depending on which settings have changed.

Test the Hardware

If your phone is having any issues, your system administrator may ask you to access a diagnostics menu on the phone to test its hardware.

You can test the display, microphones, and speaker. Contact your system administrator for instructions on how to perform these tests.

Caution: Do not run diagnostic tests during a call on VVX 450 business IP phones with two connected expansion modules. Doing so can cause the phone to reboot.

Procedure

1. Go to **Settings > Status > Diagnostics**.
2. Select **Test Hardware** and select one of the following:
 - **Audio Diagnostics**
 - **Display Diagnostics**

- **Brightness Diagnostics**
- **LED Diagnostics**
- **Keypad Diagnostics**

Cleaning the Screen

The phone screens require minor maintenance, but you may need to clean the screen periodically.

Use a clean, dry, microfiber cloth—the kind you would use to clean glass surfaces—to wipe the screen. Do not use chemicals to clean the screen.

Note: If the screen is still dirty after cleaning, dampen a soft, lint-free cloth with an isopropyl alcohol and water solution of 50:50, then wipe the screen with the cloth. Always use the dampened cloth to apply the solution; never apply the solution directly to the screen because the solution could seep inside the screen or stain the system. Do not use chemicals to clean the screen.

View Software Details

You can view the details for the software version on your phone, the latest software update available for your phone, and the status of the latest update.

Procedure

- » Navigate to **Settings > Status > Software > Update**.

Updating the Phone Software

You can update the software on your phone when a new software version is available. When new software is available, a notification is displayed on your phone and you have the option to update your software, postpone the software update, or exit the notification.

Update the Phone Software

When the software update notification is displayed on your phone, you can choose to update your phone's software at that time.

Procedure

- » When prompted to update your software, select **Update**.
The phone reboots and the software is updated on the phone.

Update Software Later

If you exit the software update, you can press the SWUpdate soft key to update your phone's software at any time after you exit the software update notification.

Procedure

- » Press the **SWUpdate** soft key.

Postpone Software Updates

Instead of updating your software immediately, you can choose to postpone the update for a later time.

You can choose to postpone the software update from 15 minutes up to six hours. You can postpone the software update up to three times. After the third time, the notification is displayed without the Postpone option.

If you do not update the phone's software after the postpone time, a notification with a countdown is displayed and the phone automatically reboots and updates the software when the countdown ends.

Procedure

1. When prompted to update your software, select **Postpone**.
2. Select one of the time options.

The notification is removed from the phone screen and is displayed again during the remaining five minutes of the postpone time selected.

Note: If you postpone a software update and the time period you chose ends while you're on an active call, a software update notification with a countdown is displayed after the call ends. After the countdown ends, the phone reboots and updates the software.

Exit the Software Update Notification

When the software update notification is displayed, you also have the option to exit the notification without choosing to update or postpone the software.

Procedure

- » When prompted to update your software, select **Exit**.

When you exit the notification, the SWUpdate soft key is displayed on the Lines screen.

Troubleshooting

Topics:

- [Speakerphone](#)
- [USB Port](#)
- [Check the Status of the Calendar](#)
- [Ribbon Communications Address Book](#)
- [Polycom Desktop Connector](#)
- [Troubleshoot Audio and Echo Issues](#)
- [Recording Issues and Solutions](#)
- [Reset the Phone to Factory Defaults](#)
- [Using an Approved Power Source](#)

If you are having issues with your Poly phone, you can try the troubleshooting options and solutions in the following topics to resolve certain issues.

Speakerphone

If your speakerphone doesn't work, your system administrator may have disabled it. If this is the case, a message displays after you press the speakerphone key informing you that Handsfree mode is disabled. In this case, use the handset or a headset to handle calls.

USB Port

If you attach a USB device to your VVX 250, 350, or 450 phone, and the phone does not detect the attached USB device, your system administrator may have disabled the USB port on your phone.

In this case, you cannot attach a USB device to your phone to use the following features:

- Call recording
- Picture frame
- USB headset

Contact your system administrator for help on enabling the USB port on your phone.

Check the Status of the Calendar

When you do not see the Calendar icon on the Home screen, or if you are not receiving meeting reminders, it is possible that the phone is not connected to the Microsoft Exchange Server.

Procedure

1. Navigate to **Settings** > **Features** > **Calendar**.
2. From the **Calendar** screen, select **Connect**.

Related Links

[Open the Calendar](#) on page 100

Ribbon Communications Address Book

If you are having issues accessing the Global Address Book (GAB), you can view the status of the GAB in the Status menu on your phone and contact your system administrator for further troubleshooting help.

Procedure

- » On your phone, navigate to **Settings > Status > Global Address Book**.
The status information and the server URL for the GAB are displayed.

View the Status of the Personal Address Book

You can view the status of the Personal Address Book on your phone to determine any issues with the PAB. Contact your system administrator for further troubleshooting help.

Procedure

- » Navigate to **Settings > Status > Contact Directory**.

The following information is displayed:

- Status
- Server Control Method
- Server URL
- Registration Index and User ID

Polycom Desktop Connector

If you encounter any issues using the Polycom Desktop Connector (PDC), see the following table for possible solutions to common problems.

Common PDC Problems and Solutions

Issue	Corrective Action
The computer and phone cannot establish a connection.	Verify the Polycom Desktop Connector settings on your phone. You may need to reboot your phone or press the Reconnect soft key.
I can't enter information in a phone field using my computer keyboard.	Check to see if the phone field has a flashing cursor. You can use PDC only to enter information in a phone field if the field has a flashing cursor.
I can't place a call.	If you're using PDC, you can't place a call using the New Call soft key. To place a call, enter the phone number and select Dial .

Issue	Corrective Action
<p>I want to change the phone that is connected to the Polycom Desktop Connector.</p>	<p>Disable the Polycom Desktop Connector, which is already connected to your computer and is in active state on your phone.</p> <p>Setup and enable the phone you want to connect to Polycom Desktop Connector. Once your computer receives an initial communication from the newly configured phone, it asks you to confirm the connection by displaying the message “You were controlling <MACaddress1> with your computer. Do you want to change to controlling <MACaddress2>?” Click OK.</p>

Troubleshoot Audio and Echo Issues

In some cases when you are using your headset during a call, your contacts may experience audio or echo issues, such as feedback of your voice or of their own voice. If your contacts hear an echo during a call when using your headset, enable echo cancellation on your phone.

Procedure

1. Go to **Settings > Basic > Preferences**.
2. Select **Headset > Echo Cancellation** and select **Enabled**.

Recording Issues and Solutions

If you encounter any issues recording calls, see the following table for possible solutions to common problems.

Common Recording Issues and Solutions

Issue	Corrective Action
<p>The message “USB device is full. Recording canceled” is displayed when I pressed Start.</p>	<p>Check that there is sufficient space on the USB flash drive.</p>
<p>The recording stopped during a call.</p>	<p>If the USB flash drive becomes full during recording, recording stops and the message “USB device is full. Recording stopped” is displayed.</p> <p>Delete previous recordings to make space on the USB drive.</p>
<p>The message “USB device removed unsafely. Recording canceled” displayed when I removed my USB flash drive during a call.</p>	<p>Do not remove the USB flash drive while recording. If you want to remove the drive during a call, press Stop, and then remove the drive.</p>

Issue	Corrective Action
The message “Unsupported USB device attached” displayed.	Refer to <i>Feature Profile 37477: Using Headsets with Polycom Phones</i> on Polycom Support for a list of USB devices supported on Polycom phones.

Reset the Phone to Factory Defaults

You can access the phone reset option without having to enter an administrator password.

After the administrator configures this feature on the phone, you can reset the phone to factory default settings.

Procedure

- » Navigate to **Settings > Basic > Reset to Factory**.

Using an Approved Power Source

Symptom:

If your phone is having the following issues, check your power supply:

- The phone cannot connect to the network.
- The phone does not start up properly or continues to restart.

Problem:

If you connect the wrong power supply to your phone, such as the power supply for a different or older Polycom phone, it could damage the phone, the phone will not function as expected, and it can void your warranty.

Workaround:

Only use the power supply designed for your phone or check with your system administrator about using Power over Ethernet.