

LENOVO THINKSTATION P520, P520C

# INTEL VIRTUAL RAID ON CPU (VROC) SUPPORT



---

## Contents

*SECTION 1 – INTEL VIRTUAL RAID ON CPU (VROC) [OVERVIEW]*

*SECTION 2 – VROC SUPPORT/LIMITATIONS BY PLATFORM*

*SECTION 3 – HOW TO INSTALL THE VROC DEVICE*

*SECTION 4 – HOW TO CONFIGURE THE VROC DEVICE*

*SECTION 5 – HOW TO CREATE THE M.2 RAID ARRAY*

*SECTION 6 – DOCUMENT REVISION HISTORY*

## Section 1 – Intel Virtual RAID On CPU (VROC)

Intel Virtual RAID on CPU (VROC) provides an enterprise RAID solution on platforms that support Intel Volume Management Device (VMD).

Intel Volume Management Device (VMD) provides support for RAID on PCIe NVMe Solid State Drives. Intel VMD's can use a minimum of 4 PCIe lanes and a maximum of 16 PCIe lanes. There can essentially be up to 4 NVMe SSD's per Intel VMD.

Intel VROC, combined with Intel RSTe 5.0 and VMD, allows bootable RAID on PCIe NVMe SSDs directly attached to the CPU PCIe lanes.

There are two types of VROC's supported on Lenovo Workstations:

- Intel Virtual RAID on CPU (VROC) – **Basic**
  - Supports RAID 0, 1, and 10.
- Intel Virtual RAID on CPU (VROC) – **Premium**
  - Supports RAID 0, 1, 10, and 5.

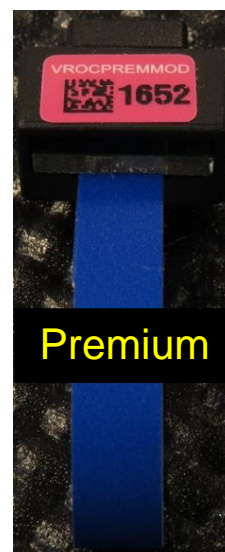

See Intel documentation for more details on Intel Virtual RAID On CPU (VROC):

<https://www.intel.com/content/www/us/en/support/memory-and-storage/ssd-software/000024498.html>

# ThinkStation P520c



CPU0

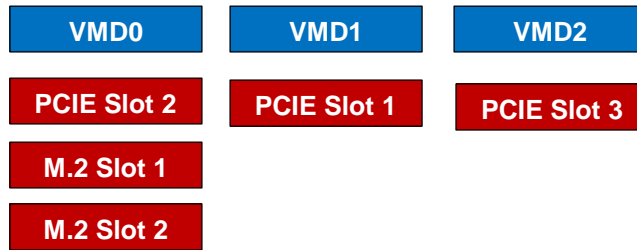

---

# ThinkStation P520

CPU0

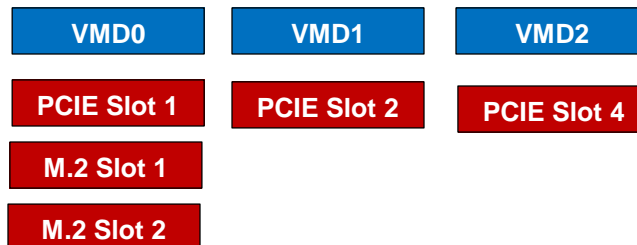

## Section 2 – VROC Support/Limitations by platform

The screenshots below correlate with the diagrams above in *Section 1* in regards to Intel VMD. Refer to the motherboard diagrams in *Section 3* to correlate the PCIe labels with the actual PCIe slot locations.

### ThinkStation P520c

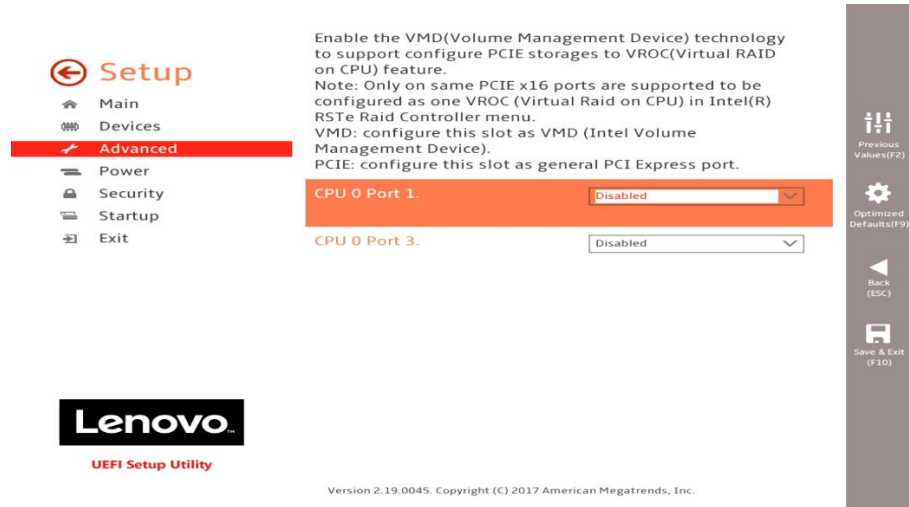

Enable the VMD (Volume Management Device) technology to support configure PCIe storages to VROC (Virtual RAID on CPU) feature.  
 Note: Only on same PCIe x16 ports are supported to be configured as one VROC (Virtual Raid on CPU) in Intel(R) RSTe Raid Controller menu.  
 VMD: configure this slot as VMD (Intel Volume Management Device).  
 PCIe: configure this slot as general PCI Express port.

CPU 0 Port 1.

CPU 0 Port 3.

Version 2.19.0045. Copyright (C) 2017 American Megatrends, Inc.

- ➔ “CPU 0 Port 1”
  - PCIe Slot 2 (x8 slot)
  - M.2 Slot 1 (x4 slot)
  - M.2 Slot 2 (x4 slot)
- ➔ “CPU 0 Port 3”
  - PCIe Slot 3 (x16 slot)

### ThinkStation P520

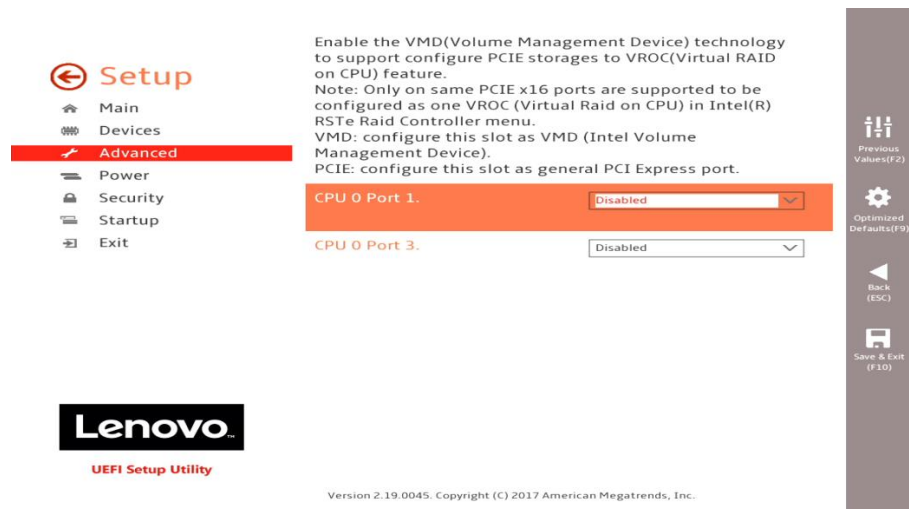

Enable the VMD (Volume Management Device) technology to support configure PCIe storages to VROC (Virtual RAID on CPU) feature.  
 Note: Only on same PCIe x16 ports are supported to be configured as one VROC (Virtual Raid on CPU) in Intel(R) RSTe Raid Controller menu.  
 VMD: configure this slot as VMD (Intel Volume Management Device).  
 PCIe: configure this slot as general PCI Express port.

CPU 0 Port 1.

CPU 0 Port 3.

Version 2.19.0045. Copyright (C) 2017 American Megatrends, Inc.

- ➔ “CPU 0 Port 1”
  - PCIe Slot 1 (x8 slot)
  - M.2 Slot 1 (x4 slot)
  - M.2 Slot 2 (x4 slot)
- ➔ “CPU 0 Port 3”
  - PCIe Slot 4 (x16 slot)

### Levels of Support:

- BOOTABLE RAID on NVMe SSDs – maximum of four NVMe SSDs.
    - Cannot span across multiple Intel VMD domains.
  - DATA RAID on NVMe SSDs
    - Can span across multiple Intel VMD domains.
  - Spanning across CPU's.
    - Not recommended as it could result in performance degradation.
  - UEFI
    - Does **not** support nor provide a Legacy Option ROM.
  - Three (3) Intel Volume Management Device (VMD) domains per single CPU.
- For **Debian** and **Ubuntu** Linux based operating systems, **VMD** mode is **NOT** supported; therefore, NVMe PCIe drives need to be set up as PCIE mode.
- For **RedHat** Linux based operating systems, VMD mode support is limited. RHEL 7.3/7.4 or equivalent operating systems can support VMD mode with a proprietary Intel RSTe/VMD driver. See “P520c-P520-P720-P920 RHEL 7 Installation” whitepaper for step-by-step instructions on how to get this to work.

## Section 3 – How to Install the VROC Device

Refer to the motherboard diagrams below for the location of the VROC header on the motherboard.

### P520c

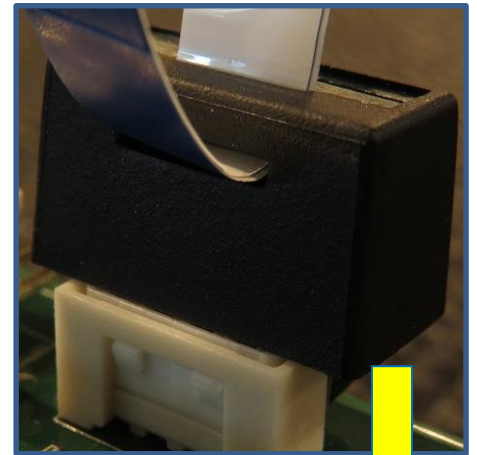
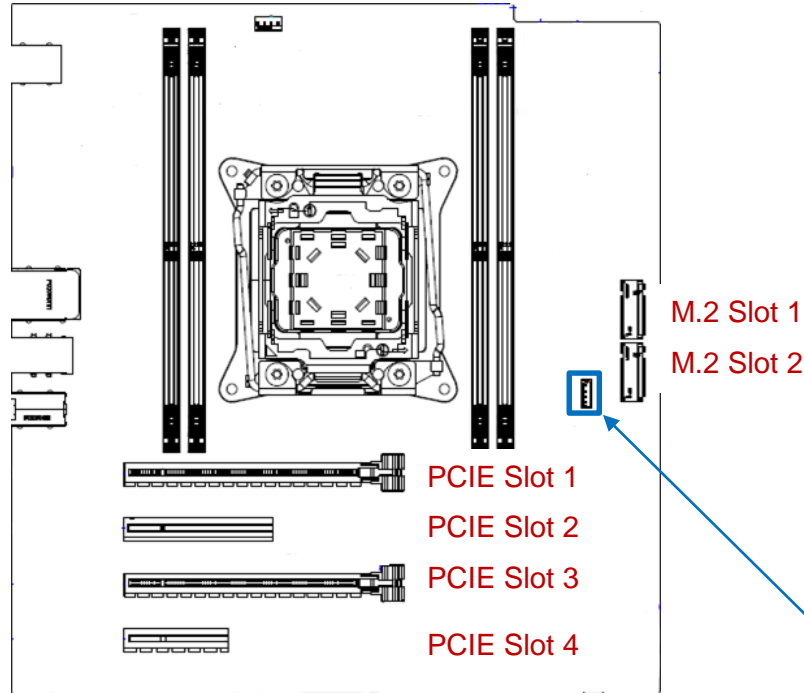

### P520

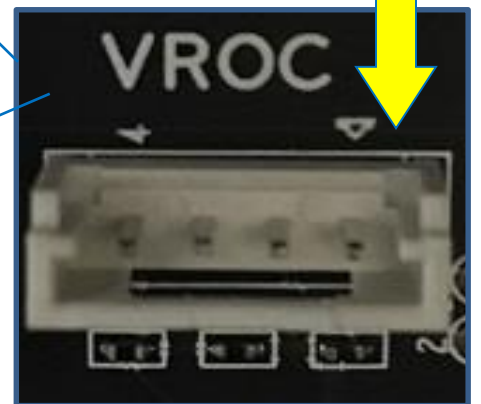
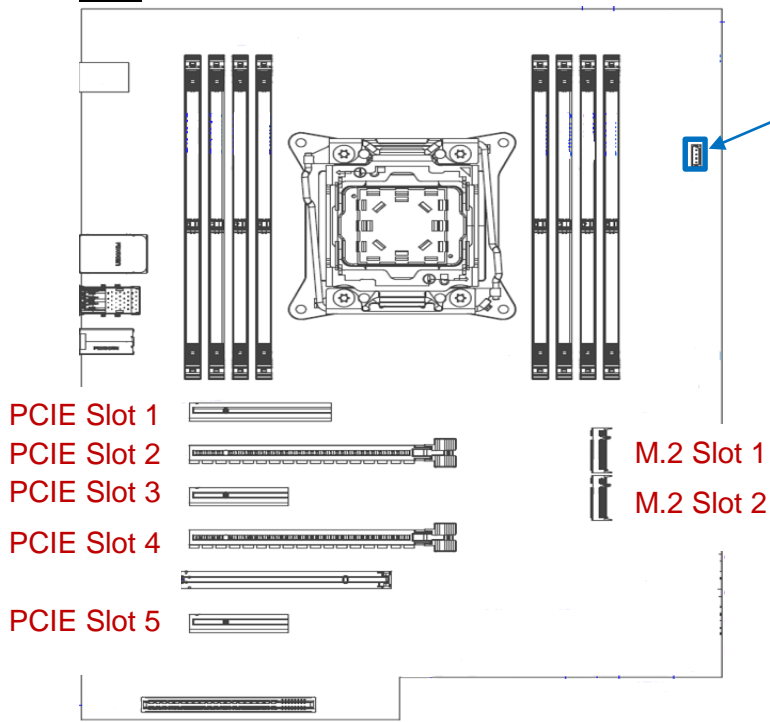

## Section 4 – How to Configure the VROC Device

Please see the following steps to configure VROC.

1. Boot into BIOS by pressing the function F1 key at the “Lenovo” splash screen.
2. Select “Setup” from the screen indicated below.



Version 1.01.0040. Copyright (C) 2017 American Megatrends, Inc.

3. Select “Advanced” (left) and “Intel VMD technology” (right).





4. Enable the appropriate CPU x Port y based on where the NVMe SSDs are installed in the system.

\*\*\*See Section 2 above for specific platforms.

5. Set the appropriate slots where the NVMe SSDs are installed to “VMD”.

\*\*\*See Section 2 above for specific platforms.

6. Press F10 to Save and Exit the BIOS setup menu. .

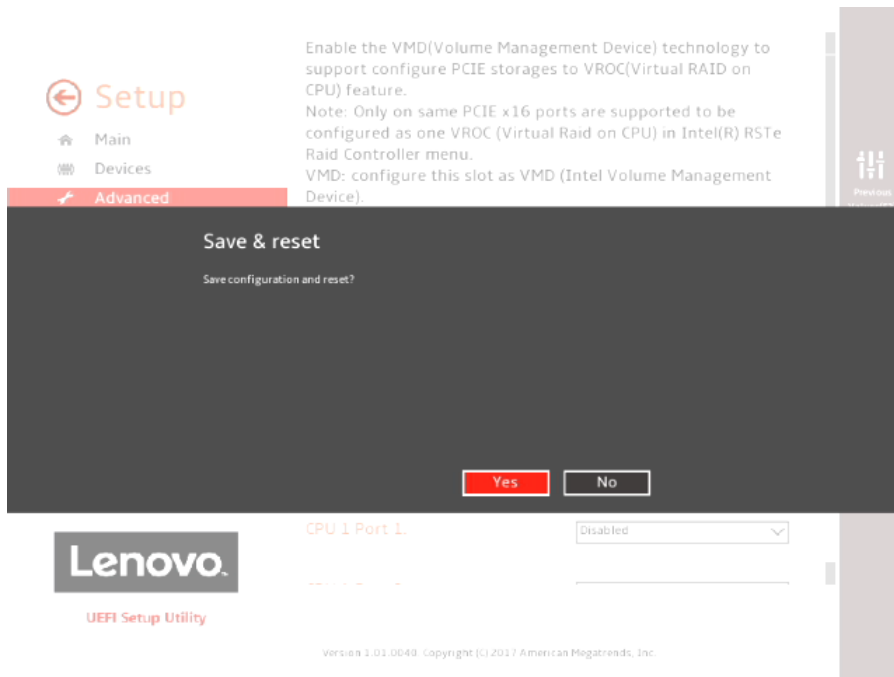

## Section 5 – How to Create the M.2/AIC RAID Array

Please see the following steps to create the NVMe SSD RAID Array.

1. Boot into BIOS by pressing the function F1 key at the “Lenovo” splash screen.
2. Select “Setup” from the screen indicated below.



Version 1.01.0040. Copyright (C) 2017 American Megatrends, Inc.

3. Select the “Advanced” menu option (left) and “Intel(R) Virtual RAID on CPU” (right).



4. Select “All Intel VMD Controllers”.



5. Select "Create RAID Volume".



6. Enter a unique volume name under the "Name" parameter.

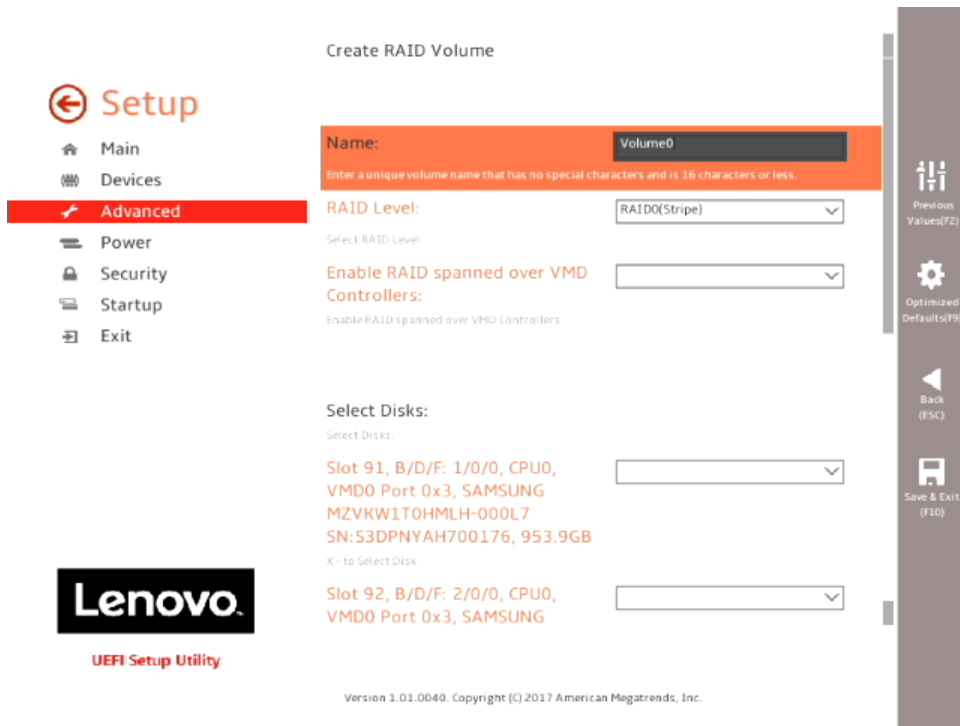

- 7. Select the RAID level. Only the available RAID levels will be shown in the drop-down menu based on the number of NVME SSDs and type of VROC installed.

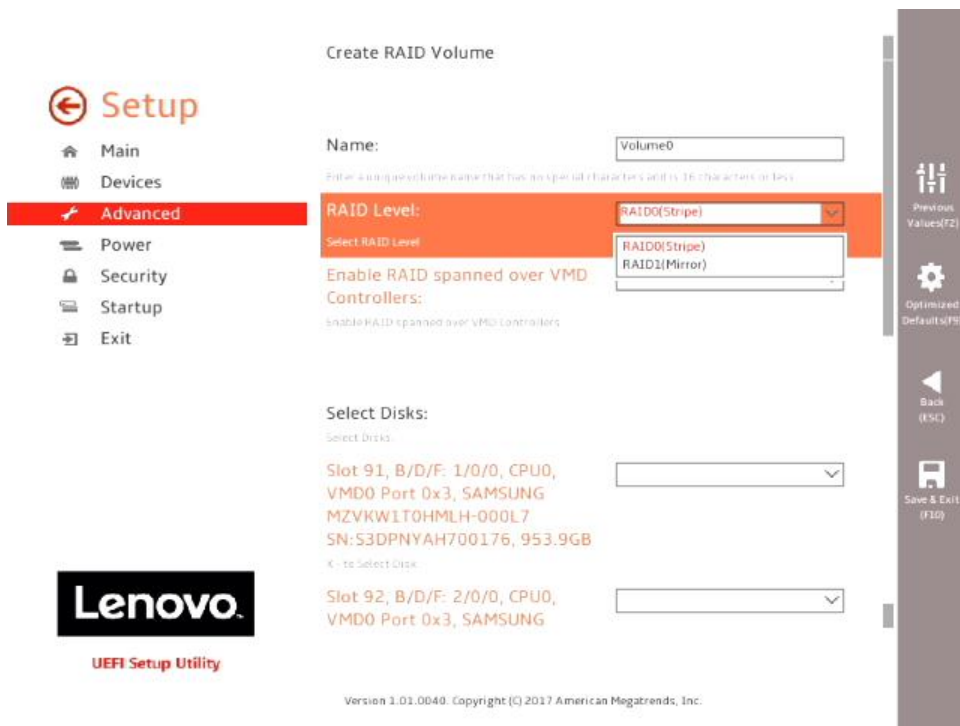

- 8. Select Disks to use in the RAID level selected.



**Setup**

- Main
- Devices
- Advanced**
- Power
- Security
- Startup
- Exit

### Create RAID Volume

**Name:**   
Enter a unique volume name that has no special characters and is 36 characters or less.

**RAID Level:**   
Select RAID Level.

**Enable RAID spanned over VMD Controllers:**   
Enable RAID spanned over VMD Controllers.

**Select Disks:**  
Select Disks.

Slot 91, B/D/F: 1/0/0, CPU0, VMD0 Port 0x3, SAMSUNG MZVKW1T0HMLH-000L7 SN:S3DPNYAH700176, 953.9GB  
 X - To Select Disk

Slot 92, B/D/F: 2/0/0, CPU0, VMD0 Port 0x3, SAMSUNG  
 X - To Select Disk

**Create Volume**  
Create a volume with the settings specified above

Version 1.01.0040. Copyright (C) 2017 American Megatrends, Inc.

Previous Values(F2)  
Optimized Defaults(F9)  
Back (ESC)  
Save & Exit (F10)

9. Select "Create Volume".

**Setup**

- Main
- Devices
- Advanced**
- Power
- Security
- Startup
- Exit

**Strip Size:**   
Strip size help

**Capacity (MB):**   
Capacity in MB. Enter desired volume size. Maximum size=1953516

**Create Volume**  
Create a volume with the settings specified above

Version 1.01.0040. Copyright (C) 2017 American Megatrends, Inc.

Previous Values(F2)  
Optimized Defaults(F9)  
Back (ESC)  
Save & Exit (F10)

10. Once a RAID volume has been created, the user should be able to see this under the “All Intel VMD Controllers” menu option.

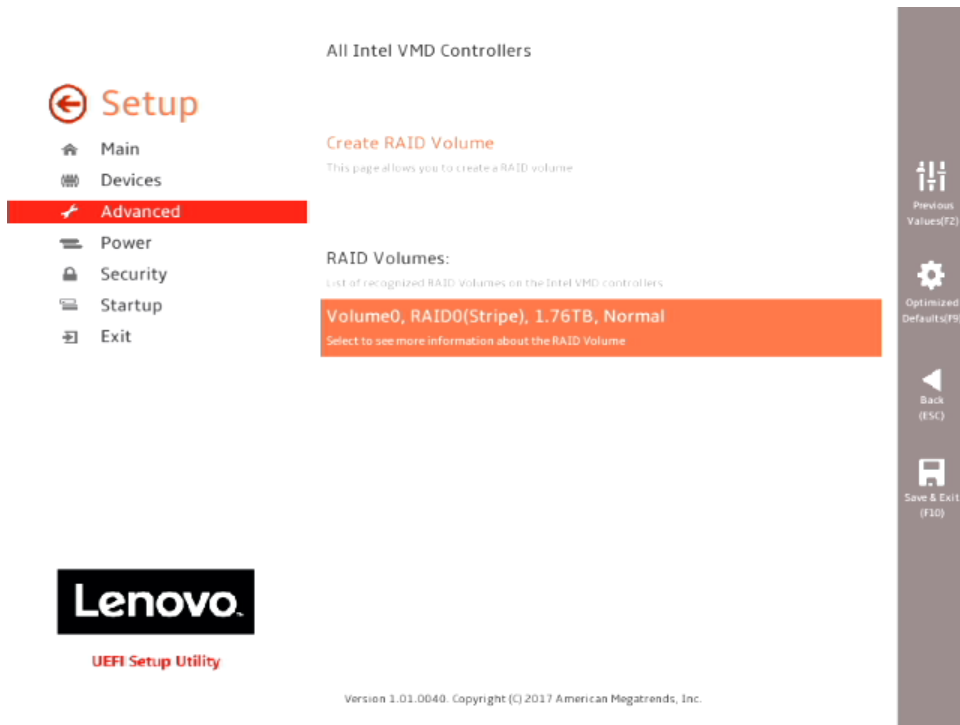

11. To delete the RAID volume, select the RAID volume in the previous step and select “Delete” on the next screen.

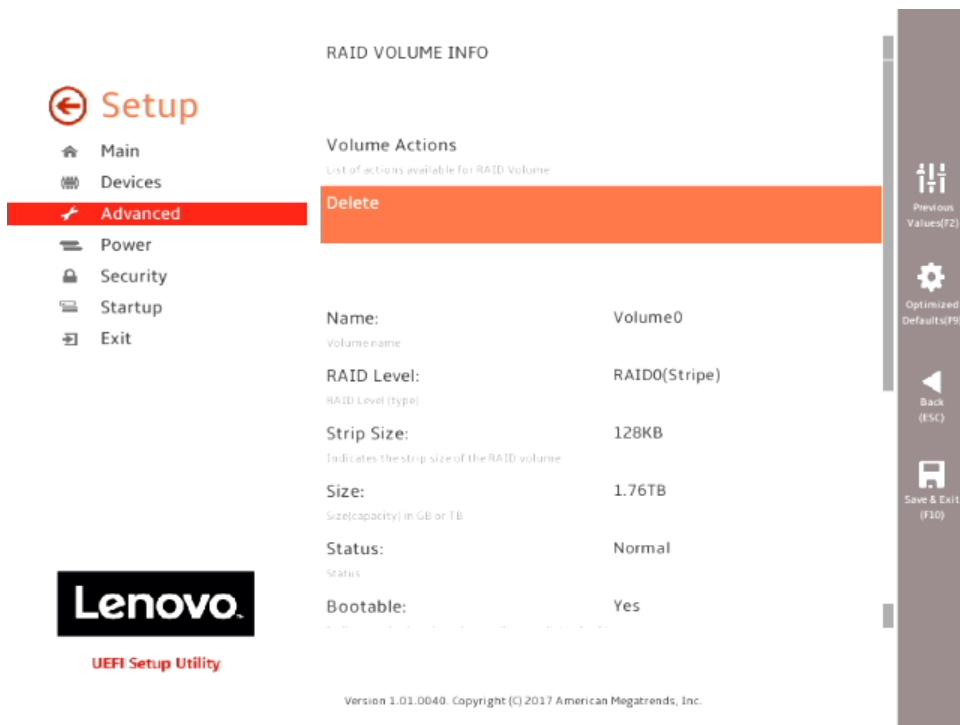

---

## Section 6 – Revision History

Version	Date	Author	Changes/Updates
1.2	11/7/2018	Jason Moebis	Added Linux levels of support. Changed CPU1 to CPU0 nomenclature.
1.1	11/8/2017	Jason Moebis	New cover page. Added 'Contents' section. Added 'Revision History' section.
1.0	10/2/2017	Jason Moebis	Initial launch release