

Storage Configurator

Lenovo ThinkStation P7



Table of Contents

Overview	3
Section 1 – P7 Storage Summary	4
Section 2 – P7 M.2 SSD Details.....	5
Section 3 – P7 SATA Hard Drive Details.....	36
Section 4 – Appendix	47
Revision History	49



Overview

ThinkStation P7 is a single processor, 39L tower added to the Lenovo workstation portfolio in the spring of 2023. P7 offers multiple different storage options for M.2 and 3.5" SATA drives. This document describes the P7 storage subsystem and provides configuration guidelines to help you set up the optimal storage solution for your needs.

Section 1 – P7 Storage Summary

The tables below give a quick snapshot of the type, capacity, and quantity of storage devices supported on P7.

Table 1 – P7 Storage Types

Drive Type and Speed	P7 Supported Capacity
M.2 PCIe SSD Gen4 x4	Up to 4TB
3.5" SATA Gen3 Hard Disk Drive	Up to 2TB
3.5" SATA Gen3 Enterprise HDD	Up to 12TB

Table 2 – Quantity and Capacity by Drive Type

Drive Type	Number of Drives Available	Total Storage
3.5" SATA Drives	3	Up to 36TB
M.2 PCIe Drive	9	Up to 28TB

Table 3 - Storage Summary

Storage Location	Drive Type Supported
Internal onboard M.2 slots	<p>Standard 2 x M.2 SSD Gen5</p> <p>Optional 1 x M.2 SSD Gen4</p>
Front access FLEX bay *Note: Not configurable with internal bays CPU-based NVMe storage	1 x M.2 SSD Gen4 (CPU)
Internal bays 1 and 2	<p>One of 2 x 3.5" SATA Gen3 (Chipset) 2 x M.2 SSD Gen4 (CPU)</p>
Internal bay 3	1 x 3.5" SATA Gen3 (Chipset)
PCIe Slot expansion	4 x M.2 SSD Gen3 (by adapter)

Section 2 – P7 M.2 SSD Details

The P7 platform supports a variety of different M.2 SSD storage options. The two tables below give details on the features, compatibility, and required parts for M.2 SSDs. Installation location and information for each of the M.2 SSD options can be found in the subsequent pages.

Table 4 – M.2 features

Feature	Onboard M.2 slots	Third onboard M.2 kit	FLEX bay M.2 kit	Internal bays M.2 kit	Quad M.2 PCIe Card Gen3
Drive Count (System max = 10)	2	1	1	2	4
Maximum PCIe speed	Gen5	Gen4	Gen4	Gen4	Gen3
Availability	Standard	Optional	Optional	Optional	Optional
Location	Motherboard	Carrier off motherboard	Front access FLEX bay	Internal 3.5" bays	PCIe slot
Controller	CPU	CPU	CPU	CPU	CPU
Supported M.2 dimensions (mm)	2280 / 22110	2280	2280	2280	2242, 2260, 2280, 22110
Double side support	Yes	Yes	Yes	Yes	No
Maximum power per drive	8W	8W	8W	8W	8W
Front accessible	No	No	Yes	No	No
Toolless	Yes	Yes	Yes	No	No
Hot swappable	No	No	Yes	No	No
Individual activity/status LEDs	No	No	Activity only*	No	No
Combined in system activity LED	Yes	Yes	Yes	Yes	Yes

*Refer to the photo below for the location of the front panel storage activity LED



Table 5 – M.2 compatibility and required parts

Location	Compatibility	Requirements and parts
Onboard (OB)		<ul style="list-style-type: none"> M.2 Carrier and Heatsink kit standard on motherboard
Third onboard M.2 kit	<ul style="list-style-type: none"> Limits PCIe slot 7 to half length Not compatible with double-wide GFX adapter in slot 5 	<ul style="list-style-type: none"> M.2 Vertical holders for OB 3rd M.2 SSD
FLEX bay M.2 kit	<ul style="list-style-type: none"> Not compatible with internal 3.5" bays M.2 kit 	<ul style="list-style-type: none"> Front storage tray M.2 storage access box for front storage bay FLEX bay fan
Internal 3.5" bays M.2 kit	<ul style="list-style-type: none"> Not compatible with <ul style="list-style-type: none"> FLEX bay M.2 kit Internal 3.5" bays standard SATA 	<ul style="list-style-type: none"> HDD bay for NVMe SSD kit (includes backplane and cable) Internal tray for M.2 SSD Internal HDD bay fan
Quad M.2 PCIe card Gen3	<ul style="list-style-type: none"> Requires available x16 slot 	<ul style="list-style-type: none"> Quad M.2 PCIe adapter



Onboard M.2 SSD installation

The location of the two standard onboard M.2 SSDs can be seen in this picture:

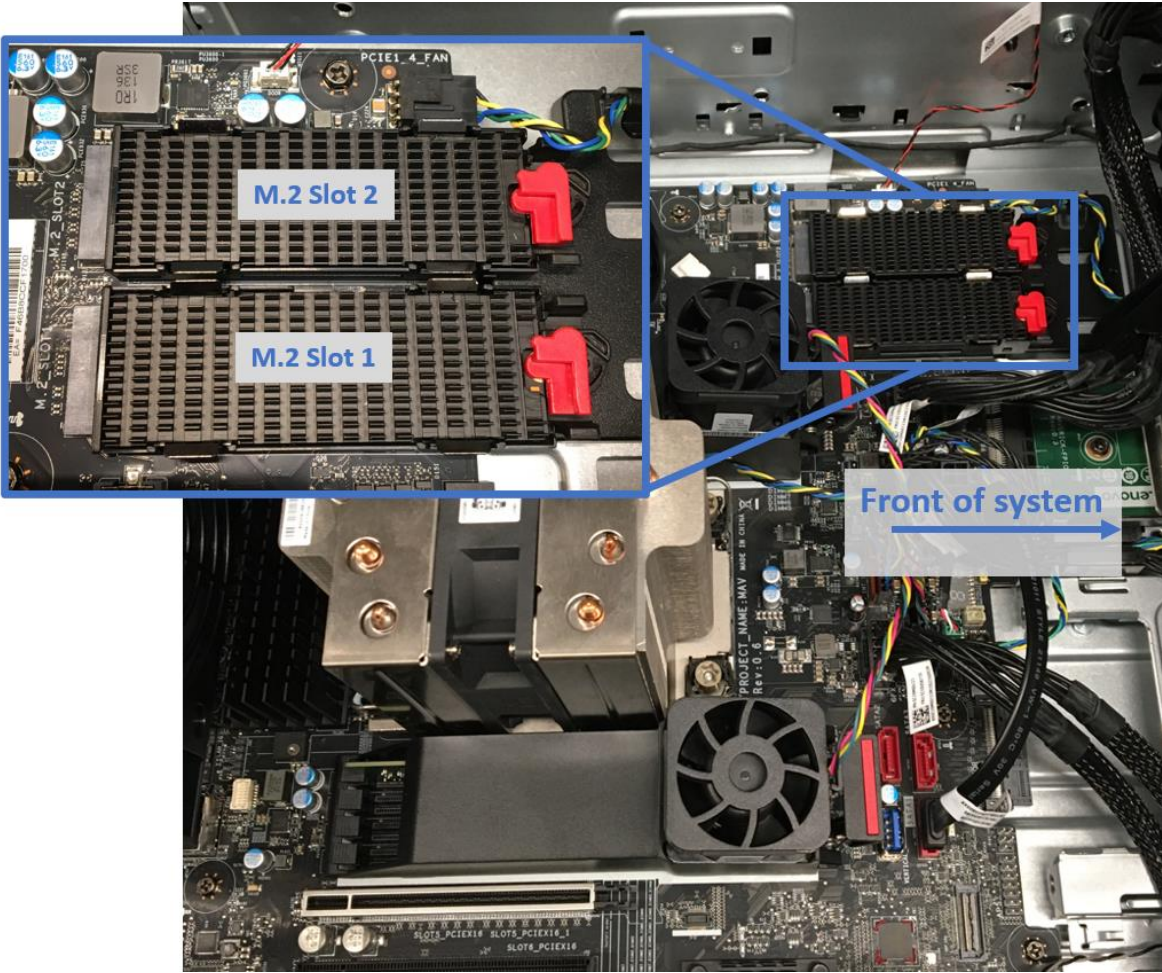

Each M.2 module consists of the M.2 carrier, heatsink, and the drive itself.

1. Open the side cover of the P7 and remove any PCIe adapters that may interfere with accessing the onboard M.2 slots.
2. Rotate the red latch counterclockwise to release the M.2 carrier.

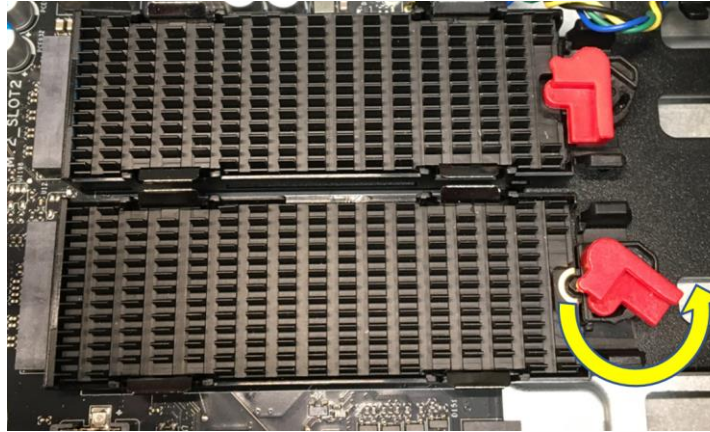

3. Tilt the front side of the M.2 carrier up slightly and pull to the right to remove it from the socket.

Caution: Tilting the carrier to an angle greater than about 20° can damage the socket.

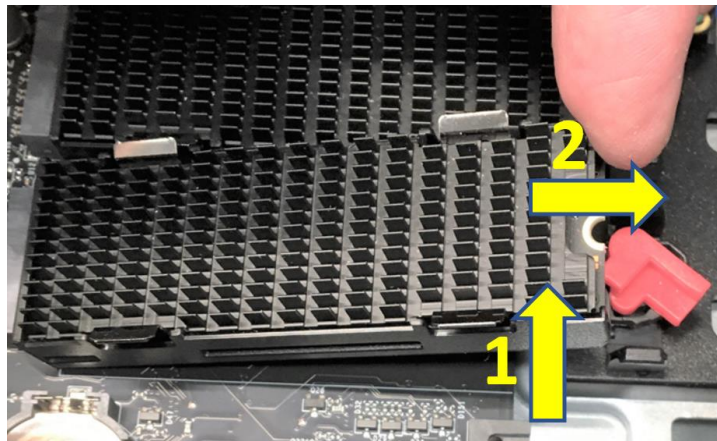

- 4. Lay the M.2 carrier flat on a desk and carefully separate the heat sink from the carrier by gently pushing two of the tabs on one side away from the heat sink.



- 5. Remove the plastic insert as well as the thermal pad plastic film.

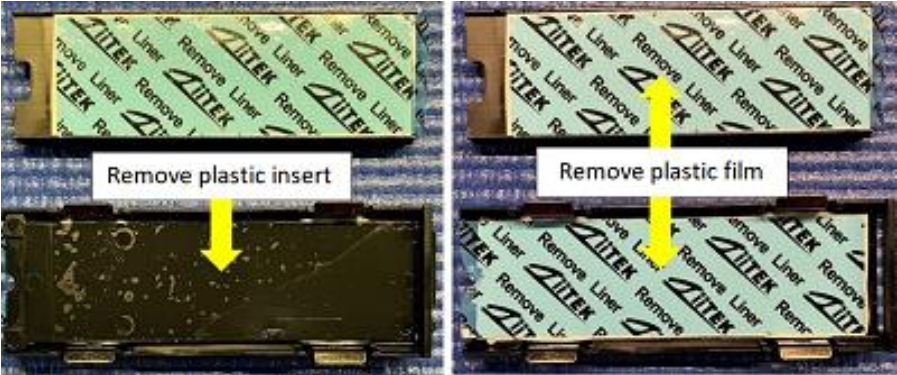

- 6. Insert the M.2 drive carefully in the M.2 carrier as shown below.

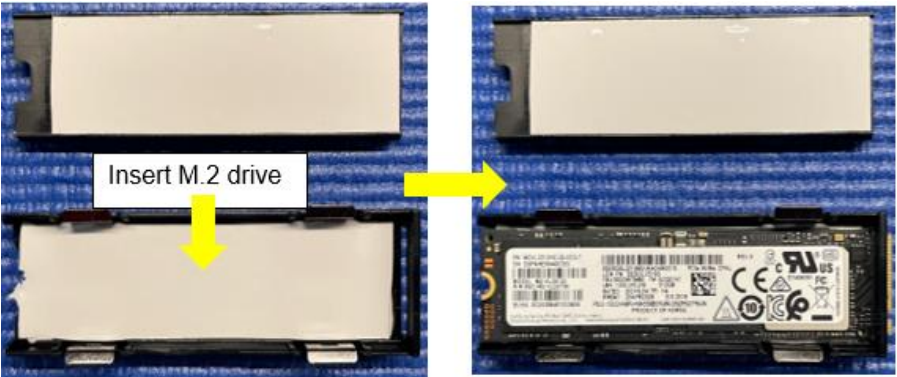

7. Reinstall the heatsink on top of the M.2 drive within the carrier by inserting the feet on one side of the heat sink into the openings of two of the tabs on one side of the carrier. Then press down on the other side of the heat sink until the feet engage the tabs on the heatsink.



8. Insert the M.2 carrier back into the onboard M.2 slot at a slight angle and press the end down into the slot.

Caution: Be careful not to use excessive force as this risks breaking the M.2 slot.

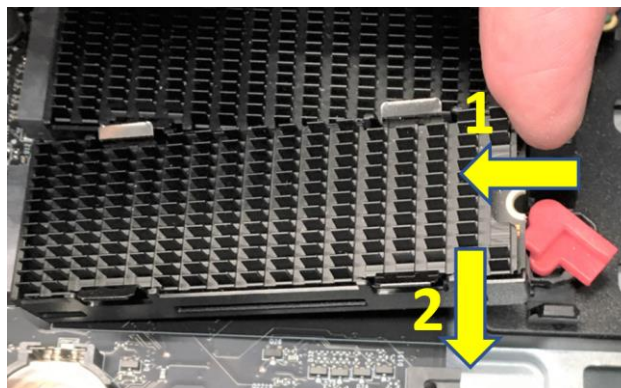

9. Rotate the red latch clockwise to the locked position, securing the M.2 carrier into the system.



Third onboard M.2 kit installation

The third onboard M.2 kit is an optional kit that will need to be purchased separately if it was not ordered when the original system was built. The kit is mounted on the rear of the internal 3.5" drive bays, as seen in the following pictures.

From above:

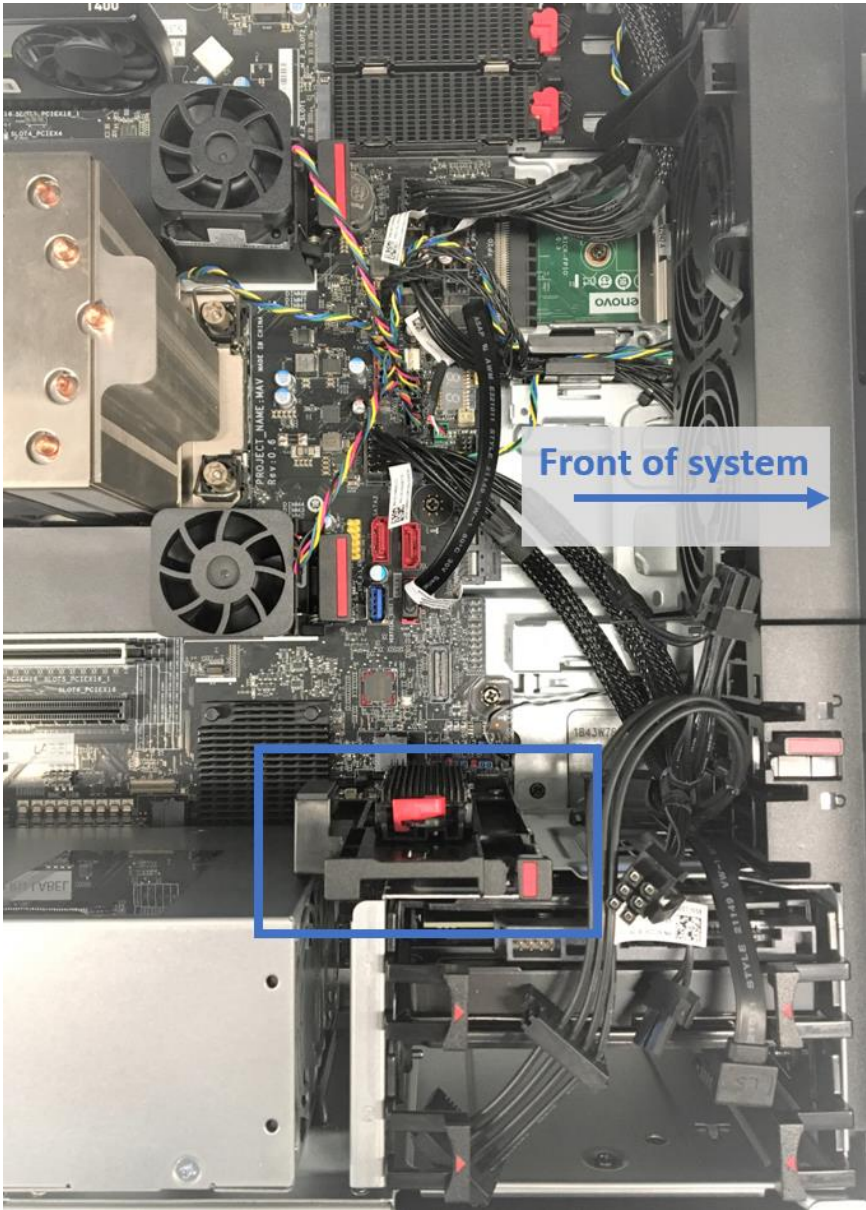

...and from the other side:

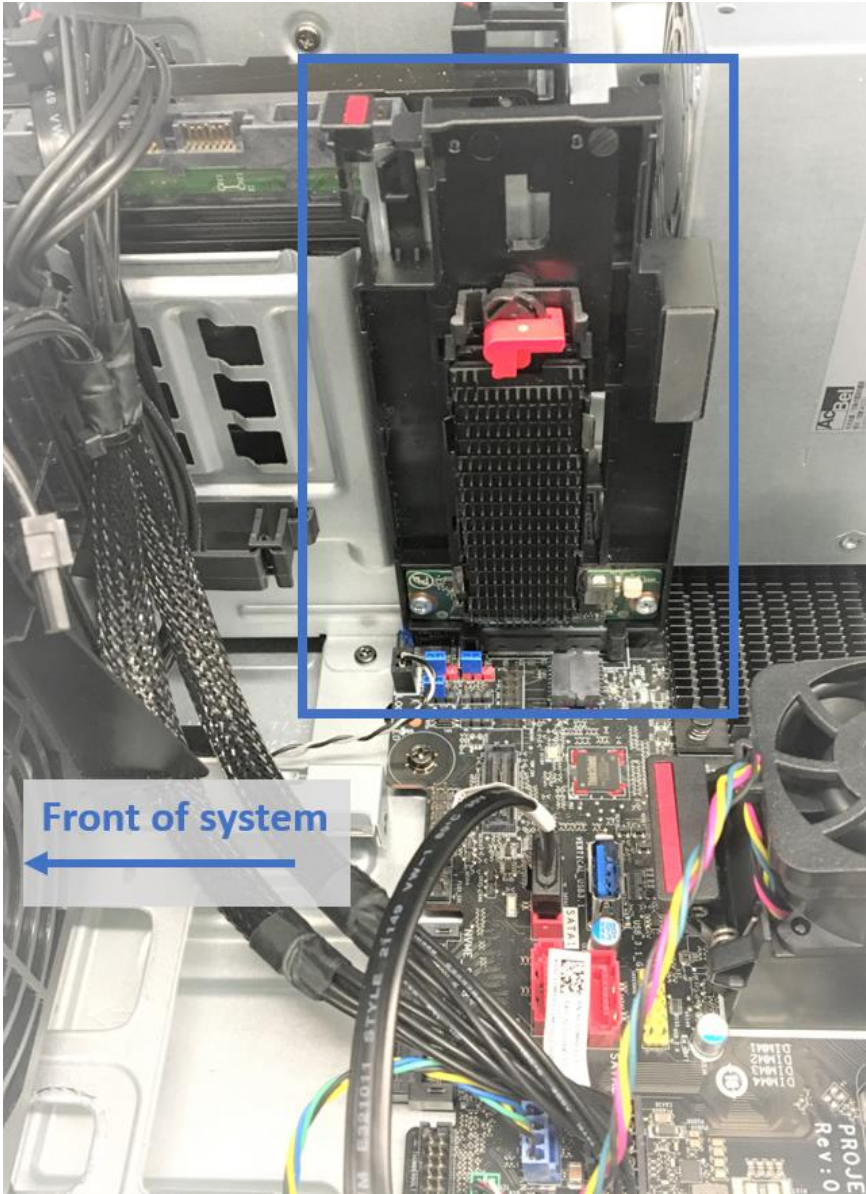

The third onboard M.2 kit consists of the vertical holder w/ interposer card and the M.2 carrier, as seen in the following photos.

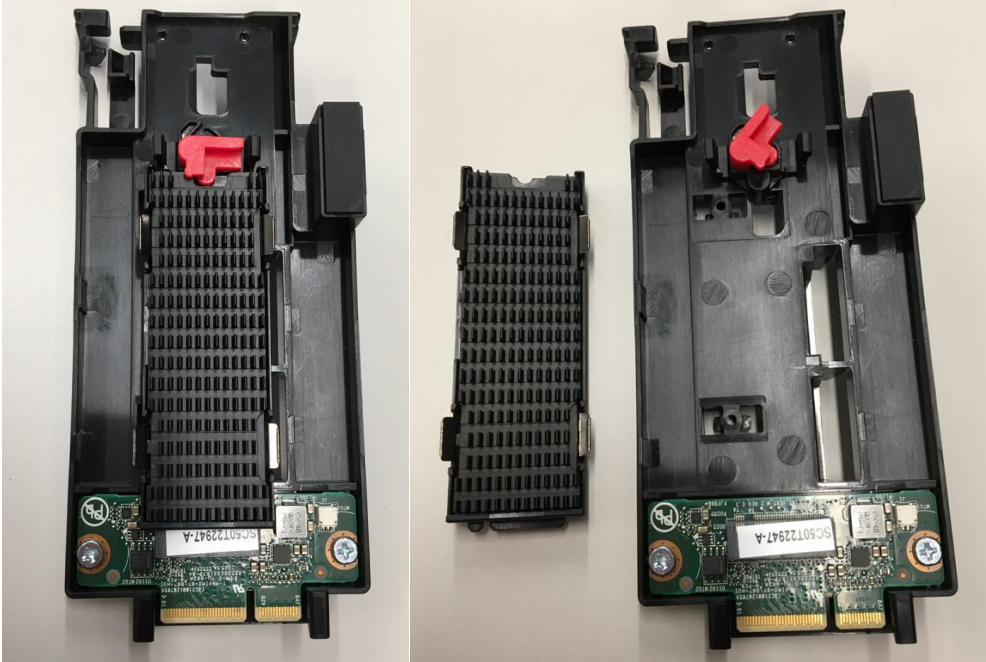

1. The M.2 carrier itself is identical to the one used for the onboard M.2 drives, so please follow the installation instructions from the previous section to install the M.2 drive and heatsink into the carrier and then the carrier into the vertical holder.
2. On the rear of the vertical holder, you will find a couple of mounting tabs:

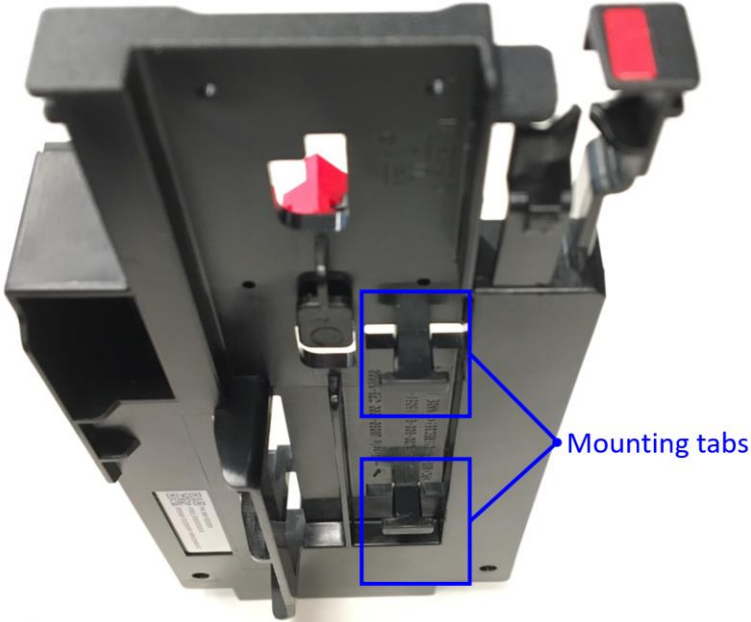

Then, when looking at the inner side of the SATA drive bay, you will also find two mounting channels on the chassis and a card connector socket directly beneath on the motherboard:

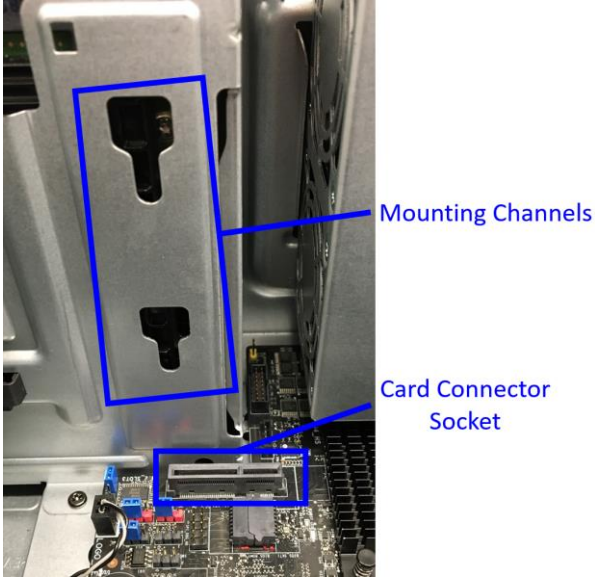

In order to mount the M.2 holder, insert the mounting tabs into the channels, align the interposer card edge connector with the socket as shown below, and press the whole assembly straight down until you feel it lock into place.

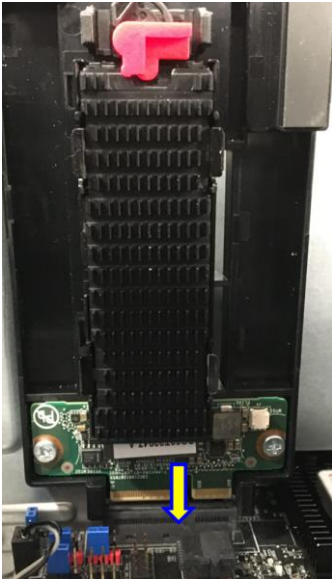

FLEX bay M.2 kit installation

The front access FLEX bay is located on the front of the P7, as shown here:

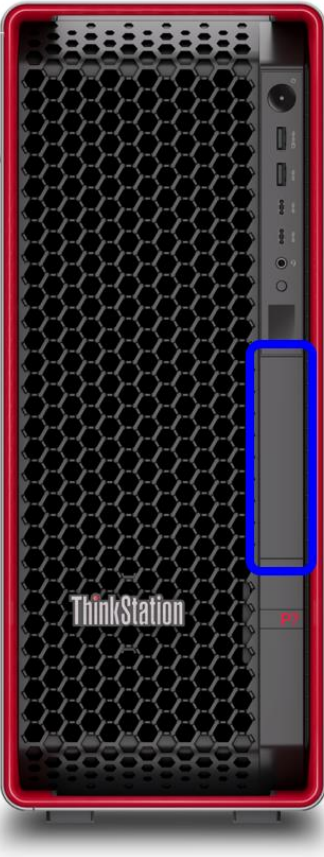

The FLEX bay can hold a single M.2 drive, which can be installed as long as the internal 3.5" bay M.2 drive kits are not in use. The M.2 drive is mounted into a FLEX bay carrier, which is then inserted into the FLEX bay slot.



FLEX Bay Carrier



FLEX Bay Slot

- 1. Install the FLEX bay into the FLEX bay frame through the bezel. Push the bay until the retention tab locks the bay into place in the frame.



- 2. To install the M.2 SSD into the FLEX Bay M.2 carrier, remove the screws from each side of the carrier.



- 3. Lift up on the lid on the end of the carrier slightly (1) and slide the lid out from under the tabs on the front of the carrier base (2).



- 4. Peel back and remove the protective film from the heat sink pads on the lid and base.

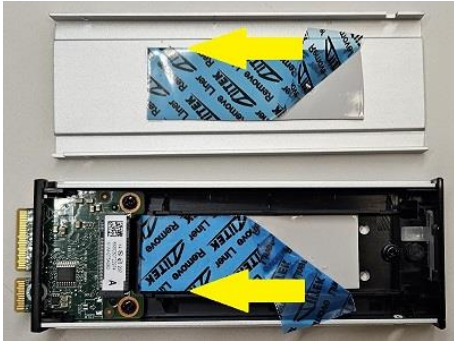

5. Remove the M.2 retention screw from the carrier base.



6. Insert the M.2 SSD into the M.2 slot in the carrier base at a slight 15-degree angle (1). Gently lower the M.2 into place with the round notch lining up with the screw hole in the carrier base (2). Reinstall the screw to secure the M.2 drive in the carrier.



Caution: Be careful not to use excessive force as this risks breaking the M.2 slot or drive.

7. Holding the lid at a slight angle, slide the lid under the tabs on the front of the carrier base (1) and lower the lid into place (2) with the holes on the lids aligning with the screw holes on the base. Reinstall the screws to secure the carrier lid in place.



8. Insert the M.2 carrier into the FLEX bay through the front opening. Push firmly until the carrier latches into place in the FLEX bay.

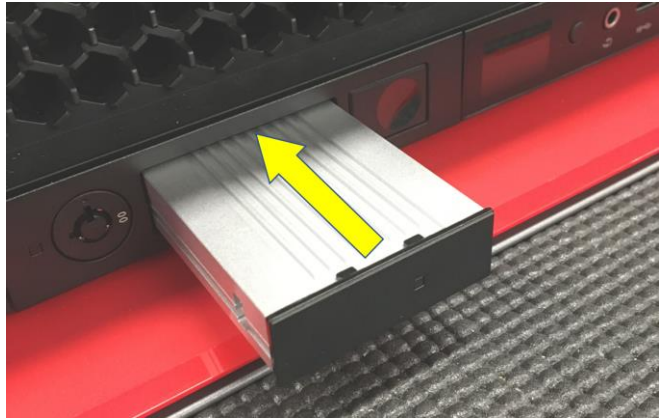

9. After installing the M.2 carrier, you need to install the FLEX bay fan on the inside of the system. Note that the fan has two tabs on one side of the shroud:

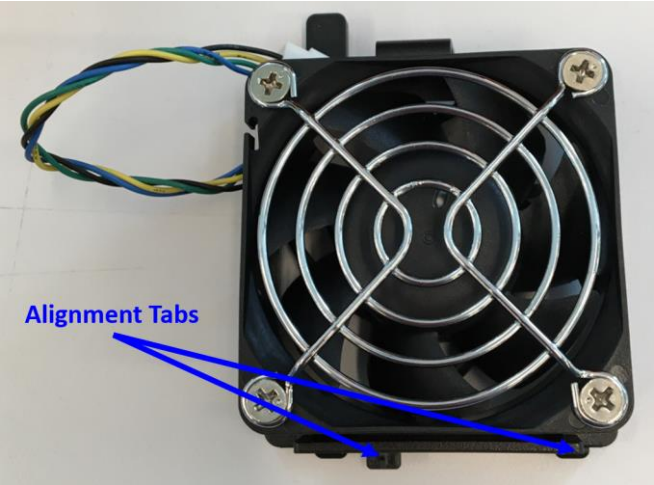

10. Align the tabs with the notches in the chassis directly above the FLEX bay:

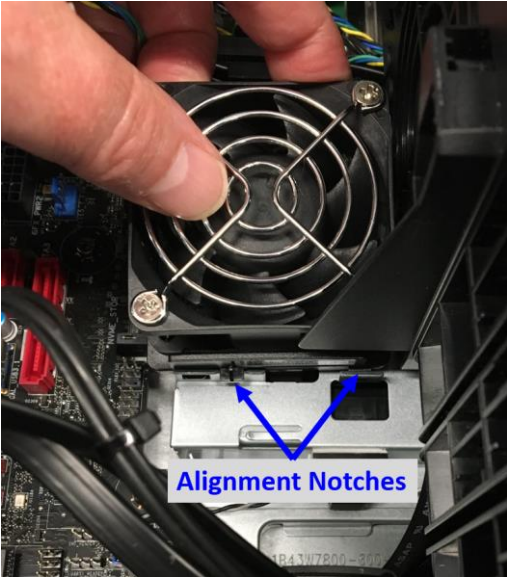

11. Press down on the tab on the other side of the fan until you feel it latch into place.



12. Plug the fan power cable into the matching connector on the motherboard.

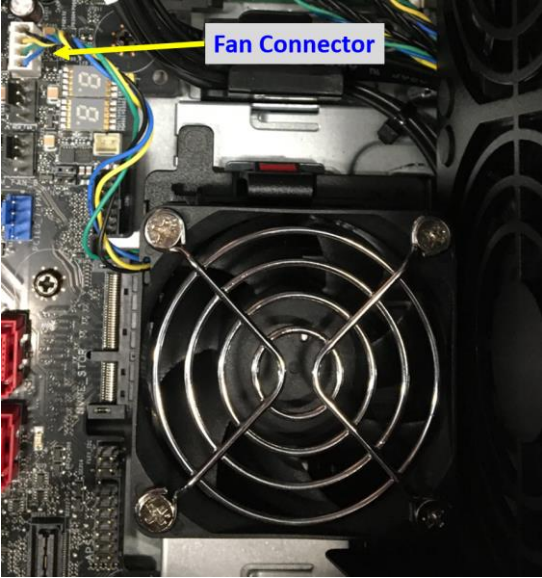

13. To remove the carrier, press the eject button on the side of the FLEX bay.



14. The FLEX bay also includes 2 keys in a mountable key carrier. These keys can be used to lock the M.2 carrier into place once it has been inserted.



15. On the back of the system chassis there are two locations for storage of key carriers for both the side door keys and the FLEX bay keys, as needed. If there is no lock for the side door, both of these locations will be available. Both locations are identical and either can be used.

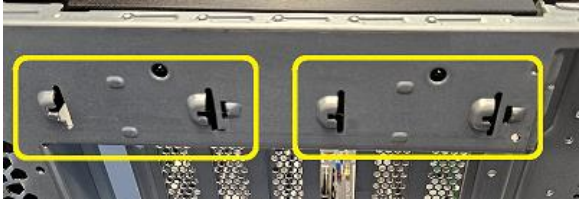

16. On the bottom of the key carrier, locate the two mounting tabs. Note the open end with the center guide on each tab.



17. Position the carrier to insert the open end of the tabs into the notches on one of the key carrier mount locations. Line up the center guides on the carrier with the openings in the center of the notches

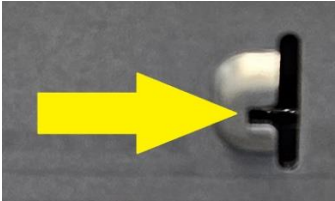

18. Slide the carrier into the notches until the catch on the end of the carrier, seen below, locks into place. If it does not slide into place easily, it may be necessary to put pressure on the carrier, directly over each tab.



Internal 3.5" bay M.2 kit installation

Another storage option is available via two internal 3.5" drive bay M.2 kits. Up to two M.2 drives can be installed, given that the following conditions are met:

- 1. No 3.5" SATA HDDs are installed in the standard slots
- 2. The front storage FLEX bay is not installed

The location of the 3.5" bay M.2 kits can be seen here:

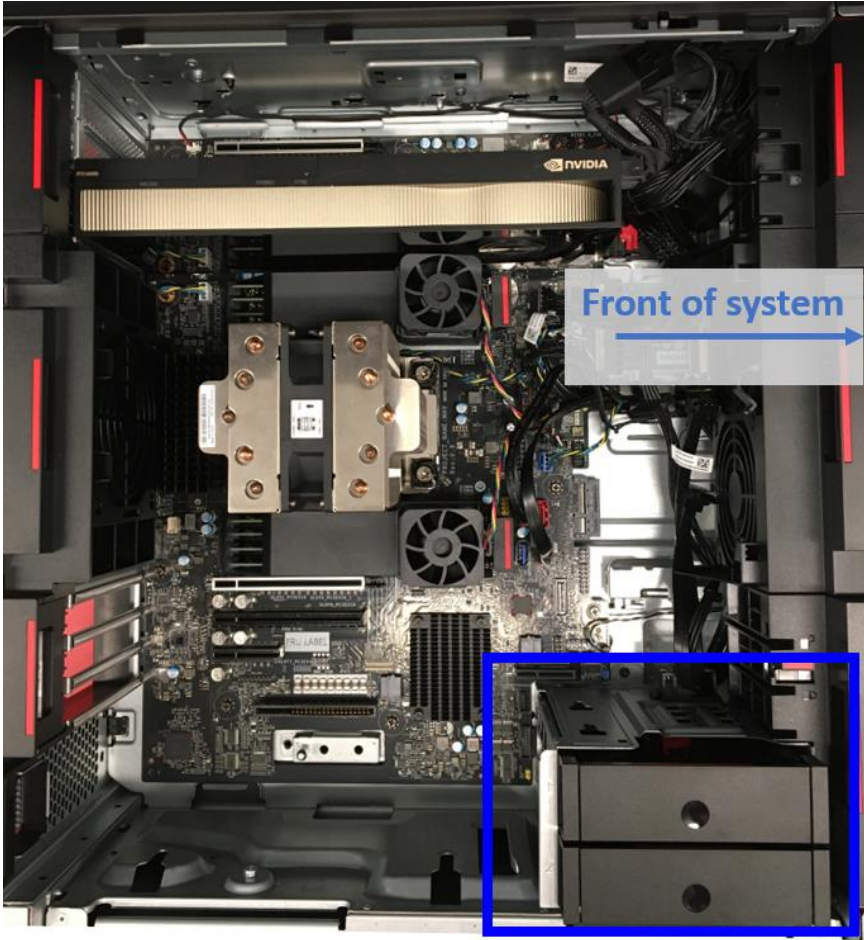

The 3.5" bay M.2 kits consist of the internal tray with the M.2 carrier, the blind connect board (BCB), and the 200mm 84-pin NVME Gen5 cable, shown here:

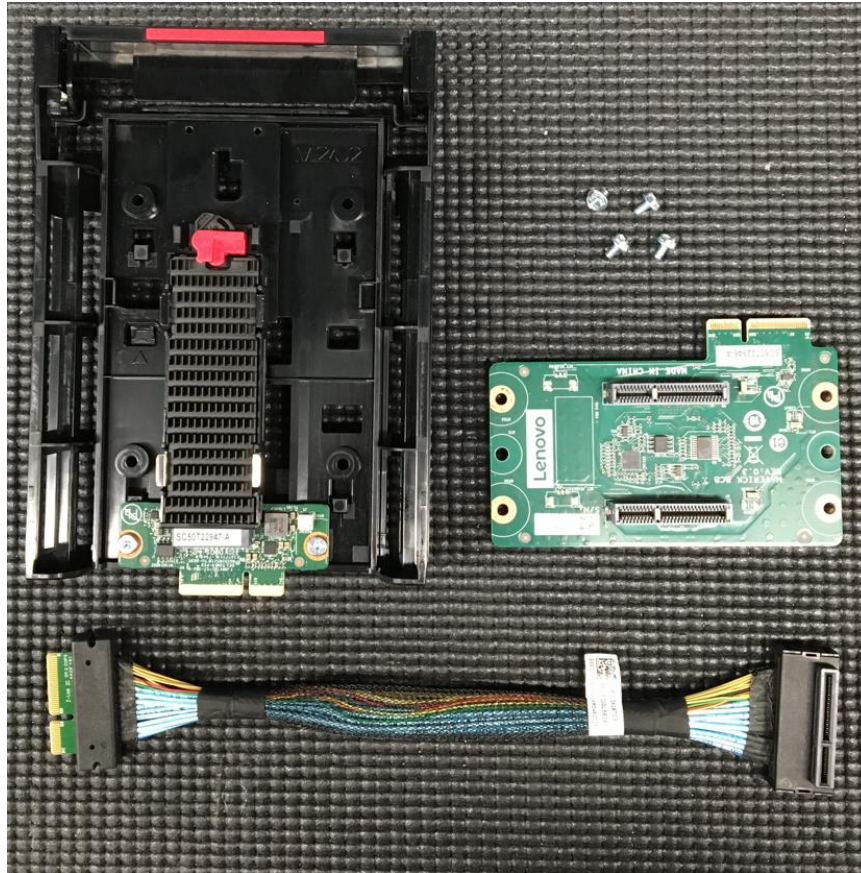

1. The M.2 carrier itself is identical to the one used for the onboard M.2 drives, so please follow the installation instructions from that installation section to install the M.2 drive and heatsink into the carrier and then the carrier into the internal tray.

- At the bottom of the 3.5" bay cavity, you will see 4 threaded screw holes and 2 alignment dimples, as shown here:

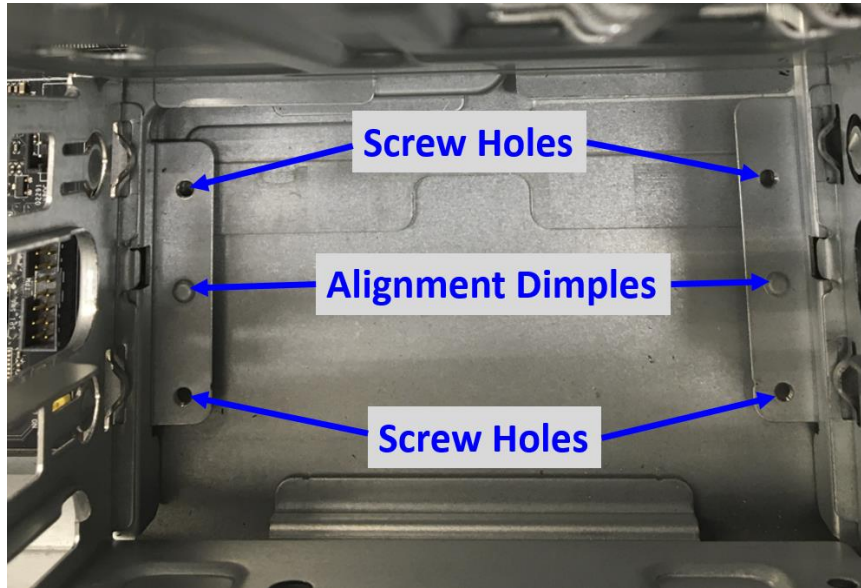

- This is where the BCB circuit board needs to be installed. On the BCB itself, you will see 4 screw pilot holes and 2 alignment holes, as shown here:

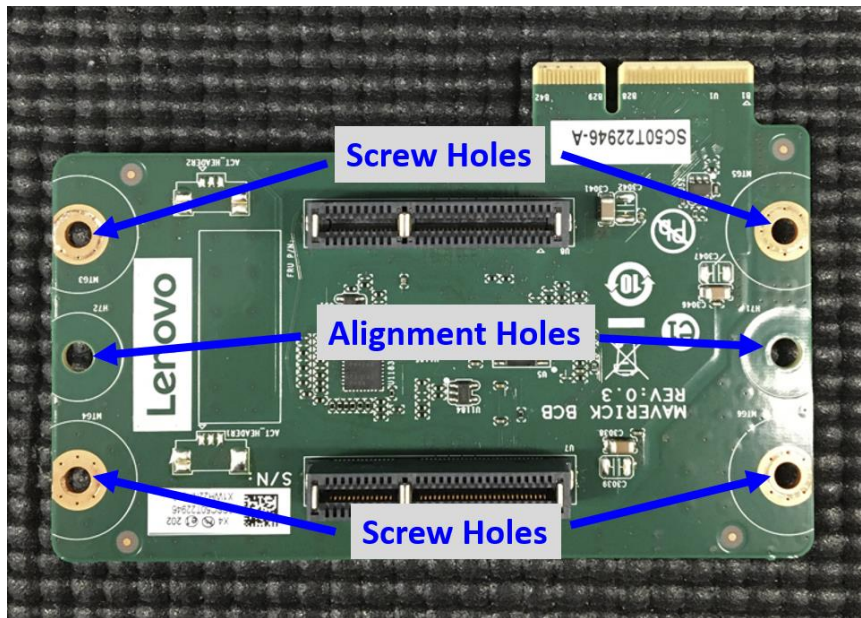

- Insert the BCB in the bottom of the 3.5" bay cavity and position it so that the alignment dimples on the chassis mate with the alignment holes on the board.

The properly aligned BCB should look like this:



5. Make sure that the card edge connector contacts protrude into the empty cavity just beyond the inside wall of the 3.5" bay:

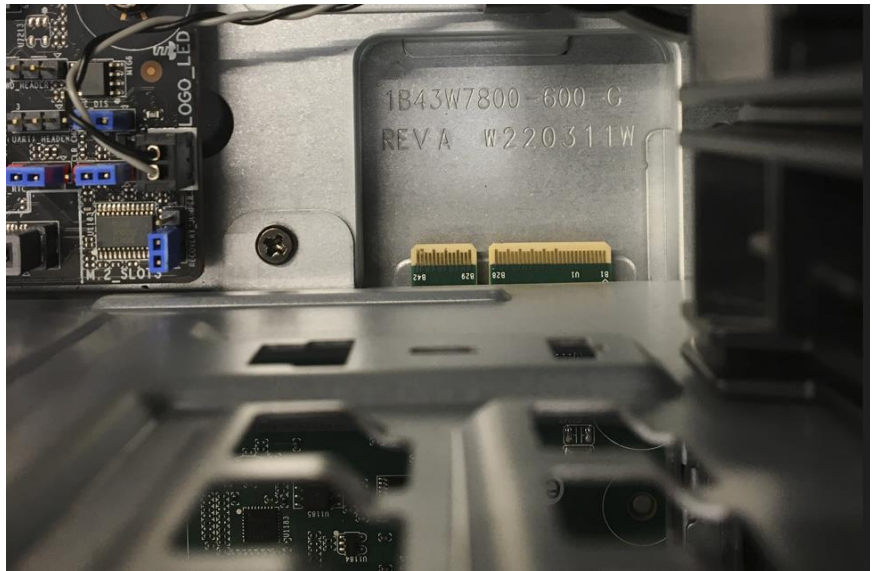

6. Secure the BCB into place with the 4 provided M3 Phillips head screws.

7. Lower the right angle end of the NVMe Gen5 cable into the cavity mentioned in the previous step and align it with the card edge connector contacts from the BCB. Press the right angle connector onto the BCB to make a secure connection.

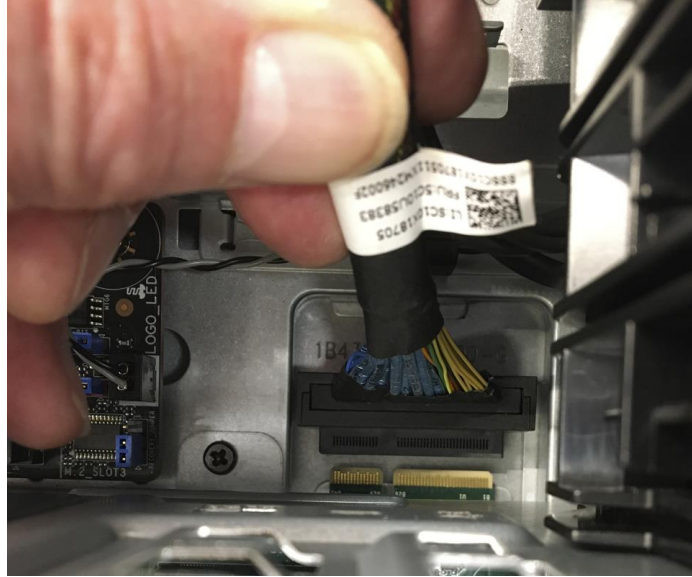

- 8. Route the other end of the NVMe Gen5 cable to the card edge connector on the system motherboard labeled “NVME STOR” and connect it securely, as shown in this picture:

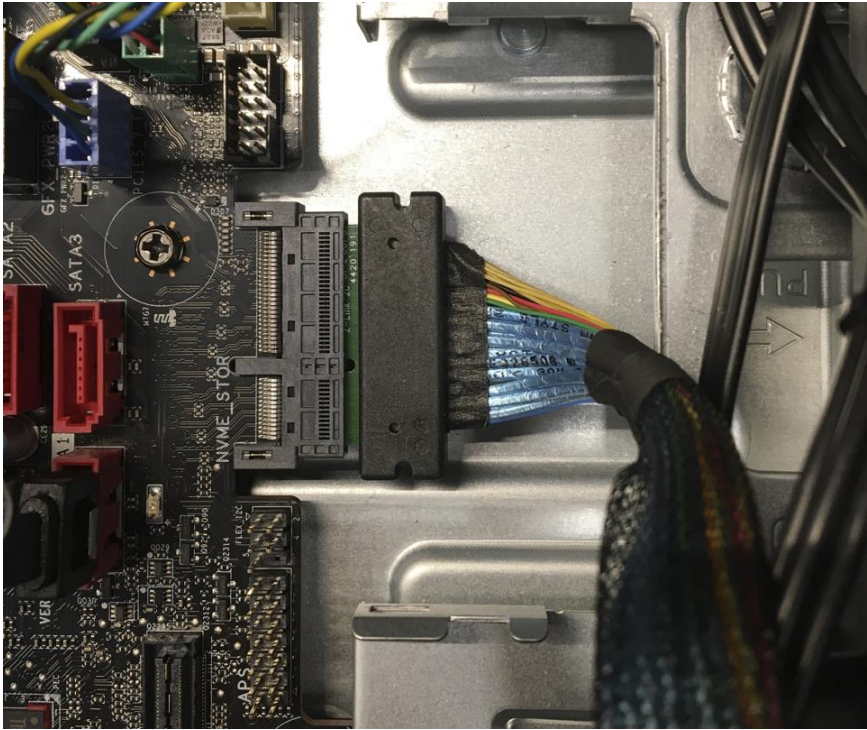

The completed routing of the NVMe Gen5 cable should look like this:

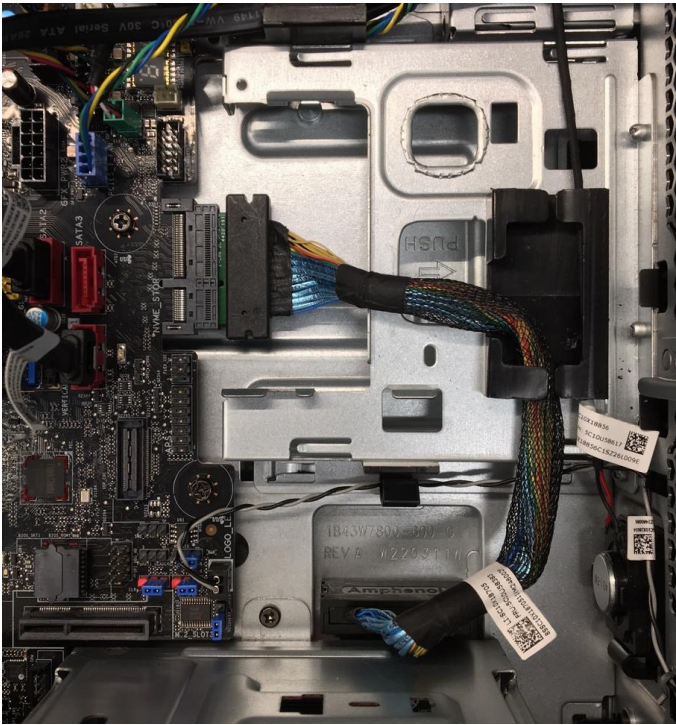

9. Now that the M.2 drive is inserted into the tray and the BCB is installed, you are ready to install the tray into the 3.5" drive bay. Rotate the tray cover up and slide the tray down into either 3.5" drive bay:

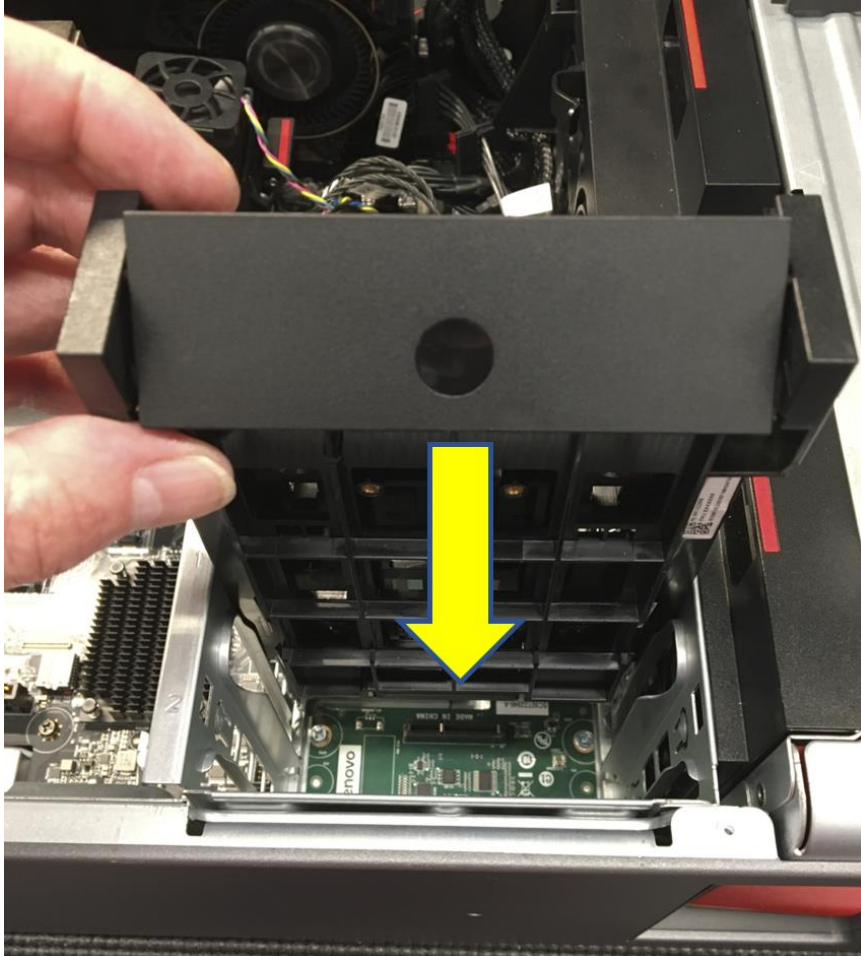

10. When the tray is fully inserted, rotate the cover down as shown to lock the tray into place:

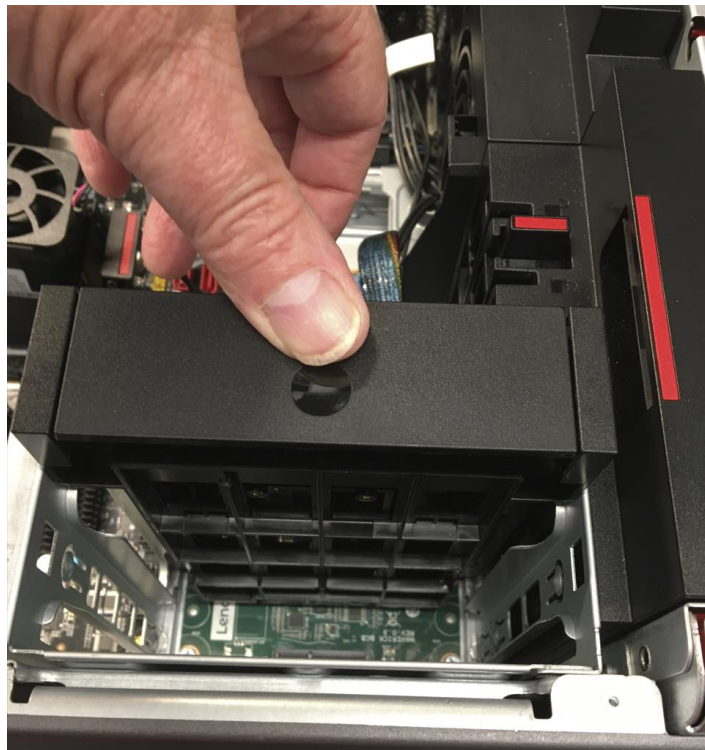
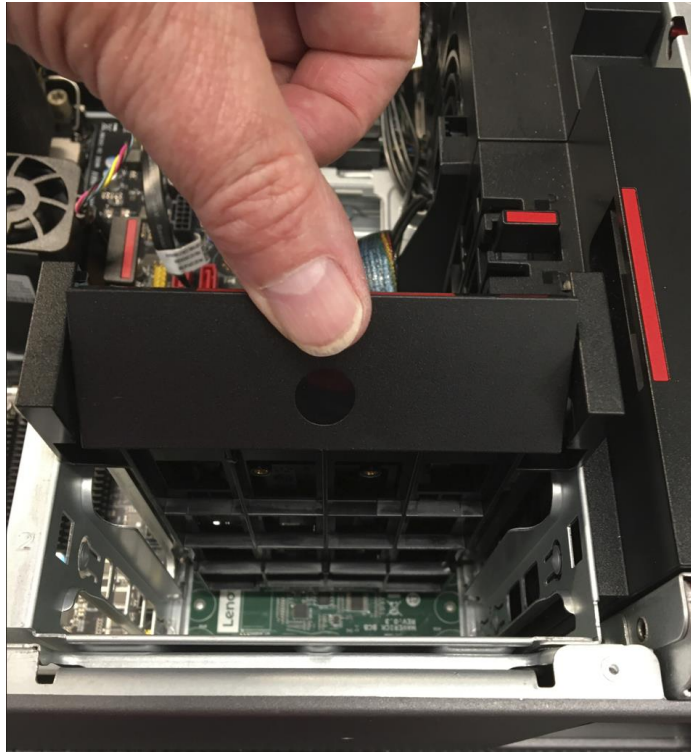

11. Here is a picture of both 3.5" drive bays being used for M.2 storage:

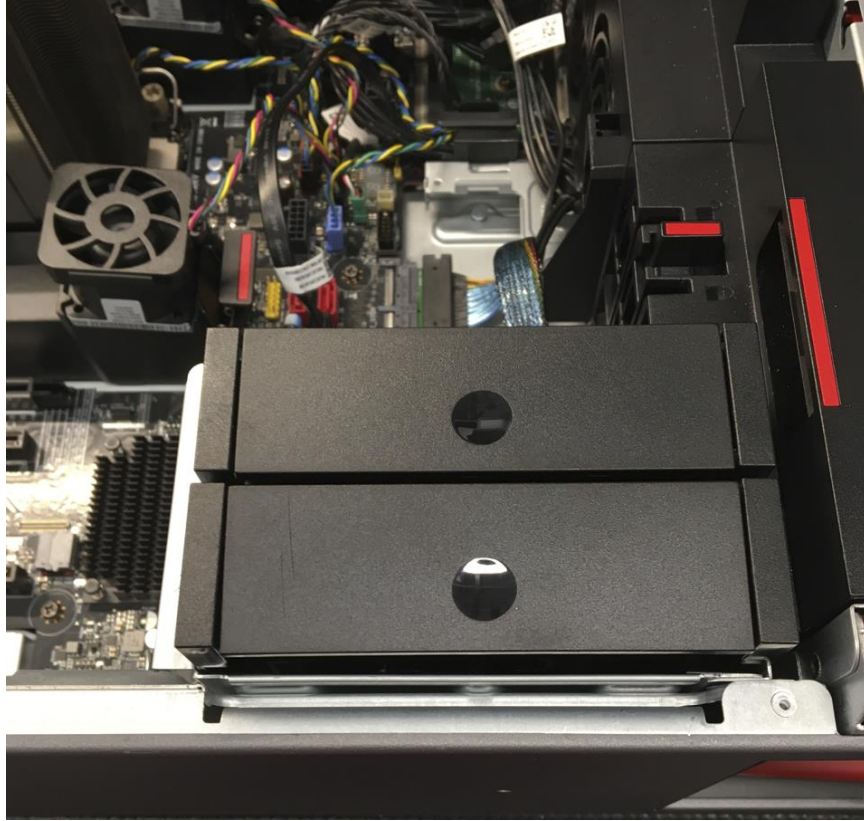

Quad M.2 Gen3 PCIe Add-In-Card (AIC) installation

It is possible to add up to four (4) additional M.2 drives to your P7 using an optional PCIe based Quad M.2 adapter card. See the Appendix at the end of this document for additional information and images of parts.

1. Slide the cover latches of the quad drive PCIe adapter to the open position. Then, pivot the cover as shown until it stops.

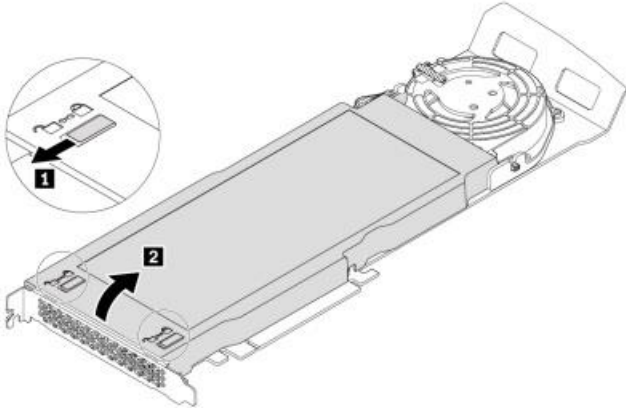

2. Loosen the screws that secure the M.2 NVMe drive heat sink. Then, remove the heat sink as shown.

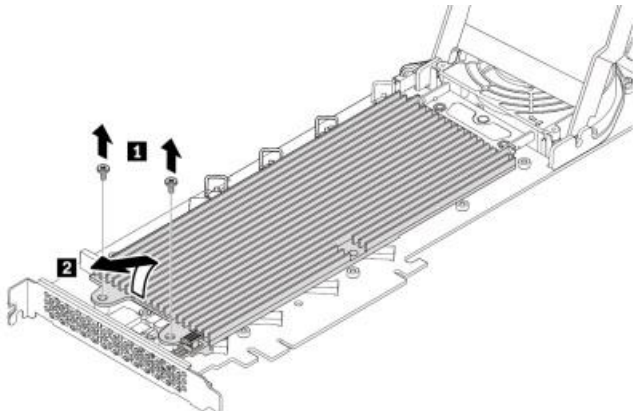

3. Install M.2 solid-state drives in the alphabetic order as shown.

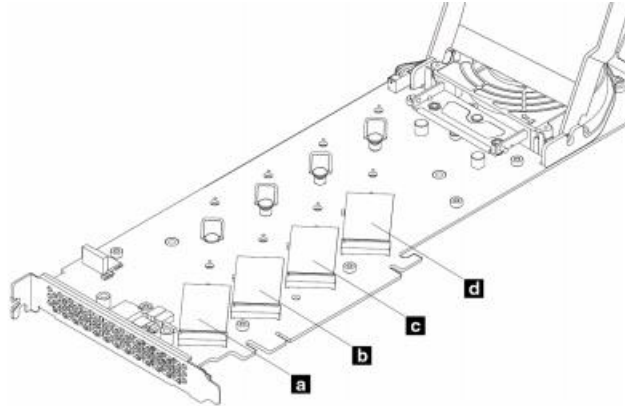

4. If necessary, move the retention latch to an appropriate location to suit the length of the new M.2 NVMe drive and remove any film on the thermal pads on which you want to install the M.2 NVMe drive.

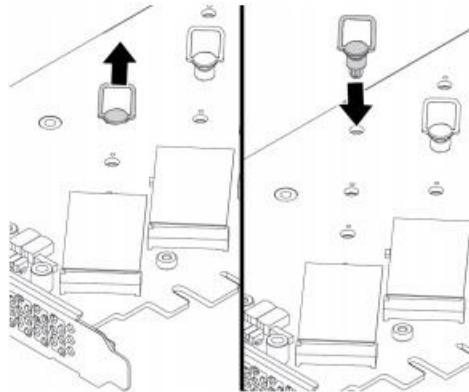

5. Pull the handle of the retention latch outward to the open position.

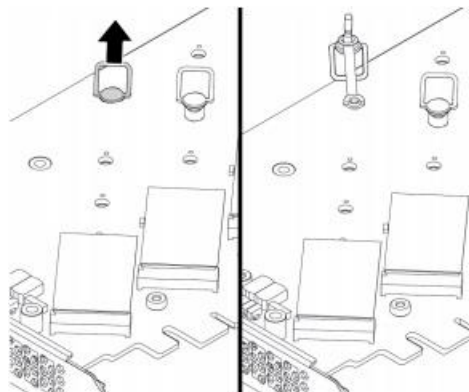

6. Hold the new drive by its edges so as not to touch the circuit board and ensure that the circuit board side is facing upward. Align the notch in the new M.2 NVMe drive with the slot key in the M.2 slot. Insert the drive into the corresponding slot on the PCIe adapter until it is firmly seated. Then, insert the plug of the retention latch into the hole to secure the new drive.

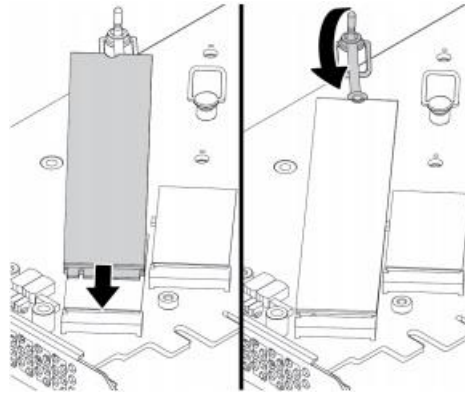

7. Install the heat sink as shown. Then tighten the screws to secure the heat sink.

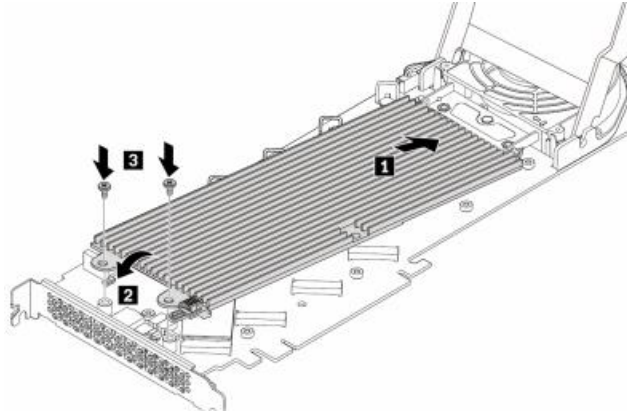

8. Install the cover as shown. Then, slide the cover latches to the locked position.

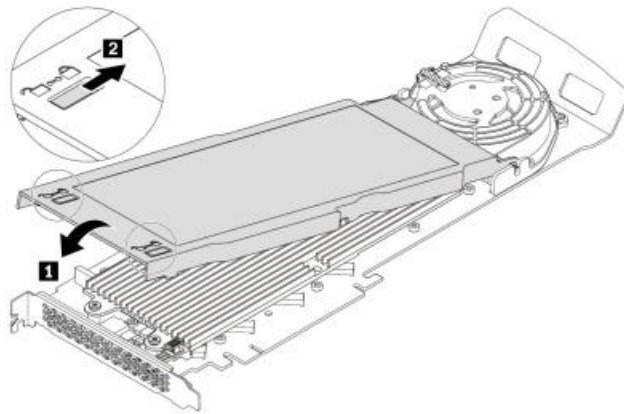

9. Install the M.2 NVMe drive PCIe adapter in a PCIe x16 card slot on the system board.

Note: Although the Quad Adapter supports multiple M.2 sizes, all of the Lenovo qualified drives are 2280 M.2 drives.

Section 3 – P7 SATA Hard Drive Details

The P7 platform supports a variety of different SATA hard drive storage options. The two tables below give details on the features, compatibility, and required parts for SATA hard drives. Installation location and information for each of the SATA hard drive options can be found in the subsequent pages.

Table 6 – SATA HDD features

Feature	Internal 3.5" bays (SATA)	3 rd HDD bay kit
Drive Count (System max = 3)	Up to 2	1
Drive size	3.5" only*	3.5" only
Maximum SATA speed	6Gb/s SATA3	6Gb/s SATA3
Availability	Standard	Optional
Location	Internal 3.5" bays	Bracket above CPU
Controller	PCH	PCH
Front accessible	No	No
Toolless	Yes	Yes
Hot swappable	No	No
Individual activity/status LED	No	No
Combined in system activity LED**	Yes	Yes

* The drive trays for the internal bays each have the ability to convert, without any additional parts, and hold a 2.5" drive. However, at the time of writing, only 3.5" drives have been certified by Lenovo on the P7.

** Refer to the photo below for the location of the front panel storage activity LED



Table 7 – SATA HDD compatibility and required parts

Location	Compatibility	Requirements and parts
Internal 3.5" bays (SATA)	Not compatible with internal 3.5" bays M.2 kit	<ul style="list-style-type: none"> • SATA 2-drop power cable included standard (supports both bays) • Standard SATA signal cable count <ul style="list-style-type: none"> · 0 drives configured: one cable · 1-2 drives configured: two cables
3rd HDD bay kit		<i>Optional HDD kit (includes cables)</i>

Note: Microsoft Windows 11 does not support booting from magnetic rotational media.

Internal 3.5" SATA drive installation

All P7 models have two standard 3.5" SATA HDD bays, which are located in the lower front corner of the chassis, as shown here (populated with HDDs):

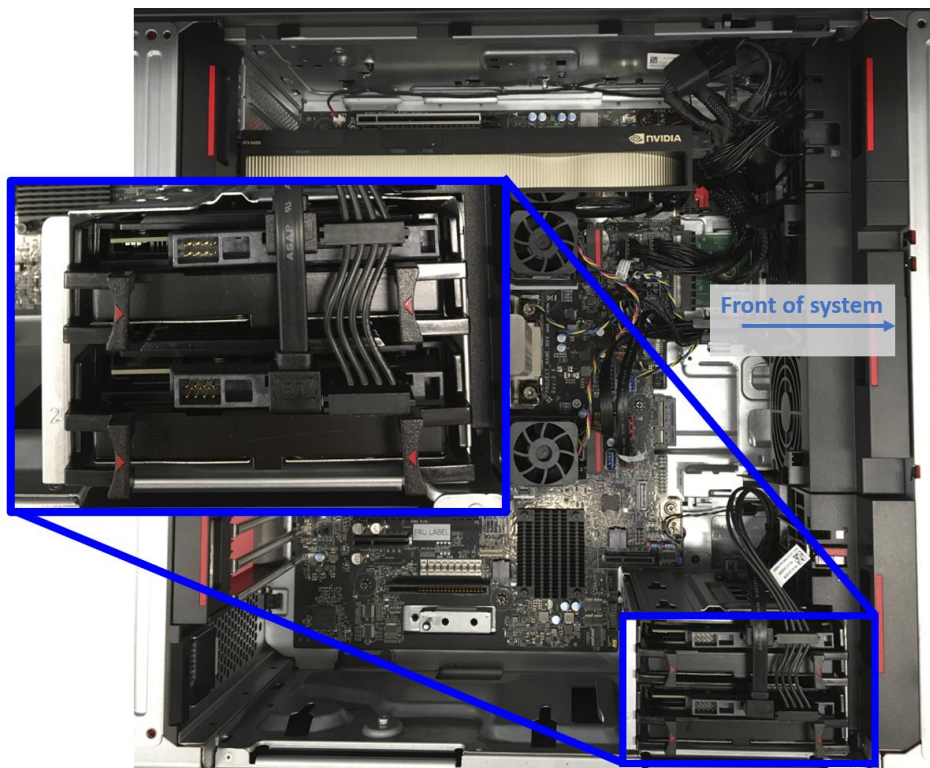

1. Pinch the arrowed tabs and pull the drive tray out of the system. Note: this picture shows the drive bays from P5, but the tray removal process is identical for P7.



2. Insert the drive, bottom down, into the tray with the signal and power connections on the same end as the arrowed tabs. Angle the side of the drive down into the tray and line up the holes on the side of the drive with the posts on the inside of the tray then insert the posts.

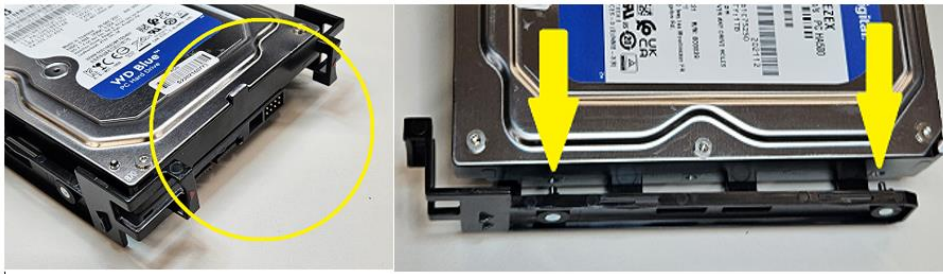

3. Gently twist the open side of the tray downward until the posts on the tray clear the side of the drive. Release the side of the tray to insert the posts into the holes on the side of the drive.



4. Install the drive/tray assembly by fitting the tray into the channels of either of the 3.5" bays. Slide the assembly down until you hear it latch into place.

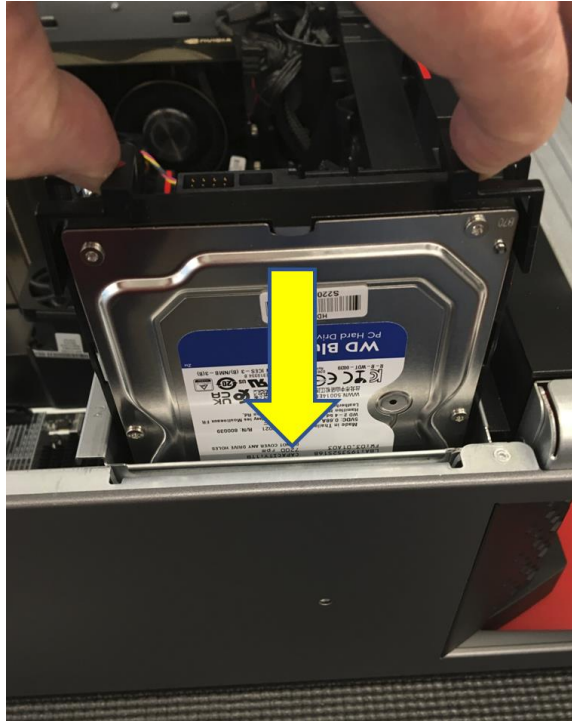

5. Connect the SATA power and data cables as shown in the following photo. One dual drop SATA power cable and one single drop SATA data cable are installed as standard parts in every P7. If you are installing a second 3.5" HDD, you can route the cable to the SATA ports on the motherboard along the same path that the installed power & data cables follow.

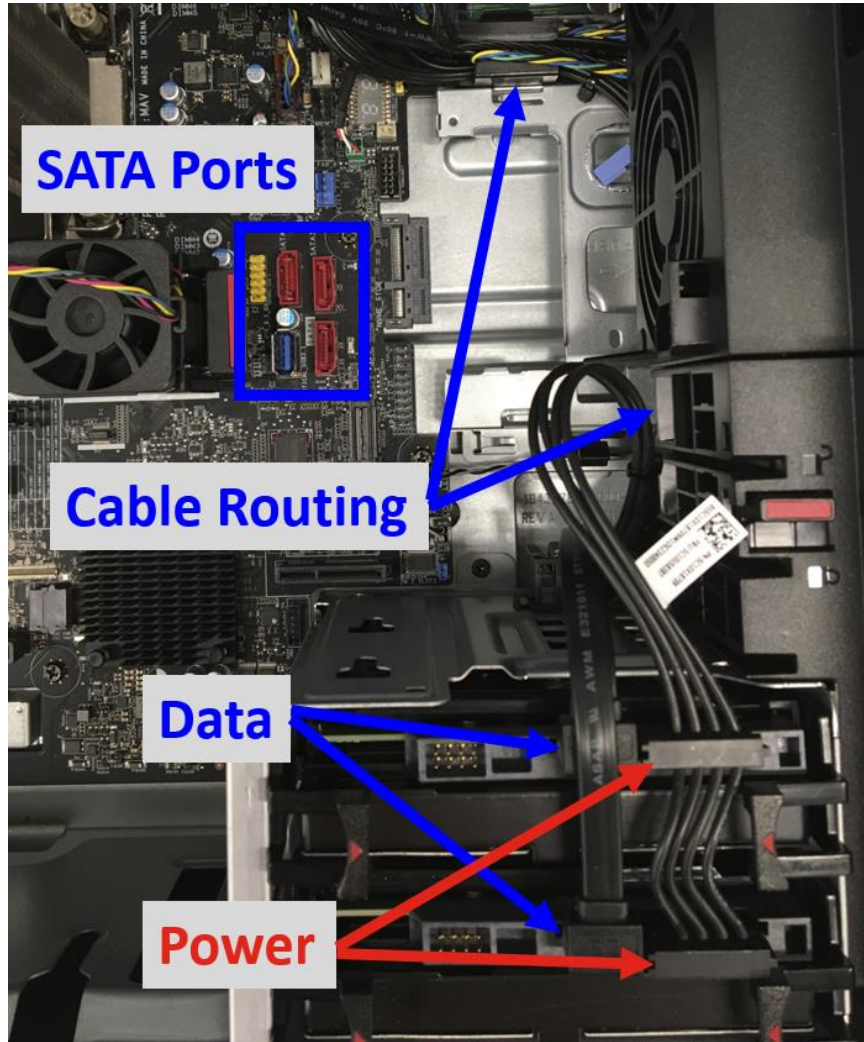

6. Plug the SATA data cables into SATA ports 1 and/or 2. The overall location of the SATA ports is shown on the previous photo is zoomed in on here:

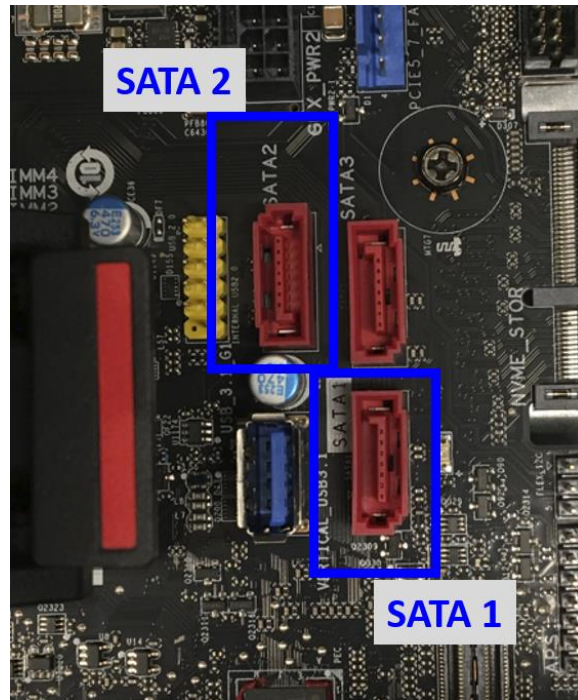

3rd HDD bay kit installation

An optional 3rd 3.5" HDD can be installed in a tray that mounts above the CPU cooling duct, as shown here:

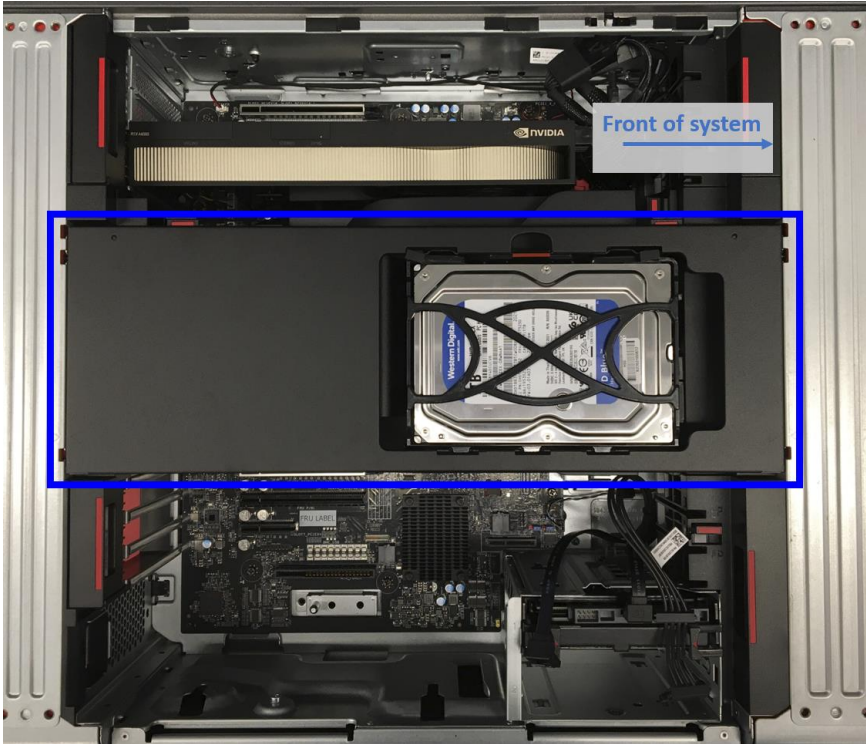

1. The 3rd HDD bay kit consists of the tray, drive carrier, and SATA cables, as shown here:

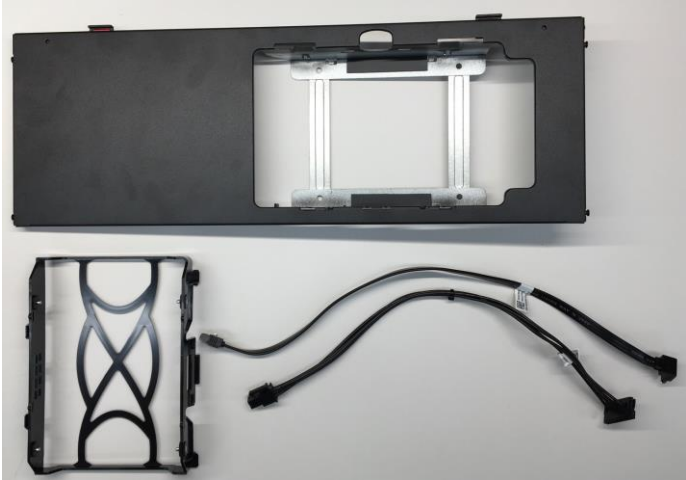

2. Before installing the tray and drive carrier, remove the CPU cooling duct and connect the SATA power and data cables to the C6 (Internal Bay

Power 2) and C17 (SATA 3) motherboard connectors that are shown on the side cover motherboard connector diagram.

3. Reinstall the cooling duct and route the cables through the cable management clip and then the slot at the front of the chassis.

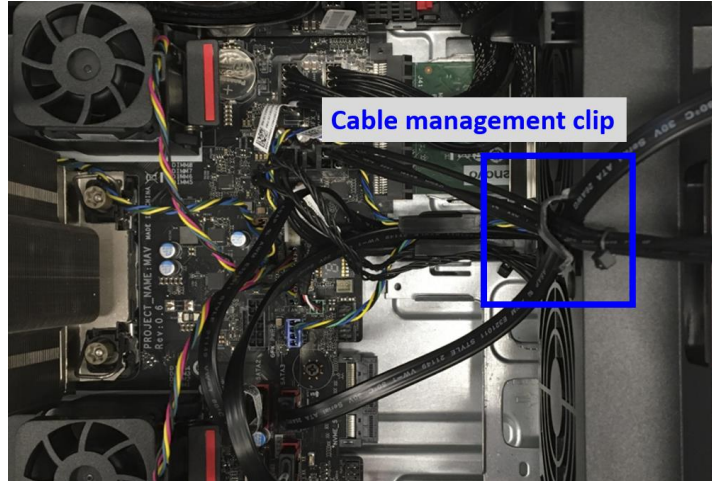

4. The tray has four mounting posts that mount into slots on the chassis.

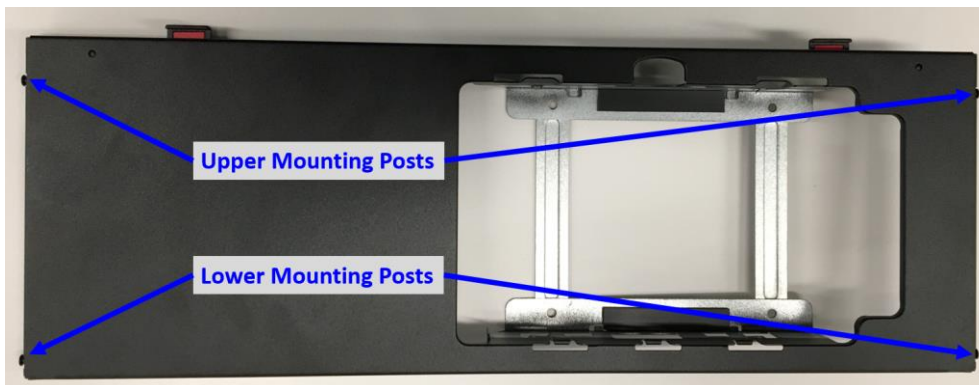

5. Insert the lower mounting posts into the lower slots. Then, using the lower posts as a pivot point, rotate the top of the tray down until the upper posts latch into place in the corresponding slots on the chassis.

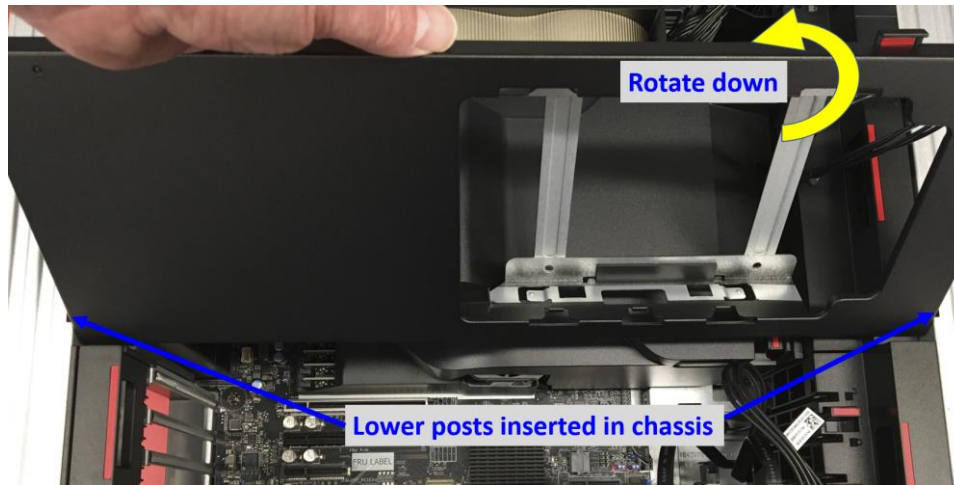

6. The 3rd HDD needs to be installed in a special drive carrier before being mounted in the system. Set the drive carrier on a flat surface, upside down, as seen in the below image. Note the position of the red handle.



7. Align the drive, upside down, so that the signal and power plugs are on the end of the carrier as seen in the below image.



8. Line up the holes on the side of the drive with the posts on the inside of the carrier and insert the posts into the holes.



9. Gently bend the open side of the carrier outward, until the posts on the carrier can clear the side of the drive. Then insert the posts into the holes on the side of the drive.

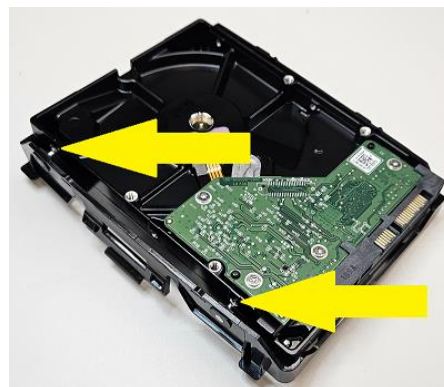

10. Align the tabs on the side of the drive carrier with the notches on the inside of the tray and insert the tabs. Lower the carrier side with the red handle down into the tray and press on the red handle until it clicks into place.

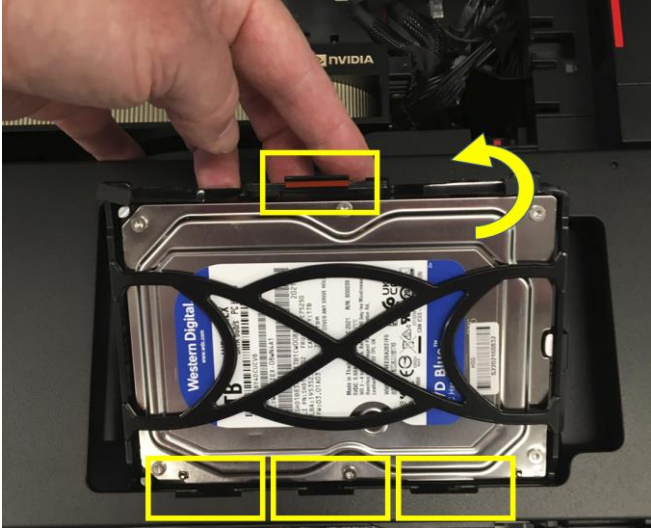

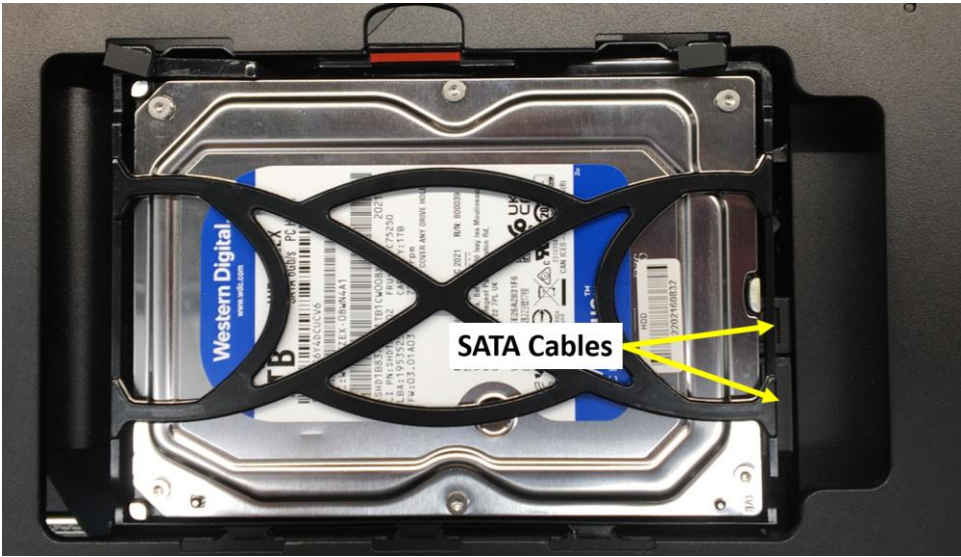

11. Plug the SATA power and data cables into the drive:

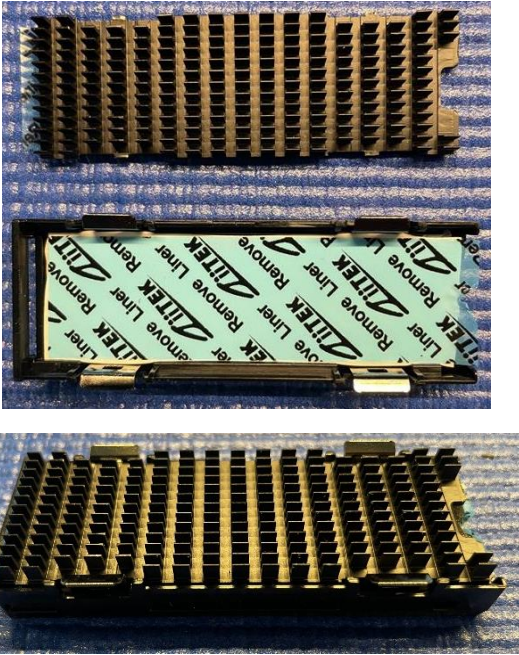

Section 4 – Appendix

The ThinkStation P7 platform contains all new mechanical parts for different storage device options. Here are some pictures representing a few of these parts.

Part	Picture
Onboard M.2 Carrier + Heatsink	
M.2 Vertical holders for OB 3rd M.2 SSD FRU: 5M11C16897	

Internal tray for M.2 SSD
FRU: 5M11C16906

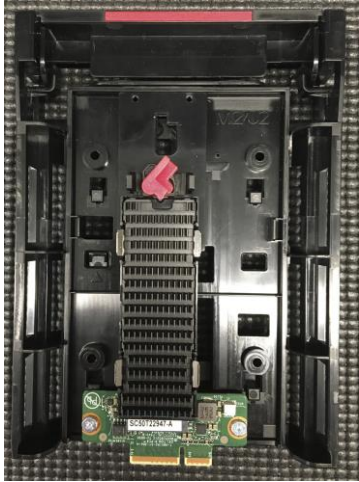

BCB for internal NVME drives
FRU: 5C51K23022



84-pin NVME Gen5 cable
FRU: 5C10U58383



Revision History

Version	Date	Author	Changes/Updates
1.0	6/7/2023	Jim P	Initial Version