

# Poly CCX 400 Business Media Phone

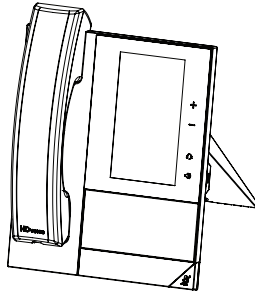

---

## Package Contents

CCX 400

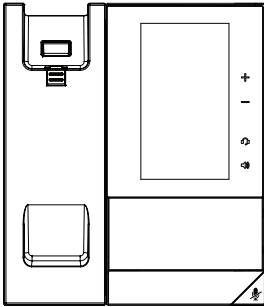

Handset

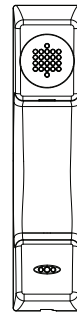

Stand

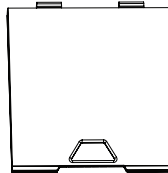

Setup Sheet



Handset Cord

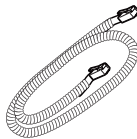

Network Cable

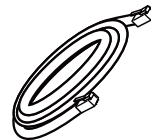

---

## Optional Accessories

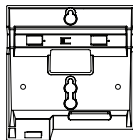
AC Power Adapter  
(varies by region)

Wallmount

# Features

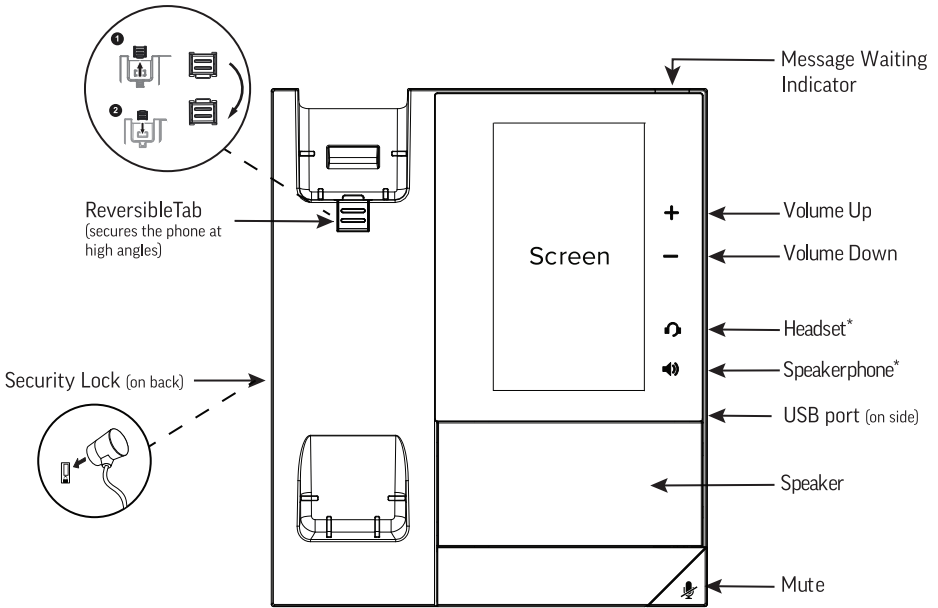

\* Icon displays when the phone is powered on.

## Connect Desktop Stand

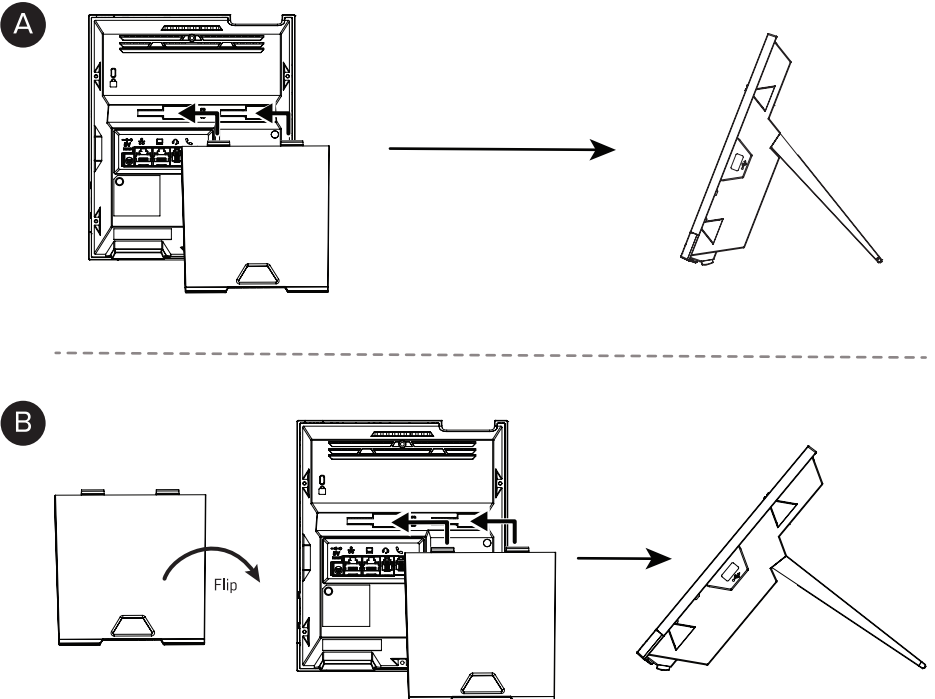

# Connect Cables

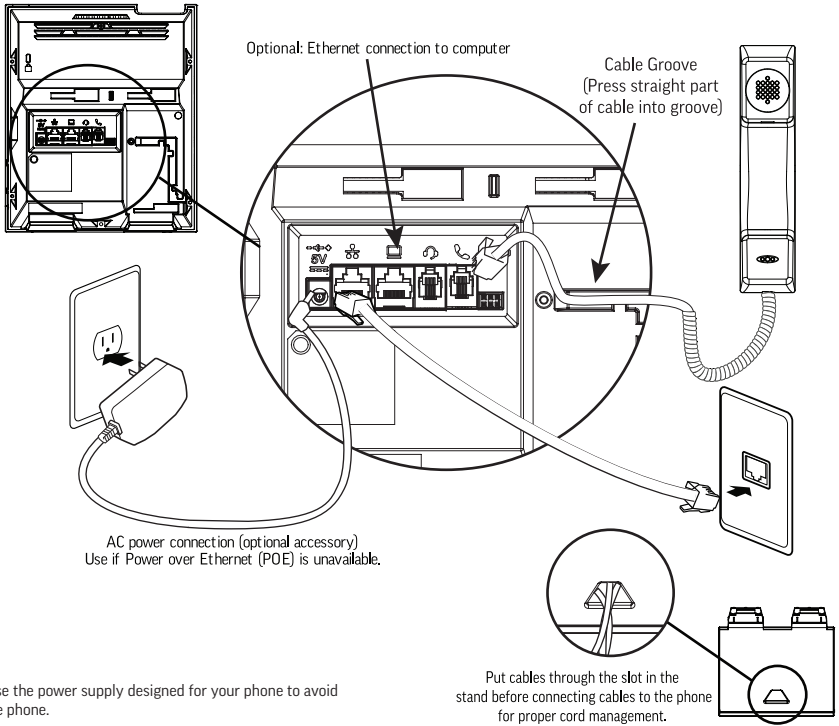

# Connect Optional Headset

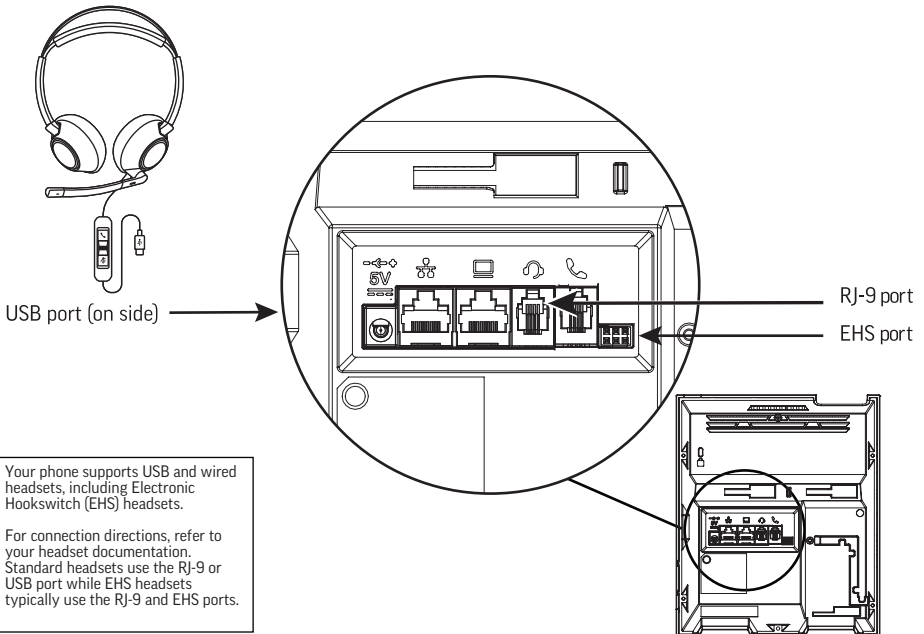



HP Inc UK Ltd, Regulatory Enquiries, Earley West, 300 Thames Valley Park Drive, Reading, RG6 1PT

HP REG 23010, 08028 Barcelona, Spain

**ENERGY STAR®:**



Backlight intensity and timeout can be adjusted in basic user settings menu. By default, after the phone is idle for 40 seconds, the backlight dims. The backlight automatically turns on with any phone activity.

 [support.hp.com/poly](https://support.hp.com/poly)

Poly CCX 400 



Translations of this Setup Sheet are available at [support.hp.com/poly](https://support.hp.com/poly).

انڈیا ۛر وکڈڈم لہا تاغل لہ لہ ص ف ن م تاد ن ت س م ی ف ی ل ل ا ل ا تاد ن ت س م ل ہ ا ۛ م ج ر ت م ت س . ar

de Übersetzungen dieser Einrichtungsanleitung sind unter [support.hp.com/poly](https://support.hp.com/poly) verfügbar.

es Las traducciones de esta guía de instalación están disponibles en [support.hp.com/poly](https://support.hp.com/poly). fr Des traductions de

cette Fiche de configuration sont disponibles à l'adresse [support.hp.com/poly](https://support.hp.com/poly).

he .support.hp.com/poly תרגומים של גיליון ההתקנה זמינים בכתובת

id Terjemahan Lembar Penyetelan ini tersedia di [support.hp.com/poly](https://support.hp.com/poly).

it Le traduzioni di questo foglio di installazione sono disponibili all'indirizzo [support.hp.com/poly](https://support.hp.com/poly).

ja このセットアップシートの各国語版は、[support.hp.com/poly](https://support.hp.com/poly) から入手できます。

ko 이 설치 안내서의 번역본은 [support.hp.com/poly](https://support.hp.com/poly)에서 확인할 수 있습니다.

ku .support.hp.com/poly وه رگێزان بۆ ئەم پەڕەی زینکۆستنه بهردهسته له

pt As traduções desta Folha de configuração estão disponíveis no site [support.hp.com/poly](https://support.hp.com/poly).

ru Переводы этой монтажной схемы доступны по адресу: [support.hp.com/poly](https://support.hp.com/poly).

sr Prevodi ovog priručnika za podešavanje dostupni su na [support.hp.com/poly](https://support.hp.com/poly).

tr Bu Kurulum Sayfasının çevirileri [support.hp.com/poly](https://support.hp.com/poly) adresinde mevcuttur.

zh-cn 此安装说明书的翻译版本见 [support.hp.com/poly](https://support.hp.com/poly)。

zh-tw 此安裝說明書的翻譯版本可在 [support.hp.com/poly](https://support.hp.com/poly) 取得。

**Contact Information:**

Contact your authorized reseller for assistance.

[www.hp.com](http://www.hp.com)

HP Inc., 1501 Page Mill Road, Palo Alto, CA 94304

