

# Lenovo 13w Yoga Gen 2 Hardware Maintenance Manual

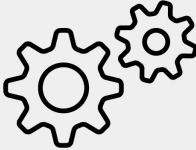

**First Edition (February 2023)**

**© Copyright Lenovo 2023.**

LIMITED AND RESTRICTED RIGHTS NOTICE: If data or software is delivered pursuant to a General Services Administration "GSA" contract, use, reproduction, or disclosure is subject to restrictions set forth in Contract No. GS-35F-05925.

---

# Contents

## About this manual . . . . . iii

## Chapter 1. Safety information . . . . . 1

General safety . . . . .	1
Electrical safety . . . . .	1
Safety inspection guide . . . . .	3
Handling devices that are sensitive to electrostatic discharge . . . . .	3
Grounding requirements . . . . .	4
Safety notices (multilingual translations) . . . . .	4

## Chapter 2. General checkout . . . . . 19

What to do first . . . . .	19
Checking the ac power adapter . . . . .	20
Checking the battery and operational charging . . . . .	20

## Chapter 3. Locations . . . . . 23

Locating computer controls and connectors . . . . .	23
Front view . . . . .	23
Side view . . . . .	25
Locating FRUs and CRUs . . . . .	26
Major FRUs and CRUs . . . . .	27
LCD FRUs and CRUs . . . . .	29
Miscellaneous parts . . . . .	30
Looking up FRU information . . . . .	30

## Chapter 4. FRU replacement notices . . . . . 31

Service tool kit . . . . .	31
Screw notices . . . . .	31

## Chapter 5. Removing or replacing a FRU. . . . . 33

General guidelines . . . . .	33
Before servicing the computer . . . . .	33
Disable Fast Startup and the built-in battery . . . . .	33
Removing the nano-SIM-card and nano-SIM-card tray (for selected models) . . . . .	34

Removing the SD card . . . . .	34
Removing the pen dummy (for selected models) . . . . .	34
1010 Base cover assembly . . . . .	35
1020 M.2 2242 solid-state drive . . . . .	36
1030 Wireless WAN card (for selected models) . . . . .	37
1040 Coin-cell battery . . . . .	38
1050 Memory module . . . . .	38
1060 Wireless LAN card . . . . .	39
1070 Heat sink . . . . .	40
1080 Rear camera and microphone module, bracket, and cable (for selected models) . . . . .	41
1090 Thermal fan . . . . .	42
1100 Built-in battery . . . . .	43
1110 P-sensor cable (for selected models) . . . . .	44
1120 Lenovo Integrated Pen charge board and cable (for selected models) . . . . .	45
1130 I/O brackets . . . . .	46
1140 System board . . . . .	46
1150 Power button with or without fingerprint reader . . . . .	48
1160 Speaker assembly . . . . .	49
1170 Trackpad and trackpad cable . . . . .	50
1180 LCD unit . . . . .	52
1190 Keyboard assembly . . . . .	53
2010 LCD strip cover. . . . .	54
2020 Touch module assembly . . . . .	54
2030 LCD cable. . . . .	56
2040 LCD hinges . . . . .	56
2050 Camera and microphone module with microphone rubbers . . . . .	57
2060 Gravity sensor board and camera cable . . . . .	58
2070 LCD cover assembly. . . . .	59

## Appendix A. Notices. . . . . 61

## Appendix B. Abbreviation table . . . . . 63



---

## About this manual

This manual contains service and reference information for the following products:

Product name	Machine type (MT)
Lenovo 13w Yoga Gen 2	82YR and 82YS

Use this manual along with the advanced diagnostic tests to troubleshoot problems.

### Important:

- This manual is intended only for trained service technicians who are familiar with products. Use this manual along with the advanced diagnostic tests to troubleshoot problems effectively.
- Depending on the model, some hardware configuration and software programs might not be available on the computer. Some statements in this manual might not be applicable to the computer.
- Before servicing a product, be sure to read all the information under Chapter 1 “Safety information” on page 1.



---

## Chapter 1. Safety information

This chapter presents following safety information that you need to be familiar with before you service a notebook computer.

- “General safety” on page 1
- “Electrical safety” on page 1
- “Safety inspection guide” on page 3
- “Handling devices that are sensitive to electrostatic discharge” on page 3
- “Grounding requirements” on page 4
- “Safety notices (multilingual translations)” on page 4

---

### General safety

Follow these rules to ensure general safety:

- Observe good housekeeping in the area of the machines during and after maintenance.
- When lifting any heavy object:
  1. Ensure that you can stand safely without slipping.
  2. Distribute the weight of the object equally between your feet.
  3. Use a slow lifting force. Never move suddenly or twist when you attempt to lift.
  4. Lift by standing or by pushing up with your leg muscles; this action removes the strain from the muscles in your back. Do not attempt to lift any object that weighs more than 16 kg (35 lb) or that you think is too heavy for you.
- Do not perform any action that causes hazards to the customer, or that makes the equipment unsafe.
- Before you start the machine, ensure that other service technicians and the customer's personnel are not in a hazardous position.
- Place removed covers and other parts in a safe place, away from all personnel, while you are servicing the machine.
- Keep your tool case away from walk areas so that other people will not trip over it.
- Do not wear loose clothing that can be trapped in the moving parts of a machine. Ensure that your sleeves are fastened or rolled up above your elbows. If your hair is long, fasten it.
- Insert the ends of your necktie or scarf inside clothing or fasten it with a nonconductive clip, about 8 centimeters (3 inches) from the end.
- Do not wear jewelry, chains, metal-frame eyeglasses, or metal fasteners for your clothing, because metal objects are good electrical conductors.
- Wear safety glasses when you are hammering, drilling, soldering, cutting wire, attaching springs, using solvents, or working in any other conditions that might be hazardous to your eyes.
- After service, reinstall all safety shields, guards, labels, and ground wires. Replace any safety device that is worn or defective.
- Reinstall all covers correctly before returning the machine to the customer.
- Fan louvers on the machine help to prevent overheating of internal components. Do not obstruct fan louvers or cover them with labels or stickers.

---

### Electrical safety

Observe the following rules when working on electrical equipment.

**Important:**

- Use only approved tools and test equipment. Some hand tools have handles covered with a soft material that does not insulate you when working with live electrical currents.
- Many customers have, near their equipment, rubber floor mats that contain small conductive fibers to decrease electrostatic discharges (ESD). Do not use this type of mat to protect yourself from electrical shock.
- Find the room emergency power-off (EPO) switch, disconnecting switch, or electrical outlet. If an electrical accident occurs, you can then operate the switch or unplug the power cord quickly.
- Do not work alone under hazardous conditions or near equipment that has hazardous voltages.
- Disconnect all power before:
  - Performing a mechanical inspection
  - Working near power supplies
  - Removing or installing main units
- Before you start to work on the machine, unplug the power cord. If you cannot unplug it, ask the customer to power off the wall box that supplies power to the machine, and to lock the wall box in the off position.
- If you need to work on a machine that has exposed electrical circuits, observe the following precautions:
  - Ensure that another person, familiar with the power-off controls, is near you. That person must be there to switch off the power, if necessary.
  - Use only one hand when working with powered-on electrical equipment; keep the other hand in your pocket or behind your back.

**CAUTION:**

**An electrical shock can occur only when there is a complete circuit. By observing the above rule, you may prevent a current from passing through your body.**

- When using testers, set the controls correctly and use the approved probe leads and accessories for that tester.
- Stand on suitable rubber mats (obtained locally, if necessary) to insulate you from grounds such as metal floor strips and machine frames.

Observe the special safety precautions when you work with very high voltages. Instructions for these precautions are in the safety sections of maintenance information. Use extreme care when measuring high voltages.

- Regularly inspect and maintain your electrical hand tools for safe operational condition.
- Do not use worn or broken tools and testers.
- Never assume that power has been disconnected from a circuit. First, check that it has been powered off.
- Always look carefully for possible hazards in your work area. Examples of these hazards are moist floors, nongrounded power extension cables, power surges, and missing safety grounds.
- Do not touch live electrical circuits with the reflective surface of a plastic dental mirror. The surface is conductive; such touching can cause personal injury and machine damage.
- Do not service the following parts with the power on:
  - Power supply units
  - Fans
  - Units similar to those listed above

This practice ensures correct grounding of the units.

- If an electrical accident occurs:
  - Use caution; do not become a victim yourself.
  - Switch off power.
  - Send another person to get medical aid.



---

## Safety inspection guide

The purpose of this inspection guide is to assist you in identifying potentially unsafe conditions. As each machine was designed and built, required safety items were installed to protect users and service technicians from injury. This guide addresses only those items. You should use good judgment to identify potential safety hazards due to attachment of non-Lenovo features or options not covered by this inspection guide.

If any unsafe conditions are present, you must determine how serious the apparent hazard could be and whether you can continue without first correcting the problem.

Consider these conditions and the safety hazards they present:

- Electrical hazards, especially primary power (primary voltage on the frame can cause serious or fatal electrical shock)
- Explosive hazards, such as a damaged CRT face or a bulging capacitor
- Mechanical hazards, such as loose or missing hardware

To determine whether there are any potentially unsafe conditions, use the following checklist at the beginning of every service task. Begin the checks with the power off, and the power cord disconnected.

Checklist:

1. Check exterior covers for damage (loose, broken, or sharp edges).
2. Turn off the computer. Disconnect the power cord.
3. Check the power cord for:
  - a. A third-wire ground connector in good condition. Use a meter to measure third-wire ground continuity for 0.1 ohm or less between the external ground pin and the frame ground.
  - b. The power cord should be the authorized type specified for your computer. Go to: <https://support.lenovo.com/partslookup>.
  - c. Insulation must not be frayed or worn.
4. Check for cracked or bulging batteries.
5. Remove the cover.
6. Check for any obvious non-Lenovo alterations. Use good judgment as to the safety of any non-Lenovo alterations.
7. Check inside the unit for any obvious unsafe conditions, such as metal filings, contamination, water or other liquids, or signs of fire or smoke damage.
8. Check for worn, frayed, or pinched cables.
9. Check that the power-supply cover fasteners (screws or rivets) have not been removed or tampered with.

---

## Handling devices that are sensitive to electrostatic discharge

Any computer part containing transistors or integrated circuits (ICs) should be considered sensitive to electrostatic discharge (ESD). ESD damage can occur when there is a difference in charge between objects. Protect against ESD damage by equalizing the charge so that the machine, the part, the work mat, and the person handling the part are all at the same charge.

**Notes:**

1. Use product-specific ESD procedures when they exceed the requirements noted here.

2. Ensure that the ESD protective devices you use have been certified (ISO 9000) as fully effective.

When handling ESD-sensitive parts:

- Keep the parts in protective packages until they are inserted into the product.
- Avoid contact with other people.
- Wear a grounded wrist strap against your skin to eliminate static on your body.
- Prevent the part from touching your clothing. Most clothing is insulative and retains a charge even when you are wearing a wrist strap.
- Use a grounded work mat to provide a static-free work surface. The mat is especially useful when handling ESD-sensitive devices.
- Select a grounding system, such as those listed below, to provide protection that meets the specific service requirement.

**Note:** The use of a grounding system to guard against ESD damage is desirable but not necessary.

- Attach the ESD ground clip to any frame ground, ground braid, or green-wire ground.
- When working on a double-insulated or battery-operated system, use an ESD common ground or reference point. You can use coax or connector-outside shells on these systems.
- Use the round ground prong of the ac plug on ac-operated computers.

---

## Grounding requirements

Electrical grounding of the computer is required for operator safety and correct system function. Proper grounding of the electrical outlet can be verified by a certified electrician.

---

## Safety notices (multilingual translations)

The safety notices in this section are provided in the following languages:

- English
- Arabic
- Brazilian Portuguese
- French
- German
- Hebrew
- Japanese
- Korean
- Spanish
- Traditional Chinese



**Before the computer is powered on after FRU replacement, make sure that all screws, springs, and other small parts are in place and are not left loose inside the computer. Verify this by shaking the computer and listening for rattling sounds. Metallic parts or metal flakes can cause electrical short circuits.**

### DANGER



Some standby batteries contain a small amount of nickel and cadmium. Do not disassemble a standby battery, recharge it, throw it into fire or water, or short-circuit it. Dispose of the battery as required by local ordinances or regulations. Use only the battery in the appropriate parts listing. Use of an incorrect battery can result in ignition or explosion of the battery.

**DANGER**



The battery pack contains small amounts of nickel. Do not disassemble it, throw it into fire or water, or short-circuit it. Dispose of the battery pack as required by local ordinances or regulations. Use only the battery in the appropriate parts listing when replacing the battery pack. Use of an incorrect battery can result in ignition or explosion of the battery.

**DANGER**



The lithium battery can cause a fire, an explosion, or a severe burn. Do not recharge it, remove its polarized connector, disassemble it, heat it above 100°C (212°F), incinerate it, or expose its cell contents to water. Dispose of the battery as required by local ordinances or regulations. Use only the battery in the appropriate parts listing. Use of an incorrect battery can result in ignition or explosion of the battery.

**DANGER**



If the LCD breaks and the fluid from inside the LCD gets into your eyes or on your hands, immediately wash the affected areas with water for at least 15 minutes. Seek medical care if any symptoms from the fluid are present after washing.

**DANGER**



To avoid shock, do not remove the plastic cover that protects the lower part of the inverter card.

**DANGER**



Though the main batteries have low voltage, a short-circuited or grounded battery can produce enough current to burn personnel or combustible materials.

**DANGER**



Unless hot swap is allowed for the FRU being replaced, do as follows before removing it: power off the computer, unplug all power cords from electrical outlets, remove the battery pack, and disconnect any interconnecting cables.

## DANGER



خطر

قبل اعادة تشغيل الحاسب بعد الانتهاء من استبدال FRU، تأكد من أنه قد تم اعادة كل من المسامير و السوست وكل الأجزاء الصغيرة الأخرى في أماكنهم ولم يتم فقدهم داخل الحاسب. ويمكن التحقق من ذلك عن طريق هز الحاسب والاستماع لأي صوت صاخب يصدر منه. قد تؤدي الأجزاء أو الرقائق المعدنية الى حدوث دائرة قصر.



خطر

تحتوي بعض البطاريات الاحتياطية على كمية صغيرة من مادتي النيكل والكادميوم. لا تقم بفك أو اعادة شحن البطارية الاحتياطية ولا تقم أيضا بالقائها في النار أو الماء ولا تتسبب في احداث دائرة قصر بها. قم بالتخلص من البطارية كما هو موضح في القوانين المحلية. استخدم نوع البطارية المحدد والذي يوصى باستخدامه. حيث أنه قد يؤدي استخدام نوع بطارية غير صحيح الى اشتعالها أو انفجارها.



خطر

تحتوي حزمة البطارية على كمية صغيرة من مادة النيكل. لا تقم بفكها أو القاءها في النار أو الماء ولا تتسبب في احداث دائرة قصر بها. تخلص من حزمة البطارية وفقا لما هو موضح في القوانين المحلية. قم، عند استبدال حزمة البطارية، باستخدام الأنواع المحددة فقط والتي يوصى باستخدامها. حيث أنه قد يؤدي استخدام نوع بطارية غير صحيح الى اشتعالها أو انفجارها.



خطر

قد تتسبب بطارية الليثيوم في حدوث حريق أو انفجار أو حدوث حروق شديدة. لا تقم بإعادة شحن البطارية أو ازالة موصل الاستقطاب الخاص بها ولا تحاول أيضا فكها أو تسخينها لأكثر من ١٠٠ درجة مئوية (٢١٢١ فهرنهايت) أو حرقها أو تعريض محتويات الخانة الخاصة بها للماء. قم بالتخلص من البطارية وفقا لما هو موضح في القوانين المحلية. استخدم نوع البطارية المحدد والذي يوصى باستخدامه. حيث أنه قد يؤدي استخدام نوع بطارية غير صحيح الى اشتعالها أو انفجارها.



خطر

إذا ما انكسرت شاشة LCD ولامس السائل الداخلي عينيك أو يديك، قم في الحال بغسلهما بالماء لمدة لا تقل عن ١٥ دقيقة. إذا ما وجدت أي أعراض بعد الغسل اطلب عندئذ المساعدة الطبية.



خطر

لتجنب التعرض لأي صدمات، لا تقم بإزالة الغطاء البلاستيكي الذي يحمي الجزء الأسفل من بطاقة العاكس.



خطر

على الرغم من أن البطاريات الرئيسية يكون لها جهد منخفض، إلا أنه قد تقوم البطاريات التي حدث قصور بها أو التي تم توصيلها أرضيا بإصدار تيار يكفي لحدوث حروق للأفراد أو تعرض المواد القابلة للاشتعال للحريق.



خطر

ما لم يتم السماح بالتبديل الفوري لأي FRU الجاري استبداله بدون ضرورة اغلاق النظام، قم بتنفيذ ما يلي قبل ازالته. قم بإيقاف تشغيل الحاسب ونزع كل أسلاك الطاقة من المخارج الكهربائية وقم أيضا بإزالة حزمة البطارية ثم قم بفصل أي كابلات متصلة.



## PERIGO

Antes de ligar o computador após a substituição da FRU, certifique-se de que todos os parafusos, molas e outras peças pequenas estejam no lugar e não estejam soltos dentro do computador. Verifique isso sacudindo o computador e procurando ouvir sons de peças soltas. Peças metálicas ou lascas de metal podem causar curto-circuito.



## PERIGO

Algumas baterias reserva contêm uma pequena quantidade de níquel e cádmio. Não desmonte uma bateria reserva, recarregue-a, jogue-a no fogo ou na água, ou deixe-a entrar em curto-circuito. Descarte a bateria conforme requerido pelas leis ou regulamentos locais. Use somente a bateria nas partes listadas apropriadas. O uso de uma bateria incorreta pode resultar em combustão ou explosão da bateria.



## PERIGO

O pacote da bateria contém uma pequena quantidade de níquel. Não o desmonte, jogue-o no fogo ou na água, ou deixe-o entrar em curto-circuito. Descarte o pacote da bateria conforme requerido pelas leis ou regulamentos locais. Use somente a bateria nas partes listadas apropriadas ao substituir o pacote da bateria. O uso de uma bateria incorreta pode resultar em combustão ou explosão da bateria.



## PERIGO

A bateria de lítio pode causar incêndio, explosão ou graves queimaduras. Não a recarregue, remova seu conector polarizado, desmonte-a, aqueça-a acima de 100°C (212°F), incinere-a, ou exponha o conteúdo de sua célula à água. Descarte a bateria conforme requerido pelas leis ou regulamentos locais. Use somente a bateria nas partes listadas apropriadas. O uso de uma bateria incorreta pode resultar em combustão ou explosão da bateria.



## PERIGO

Se o LCD quebrar e o fluido de dentro dele entrar em contato com seus olhos ou com suas mãos, lave as áreas afetadas imediatamente com água durante pelo menos 15 minutos. Procure cuidados médicos se algum sintoma causado pelo fluido surgir após a lavagem.



## PERIGO

Para evitar choque elétrico, não remova a capa plástica que protege a parte inferior da placa inversora.



## PERIGO

Embora as principais baterias possuam baixa voltagem, uma bateria em curto-circuito ou aterrada pode produzir corrente o bastante para queimar materiais de pessoal ou inflamáveis.



## PERIGO

A menos que uma hot swap seja permitida para a FRU que está sendo substituída, faça o seguinte antes de removê-la: desligue o computador, desconecte todos os cabos de energia das tomadas, remova o pacote de baterias e desconecte quaisquer cabos de interconexão.



## DANGER

Avant de remettre l'ordinateur sous tension après remplacement d'une unité en clientèle, vérifiez que tous les ressorts, vis et autres pièces sont bien en place et bien fixées. Pour ce faire, secouez l'unité et assurez-vous qu'aucun bruit suspect ne se produit. Des pièces métalliques ou des copeaux de métal pourraient causer un court-circuit.



## DANGER

Certaines batteries de secours contiennent du nickel et du cadmium. Ne les démontez pas, ne les rechargez pas, ne les exposez ni au feu ni à l'eau. Ne les mettez pas en court-circuit. Pour les mettre au rebut, conformez-vous à la réglementation en vigueur. Lorsque vous remplacez la pile de sauvegarde ou celle de l'horloge temps réel, veillez à n'utiliser que les modèles cités dans la liste de pièces détachées adéquate. Une batterie ou une pile inappropriée risque de prendre feu ou d'exploser.



#### **DANGER**

La batterie contient du nickel. Ne la démontez pas, ne l'exposez ni au feu ni à l'eau. Ne la mettez pas en court-circuit. Pour la mettre au rebut, conformez-vous à la réglementation en vigueur. Lorsque vous remplacez la batterie, veillez à n'utiliser que les modèles cités dans la liste de pièces détachées adéquate. En effet, une batterie inappropriée risque de prendre feu ou d'exploser.



#### **DANGER**

La pile de sauvegarde contient du lithium. Elle présente des risques d'incendie, d'explosion ou de brûlures graves. Ne la rechargez pas, ne retirez pas son connecteur polarisé et ne la démontez pas. Ne l'exposez pas à une température supérieure à 100°C, ne la faites pas brûler et n'en exposez pas le contenu à l'eau. Mettez la pile au rebut conformément à la réglementation en vigueur. Une pile inappropriée risque de prendre feu ou d'exploser.



#### **DANGER**

Si le panneau d'affichage à cristaux liquides se brise et que vous recevez dans les yeux ou sur les mains une partie du fluide, rincez-les abondamment pendant au moins quinze minutes. Consultez un médecin si des symptômes persistent après le lavage.



#### **DANGER**

Afin d'éviter tout risque de choc électrique, ne retirez pas le cache en plastique protégeant la partie inférieure de la carte d'alimentation.



#### **DANGER**

Bien que le voltage des batteries principales soit peu élevé, le court-circuit ou la mise à la masse d'une batterie peut produire suffisamment de courant pour brûler des matériaux combustibles ou causer des brûlures corporelles graves.



## DANGER

Si le remplacement à chaud n'est pas autorisé pour l'unité remplaçable sur site que vous remplacez, procédez comme suit avant de retirer l'unité : mettez l'ordinateur hors tension, débranchez tous les cordons d'alimentation des prises de courant, retirez le bloc de batterie et déconnectez tous les câbles d'interconnexion.



## VORSICHT

Bevor nach einem FRU-Austausch der Computer wieder angeschlossen wird, muß sichergestellt werden, daß keine Schrauben, Federn oder andere Kleinteile fehlen oder im Gehäuse vergessen wurden. Der Computer muß geschüttelt und auf Klappergeräusche geprüft werden. Metallteile oder-splitter können Kurzschlüsse erzeugen.



## VORSICHT

Die Bereitschaftsbatterie, die sich unter dem Diskettenlaufwerk befindet, kann geringe Mengen Nickel und Cadmium enthalten. Sie darf nur durch die Verkaufsstelle oder den IBM Kundendienst ausgetauscht werden. Sie darf nicht zerlegt, wiederaufgeladen, kurzgeschlossen, oder Feuer oder Wasser ausgesetzt werden. Die Batterie kann schwere Verbrennungen oder Verätzungen verursachen. Bei der Entsorgung die örtlichen Bestimmungen für Sondermüll beachten. Beim Ersetzen der Bereitschafts- oder Systembatterie nur Batterien des Typs verwenden, der in der Ersatzteilliste aufgeführt ist. Der Einsatz falscher Batterien kann zu Entzündung oder Explosion führen.



## VORSICHT

Akkus enthalten geringe Mengen von Nickel. Sie dürfen nicht zerlegt, wiederaufgeladen, kurzgeschlossen, oder Feuer oder Wasser ausgesetzt werden. Bei der Entsorgung die örtlichen Bestimmungen für Sondermüll beachten. Beim Ersetzen der Batterie nur Batterien des Typs verwenden, der in der Ersatzteilliste aufgeführt ist. Der Einsatz falscher Batterien kann zu Entzündung oder Explosion führen.



## VORSICHT

Die Systembatterie ist eine Lithiumbatterie. Sie kann sich entzünden, explodieren oder schwere Verbrennungen hervorrufen. Batterien dieses Typs dürfen nicht aufgeladen, zerlegt, über 100°C erhitzt oder verbrannt werden. Auch darf ihr Inhalt nicht mit Wasser in Verbindung gebracht oder der zur richtigen Polung angebrachte Verbindungsstecker entfernt werden. Bei der Entsorgung die örtlichen Bestimmungen für Sondermüll beachten. Beim Ersetzen der Batterie nur Batterien des Typs verwenden, der in der Ersatzteilliste aufgeführt ist. Der Einsatz falscher Batterien kann zu Entzündung oder Explosion führen.





## VORSICHT

Die Leuchtstoffröhre im LCD-Bildschirm enthält Quecksilber. Bei der Entsorgung die örtlichen Bestimmungen für Sondermüll beachten. Der LCD-Bildschirm besteht aus Glas und kann zerbrechen, wenn er unsachgemäß behandelt wird oder der Computer auf den Boden fällt. Wenn der Bildschirm beschädigt ist und die darin befindliche Flüssigkeit in Kontakt mit Haut und Augen gerät, sollten die betroffenen Stellen mindestens 15 Minuten mit Wasser abgespült und bei Beschwerden anschließend ein Arzt aufgesucht werden.



## VORSICHT

Aus Sicherheitsgründen die Kunststoffabdeckung, die den unteren Teil der Spannungswandlerplatine umgibt, nicht entfernen.



## VORSICHT

Obwohl Hauptbatterien eine niedrige Spannung haben, können sie doch bei Kurzschluß oder Erdung genug Strom abgeben, um brennbare Materialien zu entzünden oder Verletzungen bei Personen hervorzurufen.



## VORSICHT

Wenn ein Austausch der FRU bei laufendem Betrieb nicht erlaubt ist, gehen Sie beim Austausch der FRU wie folgt vor: Schalten Sie den Computer aus, ziehen Sie alle Netzkabel von den Netzsteckdosen ab, entfernen Sie den Akku und ziehen Sie alle miteinander verbundenen Kabel ab.



סכנה

לפני הפעלת המחשב לאחר החלפת FRU יש לוודא שכל חברגים, חקפזים, וחלקים קטנים אחרים נמצאים במקומם ואינם חופשיים לזוז בתוך המחשב. כדי לוודא זאת, יש לטלטל את המחשב ולהקשיב לגילוי קולות שקשוק. חלקי או שבבי מתכת עלולים לגרום לקצרים חשמליים.



סכנה

סוללות המתנה מסוימות מכילות כמות קטנה של ניקל וקדמיום. אין למרק סוללת המתנה, לטעון אותה מחדש, להשליך אותה לאש או למים או לקצר אותה. יש לסלק את הסוללה כנדרש על ידי התקנות והחוקים המקומיים. יש להשתמש רק בסוללה המומייעה ברשימת החלקים המתאימה. שימוש בסוללה לא מתאימה עלול לגרום להצתה או התמוצצות של הסוללה.



סכנה

מארוז הסוללה מכיל כמות קטנה של ניקל וקדמיום. אין למרק את מארוז הסוללה, להשליך אותו לאש או למים או לקצר אותו. יש לסלק את מארוז הסוללה הסוללה כנדרש על ידי התקנות והחוקים המקומיים. יש להשתמש רק בסוללה המומייעה ברשימת החלקים המתאימה בזמן החלפת מארוז הסוללה. שימוש בסוללה לא מתאימה עלול לגרום להצתה או התמוצצות של הסוללה.



סכנה

סוללת הליתיום עלולה לגרום לשריפה, להתפוצצות או לכוויות קשות. אין לטעון אותה מחדש, לשלף את המחבר המקוטב שלה, לפרק אותה או לחמם אותה לסמפרטורה העולה על 100 מעלות צלזיוס. אין לשרוף את הסוללה ואין לחשוף את תוכן הזנא למים. יש לשלף את הסוללה כנדרש בתקנות ובחוקים המקומיים. יש להשתמש רק בסוללה המופיעה ברשימת החלקים המתאימים. שימוש בסוללה אחרת עלול לגרום לסכנת שריפה או התפוצצות.



סכנה

אם מסך הנביש הנוזלי (LCD) נשבר והנוזל מתוך המסך בא במגע עם עיניכם או ידיכם, שטפו את האזורים הנגועים מיד במים במשך 15 דקות לפחות. פנו לקבלת עזרה רפואית אם תסמינים הנובעים מחמגע עם הנוזל נמשכים לאחר השטיפה.



סכנה

כדי למנוע התחשמלות, אין לחסיר את מכסה הפלסטיק המגן על חלקו התחתון של הכרטיס החמך.



סכנה

אף שהסוללות הראשיות הן בעלות מתח נמוך, סוללה מקוצרת או מוארכת עלולה להפיק זרם מסביב לגרימת כוויות או להצתת חומרים דליקים.



סכנה

אלא אם כן מותרת 'החלפה חמה' של ה-FRU המוחלף, פעלו כדלהלן לפני חסרתו: כבו את המחשב, נתקו את כל כבלי החשמל מחשקעים, הוציאו את מארז הסוללות ונתקו את כל הכבלים המחוברים.



החלפה

FRUの交換後、コンピューターの電源を入れる前に、ねじ、バネ、その他の小さな部品がすべて正しい位置にあり、コンピューターの内部でそれらが緩んでいないことを確認してください。これを確認するには、コンピューターを振って、カチャカチャと音がしないか確認します。金属部品や金属破片はショートの原因になることがあります。



החלפה

予備バッテリーの中には少量のニッケルとカドミウムが含まれているものがあります。したがって、予備バッテリーの分解、再充電、火または水の中への投棄、またはショートさせることは決して行わないでください。バッテリーを廃棄する場合は地方自治体の条例に従ってください。適切なパーツ・リストにあるバッテリーだけを使用してください。誤ったバッテリーを使用すると、バッテリーが発火したり、爆発したりすることがあります。



החלפה

バッテリー・パックには少量のニッケルが含まれています。バッテリー・パックを分解したり、火または水の中に投げ込んだり、ショートさせないでください。バッテリー・パックの廃棄にあたっては、地方自治体の条例または規則に従ってください。バッテリー・パックを交換するときは、適切なパーツ・リストにあるバッテリーだけを使用してください。誤ったバッテリーを使用すると、バッテリーが発火したり、爆発したりすることがあります。



## 危険

リチウム・バッテリーは、火災、爆発、または重症のやけどを引き起こすことがあります。バックアップ・バッテリーの充電、その極性コネクターの取り外し、バッテリー本体の分解、100°C (212°F) 以上への加熱、焼却、電池の中身を水に浸すことはしないでください。バッテリーを廃棄する場合は地方自治体の条例に従ってください。適切なパーツ・リストにあるバッテリーだけを使用してください。誤ったバッテリーを使用すると、バッテリーが発火したり、爆発したりすることがあります。



## 危険

LCD が破損し、LCD 中の液体が目に入ったり、手に触れたりした場合は、液体が触れた部分を少なくとも 15 分間洗い流してください。洗い流した後に、液体によって何らかの症状が現れた場合は、医師の治療を受けてください。



## 危険

感電を防ぐため、インバーター・カードの下部を保護しているプラスチック・カバーを外さないでください。



## 危険

メイン・バッテリーの電圧は低くても、ショートしたり、接地したバッテリーが、作業者にやけどを負わせたり、可燃物を燃やすだけの電流を発生させる場合があります。



## 危険

交換しようとしている FRU がホット・スワップに対応していない場合、それを取り外す前に、コンピューターの電源をオフにし、すべての電源コードをコンセントから抜き、バッテリー・パックを取り外して、相互接続しているケーブルをすべて切り離してください。



## 위험

FRU를 교체하고 나서 컴퓨터 전원을 켜기 전에 모든 나사, 스프링 및 기타 작은 부품들이 올바른 위치에 있는지, 컴퓨터 내부에 단단하게 연결되어 있는지 확인하십시오. 컴퓨터를 흔들어 달각거리는 소리가 나지 않는지 확인하십시오. 금속 부품 또는 금속 조각은 누전을 일으킬 수 있습니다.



## 위험

일부 보조 배터리에는 소량의 니켈 및 카드뮴이 포함되어 있습니다. 보조 배터리를 분해하거나, 다시 충전하거나, 불 또는 물에 던지거나, 단락시키지 마십시오. 배터리 팩을 폐기할 때에는 해당 지역의 법률 규정을 따르십시오. 배터리 팩을 교체할 때에는 올바른 배터리만 사용하십시오. 올바르지 않은 배터리를 사용하면 배터리가 발화되거나 폭발할 수 있습니다.



#### 위험

배터리 팩에는 소량의 니켈이 포함되어 있습니다. 배터리 팩을 분해하거나, 불 또는 물에 던지거나, 단락시키지 마십시오. 배터리 팩을 폐기할 때에는 해당 지역의 법률 규정을 따르십시오. 배터리 팩을 교체할 때에는 올바른 배터리만 사용하십시오. 올바르지 않은 배터리를 사용하면 배터리가 발화되거나 폭발할 수 있습니다.



#### 위험

리튬 배터리는 화재, 폭발 또는 심각한 화상을 일으킬 수 있습니다. 리튬 배터리를 다시 충전하거나, 극성 커넥터를 제거하거나, 분해하거나, 100C(212F) 이상으로 가열하거나, 소각하거나, 전지 내용물을 물에 노출시키지 마십시오. 배터리를 폐기할 때에는 해당 지역의 법률 규정을 따르십시오. 올바른 배터리만 사용하십시오. 올바르지 않은 배터리를 사용하면 배터리가 발화되거나 폭발할 수 있습니다.



#### 위험

LCD가 파손되어 LCD 내부의 액체가 눈에 들어가거나 손에 묻으면 즉시 깨끗한 물로 15분 이상 닦아 내십시오. 씻은 후에 조금이라도 이상을 느끼면 즉시 병원에 가서 의사의 진찰을 받아야 합니다.



#### 위험

전기적 위험을 방지하려면 인버터 카드의 아래 부분을 보호하는 플라스틱 덮개를 제거하지 마십시오.



#### 위험

기본 배터리의 전압은 낮지만, 단락되거나 접지된 배터리는 화상을 입히기에 충분한 전류와 가연성 물질을 발생시킬 수 있습니다.



#### 위험

FRU 교체 시 Hot Swap이 지원되지 않는 경우, FRU를 제거하기 전에 컴퓨터의 전원을 끄고, 전기 콘센트에서 전원 코드를 분리하고, 배터리를 제거한 후, 연결된 모든 케이블을 분리하십시오.



#### PELIGRO

Antes de encender el sistema después de sustituir una FRU, compruebe que todos los tornillos, muelles y demás piezas pequeñas se encuentran en su sitio y no se encuentran sueltas dentro del sistema. Compruébelo agitando el sistema y escuchando los posibles ruidos que provocarían. Las piezas metálicas pueden causar cortocircuitos eléctricos.



#### **PELIGRO**

Algunas baterías de reserva contienen una pequeña cantidad de níquel y cadmio. No las desmonte, ni recargue, ni las eche al fuego o al agua ni las cortocircuite. Deséchelas tal como dispone la normativa local. Utilice sólo baterías que se encuentren en la lista de piezas. La utilización de una batería no apropiada puede provocar la ignición o explosión de la misma.



#### **PELIGRO**

Las baterías contienen pequeñas cantidades de níquel. No las desmonte, ni recargue, ni las eche al fuego o al agua ni las cortocircuite. Deséchelas tal como dispone la normativa local. Utilice sólo baterías que se encuentren en la lista de piezas al sustituir la batería. La utilización de una batería no apropiada puede provocar la ignición o explosión de la misma.



#### **PELIGRO**

La batería de repuesto es una batería de litio y puede provocar incendios, explosiones o quemaduras graves. No la recargue, ni quite el conector polarizado, ni la desmonte, ni caliente por encima de los 100°C (212°F), ni la incinere ni exponga el contenido de sus celdas al agua. Deséchela tal como dispone la normativa local.



#### **PELIGRO**

Si la LCD se rompe y el fluido de su interior entra en contacto con sus ojos o sus manos, lave inmediatamente las áreas afectadas con agua durante 15 minutos como mínimo. Obtenga atención médica si se presenta algún síntoma del fluido después de lavarse.



#### **PELIGRO**

Para evitar descargas, no quite la cubierta de plástico que rodea la parte baja de la tarjeta invertida.



#### **PELIGRO**

Aunque las baterías principales tienen un voltaje bajo, una batería cortocircuitada o con contacto a tierra puede producir la corriente suficiente como para quemar material combustible o provocar quemaduras en el personal.



## PELIGRO

Salvo que se permita el intercambio en caliente para la unidad sustituible localmente, realice lo siguiente antes de extraerla: apague el sistema, desconecte todos los cables de alimentación de las tomas de alimentación eléctrica, extraiga la batería y desconecte los cables de interconexión.



## 危險

完成 FRU 更換之後，在開啟電腦的電源之前，請確定所有螺絲、彈簧及其他小零件都已歸位，沒有遺留在電腦內部。  
若要確認這一點，請搖晃電腦，聽聽看是否有卡嗒的聲音。  
金屬零件或儀錶的火花會造成電線短路。



## 危險

部分備用電池含有微量的鎳和銅。請勿拆開備用電池、再充電、丟入火或水中，或使其形成短路。請按照當地法令或規定來棄置電池。

僅限使用零件清單中的電池。使用不適當的電池會導致電池起火或爆炸。



## 危險

電池套件含有微量的鎳。請勿拆開電池套件、丟入火或水中，或使其形成短路。請按照當地法令或規定來棄置電池套件。

更換電池套件時，僅限使用零件清單中的電池。使用不適當的電池會導致電池起火或爆炸。



## 危險

鋰電池會導致起火、爆炸或嚴重燒傷。請勿再充電、拔除其電極接頭、拆開、加熱超過 100°C (212°F)、焚燒，或讓電池組物浸到水。請按照當地法令或規定來棄置電池。

僅限使用零件清單中的電池。使用不適當的電池會導致電池起火或爆炸。



## 危險

如果 LCD 破裂導致 LCD 流出的液體沾到您的眼睛或手，請立即以清水沖洗沾染部位至少 15 分鐘。如果在清洗後出現該液體所造成的任何症狀，請就醫治療。



## 危險

為避免電擊，請勿拆下轉換卡下面的塑膠護蓋。



危險

雖然主電池的電壓很低，但短路或接地電池所產生的電流，仍足以使人燒傷或使可燃物質起火。



危險

除非 FRU 允許以熱抽換來替換，否則請依下列方式將其移除：將電腦關機，拔除插座上所有電源線，移除電池包，並拔開任何交互連接的線材。





---

## Chapter 2. General checkout

Before you go to the checkout instructions, ensure that you read the following important notes.

### Important notes:

- **Only certified trained personnel should service the computer.**
- **Before replacing any FRU, read the entire page on removing and replacing FRUs.**
- **When you replace FRUs, it is recommended to use new nylon-coated screws.**
- **Be extremely careful during such write operations as copying, saving, or formatting.** Drives in the computer that you are servicing sequence might have been altered. If you select an incorrect drive, data or programs might be overwritten.
- **Replace a FRU only with another FRU of the correct model.** When you replace a FRU, make sure that the model of the machine and the FRU part number are correct by visiting <https://support.lenovo.com/partslookup>.
- **A FRU should not be replaced because of a single, unreproducible failure.** Single failures can occur for a variety of reasons that have nothing to do with a hardware defect, such as cosmic radiation, electrostatic discharge, or software errors. Consider replacing a FRU only when a problem recurs. If you suspect that a FRU is defective, clear the error log and run the test again. If the error does not recur, do not replace the FRU.
- **Be careful not to replace a nondefective FRU.**

---

## What to do first

When you return a FRU, you must include the following information in the parts exchange form or parts return form that you attach to it:

1. Name and phone number of service technician
2. Date of service
3. Date on which the machine failed
4. Date of purchase
5. Failure symptoms, error codes appearing on the display, and beep symptoms
6. Procedure index and page number in which the failing FRU was detected
7. Failing FRU name and part number
8. Machine type, model number, and serial number
9. Customer's name and address

**Note:** During the warranty period, the customer may be responsible for repair costs if the computer damage was caused by misuse, accident, modification, unsuitable physical or operating environment, or improper maintenance by the customer. Following is a list of some common items that are not covered under warranty and some symptoms that might indicate that the system was subjected to stress beyond normal use.

Before checking problems with the computer, determine whether the damage is covered under the warranty by referring to the following list:

### The following are not covered under warranty:

- LCD panel cracked from the application of excessive force or from being dropped
- Scratched (cosmetic) parts
- Distortion, deformation, or discoloration of the cosmetic parts
- Plastic parts, latches, pins, or connectors that have been cracked or broken by excessive force

- Damage caused by liquid spilled into the system
- Damage caused by the improper insertion of a personal-computer card (PC card) or the installation of an incompatible card
- Improper disc insertion or use of an external optical drive
- Fuses blown by attachment of a non-supported device
- Forgotten computer password (making the computer unusable)
- Sticky keys caused by spilling a liquid onto the keyboard
- Use of an incorrect ac power adapter on laptop products

**The following symptoms might indicate damage caused by non-warranted activities:**

- Missing parts might be a symptom of unauthorized service or modification.
- Check for obvious damage to a hard disk drive. If the spindle of a hard disk drive becomes noisy, the hard disk drive might have been dropped or subject to excessive force.

---

## Checking the ac power adapter

If the computer fails only when the ac power adapter is used:

- If the power problem occurs only when the docking station or the port replicator is used, replace the docking station or the port replicator.
- If the system status indicator does not blink three times when an ac power source is connected, check the power cord of the ac power adapter for correct continuity and installation.
- If the computer does not charge during operation, go to “Checking the battery and operational charging” on page 20.

**Note:** Noise from the ac power adapter does not always indicate a defect.

### Checking the ac power adapter

1. Connect the computer to a power outlet and turn on the computer.
2. Start the Vantage app, and locate the **Power** section. The ac power adapter information is displayed.

Ensure that you use the ac power adapter that is shipped with the computer to provide enough power to the computer. Otherwise a message will be displayed, prompting you that the computer will not be charged or will be charged slowly.

---

## Checking the battery and operational charging

### Checking the battery

This system supports only batteries specially designed for this specific system and manufactured by Lenovo or an authorized manufacturer. The system does not support unauthorized batteries or batteries designed for other systems. If an unauthorized battery or a battery designed for another systems is installed, the system will not charge.

**Attention:** Lenovo has no responsibility for the performance or safety of unauthorized batteries, and provides no warranties for failures or damage arising out of their use.

Move your pointer to the battery-status icon in the Windows® notification area to check the battery status. The battery-status icon displays the percentage of battery power remaining and how long you can use your computer before you must charge the battery.

### Checking the operational charging

1. Discharge the battery to 50% or lower.

2. Perform operational charging. Click the battery status icon in the Windows notification area to display detailed battery information. If it indicates that the battery is not charging, replace the battery.
3. Check the battery status again. If the same error still exists, replace the system board.











## Chapter 3. Locations

### Locating computer controls and connectors

#### Front view









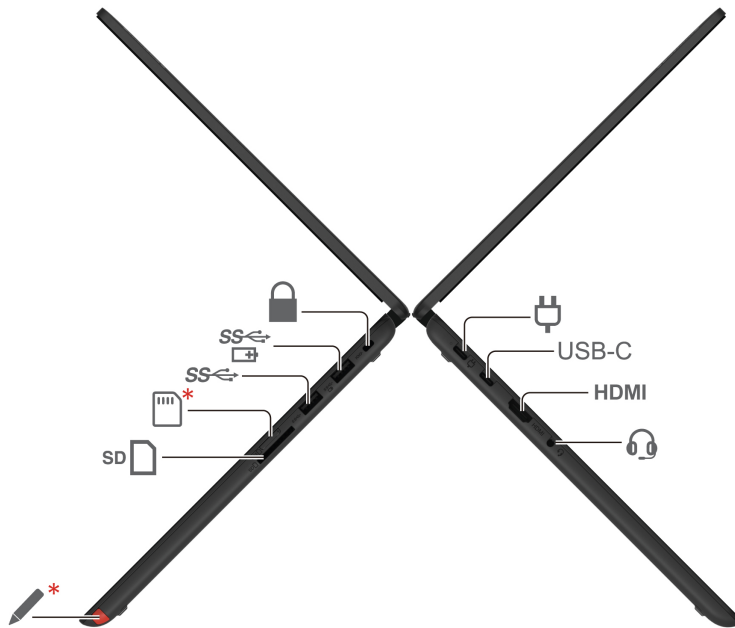

Item	Description	Item	Description
	Microphone		Infrared (IR) camera / Camera
	Webcam privacy shutter		Touch screen
	Power button with / without fingerprint reader		Speaker
	Trackpad		Microphone

\* for selected models

## Side view



Item	Description	Item	Description
	Power connector / USB-C® connector	USB-C	USB-C (3.2 Gen 1) connector
HDMI	HDMI™ connector		Audio connector
	Lenovo Integrated Pen	SD 	SD card slot
	Nano-SIM-card tray	SS 	USB-A 3.2 Gen 1 connector
SS 	Always on USB 3.2 Gen 1 connector		Security-lock slot

\* for selected models

---

## Locating FRUs and CRUs

This topic introduces the following service parts:

- “Major FRUs and CRUs” on page 27
- “LCD FRUs and CRUs” on page 29
- “Miscellaneous parts” on page 30

### Notes:

- Each FRU is available for all types or models, unless otherwise specified.
- **CRU statement for customers:**

You can resolve some problems with your product with a replacement part you can install yourself, called a “Customer Replaceable Unit” or “CRU.” Some CRUs are designated as self-service CRUs and others are designated as optional-service CRUs. *Installation of self-service CRUs is your responsibility. For optional-service CRUs, you can either install the CRU yourself or you can request that a Service Provider install the CRU according to the warranty service for your product.* If you intend on installing the CRU, Lenovo will ship the CRU to you. CRU information and replacement instructions are shipped with your product and are available from Lenovo at any time upon request. You can find a list of CRUs for your product in this *Hardware Maintenance Manual*. An electronic version of this manual can be found at <https://support.lenovo.com>. Click **Documentation** and then follow the on-screen instructions to find the manual for your product. You might be required to return the defective CRU. When return is required: (1) return instructions, a prepaid shipping label, and a container will be included with the replacement CRU; and (2) you might be charged for the replacement CRU if Lenovo does not receive the defective CRU within thirty (30) days of your receipt of the replacement CRU. See your Lenovo Limited Warranty documentation for full details.
- Your computer contains the following types of CRUs and FRUs:
  - **Self-service CRUs:** Refer to parts that can be replaced easily by customer themselves or by trained service technicians at an additional cost.
  - **Optional-service CRUs:** Refer to parts that can be replaced by customers with a greater skill level. Trained service technicians can also provide service to replace the parts under the type of warranty designated for the customer’s machine.
  - **FRUs:** Refer to parts that must be replaced only by trained service technicians. If customers choose to replace the FRUs by themselves, the product warranty might be affected.



# Major FRUs and CRUs

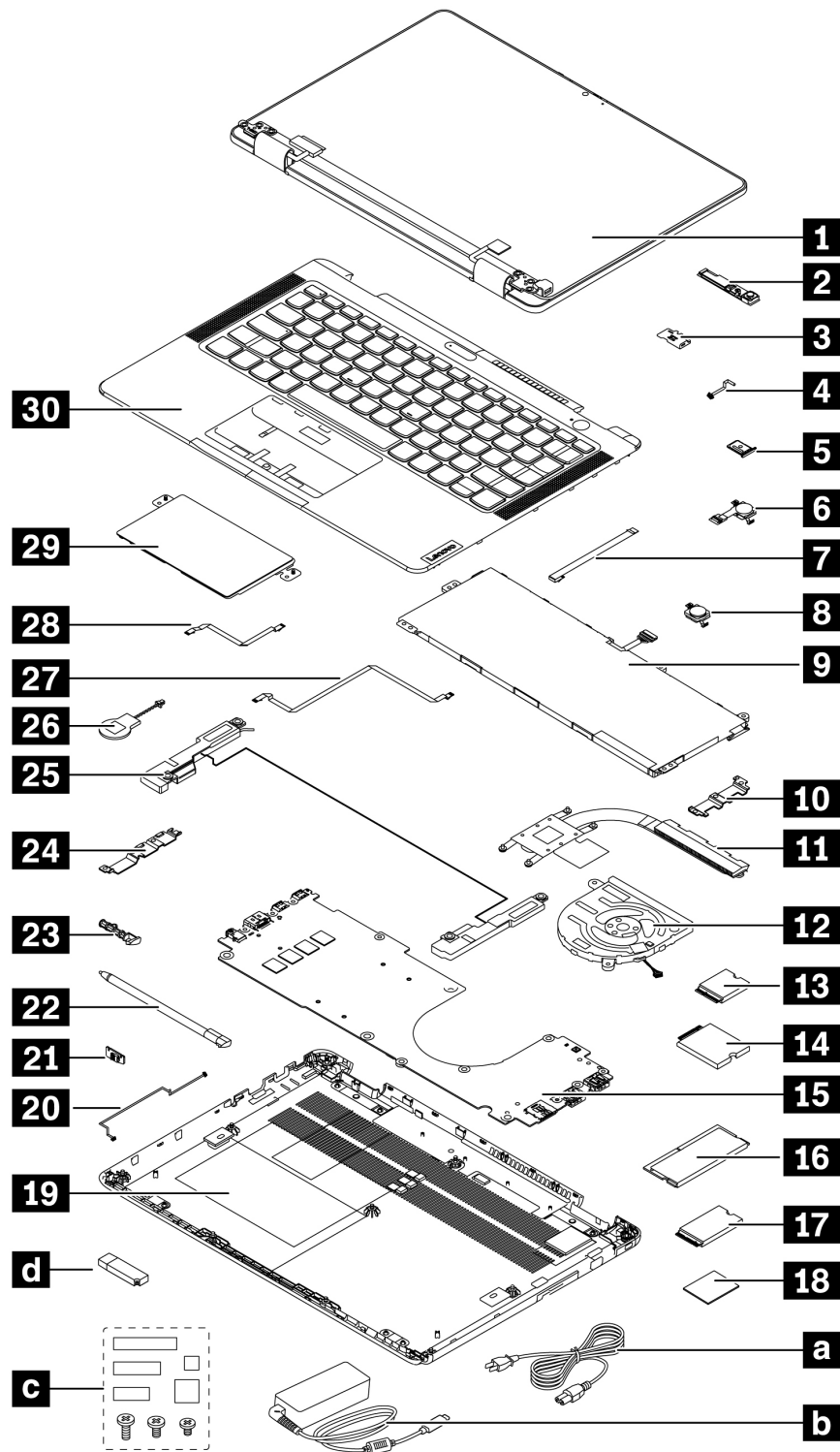



Table 1. Major FRUs and CRUs

No.	FRU description	Self-service CRU	Optional-service CRU
<b>1</b>	LCD unit	No	No
<b>2</b>	Rear camera and microphone module*	No	No
<b>3</b>	Rear camera bracket*	No	No
<b>4</b>	Rear camera and microphone module cable*	No	No
<b>5</b>	Nano-SIM-card tray*	Yes	No
<b>6</b>	Power button with bracket and fingerprint reader*	No	No
<b>7</b>	Fingerprint reader cable*	No	No
<b>8</b>	Power button with bracket	No	No
<b>9</b>	Built-in battery	No	No
<b>10</b>	Right I/O bracket	No	No
<b>11</b>	Heat sink	No	No
<b>12</b>	Thermal fan	No	No
<b>13</b>	Wireless LAN card	No	No
<b>14</b>	Wireless WAN card*	No	Yes
<b>15</b>	System board	No	No
<b>16</b>	Memory module	No	Yes
<b>17</b>	M.2 2242 solid-state drive	No	Yes
<b>18</b>	Thermal pad for M.2 2242 solid-state drive	No	No
<b>19</b>	Base cover assembly	No	Yes
<b>20</b>	Lenovo Integrated Pen charge board cable*	No	No
<b>21</b>	Lenovo Integrated Pen charge board*	No	No
<b>22</b>	Lenovo Integrated Pen*	Yes	No
<b>23</b>	Pen dummy*	No	Yes
<b>24</b>	Left I/O bracket	No	No
<b>25</b>	Speaker assembly	No	No
<b>26</b>	Coin-cell battery	No	No
<b>27</b>	P-sensor cable*	No	No
<b>28</b>	Trackpad cable	No	No
<b>29</b>	Trackpad	No	No
<b>30</b>	Keyboard assembly	No	No
<b>a</b>	Power cord	Yes	No
<b>b</b>	ac power adapter	Yes	No
<b>c</b>	Miscellaneous parts kits (see “Miscellaneous parts” on page 30)	No	No
<b>d</b>	Lenovo factory recovery USB key*	No	No

\* for selected models

**Note:** The Lenovo factory recovery USB key  is used to restore the Microsoft Windows operating system. It might not come with the computer, and a user might order it from <https://pcsupport.lenovo.com/lenovorecovery>, though additional shipping and handling fees might apply.

## LCD FRUs and CRUs

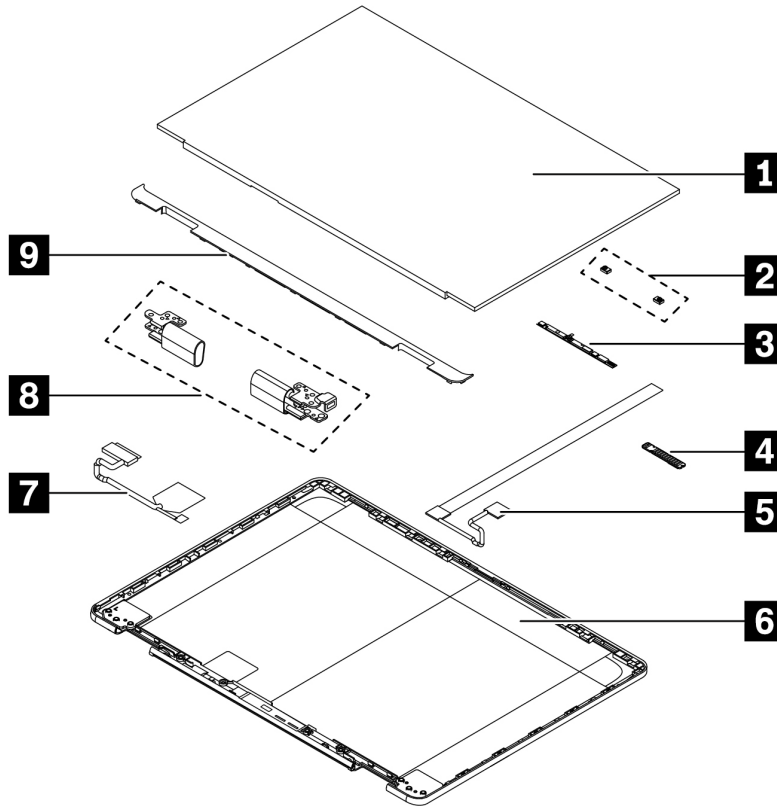

Table 2. LCD FRUs and CRUs

No.	FRU description	Self-service CRU	Optional-service CRU
<b>1</b>	Touch module assembly	No	No
<b>2</b>	Microphone rubbers	No	No
<b>3</b>	Camera and microphone module	No	No
<b>4</b>	Gravity sensor board	No	No
<b>5</b>	Camera cable	No	No
<b>6</b>	LCD cover assembly	No	No
<b>7</b>	LCD cable	No	No
<b>8</b>	LCD hinges	No	No
<b>9</b>	LCD strip cover	No	No

## Miscellaneous parts

Table 3. Miscellaneous part

FRU descriptions	Self-service CRU	Optional-service CRU
Screw kit <ul style="list-style-type: none"> <li>• M2 x L2.5, black (2)</li> <li>• M2 x L3, black (8)</li> <li>• M2 x L3, silver (4)</li> <li>• M2 x L4, silver (16)</li> <li>• M2.5 x L2.5, black (6)</li> <li>• M2.5 x L5, black (4)</li> <li>• M2.5 x L7, black (10)</li> <li>• Spec</li> </ul>	No	No
Mechanical miscellaneous kit <ul style="list-style-type: none"> <li>• Trackpad waterproof mylar</li> <li>• Thermal pad for heat sink</li> <li>• Mylar on LCD cover*</li> <li>• Rear camera sponge</li> <li>• Thermal pad for heat sink</li> <li>• Conductive tape</li> <li>• Spec</li> </ul>	No	No
Label kit: <ul style="list-style-type: none"> <li>• Label</li> <li>• Spec</li> </ul>	No	No

\* for selected model

---

## Looking up FRU information

For detailed FRU information, including part numbers, descriptions, and substitution part numbers, go to: <https://support.lenovo.com/partslookup>

---

## Chapter 4. FRU replacement notices

Read this chapter carefully before replacing any FRU.

---

### Service tool kit

Ensure that the following service tool kit is prepared before you service a notebook computer.

No.	Tool name	Tool type
1	Phillips-head screwdriver	Common tool
2	Conductive tweezers	Common tool
3	Silicone grease	Consumable tool
4	Polyamide tape	Consumable tool
5	Mylar tape	Consumable tool
6	Eraser	Consumable tool
7	Electrical tape	Consumable tool
8	Double-sided tape	Consumable tool
9	Conductive tape	Consumable tool
10	Trackpad jig (this might come with trackpad)	Consumable tool

**Note:** The silicone grease can be applied to the surfaces of the microprocessor and heatsink to eliminate air gaps.

---

### Screw notices

Loose screws can cause a reliability problem. In your computer, this problem is addressed with special nylon-coated screws that have the following characteristics:

- They maintain tight connections.
- They do not easily come loose, even with shock or vibration.
- They are harder to tighten.

Do the following when you service the computer:

- Keep the screw kit in your tool bag. For the part number of the screw kit, go to: <https://support.lenovo.com/partslookup>

Tighten screws as follows:

- **Plastic to plastic**

Turn an additional angle of 90 degrees after the screw head touches the surface of the plastic part.

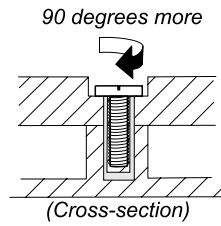

- **Logic card to plastic**

Turn an additional angle of 180 degrees after the screw head touches the surface of the logic card.

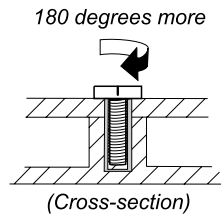

**Notes:**

- Ensure that you use the correct screw. It is recommended to use new screws for replacements. If you have a torque screwdriver, tighten all screws firmly to the torque specified in the screw information table for each step.
- Ensure torque screwdrivers are calibrated correctly following country specifications.

---

## Chapter 5. Removing or replacing a FRU

This chapter provides instructions on how to remove or replace a FRU.

---

### General guidelines

When removing or replacing a FRU, be sure to observe the following general guidelines:

1. Do not try to service any computer unless you have been trained and certified. An untrained person runs the risk of damaging parts.
2. Before replacing any FRU, review Chapter 4 “FRU replacement notices” on page 31.
3. Begin by removing any FRUs that have to be removed before replacing the failing FRU. Any such FRUs are listed at the beginning of each FRU replacement section. Remove them in the order in which they are listed.
4. Follow the correct sequence in the steps for removing a FRU, as given in the illustrations by the numbers in square callouts.
5. When turning a screw, turn it in the direction as given by the arrow in the illustration.
6. When removing a FRU, move it in the direction as given by the arrow in the illustration.
7. To put the new FRU in place, reverse the removal procedure and follow any notes that pertain to replacement.
8. When replacing a FRU, use the correct screws as shown in the replacement procedures.



**Before removing any FRU, turn off the computer, unplug all power cords from electrical outlets, disable the built-in battery, and then disconnect any interconnecting cables.**

#### Attention:

- After replacing a FRU, do not turn on the computer until you have made sure that all screws, springs, and other small parts are in place and none are loose inside the computer. Verify this by shaking the computer gently and listening for rattling sounds. Metallic parts or metal flakes can cause electrical short circuits.
- The system board is sensitive to, and can be damaged by ESD. Before touching it, establish personal grounding by touching a ground point with one hand or by using an ESD strap.

---

### Before servicing the computer

Carefully read this topic before servicing the computer.

### Disable Fast Startup and the built-in battery

Before replacing any CRU, ensure that you disable Fast Startup first and then disable the built-in battery.

To disable Fast Startup:

1. Go to **Control Panel** and view by Large icons or Small icons.
2. Click **Power Options**, and then click **Choose what the power buttons do** on the left pane.
3. Click **Change settings that are currently unavailable** at the top.
4. If prompted by User Account Control (UAC), click **Yes**.

5. Clear the **Turn on fast startup** check box, and then click **Save changes**.

To disable the built-in battery:

1. Enter the setup utility.
2. Select **Configuration** → **Disable Built-in Battery** and press Enter.
3. Select **Yes** in the Setup Confirmation window. The built-in battery is disabled and the computer turns off automatically. Wait three to five minutes to let the computer cool.

## Removing the nano-SIM-card and nano-SIM-card tray (for selected models)

**Note:** If the computer you are servicing has a nano-SIM card installed, remove the card with the tray together.

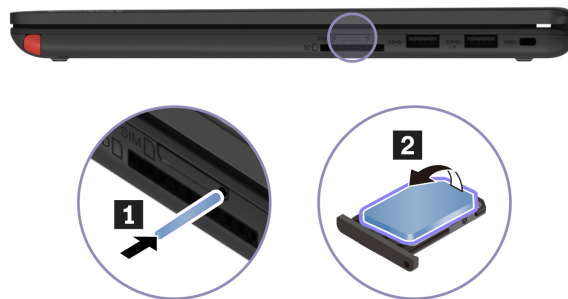

## Removing the SD card

If the computer you are servicing has an SD card installed, remove the SD card before you start the servicing. Push the SD card inward a little bit **1**. Then, release it. The SD card ejects. Gently slide the card out of the card slot **2**.

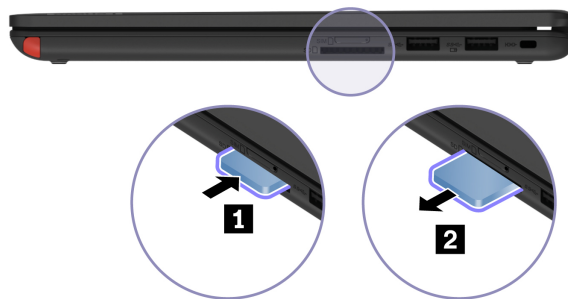

**Note:** After you finish the servicing, ensure that you install the SD card back into the slot firmly.

## Removing the pen dummy (for selected models)

If the computer you are servicing has a pen dummy installed, remove the pen dummy before you start the servicing.



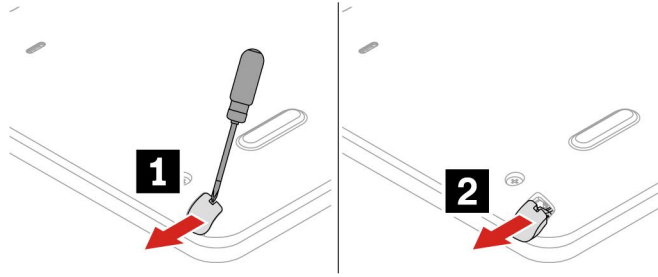

## 1010 Base cover assembly

### Removal steps of the base cover assembly

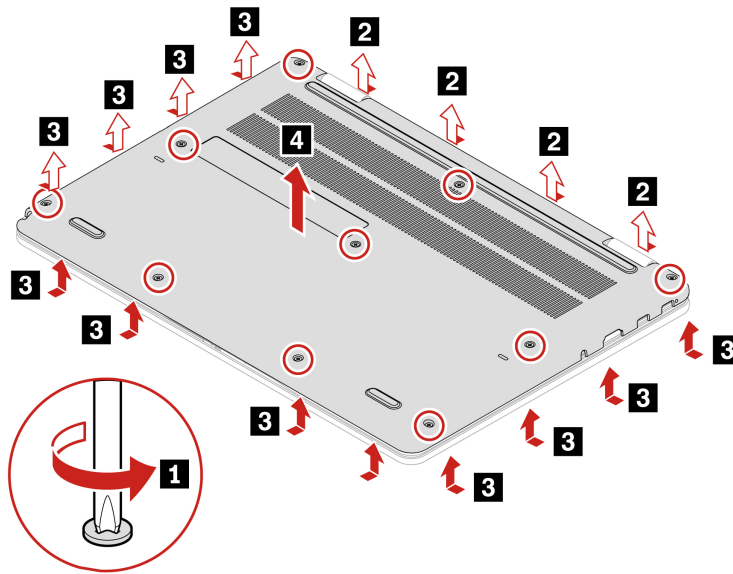

Step	Screw (quantity)	Color	Torque
<b>1</b>	M2.5 × 7 mm, flat-head, nylon-coated (10)	Black	0.294 Nm (3.0 kgf-cm)

## Applying labels to the base cover assembly

### Notes:

- Depending on the country or region of delivery, the labels might be slightly different from the ones in the following illustration.
- The new base cover assembly FRU is shipped with a kit containing labels of several kinds. Apply those labels when you replace the base cover assembly. For the labels that are not shipped with the new base cover assembly, peel them from the old base cover assembly, and adhere them to the new one.

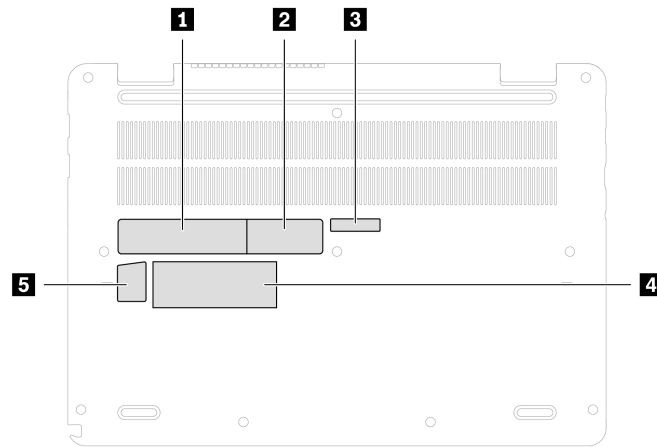

#### Item

**1** Rating label

**3** IMEI label

**5** Genuine Microsoft label

#### Item

**2** Rating label

**4** Country label

---

## 1020 M.2 2242 solid-state drive

For access, remove this FRU:

- “1010 Base cover assembly” on page 35

**Attention:** The M.2 solid-state drive is sensitive. Inappropriate handling might cause damage and permanent loss of data.

When handling the M.2 solid-state drive, observe the following guidelines:

- Replace the M.2 solid-state drive only for repair. The M.2 solid-state drive is not designed for frequent changes or replacement.
- Before replacing the M.2 solid-state drive, make a backup copy of all the data that you want to keep.
- Do not apply pressure to the M.2 solid-state drive.
- Do not touch the contact edge or circuit board of the M.2 solid-state drive. Otherwise the M.2 solid-state drive might get damaged.
- Do not make the M.2 solid-state drive subject to physical shocks or vibration. Put the M.2 solid-state drive on a soft material, such as cloth, to absorb physical shocks.

## Removal steps of the M.2 2242 solid-state drive

### Notes:

- A Mylar film might cover the solid-state drive. For access, peel off the film first.
- The thermal pad is placed on the lower surface of the solid-state drive.

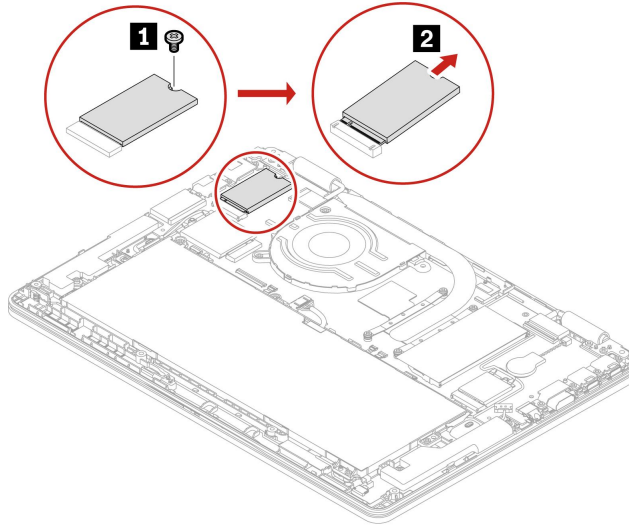

Step	Screw (quantity)	Color	Torque
1	M2 × 3 mm, flat-head, nylon-coated (1)	Black	0.181 Nm (1.85 kgf-cm)

## 1030 Wireless WAN card (for selected models)

For access, remove this FRU:

- “1010 Base cover assembly” on page 35

### Removal steps of the wireless WAN card

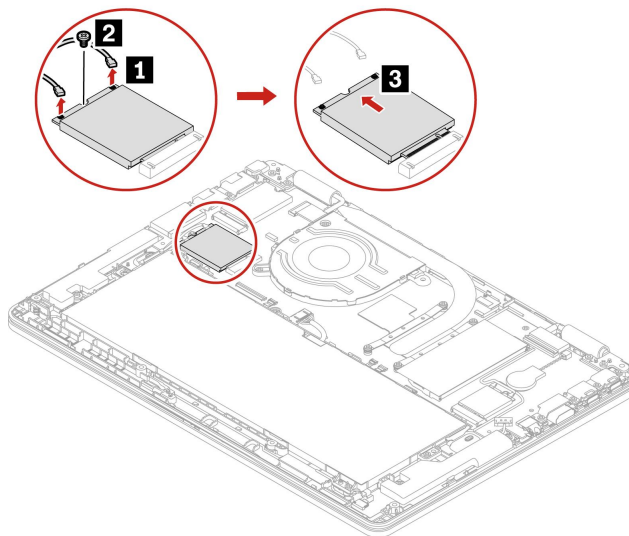

Step	Screw (quantity)	Color	Torque
<b>2</b>	M2 × 3 mm, flat-head, nylon-coated (1)	Black	0.181 Nm (1.85 kgf-cm)

**When installing:** Ensure that you connect the orange cable to the main connector, and the blue cable to the auxiliary connector.

## 1040 Coin-cell battery



**DANGER**

**Use only the authorized battery specified for the computer. Any other battery could ignite or explode.**

For access, remove this FRU:

- “1010 Base cover assembly” on page 35

### Removal steps of the coin-cell battery

**Note:** A Mylar film might cover the coin-cell battery. To access the coin-cell battery, peel off the film first.

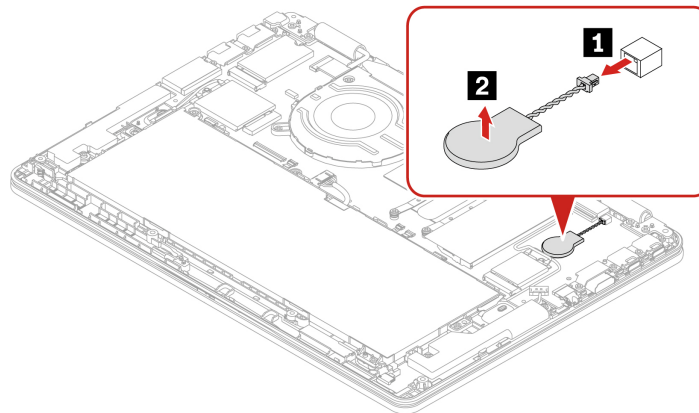

### When installing:

- Ensure that the connector is attached firmly.
- Reset the system date and time in the BIOS menu.

## 1050 Memory module

For access, remove this FRU:

- “1010 Base cover assembly” on page 35

### Removal steps of the memory module

**Note:** A Mylar film might cover the memory module. To access the memory module, peel off the film first.

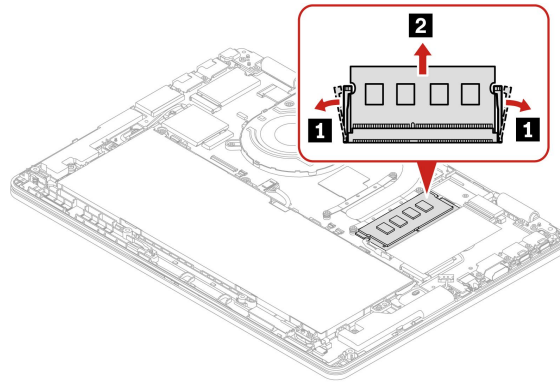

**When installing:** Insert the notched end of the memory module into the memory slot. Press the memory module in firmly, and pivot it downward until it snaps into place. Ensure that the memory module is firmly installed in the slot and does not move easily.

## 1060 Wireless LAN card

For access, remove this FRU:

- “1010 Base cover assembly” on page 35

### Removal steps of the wireless LAN card

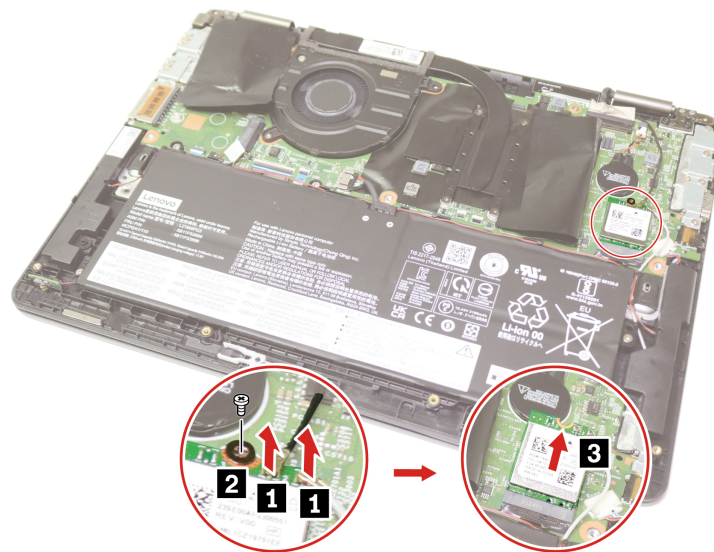

Step	Screw (quantity)	Color	Torque
2	M2 × 3 mm, flat-head, nylon-coated (1)	Black	0.181 Nm (1.85 kgf-cm)

**When installing:** Plug the gray cable into the main connector, and the black cable into the auxiliary connector on the card.

## 1070 Heat sink

For access, remove this FRU:

- “1010 Base cover assembly” on page 35

### Removal steps of the heat sink

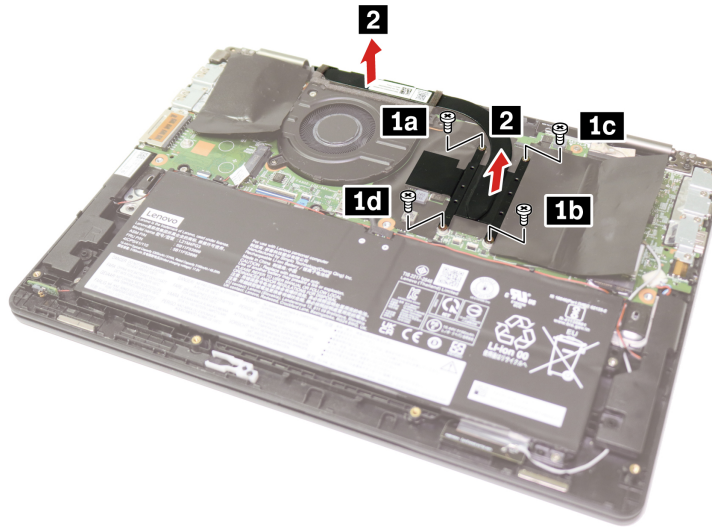

Step	Screw (quantity)	Color	Torque
<b>1</b>	M2 × 3 mm, flat-head, nylon-coated (4)	Black	0.181 Nm (1.85 kgf-cm)

**When installing:** Before you attach the heat sink to the computer, apply thermal grease, at an amount of 0.2 grams, on the parts marked **a** as shown in the following illustration. Either too much or too less application of grease can cause a thermal problem due to imperfect contact with a component. For the new heat sink, you must peel the thin film off from the rubbers.

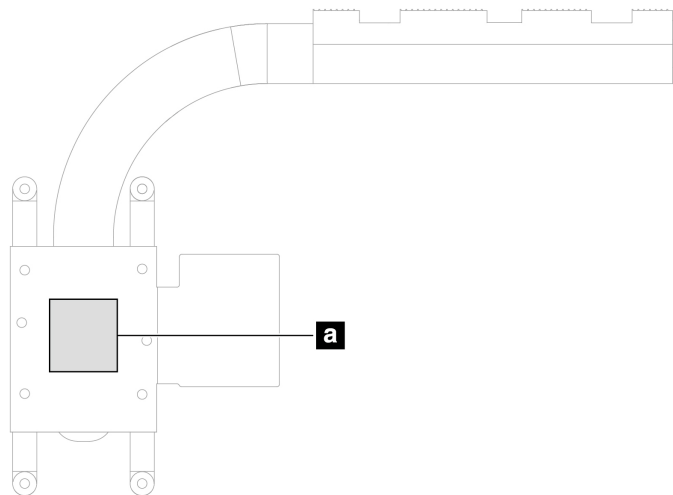

## 1080 Rear camera and microphone module, bracket, and cable (for selected models)

For access, remove these FRUs in order:

- “1010 Base cover assembly” on page 35
- “1070 Heat sink” on page 40

### Removal steps of the rear camera and microphone module, bracket, and cable

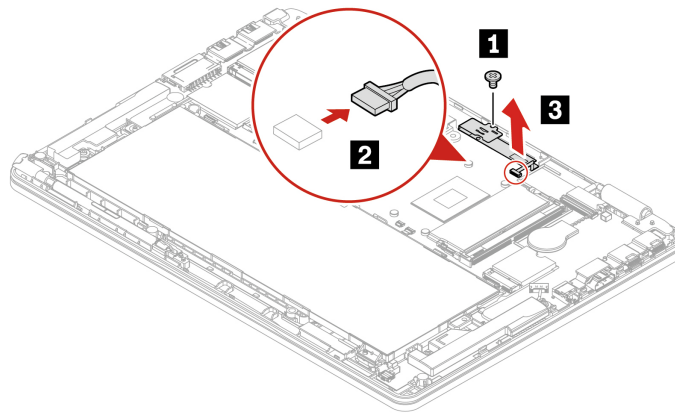

Step	Screw (quantity)	Color	Torque
1	M2 × 3 mm, flat-head, nylon-coated (1)	Black	0.181 Nm (1.85 kgf-cm)

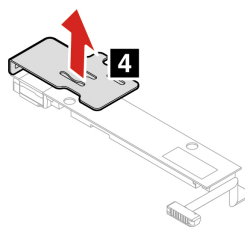

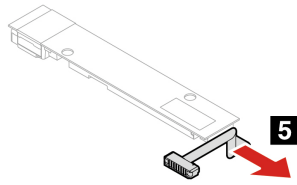

**When installing:** Ensure that the connectors are attached firmly.

---

## 1090 Thermal fan

For access, remove this FRU:

- “1010 Base cover assembly” on page 35

### Removal steps of the thermal fan

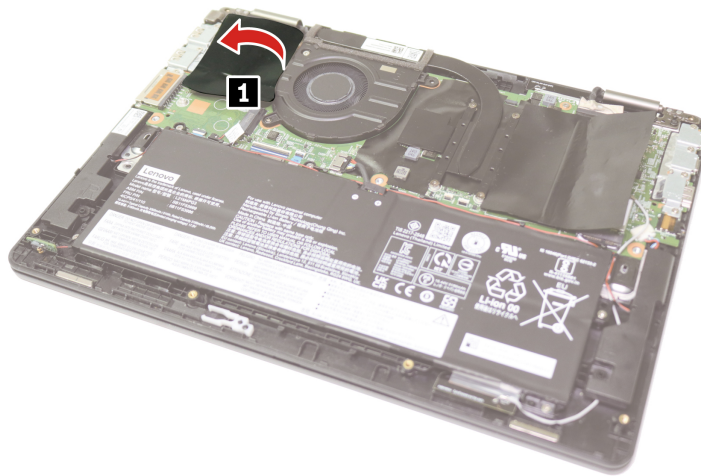



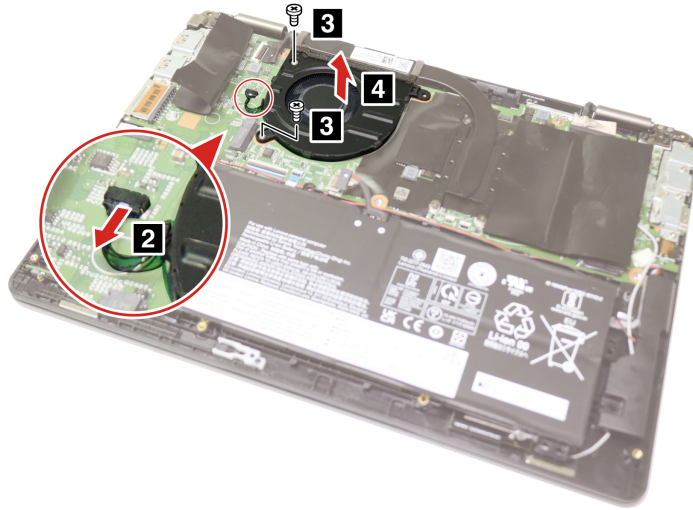

Step	Screw (quantity)	Color	Torque
<b>3</b>	M2 × 4 mm, flat-head, nylon-coated (2)	Silver	0.181 Nm (1.85 kgf-cm)

**When installing:**

- Ensure that the connector is attached firmly.
- Do not press the top of the fan cover and the fan hub.

## 1100 Built-in battery



**Use only the authorized battery specified for the computer. Any other battery could ignite or explode.**

**Important notice for replacing a battery**

**Attention:** Lenovo has no responsibility for the performance or safety of unauthorized batteries, and provides no warranties for failures or damage arising out of their use.

The Vantage app provides an automatic battery diagnostic test that determines if the built-in battery is defective. A built-in battery FRU should not be replaced unless this diagnostic test shows that the battery is defective. The only exception to this is if the built-in battery is physically damaged or a customer is reporting a possible safety issue.

If the Vantage app is not installed on the computer, the customer should download and install the program to diagnose the built-in battery, before getting a non-physically damaged built-in battery replaced. Note that the replacement of a physically damaged built-in battery is not covered by the warranty.

For access, remove this FRU:

- “1010 Base cover assembly” on page 35

## Removal steps of the built-in battery

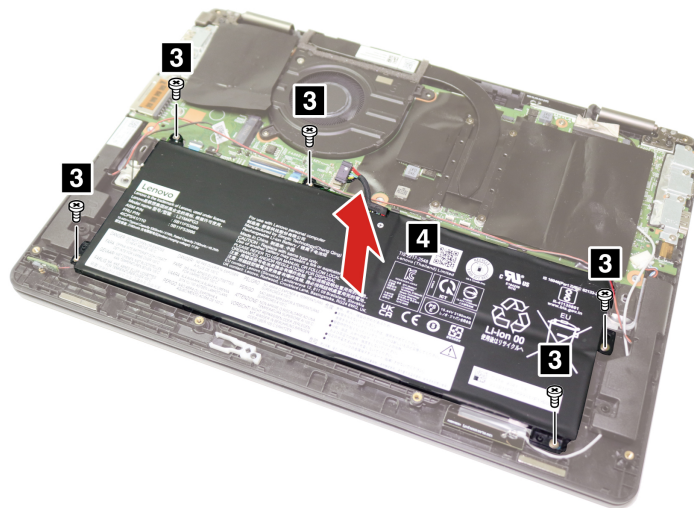
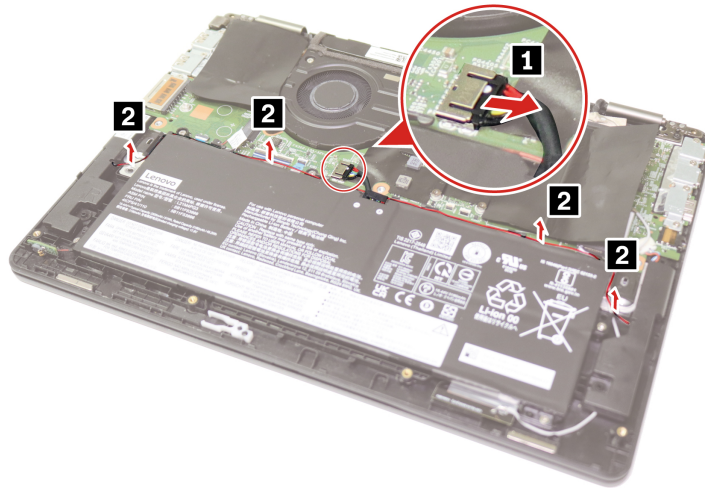

Step	Screw (quantity)	Color	Torque
<b>3</b>	M2 × 4 mm, flat-head, nylon-coated (5)	Silver	0.181 Nm (1.85 kgf-cm)

### When installing:

- Ensure that the connector is attached firmly.
- Ensure that the base cover assembly is secured in place. Otherwise, the battery connection may fail.
- When you route the cables, ensure that they are not subject to any tension. Tension could cause the cables to be damaged by the cable guides, or a wire to be broken.

## 1110 P-sensor cable (for selected models)

For access, remove these FRUs in order:

- “1010 Base cover assembly” on page 35
- “1100 Built-in battery” on page 43

### Removal steps of the P-sensor cable

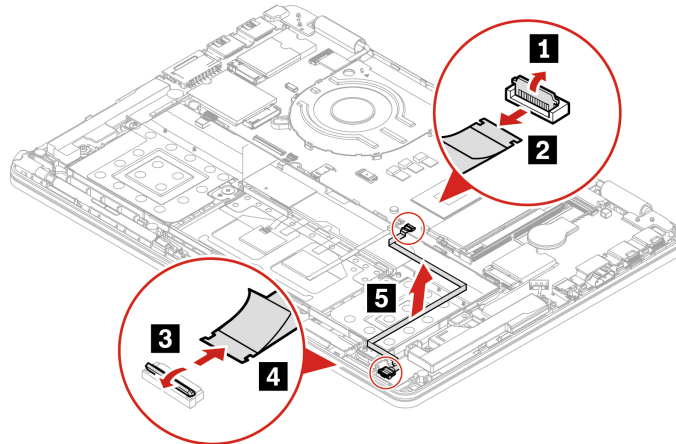

**When installing:** Ensure that the connectors are attached firmly.

## 1120 Lenovo Integrated Pen charge board and cable (for selected models)

For access, remove these FRUs in order:

- “1010 Base cover assembly” on page 35
- “1100 Built-in battery” on page 43

### Removal steps of the Lenovo Integrated Pen charge board and cable

**Note:** For wireless WAN models, additionally remove the wireless WAN antenna Cu foil assembly.

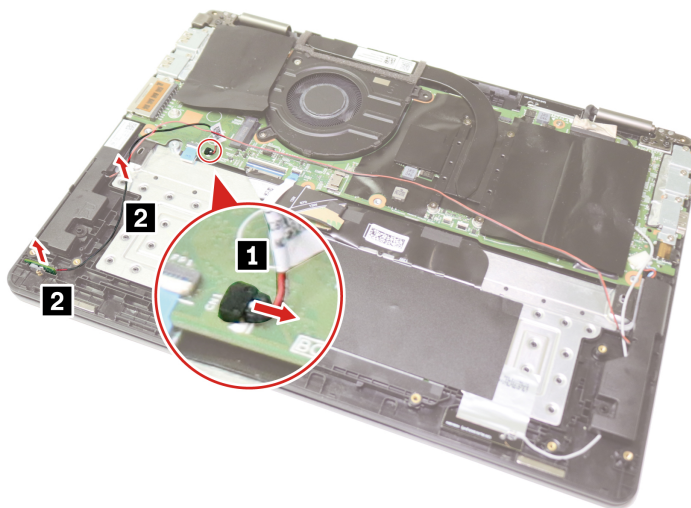

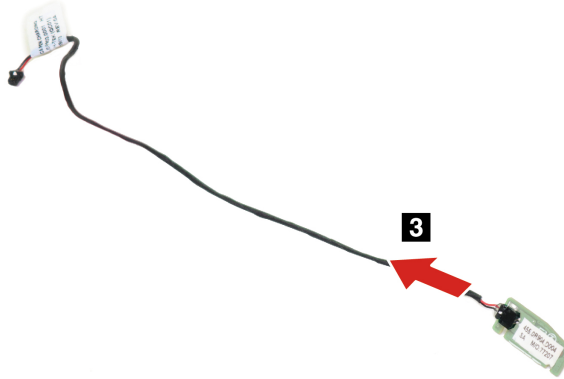

## 1130 I/O brackets

For access, remove this FRU:

- “1010 Base cover assembly” on page 35

### Removal steps of the I/O brackets

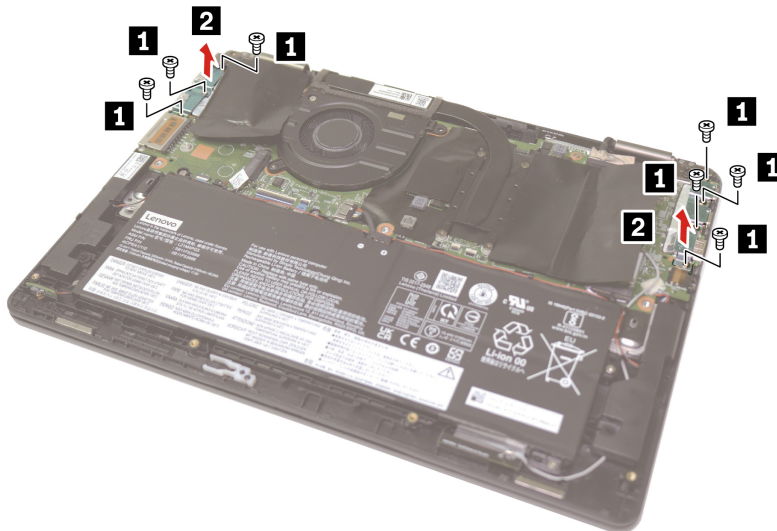

Step	Screw (quantity)	Color	Torque
<b>1</b>	M2 × 4 mm, flat-head, nylon-coated (7)	Silver	0.181 Nm (1.85 kgf-cm)

## 1140 System board

Important notices for handling the system board:

When handling the system board, read the following:

- Some components mounted on a system board are very sensitive. Improper handling of a system board can cause damage to those components, and may cause a system malfunction.
- The system board has an accelerometer, which can be broken when several thousands of G-forces are applied.

**Note:** Dropping a system board from a height of as little as 6 inches so that it falls flat on a hard bench can subject the accelerometer to as much as 6000 G's of shock.

- Be careful not to drop the system board on a bench top that has a hard surface, such as metal, wood, or composite.
- Avoid rough handling of any kind.
- At every point in the process, be sure not to drop or stack the system board.
- If you put a system board down, be sure to put it only on a padded surface such as an ESD mat or a corrugated conductive surface.
- Avoid bending a system board and hard pushing to prevent cracking at each BGA (Ball Grid Array) chipset.

For access, remove these FRUs in order:

- “1010 Base cover assembly” on page 35
- “1020 M.2 2242 solid-state drive” on page 36
- “1030 Wireless WAN card (for selected models)” on page 37
- “1040 Coin-cell battery” on page 38
- “1050 Memory module” on page 38
- “1060 Wireless LAN card” on page 39
- “1070 Heat sink” on page 40
- “1080 Rear camera and microphone module, bracket, and cable (for selected models)” on page 41
- “1090 Thermal fan” on page 42
- “1100 Built-in battery” on page 43
- “1110 P-sensor cable (for selected models)” on page 44
- “1130 I/O brackets” on page 46

### Removal steps of the system board

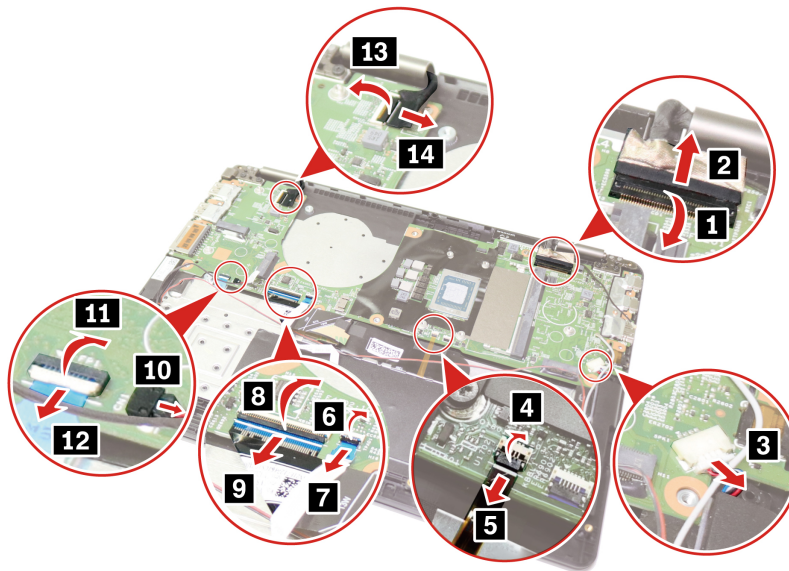

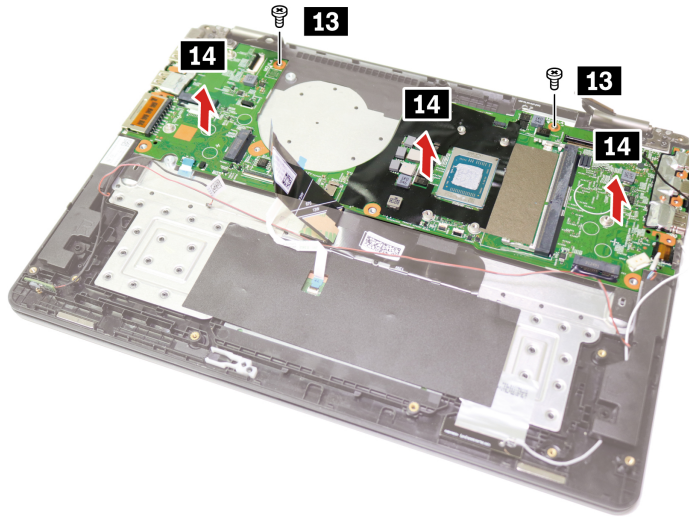

Step	Screw (quantity)	Color	Torque
<b>13</b>	M2 × 4 mm, flat head, nylon-coated (2)	Silver	0.181 Nm (1.85 kgf-cm)

**Note:** When replacing the system board, please ensure the thermal pads for heat sink below are well attached to the system board.

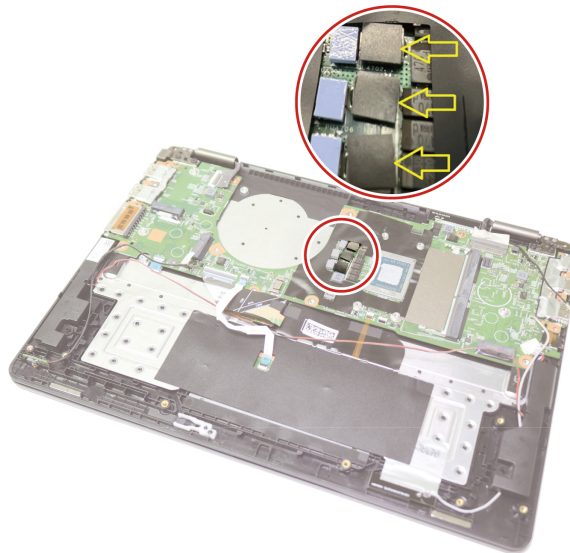

**When installing:** Ensure that the connectors are attached firmly.

## 1150 Power button with or without fingerprint reader

For access, remove these FRUs in order:

- “1010 Base cover assembly” on page 35
- “1140 System board” on page 46

## Removal steps of the power button with or without fingerprint reader

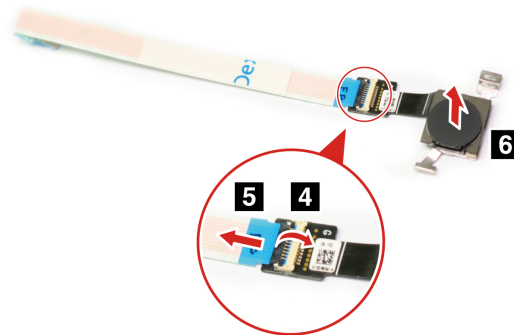
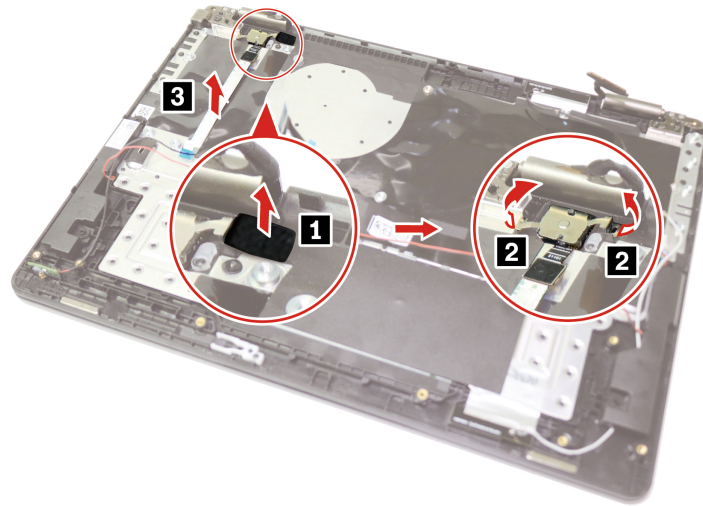

---

## 1160 Speaker assembly

For access, remove these FRUs in order:

- “1010 Base cover assembly” on page 35
- “1140 System board” on page 46

## Removal step of the speaker assembly

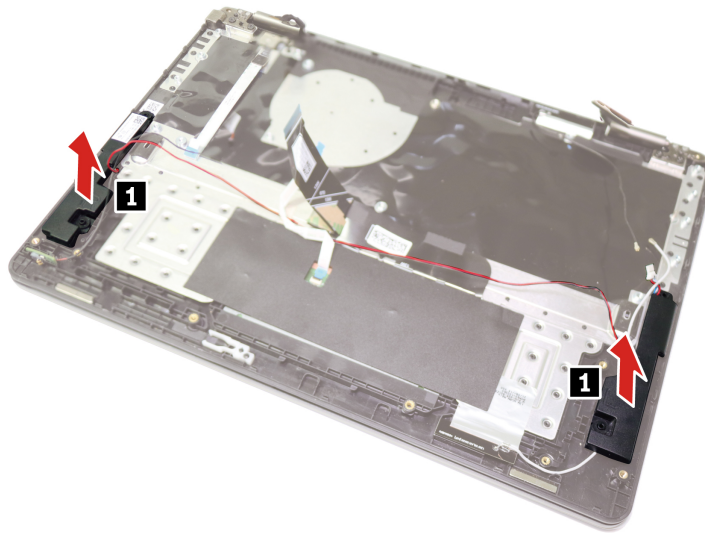

### When installing:

- Ensure that the connector is attached firmly.
- Ensure that the cable is routed properly.

---

## 1170 Trackpad and trackpad cable

For access, remove these FRUs in order:

- “1010 Base cover assembly” on page 35
- “1100 Built-in battery” on page 43

### Removal steps of the trackpad and trackpad cable

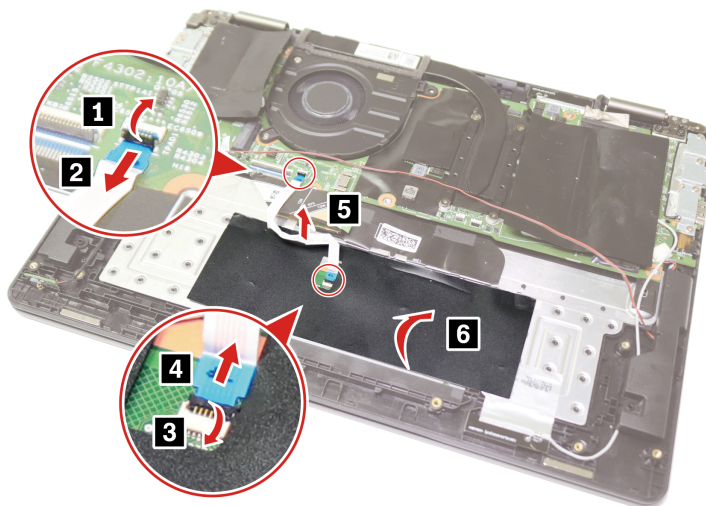



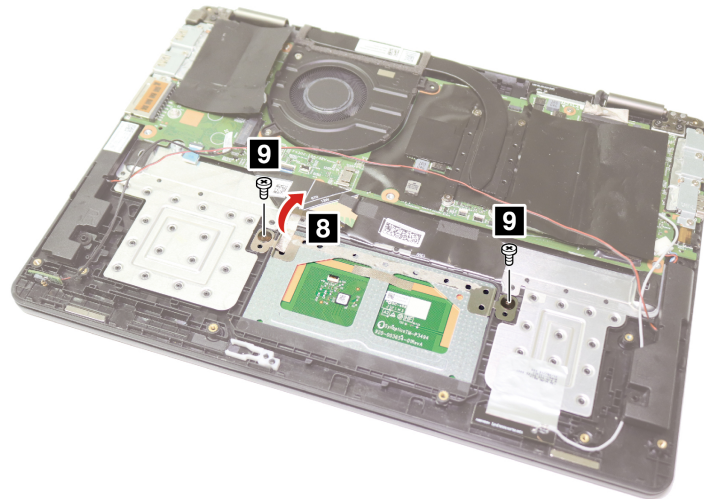
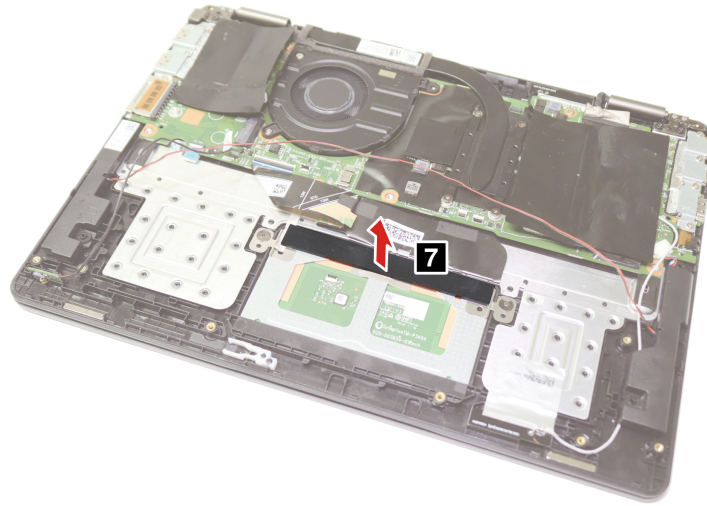

Step	Screw (quantity)	Color	Torque
9	M2 × 2.5 mm, flat-head, nylon-coated (2)	Black	0.181 Nm (1.85 kgf-cm)

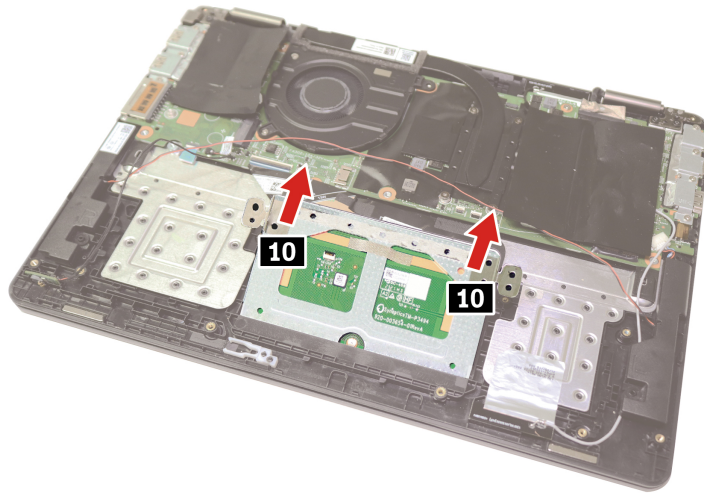

**When installing:**

- Install the trackpad in the direction as shown.

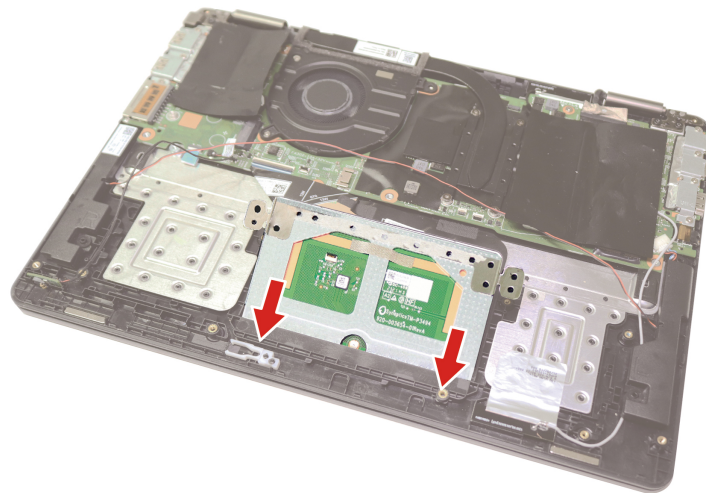

- Ensure that the trackpad waterproof mylar is attached after replacement.
- Ensure that the connector is attached firmly.

---

## 1180 LCD unit

For access, remove this FRU:

- “1010 Base cover assembly” on page 35

## Removal steps of the LCD unit

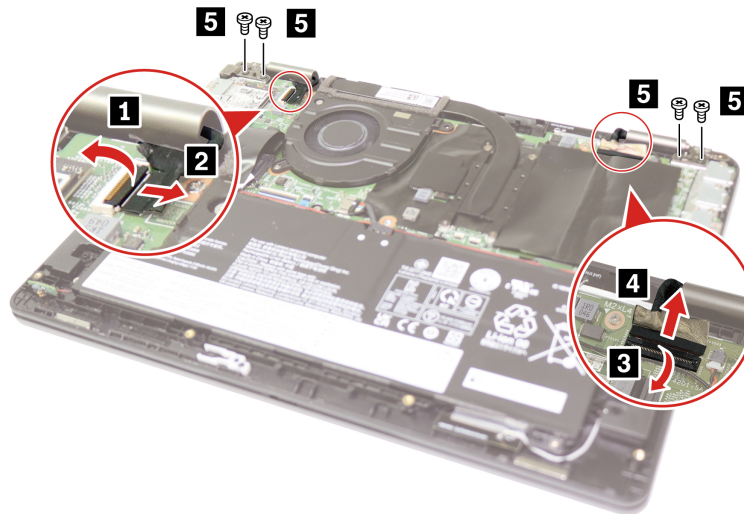

Step	Screw (quantity)	Color	Torque
5	M 2.5 × 5 mm, flat-head, nylon-coated (4)	Black	0.294 Nm (3.0 kgf-cm)

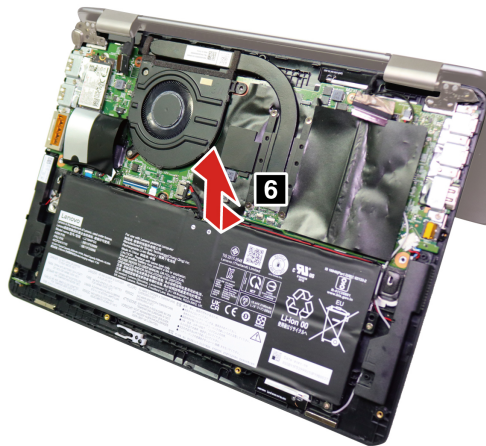

**When installing:** Ensure that the connectors are attached firmly.

## 1190 Keyboard assembly

For access, remove these FRUs in order:

- “1010 Base cover assembly” on page 35
- “1020 M.2 2242 solid-state drive” on page 36
- “1030 Wireless WAN card (for selected models)” on page 37
- “1040 Coin-cell battery” on page 38
- “1050 Memory module” on page 38

- “1060 Wireless LAN card” on page 39
- “1070 Heat sink” on page 40
- “1080 Rear camera and microphone module, bracket, and cable (for selected models)” on page 41
- “1090 Thermal fan” on page 42
- “1100 Built-in battery” on page 43
- “1110 P-sensor cable (for selected models)” on page 44
- “1120 Lenovo Integrated Pen charge board and cable (for selected models)” on page 45
- “1130 I/O brackets” on page 46
- “1140 System board” on page 46
- “1150 Power button with or without fingerprint reader” on page 48
- “1160 Speaker assembly” on page 49
- “1170 Trackpad and trackpad cable” on page 50
- “1180 LCD unit” on page 52

---

## 2010 LCD strip cover

For access, remove these FRUs in order:

- “1010 Base cover assembly” on page 35
- “1180 LCD unit” on page 52

### Removal step of the LCD strip cover



**When installing:** Ensure that all the latches are attached firmly.

---

## 2020 Touch module assembly

For access, remove these FRUs in order:

- “1010 Base cover assembly” on page 35
- “1180 LCD unit” on page 52
- “2010 LCD strip cover” on page 54

## Removal steps of the touch module assembly

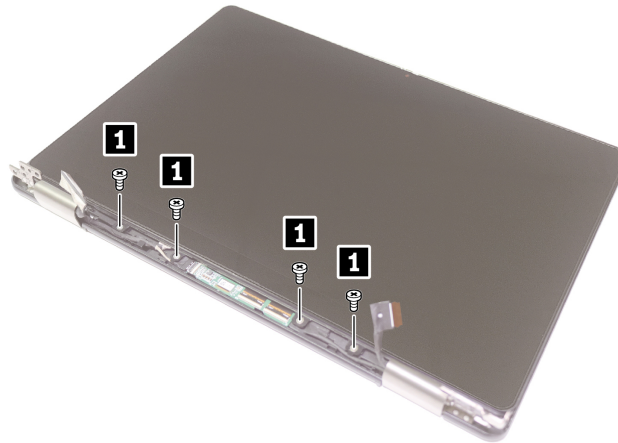

Step	Screw (quantity)	Color	Torque
1	M2 × 3 mm, flat-head, nylon-coated (4)	Sliver	0.181 Nm (1.85 kgf-cm)

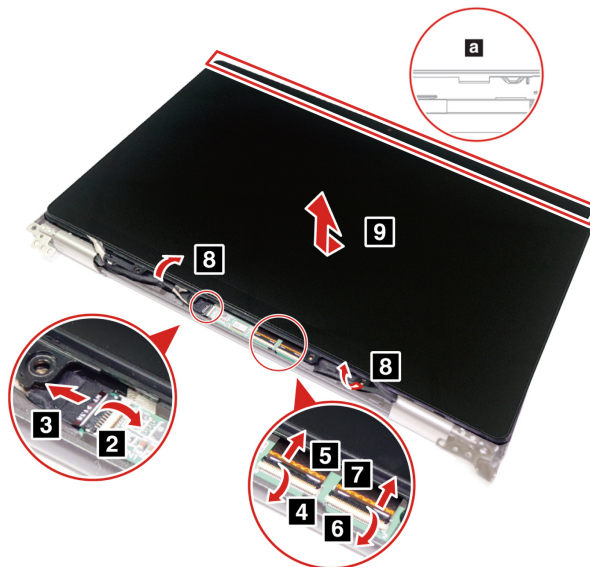

### Notes:

- In step 9, use your palms to slide down the LCD panel in the direction as shown to loosen its hooks a.
- Do not pry up the panel, or the hooks might get damaged.

**When installing:** Ensure that the connectors are attached firmly.

---

## 2030 LCD cable

For access, remove these FRUs in order:

- “1010 Base cover assembly” on page 35
- “1180 LCD unit” on page 52
- “2010 LCD strip cover” on page 54
- “2020 Touch module assembly” on page 54

### Removal steps of the LCD cable

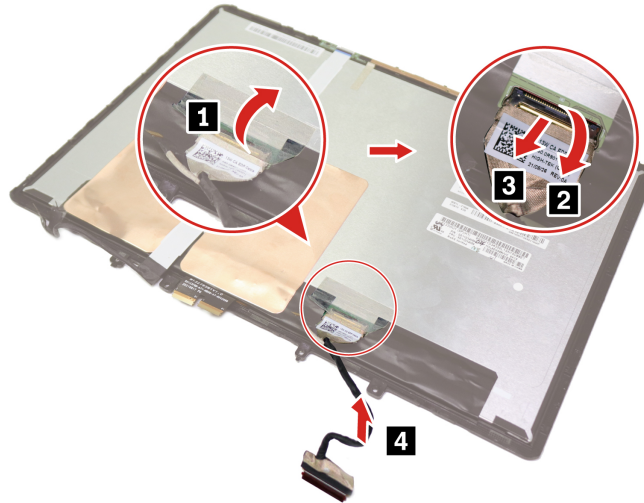

---

## 2040 LCD hinges

For access, remove these FRUs in order:

- “1010 Base cover assembly” on page 35
- “1180 LCD unit” on page 52
- “2010 LCD strip cover” on page 54
- “2020 Touch module assembly” on page 54

## Removal steps of the LCD hinges

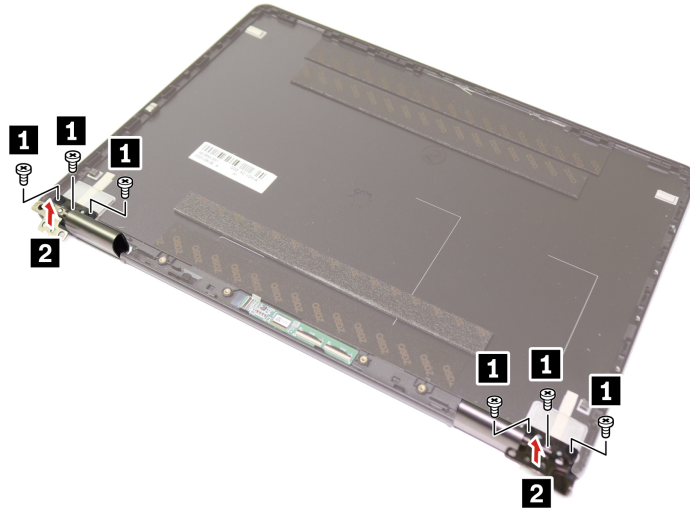

Step	Screw (quantity)	Color	Torque
<b>1</b>	M2.5 × 2.5 mm, flat-head, nylon-coated (6)	Black	0.294 Nm (3.0 kgf-cm)

## 2050 Camera and microphone module with microphone rubbers

For access, remove these FRUs in order:

- “1010 Base cover assembly” on page 35
- “1180 LCD unit” on page 52
- “2010 LCD strip cover” on page 54
- “2020 Touch module assembly” on page 54

### Removal steps of the camera and microphone module with microphone rubbers

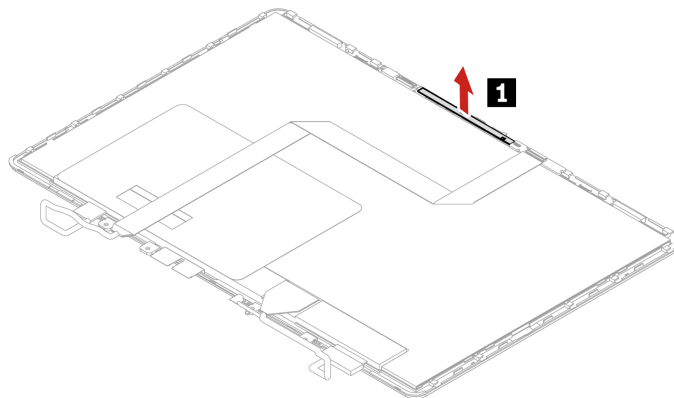

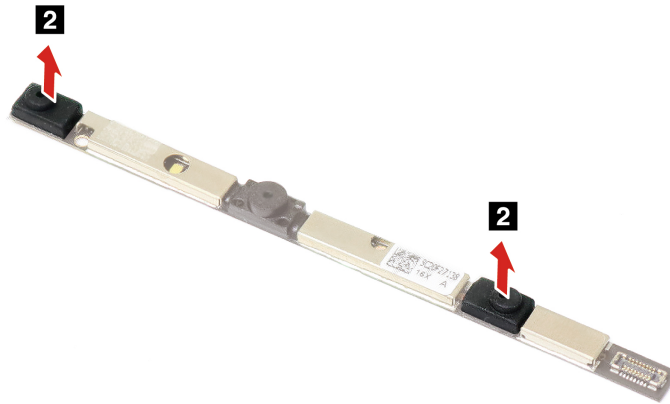

**Note:** When installing RGB Camera, ensure to paste a mylar on the hole mark **a**.



---

## 2060 Gravity sensor board and camera cable

For access, remove these FRUs in order:

- “1010 Base cover assembly” on page 35
- “1180 LCD unit” on page 52
- “2010 LCD strip cover” on page 54
- “2020 Touch module assembly” on page 54
- “2050 Camera and microphone module with microphone rubbers” on page 57



## Removal steps of the gravity sensor board and camera cable

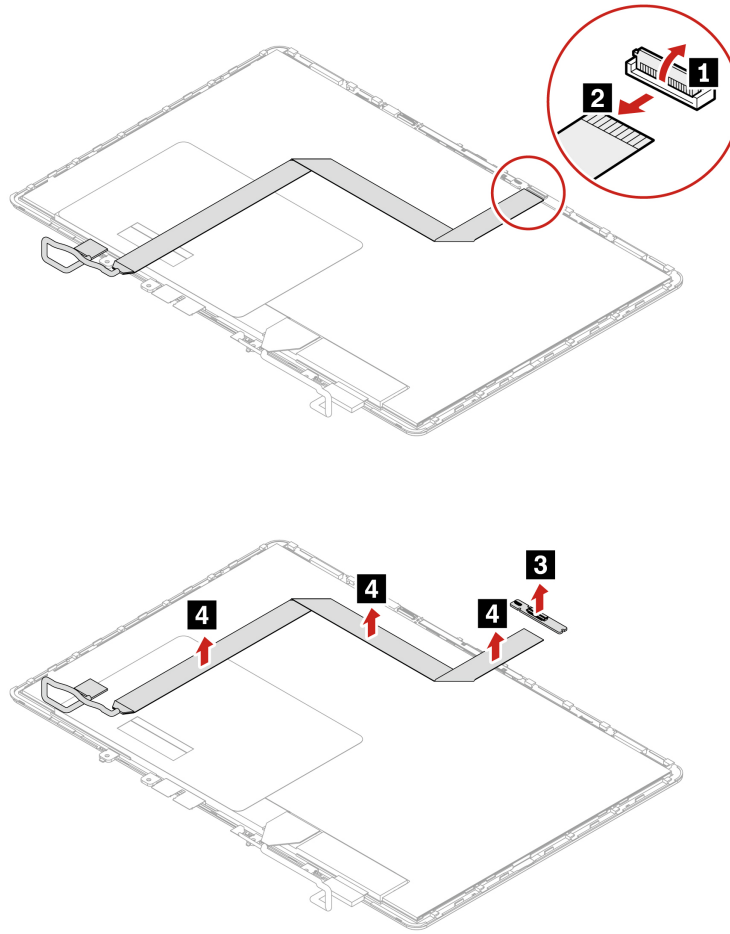

---

## 2070 LCD cover assembly

For access, remove these FRUs in order:

- “1010 Base cover assembly” on page 35
- “1180 LCD unit” on page 52
- “2010 LCD strip cover” on page 54
- “2020 Touch module assembly” on page 54
- “2040 LCD hinges” on page 56



---

## Appendix A. Notices

Lenovo may not offer the products, services, or features discussed in this document in all countries. Consult your local Lenovo representative for information on the products and services currently available in your area. Any reference to a Lenovo product, program, or service is not intended to state or imply that only that Lenovo product, program, or service may be used. Any functionally equivalent product, program, or service that does not infringe any Lenovo intellectual property right may be used instead. However, it is the user's responsibility to evaluate and verify the operation of any other product, program, or service.

Lenovo may have patents or pending patent applications covering subject matter described in this document. The furnishing of this document does not give you any license to these patents. You can send license inquiries, in writing, to:

*Lenovo (United States), Inc.  
8001 Development Drive  
Morrisville, NC 27560  
U.S.A.  
Attention: Lenovo Director of Licensing*

LENOVO PROVIDES THIS PUBLICATION "AS IS" WITHOUT WARRANTY OF ANY KIND, EITHER EXPRESS OR IMPLIED, INCLUDING, BUT NOT LIMITED TO, THE IMPLIED WARRANTIES OF NON-INFRINGEMENT, MERCHANTABILITY OR FITNESS FOR A PARTICULAR PURPOSE. Some jurisdictions do not allow disclaimer of express or implied warranties in certain transactions, therefore, this statement may not apply to you.

This information could include technical inaccuracies or typographical errors. Changes are periodically made to the information herein; these changes will be incorporated in new editions of the publication. Lenovo may make improvements and/or changes in the product(s) and/or the program(s) described in this publication at any time without notice.

The products described in this document are not intended for use in implantation or other life support applications where malfunction may result in injury or death to persons. The information contained in this document does not affect or change Lenovo product specifications or warranties. Nothing in this document shall operate as an express or implied license or indemnity under the intellectual property rights of Lenovo or third parties. All information contained in this document was obtained in specific environments and is presented as an illustration. The result obtained in other operating environments may vary.

Lenovo may use or distribute any of the information you supply in any way it believes appropriate without incurring any obligation to you.

Any references in this publication to non-Lenovo Web sites are provided for convenience only and do not in any manner serve as an endorsement of those Web sites. The materials at those Web sites are not part of the materials for this Lenovo product, and use of those Web sites is at your own risk.

Any performance data contained herein was determined in a controlled environment. Therefore, the result obtained in other operating environments may vary significantly. Some measurements may have been made on development-level systems and there is no guarantee that these measurements will be the same on generally available systems. Furthermore, some measurements may have been estimated through extrapolation. Actual results may vary. Users of this document should verify the applicable data for their specific environment.

---

## Trademarks

LENOVO and LENOVO logo are trademarks of Lenovo. Microsoft and Windows are trademarks of the Microsoft group of companies. The term HDMI is a trademark or registered trademark of HDMI Licensing LLC in the United States and other countries. USB-C is a registered trademark of USB Implementers Forum. All other trademarks are the property of their respective owners.

---

## Appendix B. Abbreviation table

The following table lists all abbreviations used in this manual.

Abbreviation	Term
BGA	Ball Grid Array
CMOS	Complementary Metal Oxide Semiconductor
CMV	Custom Model Variant
CRC	Cyclic redundancy check
CRT	Cathode ray tube
CRU	Customer Replaceable Unit
CTO	Configure To Order
EAIA	Enhanced Asset Information Area
EEPROM	Electrically Erasable Programmable Read-Only Memory
EFI	Extensible Firmware Interface
ESD	Electrostatic discharge
FRU	Field Replaceable Unit
GAV	General Announce Variant
IC	Integrated circuits
LCD	Liquid Crystal Display
MTM	Machine type and model
POST	Power-on self-test
RFID	Radio-frequency identification
SVP	Supervisor password
UUID	Universally unique identifier







Part Number: SP41G21795

Printed in China

(1P) P/N: SP41G21795

