

Precision 3660 Tower

Service Manual



Notes, cautions, and warnings

 **NOTE:** A NOTE indicates important information that helps you make better use of your product.

 **CAUTION:** A CAUTION indicates either potential damage to hardware or loss of data and tells you how to avoid the problem.

 **WARNING:** A WARNING indicates a potential for property damage, personal injury, or death.

Chapter 1: Working inside your computer	6
Safety instructions	6
Before working inside your computer	6
Safety precautions	7
Electrostatic discharge—ESD protection	7
ESD field service kit	8
Transporting sensitive components	9
After working inside your computer	9
Chapter 2: Removing and installing components	10
Recommended tools	10
Screw list	10
Major components of Precision 3660 Tower	10
Side cover	11
Removing the side cover	11
Installing the side cover	13
Front bezel	14
Installing the front bezel	14
Removing the front bezel	15
3.5 in. hard-drive assembly	16
Removing the 3.5-inch hard-disk drive assembly (Bay-1)	16
Removing the 3.5-inch hard-disk drive assembly (Bay-2)	17
Removing the 3.5-inch hard-disk drive bracket	18
Installing the 3.5-inch hard-disk drive bracket	19
Installing the 3.5-inch hard-disk drive assembly (Bay-2)	20
Installing the 3.5-inch hard-disk drive assembly (Bay-1)	21
Solid-state drive	22
Installing the M.2 2230 PCIe solid-state drive	22
Removing the M.2 2280 PCIe solid-state drive	22
Installing the M.2 2280 PCIe solid-state drive	23
Removing the M.2 2230 PCIe solid-state drive	24
WLAN card	25
Removing the WLAN card	25
Installing the WLAN card	26
WLAN antenna	28
Removing the WLAN antenna	28
Installing the WLAN antenna	29
Coin-cell battery	30
Removing the coin-cell battery	30
Installing the coin-cell battery	30
Memory module	31
Removing the memory module	31
Installing the memory module	32
GPU end holder	33











Removing GPU end holder.....	33
Installing the GPU end holder.....	34
Expansion card.....	35
Removing the graphics card.....	35
Installing the graphics card.....	36
Removing the powered GPU.....	37
Installing the powered GPU.....	39
Power-supply unit.....	40
Removing the power-supply unit.....	40
Installing the power-supply unit.....	41
Processor fan and heat-sink assembly.....	43
Removing the processor fan and 125 W heat-sink assembly.....	43
Installing the processor fan and 125 W heat-sink assembly.....	44
Removing the processor fan.....	45
Installing the processor fan.....	45
Removing the processor fan and 65 W heat-sink assembly.....	46
Installing the processor fan and 65 W heat-sink assembly.....	47
Liquid cooler.....	48
Removing the liquid cooler.....	48
Installing the liquid cooler.....	50
Processor.....	51
Removing the processor.....	51
Installing the processor.....	52
Chassis fan.....	53
Removing the front fan.....	53
Removing front fan cage.....	54
Installing the front fan cage.....	55
Installing the front fan.....	56
Removing the rear fan.....	57
Installing the rear fan.....	58
Power button.....	59
Removing the power button.....	59
Installing the power button.....	60
Intrusion switch.....	61
Removing the intrusion switch.....	61
Installing the intrusion switch.....	62
Intrusion speaker.....	63
Removing the intrusion speaker.....	63
Installing the intrusion speaker.....	64
System board.....	65
Removing the system board.....	65
Installing the system board.....	70
Chapter 3: Software.....	74
Drivers and downloads.....	74
Chapter 4: System setup.....	75
Boot menu.....	75
Navigation keys.....	75

Boot Sequence.....	76
System setup options.....	76
Updating the BIOS.....	85
Updating the BIOS in Windows.....	85
Updating the BIOS in Linux and Ubuntu.....	85
Updating the BIOS using the USB drive in Windows.....	86
Updating the BIOS from the F12 One-Time boot menu.....	86
System and setup password.....	87
Assigning a system setup password.....	87
Deleting or changing an existing system setup password.....	88
Chapter 5: Troubleshooting.....	89
System Limitations.....	89
SupportAssist diagnostics.....	90
Diagnostic LED behavior.....	90
Recovering the operating system.....	91
Updating the BIOS in Windows.....	92
Updating the BIOS using the USB drive in Windows.....	92
Backup media and recovery options.....	92
WiFi power cycle.....	92
Drain residual flea power (perform hard reset).....	93
Chapter 6: Getting help and contacting Dell.....	94

Working inside your computer



Safety instructions

Use the following safety guidelines to protect your computer from potential damage and to ensure your personal safety. Unless otherwise noted, each procedure included in this document assumes that you have read the safety information that shipped with your computer.

-  **WARNING:** Before working inside your computer, read the safety information that is shipped with your computer. For more safety best practices, see the Regulatory Compliance home page at www.dell.com/regulatory_compliance.
-  **WARNING:** Disconnect your computer from all power sources before opening the computer cover or panels. After you finish working inside the computer, replace all covers, panels, and screws before connecting your computer to an electrical outlet.
-  **CAUTION:** To avoid damaging the computer, ensure that the work surface is flat, dry, and clean.
-  **CAUTION:** To avoid damaging the components and cards, handle them by their edges, and avoid touching the pins and the contacts.
-  **CAUTION:** You should only perform troubleshooting and repairs as authorized or directed by the Dell technical assistance team. Damage due to servicing that is not authorized by Dell is not covered by your warranty. See the safety instructions that is shipped with the product or at www.dell.com/regulatory_compliance.
-  **CAUTION:** Before touching anything inside your computer, ground yourself by touching an unpainted metal surface, such as the metal at the back of the computer. While you work, periodically touch an unpainted metal surface to dissipate static electricity which could harm internal components.
-  **CAUTION:** When you disconnect a cable, pull it by its connector or its pull tab, not the cable itself. Some cables have connectors with locking tabs or thumbscrews that you must disengage before disconnecting the cable. When disconnecting cables, keep them evenly aligned to avoid bending the connector pins. When connecting cables, ensure that the ports and the connectors are correctly oriented and aligned.
-  **CAUTION:** Press and eject any installed card from the media-card reader.
-  **CAUTION:** Exercise caution when handling Lithium-ion batteries in laptops. Swollen batteries should not be used and should be replaced and disposed properly.
-  **NOTE:** The color of your computer and certain components may appear differently than shown in this document.

Before working inside your computer

Steps

1. Save and close all open files and exit all open applications.
2. Shut down your computer. Click **Start** >  **Power** > **Shut down**.
 -  **NOTE:** If you are using a different operating system, see the documentation of your operating system for shut-down instructions.
3. Disconnect your computer and all attached devices from their electrical outlets.
4. Disconnect all attached network devices and peripherals, such as keyboard, mouse, and monitor from your computer.

5. Remove any media card and optical disc from your computer, if applicable.
6. After the computer is unplugged, press and hold the power button for 5 seconds to ground the system board.

 **CAUTION: Place the computer on a flat, soft, and clean surface to avoid scratches on the display.**

7. Place the computer face down.

Safety precautions

The safety precautions chapter details the primary steps to be taken before performing any disassembly instructions.

Observe the following safety precautions before you perform any installation or break/fix procedures involving disassembly or reassembly:

- Turn off the system and all attached peripherals.
- Disconnect the system and all attached peripherals from AC power.
- Disconnect all network cables, telephone, and telecommunications lines from the system.
- Use an ESD field service kit when working inside any tablet/notebook/desktop to avoid electrostatic discharge (ESD) damage.
- After removing any system component, carefully place the removed component on an anti-static mat.
- Wear shoes with non-conductive rubber soles to reduce the chance of getting electrocuted.

Standby power

Dell products with standby power must be unplugged before you open the case. Systems that incorporate standby power are essentially powered while turned off. The internal power enables the system to be remotely turned on (wake on LAN) and suspended into a sleep mode and has other advanced power management features.

Unplugging, pressing and holding the power button for 15 seconds should discharge residual power in the system board.

Bonding

Bonding is a method for connecting two or more grounding conductors to the same electrical potential. This is done through the use of a field service electrostatic discharge (ESD) kit. When connecting a bonding wire, ensure that it is connected to bare metal and never to a painted or non-metal surface. The wrist strap should be secure and in full contact with your skin, and ensure that you remove all jewelry such as watches, bracelets, or rings prior to bonding yourself and the equipment.

Electrostatic discharge—ESD protection

ESD is a major concern when you handle electronic components, especially sensitive components such as expansion cards, processors, memory DIMMs, and system boards. Very slight charges can damage circuits in ways that may not be obvious, such as intermittent problems or a shortened product life span. As the industry pushes for lower power requirements and increased density, ESD protection is an increasing concern.

Due to the increased density of semiconductors used in recent Dell products, the sensitivity to static damage is now higher than in previous Dell products. For this reason, some previously approved methods of handling parts are no longer applicable.

Two recognized types of ESD damage are catastrophic and intermittent failures.

- **Catastrophic** – Catastrophic failures represent approximately 20 percent of ESD-related failures. The damage causes an immediate and complete loss of device functionality. An example of catastrophic failure is a memory DIMM that has received a static shock and immediately generates a "No POST/No Video" symptom with a beep code emitted for missing or nonfunctional memory.
- **Intermittent** – Intermittent failures represent approximately 80 percent of ESD-related failures. The high rate of intermittent failures means that most of the time when damage occurs, it is not immediately recognizable. The DIMM receives a static shock, but the tracing is merely weakened and does not immediately produce outward symptoms related to the damage. The weakened trace may take weeks or months to melt, and in the meantime may cause degradation of memory integrity, intermittent memory errors, etc.

The more difficult type of damage to recognize and troubleshoot is the intermittent (also called latent or "walking wounded") failure.

Perform the following steps to prevent ESD damage:

- Use a wired ESD wrist strap that is properly grounded. The use of wireless anti-static straps is no longer allowed; they do not provide adequate protection. Touching the chassis before handling parts does not ensure adequate ESD protection on parts with increased sensitivity to ESD damage.
- Handle all static-sensitive components in a static-safe area. If possible, use anti-static floor pads and workbench pads.
- When unpacking a static-sensitive component from its shipping carton, do not remove the component from the anti-static packing material until you are ready to install the component. Before unwrapping the anti-static packaging, ensure that you discharge static electricity from your body.
- Before transporting a static-sensitive component, place it in an anti-static container or packaging.

ESD field service kit

The unmonitored Field Service kit is the most commonly used service kit. Each Field Service kit includes three main components: anti-static mat, wrist strap, and bonding wire.

Components of an ESD field service kit

The components of an ESD field service kit are:

- **Anti-Static Mat** – The anti-static mat is dissipative and parts can be placed on it during service procedures. When using an anti-static mat, your wrist strap should be snug and the bonding wire should be connected to the mat and to any bare metal on the system being worked on. Once deployed properly, service parts can be removed from the ESD bag and placed directly on the mat. ESD-sensitive items are safe in your hand, on the ESD mat, in the system, or inside a bag.
- **Wrist Strap and Bonding Wire** – The wrist strap and bonding wire can be either directly connected between your wrist and bare metal on the hardware if the ESD mat is not required, or connected to the anti-static mat to protect hardware that is temporarily placed on the mat. The physical connection of the wrist strap and bonding wire between your skin, the ESD mat, and the hardware is known as bonding. Use only Field Service kits with a wrist strap, mat, and bonding wire. Never use wireless wrist straps. Always be aware that the internal wires of a wrist strap are prone to damage from normal wear and tear, and must be checked regularly with a wrist strap tester in order to avoid accidental ESD hardware damage. It is recommended to test the wrist strap and bonding wire at least once per week.
- **ESD Wrist Strap Tester** – The wires inside of an ESD strap are prone to damage over time. When using an unmonitored kit, it is a best practice to regularly test the strap prior to each service call, and at a minimum, test once per week. A wrist strap tester is the best method for doing this test. If you do not have your own wrist strap tester, check with your regional office to find out if they have one. To perform the test, plug the wrist-strap's bonding-wire into the tester while it is strapped to your wrist and push the button to test. A green LED is lit if the test is successful; a red LED is lit and an alarm sounds if the test fails.
- **Insulator Elements** – It is critical to keep ESD sensitive devices, such as plastic heat sink casings, away from internal parts that are insulators and often highly charged.
- **Working Environment** – Before deploying the ESD Field Service kit, assess the situation at the customer location. For example, deploying the kit for a server environment is different than for a desktop or portable environment. Servers are typically installed in a rack within a data center; desktops or portables are typically placed on office desks or cubicles. Always look for a large open flat work area that is free of clutter and large enough to deploy the ESD kit with additional space to accommodate the type of system that is being repaired. The workspace should also be free of insulators that can cause an ESD event. On the work area, insulators such as Styrofoam and other plastics should always be moved at least 12 inches or 30 centimeters away from sensitive parts before physically handling any hardware components
- **ESD Packaging** – All ESD-sensitive devices must be shipped and received in static-safe packaging. Metal, static-shielded bags are preferred. However, you should always return the damaged part using the same ESD bag and packaging that the new part arrived in. The ESD bag should be folded over and taped shut and all the same foam packing material should be used in the original box that the new part arrived in. ESD-sensitive devices should be removed from packaging only at an ESD-protected work surface, and parts should never be placed on top of the ESD bag because only the inside of the bag is shielded. Always place parts in your hand, on the ESD mat, in the system, or inside an anti-static bag.
- **Transporting Sensitive Components** – When transporting ESD sensitive components such as replacement parts or parts to be returned to Dell, it is critical to place these parts in anti-static bags for safe transport.

ESD protection summary

It is recommended that all field service technicians use the traditional wired ESD grounding wrist strap and protective anti-static mat at all times when servicing Dell products. In addition, it is critical that technicians keep sensitive parts separate from all insulator parts while performing service and that they use anti-static bags for transporting sensitive components.

Transporting sensitive components

When transporting ESD sensitive components such as replacement parts or parts to be returned to Dell, it is critical to place these parts in anti-static bags for safe transport.

Lifting equipment

Adhere to the following guidelines when lifting heavy weight equipment:

 **CAUTION: Do not lift greater than 50 pounds. Always obtain additional resources or use a mechanical lifting device.**

1. Get a firm balanced footing. Keep your feet apart for a stable base, and point your toes out.
2. Tighten stomach muscles. Abdominal muscles support your spine when you lift, offsetting the force of the load.
3. Lift with your legs, not your back.
4. Keep the load close. The closer it is to your spine, the less force it exerts on your back.
5. Keep your back upright, whether lifting or setting down the load. Do not add the weight of your body to the load. Avoid twisting your body and back.
6. Follow the same techniques in reverse to set the load down.

After working inside your computer

About this task

 **NOTE:** Leaving stray or loose screws inside your computer may severely damage your computer.

Steps

1. Replace all screws and ensure that no stray screws remain inside your computer.
2. Connect any external devices, peripherals, or cables you removed before working on your computer.
3. Replace any media cards, discs, or any other parts that you removed before working on your computer.
4. Connect your computer and all attached devices to their electrical outlets.
5. Turn on your computer.

Removing and installing components

NOTE: The images in this document may differ from your computer depending on the configuration you ordered.

Recommended tools

The procedures in this document may require the following tools:

- Phillips screwdriver #0
- Phillips screwdriver #1
- Plastic scribe





Screw list

NOTE: When removing screws from a component, it is recommended to note the screw type, the quantity of screws, and then place them in a screw storage box. This is to ensure that the correct number of screws and correct screw type is restored when the component is replaced.

NOTE: Some computers have magnetic surfaces. Ensure that the screws are not left attached to such surfaces when replacing a component.

NOTE: Screw color may vary with the configuration ordered.

Table 1. Screw list

Component	Screw type	Quantity	Screw image
M.2 2230/2280 Solid-state drive	M2x3.5	1	
WLAN card	M2x3.5	1	
Power supply unit	#6-32	4	
Processor fan and heat-sink assembly	Captive screw	4	
VR heat sink	Captive screw	2	
Liquid cooler (optional)	Captive screw	4	
System board	#6-32	9	

Major components of Precision 3660 Tower

The following image shows the major components of Precision 3660 Tower.

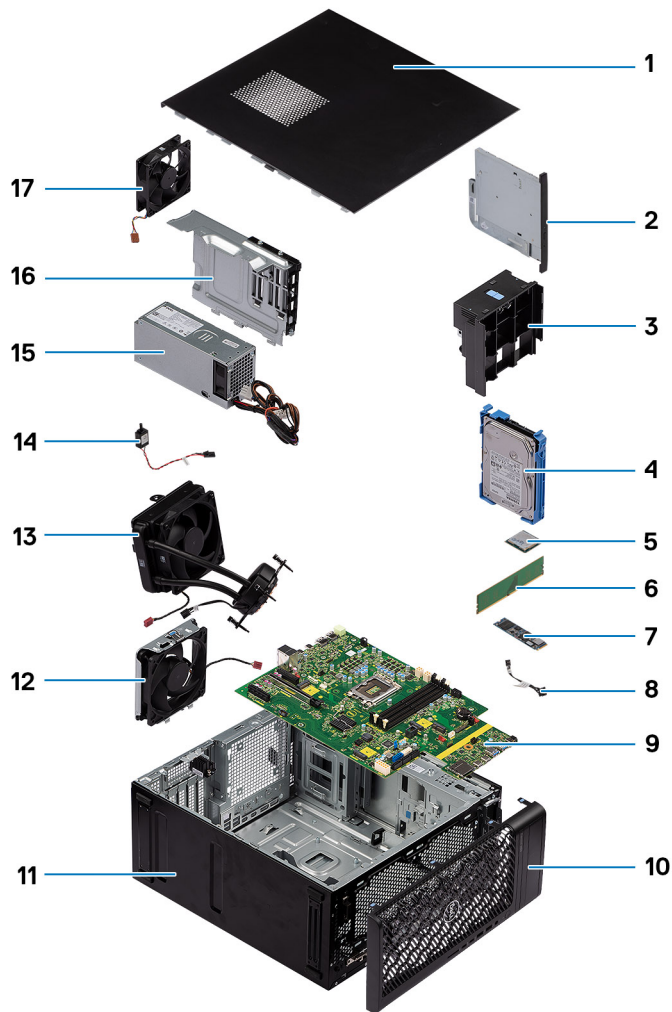

- | | |
|-------------------------------|-----------------------------|
| 1. Side cover | 2. Slim ODD |
| 3. Air duct | 4. 3.5-inch hard-disk drive |
| 5. WLAN card | 6. Memory module |
| 7. M.2 2280 solid-state drive | 8. Power button |
| 9. System board | 10. Front bezel |
| 11. System chassis | 12. System fan |
| 13. Liquid cooler | 14. Intrusion switch |
| 15. Power supply unit | 16. Power supply unit cover |
| 17. System fan | |

i **NOTE:** Dell provides a list of components and their part numbers for the original system configuration purchased. These parts are available according to warranty coverages purchased by the customer. Contact your Dell sales representative for purchase options.

Side cover

Removing the side cover

Prerequisites

1. Follow the procedure in [before working inside your computer](#).

i **NOTE:** Ensure that you remove the security cable from the security-cable slot (if applicable).

About this task

The following images indicate the location of the side cover and provide a visual representation of the removal procedure.



1x

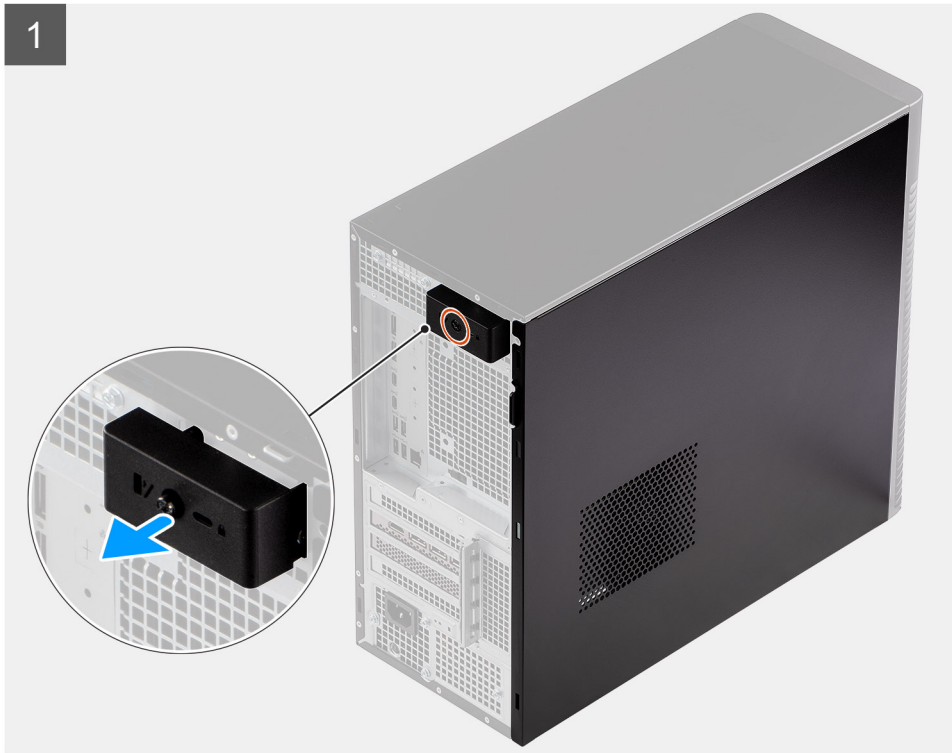

Steps

1. Loosen the single captive screw that secures the side cover to the computer.
2. Pull the release latch to release the cover from the computer.
3. Open the side cover towards the side of the computer and lift the cover away from the chassis.

Installing the side cover

Prerequisites

If you are replacing a component, remove the existing component before performing the installation procedure.

About this task

The following images indicate the location of the side cover and provides a visual representation of the installation procedure.



1x



2



Steps

1. Align the tabs on the side cover with the slots on the chassis.
2. Press the side cover towards the side of the computer to install it.
3. The release latch automatically locks the side cover to the computer.
4. Tighten the single captive screw to secure the side cover to the computer.

Next steps

1. Follow the procedure in [after working inside your computer](#).

Front bezel

Installing the front bezel

Prerequisites

If you are replacing a component, remove the existing component before performing the installation procedure.

About this task

The following images indicate the location of the front bezel and provides a visual representation of the installation procedure.

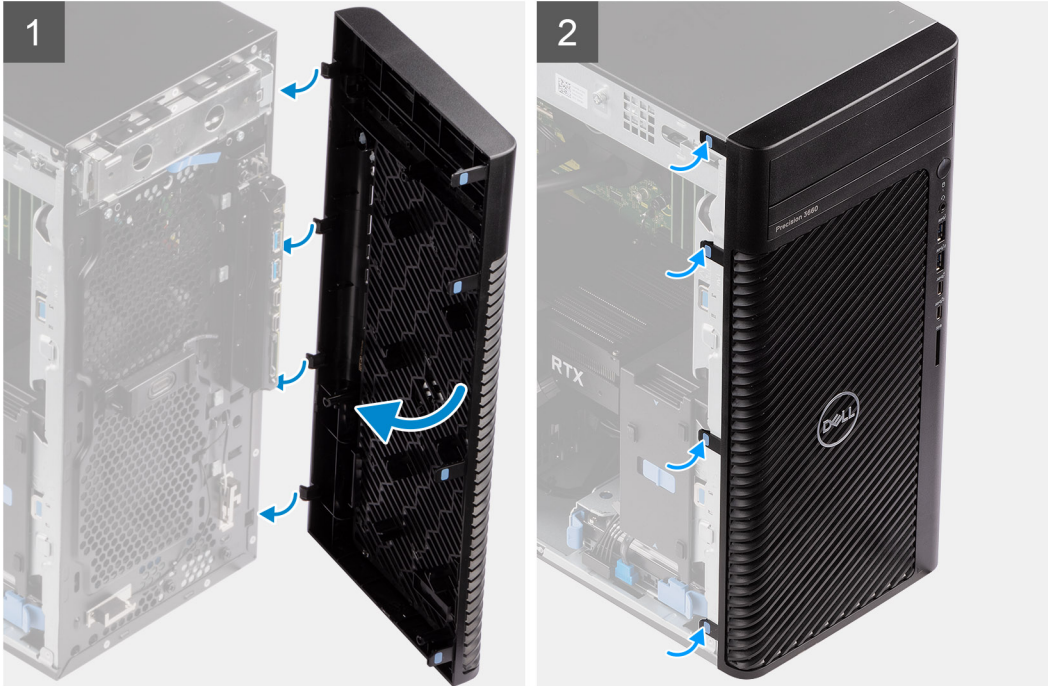

Steps

1. Position the front bezel to align the tabs on the bezel with the slots on the chassis.
2. Press the bezel until the tabs clicks into place.

Next steps

1. Install the [side cover](#).
2. Follow the procedure in [after working inside your computer](#).

Removing the front bezel

Prerequisites

1. Follow the procedure in [before working inside your computer](#).
2. Remove the [side cover](#).

About this task

The following images indicate the location of the front bezel and provide a visual representation of the removal procedure.

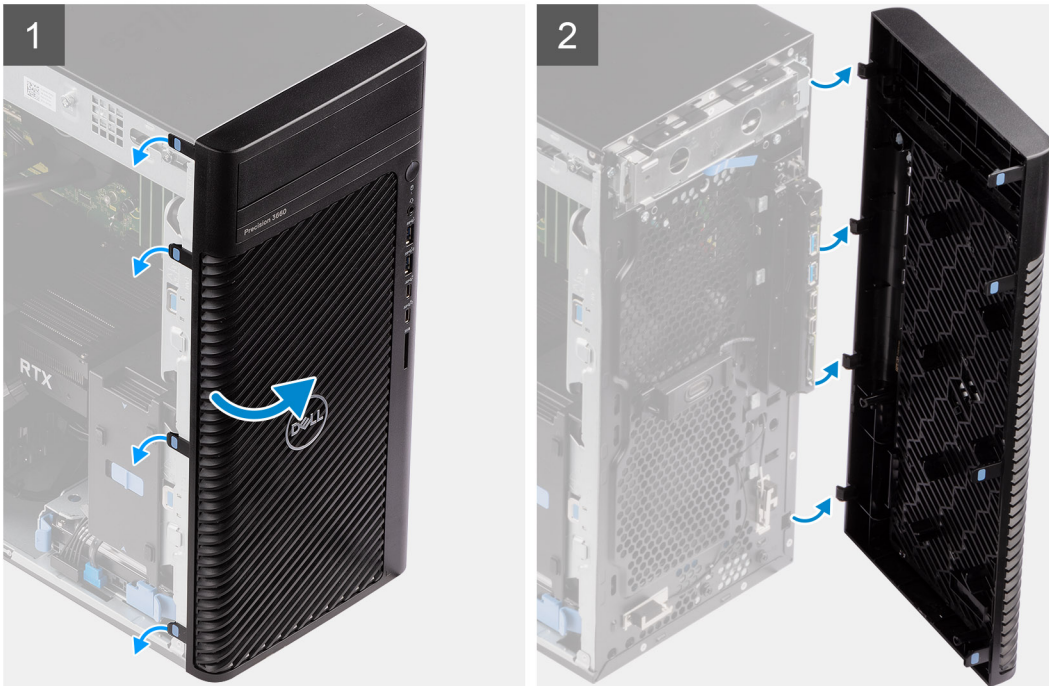

Steps

1. Pry the retention tabs to release the front bezel from the computer.
2. Slightly pull the front bezel and gently rotate to release the other tabs on the bezel from the slots in the computer chassis.
3. Remove the front bezel from the computer.

3.5 in. hard-drive assembly

Removing the 3.5-inch hard-disk drive assembly (Bay-1)

Prerequisites

1. Follow the procedure in [before working inside your computer](#).
2. Remove the [side cover](#).
3. Remove the [front bezel](#).

About this task

The following images indicate the location of the 3.5-inch hard-disk drive assembly and provide a visual representation of the removal procedure.

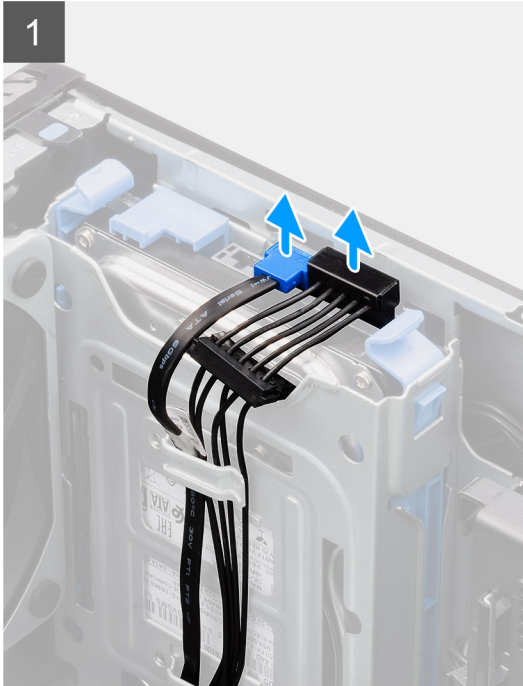
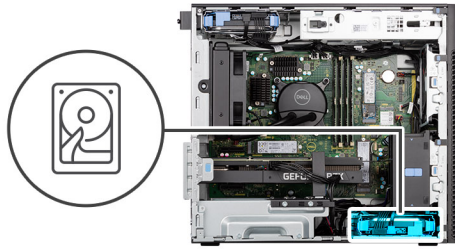

Steps

1. Disconnect the data and power cables from the 3.5-inch hard-disk drive module.
2. Press the securing tabs to release the hard-disk drive assembly from the chassis.
3. Slide the hard-disk drive assembly away from the chassis.

Removing the 3.5-inch hard-disk drive assembly (Bay-2)

Prerequisites

1. Follow the procedure in [before working inside your computer](#).
2. Remove the [side cover](#).
3. Remove the [front bezel](#).

About this task

The following images indicate the location of the 3.5-inch hard-disk drive assembly and provide a visual representation of the removal procedure.

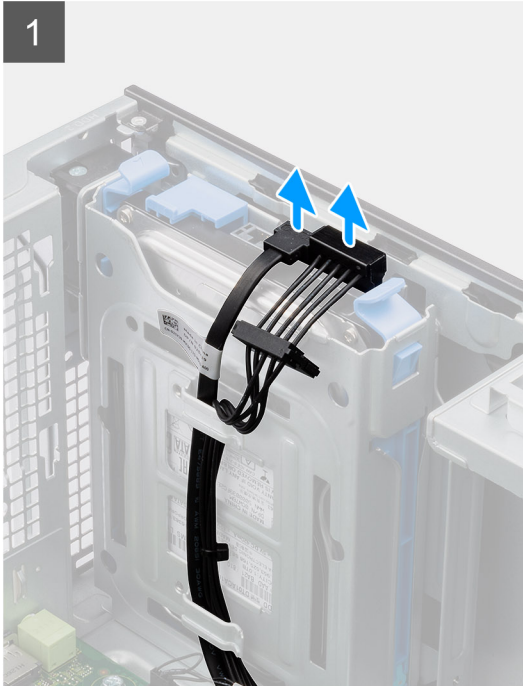
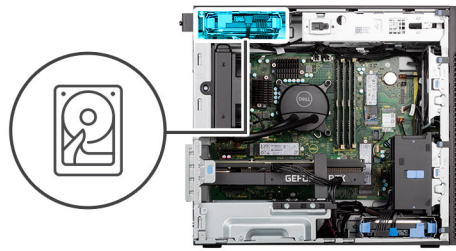

Steps

1. Disconnect the data and power cables from the 3.5-inch hard-disk drive module.
2. Press the securing tabs to release the hard-disk drive assembly from the chassis.
3. Slide the hard-disk drive assembly away from the chassis.

Removing the 3.5-inch hard-disk drive bracket

Prerequisites

1. Follow the procedure in [before working inside your computer](#).
2. Remove the [side cover](#).
3. Remove the [3.5-inch hard-disk drive assembly](#).

About this task

The following images indicate the location of the 3.5-inch hard-disk drive bracket and provides a visual representation of the removal procedure.

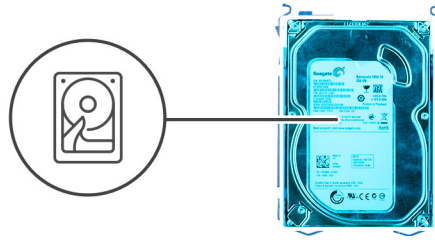

Steps

1. Pry both sides of the hard-disk drive bracket edge to release the tabs on the bracket from the slots on the hard-disk drive.
2. Lift and remove the hard-disk drive off the hard-disk drive bracket.

Installing the 3.5-inch hard-disk drive bracket

Prerequisites

If you are replacing a component, remove the existing component before performing the installation procedure.

About this task

The following images indicate the location of the 3.5-inch hard-disk drive bracket and provides a visual representation of the installation procedure.

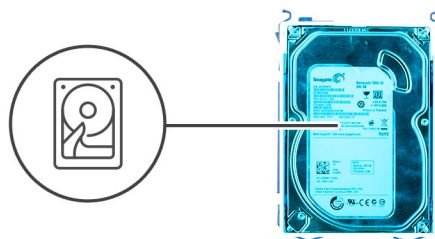

Steps

1. Place the hard-disk drive into the hard-disk drive bracket and align the tabs on the bracket with the slots on the hard-disk drive.
2. Snap the hard-disk drive into the hard-disk drive bracket.

Next steps

1. Install the [3.5-inch hard-disk drive assembly](#).
2. Install the [side cover](#).
3. Follow the procedure in [after working inside your computer](#).

Installing the 3.5-inch hard-disk drive assembly (Bay-2)

Prerequisites

If you are replacing a component, remove the existing component before performing the installation procedure.

About this task

The following images indicate the location of the 3.5-inch hard-disk drive assembly and provides a visual representation of the installation procedure.

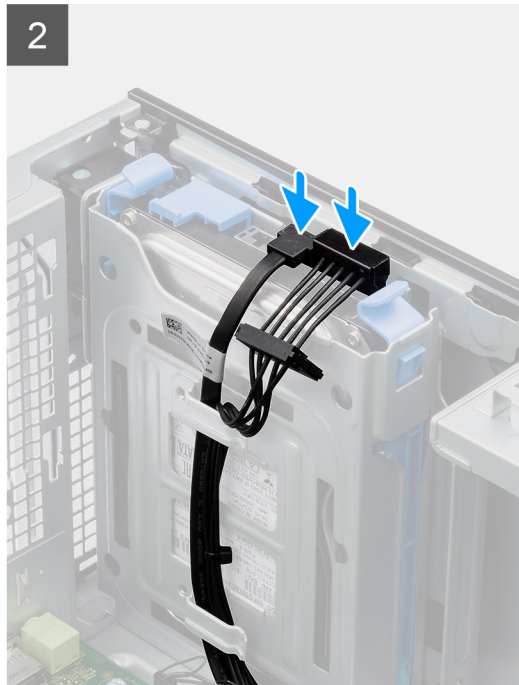
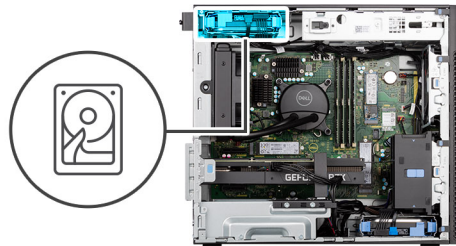

Steps

1. Slide and insert the 3.5-inch hard-disk drive assembly into the hard-disk drive slot.
2. Route the power cable and the data cable through the routing guides on the hard-disk drive assembly and connect the cables to the hard-disk drive.

Next steps

1. Install the [front bezel](#).
2. Install the [side cover](#).
3. Follow the procedure in [after working inside your computer](#).

Installing the 3.5-inch hard-disk drive assembly (Bay-1)

Prerequisites

If you are replacing a component, remove the existing component before performing the installation procedure.

About this task

The following images indicate the location of the 3.5-inch hard-disk drive assembly and provides a visual representation of the installation procedure.

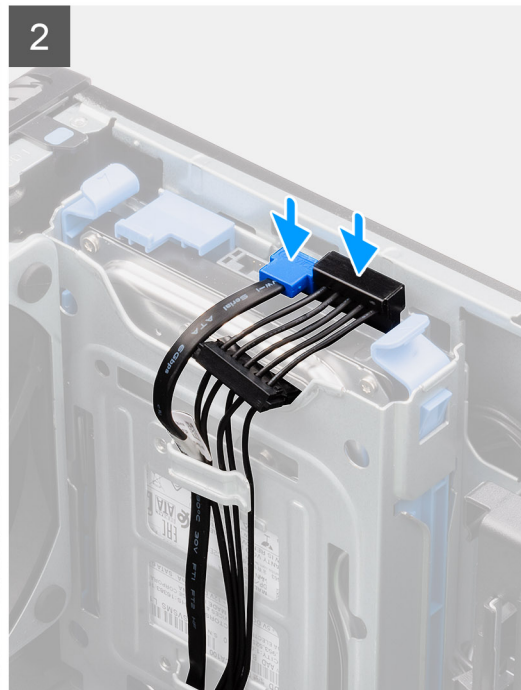
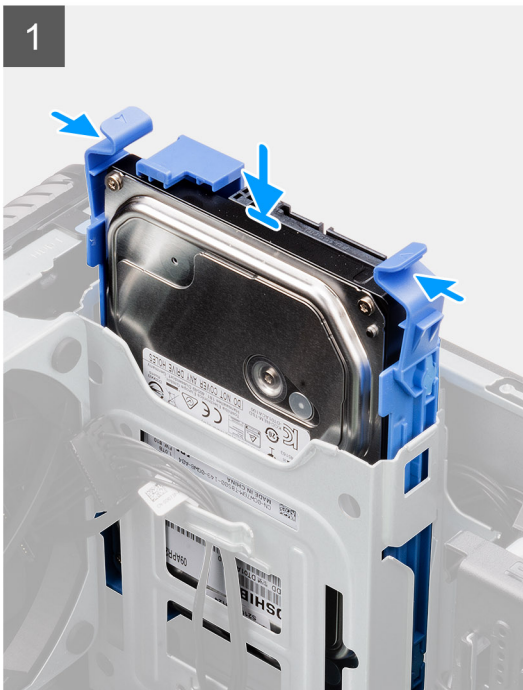
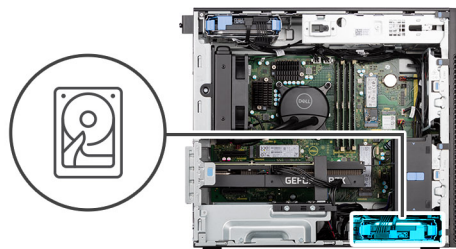

Steps

1. Slide and insert the 3.5-inch hard-disk drive assembly into the hard-disk drive slot.
2. Route the power cable and the data cable through the routing guides on the hard-disk drive assembly and connect the cables to the hard-disk drive.

Next steps

1. Install the [front bezel](#).
2. Install the [side cover](#).
3. Follow the procedure in [after working inside your computer](#).

Solid-state drive

Installing the M.2 2230 PCIe solid-state drive

Prerequisites

If you are replacing a component, remove the existing component before performing the installation procedure.

About this task

The following images indicate the location of the solid-state drive and provides a visual representation of the installation procedure.



1x
M2x3.5

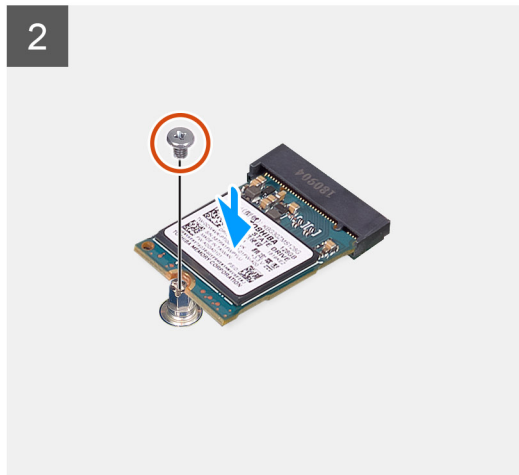
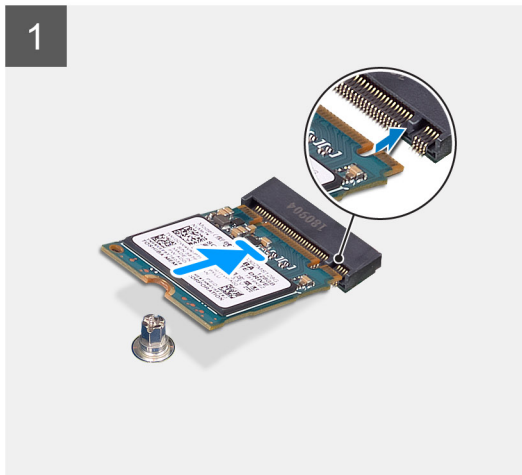
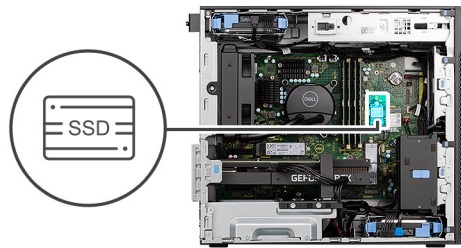

Steps

1. Align the notch on the solid-state drive with the tab on the solid-state drive connector.
2. Insert the solid-state drive at a 45-degree angle into the slot on the system board.
i **NOTE:** When replacing a M.2 2280 solid-state drive from a M.2 2230 solid-state drive, ensure to move the standoff nut to the M.2 2230 solid-state drive slot position.
3. Replace the screw (M2x3.5) to secure the M.2 2230 solid-state drive to the system board.

Next steps

1. Install the [side cover](#).
2. Follow the procedure in [after working inside your computer](#).

Removing the M.2 2280 PCIe solid-state drive

Prerequisites

1. Follow the procedure in [before working inside your computer](#).
2. Remove the [side cover](#).

About this task

The following images indicate the location of the solid-state drive and provide a visual representation of the removal procedure.



1x
M2x3.5

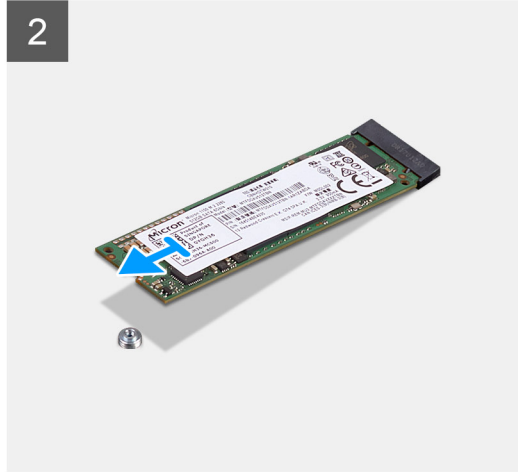
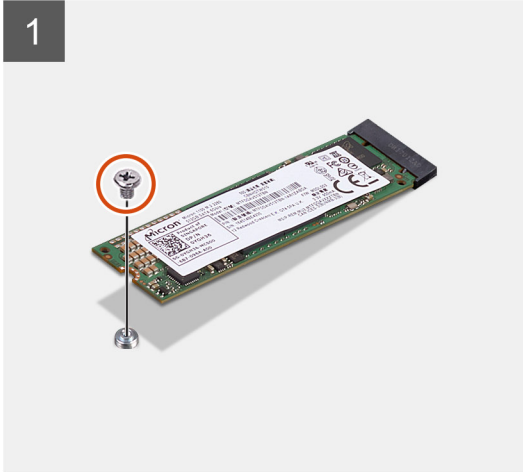
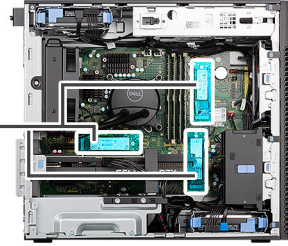

Steps

1. Remove the screw (M2x3.5) that secures the solid-state drive to the system board.
2. Slide and lift the solid-state drive off the system board.

NOTE: Repeat the above procedure for removing the other solid-state drive.

Installing the M.2 2280 PCIe solid-state drive

Prerequisites

If you are replacing a component, remove the existing component before performing the installation procedure.

About this task

The following images indicate the location of the solid-state drive and provides a visual representation of the installation procedure.



1x
M2x3.5

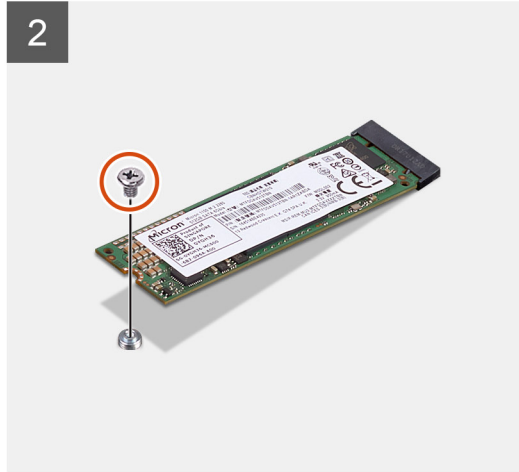
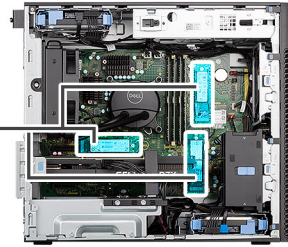

Steps

1. Align the notch on the solid-state drive with the tab on the solid-state drive connector.
2. Insert the solid-state drive at a 45-degree angle into the slot on the system board.
i **NOTE:** When replacing a M.2 2230 solid-state drive with a M.2 2280 solid-state drive, ensure to move the standoff nut to the M.2 2280 solid-state drive slot position.
3. Replace the screw (M2x3.5) to secure the M.2 2280 solid-state drive to the system board.
i **NOTE:** Repeat the above procedure for installing the other solid-state drive.

Next steps

1. Install the [side cover](#).
2. Follow the procedure in [after working inside your computer](#).

Removing the M.2 2230 PCIe solid-state drive

Prerequisites

1. Follow the procedure in [before working inside your computer](#).
2. Remove the [side cover](#).

About this task

The following images indicate the location of the solid-state drive and provide a visual representation of the removal procedure.



1x
M2x3.5

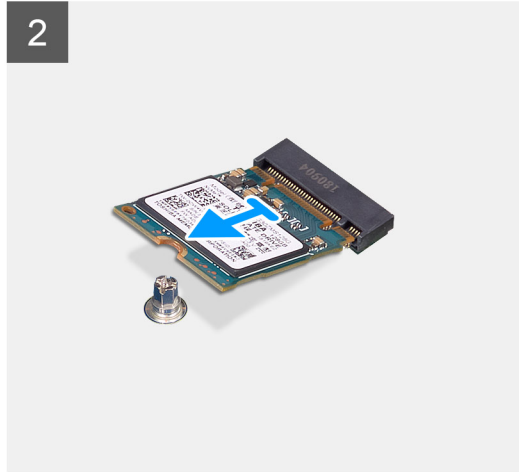
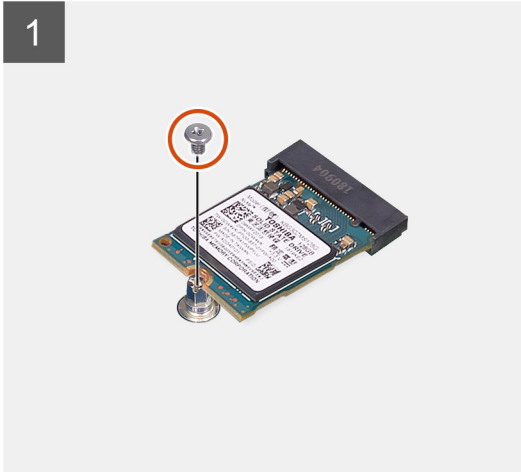
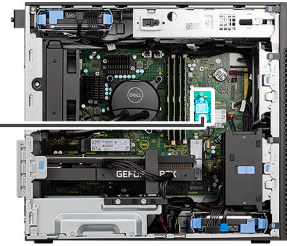

Steps

1. Remove the screw (M2x3.5) that secures the solid-state drive to the system board.
2. Slide and lift the solid-state drive off the system board.

WLAN card

Removing the WLAN card

Prerequisites

1. Follow the procedure in [before working inside your computer](#).
2. Remove the [side cover](#).

About this task

The following images indicate the location of the wireless card and provide a visual representation of the removal procedure.



1x
M2x3.5

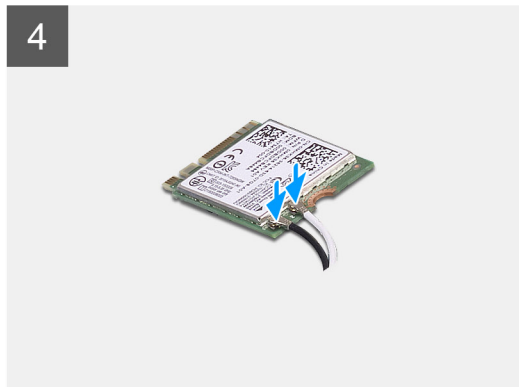
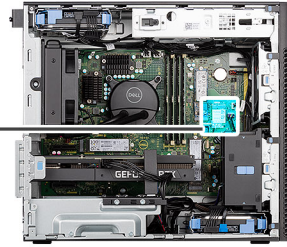

Steps

1. Remove the (M2x3.5) screw that secures the WLAN card to the system board.
2. Lift the WLAN card bracket away from the WLAN card.
3. Slide and remove the WLAN card from the connector on the system board.
4. Disconnect the antenna cables from the WLAN card.

Installing the WLAN card

Prerequisites

If you are replacing a component, remove the existing component before performing the installation procedure.

About this task

The following images indicate the location of the wireless card and provides a visual representation of the installation procedure.



1x
M2x3.5

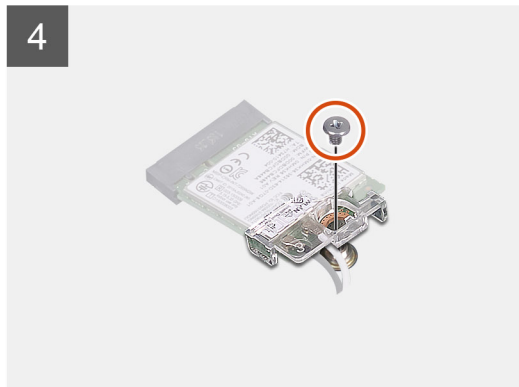
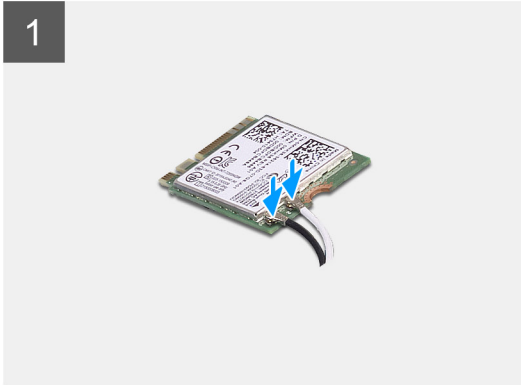
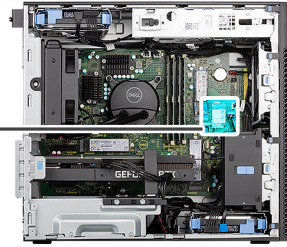

Steps

1. Connect the antenna cables to the WLAN card.

The following table provides the antenna-cable color scheme for the WLAN card of your computer.

Table 2. Antenna-cable color scheme

Connectors on the wireless card	Antenna-cable color
Main (white triangle)	White
Auxiliary (black triangle)	Black

2. Place the WLAN card bracket to secure the WLAN antenna cables.
3. Insert the WLAN card into the connector on the system board.
4. Replace the (M2x3.5) screw to secure the plastic tab to the WLAN card.

Next steps

1. Install the [side cover](#).
2. Follow the procedure in [after working inside your computer](#).

WLAN antenna

Removing the WLAN antenna

Prerequisites

1. Follow the procedure in [before working inside your computer](#).
2. Remove the [side cover](#).
3. Remove the [front bezel](#).
4. Remove the [WLAN card](#).

About this task

The following images indicate the location of the WLAN antenna module and provide a visual representation of the removal procedure.



2x
M3x3

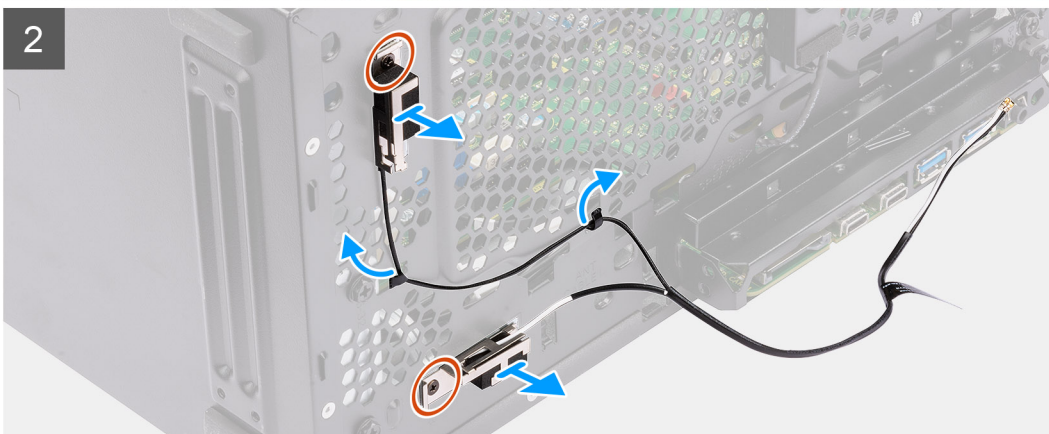
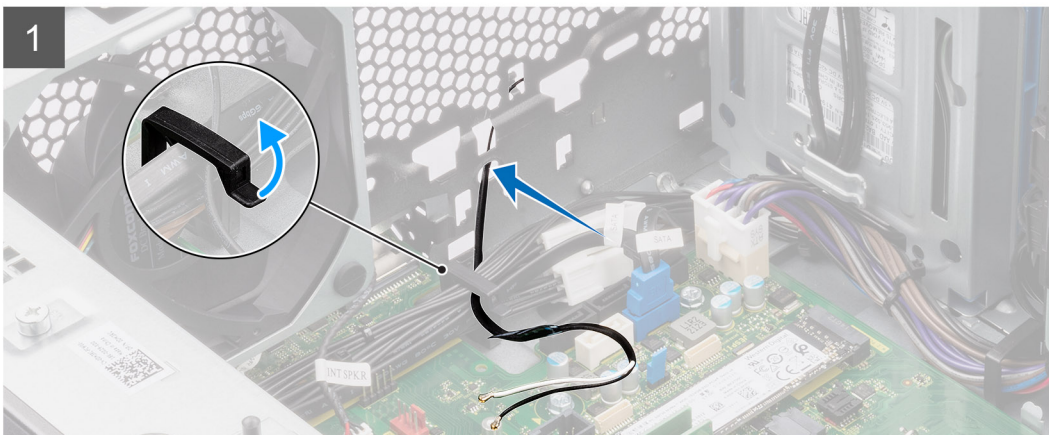
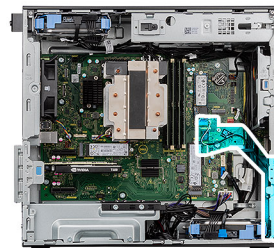

Steps

1. Remove the antenna cables from the routing guides on the chassis.
2. Unroute the antenna cables through the recess on the front of the chassis.
3. Remove the two (M3x3) screws that secures the WLAN antenna to the chassis.

4. Lift the WLAN antenna off the chassis.

Installing the WLAN antenna

Prerequisites

If you are replacing a component, remove the existing component before performing the installation procedure.

About this task

The following images indicate the location of the WLAN antenna and provides a visual representation of the installation procedure.



2x
M3x3

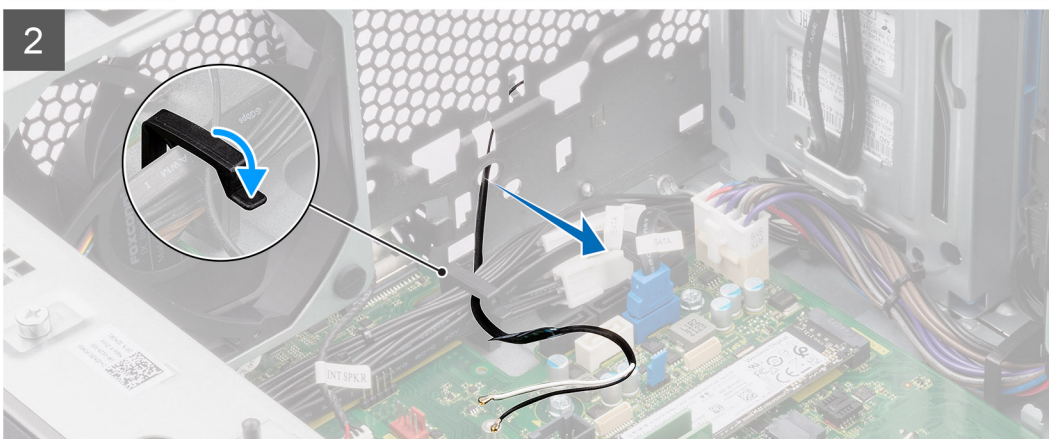
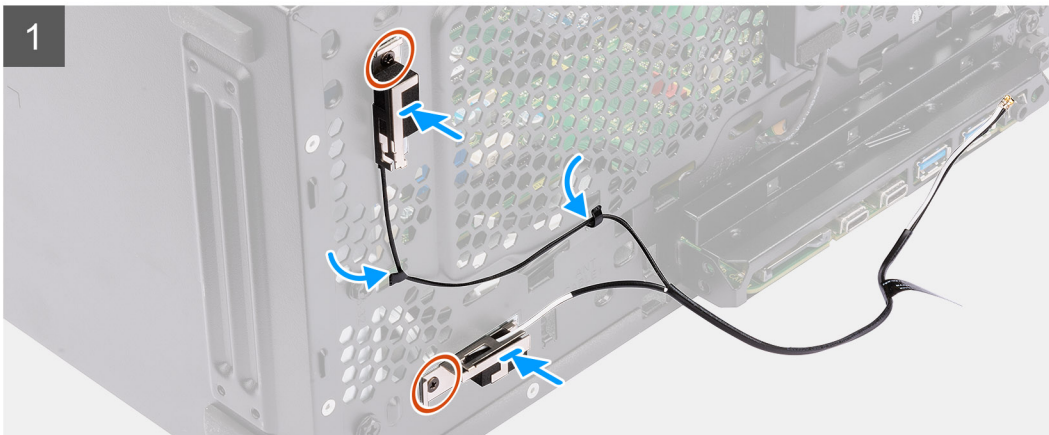
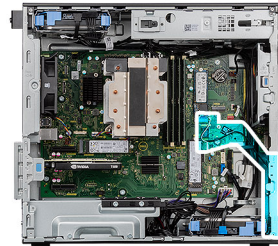

Steps

1. Route the antenna cables through the routing guides on the chassis.
2. Align and place the screw holes on the WLAN antenna with the screw holes on the chassis.
NOTE: When replacing the WLAN antenna, ensure to remove the Mylar tape on the WLAN antenna base.
3. Replace the two screws (M3x3) to secure the WLAN antenna to the chassis.

Next steps

1. Install the [WLAN card](#).
2. Install the [front bezel](#).
3. Install the [side cover](#).
4. Follow the procedure in [after working inside your computer](#).

Coin-cell battery

Removing the coin-cell battery

Prerequisites

1. Follow the procedure in [before working inside your computer](#).
2. Remove the [side cover](#).

About this task

The following images indicate the location of the coin-cell battery and provide a visual representation of the removal procedure.

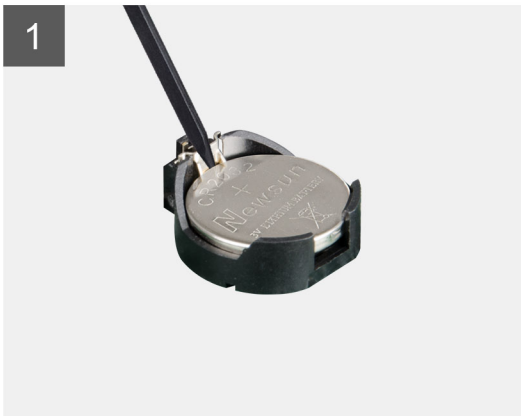
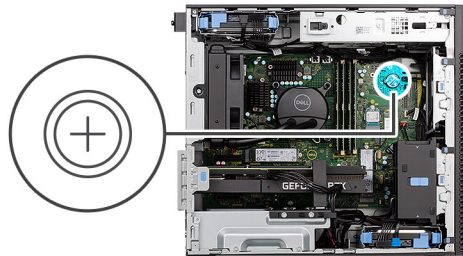

Steps

1. Using a plastic scribe, gently pry the coin-cell battery out of the slot on the system board.
2. Remove the coin-cell battery away from the computer.

Installing the coin-cell battery

Prerequisites

If you are replacing a component, remove the existing component before performing the installation procedure.

About this task

The following images indicate the location of the coin-cell battery and provides a visual representation of the installation procedure.

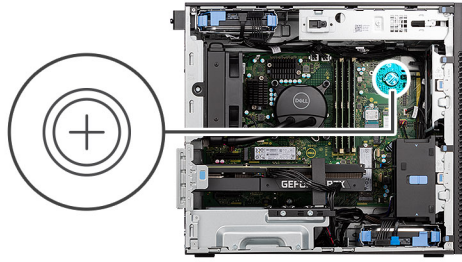

Steps

1. Insert the coin cell battery with the "+" sign facing up and slide it under the securing tabs at the positive side of the connector.
2. Press the battery into the connector until it locks into place.

Next steps

1. Install the [side cover](#).
2. Follow the procedure in [after working inside your computer](#).

Memory module

Removing the memory module

Prerequisites

1. Follow the procedure in [before working inside your computer](#).
2. Remove the [side cover](#).

About this task

The following image indicates the location of the memory module and provide a visual representation of the removal procedure.

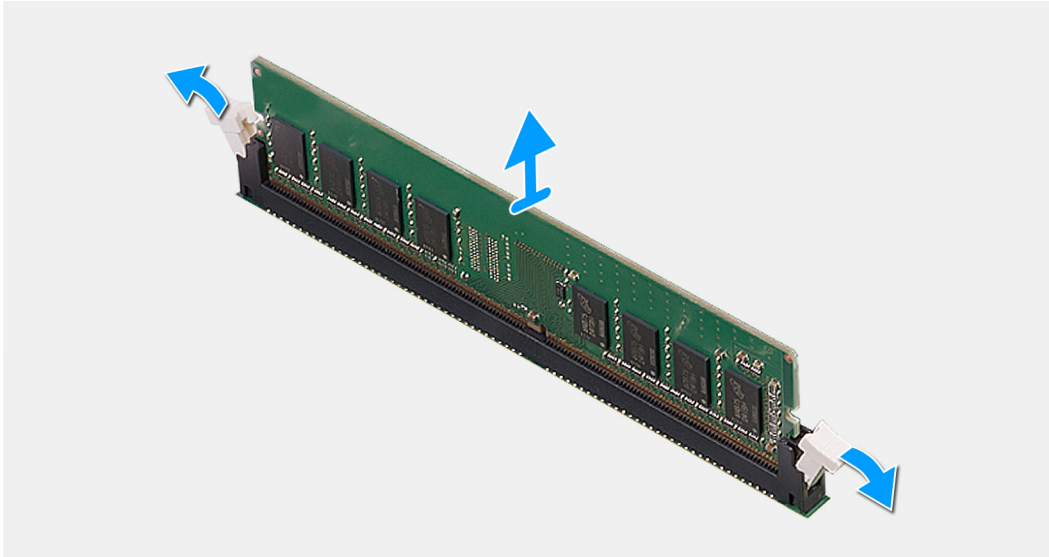
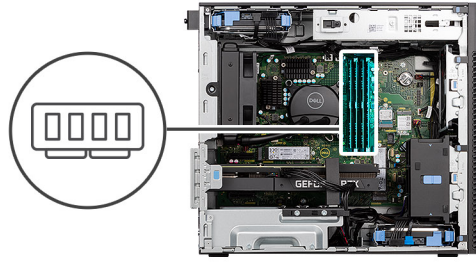

Steps

1. Pull the securing clips from both side of the memory module until the memory module pops up.
2. Slide and remove the memory module from the memory-module slot.

Installing the memory module

Prerequisites

If you are replacing a component, remove the existing component before performing the installation procedure.

About this task

The following image indicates the location of the memory module and provides a visual representation of the installation procedure.

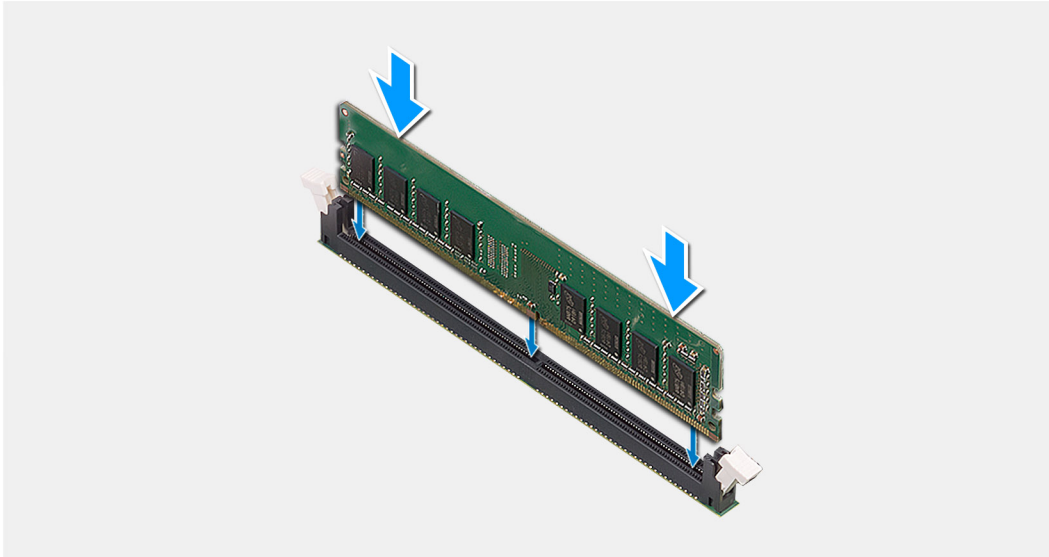
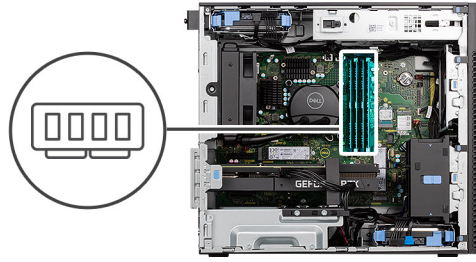

Steps

1. Align the notch on the memory module with the tab on the memory-module slot.
2. Slide the memory module firmly into the slot at an angle and press the memory module down until it clicks into place.

NOTE: If you do not hear the click, remove the memory module and reinstall it.

Next steps

1. Install the [side cover](#).
2. Follow the procedure in [after working inside your computer](#).

GPU end holder

Removing GPU end holder

Prerequisites

1. Follow the procedure in [before working inside your computer](#).
2. Remove the [side cover](#).

About this task

The following images indicate the location of the GPU end holder and provide a visual representation of the removal procedure.

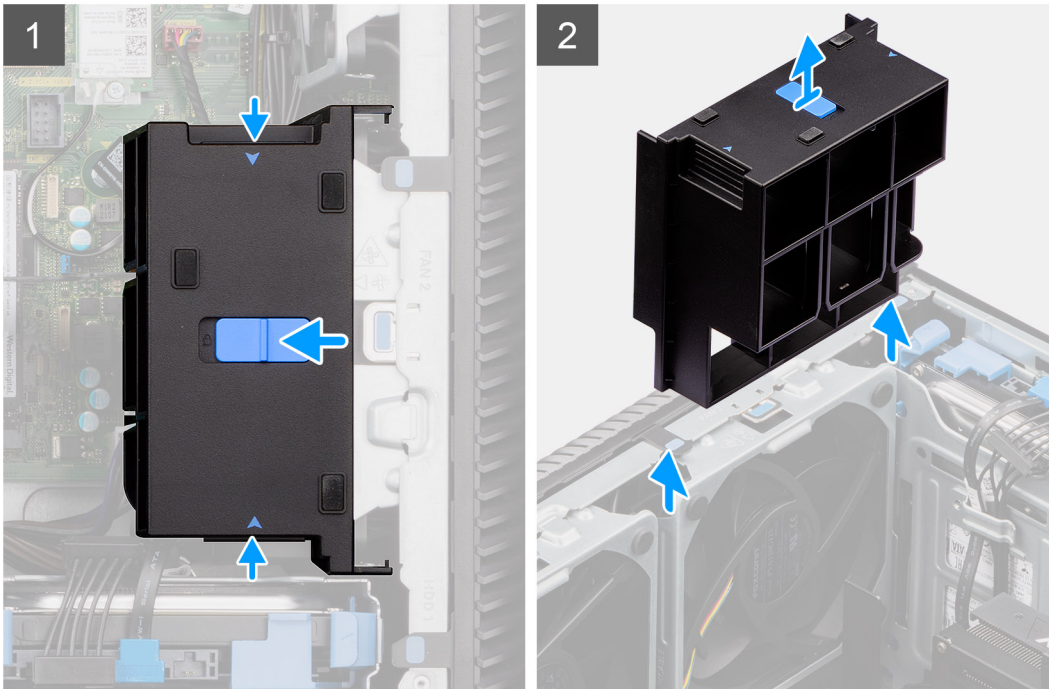

Steps

1. Press the retention tabs on both sides of the GPU end holder to release it.
2. Lift and remove the GPU end holder from the computer.

Installing the GPU end holder

Prerequisites

If you are replacing a component, remove the existing component before performing the installation procedure.

About this task

The following images indicate the location of the GPU end holder and provides a visual representation of the installation procedure.

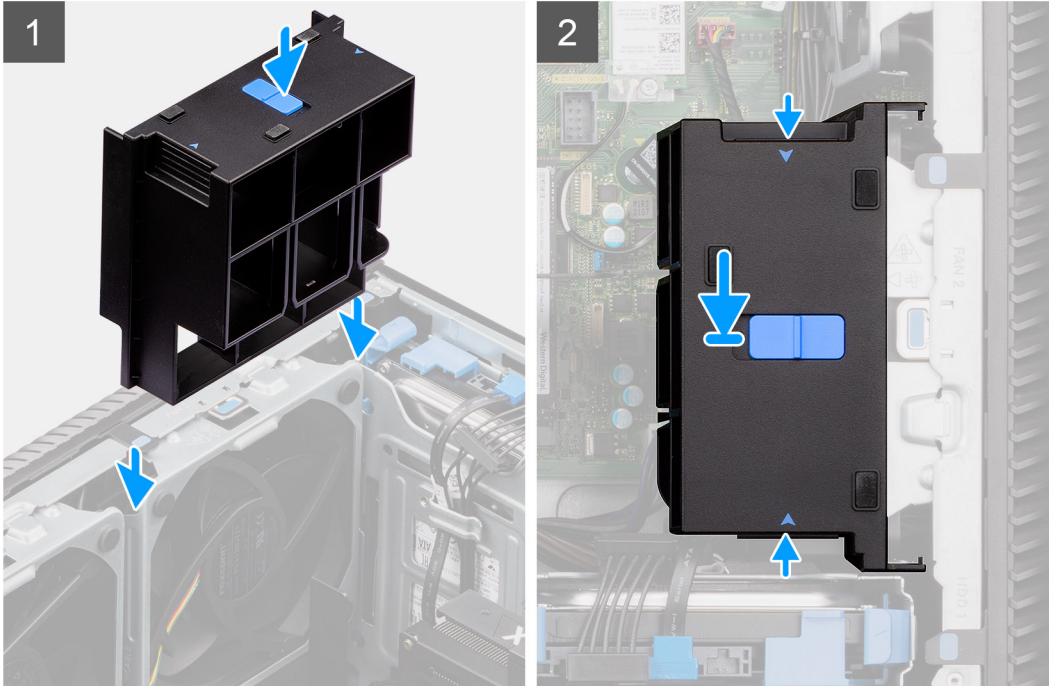

Steps

1. Position the GPU end holder to align it with the slots on the computer chassis.
2. Press the GPU end holder down until it clicks into place.

Next steps

1. Install the [side cover](#).
2. Follow the procedure in [after working inside your computer](#).

Expansion card

Removing the graphics card

Prerequisites

1. Follow the procedure in [before working inside your computer](#).
2. Remove the [side cover](#).

About this task

The following images indicate the location of the graphics card and provide a visual representation of the removal procedure.

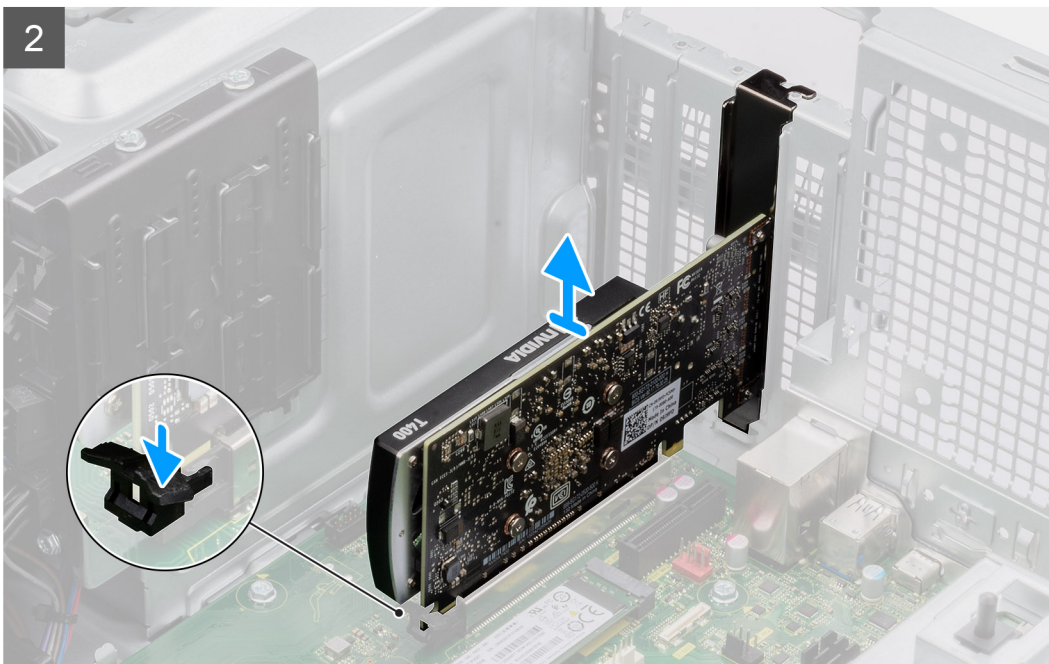
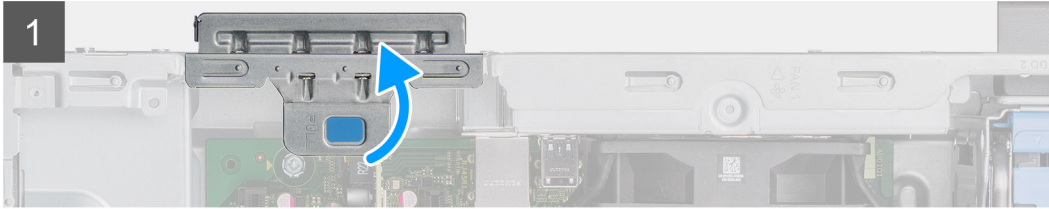
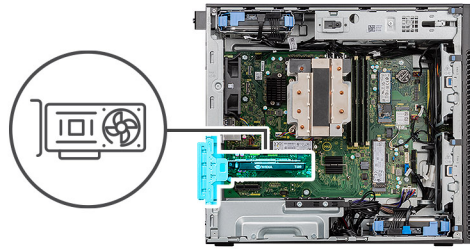

Steps

1. Lift the pull tab to open the PCIe door.
2. Push and hold the securing tab on the graphics-card slot and lift the graphics card from the graphics-card slot.

Installing the graphics card

Prerequisites

If you are replacing a component, remove the existing component before performing the installation procedure.

About this task

The following images indicate the location of the graphics card and provide a visual representation of the installation procedure.

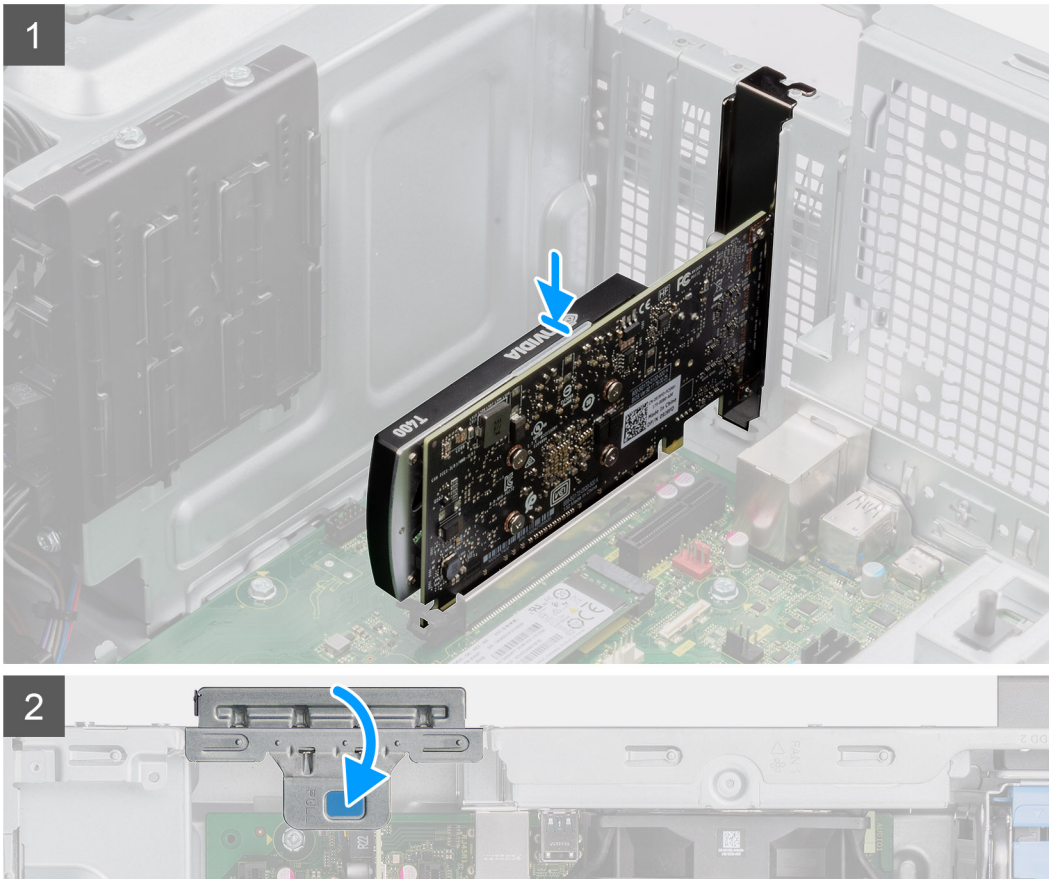
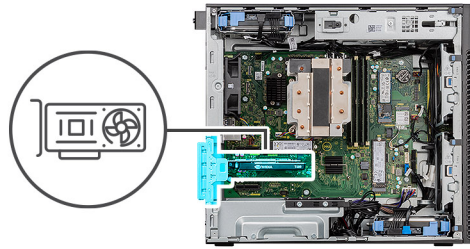

Steps

1. Align the graphics card with the PCI-Express card connector on the system board.
2. Using the alignment post, connect the graphics card in the connector and press down firmly. Ensure that the card is firmly seated.
3. Lift the pull tab to close the PCIe door.

Next steps

1. Install the [side cover](#).
2. Follow the procedure in [after working inside your computer](#).

Removing the powered GPU

Prerequisites

1. Follow the procedure in [before working inside your computer](#).
2. Remove the [side cover](#).
3. Remove the [GPU end holder](#).

About this task

The following images indicate the location of the powered graphical processing unit and provide a visual representation of the removal procedure.

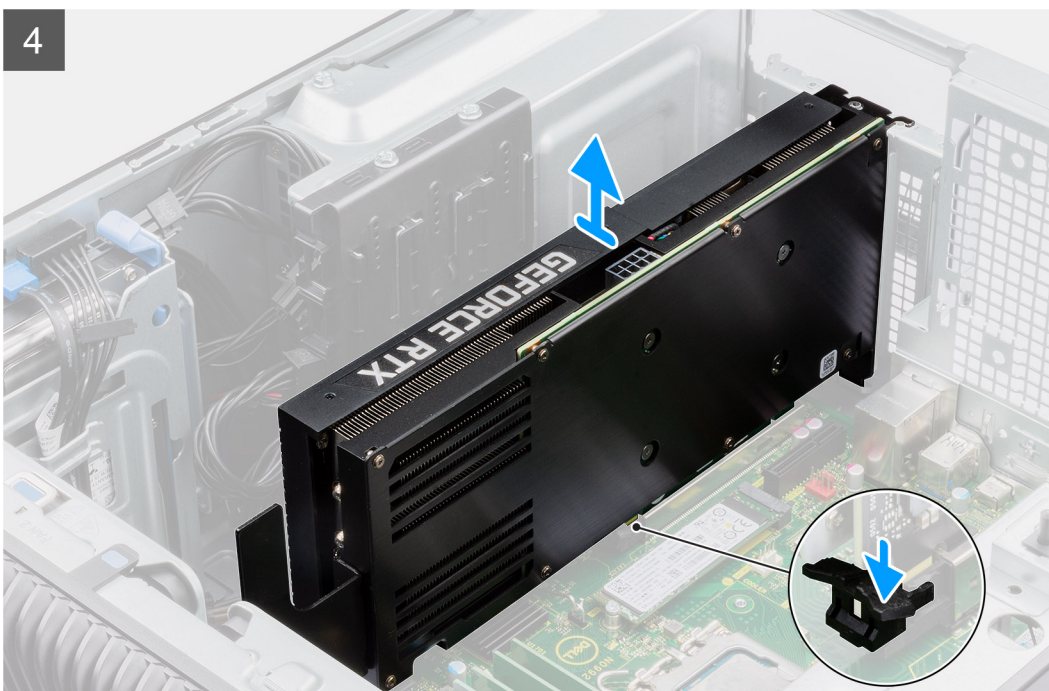
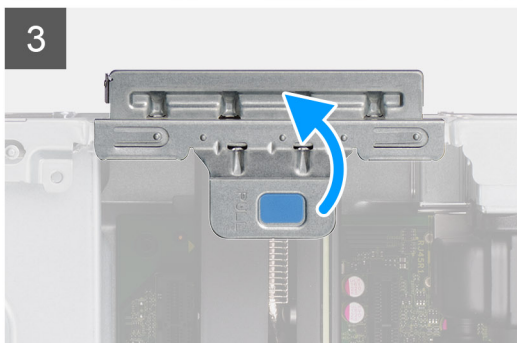
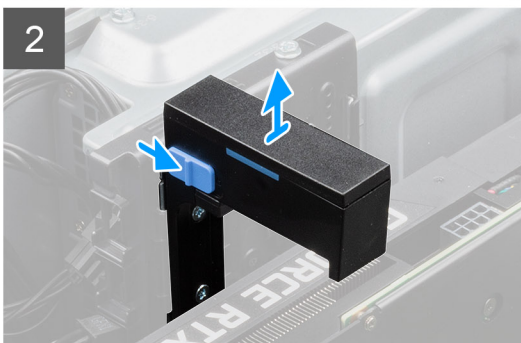
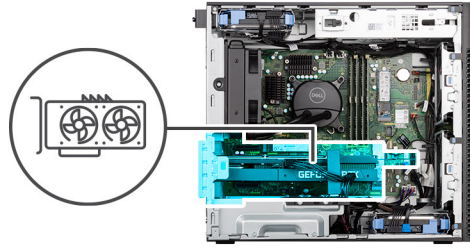

Steps

1. Disconnect the two power cables from the connector on the powered GPU and the power supply unit.
2. Slide the release latch on the graphics card holder and lift it out of the computer.
3. Lift the pull tab to open the PCIe door.
4. Push and hold the securing tab on the graphics-card slot and lift the powered GPU away from the graphics-card slot.
5. Close the PCIe door.

Installing the powered GPU

Prerequisites

If you are replacing a component, remove the existing component before performing the installation procedure.

About this task

The following images indicate the location of the powered graphical processing unit and provide a visual representation of the installation procedure.

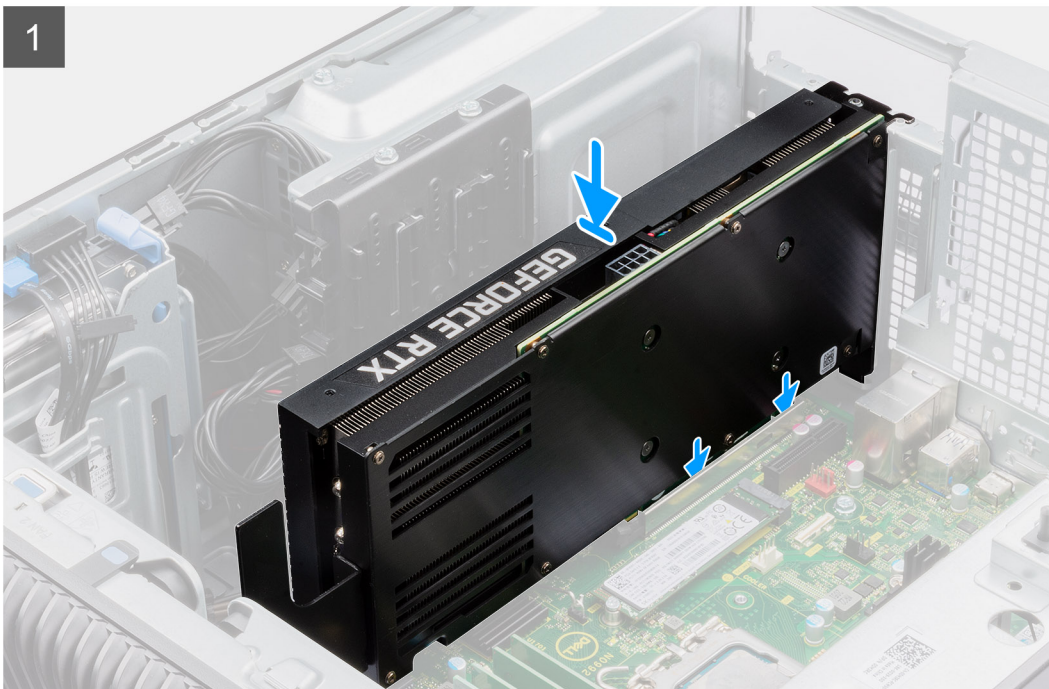
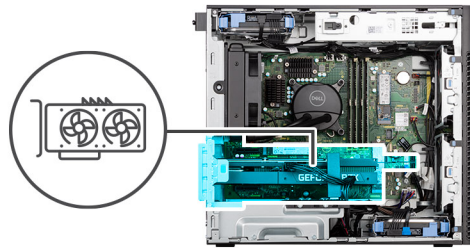

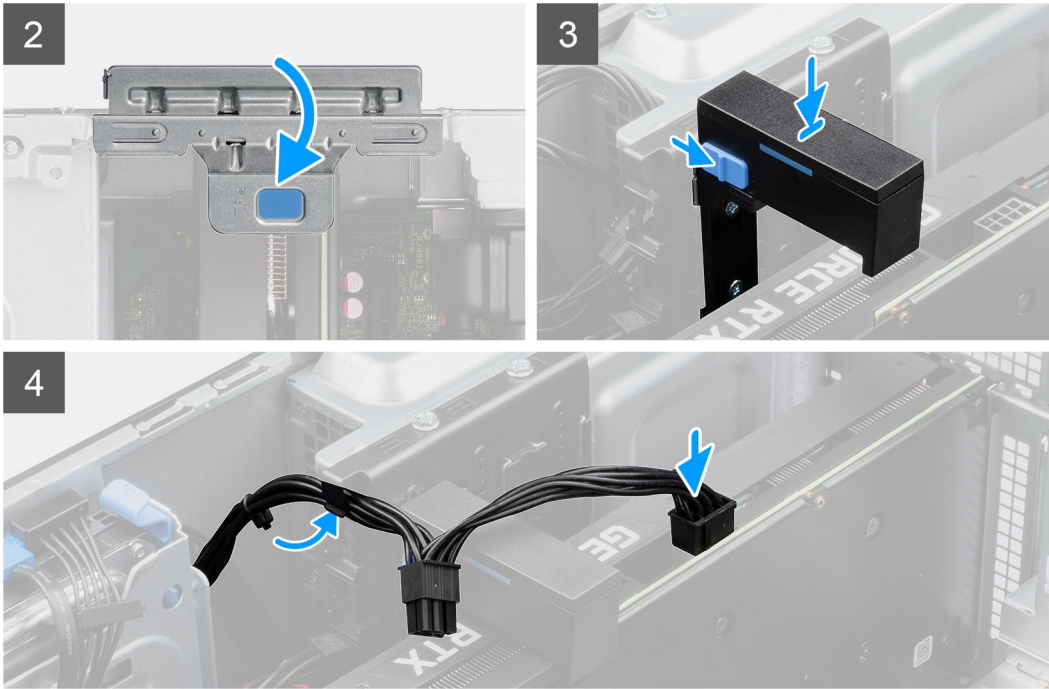

Steps

1. Lift the pull tab to open the PCIe door.
2. Align the powered GPU with the PCI-Express card connector on the system board.
3. Using the alignment post, connect the powered GPU in the connector and press down firmly. Ensure that the powered GPU is firmly seated.
4. Close the PCIe door.
5. Slide the release latch on the graphics card holder and insert it into the slot until it clicks to place.
6. Connect the two power cables, to the connectors on the powered GPU and power supply unit.

Next steps

1. Install the [GPU end holder](#).
2. Install the [side cover](#).
3. Follow the procedure in [after working inside your computer](#).

Power-supply unit

Removing the power-supply unit

Prerequisites

1. Follow the procedure in [before working inside your computer](#).
2. Remove the [side cover](#).

i **NOTE:** Note the routing of all cables as you remove them so that you can route them correctly while you are replacing the power-supply unit.

About this task

The following images indicate the location of the power-supply unit and provide a visual representation of the removal procedure.



4x
M6x32

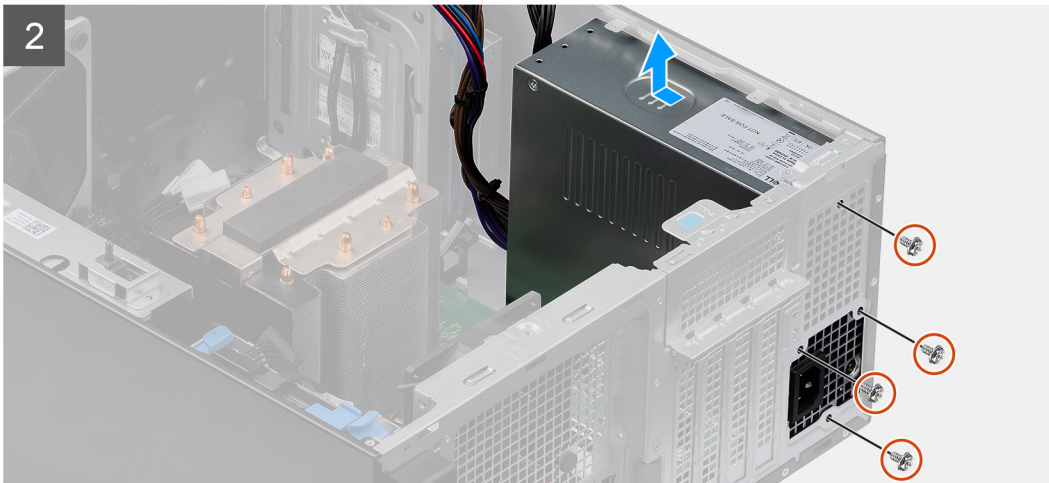
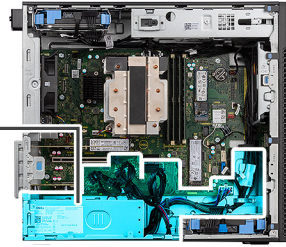
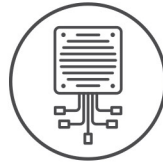

Steps

1. Lay the computer on the right side.
2. Disconnect the power cables from the connectors on the system board and unroute them from the routing guides on the chassis.
3. Remove the four (M6x32) screws that secure the power-supply unit to the chassis.
4. Slide the power-supply unit away from the back of the chassis.
5. Lift the power-supply unit off the chassis.

Installing the power-supply unit

Prerequisites

If you are replacing a component, remove the existing component before performing the installation procedure.

⚠ WARNING: The cables and ports on the back of the power-supply unit are color-coded to indicate the different power wattage. Ensure that you plug in the cable to the correct port. Failure to do so may result in damaging the power-supply unit and/or system components.

About this task

The following images indicate the location of the power-supply unit and provide a visual representation of the installation procedure.



4x
M6x32

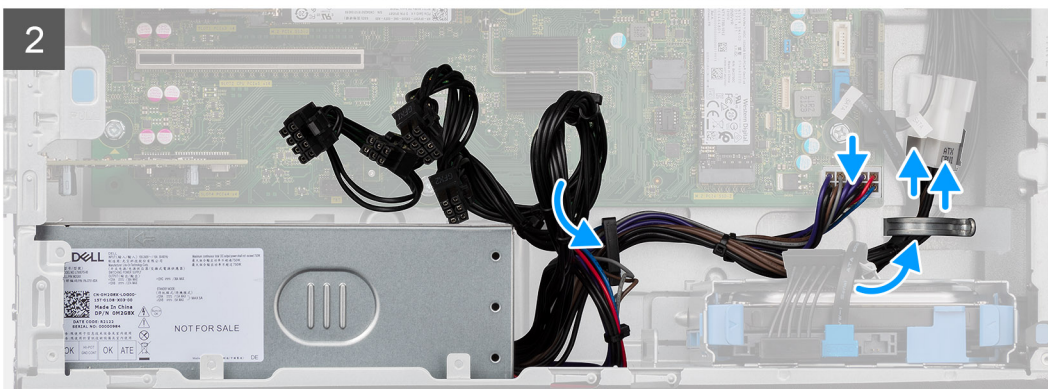
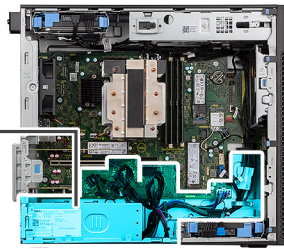
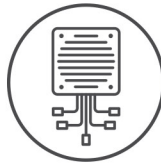

Steps

1. Slide the power-supply unit into the chassis until the securing tab snaps into position.
2. Replace the four (M6x32) screws to secure the power-supply unit to the chassis.
3. Route the power cable through the routing guides on the chassis and connect the power cables to the connectors on the system board.

Next steps

1. Install the [side cover](#).
2. Follow the procedure in [after working inside your computer](#).

Processor fan and heat-sink assembly

Removing the processor fan and 125 W heat-sink assembly

Prerequisites

1. Follow the procedure in [before working inside your computer](#).

 **WARNING:** The heat sink may become hot during normal operation. Allow sufficient time for the heat sink to cool before you touch it.

 **CAUTION:** For maximum cooling of the processor, do not touch the heat transfer areas on the heat sink. The oils in your skin can reduce the heat transfer capability of the thermal grease.

2. Remove the [side cover](#).

About this task

The following images indicate the location of the processor fan and 125 W heat-sink assembly and provide a visual representation of the removal procedure.



4x

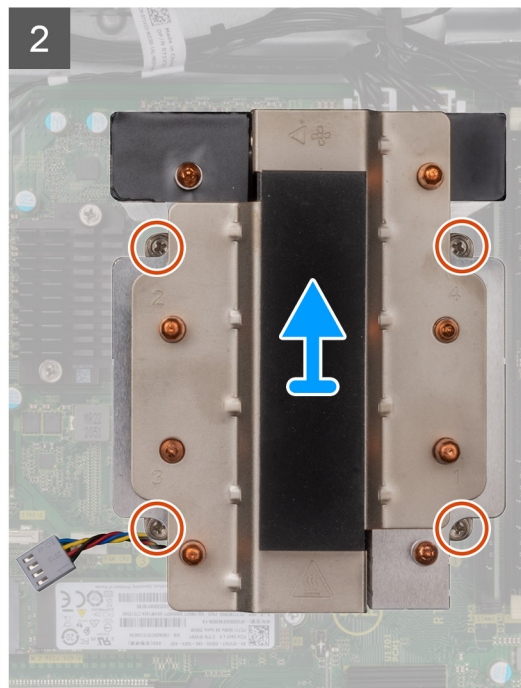
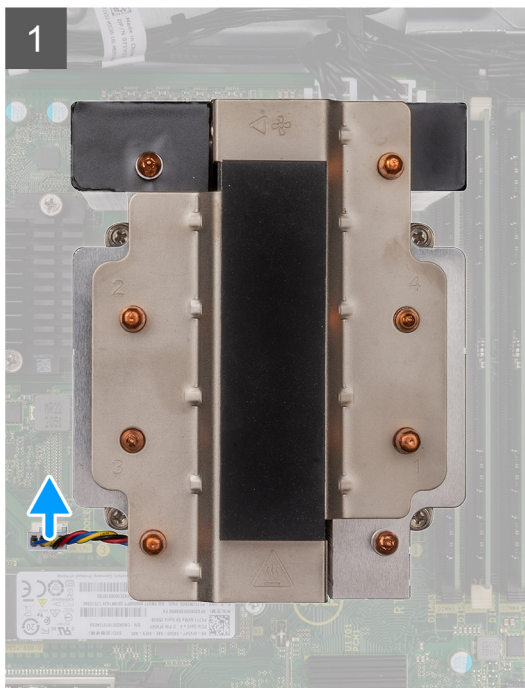
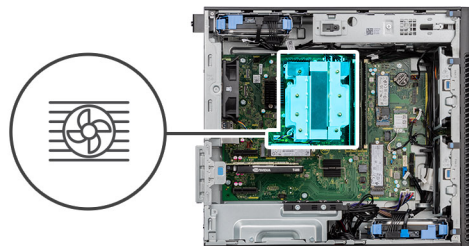

Steps

1. Disconnect the processor-fan cable from the connector on the system board.
2. In the reverse sequential order (4->3->2->1), loosen the four captive screws that secure the processor fan and heat-sink assembly to the system board.
3. Lift the processor fan and heat-sink assembly from the system board.

Installing the processor fan and 125 W heat-sink assembly

Prerequisites

If you are replacing a component, remove the existing component before performing the installation procedure.

NOTE: If either the processor or the heat sink is replaced, use the thermal grease that is provided in the kit to ensure that thermal conductivity is achieved.

About this task

The following images indicate the location of the processor fan and 125 W heat-sink and provides a visual representation of the installation procedure.



4x

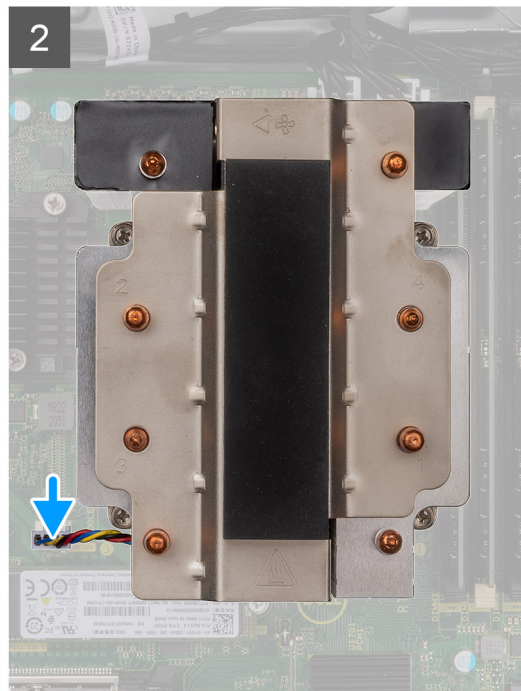
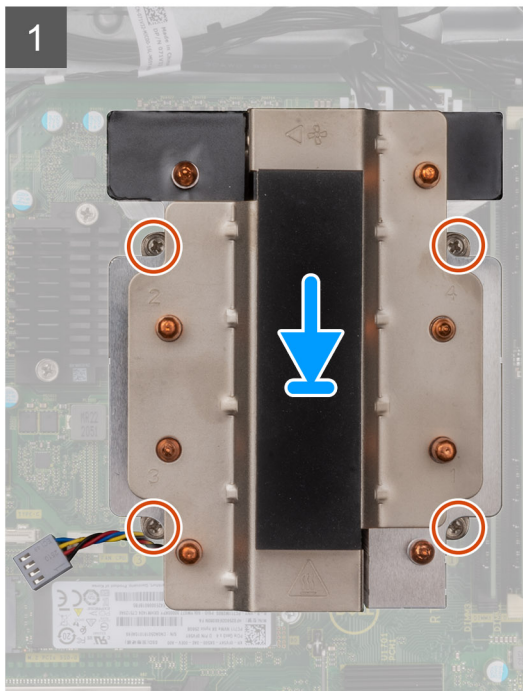
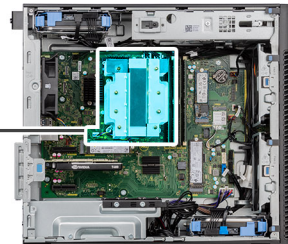

Steps

1. Align the screws on the processor fan and heat-sink assembly with the screw holders on the system board and place the processor fan and heat-sink assembly on the processor.
NOTE: Ensure that the triangle mark is directed towards the rear side of the computer.
2. In the sequential order (1->2->3->4), tighten the captive screws to secure the processor fan and heat-sink assembly to the system board.
NOTE: Tighten the screws in a sequential order (1,2,3,4) as printed on the system board.
3. Connect the processor-fan cable to the connector on the system board.

Next steps

1. Install the [side cover](#).

2. Follow the procedure in [after working inside your computer](#).

Removing the processor fan

Prerequisites

1. Follow the procedure in [before working inside your computer](#).
2. Remove the [side cover](#).
3. Remove the [processor fan and heat-sink assembly](#).

About this task

The following images indicate the location of the processor fan and provide a visual representation of the removal procedure.



4x

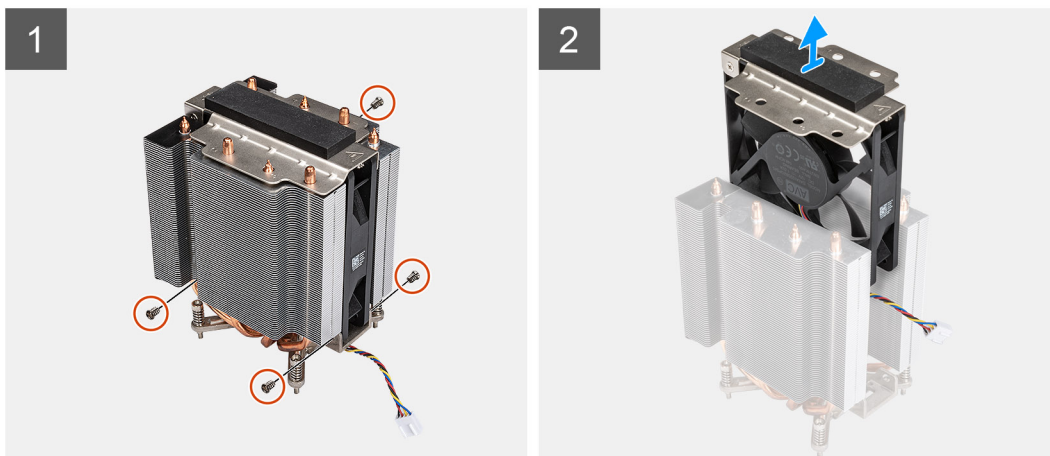

Steps

1. Remove the four screws that secure the processor fan to the heat-sink assembly.
2. Lift the processor fan from the heat-sink.

Installing the processor fan

Prerequisites

If you are replacing a component, remove the existing component before performing the installation procedure.

About this task

The following images indicate the location of the processor fan and provide a visual representation of the removal procedure.



4x

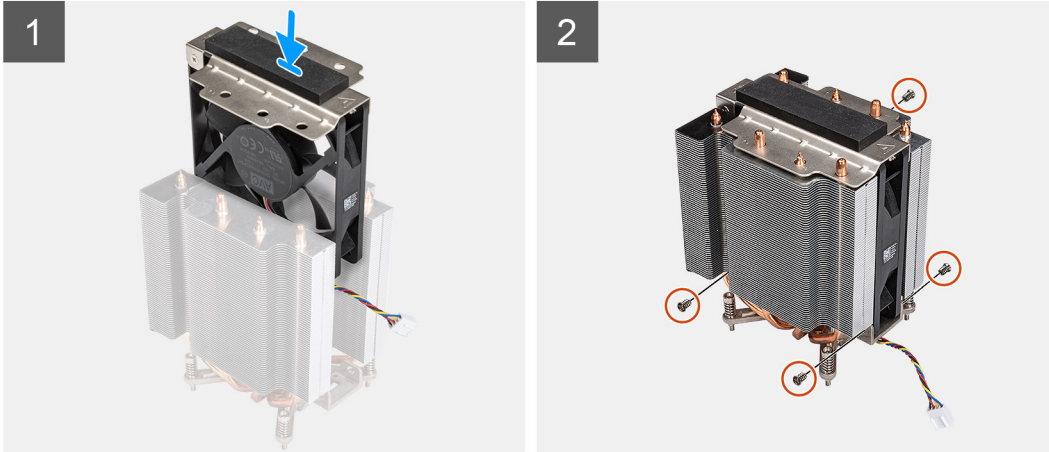

Steps

1. Insert the processor fan into its slot in the heat-sink.
2. Replace the four screws to secure the processor fan to the heat-sink assembly.

Next steps

1. Install the [processor fan and heat-sink assembly](#).
2. Install the [side cover](#).
3. Follow the procedure in [after working inside your computer](#).

Removing the processor fan and 65 W heat-sink assembly

Prerequisites

1. Follow the procedure in [before working inside your computer](#).

 **WARNING:** The heat sink may become hot during normal operation. Allow sufficient time for the heat sink to cool before you touch it.

 **CAUTION:** For maximum cooling of the processor, do not touch the heat transfer areas on the heat sink. The oils in your skin can reduce the heat transfer capability of the thermal grease.

2. Remove the [side cover](#).

About this task

The following images indicate the location of the processor fan and heat-sink and provide a visual representation of the removal procedure.



4x

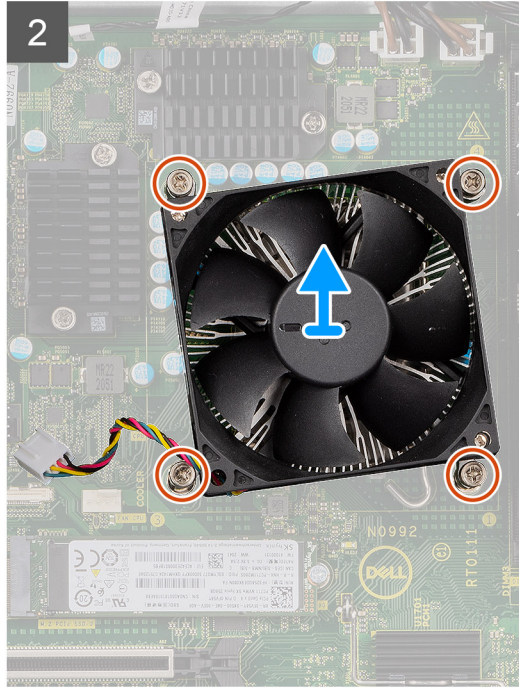
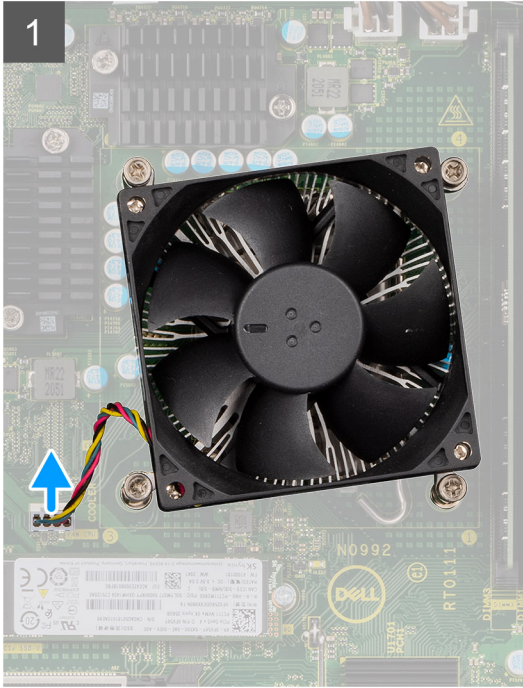
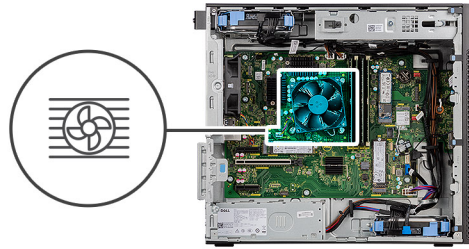

Steps

1. Disconnect the processor fan cable from the connector on the system board.
2. Loosen the four captive screws that secure the processor fan and heat-sink assembly to the system board.
3. Lift the processor fan and heat-sink assembly off the system board.

Installing the processor fan and 65 W heat-sink assembly

Prerequisites

i **NOTE:** If either the processor or the heat sink is replaced, use the thermal grease that is provided in the kit to ensure that thermal conductivity is achieved.

About this task

The following images indicate the location of the processor fan and heat-sink assembly and provides a visual representation of the installation procedure.



4x

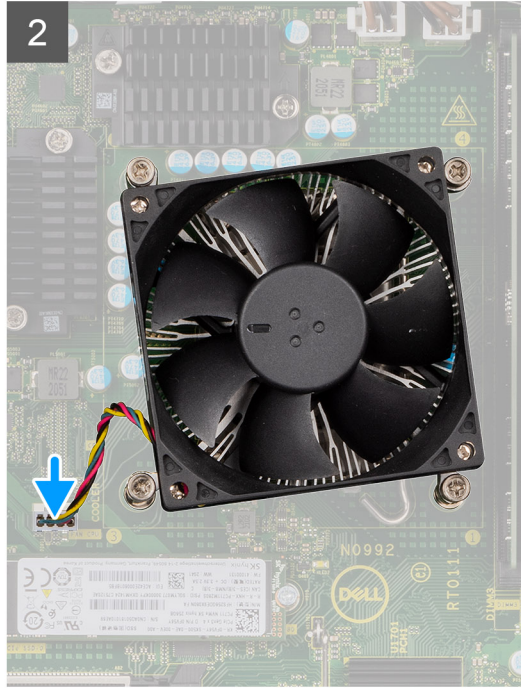
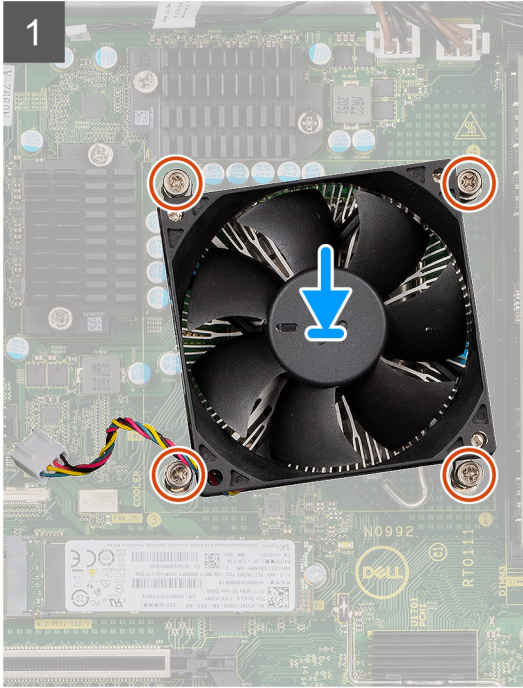

Steps

1. Align the screw holes on the processor fan and heat-sink assembly with the screw holes on the system board.
2. Tighten the four captive screws that secure the processor fan and heat-sink assembly to the system board.
3. Connect the processor-fan cable to the connector on the system board.

Next steps

1. Install the [side cover](#).
2. Follow the procedure in [after working inside your computer](#).

Liquid cooler

Removing the liquid cooler

Prerequisites

1. Follow the procedure in [before working inside your computer](#).



WARNING: The liquid cooler may become hot during normal operation. Allow sufficient time for the liquid cooler to cool before you touch it.

2. Remove the [side cover](#).

About this task

The following images indicate the location of the liquid cooler and provide a visual representation of the removal procedure.

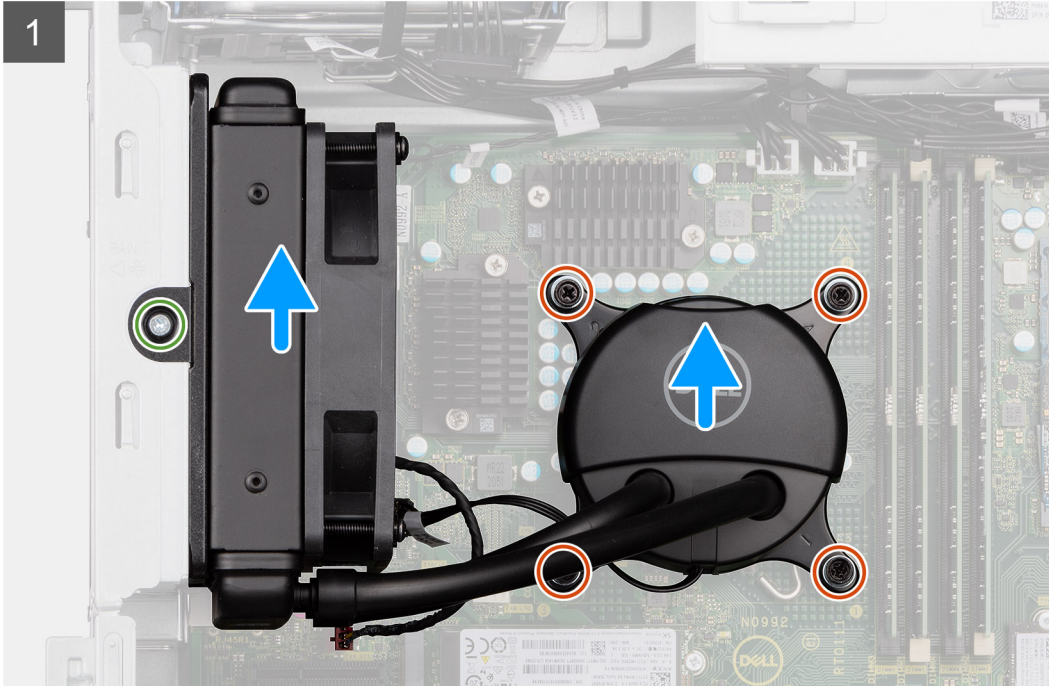
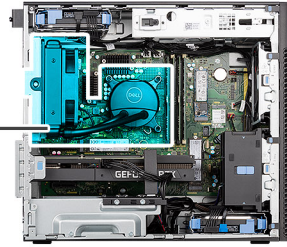
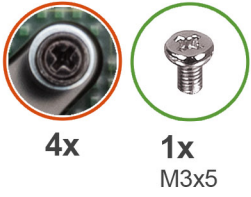

Steps

1. Loosen the four captive screws that secure the liquid cooler to the system board.
2. Remove the screw (M3x5) that secures the liquid cooler fan to chassis and slide it out of the slot.
3. Disconnect the liquid cooler cable and the liquid cooler fan cable from the connectors on the system board.

4. Lift the liquid cooler assembly out of the chassis.

Installing the liquid cooler

Prerequisites

If you are replacing a component, remove the existing component before performing the installation procedure.

About this task

The following images indicate the location of the liquid cooler and provide a visual representation of the installation procedure.



4x



1x
M3x5

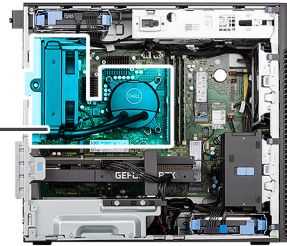

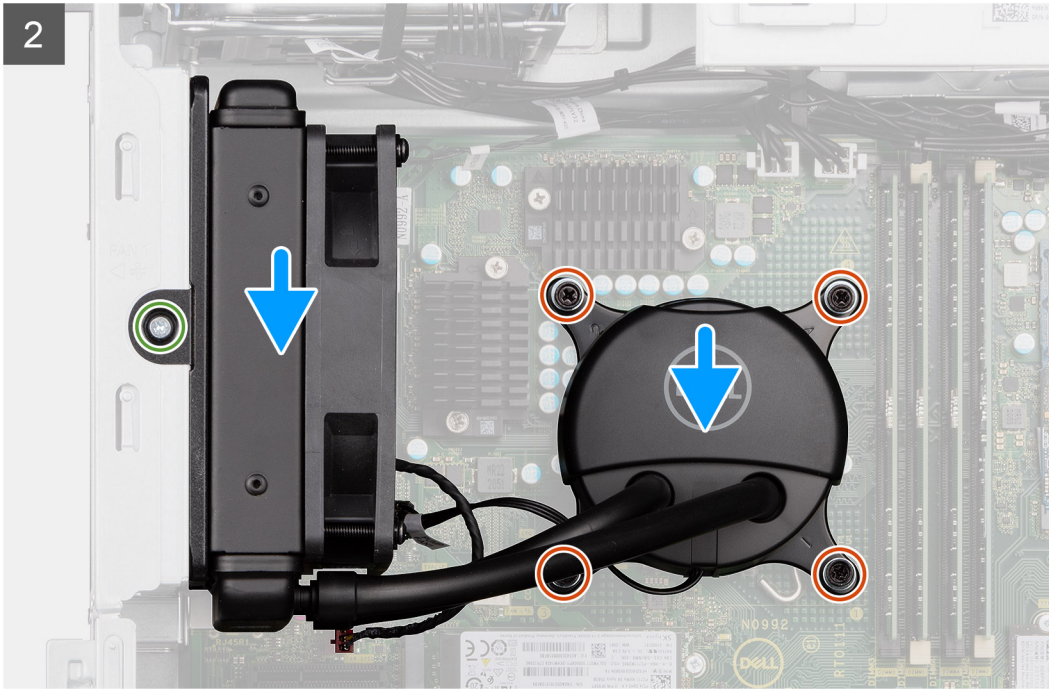

Steps

1. Connect the Liquid cooler cable and the liquid cooler fan cables to the connectors on the system board .
2. Align and place the liquid cooler fan in the slot on the chassis.
3. Replace the single screw (M3x5) that secures the liquid cooler fan to the chassis.
4. Align the screw holes on the liquid cooler with the screw holes on the system board and place the liquid cooler fan.
5. Tighten the four captive screws that secure the liquid cooler to the system board.

Next steps

1. Install the [side cover](#).
2. Follow the procedure in [after working inside your computer](#).

Processor

Removing the processor

Prerequisites

1. Follow the procedure in [before working inside your computer](#).
2. Remove the [side cover](#).
3. Remove the [processor fan and 125 W heat-sink assembly](#) or [processor fan and heat-sink assembly](#).

NOTE: The processor might still be hot after the computer is shut down. Allow the processor to cool down before removing it.

About this task

The following images indicate the location of the processor and provide a visual representation of the removal procedure.

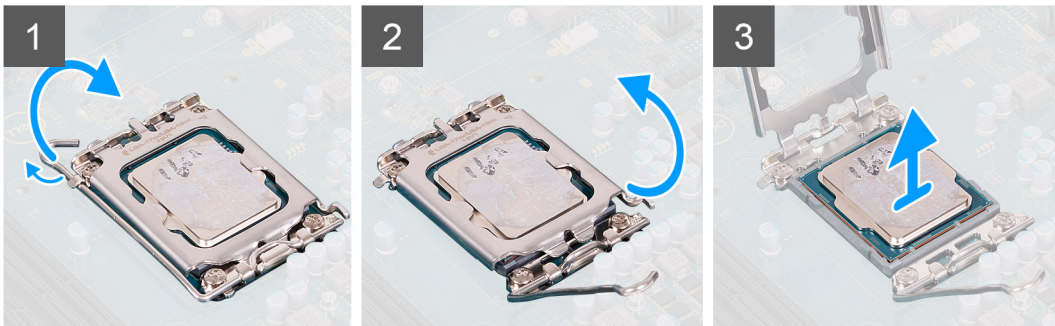
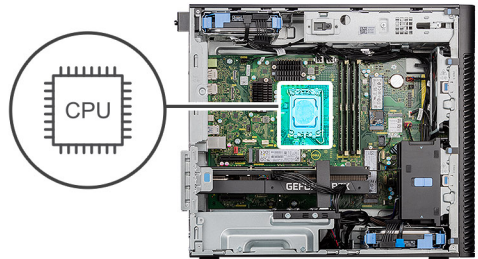

Steps

1. Press down and push the release lever away from the processor to release it from the securing tab.
2. Lift the lever upward to lift the processor cover.

CAUTION: When removing the processor, do not touch any of the pins inside the socket or allow any objects to fall on the pins in the socket.

3. Gently lift the processor from the processor socket.

Installing the processor

Prerequisites

If you are replacing a component, remove the existing component before performing the installation procedure.

About this task

The following images indicate the location of the processor and provides a visual representation of the installation procedure.

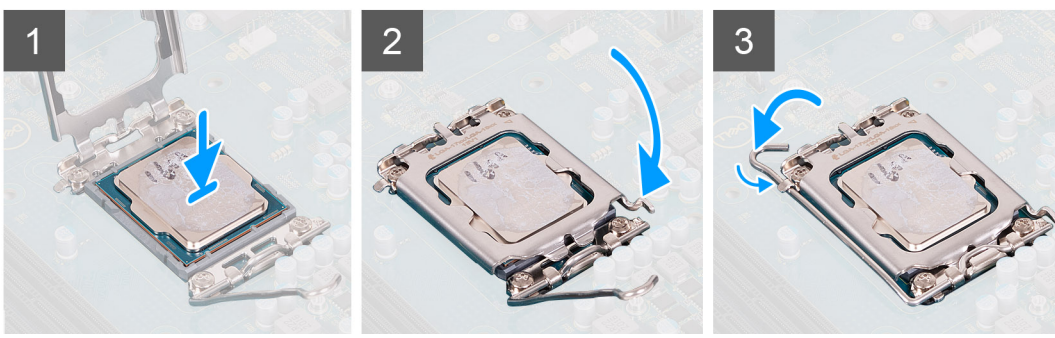
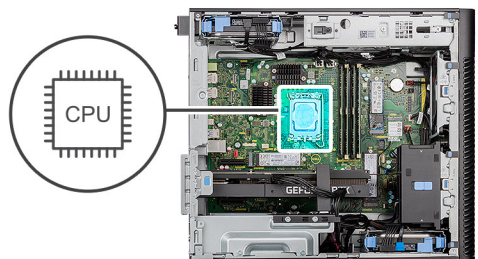

Steps

1. Ensure that the release lever on the processor socket is fully extended in the open position.
2. Align the notches on the processor with the tabs on the processor socket and place the processor in the processor socket.
i **NOTE:** The pin-1 corner of the processor has a triangle that aligns with the triangle on the pin-1 corner on the processor socket. When the processor is properly seated, all four corners are aligned at the same height. If one or more corners of the processor are higher than the others, the processor is not seated properly.
3. When the processor is fully seated in the socket, pivot the release-lever down and place it under the tab on the processor cover.

Next steps

1. Install the [processor fan and 125 W heat-sink assembly](#) or [processor fan and heat-sink assembly](#).
2. Install the [side cover](#).
3. Follow the procedure in [after working inside your computer](#).

Chassis fan

Removing the front fan

Prerequisites

1. Follow the procedure in [before working inside your computer](#).
2. Remove the [side cover](#).

About this task

The following images indicate the location of the chassis fan and provide a visual representation of the removal procedure.

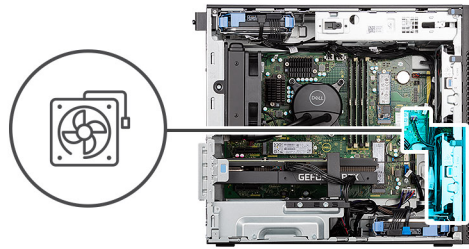

Steps

1. Disconnect the fan cable from the connector on the system board.
2. Press the tab to release the chassis fan from the slot.
3. At an angle lift the chassis fan and remove it from the chassis.

i **NOTE:** Follow the procedure if your computer is installed with two front fans.

Removing front fan cage

Prerequisites

1. Follow the procedure in [before working inside your computer](#).
2. Remove the [side cover](#).

About this task

The following image indicates the location of the chassis front fan cage and provide a visual representation of the removal procedure.

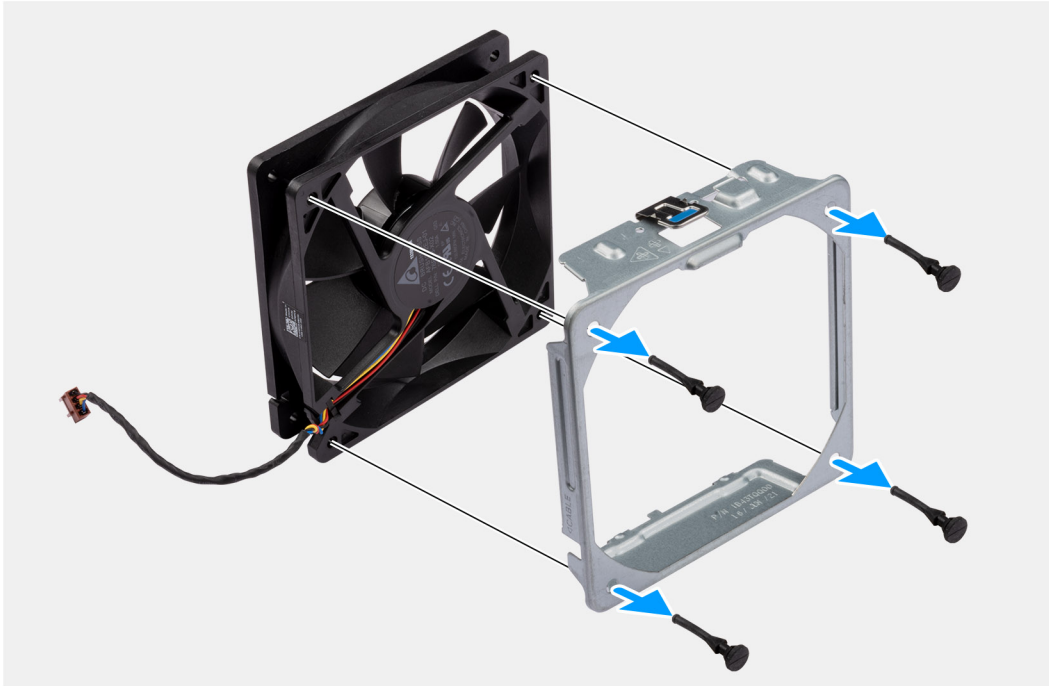
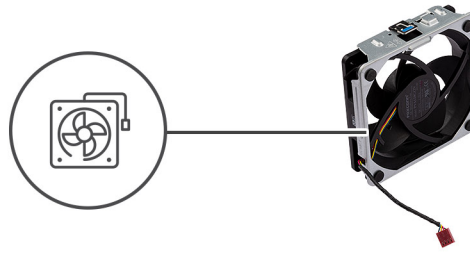

Steps

1. Locate the position of rubber grommets.
2. Gently pull the rubber grommets to release the fan from the fan cage.
3. Remove the fan from the fan cage.

Installing the front fan cage

Prerequisites

If you are replacing a component, remove the existing component before performing the installation procedure.

About this task

The following image indicates the location of the chassis front fan cage and provide a visual representation of the installation procedure.

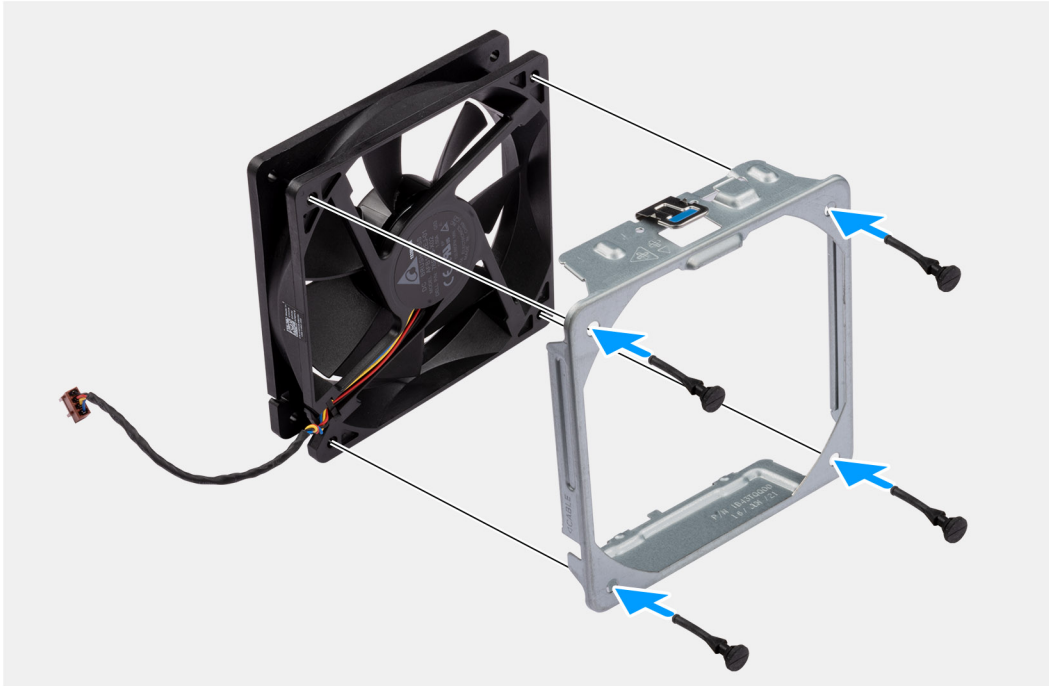
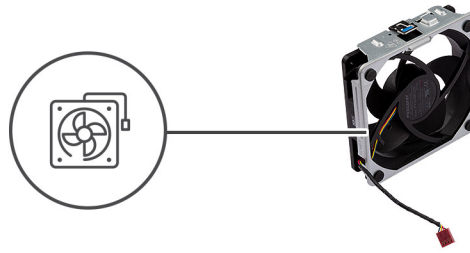

Steps

1. Insert the rubber grommets on the fan cage.
2. Align the slots on the fan with the rubber grommets on the fan cage.
3. Route the rubber grommets through the slots on the fan and pull the rubber grommets until the fan snaps into position.

Next steps

1. Install the [side cover](#).
2. Follow the procedure in [after working inside your computer](#).

Installing the front fan

Prerequisites

If you are replacing a component, remove the existing component before performing the installation procedure.

About this task

The following images indicate the location of the chassis fan and provide a visual representation of the installation procedure.

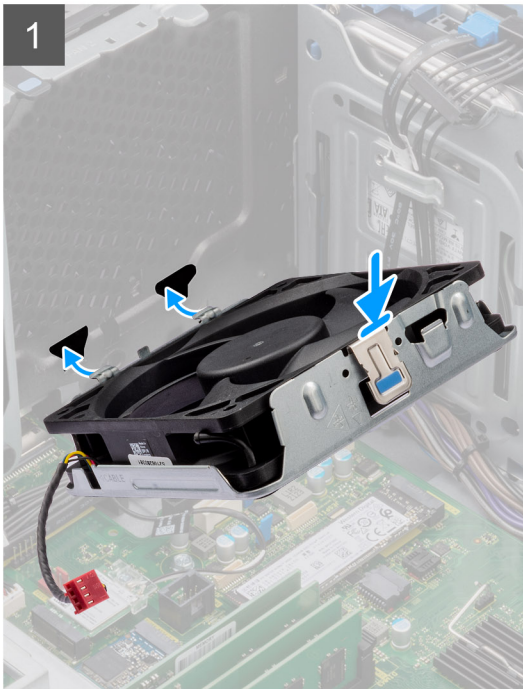
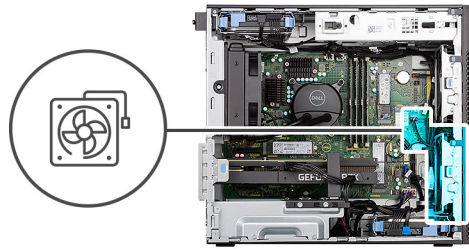

Steps

1. Align the tabs on the fan with the slots on the chassis.
2. Insert the chassis fan at an angle into the slot in the chassis.
3. Press the chassis fan into the slot until the release tab locks into place.
4. Connect the fan cable to the connector on the system board.

i **NOTE:** Follow the procedure if your computer is installed with two front fans.

Next steps

1. Install the [side cover](#).
2. Follow the procedure in [after working inside your computer](#).

Removing the rear fan

Prerequisites

1. Follow the procedure in [before working inside your computer](#).
2. Remove the [side cover](#).

About this task

The following images indicate the location of the chassis fan and provide a visual representation of the removal procedure.

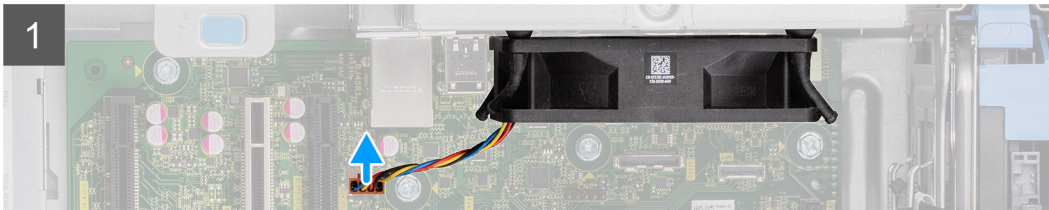
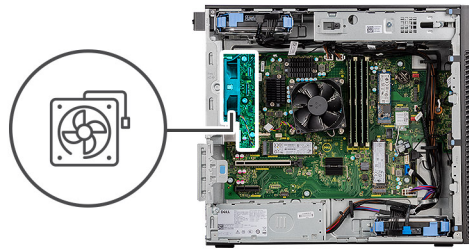

Steps

1. Disconnect the fan cable from the connector on the system board.
2. Locate the position of rubber grommets.
3. Gently pull the rubber grommets to release the fan from the chassis.
4. Remove the fan off the chassis.

Installing the rear fan

Prerequisites

If you are replacing a component, remove the existing component before performing the installation procedure.

About this task

The following images indicate the location of the chassis fan and provide a visual representation of the installation procedure.

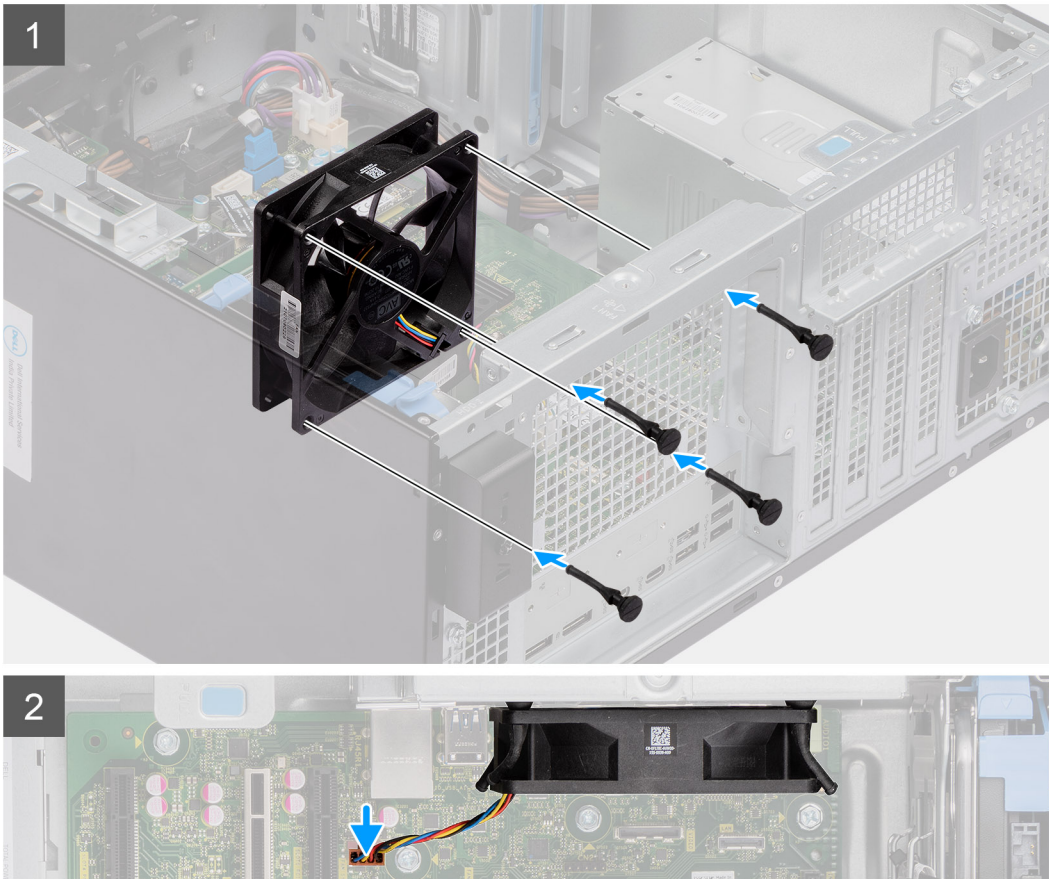
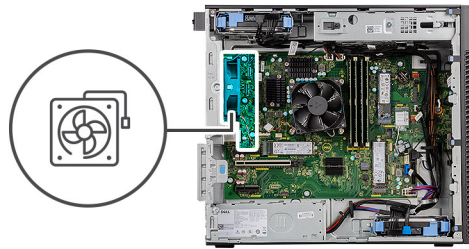

Steps

1. Insert the rubber grommets on the chassis.
2. Align the slots on the fan with the rubber grommets on the chassis.
3. Route the rubber grommets through the slots on the fan and pull the rubber grommets until the fan snaps into position.
4. Connect the fan cable to the connector on the system board.

Next steps

1. Install the [side cover](#).
2. Follow the procedure in [after working inside your computer](#).

Power button

Removing the power button

Prerequisites

1. Follow the procedure in [before working inside your computer](#).

2. Remove the [side cover](#).
3. Remove the [front bezel](#).

About this task

The following images indicate the location of the power button and provide a visual representation of the removal procedure.

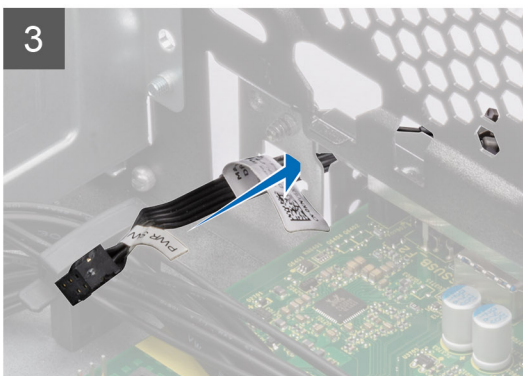
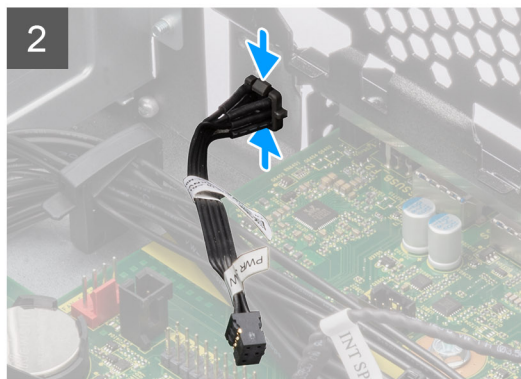
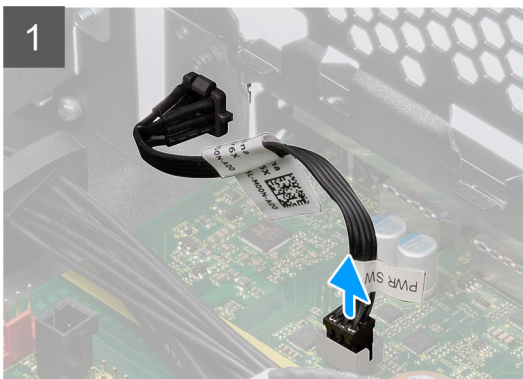
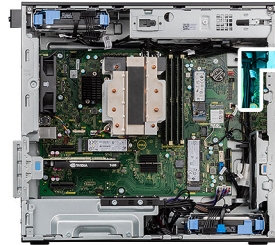

Steps

1. Disconnect the power-button cable from the connector on the system board.
2. Press the release tabs on the power-button head and slide the power-button cable out from the front-side chassis of the computer.
3. Pull the power-button cable out from the computer.

Installing the power button

Prerequisites

If you are replacing a component, remove the existing component before performing the installation procedure.

About this task

The following images indicate the location of the power button and provide a visual representation of the installation procedure.

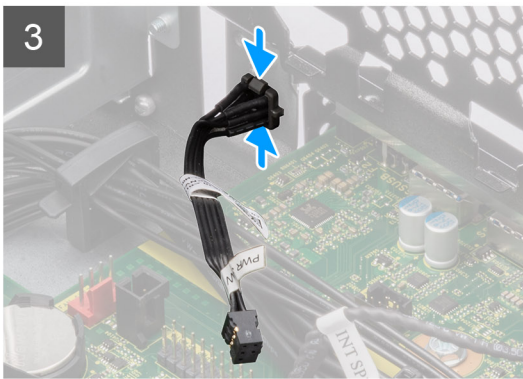
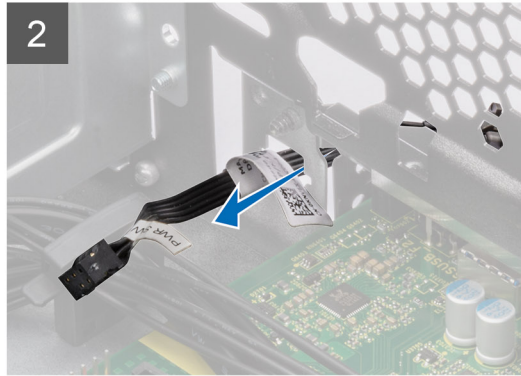
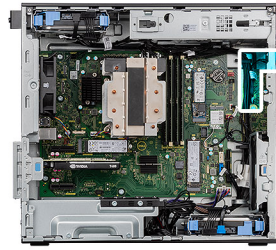

Steps

1. Insert the power-button cable into the slot from the front-side of the computer, and press the power-button head until it clicks into the place in the chassis.
2. Align and connect the power-button cable to the connector on the system board.

Next steps

1. Install the [front bezel](#).
2. Install the [side cover](#).
3. Follow the procedure in [after working inside your computer](#).

Intrusion switch

Removing the intrusion switch

Prerequisites

1. Follow the procedure in [before working inside your computer](#).
2. Remove the [side cover](#).

About this task

The following images indicate the location of the intrusion switch and provides a visual representation of the removal procedure.

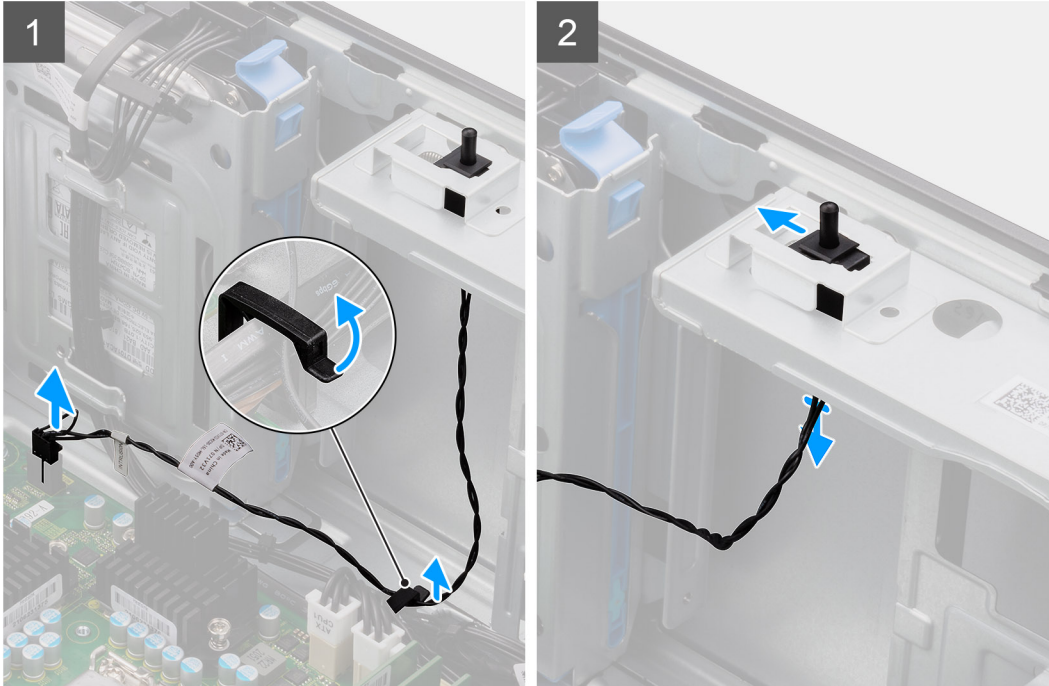

Steps

1. Disconnect the intruder cable from the connector on the system board and unrout the cable from the routing guide.
2. Slide and remove the intrusion switch from the chassis.

Installing the intrusion switch

Prerequisites

If you are replacing a component, remove the existing component before performing the installation procedure.

About this task

The following images indicate the location of the intrusion switch and provide a visual representation of the installation procedure.

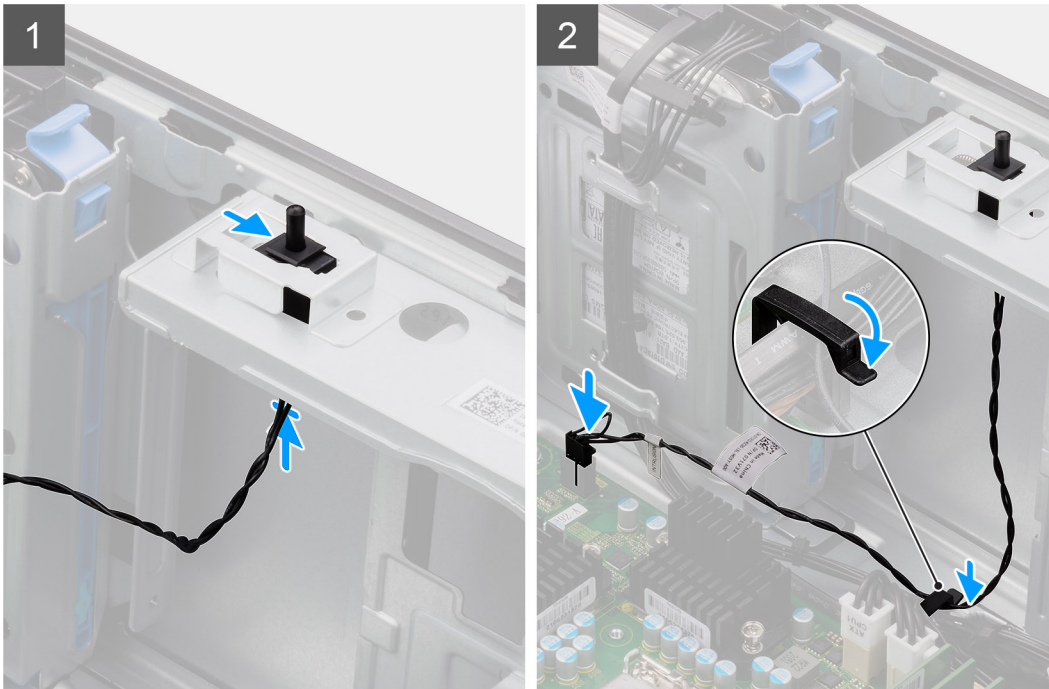

Steps

1. Insert the intrusion switch into its slot and slide the switch to secure it into the slot.
2. Route the intruder cable through the routing guide and connect the intruder cable to the connector on the system board.

Next steps

1. Install the [side cover](#).
2. Follow the procedure in [after working inside your computer](#).

Intrusion speaker

Removing the intrusion speaker

Prerequisites

1. Follow the procedure in [before working inside your computer](#).
2. Remove the [side cover](#).

About this task

The following images indicate the location of the intrusion speaker and provides a visual representation of the removal procedure.

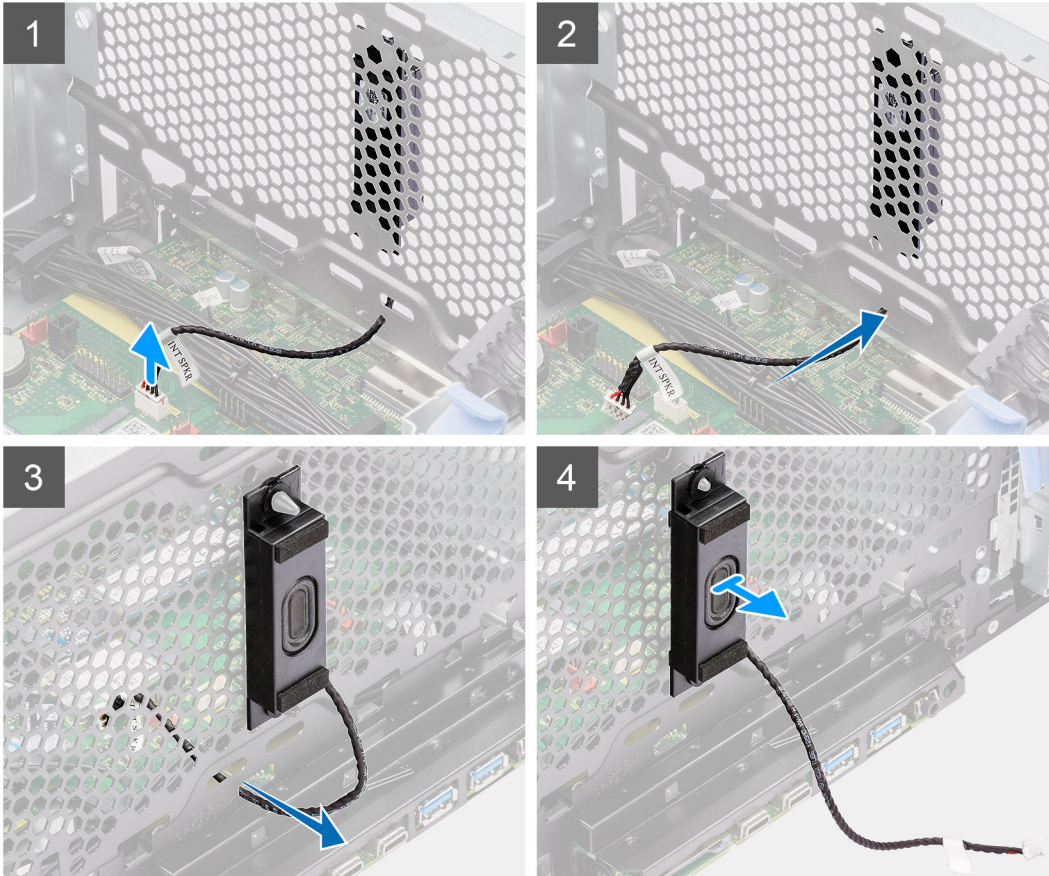
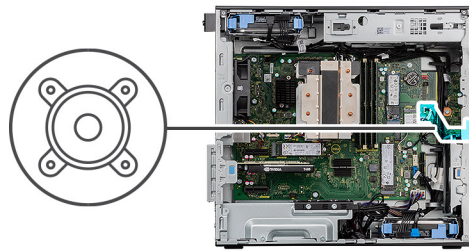

Steps

1. Disconnect the intrusion speaker cable from the connector on the system board.
2. Unroute the intrusion speaker cable through the recess on the chassis
3. Slide and remove the intrusion speaker from the chassis.

Installing the intrusion speaker

Prerequisites

If you are replacing a component, remove the existing component before performing the installation procedure.

About this task

The following images indicate the location of the intrusion speaker and provides a visual representation of the installation procedure.

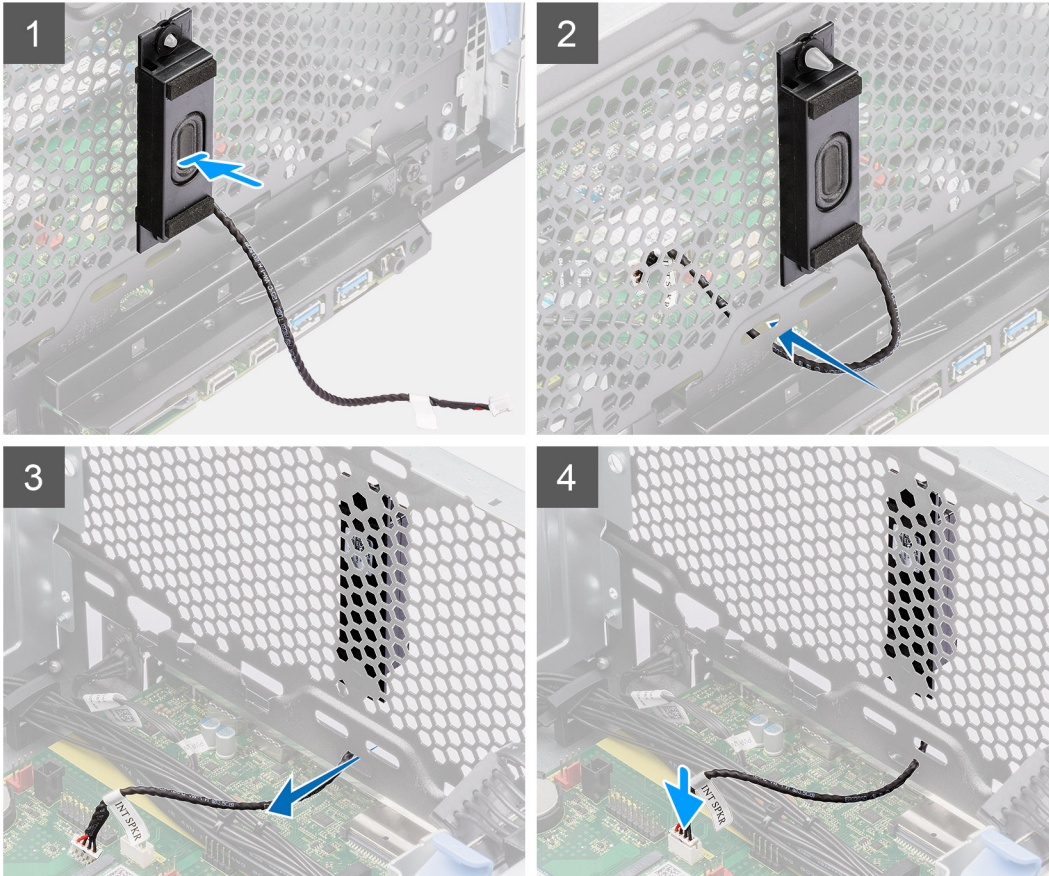
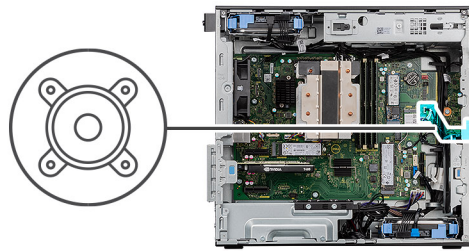

Steps

1. Align the holes on the intrusion speaker with the alignment post on the chassis.
2. Insert the intrusion speaker into its slot.
3. Route the intrusion speaker cable through the recess on the front of the chassis.
4. Connect the intrusion speaker cable to the connector on the system board

Next steps

1. Install the [side cover](#).
2. Follow the procedure in [after working inside your computer](#).

System board

Removing the system board

Prerequisites

1. Follow the procedure in [before working inside your computer](#).

NOTE: Your computer's Service Tag is stored in the system board. You must enter the Service Tag in the BIOS setup program after you replace the system board.

NOTE: Replacing the system board removes any changes that you have made to the BIOS using the BIOS setup program. You must make the appropriate changes again after you replace the system board.

NOTE: Before disconnecting the cables from the system board, note the location of the connectors so that you can reconnect the cables correctly after you replace the system board.

2. Remove the [side cover](#).
3. Remove the [front bezel](#).
4. Remove the [fan duct](#).
5. Remove the [memory module](#).
6. Remove the [WLAN](#).
7. Remove the [M.2 2230 SSD/M.2 2280 SSD](#).
8. Remove the [coin-cell battery](#).
9. Remove the [graphics card](#).
10. Remove the [powered GPU](#).
NOTE: This step is required only if the system is configured with powered GPU.
11. Remove the [intrusion speaker](#).
12. Remove the [intrusion switch](#).
13. Remove the [processor fan and 125 W heat-sink assembly](#) or [processor fan and heat-sink assembly](#).
14. Remove the [front chassis fan](#) and [rear chassis fan](#).
15. Remove the [liquid cooler](#).
16. Remove the [processor](#).

About this task

The following image indicates the connectors on your system board.

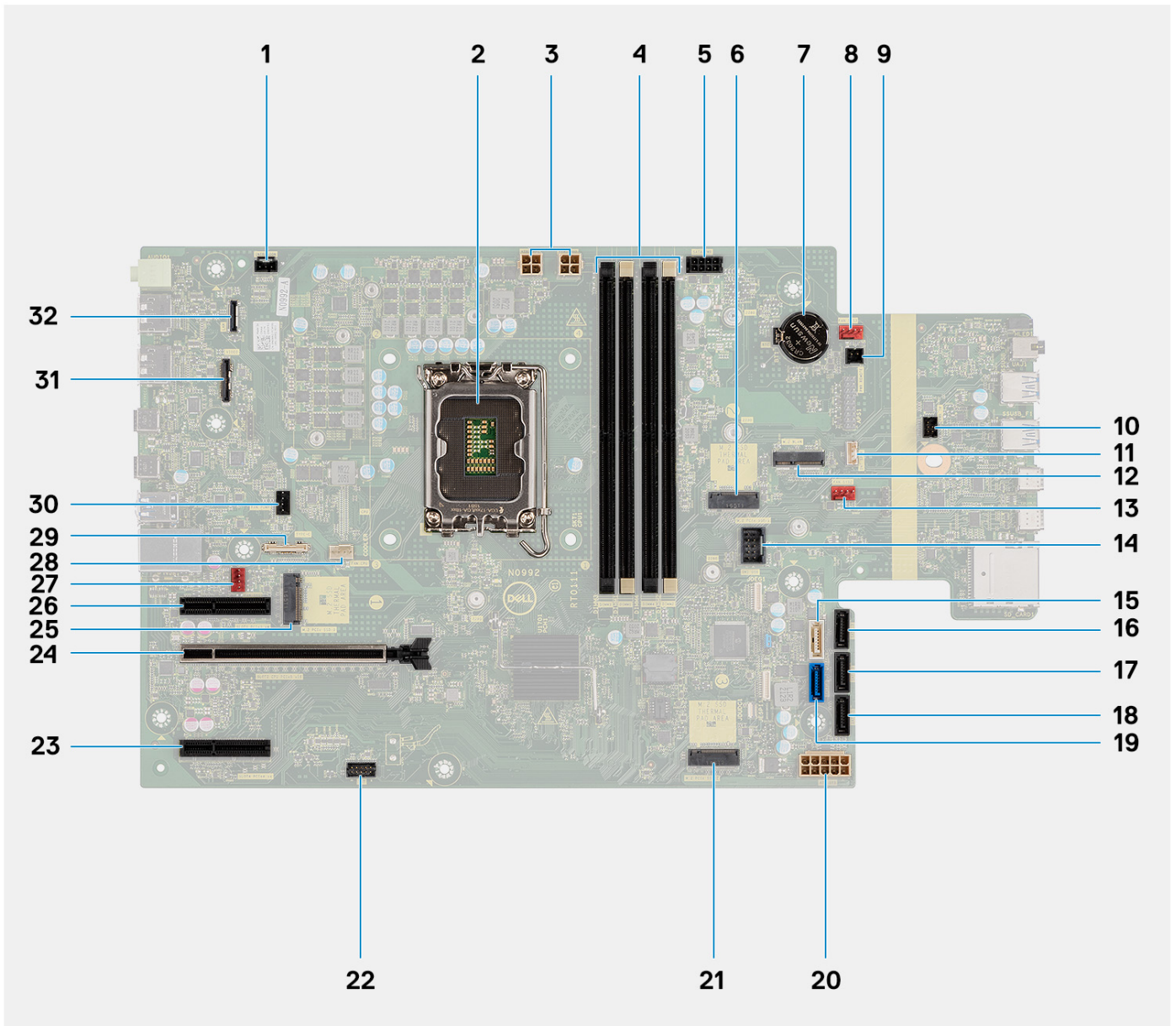

The following images indicate the location of the system board and provide a visual representation of the removal procedure.

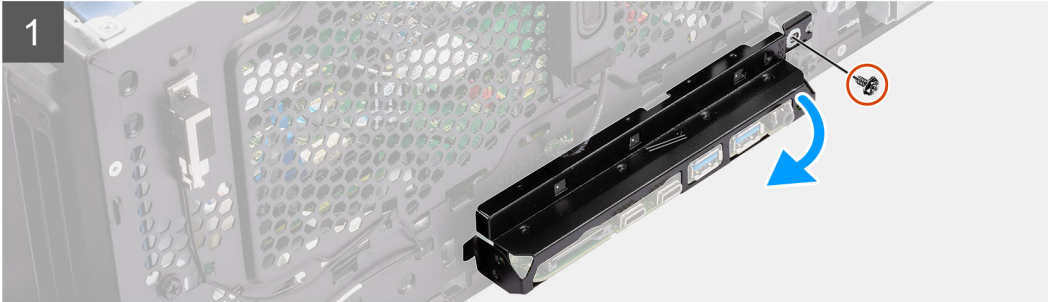
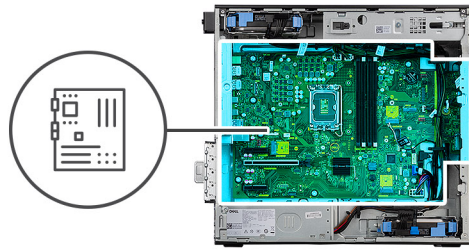

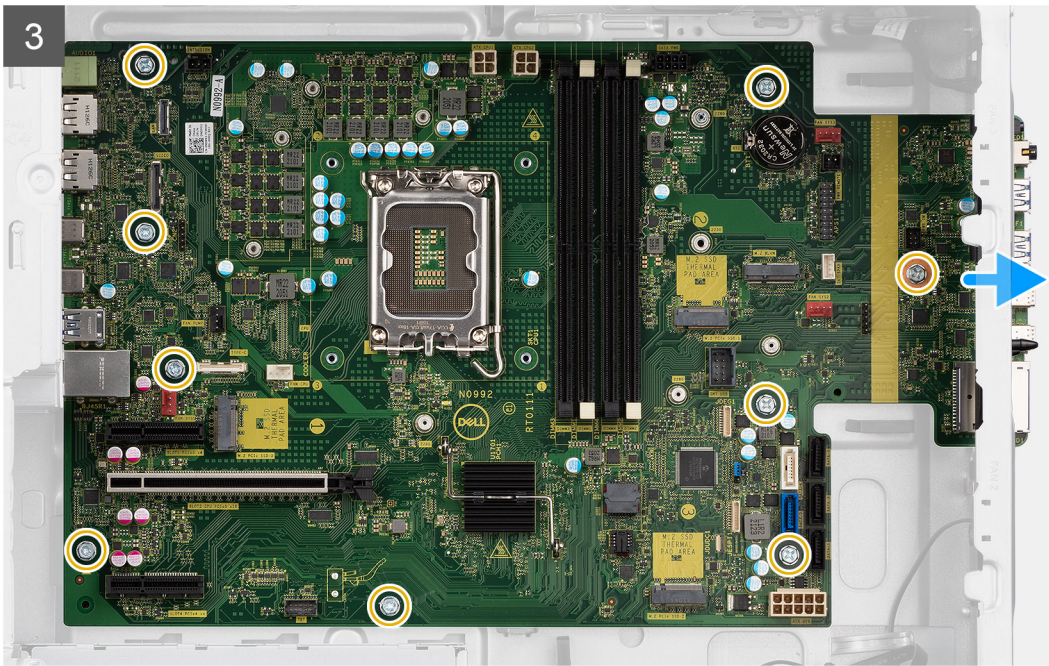

Steps

1. Remove the (#6-32) screw that secures the front I/O-bracket to the chassis.
2. Slide and remove the front I/O-bracket from the chassis.
3. Disconnect the power and HDD cables that are connected to the system board and unroute them from the routing guides on the chassis.
4. Remove the nine (#6-32) screws that secure the system board to the chassis.
5. Lift the system board at an angle and remove the system board off the chassis.

Installing the system board

Prerequisites

If you are replacing a component, remove the existing component before performing the installation procedure.

About this task

The following image indicates the connectors on your system board.

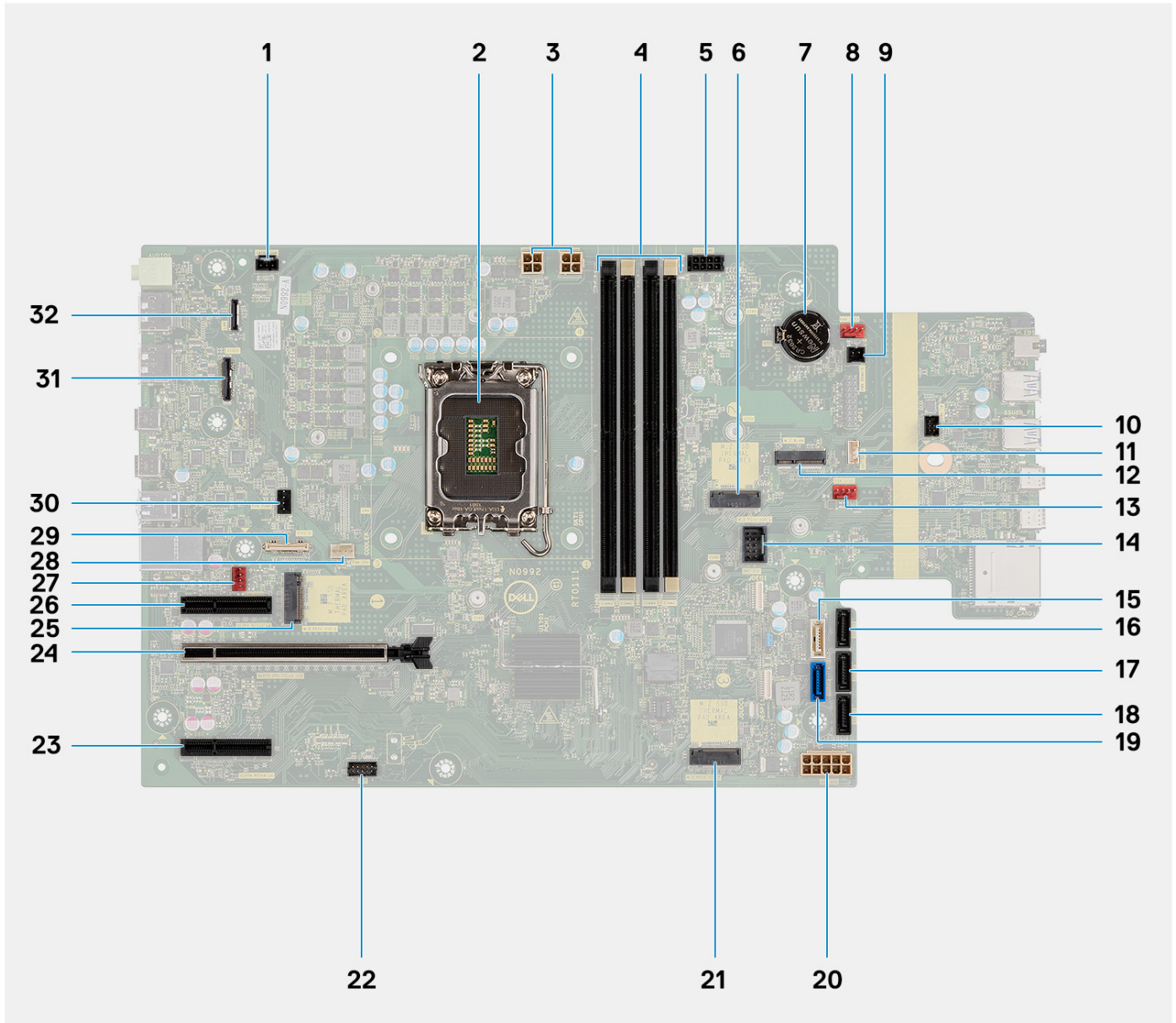

The following images indicate the location of the system board and provide a visual representation of the installation procedure.



1x
#6-32



9x
#6-32

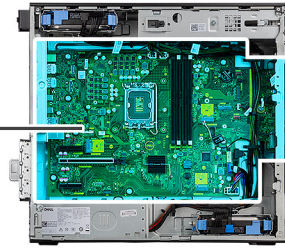

1

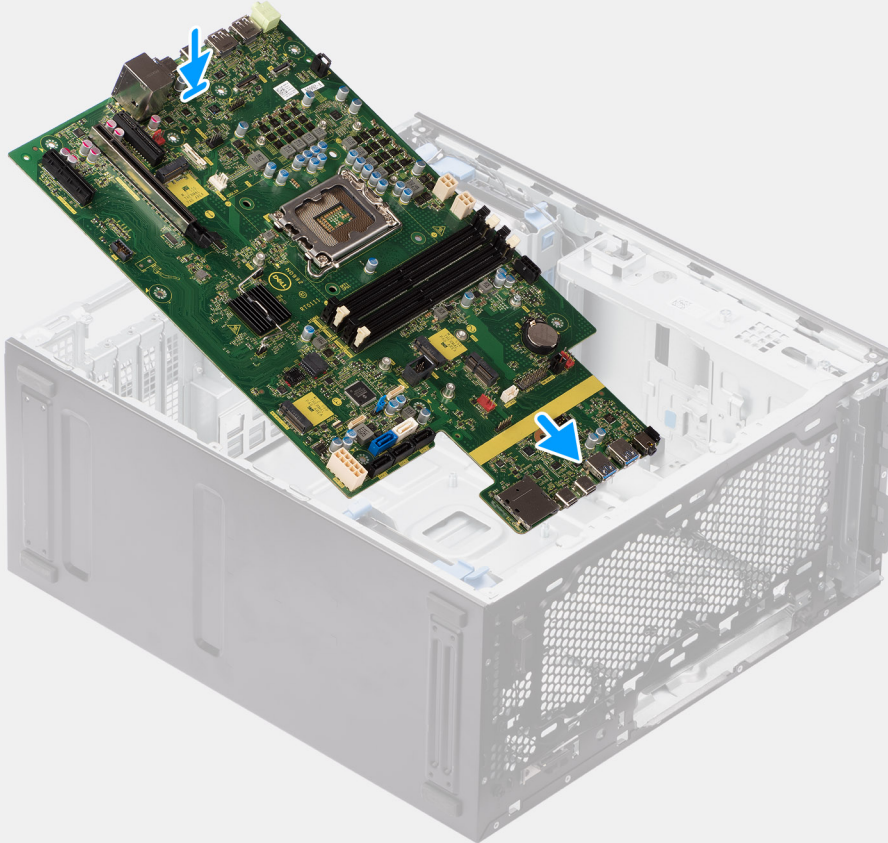

2

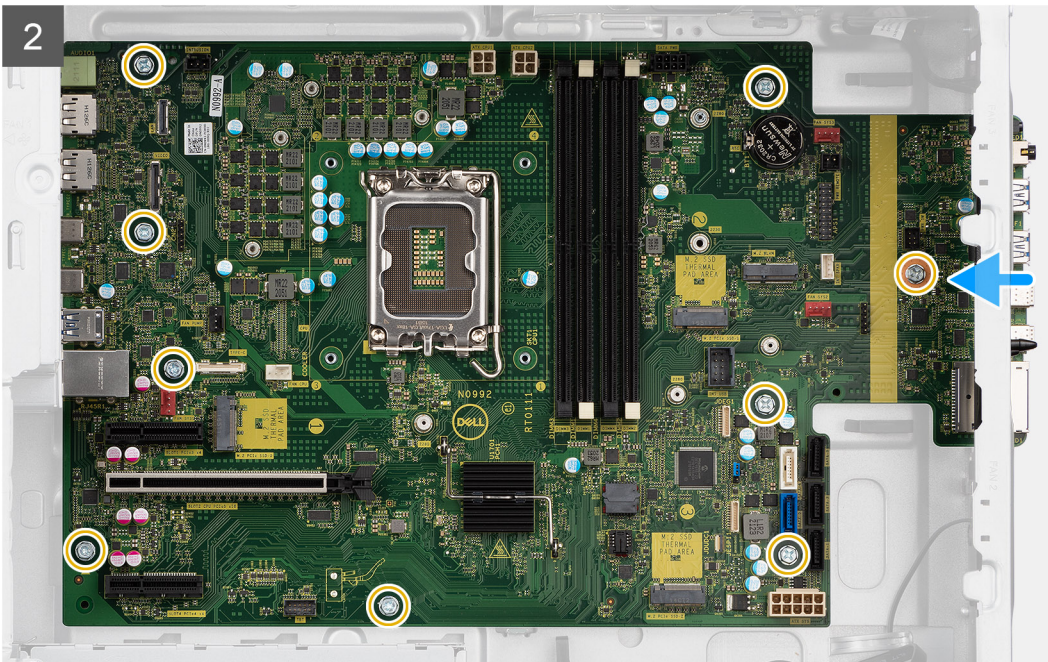

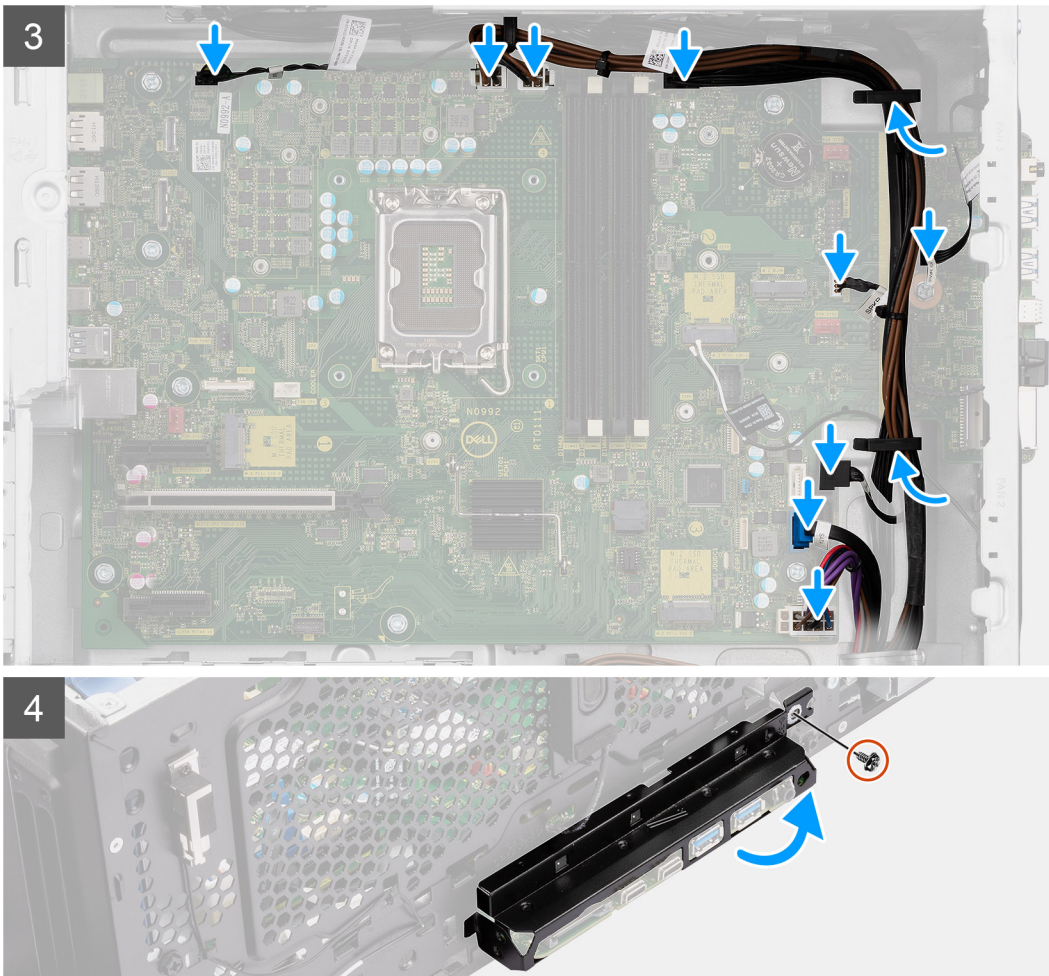

Steps



1. Slide the front I/O-ports on the system board into the front I/O-slots on the chassis and align the screw holes on the system board with the screw holes on the chassis.
2. Replace the nine (#6-32) screws that secure the system board to the chassis.
3. Route the cables through the routing guides on the chassis and connect the power and HDD cables to their respective connectors on the system board.
4. Align the front I/O-bracket with the slots on the chassis.
5. Replace the (#6-32) screw that secures the front I/O-bracket to the chassis.

Next steps

1. Install the [processor](#).
2. Install the [liquid cooler](#).
3. Install the [chassis fan](#).
4. Install the [processor fan and 125 W heat-sink assembly](#) or [processor fan and heat-sink assembly](#).
5. Install the [coin-cell battery](#).
6. Install the [intrusion switch](#).
7. Install the [intrusion speaker](#).
8. Install the [powered GPU](#).

i **NOTE:** This step is required only if the system is configured with powered GPU.

9. Install the [graphics card](#).
10. Install the [M.2 2230 SSD/M.2 2280 SSD](#).
11. Install the [WLAN](#).
12. Install the [memory module](#).
13. Install the [fan duct](#)

14. Install the [front bezel](#).
15. Install the [side cover](#).
16. Follow the procedure in [after working inside your computer](#).
 -  **NOTE:** Your computer's Service Tag is stored in the system board. You must enter the Service Tag in the BIOS setup program after you replace the system board.
 -  **NOTE:** Replacing the system board removes any changes that you have made to the BIOS using the BIOS setup program. You must make the appropriate changes again after you replace the system board.

Software

This chapter details the supported operating systems along with instructions on how to install the drivers.

Drivers and downloads

When troubleshooting, downloading or installing drivers it is recommended that you read the Dell Knowledge Based article, Drivers and Downloads FAQ [000123347](#).

System setup

CAUTION: Unless you are an expert computer user, do not change the settings in the BIOS Setup program. Certain changes can make your computer work incorrectly.

NOTE: Before you change BIOS Setup program, it is recommended that you write down the BIOS Setup program screen information for future reference.

Use the BIOS Setup program for the following purposes:

- Get information about the hardware installed in your computer, such as the amount of RAM and the size of the hard drive.
- Change the system configuration information.
- Set or change a user-selectable option, such as the user password, type of hard drive installed, and enabling or disabling base devices.

Boot menu

Press <F12> when the Dell logo appears to initiate a one-time boot menu with a list of the valid boot devices for the system. Diagnostics and BIOS Setup options are also included in this menu. The devices listed on the boot menu depend on the bootable devices in the system. This menu is useful when you are attempting to boot to a particular device or to bring up the diagnostics for the system. Using the boot menu does not make any changes to the boot order stored in the BIOS.

The options are:

- UEFI Boot:
 - Windows Boot Manager
- Other Options:
 - BIOS Setup
 - BIOS Flash Update
 - Diagnostics
 - Change Boot Mode Settings

Navigation keys

NOTE: For most of the System Setup options, changes that you make are recorded but do not take effect until you restart the system.

Keys	Navigation
Up arrow	Moves to the previous field.
Down arrow	Moves to the next field.
Enter	Selects a value in the selected field (if applicable) or follow the link in the field.
Spacebar	Expands or collapses a drop-down list, if applicable.
Tab	Moves to the next focus area.
Esc	Moves to the previous page until you view the main screen. Pressing Esc in the main screen displays a message that prompts you to save any unsaved changes and restarts the system.

Boot Sequence

Boot sequence enables you to bypass the System Setup–defined boot device order and boot directly to a specific device (for example: optical drive or hard drive). During the Power-on Self-Test (POST), when the Dell logo appears, you can:

- Access System Setup by pressing F2 key
- Bring up the one-time boot menu by pressing F12 key.

The one-time boot menu displays the devices that you can boot from including the diagnostic option. The boot menu options are:

- Removable Drive (if available)
- STXXXX Drive
i **NOTE:** XXXX denotes the SATA drive number.
- Optical Drive (if available)
- SATA Hard Drive (if available)
- Diagnostics
i **NOTE:** Choosing **Diagnostics**, displays the **SupportAssist** screen.

The boot sequence screen also displays the option to access the System Setup screen.

System setup options

i **NOTE:** Depending on your computer and its installed devices, the items that are listed in this section may or may not appear.

Table 3. System setup options—System information menu

Overview	
Precision 3660 Tower	
BIOS Version	Displays the BIOS version number.
Service Tag	Displays the Service Tag of the computer.
Asset Tag	Displays the Asset Tag of the computer.
Manufacture Date	Displays the manufacture date of the computer.
Ownership Date	Displays the ownership date of the computer.
Express Service Code	Displays the express service code of the computer.
Ownership Tag	Displays the Ownership Tag of the computer.
Signed Firmware Update	Displays whether the Signed Firmware Update is enabled on your computer.
Processor Information	
Processor Type	Displays the processor type.
Maximum Clock Speed	Displays the maximum processor clock speed.
Minimum Clock Speed	Displays the minimum processor clock speed.
Current Clock Speed	Displays the current processor clock speed.
Core Count	Displays the number of cores on the processor.
Processor ID	Displays the processor identification code.
Processor L2 Cache	Displays the processor L2 Cache size.
Processor L3 Cache	Displays the processor L3 Cache size.
Microcode Version	Displays the microcode version.
Intel Hyper-Threading Capable	Displays whether the processor is Hyper-Threading (HT) capable.
64-Bit Technology	Displays whether 64-bit technology is used.

Table 3. System setup options—System information menu (continued)

Overview	
Memory Information	
Memory Installed	Displays the total computer memory installed.
Memory Available	Displays the total computer memory available.
Memory Speed	Displays the memory speed.
Memory Channel Mode	Displays single or dual channel mode.
Memory Technology	Displays the technology that is used for the memory.
DIMM 1 Size	Displays the DIMM 1 memory size.
DIMM 2 Size	Displays the DIMM 2 memory size.
DIMM 3 Size	Displays the DIMM 3 memory size.
DIMM 4 Size	Displays the DIMM 4 memory size.
Devices Information	
Video Controller	Displays the video controller type of the computer.
Video Memory	Displays the video memory information of the computer.
Wi-Fi Device	Displays the wireless device information of the computer.
Native Resolution	Displays the native resolution of the computer.
Video BIOS Version	Displays the video BIOS version of the computer.
Audio Controller	Displays the audio controller information of the computer.
Bluetooth Device	Displays the Bluetooth device information of the computer.
LOM MAC Address	Displays the LAN On Motherboard (LOM) MAC address of the computer.
dGPU Video Controller	Displays the discrete video controller type of the computer.
Slot 1	Displays the SATA hard drive information of the computer.
Slot 2	Displays the SATA hard drive information of the computer.
Slot 3	Displays the SATA hard drive information of the computer.
Slot 4	Displays the SATA hard drive information of the computer.

Table 4. System setup options—Boot Configuration menu

Boot Configuration	
Boot Sequence	
Boot Mode: UEFI only	Displays the boot mode.
Boot Sequence	Displays the boot sequence.
Secure Digital (SD) Card Boot	Enable or disable the SD card read-only boot. By default, the Secure Digital (SD) Card Boot option is not enabled.
Secure Boot	
Enable Secure Boot	Enable or disable the secure boot feature. By default, the option is not enabled.
Secure Boot Mode	Enable or disable to change the secure boot mode options. By default, the Deployed Mode is enabled.
Expert Key Management	
Enable Custom Mode	Enable or disable custom mode.

Table 4. System setup options—Boot Configuration menu (continued)

Boot Configuration	
	By default, the custom mode option is not enabled.
Custom Mode Key Management	Select the custom values for expert key management.

Table 5. System setup options—Integrated Devices menu

Integrated Devices	
Date/Time	Displays the current date in MM/DD/YYYY format and current time in HH:MM:SS AM/PM format.
Audio	
Enable Audio	Enable or disable the integrated audio controller. By default, all the options are enabled.
Serial Port	
Serial Port Configuration	Enable or disable the serial port address. By default, the COM1: Port is configured at 3F8h with IRQ4 option is enabled.
USB Configuration	<ul style="list-style-type: none"> Enable or disable booting from USB mass storage devices through the boot sequence or boot menu. By default, all the options are enabled.
Front USB Configuration	Enable or disable the individual front USB ports. By default, all the options are enabled.
Rear USB Configuration	Enable or disable the individual rear USB ports. By default, all the options are enabled.
Miscellaneous Devices	Enable or disable the PCI Slot By default, the option is enabled.
Dust Filter Maintenance	Enable or disable the dust filter maintenance. By default, the Disabled option is enabled.

Table 6. System setup options—Storage menu

Storage	
SATA Operation	Enable or disable the operating mode of the integrated SATA hard drive controller. By default, the RAID On option is enabled.
Storage Interface	
Port Enablement	Enable or disable the onboard drives. By default, all the options are enabled.
SMART Reporting	
Enable SMART Reporting	Enable or disable Self-Monitoring, Analysis, and Reporting Technology (SMART) during computer startup. By default, the Enable SMART Reporting option is not enabled.
Drive Information	
SATA-0	
Type	Displays the SATA HDD type information of the computer.

Table 6. System setup options—Storage menu (continued)

Storage	
Device	Displays the SATA HDD device information of the computer.
SATA-1	
Type	Displays the SATA HDD type information of the computer.
Device	Displays the SATA HDD device information of the computer.
SATA-2	
Type	Displays the SATA HDD type information of the computer.
Device	Displays the SATA HDD device information of the computer.
SATA-3	
Type	Displays the SATA HDD type information of the computer.
Device	Displays the SATA HDD device information of the computer.
M.2 PCIe SSD-0	
Type	Displays the M.2 PCIe SSD-0 type information of the computer.
Device	Displays the M.2 PCIe SSD-0 device information of the computer.
M.2 PCIe SSD-1	
Type	Displays the M.2 PCIe SSD-1 type information of the computer.
Device	Displays the M.2 PCIe SSD-1 device information of the computer.
Enable MediaCard	
Secure Digital (SD) Card	Enable or disable the SD card. By default, the Secure Digital (SD) Card option is enabled.
Secure Digital (SD) Card Read-Only Mode	Enable or disable the SD card read-only mode. By default, the Secure Digital (SD) Card Read-Only Mode option is not enabled.

Table 7. System setup options—Display menu

Display	
Multi-Display	
Enable Multi-Display	Enable or disable the Enable Multi-Display buttons on the computer. By default, the option is enabled.
Primary Display	
Video Primary Display	Determines the primary display when multiple controllers are available on the computer By default, the Auto option is enabled.
Full Screen Logo	
	Enable or disable full screen logo. By default, the option is not enabled.

Table 8. System setup options—Connection menu

Connection	
Network Controller Configuration	
Integrated NIC	Controls the on-board LAN controller. By default, the Enabled with PXE option is enabled.

Table 8. System setup options—Connection menu (continued)

Connection	
Wireless Device Enable	
WLAN	Enable or disable the internal WLAN device By default, the option enabled.
Bluetooth	Enable or disable the internal Bluetooth device By default, the option enabled.
Enable UEFI Network Stack	Enable or disable UEFI Network Stack and controls the on-board LAN Controller. By default, the option is enabled.
HTTPs Boot Feature	
HTTPs Boot	Enable or disable the HTTPs Boot feature. By default, the HTTPs Boot option is enabled.
HTTPs Boot Mode	With Auto Mode, the HTTPs Boot extracts Boot URL from the DHCP. With Manual Mode, the HTTPs Boot reads Boot URL from the user-provided data. By default, the Auto Mode option is enabled.

Table 9. System setup options—Power menu

Power	
USB PowerShare	
Enable USB PowerShare	Enable or disable the USB PowerShare. By default, the Enable USB PowerShare option is enabled
USB Wake Support	
Enable USB Wake Support	When enabled, you can use the USB devices like a mouse or keyboard to wake your computer from standby. By default, the option is enabled.
AC Behavior	
AC Recovery	Enables the system to turn on automatically, when AC is inserted. By default, the Power Off option is enabled.
Active State Power Management	
Aspm	Enables or disables the Active State Power Management (ASPM) level By default, the Auto option is enabled.
Block Sleep	
	Enables to block entering sleep (S3) mode in the operating system. By default, the Block Sleep option is disabled.
Deep Sleep Control	
	Enable or disable the Deep Sleep mode support. By default, the Disabled option is enabled.
Fan Control Override	
	Enable or disable the fan control override feature. By default, the option is disabled.
Intel Speed Shift Technology	
	Enable or disable the Intel speed shift technology support. By default, the Intel Speed Shift Technology option is enabled.

Table 10. System setup options—Security menu

Security	
TPM 2.0 Security	
TPM 2.0 Security On	Enable or disable TPM 2.0 security options. By default, the TPM 2.0 Security On option is enabled.
Attestation Enable	Enables to control whether the Trusted Platform Module (TPM) Endorsement Hierarchy is available to the operating system. By default, the Attestation Enable option is enabled.
Key Storage Enable	Enables to control whether the Trusted Platform Module (TPM) Storage Hierarchy is available to the operating system. By default, the Key Storage Enable option is enabled.
SHA-256	BIOS and the TPM will use the SHA-256 hash algorithm to extend measurements into the TPM PCRs during BIOS boot. By default, the SHA-256 option is enabled.
Clear	Enables to clear the TPM owner information and returns the TPM to the default state. By default, the Clear option is disabled.
PPI ByPass for Clear Commands	Controls the TPM Physical Presence Interface (PPI). By default, the PPI ByPass for clear Commands option is disabled.
Chassis intrusion	Controls the chassis intrusion feature. By default, the option is disabled.
SMM Security Mitigation	Enable or disable SMM Security Mitigation. By default, the option is enabled.
Data Wipe on Next Boot	
Start Data Wipe	Enable or disable the data wipe on next boot. By default, the option is disabled.
Absolute	Enable or disable or permanently disable the BIOS module interface of the optional Absolute Persistence Module service from Absolute software. By default, the Enable Absolute option is enabled.
UEFI Boot Path Security	Controls whether or not the computer will prompt the user to enter the admin password (if set) when booting to a UEFI boot device from the F12 boot menu. By default, the Always Except Internal HDD option is enabled.

Table 11. System setup options—Passwords menu

Passwords	
Admin Password	Set, change, or delete the administrator password.
System Password	Set, change, or delete the computer password.
Internal HDD-0 Password	Set, change, or delete the Internal HDD-0 password.
NVMe SSD0	Set, change, or delete the NVMe SSD0 password.
Password Configuration	
Upper Case Letter	Reinforces password must have at least one upper case letter. By default, the option is disabled.
Lower Case Letter	Reinforces password must have at least one lower case letter.

Table 11. System setup options—Passwords menu (continued)

Passwords	
Digit	By default, the option is disabled. Reinforces password must have at least one digit.
Special Character	By default, the option is disabled. Reinforces password must have at least one special character.
Minimum Characters	By default, the option is disabled. Set the minimum characters allowed for password.
Password Bypass	When enabled, this always prompts for computer and internal hard drive passwords when powered on from the off state. By default, the Disabled option is enabled.
Password Changes	
Enable Non-Admin Password Changes	Enable or disable to change computer and hard drive password without the need for admin password. By default, the option is enabled.
Admin Setup Lockout	
Enable Admin Setup Lockout	Enables administrators control over how their users can or cannot access BIOS setup. By default, the option is disabled.
Master Password Lockout	
Enable Master Password Lockout	When enabled, this will disable the master password support. By default, the option is disabled.
Allow Non-Admin PSID Revert	
Enable Allow Non-Admin PSID Revert	Controls access to the Physical Security ID (PSID) revert of NVMe hard-drives from the Dell Security Manager prompt. By default, the option is disabled.

Table 12. System setup options—Update, Recovery menu

Update, Recovery	
UEFI Capsule Firmware Updates	Enable or disable BIOS updates through UEFI capsule update packages. By default, the option is enabled.
BIOS Recovery from Hard Drive	Enables the user to recover from certain corrupted BIOS conditions from a recovery file on the user primary hard drive or an external USB key. By default, the option is enabled.
BIOS Downgrade	
Allow BIOS Downgrade	Enable or disable the flashing of the computer firmware to previous revision is blocked. By default, the option is enabled.
SupportAssist OS Recovery	Enable or disable the boot flow for SupportAssist OS Recovery tool in the event of certain computer errors. By default, the option is enabled.
BIOSConnect	Enable or disable cloud Service OS recovery if the main operating system fails to boot with the number of failures equal to or greater than the value specified

Table 12. System setup options—Update, Recovery menu (continued)

Update, Recovery	
	by the Auto OS Recovery Threshold setup option and local Service OS does not boot or is not installed. By default, the option is enabled.
Dell Auto OS Recovery Threshold	Controls the automatic boot flow for SupportAssist System Resolution Console and for Dell OS Recovery Tool. By default, the threshold value is set to 2.

Table 13. System setup options—System Management menu

System Management	
Service Tag	Display the Service Tag of the computer.
Asset Tag	Create a computer Asset Tag.
Wake on LAN/WLAN	Enable or disable the computer to power on by special LAN signals when it receives a wakeup signal from the WLAN. By default, the Disabled option is selected.
Auto on Time	Enable to set the computer to turn on automatically every day or on a preselected date and time. This option can be configured only if the Auto On Time is set to Everyday, Weekdays, or Selected Days. By default, the option is disabled.
Intel AMT Capability	Enable or disable the Intel AMT capability. By default, the Restrict MEBx Access option is enabled.
Enable Intel AMT Capability	
MEBx Hotkey	Enable or disable MEBx hotkey. By default, the option is disabled.
USB Provision	Enable or disable the Intel AMT provisioning using the local provisioning file through a USB storage device. By default, the option is disabled.
Enable USB Provision	
SERR Messages	Enable or disable SERR messages. By default, the option is enabled.
Dell Development Configuration	Enable or disable certain features to control BIOS By default, the option is disabled.
Enable Flash Updated Signature Override	

Table 14. System setup options—Keyboard menu

Keyboard	
Keyboard Errors	Enable or disable the keyboard error detection. By default, the option is enabled.
Enable Keyboard Error Detection	
Numlock LED	Enable or disable Numlock LED. By default, the option is enabled.
Enable Numlock LED	

Table 14. System setup options—Keyboard menu (continued)

Keyboard	
Device Configuration Hotkey Access	
Device Configuration Hotkey Access	Enable or disable users to access device configuration by using hotkeys. By default, the option is enabled.

Table 15. System setup options—Pre-boot Behavior menu

Pre-boot Behavior	
Warning and Errors	Enable or disable the action to be done when a warning or error is encountered. By default, the Prompt on Warnings and Errors option is enabled.
Fastboot	Enable to set the speed of the boot process. By default, the Minimal option is enabled.
Extend BIOS POST Time	Set the BIOS POST time. By default, the 0 seconds option is enabled.

Table 16. System setup options—Virtualization menu

Virtualization	
Intel Virtualization Technology	
Enable Intel Virtualization Technology (VT)	Specify whether a Virtual Machine Monitor (VMM) can utilize the additional hardware capabilities that are provided by Intel Virtualization Technology. By default, the option is enabled.
VT for Direct I/O	Specify whether a Virtual Machine Monitor (VMM) can utilize the additional hardware capabilities that are provided by Intel Virtualization Technology for Direct I/O. By default, the option is enabled.
Intel Trusted Execution Technology (TXT)	
Enable Intel Trusted Execution Technology (TXT)	Specifies whether a measured Virtual Machine Monitor (MVMM) can utilize the additional hardware capabilities that are provided by Intel Trusted Execution Technology. By default, the option is disabled.

Table 17. System setup options—Performance menu

Performance	
Multi Core Support	
Active Cores	Enables to change the number of CPU cores available to the operating system. By default, the All Cores options are enabled.
Intel SpeedStep	
Enable Intel SpeedStep Technology	Enables the computer to dynamically adjust processor voltage and core frequency, decreasing average power consumption and heat production. By default, the option is enabled.
C-States Control	
Enable C-State Control	Enable or disable additional processor sleep states. By default, the option is enabled.

Table 17. System setup options—Performance menu (continued)

Performance	
Intel Turbo Boost Technology	
Enable Intel Turbo Boost Technology	Enable or disable Intel TurboBoost mode of the processor. By default, the option is enabled.
Intel Hyper-Threading Technology	
Enable Intel Hyper-Threading Technology	Enable or disable Hyper-Threading in the processor. By default, the option is enabled.

Table 18. System setup options—System Logs menu

System Logs	
BIOS Event Log	
Clear BIOS Event Log	Display BIOS events. By default, the Keep option is enabled.

Updating the BIOS

Updating the BIOS in Windows

About this task

 **CAUTION:** If BitLocker is not suspended before updating the BIOS, the next time you reboot the system it will not recognize the BitLocker key. You will then be prompted to enter the recovery key to progress and the system will ask for this on each reboot. If the recovery key is not known this can result in data loss or an unnecessary operating system re-install. For more information on this subject, see Knowledge Article: <https://www.dell.com/support/article/sln153694>

Steps

1. Go to www.dell.com/support.
2. Click **Product support**. In the **Search support** box, enter the Service Tag of your computer, and then click **Search**.
 **NOTE:** If you do not have the Service Tag, use the SupportAssist feature to automatically identify your computer. You can also use the product ID or manually browse for your computer model.
3. Click **Drivers & Downloads**. Expand **Find drivers**.
4. Select the operating system installed on your computer.
5. In the **Category** drop-down list, select **BIOS**.
6. Select the latest version of BIOS, and click **Download** to download the BIOS file for your computer.
7. After the download is complete, browse the folder where you saved the BIOS update file.
8. Double-click the BIOS update file icon and follow the on-screen instructions.
For more information, see knowledge base article [000124211](https://www.dell.com/support/article/000124211) at www.dell.com/support.

Updating the BIOS in Linux and Ubuntu

To update the system BIOS on a computer that is installed with Linux or Ubuntu, see the knowledge base article [000131486](https://www.dell.com/support/article/000131486) at www.dell.com/support.

Updating the BIOS using the USB drive in Windows

About this task

 **CAUTION:** If BitLocker is not suspended before updating the BIOS, the next time you reboot the system it will not recognize the BitLocker key. You will then be prompted to enter the recovery key to progress and the system will ask for this on each reboot. If the recovery key is not known this can result in data loss or an unnecessary operating system re-install. For more information on this subject, see Knowledge Article: <https://www.dell.com/support/article/sln153694>

Steps

1. Follow the procedure from step 1 to step 6 in [Updating the BIOS in Windows](#) to download the latest BIOS setup program file.
2. Create a bootable USB drive. For more information, see the knowledge base article [000145519](#) at www.dell.com/support.
3. Copy the BIOS setup program file to the bootable USB drive.
4. Connect the bootable USB drive to the computer that needs the BIOS update.
5. Restart the computer and press **F12**.
6. Select the USB drive from the **One Time Boot Menu**.
7. Type the BIOS setup program filename and press **Enter**.
The **BIOS Update Utility** appears.
8. Follow the on-screen instructions to complete the BIOS update.

Updating the BIOS from the F12 One-Time boot menu

Update your computer BIOS using the BIOS update.exe file that is copied to a FAT32 USB drive and booting from the F12 One-Time boot menu.

About this task

 **CAUTION:** If BitLocker is not suspended before updating the BIOS, the next time you reboot the system it will not recognize the BitLocker key. You will then be prompted to enter the recovery key to progress and the system will ask for this on each reboot. If the recovery key is not known this can result in data loss or an unnecessary operating system re-install. For more information on this subject, see Knowledge Article: <https://www.dell.com/support/article/sln153694>

BIOS Update

You can run the BIOS update file from Windows using a bootable USB drive or you can also update the BIOS from the F12 One-Time boot menu on the computer.

Most of the Dell computers built after 2012 have this capability, and you can confirm by booting your computer to the F12 One-Time Boot Menu to see if BIOS FLASH UPDATE is listed as a boot option for your computer. If the option is listed, then the BIOS supports this BIOS update option.

 **NOTE:** Only computers with BIOS Flash Update option in the F12 One-Time boot menu can use this function.

Updating from the One-Time boot menu

To update your BIOS from the F12 One-Time boot menu, you need the following:

- USB drive formatted to the FAT32 file system (key does not have to be bootable)
- BIOS executable file that you downloaded from the Dell Support website and copied to the root of the USB drive
- AC power adapter that is connected to the computer
- Functional computer battery to flash the BIOS

Perform the following steps to perform the BIOS update flash process from the F12 menu:

 **CAUTION:** Do not turn off the computer during the BIOS update process. The computer may not boot if you turn off your computer.

Steps

1. From a turn off state, insert the USB drive where you copied the flash into a USB port of the computer.
2. Turn on the computer and press F12 to access the One-Time Boot Menu, select BIOS Update using the mouse or arrow keys then press Enter.
The flash BIOS menu is displayed.
3. Click **Flash from file**.
4. Select external USB device.
5. Select the file and double-click the flash target file, and then click **Submit**.
6. Click **Update BIOS**. The computer restarts to flash the BIOS.
7. The computer will restart after the BIOS update is completed.

System and setup password

Table 19. System and setup password

Password type	Description
System password	Password that you must enter to log on to your system.
Setup password	Password that you must enter to access and make changes to the BIOS settings of your computer.

You can create a system password and a setup password to secure your computer.

 **CAUTION:** The password features provide a basic level of security for the data on your computer.

 **CAUTION:** Anyone can access the data stored on your computer if it is not locked and left unattended.

 **NOTE:** System and setup password feature is disabled.

Assigning a system setup password

Prerequisites

You can assign a new **System or Admin Password** only when the status is in **Not Set**.

About this task

To enter the system setup, press F2 immediately after a power-on or reboot.

Steps

1. In the **System BIOS** or **System Setup** screen, select **Security** and press **Enter**.
The **Security** screen is displayed.
2. Select **System/Admin Password** and create a password in the **Enter the new password** field.
Use the following guidelines to assign the system password:
 - A password can have up to 32 characters.
 - The password can contain the numbers 0 through 9.
 - Only lower case letters are valid, upper case letters are not allowed.
 - Only the following special characters are allowed: space, ("), (+), (.), (-), (.), (/), (;), ([), (\), (]), (`).
3. Type the system password that you entered earlier in the **Confirm new password** field and click **OK**.
4. Press **Esc** and a message prompts you to save the changes.
5. Press **Y** to save the changes.
The computer reboots.

Deleting or changing an existing system setup password

Prerequisites

Ensure that the **Password Status** is Unlocked (in the System Setup) before attempting to delete or change the existing System and Setup password. You cannot delete or change an existing System or Setup password, if the **Password Status** is Locked.

About this task

To enter the System Setup, press **F2** immediately after a power-on or reboot.

Steps

1. In the **System BIOS** or **System Setup** screen, select **System Security** and press **Enter**.
The **System Security** screen is displayed.
2. In the **System Security** screen, verify that **Password Status** is **Unlocked**.
3. Select **System Password**, alter or delete the existing system password and press **Enter** or **Tab**.
4. Select **Setup Password**, alter or delete the existing setup password and press **Enter** or **Tab**.
 **NOTE:** If you change the System and/or Setup password, re enter the new password when prompted. If you delete the System and Setup password, confirm the deletion when prompted.
5. Press **Esc** and a message prompts you to save the changes.
6. Press **Y** to save the changes and exit from System Setup.
The computer restarts.

Troubleshooting

System Limitations

This section contains information about some new features and need-to-know information about this computer.

- Modern Standby Limitations
- Intel System Agent Enhanced Speed Step (SAGV) always disabled
- System board TPM settings through BIOS

Modern Standby Limitations

- Legacy PCI cards do not support Modern Standby through TI PCI bridge.
- Enterprise Hard Drives do not support Modern Standby.
- Systems with 2.5-inch/ 3.5-inch Hard drives take longer to enter Modern Standby for the first time. System can enter Modern Standby normally from the second time onwards.
- Graphics Cards or Add-In Cards not factory installed by Dell may not be Modern Standby compliant and would not allow the system to enter Modern Standby.
- PSU LED may not turn off sporadically even after system enters Modern Standby

Table 20. System behavior with HDDs/ AICs which do not support Modern Standby

	Screen	dGfx fan	Hard drive LED	PWR LED	PSU LED	PSU fan	CPU fan	System fan
Expected system behavior under Modern Standby	Off	Off	Off	Off	Off	Off	Off	Off
Enterprise SATA hard drive	Off	Off	Off	Off	On	On	On	On
PCIe AIC not supporting ModS	Off	Off/On (Up to dGfx)	Off/On	Off/On (by S/W Drips)	On	On	On	On
Legacy PCI Card (via TI Bridge)	Off	Off/On (Up to dGfx)	Off/On	Off/On (by S/W Drips)	On	On	On	On

NOTE: ModS = Modern Standby

NOTE: PSU = Power Supply Unit

NOTE: CPU = Processor

Intel System Agent Enhanced Speed Step (SAGV) always disabled

All systems will have SAGV disabled by default. If enabled, systems will incur additional boot time when memory is added or swapped.

System board TPM settings through BIOS

Service replacement system boards replaced in the field default to TPM enabled. This setting is generally applicable for most computers in the Rest of the World, and technicians are not required to change it.

Technicians need to select the "Enable Firmware/Integrated TPM - for Regional Restrictions" when a tech sheet is received with the service replacement system board. This permanently disables the Discrete "Hardware" TPM and this mainly applies to China region.

SupportAssist diagnostics

About this task

The SupportAssist diagnostics (previously known as ePSA diagnostics) performs a complete check of your hardware. The SupportAssist diagnostics is embedded in the BIOS and is launched by it internally. The SupportAssist diagnostics provides a set of options for particular devices or device groups. It allows you to:

- Run tests automatically or in an interactive mode.
- Repeat tests
- Display or save test results
- Run thorough tests to introduce additional test options and provide extra information about the failed device(s)
- View status messages that indicate if the tests are completed successfully
- View error messages that indicate if problems were encountered during the test

NOTE: Some tests are meant for specific devices and require user interaction. Ensure that you are present in front of the computer when the diagnostic tests are performed.

For more information, see [SupportAssist Pre-Boot System Performance Check](#).

Diagnostic LED behavior

Table 21. Diagnostic LED behavior

Blinking pattern		Problem description	Suggested resolution
Amber	White		
1	2	Unrecoverable SPI Flash Failure	
2	1	CPU failure	<ul style="list-style-type: none"> • Run the Dell Support Assist/Dell Diagnostics tool. • If problem persists, replace the system board.
2	2	System board failure (included BIOS corruption or ROM error)	<ul style="list-style-type: none"> • Flash latest BIOS version • If problem persists, replace the system board.
2	3	No memory/RAM detected	<ul style="list-style-type: none"> • Confirm that the memory module is installed properly. • If problem persists, replace the memory module.
2	4	Memory/RAM failure	<ul style="list-style-type: none"> • Reset the memory module. • If problem persists, replace the memory module.
2	5	Invalid memory installed	<ul style="list-style-type: none"> • Reset the memory module.

Table 21. Diagnostic LED behavior (continued)

Blinking pattern		Problem description	Suggested resolution
Amber	White		
			<ul style="list-style-type: none"> If problem persists, replace the memory module.
2	6	System board / Chipset Error / Clock failure / Gate A20 failure / Super I/O failure / Keyboard controller failure	<ul style="list-style-type: none"> Flash latest BIOS version If problem persists, replace the system board.
3	1	CMOS battery failure	<ul style="list-style-type: none"> Reset the CMOS battery connection. If problem persists, replace the RTS battery.
3	2	PCI or Video card/chip failure	Replace the system board.
3	3	BIOS Recovery image not found	<ul style="list-style-type: none"> Flash latest BIOS version If problem persists, replace the system board.
3	4	BIOS Recovery image found but invalid	<ul style="list-style-type: none"> Flash latest BIOS version If problem persists, replace the system board.
3	5	Power rail failure	<ul style="list-style-type: none"> EC ran into power sequencing failure. If problem persists, replace the system board.
3	6	SBIOS Flash corruption	<ul style="list-style-type: none"> Flash corruption detected by SBIOS If problem persists, replace the system board.
3	7	Intel ME (Management Engine) Error	<ul style="list-style-type: none"> Timeout waiting on ME to reply to HECI message If problem persists, replace the system board.
4	2	CPU Power Cable Connection Issue	

Recovering the operating system

When your computer is unable to boot to the operating system even after repeated attempts, it automatically starts Dell SupportAssist OS Recovery.

Dell SupportAssist OS Recovery is a standalone tool that is preinstalled in all Dell computers installed with Windows operating system. It consists of tools to diagnose and troubleshoot issues that may occur before your computer boots to the operating system. It enables you to diagnose hardware issues, repair your computer, back up your files, or restore your computer to its factory state.

You can also download it from the Dell Support website to troubleshoot and fix your computer when it fails to boot into their primary operating system due to software or hardware failures.

For more information about the Dell SupportAssist OS Recovery, see *Dell SupportAssist OS Recovery User's Guide* at www.dell.com/serviceabilitytools. Click **SupportAssist** and then, click **SupportAssist OS Recovery**.

Updating the BIOS in Windows

Steps

1. Go to www.dell.com/support.
2. Click **Product support**. In the **Search support** box, enter the Service Tag of your computer, and then click **Search**.
 **NOTE:** If you do not have the Service Tag, use the SupportAssist feature to automatically identify your computer. You can also use the product ID or manually browse for your computer model.
3. Click **Drivers & Downloads**. Expand **Find drivers**.
4. Select the operating system installed on your computer.
5. In the **Category** drop-down list, select **BIOS**.
6. Select the latest version of BIOS, and click **Download** to download the BIOS file for your computer.
7. After the download is complete, browse the folder where you saved the BIOS update file.
8. Double-click the BIOS update file icon and follow the on-screen instructions.
For more information, see knowledge base article [000124211](https://www.dell.com/support/000124211) at www.dell.com/support.

Updating the BIOS using the USB drive in Windows

Steps

1. Follow the procedure from step 1 to step 6 in [Updating the BIOS in Windows](#) to download the latest BIOS setup program file.
2. Create a bootable USB drive. For more information, see the knowledge base article [000145519](https://www.dell.com/support/000145519) at www.dell.com/support.
3. Copy the BIOS setup program file to the bootable USB drive.
4. Connect the bootable USB drive to the computer that needs the BIOS update.
5. Restart the computer and press **F12**.
6. Select the USB drive from the **One Time Boot Menu**.
7. Type the BIOS setup program filename and press **Enter**.
The **BIOS Update Utility** appears.
8. Follow the on-screen instructions to complete the BIOS update.

Backup media and recovery options

It is recommended to create a recovery drive to troubleshoot and fix problems that may occur with Windows. Dell proposes multiple options for recovering Windows operating system on your Dell PC. For more information, see [Dell Windows Backup Media and Recovery Options](#).

WiFi power cycle

About this task

If your computer is unable to access the internet due to WiFi connectivity issues a WiFi power cycle procedure may be performed. The following procedure provides the instructions on how to conduct a WiFi power cycle:

 **NOTE:** Some ISPs (Internet Service Providers) provide a modem/router combo device.

Steps

1. Turn off your computer.
2. Turn off the modem.
3. Turn off the wireless router.
4. Wait for 30 seconds.
5. Turn on the wireless router.

6. Turn on the modem.
7. Turn on your computer.

Drain residual flea power (perform hard reset)

About this task

Flea power is the residual static electricity that remains in the computer even after it has been powered off and the battery is removed.

For your safety, and to protect the sensitive electronic components in your computer, you are requested to drain residual flea power before removing or replacing any components in your computer.

Draining residual flea power, also known as a performing a "hard reset", is also a common troubleshooting step if your computer does not power on or boot into the operating system.

To drain residual flea power (perform a hard reset)

Steps

1. Turn off your computer.
2. Disconnect the power adapter from your computer.
3. Remove the base cover.
4. Remove the battery.
5. Press and hold the power button for 20 seconds to drain the flea power.
6. Install the battery.
7. Install the base cover.
8. Connect the power adapter to your computer.
9. Turn on your computer.



 **NOTE:** For more information about performing a hard reset, see the knowledge base article [000130881](https://www.dell.com/support) at www.dell.com/support.

Getting help and contacting Dell

Self-help resources

You can get information and help on Dell products and services using these self-help resources:

Table 22. Self-help resources

Self-help resources	Resource location
Information about Dell products and services	www.dell.com
My Dell app	
Tips	
Contact Support	In Windows search, type <code>Contact Support</code> , and press Enter.
Online help for operating system	www.dell.com/support/windows www.dell.com/support/linux
Access top solutions, diagnostics, drivers and downloads, and learn more about your computer through videos, manuals and documents.	Your Dell computer is uniquely identified by a Service Tag or Express Service Code. To view relevant support resources for your Dell computer, enter the Service Tag or Express Service Code at www.dell.com/support . For more information on how to find the Service Tag for your computer, see Locate the Service Tag on your computer .
Dell knowledge base articles for a variety of computer concerns	<ol style="list-style-type: none"> 1. Go to www.dell.com/support. 2. On the menu bar at the top of the Support page, select Support > Knowledge Base. 3. In the Search field on the Knowledge Base page, type the keyword, topic, or model number, and then click or tap the search icon to view the related articles.

Contacting Dell

To contact Dell for sales, technical support, or customer service issues, see www.dell.com/contactdell.

 **NOTE:** Availability varies by country/region and product, and some services may not be available in your country/region.

 **NOTE:** If you do not have an active Internet connection, you can find contact information about your purchase invoice, packing slip, bill, or Dell product catalog.