

# RS6100

Wearable Scanner



**ZEBRA**

## Product Reference Guide

2023/10/17

ZEBRA and the stylized Zebra head are trademarks of Zebra Technologies Corporation, registered in many jurisdictions worldwide. All other trademarks are the property of their respective owners. ©2023 Zebra Technologies Corporation and/or its affiliates. All rights reserved.

Information in this document is subject to change without notice. The software described in this document is furnished under a license agreement or nondisclosure agreement. The software may be used or copied only in accordance with the terms of those agreements.

For further information regarding legal and proprietary statements, please go to:

SOFTWARE: [zebra.com/linkoslegal](https://zebra.com/linkoslegal).

COPYRIGHTS: [zebra.com/copyright](https://zebra.com/copyright).

PATENTS: [ip.zebra.com](https://ip.zebra.com).

WARRANTY: [zebra.com/warranty](https://zebra.com/warranty).

END USER LICENSE AGREEMENT: [zebra.com/eula](https://zebra.com/eula).

## Terms of Use

### Proprietary Statement

This manual contains proprietary information of Zebra Technologies Corporation and its subsidiaries ("Zebra Technologies"). It is intended solely for the information and use of parties operating and maintaining the equipment described herein. Such proprietary information may not be used, reproduced, or disclosed to any other parties for any other purpose without the express, written permission of Zebra Technologies.

### Product Improvements

Continuous improvement of products is a policy of Zebra Technologies. All specifications and designs are subject to change without notice.

### Liability Disclaimer

Zebra Technologies takes steps to ensure that its published Engineering specifications and manuals are correct; however, errors do occur. Zebra Technologies reserves the right to correct any such errors and disclaims liability resulting therefrom.

### Limitation of Liability

In no event shall Zebra Technologies or anyone else involved in the creation, production, or delivery of the accompanying product (including hardware and software) be liable for any damages whatsoever (including, without limitation, consequential damages including loss of business profits, business interruption, or loss of business information) arising out of the use of, the results of use of, or inability to use such product, even if Zebra Technologies has been advised of the possibility of such damages. Some jurisdictions do not allow the exclusion or limitation of incidental or consequential damages, so the above limitation or exclusion may not apply to you.

# Contents

<b>About This Guide.....</b>	<b>17</b>
Model Configurations.....	17
Notational Conventions.....	18
Icon Conventions.....	18
Service Information.....	19
<b>Getting Started.....</b>	<b>20</b>
Unpacking.....	20
Features.....	21
Status Indications.....	23
RS6100 Activity Modes.....	24
Batteries.....	25
Standard and Extended Batteries.....	25
Installing the Battery.....	26
Removing the Battery.....	26
Single and Double Trigger Assemblies.....	27
Placing the RS6100 on Finger.....	28
Powering On.....	30
Bluetooth Connection.....	30
Scanning.....	31
Resetting the RS6100.....	31
Warm Boot.....	31
Cold Boot.....	31
Clean Boot.....	32

<b>Accessories.....</b>	<b>33</b>
Accessories List.....	33
Device Charging.....	36
Charging the RS6100.....	36
Charging the Spare Battery.....	37
Battery Charging.....	37
2-Bay Charger.....	38
2-Bay Charger Setup.....	39
2-Bay Charger Accessories.....	39
4-Slot Charging Cradle.....	41
4-Slot Charging Cradle Setup.....	43
8-Slot Battery Charger.....	43
8-Slot Battery Charger Setup.....	45
20-Slot Charging Cradle.....	45
20-Slot Charging Cradle Setup.....	47
40-Slot Battery Charger.....	47
40-Slot Battery Charger Setup.....	49
Corded Adapter.....	49
Lanyard Mount.....	50
Back of Hand Mount.....	52
Attaching the Back of Hand Mount.....	52
Installing the Assembly for a Right-Handed User.....	52
Installing the Assembly for a Left-Handed User.....	52
Positioning the Back of Hand Mount.....	53
Installing the RS6100 onto the Back of Hand Mount.....	55
Low Temperature Back of Hand Mount.....	57
Attaching the Low Temperature Back of Hand Mount.....	57
Installing the Low Temperature Mount Straps for a Right-Handed User.....	57
Installing the Low Temperature Mount Straps for a Left-Handed User.....	58
Positioning the Low Temperature Mount.....	59
Installing the RS6100 onto the Low Temperature Mount.....	61
Enterprise Hand Mount.....	62
Attaching the Enterprise Hand Mount.....	62
Installing the Hand Wrap for a Right-Handed User.....	63

Installing the Hand Wrap for a Left-Handed User.....	64
Positioning the Hand Wrap.....	65
Installing the RS6100 on the Enterprise Hand Mount.....	69
Detaching the RS6100.....	70
Cleaning the Hand Wrap.....	71
Bluetooth Adapter.....	73
Horizontal Surface Mounting.....	73
Mounting the Adapter With Screws.....	73
Mounting the Adapter with Cable Ties.....	74
Connecting the Adapter.....	75
<b>123Scan and Software Tools.....</b>	<b>76</b>
123Scan.....	76
Communication with 123Scan.....	77
123Scan Requirements.....	77
123Scan Information.....	77
Scanner SDK, Other Software Tools, and Videos.....	78
Advanced Data Formatting.....	78
Multicode Data Formatting.....	79
Multicode Data Formatting Use.....	79
MDF for Best Practices.....	80
Preferred Symbol.....	81
Data Parsing (UDI Scan+, Label Parse+ and Blood Bag Parse+).....	82
Scan a UDI Label using UDI Scan+.....	82
Scan a GS1 Label using Label Parse+.....	82
Scan a Blood Bag Label using Blood Bag Parse+.....	82
<b>RS6100 Configuration and Update.....</b>	<b>83</b>
RS6100 Configuration.....	83
DataWedge.....	83
123Scan.....	83
Real Time Logger.....	84
Retrieving the RS6100 Log File.....	84

RS6100 Firmware Update.....	85
Bluetooth Using 123Scan.....	86
Bluetooth Connected Zebra Device.....	86
<b>Radio Communications.....</b>	<b>87</b>
Radio Communications Parameter Defaults.....	87
Wireless Beeper Definitions.....	89
Radio Communications Host Types.....	90
Cradle.....	91
Keyboard Emulation (HID).....	91
Simple Serial Interface (SSI).....	92
Serial Port Profile (SPP).....	93
Bluetooth Technology Profile Support.....	94
Central/Peripheral Modes.....	94
Bluetooth Friendly Name.....	94
Discoverable Mode.....	95
Wi-Fi Friendly Options.....	95
Wi-Fi Friendly Mode.....	95
Wi-Fi Friendly Channel Exclusion.....	96
Bluetooth Radio Parameters.....	97
Radio Output Power.....	97
Link Supervision Timeout.....	98
HID Host Parameters.....	99
Apple iOS Virtual Keyboard Toggle.....	99
Keyboard Keystroke Delay.....	99
Caps Lock Override (Radio).....	99
Barcodes with Unknown Characters (Radio).....	100
Fast HID Keyboard.....	100
Numeric Keypad Emulation.....	100
Quick Keypad Emulation (Radio).....	101
Keyboard FN1 Substitution.....	101
Function Key Mapping (Radio).....	101
Simulated Caps Lock (Radio).....	102
Convert Case (Radio).....	102

Auto-reconnect Parameters.....	103
Beep on Reconnect Attempt.....	103
Reconnect Attempt Interval.....	104
Auto-reconnect.....	105
Sleep Between Attempts.....	105
Number of Retry Attempts.....	106
Scanner(s) to Cradle Support.....	107
Modes of Operation.....	107
Bluetooth Classic and/or Low Energy (Cradle Host Only).....	107
Parameter Broadcast (Cradle Host Only).....	108
Pairing.....	108
Pair on Contacts.....	109
Pull Trigger Twice to Re-connect.....	110
Unpairing.....	110
Toggle Pairing.....	110
Auto Un-Pairing.....	111
Pairing Barcode Format.....	111
Pairing Barcode Format Using the Scan-To-Connect (STC) Utility.....	112
Connection Maintenance Interval.....	112
Bluetooth Security.....	113
PIN Code.....	114
Variable PIN Code.....	114
Bluetooth Security Level.....	115
FIPS Mode.....	116
General Radio Parameters.....	116
Batch Mode.....	116
Persistent Batch Storage.....	118
Beep on Insertion.....	119
Bluetooth SPP Beep on <BEL>.....	119
Bluetooth Radio, Linking, and Batch Operation.....	120
Linking the Scanner to an iOS or Android Device.....	120
BLE Beacons.....	120
Beacon Upon Disconnection.....	120
Unpaired Beacons.....	121

Beaconing Beep.....	121
Beacon Frequency.....	121
Beacon Battery Threshold.....	122
Beacon ID.....	123
<b>User Preferences and Miscellaneous Options.....</b>	<b>124</b>
Setting User Preference Parameters.....	124
User Preference Scanning Sequence Examples.....	124
User Preference Errors While Scanning.....	124
User Preferences/Miscellaneous Options Parameter Defaults.....	124
User Preferences.....	126
Default Parameters.....	126
Parameter Barcode Scanning.....	127
Beep After Good Decode.....	127
Beeper Volume.....	127
Beeper Tone.....	128
Beeper Duration.....	129
Suppress Power Up Beeps.....	129
Trigger Mode.....	129
Hand-held Decode Aiming Pattern.....	130
Picklist Mode.....	131
Continuous Barcode Read.....	131
Unique Barcode Reporting.....	132
Decode Session Timeout.....	132
Timeout Between Decodes, Same Symbol.....	132
Enhanced Same Symbol Timeout Mode.....	133
Same Symbol Report Timeout.....	133
Swipe Frame Timeout.....	134
Presentation Frame Timeout.....	134
Fuzzy 1D Processing.....	134
Timeout Between Decodes, Different Symbols.....	135
Mobile Phone/Display Mode.....	135
PDF Prioritization.....	135
PDF Prioritization Timeout.....	136



Decoding Illumination.....	136
Motion Tolerance.....	137
Battery Threshold.....	137
Miscellaneous Scanner Parameters.....	138
Enter Key.....	138
Tab Key.....	139
Transmit Code ID Character.....	139
Prefix Suffix Values.....	139
Scan Data Transmission Format.....	140
FN1 Substitution Values.....	141
Report Software Version.....	142
Transmit No Read Message.....	142
Low Power Mode.....	143
<b>Symbologies.....</b>	<b>144</b>
Symbology Parameter Defaults.....	144
Enable/Disable All Code Types.....	149
UPC/EAN/JAN.....	150
UPC-A.....	150
UPC-E.....	150
UPC-E1.....	150
EAN-8/JAN-8.....	151
EAN-13/JAN-13.....	151
Bookland EAN.....	152
Bookland ISBN Format.....	152
ISSN EAN.....	152
Decode UPC/EAN/JAN Supplementals.....	153
User-Programmable Supplementals.....	156
UPC/EAN/JAN Supplemental Redundancy.....	156
UPC/EAN/JAN Supplemental AIM ID Format.....	156
Transmit UPC-A Check Digit.....	157
Transmit UPC-E Check Digit.....	158
Transmit UPC-E1 Check Digit.....	158
UPC-A Preamble.....	159

UPC-E Preamble.....	159
UPC-E1 Preamble.....	160
Convert UPC-E to UPC-A.....	160
Convert UPC-E1 to UPC-A.....	161
EAN/JAN Zero Extend.....	161
UCC Coupon Extended Code.....	162
Coupon Report.....	162
UPC Reduced Quiet Zone.....	163
Digimarc Digital Watermarks.....	163
Code 128.....	163
Set Lengths for Code 128.....	164
GS1-128 (formerly UCC/EAN-128).....	165
ISBT 128.....	165
ISBT Concatenation.....	166
Check ISBT Table.....	166
ISBT Concatenation Redundancy.....	167
Code 128 <FNC4>.....	167
Code 128 Security Level.....	168
Code 128 Reduced Quiet Zone.....	168
Code 39.....	169
Trioptic Code 39.....	169
Convert Code 39 to Code 32.....	170
Code 32 Prefix.....	170
Set Lengths for Code 39.....	171
Code 39 Check Digit Verification.....	172
Transmit Code 39 Check Digit.....	172
Code 39 Full ASCII Conversion.....	173
Code 39 Security Level.....	173
Code 39 Reduced Quiet Zone.....	174
Code 93.....	174
Set Lengths for Code 93.....	175
Code 11.....	176
Set Lengths for Code 11.....	176
Code 11 Check Digit Verification.....	177

Transmit Code 11 Check Digits.....	178
Interleaved 2 of 5 (I 2 of 5).....	178
Set Lengths for Interleaved 2 of 5 (I 2 of 5).....	178
Interleaved 2 of 5 (I 2 of 5) Check Digit Verification.....	180
Transmit I 2 of 5 Check Digit.....	180
Convert Interleaved 2 of 5 (I 2 of 5) to EAN-13.....	181
Interleaved 2 of 5 (I 2 of 5) Security Level.....	181
Interleaved 2 of 5 (I 2 of 5) Reduced Quiet Zone.....	182
Discrete 2 of 5 (D 2 of 5).....	182
Set Lengths for Discrete 2 of 5 (D 2 of 5).....	183
Codabar (NW - 7).....	184
Set Lengths for Codabar.....	184
CLSI Editing.....	185
NOTIS Editing.....	186
Codabar Security Level.....	186
Codabar Upper or Lower Case Start/Stop Characters.....	187
Codabar Mod 16 Check Digit Verification.....	187
Transmit Codabar Check Digit.....	188
MSI.....	188
Set Lengths for MSI.....	189
MSI Check Digits.....	190
Transmit MSI Check Digit(s).....	190
MSI Check Digit Algorithm.....	191
Chinese 2 of 5.....	191
Matrix 2 of 5.....	191
Set Lengths for Matrix 2 of 5.....	192
Matrix 2 of 5 Check Digit.....	193
Transmit Matrix 2 of 5 Check Digit.....	193
Korean 3 of 5.....	194
Inverse 1D.....	194
GS1 DataBar.....	195
GS1 DataBar Omnidirectional (formerly GS1 DataBar-14).....	195
GS1 DataBar Limited.....	195
GS1 DataBar Expanded.....	196

Convert GS1 DataBar to UPC/EAN/JAN.....	196
GS1 DataBar Security Level.....	197
GS1 DataBar Expanded Security Level.....	197
Symbology-Specific Security Features.....	198
Redundancy Level.....	198
Security Level.....	199
1D Quiet Zone Level.....	200
Intercharacter Gap Size.....	201
Composite.....	201
Composite CC-C.....	201
Composite CC-A/B.....	202
Composite TLC-39.....	202
UPC Composite Mode.....	202
Composite Beep Mode.....	203
GS1-128 Emulation Mode for UCC/EAN Composite Codes.....	203
2D Symbologies.....	204
PDF417.....	204
MicroPDF417.....	204
Code 128 Emulation.....	205
Data Matrix.....	205
GS1 Data Matrix.....	206
Data Matrix Inverse.....	206
Maxicode.....	207
QR Code.....	207
GS1 QR.....	208
QR Inverse.....	208
MicroQR.....	208
Linked QR Mode.....	209
Aztec.....	209
Aztec Inverse.....	210
Han Xin.....	210
Han Xin Inverse.....	211
Grid Matrix.....	211
DotCode.....	212

DotCode Prioritize.....	212
DotCode Inverse.....	212
DotCode Mirrored.....	213
Macro PDF Features.....	213
Macro PDF User Indications.....	214
Flush Macro PDF Buffer.....	214
Abort Macro PDF Entry.....	215
Postal Codes.....	215
US Postnet.....	215
US Planet.....	215
Transmit US Postal Check Digit.....	216
UK Postal.....	216
Transmit UK Postal Check Digit.....	216
Japan Postal.....	217
Australia Post.....	217
Australia Post Format.....	217
Netherlands KIX Code.....	218
USPS 4CB/One Code/Intelligent Mail.....	218
UPU FICS Postal.....	219
Mailmark.....	219
Digimarc Barcode.....	220
Posti LAPA 4-State Code.....	220
<b>OCR Programming.....</b>	<b>221</b>
OCR Parameter Defaults.....	221
OCR Programming Parameters.....	222
OCR-A.....	222
OCR-A Variant.....	222
OCR-B.....	223
OCR-B Variant.....	224
MICR E13B.....	226
US Currency Serial Number.....	227
OCR Orientation.....	228
OCR Lines.....	228

OCR Minimum Characters.....	229
OCR Maximum Characters.....	229
OCR Subset.....	229
OCR Quiet Zone.....	230
OCR Template.....	230
OCR Check Digit Modulus.....	239
OCR Check Digit Multiplier.....	239
OCR Check Digit Validation.....	240
Inverse OCR.....	244
OCR Redundancy.....	245
<b>Maintenance and Troubleshooting.....</b>	<b>247</b>
Maintenance.....	247
Battery Safety Guidelines.....	247
Long Term Storage.....	248
Cleaning the Finger Strap and Comfort Pad.....	248
Replacing the Comfort Pad.....	248
Trigger Assembly Replacement.....	249
Replacing the Finger Strap.....	250
Troubleshooting the RS6100.....	251
Troubleshooting Cradles.....	252
<b>Specifications.....</b>	<b>253</b>
2-Bay Charge Only Charger Technical Specifications.....	253
4-Slot Charge Only Cradle Technical Specifications.....	254
8-Slot Battery Charger Technical Specifications.....	254
20-Slot Battery Charger Technical Specifications.....	255
40-Slot Charging Cradle Technical Specifications.....	255
Bluetooth Adapter Technical Specifications.....	256
Decode Distances.....	256
<b>Programming Reference.....</b>	<b>258</b>
Symbol Code Identifiers.....	258

AIM Code Identifiers.....	259
<b>Numeric Barcodes.....</b>	<b>264</b>
Cancel.....	265
<b>Alphanumeric Barcodes.....</b>	<b>266</b>
Cancel.....	266
Alphanumeric Barcodes 1.....	266
<b>Sample Barcodes.....</b>	<b>277</b>
Sample Code 39.....	277
Sample Code 93.....	277
Sample UPC/EAN.....	277
Sample Code 128.....	278
Sample Interleaved 2 of 5.....	278
Sample GS1 DataBar.....	278
Sample PDF417.....	279
Sample Data Matrix.....	279
Sample Maxicode.....	280
Sample QR Code.....	280
Sample Aztec.....	280
Sample Grid Matrix.....	280
Sample US Postnet.....	281
Sample UK Postal.....	281
<b>Country Codes.....</b>	<b>282</b>
<b>Country Keyboard Types (Country Codes).....</b>	<b>283</b>
<b>Country Code Barcodes.....</b>	<b>284</b>

<b>Country Code Pages.....</b>	<b>295</b>
Country Code Page Defaults.....	295
Country Code Page Barcodes.....	298
<b>CJK Decode Control.....</b>	<b>304</b>
CJK Control Parameters.....	304
Unicode Output Control.....	304
CJK Output Method to Windows Host.....	304
Non-CJK UTF Barcode Output.....	306
Unicode/CJK Decode Setup with Windows Host.....	307
Setting Up the Windows Registry Table for Unicode Universal Output.....	307
Adding CJK IME on Windows.....	308
Selecting the Simplified Chinese Input Method on the Host.....	308
Selecting the Traditional Chinese Input Method on the Host.....	309
<b>ASCII Character Sets.....</b>	<b>311</b>
<b>RSM Attributes.....</b>	<b>321</b>
<b>BLE Beacons Parameter Defaults.....</b>	<b>322</b>
Beaconing and Battery Use.....	324
BLE Beacons Attributes.....	324
Model Number.....	324
Serial Number.....	324
Date of Manufacture.....	325
Firmware Version.....	325
<b>Communication Protocol Functionality.....</b>	<b>326</b>



# About This Guide

The RS6100 Wearable Scanner is a barcode scanning solution for both 1D and 2D barcode symbologies. The RS6100 is also compatible with a wide range of mobile computers communicating over Bluetooth.

This guide provides information on setting up and using the RS6100, resetting the device, and capturing data.

The guide also covers charging and testing the RS6100 battery, troubleshooting, maintenance, firmware update, and configuration of the RS6100. Sample barcodes are provided for configuring and testing the RS6100.

## Model Configurations

This guide covers the following configurations:

**Table 1** RS6100 Configurations

Model	Single Trigger	Double Trigger	Standard Battery	Extended Battery	USB-C	Temp	Enterprise Hand Mount*	Back of Hand
RS61B0-KBSSZWR (Worldwide)	X		X			0 - 50°C		
RS61B0-KBSSZIK (India/ Korea)	X		X			0 - 50°C		
RS61B0-KESSXWR (Worldwide)	X			X		-30° - 50°C		
RS61B0-KESSXIK (India/ Korea)	X			X		-30° - 50°C		
RS61B0-KBDSZWR (Worldwide)		X	X			0 - 50°C		
RS61B0-KBDUZCN (China)		X	X		X	0 - 50°C		
RS61B0-KBBHZWR (Worldwide)			X			0 - 50°C		X
RS61B0-KEDSXWR (Worldwide)		X		X		-30° - 50°C		
RS61B0-KBENZWR (Worldwide)			X			0 - 50°C	X	

**Table 1** RS6100 Configurations (Continued)

Model	Single Trigger	Double Trigger	Standard Battery	Extended Battery	USB-C	Temp	Enterprise Hand Mount*	Back of Hand
RS61B0-KEENXWR (Worldwide)				X		-30° - 50°C	X	
Note: All configurations include the SE55 imager engine. *Enterprise hand mount includes mounting frame and trigger, requires purchase of hand wrap.								

## Notational Conventions

The following conventions are used in this document:

- **Bold** text is used to highlight the following:
  - Dialog box, window, and screen names
  - Dropdown list and list box names
  - Checkbox and radio button names
  - Icons on a screen
  - Key names on a keypad
  - Button names on a screen
- Bullets (•) indicate:
  - Action items
  - List of alternatives
  - Lists of required steps that are not necessarily sequential.
- Sequential lists (for example, those that describe step-by-step procedures) appear as numbered lists.

## Icon Conventions

The documentation set is designed to give the reader more visual clues. The following visual indicators are used throughout the documentation set.



**NOTE:** The text here indicates information that is supplemental for the user to know and that is not required to complete a task.



**IMPORTANT:** The text here indicates information that is important for the user to know.



**CAUTION:** If the precaution is not heeded, the user could receive a minor or moderate injury.



**WARNING:** If danger is not avoided, the user CAN be seriously injured or killed.



**DANGER:** If danger is not avoided, the user WILL be seriously injured or killed.

## Service Information

If you have a problem with your equipment, contact Zebra Global Customer Support for your region. Contact information is available at: [zebra.com/support](https://zebra.com/support).

When contacting support, please have the following information available:

- Serial number of the unit
- Model number or product name
- Software type and version number

Zebra responds to calls by email, telephone, or fax within the time limits set forth in support agreements.

If your problem cannot be solved by Zebra Customer Support, you may need to return your equipment for servicing and will be given specific directions. Zebra is not responsible for any damages incurred during shipment if the approved shipping container is not used. Shipping the units improperly can possibly void the warranty.

If you purchased your Zebra business product from a Zebra business partner, contact that business partner for support.

# Getting Started

This chapter describes the features of the RS6100 Wearable Scanner including activity modes and beeper and LED indications, as well as how to install the battery, place the scanner on your finger, capture data, and reset the RS6100.

## Unpacking

Carefully remove all protective material from around the equipment and save the shipping container for later storage and shipping.

Ensure the shipping box contains the following items:

- RS6100
- Battery:
  - Standard battery (480 mAH) supports operation above 0°C (32°F)
  - Extended battery (735 mAH) supports operation below 0°C (32°F)
- Regulatory Guide
- Optional Trigger Mount Screw in a separate bag.

Inspect the equipment for damage. If you are missing any equipment or if you find any damaged equipment, contact Support immediately. See [Service Information](#) for contact information.

## Features

This section lists the features of the single and double trigger RS6100.

**Figure 1** Single Trigger Configuration Top View

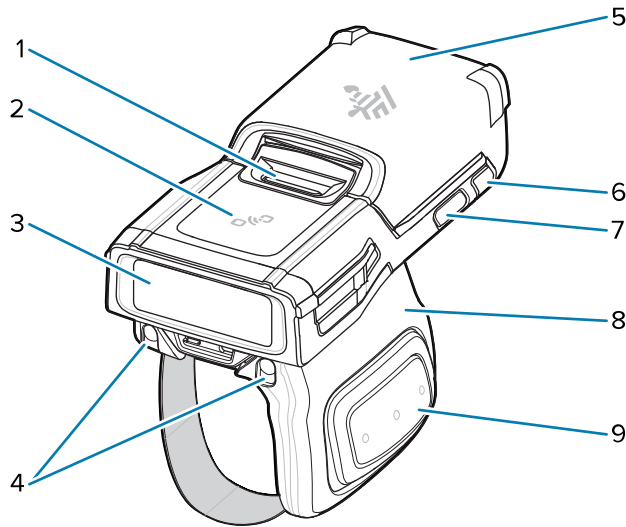

**Table 2** Single Trigger Configuration Top View

1	Battery release latch
2	NFC icon
3	Imager window
4	Charging pads for cradle
5	Battery
6	System LED
7	Restore key
8	Trigger assembly
9	Side scan trigger

**Figure 2** Double Trigger Configuration Top View

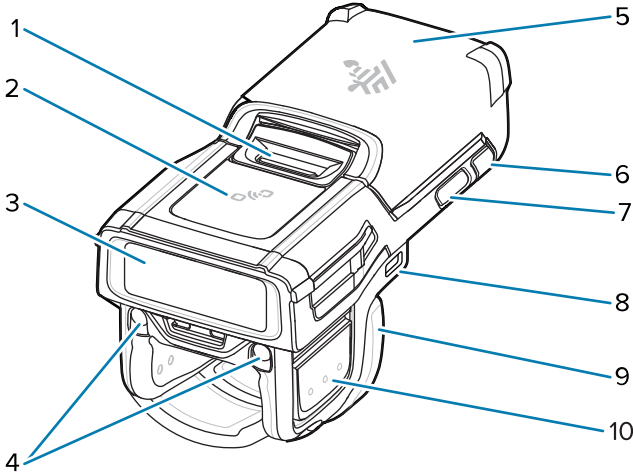

**Table 3** Double Trigger Configuration Top View

1	Battery release latch
2	NFC icon
3	Imager window
4	Charging pads for cradle
5	Battery
6	System LED
7	Restore key
8	USB-C port (not available on all configurations)
9	Trigger assembly
10	Side scan trigger

**Figure 3** Bottom View, Single Trigger Configuration Shown

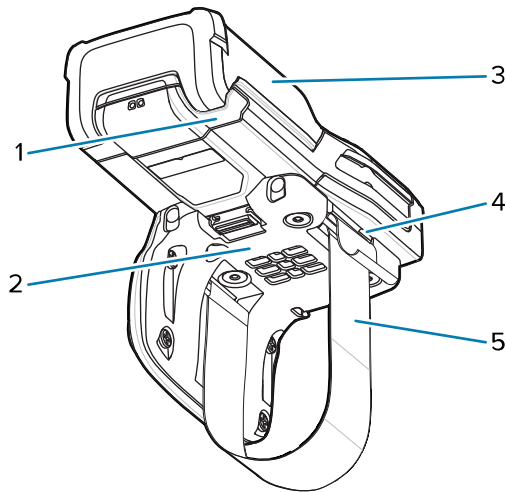

**Table 4** Bottom View, Single Trigger Configuration Shown

1	System LED
2	Comfort pad
3	Battery
4	Strap buckle
5	Finger strap

## Status Indications

The RS6100 System notification LEDs on the back of the device display system and decode status, and a System LED on the top of the device displays Bluetooth and battery status. The RS6100 beeper issues beep sequences and patterns to indicate status.

The following table defines the System LED and beep sequence status indications.

Category	LED Indication	Beep Indication	Description
Standard Use	Green	Low/Medium/High	Device is powered on.
Scanning Indications	Green single flash	High	A barcode was decoded.
	Red	4x Low	Transmission error.
	Red	5x Low	Conversion or format error.
Radio Indications	Red	Low/High/Low/High	Out of batch memory storage. Unable to store a new barcode.
	Red/Green blinking	6x Short High	Device in paging state.
	Blue double blink	High/low	Bluetooth communication is disconnected.
	Blue slow blinking	None	Attempting to reconnect over Bluetooth.

Category	LED Indication	Beep Indication	Description
	None	Low/high	Bluetooth connection established.
	None	Long low/ long high	Bluetooth connection attempt failed.
	Blue during beep sequence	Long low/ long high/ Long low/ long high	Bluetooth connection attempt is rejected.
	Blue slow blinking	5x High	Attempting to reconnect over Bluetooth (disabled by default).
	Blue blinking	3x Short high	Bluetooth disconnect indication (disabled by default).
Battery Indications	Red	4x Short high	Low battery indicator.
	Green/Amber/Red	N/A	Battery charge level indication (hold trigger for three seconds to activate). <ul style="list-style-type: none"> <li>• Green &gt; 40%</li> <li>• Amber 10% - 40%</li> <li>• Red &lt; 10%</li> </ul> Note: The LED lights for 3 seconds on the first scan after rebooting the scanner to indicate battery charge level.
	Red blinking	N/A	Battery is bad or over temperature.
Parameter Programing	Red	Long low/long high beeps	Input error, incorrect barcode or <b>Cancel</b> scanned, wrong entry, incorrect barcode programming sequence; remain in program mode.
	Green	High/low beeps	Keyboard parameter selected. Enter value using barcode keypad.
	Green	High/low/high/low beeps	Successful program exit with change in the parameter setting.
Maintenance Indications	Green slow blinking		Scanner connected to 123Scan.
	Red fast blinking		File is transferring to the scanner (new configuration parameters or firmware) via 123Scan.
	Red slow blinking		Firmware installation.
	Green		Programing completed successfully (parameter changes or firmware updated) via 123Scan.

## RS6100 Activity Modes

The RS6100 is capable of three modes of activity:

- Run Mode – The RS6100 is scanning or transferring data using Bluetooth.



- Low Power Mode – The RS6100 enters Low Power Mode (Standby Mode) when it is idle for more than 100 milliseconds, or when operating in temperatures below -10°C (14°F) with the extended battery installed. The RS6100 wakes up and returns to Run Mode upon at least one of the following events:
  - Scan trigger
  - Bluetooth activity
  - NFC field detected
  - Press of the Restore key
  - Insert into charging slot
- FF Mode – The RS6100 is not connected to a power source.

## Batteries

Before using the RS6100, charge the battery. See [Accessories](#) on page 33.

### Standard and Extended Batteries

The RS6100 includes a standard battery (480 mAH) for operation above 0°C (32°F), or an extended battery (735 mAH) for operation below 0°C (32°F).

The extended battery must be used in environments below 0°C (32°F), and affects scanner behavior in the following ways:

- When operating in temperatures above -20°C (-4°F), the RS6100 supports the default 4 second [Decode Session Timeout](#).
- Between -10°C (14°F) and -20°C (-4°F), the RS6100 enters Low Power Mode and continues to support the default 4 second [Decode Session Timeout](#).
- In temperatures below -20°C (-4°F), the RS6100 enters Low Power Mode and supports a [Decode Session Timeout](#) of less than 1 second.



**NOTE:** With the [Corded Adapter](#) connected to the WT6X with the 5000 mAH battery installed in the terminal, the RS6100 maintains the default 4 second [Decode Session Timeout](#) across the temperature range.

## Installing the Battery

To install the battery:

1. Align the battery on the RS6100 and insert into the battery compartment.

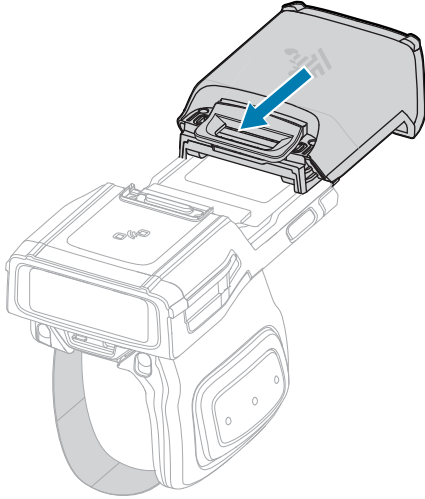

2. Slide the battery all the way into the locking slot.
3. Firmly press the battery into the RS6100 until a click indicates the battery release latch is fully engaged with the RS6100.



**NOTE:** New batteries from the factory arrive in Ship Mode for protection, and must be plugged into a charger (cradle or battery charger) to activate the battery.

## Removing the Battery

To remove the battery:

1. Push the battery release latch down until the latch pops up.

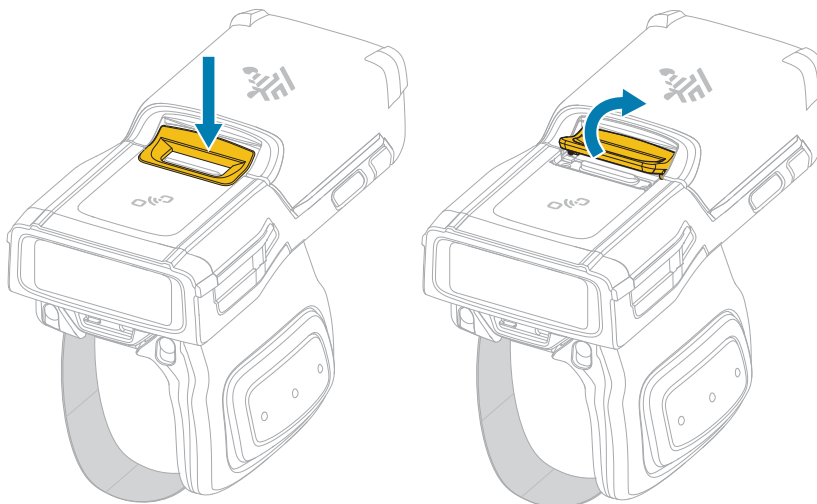

2. Slide the battery out of the battery compartment.

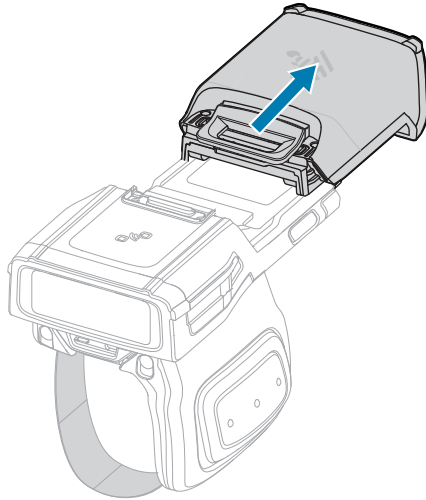

## Single and Double Trigger Assemblies

The RS6100 is worn with a Single or Double Trigger Assembly on the index finger, and triggered with the thumb. The trigger assembly is removable to provide left-handed or right-handed use.

The double trigger assembly is available in standard, USB-C, and vibrator configurations. The USB-C port on the assembly allows charging the RS6100 via a USB cable and programming using 123Scan.



**NOTE:** After installing a different type of trigger, reboot the RS6100 to recognize the new trigger.

To change the trigger position for right or left-handed use to position the scan trigger next to the thumb:

1. On the underside of the RS6100, push in the trigger assembly latch.

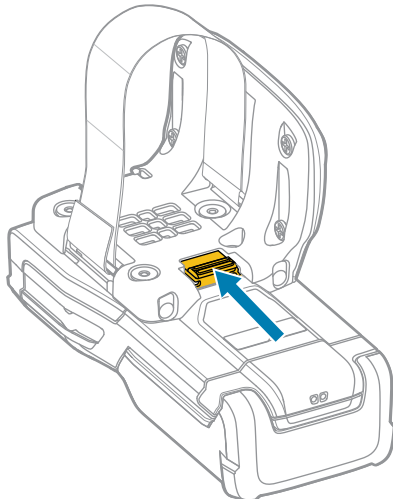

2. Lift the trigger assembly off the RS6100.

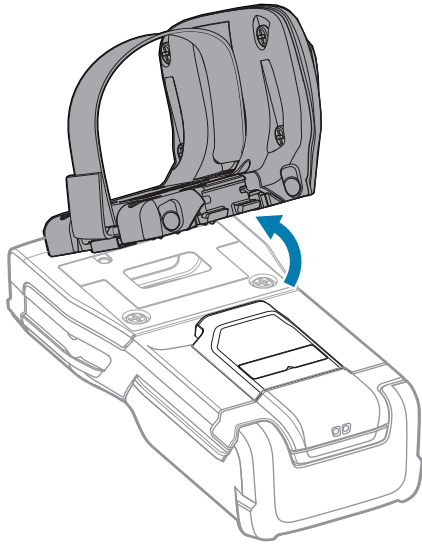

3. Rotate the trigger assembly so the scan trigger is positioned next to the thumb when the RS6100 is placed on the index finger.
4. Align one end of the trigger assembly on the RS6100 and push the other end down until it snaps into place.

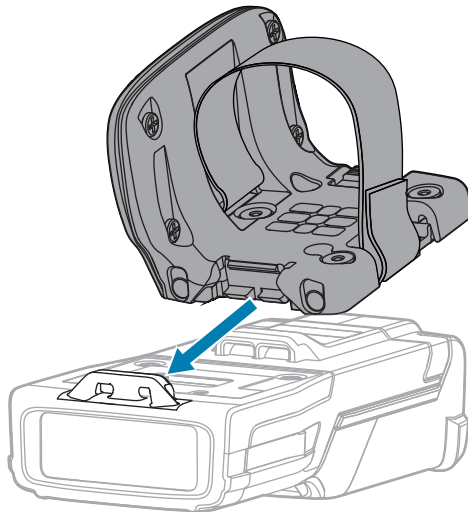

**NOTE:** An optional trigger mount screw is included in the packaging to secure the trigger mount using a Phillips screwdriver. On the single trigger, the hole for the trigger mount screw is under the comfort pad, while on the double trigger the hole is visible from the outside.

### Placing the RS6100 on Finger

To properly place the RS6100 on your finger, slide the scanner onto your index finger with the scan trigger next to your thumb.



**NOTE:** For additional mounting options, see the mounting accessories described in [Accessories](#) on page 33.

**Figure 4** Single Trigger

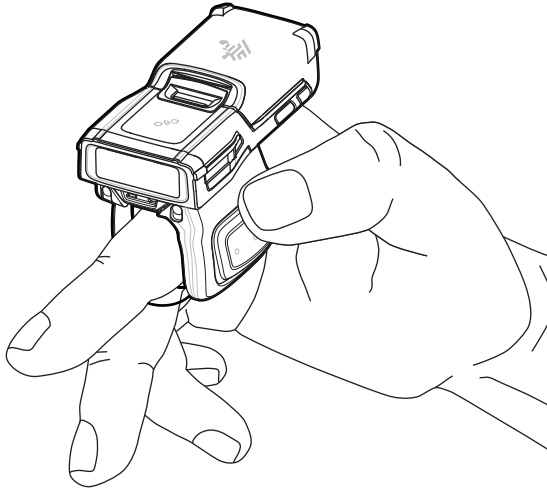

**Figure 5** Double Trigger

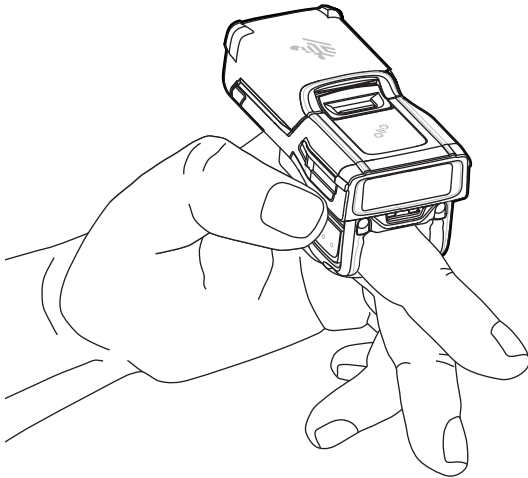

To tighten the finger strap on the single trigger, pull the end of the strap through the strap buckle. To loosen the finger strap, lift the strap buckle away from the strap while pulling the strap through the buckle. Release the buckle to hold the finger strap in place.

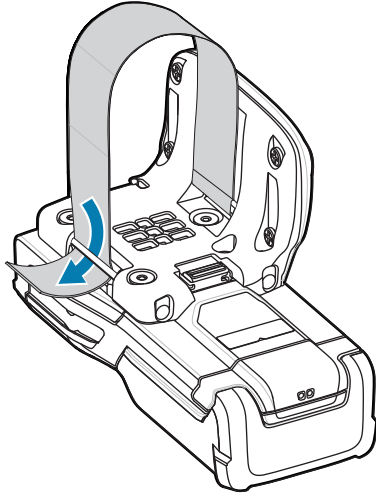

## Powering On

Locate the trigger that powers on the scanner.

To power on the device:

1. Install the battery (if not already installed).



**NOTE:** New batteries from the factory arrive in Ship Mode for protection and must be plugged into a charger (cradle or battery charger) to activate the battery.

2. Press one of the following:
  - Side scan trigger on the single trigger
  - Left side scan trigger on the double trigger
  - Scan trigger on the lanyard
  - Scan trigger on back of hand mount

## Bluetooth Connection

The RS6100 sends decoded barcode data to Zebra mobile computers and other devices using Bluetooth.

To connect the RS6100 to a device via Bluetooth, see [Radio Communications](#).

Connecting to a host device consists of two distinct processes.

1. **Pairing:** The scanner pairs with the device, exchanging security information. Pairing information is stored in the scanner's memory, and the two devices are associated with one another.
2. **Connecting:** The scanner connects to the device. Connection allows the devices to communicate and send data back and forth.

A scanner may disconnect from the host device for a variety of reasons. A disconnected scanner is still paired with the device. You can manually scan/tap to reconnect the scanner to the paired device.

## Scanning

The RS6100 uses digital camera technology to take an image of a barcode, and software decoding algorithms extract the barcode data from the image. The RS6100 includes the SE55 scan engine, which displays a green dash-dot-dash aimer.

To scan a barcode:

1. Launch a scanning application.
2. Press the scan trigger and aim the device at the barcode.



**NOTE:** For barcodes under transparent plastic or on a mobile computer screen, use a tilt (pitch) or skew scan angle to minimize reflection.

3. Adjust the position of the device so that the barcode is between two and eleven inches away, and the green LED aiming pattern appears at the center of the barcode.

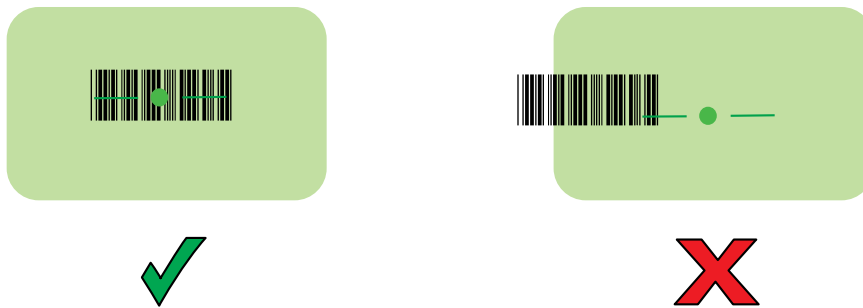

The LED lights green and a beep sounds, by default, to indicate the barcode was decoded successfully.



**NOTE:** In some configurations proper decoding of a barcode is indicated by the software application running on the mobile computer.

## Resetting the RS6100

If the RS6100 stops responding to input, reset it in one of three ways. Perform a warm boot first. If the RS6100 still does not respond, perform a cold boot. Perform clean boot to restore the RS6100 to its factory default configuration.

### Warm Boot

To perform warm boot, press and hold the Restore Key for more than five seconds and then release. The RS6100 resets when the key is released.



**NOTE:** Perform a warm boot after scanning configuration barcodes to reset the RS6100.

### Cold Boot

A cold boot power-cycles the RS6100 to restore operation. To perform cold boot, remove and re-insert the RS6100 battery.

### Clean Boot

A clean boot restores the RS6100 to its factory default configuration.

1. Make sure the battery is inserted and the scanner is turned on.
2. Press and hold the Restore Key until the System LED turns white.
3. Release the Restore Key and immediately press and hold the Restore Key until the scanner issues two beeps.

The RS6100 issues the boot beep sequence indicating the factory default configuration is restored.



# Accessories

The device accessories provide a variety of product support capabilities.

## Accessories List

**Table 5** Accessories

Accessory	Part Number	Description
<b>Cradles and Chargers</b>		
2-Bay Charger	CRD-RS5X6-2SCHG-01	Charges up to two devices with batteries. Additional shim attachment (p/n SHIM-CRD-R5X62B-01) charges a spare battery. Requires Power Supply PWR-WUA5V12W0US, USB A to USB C cord.
4-Slot RS6100 Charging Cradle	CRD-RS61-4SCHG-01	Charges up to four scanners with batteries. Requires power supply PWR-BGA12V50W0WW, DC cable CBL-DC-388A1-01, and country specific 3-wire AC line cord.
20-Slot RS6100 Charging Cradle	CRD-RS61-20SCHG-01	Charges up to twenty scanners with batteries. Requires power supply PWR-BGA12V108W0WW, DC cable CBL-DC-382A1-01, and country specific 3 wire AC line cord.
8-Slot Battery Charger	SAC-RS51-8SCHG-01	Charges up to eight spare batteries. Requires power supply PWR-BGA12V50W0WW, DC cable CBL-DC-388A1-01, and country specific 3-wire AC line cord.
40-Slot Battery Charger	SAC-RS51-40SCHG-01	Charges up to forty spare batteries. Requires power supply PWR-BGA12V108W0WW, DC cable CBL-DC-382A1-01, and country specific 3-wire AC line cord.
<b>Batteries</b>		
Replacement Standard Battery	BTRY-RS51-4MA-01	Replacement standard battery (single pack).
Replacement Standard Battery	BTRY-RS51-4MA-10	Replacement standard battery (ten pack).

**Table 5** Accessories (Continued)

Accessory	Part Number	Description
Replacement Standard Battery	BTRY-RS51-4MA-CN	Replacement standard battery, China only.
Replacement Standard Battery	BTRY-RS51-4MA-02	Replacement standard battery, India and South Korea only.
Replacement Extended Battery	BTRY-RS51-7MA-01	Replacement extended battery (single pack).
Replacement Extended Battery	BTRY-RS51-7MA-10	Replacement extended battery (ten pack).
Replacement Extended Battery	BTRY-RS51-7MA-02	Replacement extended battery, India and South Korea only.
<b>Cables / Adapters</b>		
Corded Adapter for TC2X / TC5X	CBL-RS5X6-ADPTC-01	Connects RS6100 to TC21/TC26 orTC53/TC58 via USB-C connector, terminal supplies power to scanner, communication via Bluetooth.
Corded Adapter for WT6X	CBL-RS5X6-ADPWT-01	Connects RS6100 to WT6X, terminal supplies power to scanner, communication via Bluetooth.
<b>Triggers and Soft Goods</b>		
Replacement Single Trigger Assembly	SG-RS51-TRGSS-02	Replacement single-sided trigger. Includes comfort pad and nylon strap.
Replacement Finger Strap	SG-RS51-STRPNY-10	Replacement nylon finger straps for single sided trigger (10-pack).
Replacement Comfort Pad	SG-RS51-CMPD-05	Replacement comfort pads for use with single sided trigger (5-pack).
Replacement Trigger Assembly - Double Trigger: Standard Charge Contacts	SG-RS51-TRGDS-01	Replacement double-sided trigger.
Replacement Trigger Assembly - Double Trigger: Standard Charge Contacts and Vibrator option	SG-RS51-TRGDV-01	Replacement double-sided trigger with vibrator.
Replacement Trigger Assembly - Double Trigger: USB-C Charge Port	SG-RS51-TRGDU-01	Replacement double-sided trigger with USB-C port, which allows charging the scanner via a USB cable and programming using 123Scan.
Back of Hand Mount	SG-RS5X6-BHMT-01	Mounts the RS6100 on the back of hand and provides a remote finger trigger. One size fits all; ambidextrous. Includes hand strap.
Replacement Hand Strap	SG-RS51-BHSTP-01	Replacement strap for Back of Hand Mount.

**Table 5** Accessories (Continued)

Accessory	Part Number	Description
Low Temperature Back of Hand Mount	SG-RS5X6-BHMTX-01	Mounts the RS6100 on the back of hand and provides a remote finger trigger. Designed for use in freezer operations, down to -30°C / -22°F, and fits over heavy freezer gloves. Includes hand strap and small finger strap.
Replacement Low Temperature Hand Strap	SG-RS5X6-BHSTX-01	Replacement hand strap for Low Temperature Back of Hand Mount.
Replacement Finger Strap - Small	SG-RS5X6-BHFSS-10	Replacement finger strap for Low Temperature Back of Hand Mount, small for mounting trigger on index finger (10-pack).
Replacement Finger Strap - Medium	SG-RS5X6-BHFSSM-10	Replacement finger strap for Low Temperature Back of Hand Mount, medium for mounting trigger on two fingers (10-pack).
Replacement Finger Strap - Extra Large	SG-RS5X6-BHFSX-10	Replacement finger strap for Low Temperature Back of Hand Mount, extra large for mounting trigger on entire hand (10-pack).
Enterprise Hand Mount	SG-RS5X6-HNMT-01	Includes mounting frame with trigger. Requires separate purchase of hand wrap.
Replacement Hand Wrap - Left/Large	SG-WEAR-HNWPLL-01	Replacement hand wrap for Enterprise Hand Mount, left hand, large.
Replacement Hand Wrap - Left/Medium	SG-WEAR-HNWPLM-01	Replacement hand wrap for Enterprise Hand Mount, left hand, medium.
Replacement Hand Wrap - Left/Small	SG-WEAR-HNWPLS-01	Replacement hand wrap for Enterprise Hand Mount, left hand, small.
Replacement Hand Wrap - Right/Large	SG-WEAR-HNWPRL-01	Replacement hand wrap for Enterprise Hand Mount, right hand, large.
Replacement Hand Wrap - Right/Medium	SG-WEAR-HNWPRM-01	Replacement hand wrap for Enterprise Hand Mount, right hand, medium.
Replacement Hand Wrap - Right/Small	SG-WEAR-HNWPRS-01	Replacement hand wrap for Enterprise Hand Mount, right hand, small.
Lanyard Trigger Assembly	SG-RS5X6-LNYD-01	Allows the RS6100 to be worn around the neck or hip. Requires separate purchase of retractor, below.
Retractor with Magnetic Recoil for Lanyard Trigger Assembly	SG-RS5X6-RLYD1-01	Allows RS6100 units with Lanyard Trigger Assembly to be worn around the neck or hip.
Other		
Bluetooth Adapter	BT-RS5X6-DNGL-01	Allows RS6100 to pair with a host computer via Bluetooth.

## Device Charging

The following sections describe how to charge the RS6100 and spare battery. Note that these accessories are for charging only and do not provide communication functionality.



**NOTE:** Follow the guidelines for battery safety described in [Battery Safety Guidelines](#) on page 247.

### Charging the RS6100

To charge the RS6100:

1. Insert the RS6100 into one of the 2-Bay, 4-Slot, or 20-Slot Charging Cradle slots.

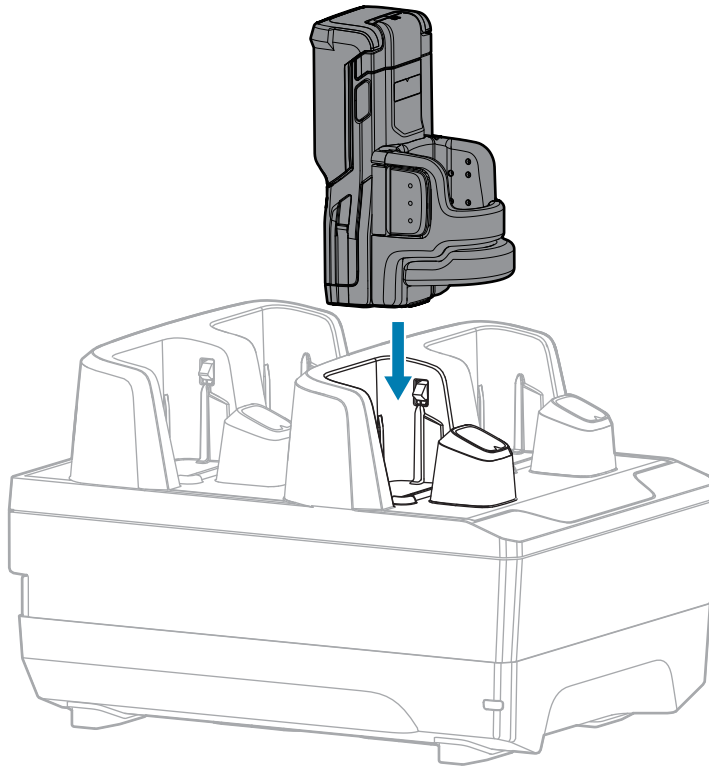

2. Ensure that the RS6100 is properly seated in the charging slot.



**NOTE:** Before performing a firmware update over Bluetooth, charge the RS6100.

## Charging the Spare Battery

To charge a spare battery:

1. Insert a spare battery into one of the 8-Slot or 40-Slot Battery Charger slots.

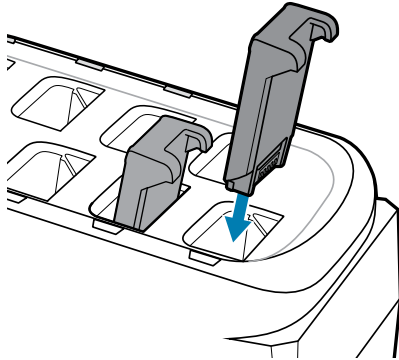

2. Ensure the battery is seated properly. The charging LED blinks to indicate charging.

## Battery Charging

The RS6100 charging LED indicates scanner battery charging status, and the spare battery charger LED indicates spare battery charging status.



**NOTE:** New batteries from the factory arrive in Ship Mode for protection. Insert them into a charger (cradle or battery charger) to activate the battery.

**Table 6** Charging LED Indicators

State	Indication
Off	The battery is not charging. The RS6100 or battery is not inserted correctly in the cradle or charger, or is not connected to a power source. Cradle is not powered.
Solid Amber	Battery is charging.
Solid Green	Battery charging is complete.
Fast Blinking Red (2 blinks/second)	Charging error, such as: <ul style="list-style-type: none"> <li>• Battery temperature is too low or too high for charging.</li> <li>• The battery has reached the charge cycle time-out period. Battery charging has gone on too long without completing a full charge cycle (typically eight hours).</li> </ul>
Solid Red	Unhealthy battery is charging or fully charged.

Charge batteries in temperatures from 5°C to 40°C (41°F to 105°F). The standard battery charges from 0% to 90% in less than two and a half hours at room temperature. When the charging temperature is between 5°C to 10°C (41°F to 50°F), the standard battery charges in less than five hours.

The device and charger monitor battery temperature. Battery charging is only performed when the battery is within safe charging temperature limits. At higher temperatures (at approximately +35 °C (+95 °F)) the device or charger may, for small periods of time, alternately enable and disable battery charging to keep the battery at acceptable temperatures. This process may increase charging time. The RS6100 or charger indicates when charging is disabled due to abnormal temperatures via the Status LED.

## 2-Bay Charger

The 2-Bay RS51/61 Charger charges up to two scanners.



**NOTE:** Follow the guidelines for battery safety described in the RS6100 Product Reference Guide.

**Figure 6** 2-Bay Charger

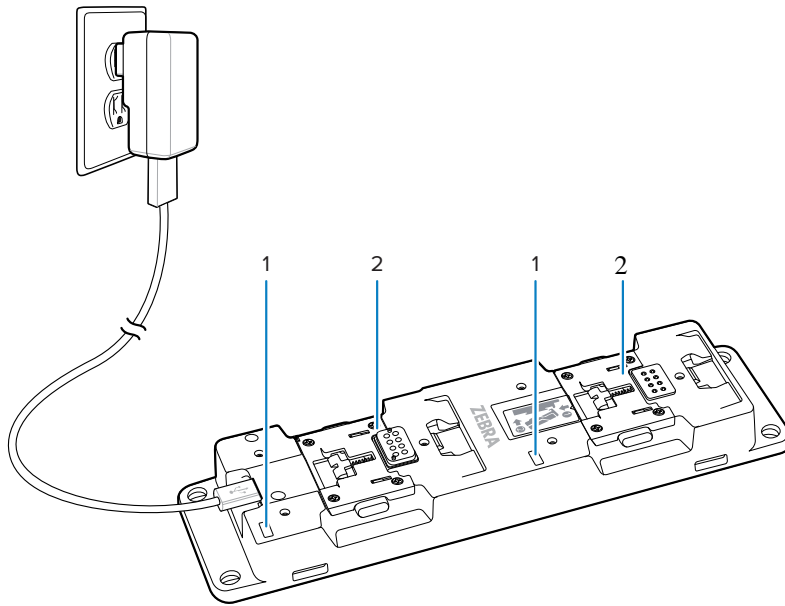

1	LED indicator
2	Scanner charging slot



**NOTE:** Follow the instructions for inserting the scanner described in the 2-Bay Charger Quick Reference Guide.

## 2-Bay Charger Setup

Connect the charger to a power source with at least 1 A to power both bays. Use a USB-A to USB-C cable to connect the charger.

**Figure 7** 2-Bay Charger Setup

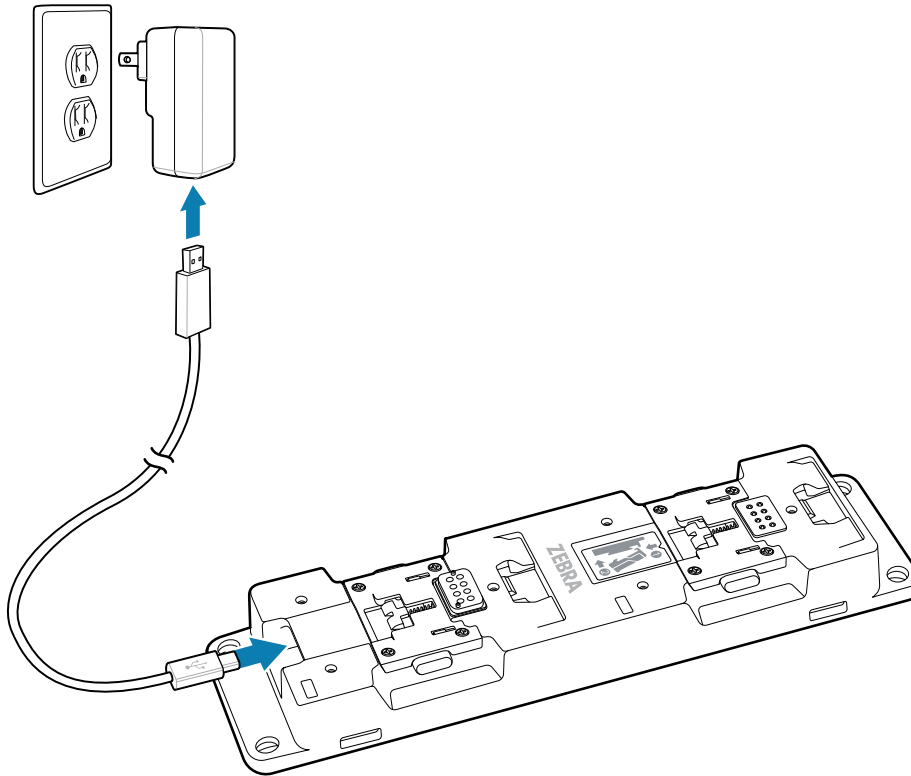

## 2-Bay Charger Accessories

Augment the 2-Bay Charger using optional accessories.

**Table 7** 2-Bay Charger Accessories

Accessory Name	Part Number	Function
RS5100/6100 2-Bay Charger Mounting Bracket	BRKT-RS5X62SCHG-01	Mount multiple 2-Bay Chargers together
RS5100/6100 Shim Attachment	SHIM-CRD-R5X62B-01	Charge spare batteries
Power Supply	PWR-WUA5V12W0XX	Power supplies 100-240 VAC, 5 V, 2.5 A

### Mounting the Charger on a Bracket

Mount up to five chargers onto a BRKT-RS5X6-2SCHG-01 bracket.

- Use four M5 7 mm long screws.

1. Place the charger on the bracket so that the mounting holes line up with the circular holes of the bracket.
2. Secure the charger in place with a screw in each mounting hole.

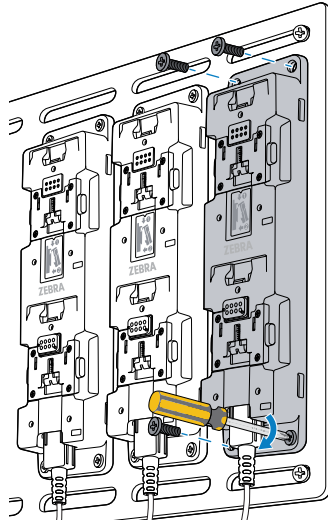

A maximum of five chargers fit onto the bracket.

### Shim Attachment

Install the SHIM-CRD-R5X62B-01 on the RS5100/6100 2-Bay Charger to charge spare batteries.

### Installing the Shim Attachment

Install the shim attachment using the provided screws.

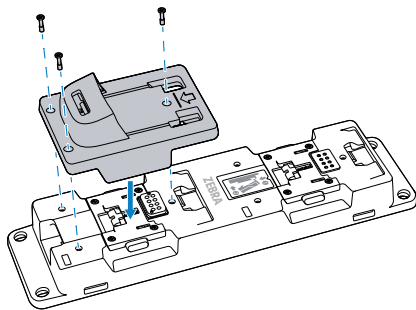

### Charging a Spare Battery

Use the shim attachment to charge a spare battery.

1. Slide the battery into the slot contacts first.



2. Press firmly until the battery latch clicks into place.

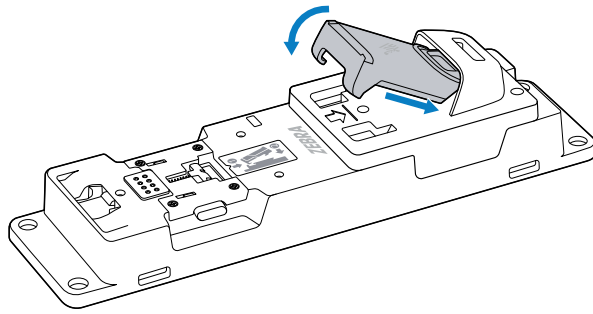

The charger's LED indicator illuminates when the battery is inserted successfully.

### Charger LED Indicator

The charger's LED indicates the charging status of the battery.

Cradle LED	Indication
Amber (solid)	Charing healthy battery
Green (solid)	Spare battery is fully charged
Red (solid)	Charging/fully charged unhealthy battery
Red (blinking)	Charing fault or insufficient current input
Off	No connection to battery or shim improperly connected to the charger

### Power Supply

Zebra recommends connecting the USB-A end of the power cable to a Zebra power supply such as PWR-WUA5V120XX. Use a power supply and outlet that provides at least 5 V, 1 A of power to the charger.



**NOTE:** When the 2-Bay Charger is connected to a power supply that provides less than 1A, the charger enters **low-current mode**. In low-current mode:

- The top slot does not provide power to the charging slot. Its LED indicator blinks red.
- The bottom slot works as normal to charge a ring scanner or spare battery.

### 4-Slot Charging Cradle

The 4-Slot RS6100 Charging Cradle provides power for RS6100 operation and charges up to four batteries in the RS6100.



**NOTE:** Ensure you follow the guidelines for battery safety described in [Battery Safety Guidelines](#).

**Figure 8** 4-Slot Charging Cradle

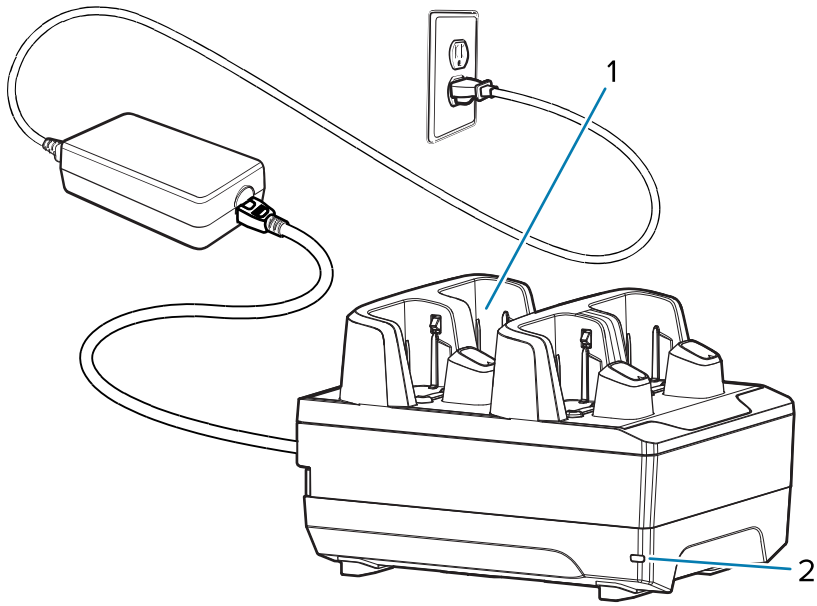

1	RS6100 charging slot (4)
2	Power LED

## 4-Slot Charging Cradle Setup

Connect the charger to a grounded outlet.

**Figure 9** 4-Slot Charging Cradle Setup

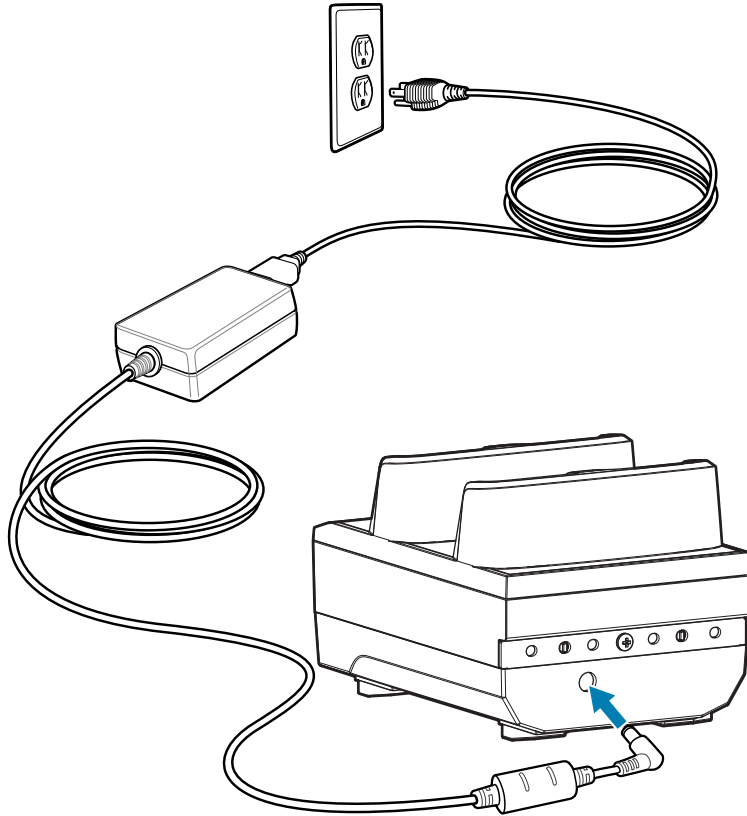

## 8-Slot Battery Charger



**NOTE:** Ensure that you follow the guidelines for battery safety described in [Battery Safety Guidelines](#).

The 8-Slot Battery Charger charges up to eight spare batteries.

**Figure 10** 8-Slot Battery Charger

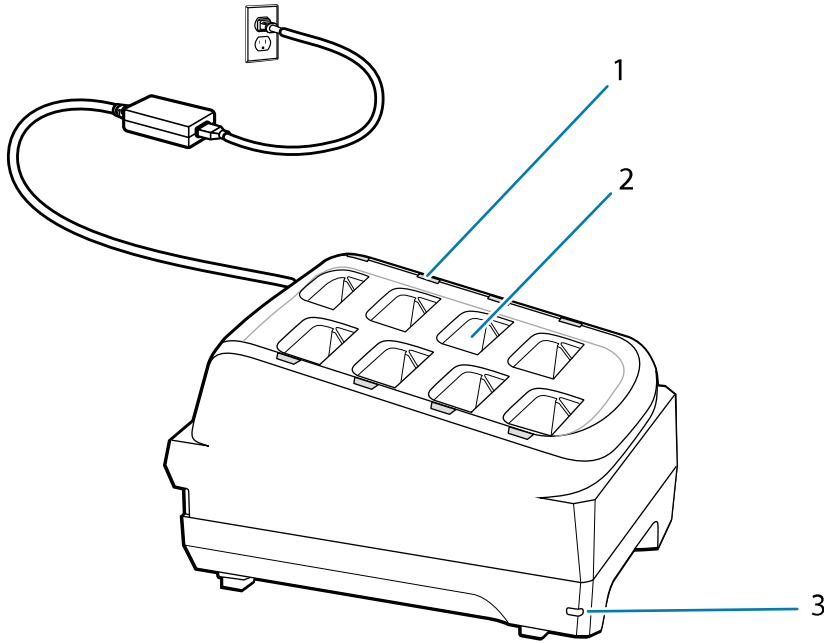

1	Battery charging LED (8)
2	Battery charging slot (8)
3	Power LED

## 8-Slot Battery Charger Setup

Connect the charger to a grounded outlet.

**Figure 11** 8-Slot Battery Charger Setup

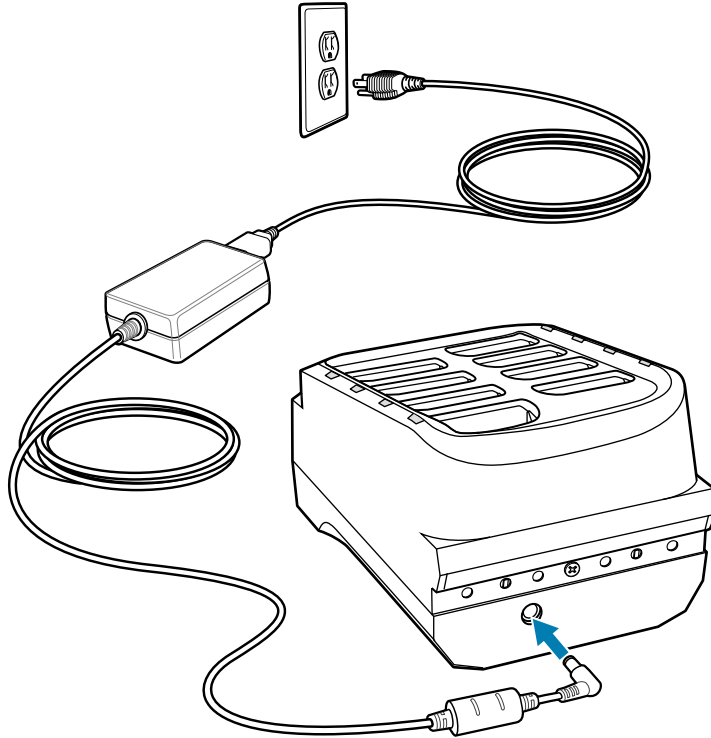

## 20-Slot Charging Cradle

The 20-Slot RS6100 Charging Cradle provides power for RS6100 operation and charges up to 20 batteries in the RS6100.



**NOTE:** Follow the guidelines for battery safety described in [Battery Safety Guidelines](#).

**Figure 12** 20-Slot Charging Cradle

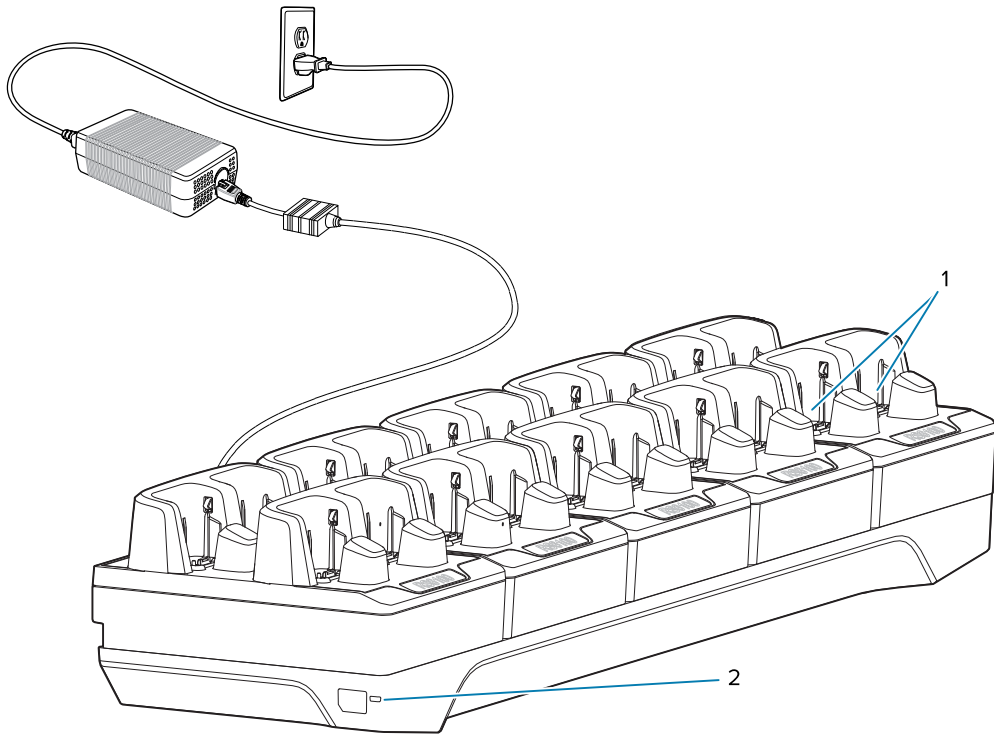

1	RS6100 charging slots (20)
2	Power LED

## 20-Slot Charging Cradle Setup

Connect the charger to a grounded outlet.

**Figure 13** 20-Slot Charging Cradle Setup

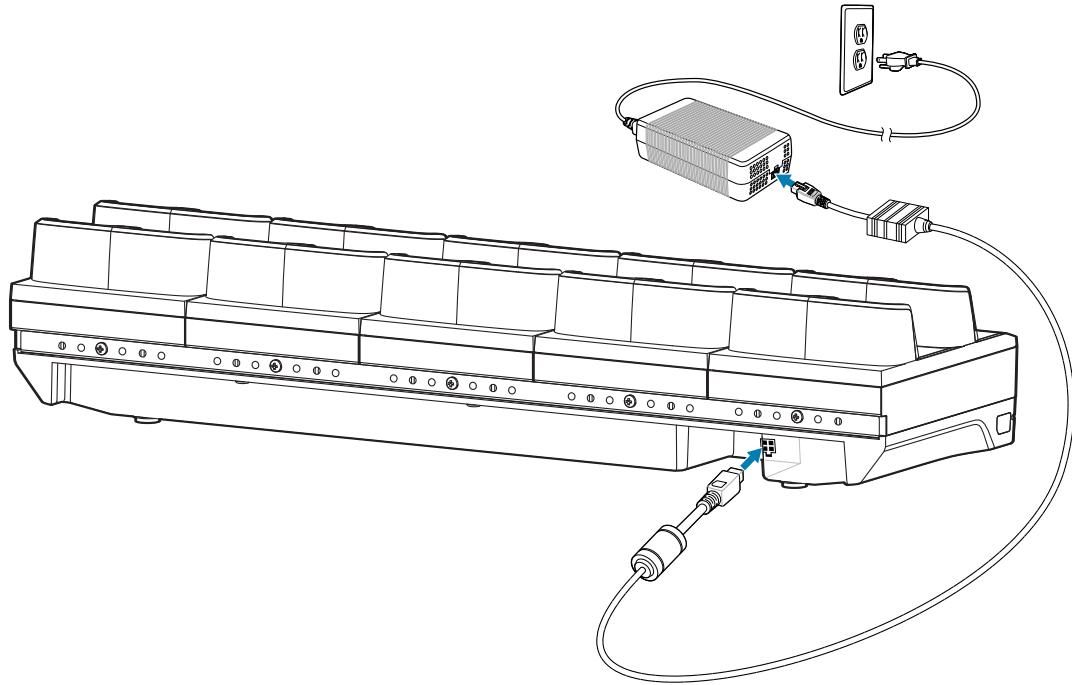

## 40-Slot Battery Charger

The 40-Slot Battery Charger charges up to forty spare batteries.



**NOTE:** Follow the guidelines for battery safety described in [Battery Safety Guidelines](#).

**Figure 14** 40-Slot Battery Charger

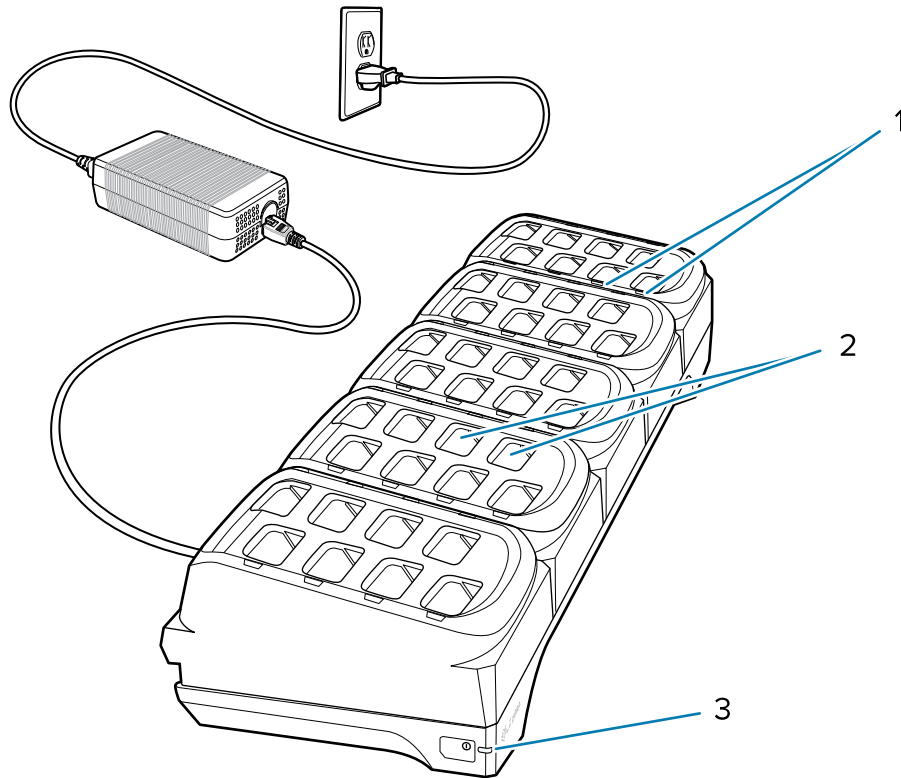

1	Battery charging LED (40)
2	Battery charging slot (40)
3	Power LED



## 40-Slot Battery Charger Setup

Connect the charger to a grounded outlet.

**Figure 15** 40-Slot Battery Charger Setup

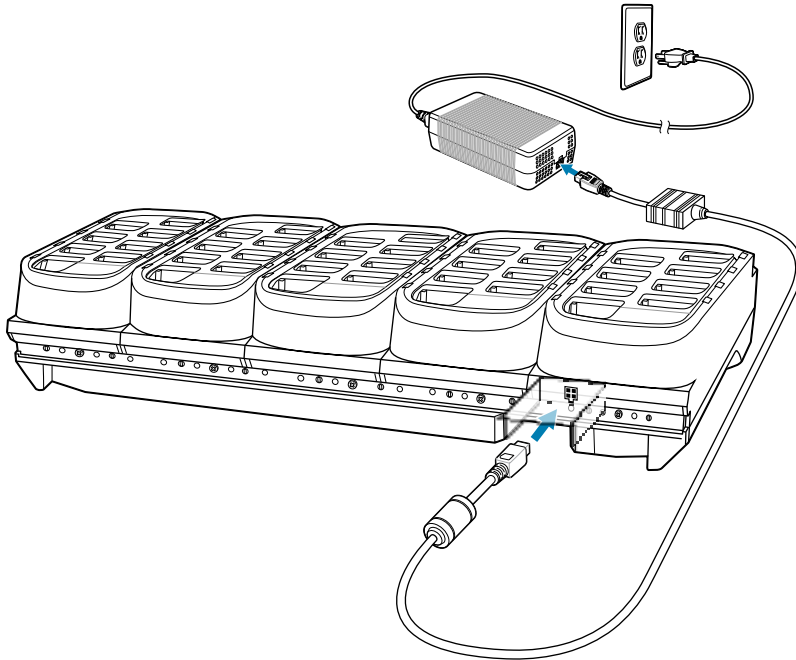

## Corded Adapter

The Corded Adapter connects an arm or wrist-mounted host terminal to the RS6100 in order to provide power to the scanner.

Data communication between the host and scanner is provided via Bluetooth, not through the adapter. There are two adapters available.

CBL-RS5X6-ADPWT-01 accommodates connection to the WT6X00.

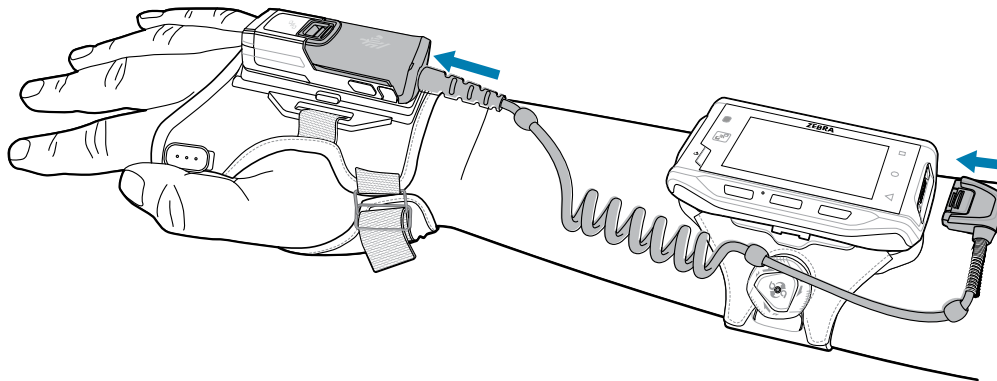

CBL-RS5X6-ADPTC-01 accommodates USB-C connection to the TC21/TC26 and TC53/TC58.

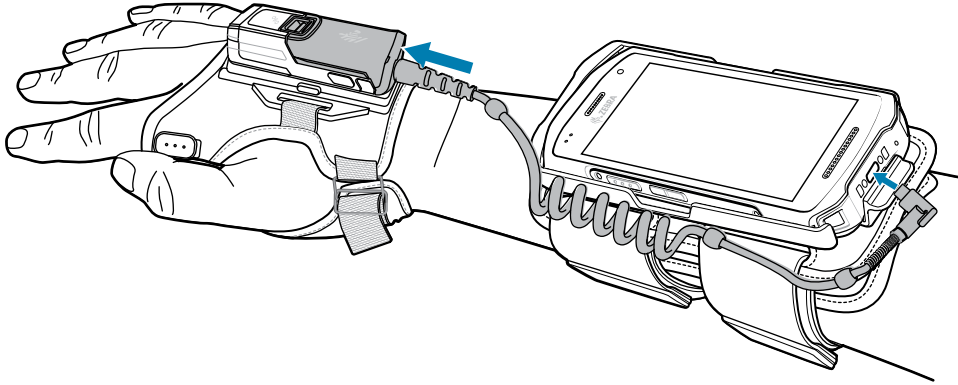

## Lanyard Mount

The lanyard mount is comprised of the lanyard trigger assembly, retractor, and lanyard. The lanyard trigger assembly allows the RS6100 to be worn around the neck or hip. It requires a separate purchase of the retractor with magnetic recoil for neck or hip mounting.

**Figure 16** Lanyard Mount

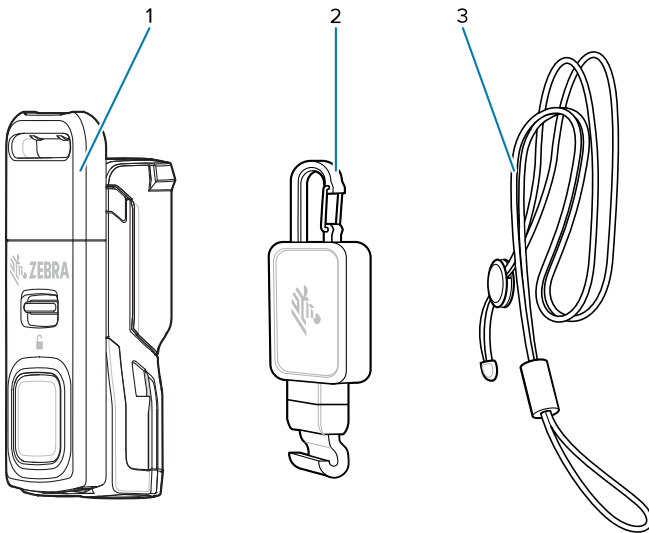

1	Lanyard trigger assembly
2	Retractor
3	Lanyard

To attach the lanyard trigger assembly and retractor to the RS6100:

1. Align the contacts on the RS6100 assembly with the contacts on the back of the lanyard trigger assembly and slide the lanyard trigger assembly into the notch on the RS6100 assembly.

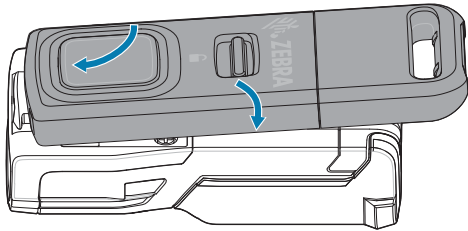

2. Push down on the lanyard trigger assembly to snap into place.
3. If using the retractor, slide the hook on the bottom of the retractor into the top/front slot on the lanyard trigger assembly, and push the lanyard through the clasp on the top of the retractor.

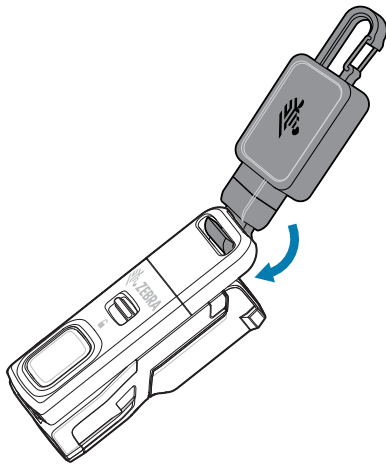

If using the lanyard without the retractor, insert the lanyard through the top/front slot on the lanyard trigger assembly.

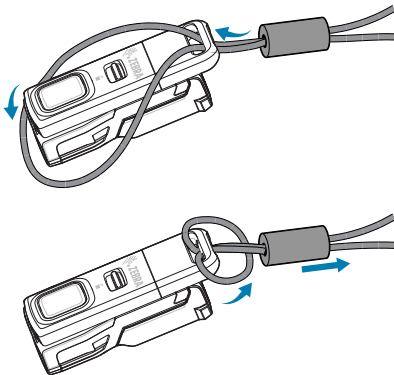

To remove the lanyard trigger assembly, slide the release latch and detach the assembly from the RS6100.

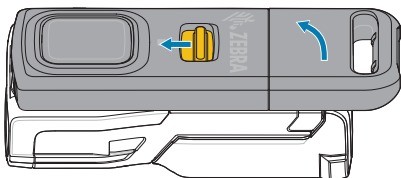

## Back of Hand Mount

The Back of Hand Mount (which includes a hand strap) allows mounting the RS6100 on the back of the hand and provides a remote finger trigger. It accommodates both right and left hands.

### Attaching the Back of Hand Mount

To attach the back of hand mount:

1. Install the strap to the back of hand assembly as described in [Installing the Assembly for a Right-Handed User](#) or [Installing the Assembly for a Left-Handed User](#).
2. Position the back of hand mount on the hand as described in [Positioning the Back of Hand Mount](#).
3. Install the RS6100 onto the back of hand mount as described in [Installing the RS6100 onto the Back of Hand Mount](#).

### Installing the Assembly for a Right-Handed User

To install the assembly for a right-handed user:

1. Hold the back of hand mount with the trigger assembly toward you.
2. On the Y-shaped strap, locate the two ends that include a snap, and slide them up through the top right and bottom right slots on the back of hand assembly. Snap them into place.
3. Slide the long end of the strap up through the left center slot of the back of hand assembly, and press in place.

**Figure 17** Right Hand User: Secure Straps Into Place

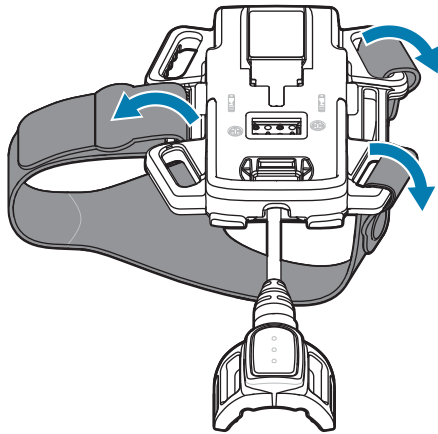

### Installing the Assembly for a Left-Handed User

To install the assembly for a left-handed user:

1. Hold the back of hand mount with the trigger assembly toward you.
2. On the Y-shaped strap, locate the two ends that include a snap, and slide them up through the top left and bottom left slots on the back of hand assembly. Snap them into place.

3. Slide the long end of the strap up through the right center slot of the back of hand assembly, and press in place.

**Figure 18** Left Hand User: Secure Straps Into Place

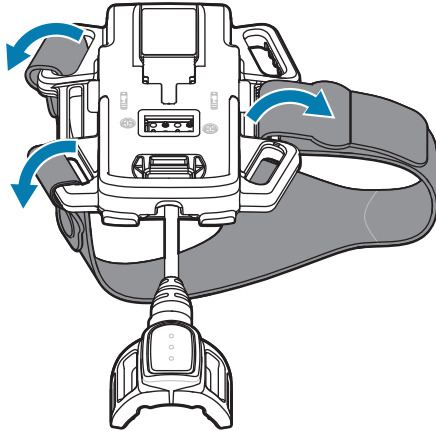

## Positioning the Back of Hand Mount

To properly position the back of hand mount on your hand:

1. Slide your hand through the strap, with your thumb through the smaller opening between the two snaps and your remaining four fingers through the larger opening.

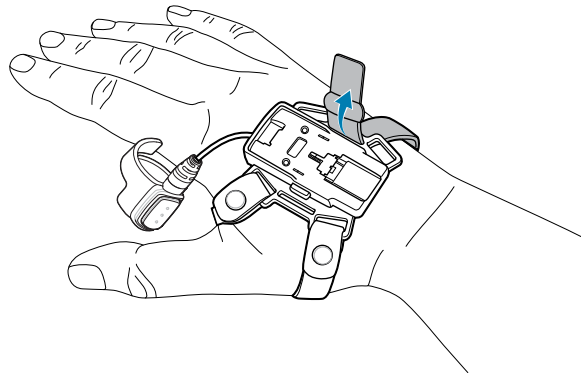

2. Adjust the self-fastening strap to a comfortable position.

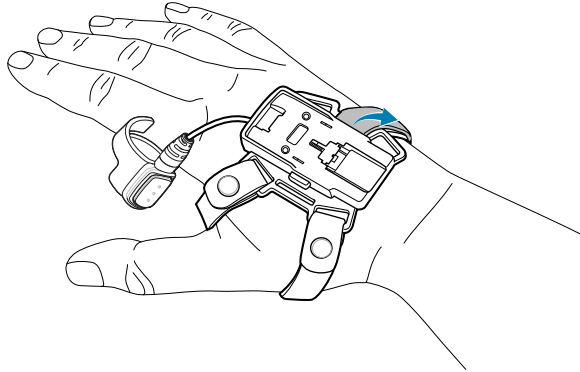

3. Slide the finger trigger over your index finger.
4. Rotate the finger trigger so that your thumb can easily access the trigger button.

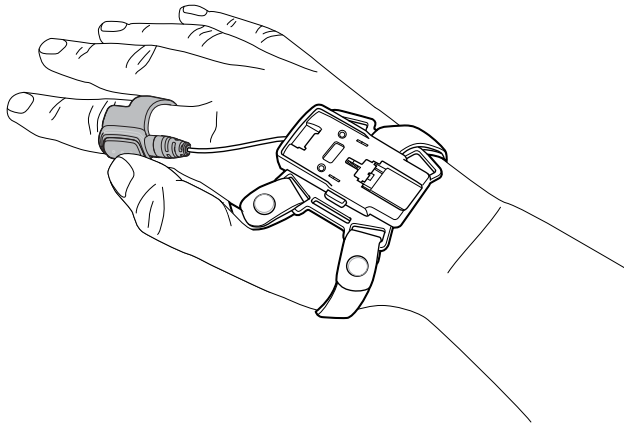

## Installing the RS6100 onto the Back of Hand Mount

To install the RS6100 on the back of hand mount:

1. Engage the bump at the front of the RS6100 (on the underside) with the slot on the top of the mount.

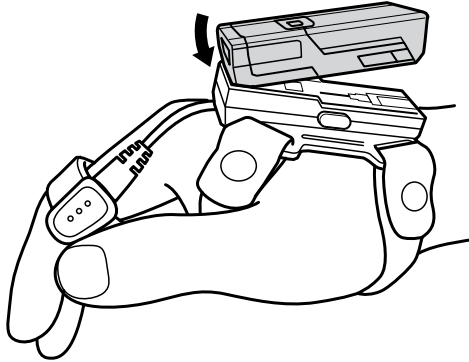

2. Pivot the RS6100 downward until it snaps into place.

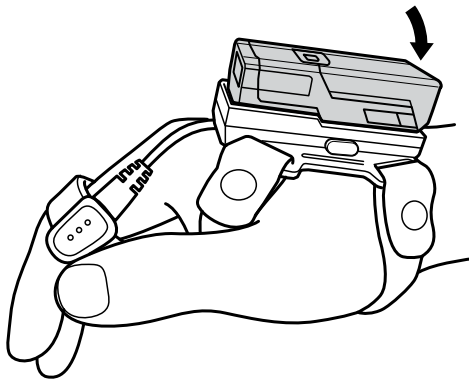

## Detaching the RS6100

To detach the RS6100 from the back of hand mount, press the release buttons on both sides of the mount and lift the RS6100 off the mount.

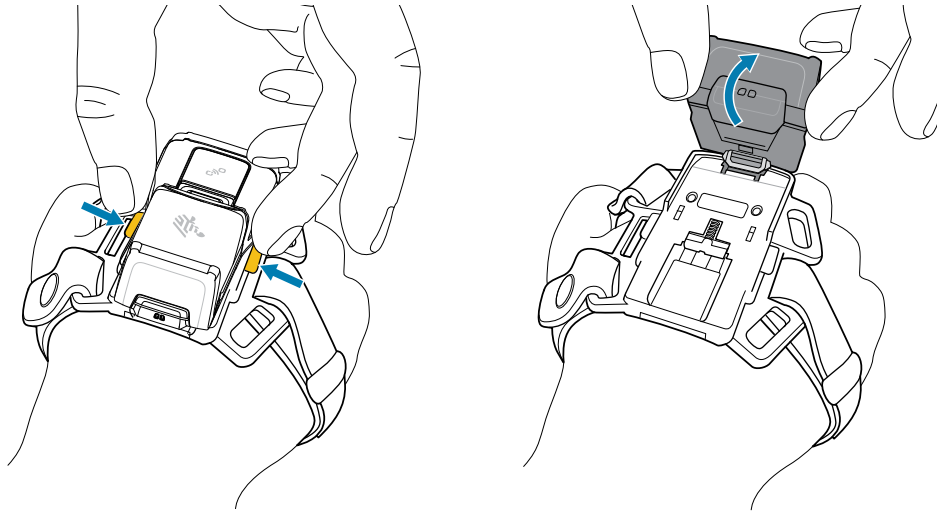



## Low Temperature Back of Hand Mount

The Low Temperature Back of Hand Mount allows mounting the RS6100 on the back of the hand and provides a remote finger trigger.

This mount is designed for use in freezer operations, down to  $-30^{\circ}\text{C}$  /  $-22^{\circ}\text{F}$ , and fits over heavy freezer gloves. It accommodates both right and left hands, and includes a hand strap and a small finger strap. Medium and extra large finger straps are also available.

### Attaching the Low Temperature Back of Hand Mount

To attach the low temperature back of hand mount:

1. Install the hand and trigger straps to the low temperature mount as described in [Installing the Low Temperature Mount Straps for a Right-Handed User](#) or [Installing the Low Temperature Mount Straps for a Left-Handed User](#).
2. Position the low temperature mount on the hand as described in [Positioning the Low Temperature Mount](#).
3. Install the RS6100 onto the low temperature mount as described in [Installing the RS6100 onto the Low Temperature Mount](#).

### Installing the Low Temperature Mount Straps for a Right-Handed User

To install the mount straps for a right-handed user:

1. Hold the mount with the trigger assembly toward you.
2. On the Y-shaped hand strap, locate the two ends that include a snap, and slide them up through the top and bottom right slots on the back of hand assembly. Snap them into place.
3. Slide the long end of the strap up through the left center slot of the back of hand assembly, and press in place.
4. Slide the end of the trigger strap with the snap through the left trigger slot (as it faces you), and snap it in place.

5. Slide the other end of the trigger strap through the right trigger slot and leave slack.

**Figure 19** Right Hand User: Secure Straps

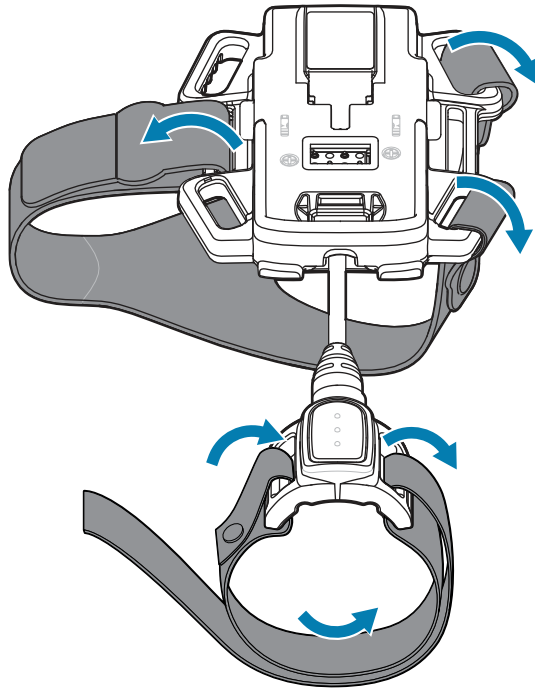

## Installing the Low Temperature Mount Straps for a Left-Handed User

To install the mount straps for a left-handed user:

1. Hold the back of hand mount with the trigger assembly toward you.
2. On the Y-shaped hand strap, locate the two ends that include a snap, and slide them up through the top and bottom left slots on the back of hand assembly. Snap them into place.
3. Slide the long end of the strap up through the right center slot of the back of hand assembly, and press in place.
4. Slide the end of the trigger strap with the snap through the right trigger slot (as it faces you), and snap it in place.

- Slide the other end of the trigger strap through the left trigger slot and leave slack.

**Figure 20** Left Hand User: Secure Straps

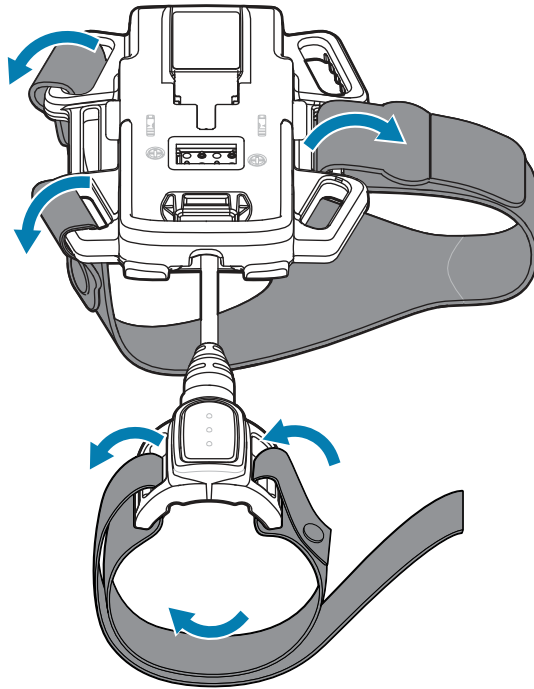

## Positioning the Low Temperature Mount

To properly position the low temperature back of hand mount on your hand:

- Slide your hand through the hand strap, with your thumb through the smaller opening between the two snaps and remaining fingers through the larger opening.
- Insert your finger(s) through the loose trigger strap based on the size of the strap::
  - Small trigger strap: insert index finger.
  - Medium trigger strap: insert index and middle fingers.
  - Large trigger strap: insert four fingers.

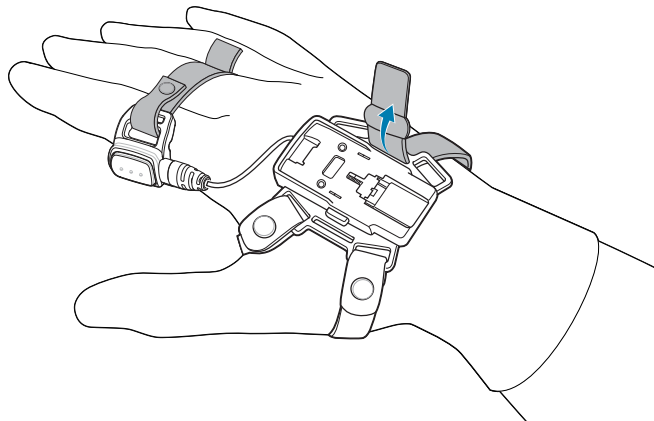

3. Adjust the strap to a comfortable position.

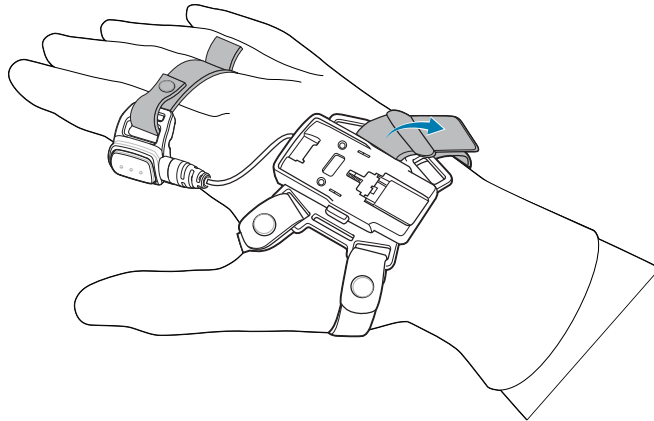

4. Place the trigger against your index finger, adjust the trigger strap to a comfortable position, and secure in place.

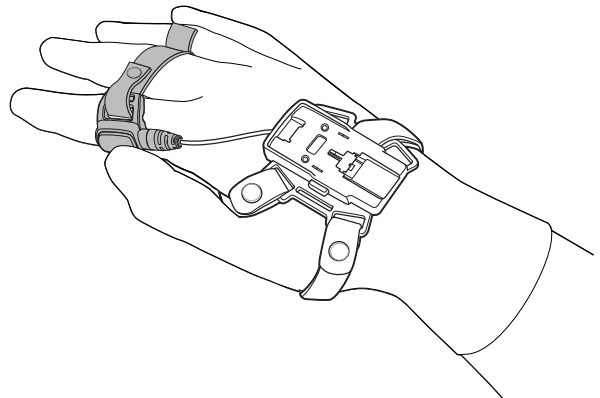
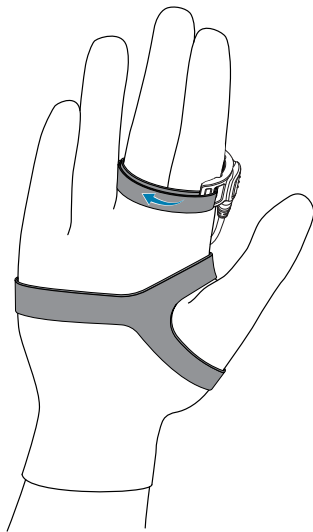

## Installing the RS6100 onto the Low Temperature Mount

To install the RS6100 onto the low temperature mount:

1. Engage the bump at the front of the RS6100 (on the underside) with the slot on the top of the mount.

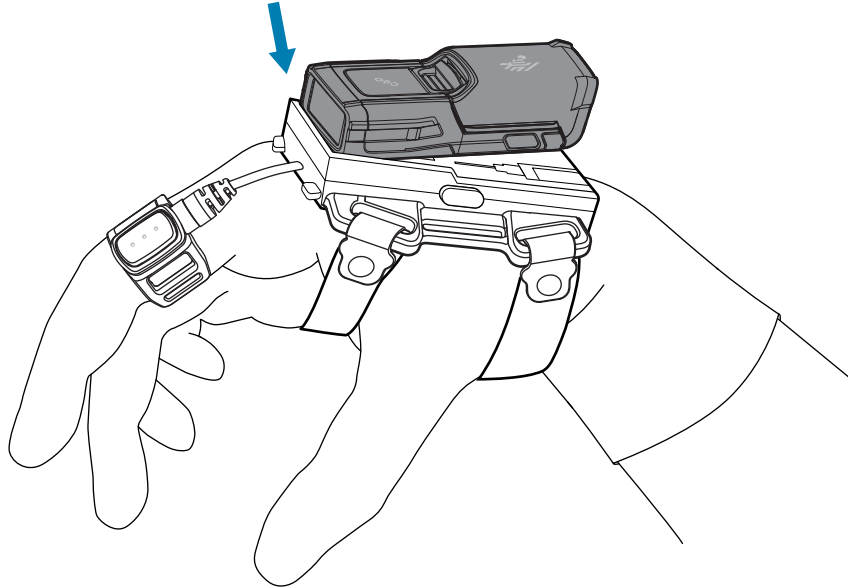

2. Pivot the RS6100 downward until it snaps into place.

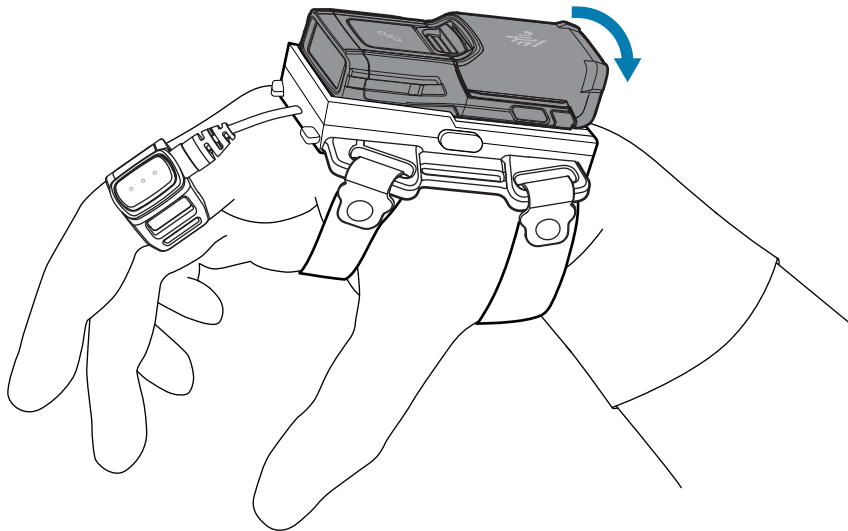

## Detaching the RS6100

To detach the RS6100 from the back of hand mount, press the release buttons on both sides of the mount and lift the RS6100 off the mount.

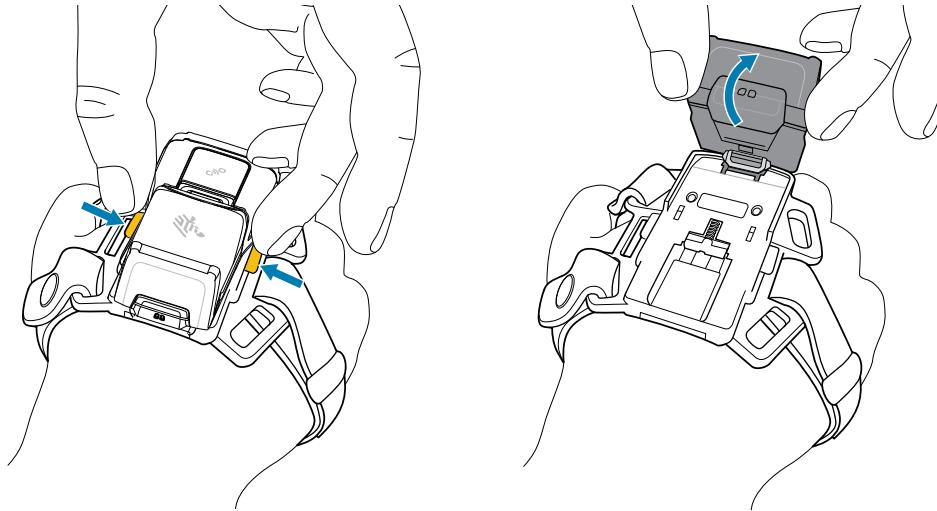

## Enterprise Hand Mount

The Enterprise Hand Mount allows the RS6100 to be worn on the back of the hand and provides a remote finger trigger. It is available for both right-handed and left-handed users, and in the following sizes, distinguished by the color of the stitching on the hand wrap.

- Small = white
- Medium = black
- Large = blue

## Attaching the Enterprise Hand Mount

To attach the Enterprise Hand Mount:

1. Install the hand wrap to the hand mount as described in [Installing the Hand Wrap for a Right-Handed User](#) or [Installing the Hand Wrap for a Left-Handed User](#).
2. Position the hand wrap on the hand as described in [Positioning the Hand Wrap](#).
3. Install the RS6100 onto the mount as described in [Installing the RS6100 on the Enterprise Hand Mount](#).

## Installing the Hand Wrap for a Right-Handed User

To install the hand wrap to the Enterprise Hand Mount for a right-handed user:

1. Insert the trigger cable and button through the trigger slot.

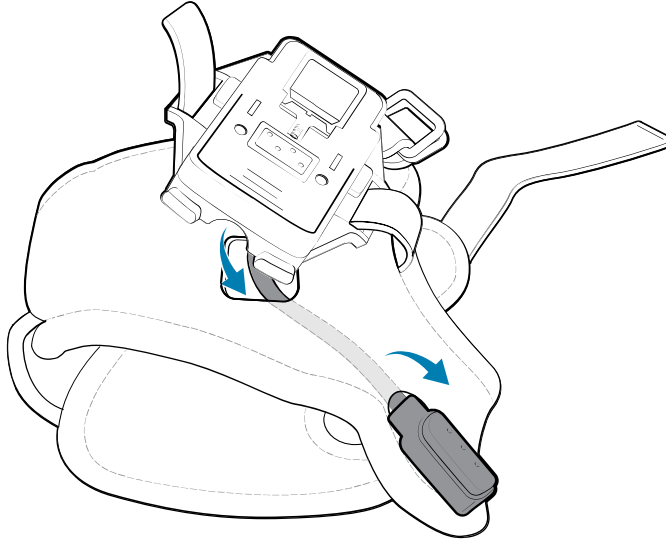

2. Insert the mount strap through the left slot of the mount (as it sits on your hand) and slide under the mount.

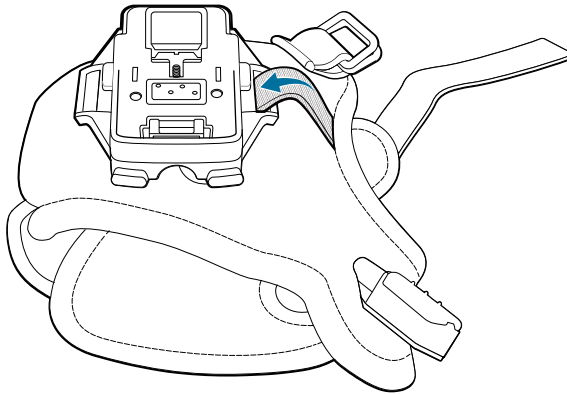

3. Insert the mount strap up through the remaining slot of the mount and fasten the strap end.

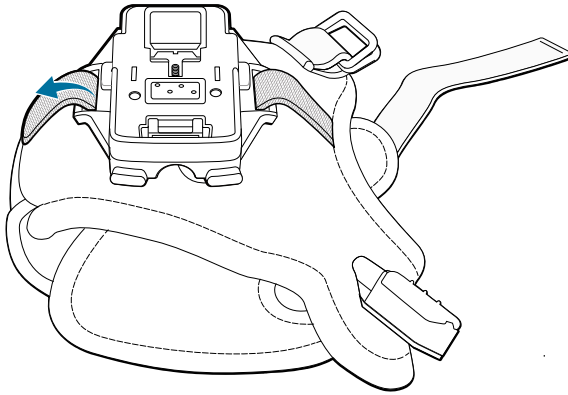

### Installing the Hand Wrap for a Left-Handed User

To install the hand wrap to the Enterprise Hand Mount for a left-handed user:

1. Insert the trigger cable and button through the trigger slot.

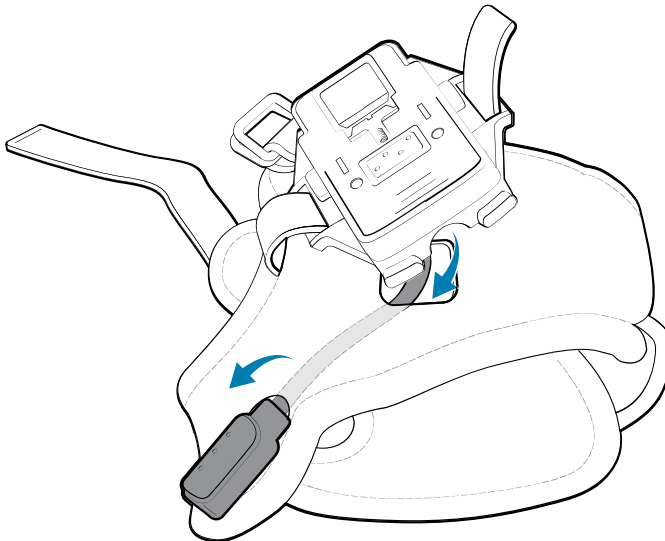



2. Insert the mount strap through the right slot of the mount (as it sits on your hand) and slide under the mount.

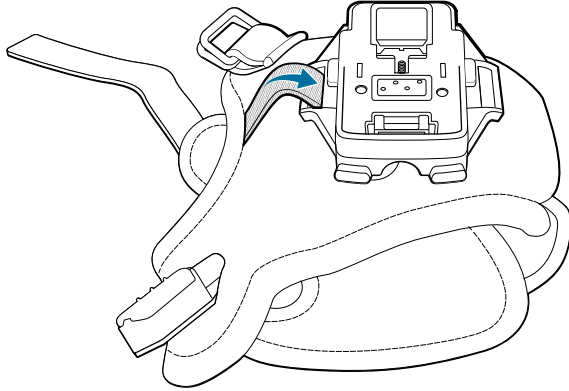

3. Insert the mount strap up through the remaining slot of the mount and fasten the strap end.

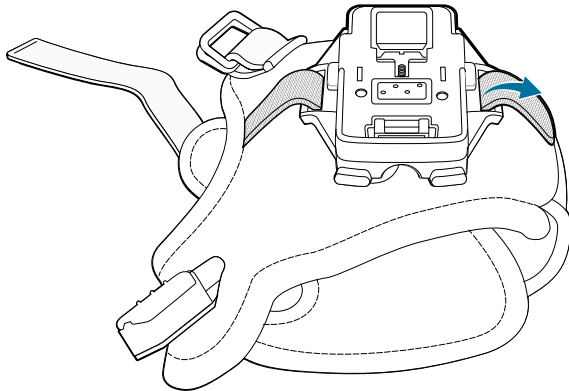

## Positioning the Hand Wrap

To position the hand wrap on the hand:

1. Slide your hand through the hand wrap, with your thumb through the smaller opening and remaining four fingers through the larger opening. Note the position for left-handed or right-handed use.

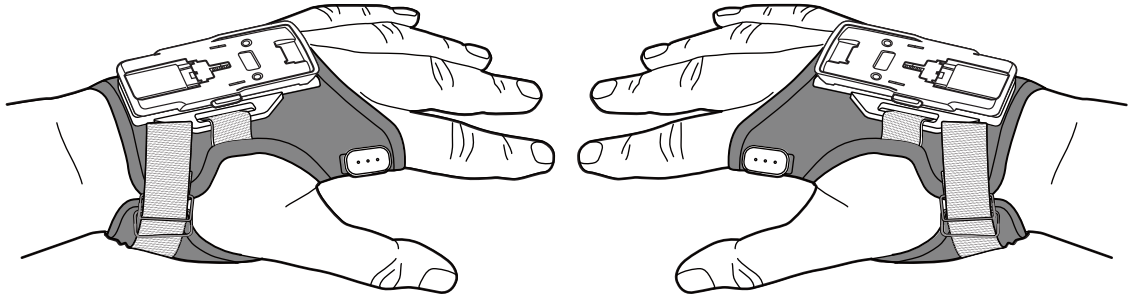

2. Adjust the strap to a comfortable position to fit securely.

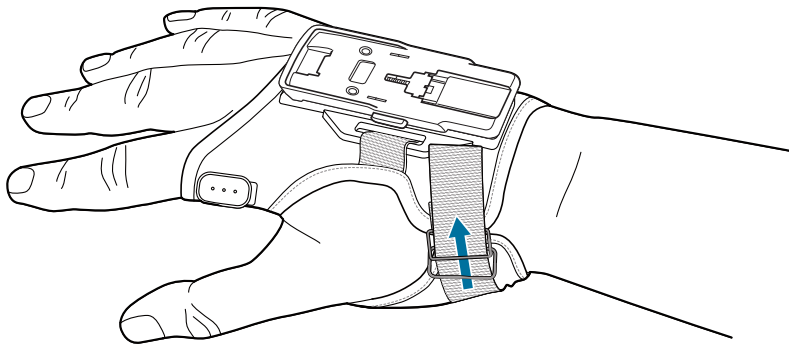

3. Slide the strap through the buckle and secure the end of the strap in place.

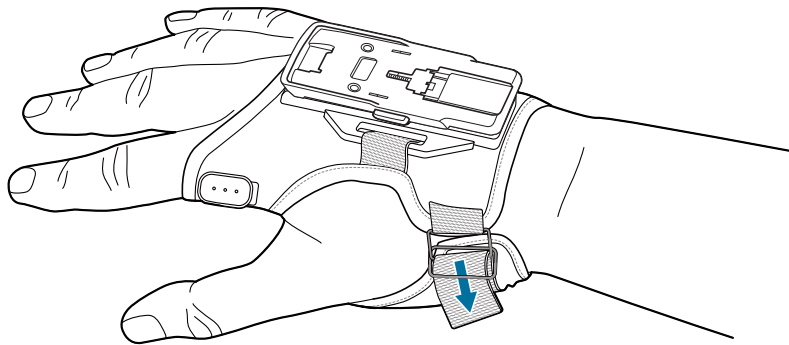

**NOTE:** The snap under the strap is a safety breakaway, and is not used to secure the strap.

4. Position the finger trigger button to allow access by your thumb, and fasten it in place.

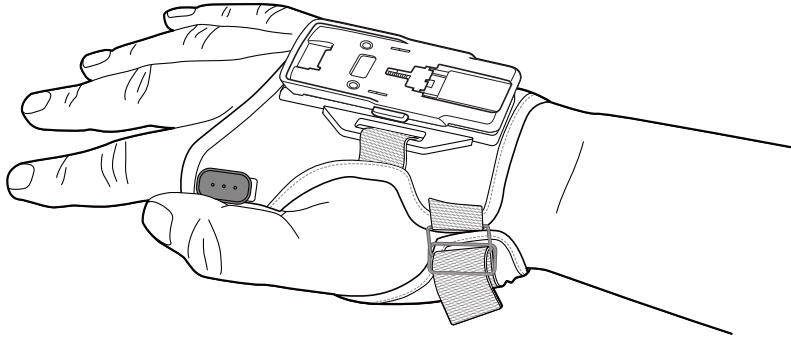

**5.** Align the mount on the hand wrap:

- a)** Lift the strap holding the mount in place.

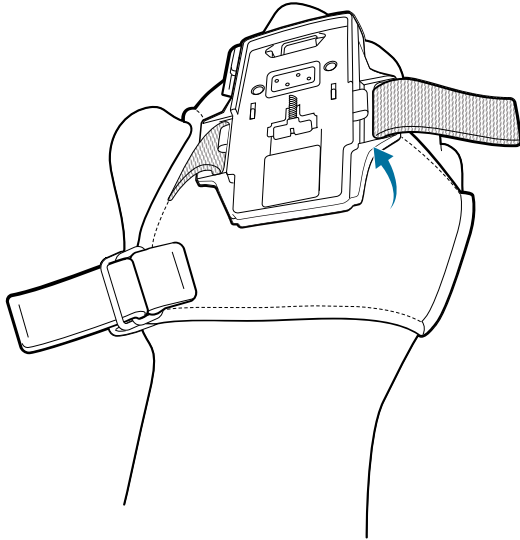

- b)** Detach and lift the mount.

- c)** Reposition the mount on the hand wrap to align the mount with your middle finger knuckle.

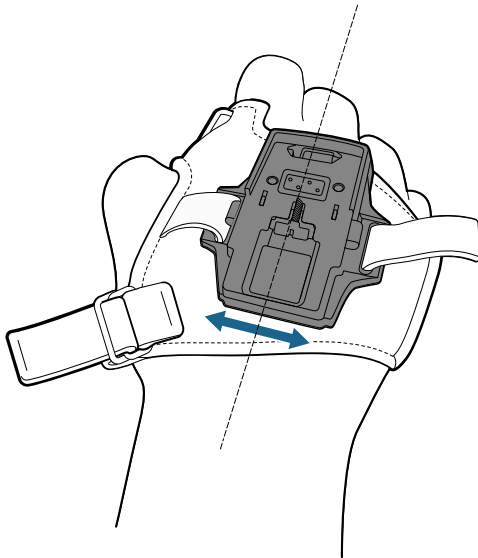

- d)** Fasten the strap.

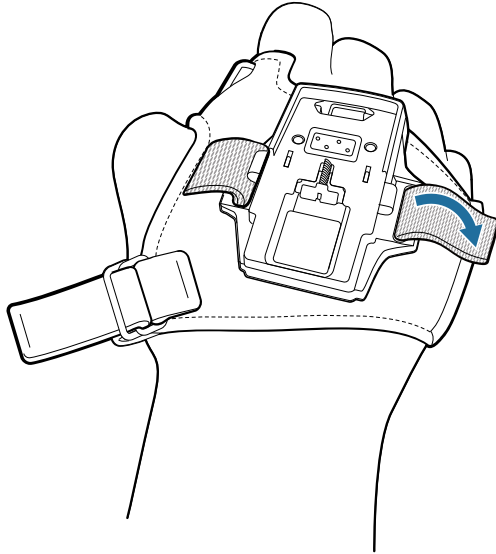

## Installing the RS6100 on the Enterprise Hand Mount

To install the RS6100 onto the Enterprise Hand Mount:

1. Align the contacts on the RS6100 with the contacts on the hand mount and engage the slot at the top of the RS6100 (on the backside) with the opening at the top of the mount.

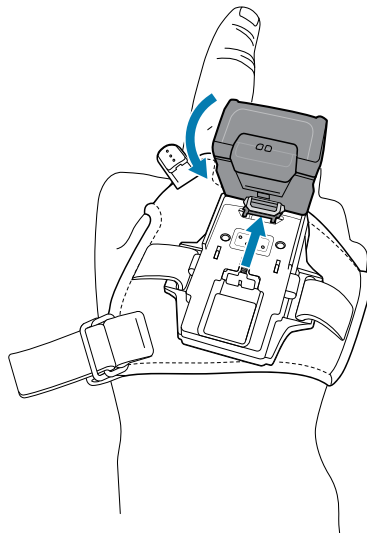

2. Push down on the RS6100 to snap into place.

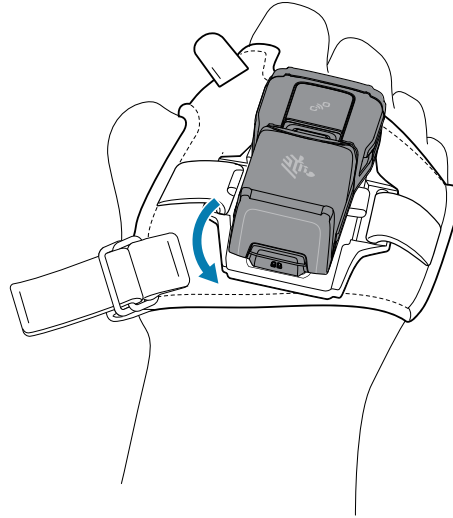

### Correct Installation

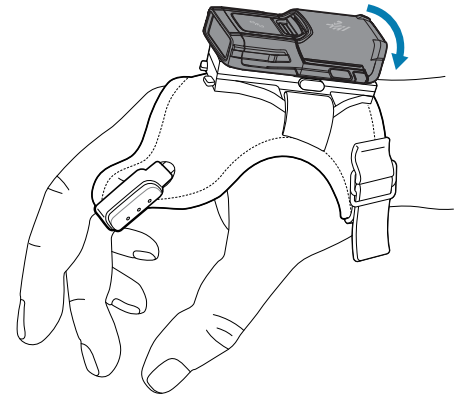
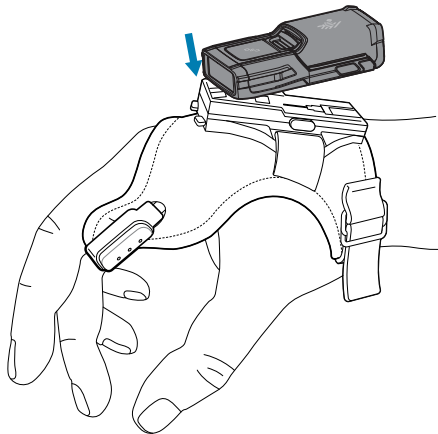

### Detaching the RS6100

To detach the RS6100 from the Enterprise Hand Mount:

1. Press the release buttons on both sides of the hand mount.

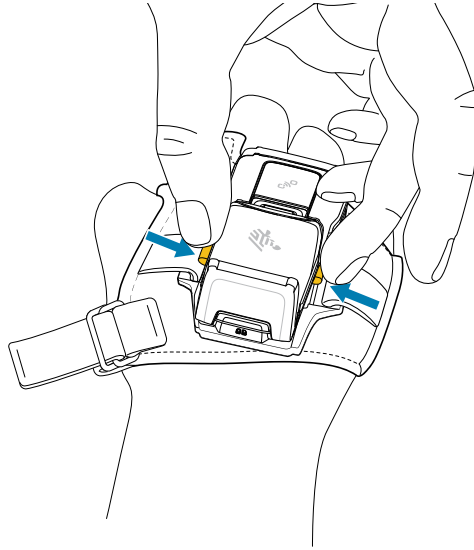

2. Lift the RS6100 off the mount.

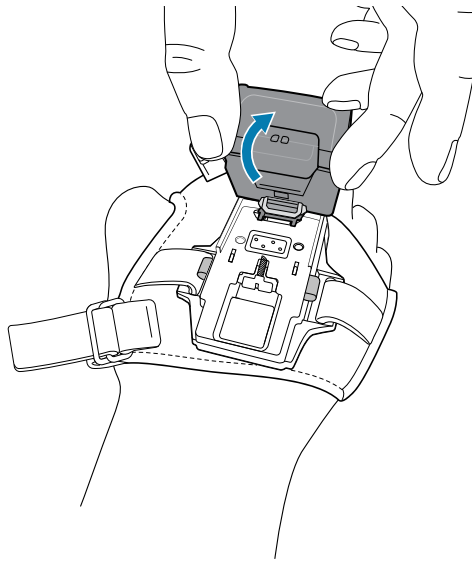

### Cleaning the Hand Wrap

Before cleaning the hand wrap, remove the electronics:

1. Unfasten the strap and detach the hand mount.

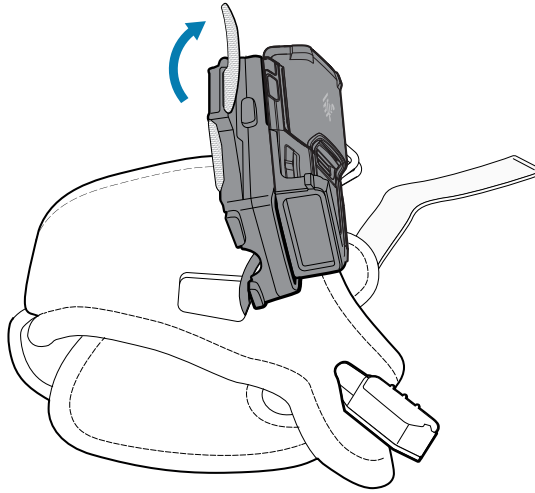

2. Slide the mount off the strap.

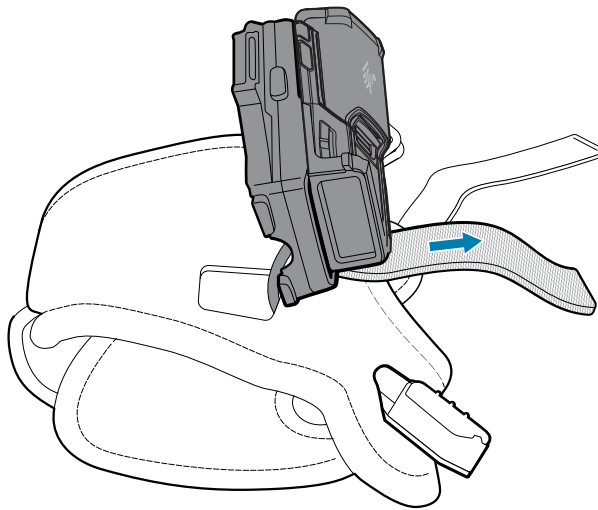



3. Remove the finger trigger button and cable from the hand wrap.

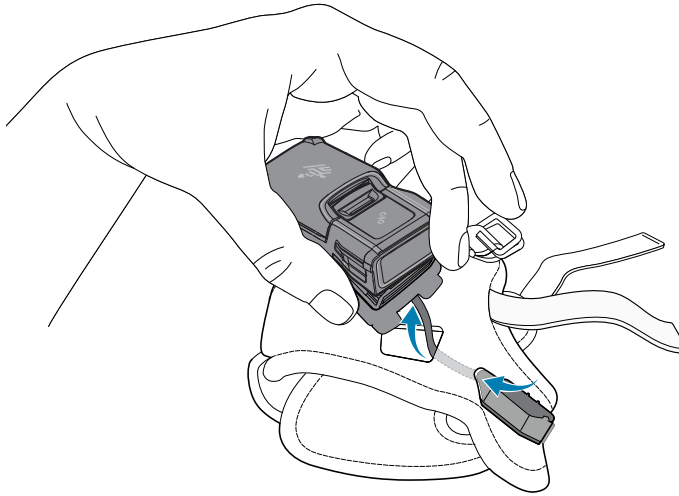

4. Use an approved cleaning agent or mild detergent on the hand wrap material only and air dry.

## Bluetooth Adapter

The BT-RS5X6-DNGL-01 Bluetooth Adapter provides Bluetooth capability to a host computer. Place it on a horizontal surface or mount it vertically.

### Horizontal Surface Mounting

Place the adapter on a horizontal surface.

The rubber feet provide traction and prevent surface damage.

### Mounting the Adapter With Screws

Mount the adapter using screws to hold it in place.

Use four M5 screws at least 13 mm long.

1. Place the Bluetooth Adapter on the desired location.
2. Mark the surface through the four mounting holes to determine the location of the screw holes.

3. Pre-drill the holes to accommodate four M5 screws.

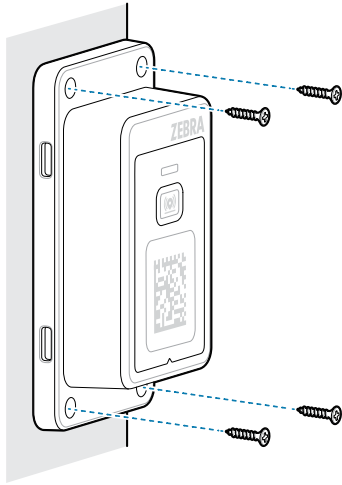

4. Attach the adapter securely to the surface.

## Mounting the Adapter with Cable Ties

Mount the adapter using cable ties to hold it in place.

Use two cable ties a maximum 8 mm wide and 3 mm thick.



**NOTE:** Mount the adapter no more than 2 m (6 ft 5in.) above the floor.

1. Place the Bluetooth adapter in the desired location.
2. Thread a cable tie through the top two mounting holes and wrap it around the pole. Tighten the cable tie.

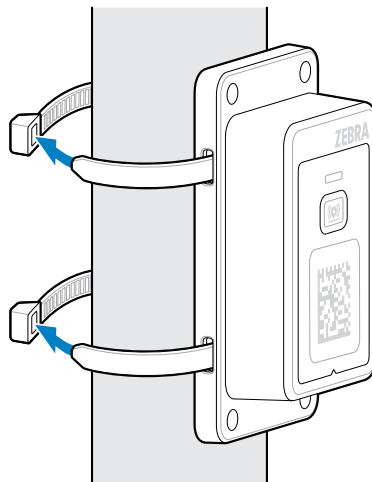

3. Trim excess cable tie length.
4. Repeat the process for the bottom mounting holes.

## Connecting the Adapter

Connect the Bluetooth Adapter to the host computer to provide a Bluetooth connection.

Use cable CBA-U46-S07ZAR.

1. Connect the latching end of the cable to the Bluetooth adapter port.

Press the cable firmly until you hear a click to ensure it is fully inserted into the port.

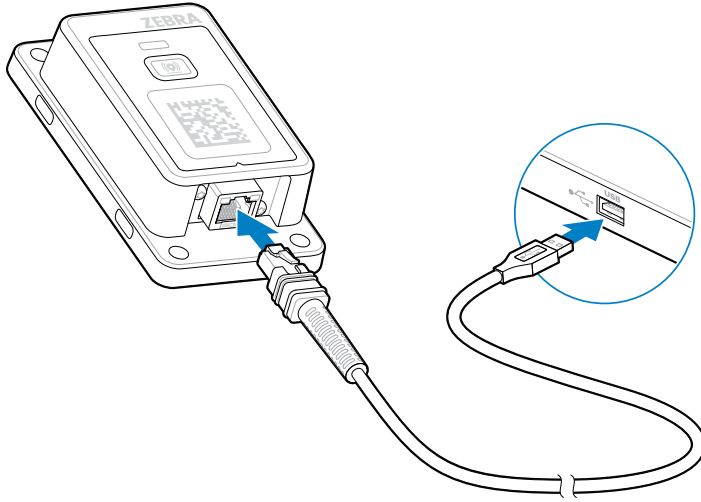

2. Connect the USB end of the cable to the host computer.

# 123Scan and Software Tools

This chapter describes the Zebra software tools available for customizing scanner operation.

## 123Scan

123Scan is a software tool that simplifies scanner setup and more.

Intuitive enough for first time users, the 123Scan wizard guides users through a streamlined setup process. Settings are saved in a configuration file that can be printed as a single programming barcode for scanning, emailed to a smart phone for scanning from its screen, or downloaded to the scanner using a USB cable.

Through 123Scan a user can:

- Configure a scanner using a wizard.
  - Program the following scanner settings.
    - Beeper tone / volume settings.
    - Enable / disable symbologies.
    - Communication settings.
  - Modify data before transmission to a host using:
    - Advanced Data Formatting (ADF) - Scan one barcode per trigger pull.
    - Multicode Data Formatting (MDF) - Scan many barcodes in one trigger pull (select scanners).
    - Preferred Symbol - Single out one barcode on label of many (select scanners).
- Load parameter settings to a scanner via the following.
  - Barcode scanning.
    - Scan a paper barcode.
    - Scan a barcode from a PC screen.
    - Scan a barcode from a smart phone screen.
  - Download over a USB cable.
    - Load settings to one scanner.
    - Stage up to 10 scanners simultaneously (Powered USB Hub recommended with 0.5 amp / port).

- Validate scanner setup.
  - View scanned data within the utility's Data view screen.
  - Capture an image and save to a PC within the utility's Data view screen.
  - Review settings using the Parameter Report.
  - Clone settings from an already deployed scanner from the Start screen.
- Upgrade scanner firmware.
  - Load settings to one scanner.
  - Stage up to 10 scanners simultaneously (Powered USB Hub recommended with 0.5 amp / port).
- View statistics such as:
  - Asset tracking information.
  - Time and usage information.
  - Barcodes scanned by symbology.
- Generate the following reports.
  - Barcode Report - Programming barcode, included parameter settings, and supported scanner models.
  - Parameter Report - Parameters programmed within a configuration file.
  - Inventory Report - Scanner asset tracking information.
  - Validation Report - Scanned data from the Data view.
  - Statistics Report - All statistics retrieved from the scanner.

For more information go to: [zebra.com/123Scan](https://zebra.com/123Scan).

## Communication with 123Scan

Use a USB cable to connect the scanner to a Windows host computer running 123Scan.

## 123Scan Requirements

- Host computer running Windows 10 or 11
- Scanner
- USB cable

## 123Scan Information

For more information on 123Scan, go to: [zebra.com/123Scan](https://zebra.com/123Scan)

For a 1 minute tour of 123Scan, go to: [zebra.com/ScannerHowToVideos](https://zebra.com/ScannerHowToVideos)

To see a list of all of our software tools, go to: [zebra.com/scannersoftware](https://zebra.com/scannersoftware)

## Scanner SDK, Other Software Tools, and Videos

Tackle all your scanner programming needs with our diversified set of software tools. Whether you need to simply stage a device, or develop a fully featured application with image and data capture as well as asset management, these tools help you every step of the way.

To download any of the following free tools, go to: [zebra.com/scannersoftware](https://zebra.com/scannersoftware).

- 123Scan configuration utility
- SDKs
  - Scanner SDK for Windows
  - Scanner SDK for Linux
  - Scanner SDK for Android
  - Scanner SDK for iOS
- Drivers
  - OPOS driver
  - JPOS driver
  - USB CDC driver
- Scanner Management Service (SMS) for Remote Management
  - Windows
  - Linux
- Mobile Apps
  - Scanner Control App
    - Android
    - iOS
  - Scan-To-Connect Utility
    - Android
    - Windows
- How-To-Videos



**NOTE:** For a list of SDK supported scanner functionality by communication protocol, see [Communication Protocol Functionality](#)

## Advanced Data Formatting

Advanced Data Formatting (ADF) allows customizing data before transmission to the host device. Use ADF to edit scanned data to suit the host application's requirements. With ADF you scan one barcode per trigger pull. ADF is programmed using 123Scan.

For a video on Creating an Advanced Data Formatting (ADF) Rule using 123Scan, go to [zebra.com/ScannerHowToVideos](https://zebra.com/ScannerHowToVideos).

For additional information, refer to the Advanced Data Formatting Programmer Guide.

## Multicode Data Formatting

Programming options include:

- Output all or specific barcodes.
- Control the barcode output sequence.
- Apply unique multicode data formatting (MDF) to each output barcode.
- Discard scanned data if all required barcodes are not present.

For more information, refer to the Multicode Data Formatting and Preferred Symbol User Guide, p/n MN-002895-xx.

For a video on Creating an Multicode Data Formatting (MDF) Rule using 123Scan, go to [zebra.com/ScannerHowToVideos](http://zebra.com/ScannerHowToVideos).

## Multicode Data Formatting Use

Multicode Data Formatting may yield multiple unexpected and undesired outputs when a label (most likely on a complex label) passes through the scanner's field of view. This problem happens when the complex label's barcodes can be matched by more than one group (for example, Group 1 represents all barcodes present, and Group 2 represent some barcodes present).

1. As the label is moving through the field of view, it is first partially read (some of the barcodes in the field of view in Frame 2).
2. Then, the second decode occurs as it is fully read (all the barcodes in the field of view in Frame 3).
3. This yields two different outputs (instead of the expected single output) from the presentation of a label. This problem is driven by a complex label inadvertently matching two different MDF rules/groups, thereby yielding two outputs.

**Figure 21** Scanning Label in a Horizontal Orientation

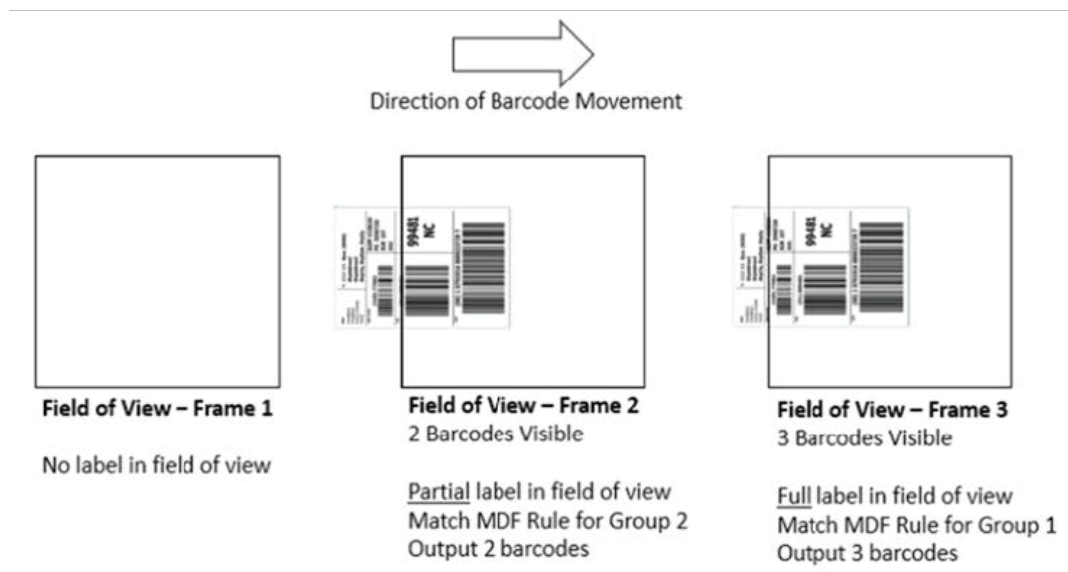

## MDF for Best Practices

Suggestions to minimize the undesired multiple outputs when scanning with MDF.

- Scan barcodes in a vertical orientation.

**Figure 22** Scanning Label in a Vertical Orientation

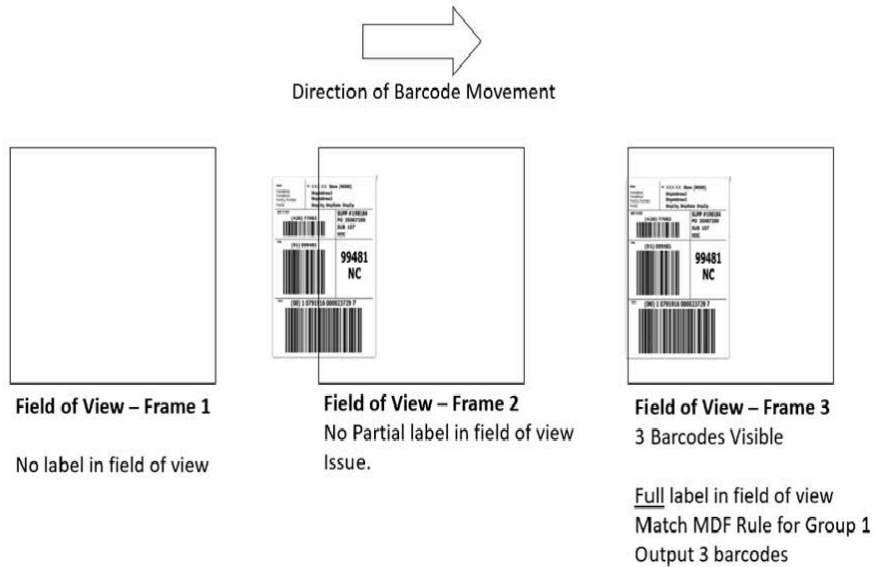

- When creating the MDF programming with multiple groups, the Group 1's pattern match should be the most complicated (hardest to match), which equals to the most number of barcodes and criteria. Then Group 2, 3, and so on should be progressively matched more easily.
- When defining criteria, avoid enabling an output when the pattern is not matched. Set **Output if NO pattern match** set as **Discard bar code**.

**Figure 23** Figure Match Setting for Output

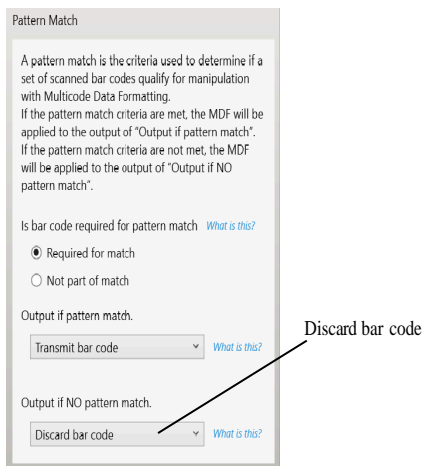

- Select Discard barcode(s) NOT within the pattern match in the 123Scan MDF setting. For more details, select **What is this?** located next to this selection.



- To prevent double decodes of the same symbol, increase the Timeout Between Same Symbols setting. See [Timeout Between Decodes, Same Symbol](#) for more details.
- Turn the scanner's aimer on to assist operators in scanning the barcode in a more consistent manner.
- Other reasons a label/barcode may not be decoded while in the field of view are as follows:
  - The label out of focus (too close or too far away). See [Decode Distances](#) for correct working range.
  - Specular reflection (reflection off a shiny surface).
  - The label is presented at an extreme angle to the scanner.

## Preferred Symbol

Preferred Symbol is a barcode prioritization technique that enables favored decoding of high-priority barcode(s). The Preferred Symbol is the only barcode that is decoded and output within the preset Preferred Symbol Timeout. During this time, the scanner attempts to decode the prioritized barcode and reports only this barcode.

For more information, refer to the Multicode Data Formatting and Preferred Symbol User Guide, p/n MN-002895-xx.

To program Preferred Symbol via 123Scan, select **123Scan > Configuration Wizard > Symbologies** screen, and then select **Preferred Symbol** from the drop-down menu. Preferred Symbol programming is saved in the 123Scan configuration file.

**Figure 24** Preferred Symbol Programming Options

Preferred Symbol

Preferred Symbol [What is this?](#)

Options

**Prioritized symbologies**

Preferred Symbol Options  [Edit](#)

**Identify exact bar code**

Preferred symbol criteria [View / Edit](#)

Prioritization time (ms)  [What is this?](#)

## Data Parsing (UDI Scan+, Label Parse+ and Blood Bag Parse+)

Data Parsing allows a Zebra scanner to scan a UDI label, GS1 label, or Blood Bags with one or more barcodes encoded with multiple data fields (such as date of manufacture, expiration date, batch number, GTIN, and SSCC) and transmit select data fields and not others, in a specific order to a host application. Wave the scanner over all the barcodes while holding the trigger.

The scanner finds and transmits only the required data fields, even if they are spread across multiple barcodes and on different sides of the container.

In addition, the scanner can insert field separators (such as tab, enter, and slash) to automate data entry into a host application.

Use 123 Scan to program your scanner. For more information on writing a Data Parsing Rule, refer to the Data Parsing (UDI, GS1 Label, Blood Bag) on Zebra Scanners User Guide at: [zebra.com/support](https://zebra.com/support). To watch a video on Creating a Data Parsing Rule using 123Scan, go to: [zebra.com/ScannerHowToVideos](https://zebra.com/ScannerHowToVideos).

### Scan a UDI Label using UDI Scan+

Government regulatory agencies (such as the United States Food and Drug Administration (FDA), European Commission, and International Medical Device Regulatory Forum) have established Unique Device Identification (UDI) standards to identify and monitor the distribution and use of medical devices within healthcare environments

These UDI standards identify medical devices from manufacturing through distribution to patient use - enabling complete traceability of the millions of individual medical devices utilized for patient care. To enable UDI compliance, all medical devices must carry a UDI label to enable “track and trace” from the point of production, during shipment, through the product’s use and disposal.

### Scan a GS1 Label using Label Parse+

The GS1 Organization, an international standards body, has released specifications used worldwide for generating shipping labels. These labels are used when shipping packages (logistics), raw materials and produce.

### Scan a Blood Bag Label using Blood Bag Parse+

The International Council for Commonality in Blood Banking Automation (CCBBA Organization, an international standards body, has released a worldwide specification for generating blood bag labels. These labels are used when shipping, storing, and using blood bags.



**NOTE:** For more information, go to: [isbt128.org/tech-library/iccbba-documents/standards-documents/standard-labeling-blood](https://isbt128.org/tech-library/iccbba-documents/standards-documents/standard-labeling-blood).

# RS6100 Configuration and Update

This chapter describes how to configure the RS6100, use the Real Time Logger application, and update firmware.

## RS6100 Configuration

The RS6100 is provided with a default software configuration set in the factory, which can be configured to meet customer-specific operational requirements. Before using the RS6100, configure the device properly to best use its extensive capabilities and gain maximum efficiency.

To configure the RS6100, scan special configuration barcodes or use the 123Scan application. When the RS6100 is connected to a Zebra mobile computer, some configuration parameters can be automatically overwritten by an EMDK application or DataWedge.



**NOTE:** Perform a warm boot after scanning the configuration barcodes to reset the RS6100.



**NOTE:** Once the RS6100 is paired to a Zebra host device, the scanning software disables the ability to read configuration barcodes.

## DataWedge

The DataWedge application available on Zebra mobile computers is used to configure scanner settings and process scanned data before sending to an application.

DataWedge is based on profiles, which direct DataWedge behavior for different applications. Using profiles, each application can have a specific DataWedge configuration. For example, each user application can have a DataWedge profile that processes scanned data in the required format for that application.

Once connected to a Zebra mobile computer, DataWedge settings override some of the RS6100 parameters previously set via configuration barcodes or 123Scan. These settings only apply while the RS6100 is connected to the mobile computer, and do not persist once the RS6100 is disconnected and reset.

For more information on DataWedge, refer to WT6000 Integrator Guide, p/n MN-002699-xx.

## 123Scan

123Scan is a PC-based software tool that enables rapid customized setup of the device.

123Scan uses a wizard tool to guide users through a streamlined set up process. Settings are saved in a configuration file that can be distributed via e-mail or used to generate a sheet of programming barcodes.

123Scan can upgrade device firmware, check on-line to enable support for newly released products, generate a collection of multi-setting barcodes if the number of settings is very large, and generate reports with asset tracking information.

For more information on 123Scan, see [123Scan](#).

## Real Time Logger

The Real Time Logger application logs RS6100 events, errors, exceptions, and software diagnostics. Each log record has a time stamp with a 1 ms resolution. The log record memory size is 4 MB and is cyclic. Log records reset after a cold or clean boot.

The following figure shows the Real Time Logger file content as shown on a host computer screen.

**Figure 25** Real Time Logger Content Screen

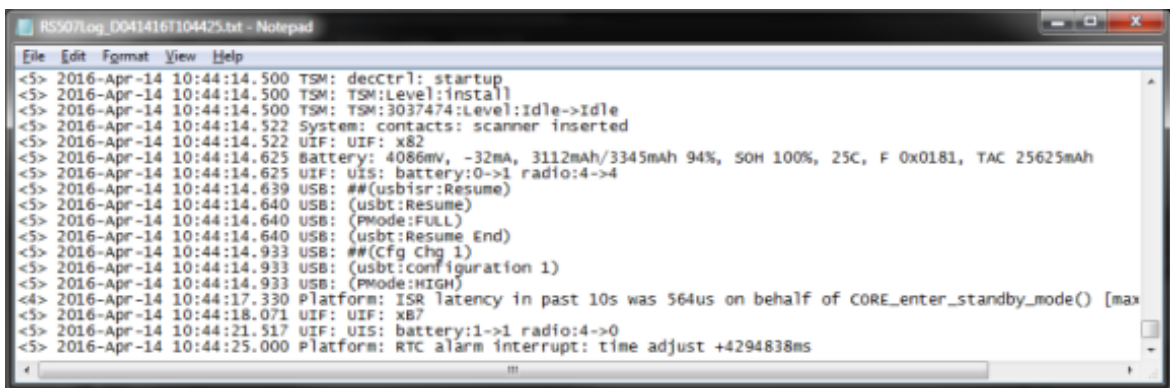

```

RS507.log_D0414161104425.txt - Notepad
File Edit Format View Help
<5> 2016-Apr-14 10:44:14.500 TSM: decCtrl: startup
<5> 2016-Apr-14 10:44:14.500 TSM: TSM:Level:install
<5> 2016-Apr-14 10:44:14.500 TSM: TSM:3037474:Level:Idle->Idle
<5> 2016-Apr-14 10:44:14.522 System: contacts: scanner inserted
<5> 2016-Apr-14 10:44:14.522 UIF: UIF: x82
<5> 2016-Apr-14 10:44:14.625 Battery: 4086mV, -32mA, 3112mAh/3345mAh 94%, SOH 100%, 25C, F 0x0181, TAC 25625mAh
<5> 2016-Apr-14 10:44:14.625 UIF: UIS: battery:0->1 radio:4->4
<5> 2016-Apr-14 10:44:14.639 USB: ##(usbt:Resume)
<5> 2016-Apr-14 10:44:14.640 USB: (usbt:Resume)
<5> 2016-Apr-14 10:44:14.640 USB: (Pmode:FULL)
<5> 2016-Apr-14 10:44:14.640 USB: (usbt:Resume End)
<5> 2016-Apr-14 10:44:14.933 USB: ##(Cfg Chg 1)
<5> 2016-Apr-14 10:44:14.933 USB: (usbt:configuration 1)
<5> 2016-Apr-14 10:44:14.933 USB: (Pmode:HIGH)
<4> 2016-Apr-14 10:44:17.330 Platform: ISR latency in past 10s was 564us on behalf of CORE_enter_standby_mode() [max
<5> 2016-Apr-14 10:44:18.071 UIF: UIF: XB7
<5> 2016-Apr-14 10:44:21.517 UIF: UIS: battery:1->1 radio:4->0
<5> 2016-Apr-14 10:44:25.000 Platform: RTC alarm interrupt: time adjust +4294838ms
  
```

## Retrieving the RS6100 Log File

The RS6100 log file is retrieved over a USB connection using a host computer, USB trigger, and the RS507PCTool application.



**NOTE:** If running Windows 7 or 8, the RS507PCTool application requires installing the Scanner CDC driver on the host computer. This driver creates a virtual COM port (Scanner Virtual COM Port) when the RS6100 is connected to a host computer via USB. Both RS507PCTool and the Scanner USB CDC driver are available for download from [zebra.com/support](http://zebra.com/support).

To obtain log messages over a USB connection:

1. Scan the **SSI over USB CDC** bar code to switch the RS6100 USB connection from SNAPI to CDC / SSI.

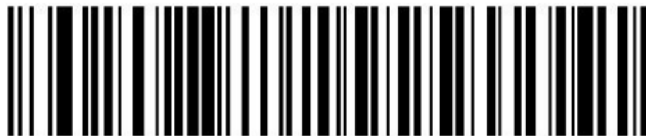

2. Connect the RS6100 to the host computer via the USB trigger.
3. Open the RS507PCTool application.

- In the **Device** section, click **Open**. The virtual COM port assigned to the RS6100 opens and RS6100 **Device Info** displays.

When the RS6100 is connected to the RS507PCTool, the logger time on the RS6100 is synchronized with the host computer's time.

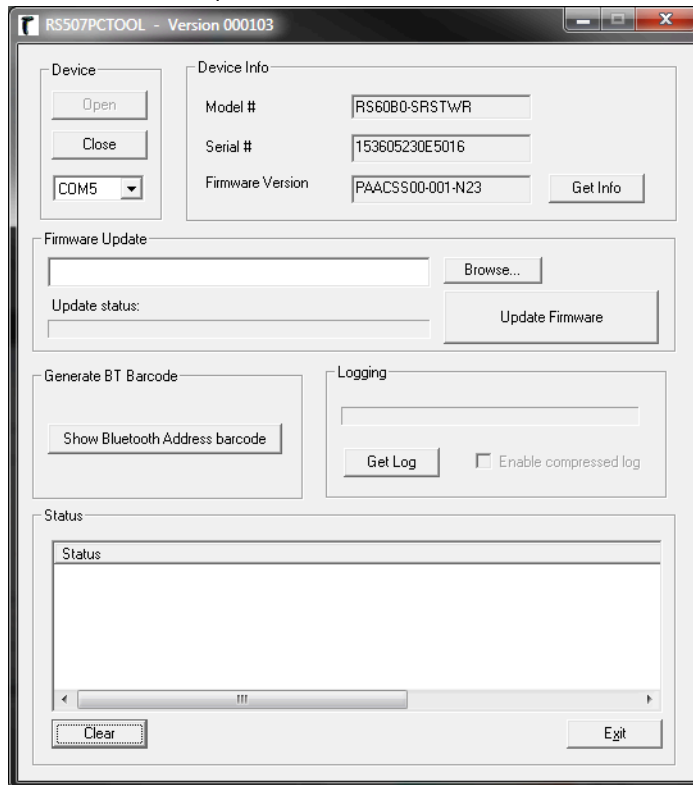

- Click **Get Log**.

The log file, with the name format RS507Log\_D<date&time>.txt, is saved in the same directory on the host computer as the RS507PCTool application.

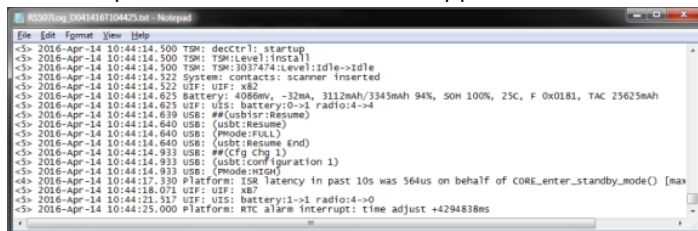

## RS6100 Firmware Update

RS6100 devices can be updated and re-flashed with new firmware. To perform the update, download the firmware to the RS6100 flash memory. If the download fails, the previous firmware remains operational. The firmware remains in RS6100 memory even when powering the RS6100 off and on (removing and re-installing the battery).

The RS6100 firmware can be updated via Bluetooth using 123Scan or a connected Zebra device.



**NOTE:** Ensure the current firmware version is different from the version selected for an update. Attempting to update the firmware version that is already installed results in a failed process.

Updating firmware with different parameters causes the scanner and its connection to the host device to reset. Manually scan/tap to pair the scanner to a host device after a firmware update.

### Bluetooth Using 123Scan

The 123Scan application can upgrade the RS6100 firmware using Bluetooth to connect to a host computer. For more information on using 123Scan, go to [123Scan](#).

### Bluetooth Connected Zebra Device

The Zebra WT6000 or later device provides Enterprise Mobility Developer Kit (EMDK) support for updating the firmware of a Bluetooth connected RS6100. Using a Mobile Device Management (MDM) application, RS6100 firmware is deployed to the WT6000 device. Then an EMDK application must be created which downloads the firmware to the RS6100.

### Updating the Firmware

Update RS6100 firmware using the Zebra Device Central app (version 2.1.0.14 or later).

1. Deploy the firmware update to the Zebra host device in the location:

```
\Internal shared storage\Android\data\com.symbol.devicecentral\files
```

2. Open the Device Central app, and pair the RS6100.
3. Tap the RS6100 item to show device details.
4. Tap the **Firmware update** button.

# Radio Communications

This section provides information about the modes of operation and features available for wireless communication between scanners, cradles, and hosts. The section also includes the parameters necessary to configure the scanner.

The scanner ships with the settings shown in the following table. If the default values suit requirements, programming is not necessary.

## Radio Communications Parameter Defaults

This section lists the defaults for radio communication parameters. Change these values in one of two ways:

- Scan the appropriate barcodes in this chapter. The new value replaces the standard default value in memory. To recall default parameter values, use the following table.
- Configure the scanner using the 123Scan configuration program. See [123Scan and Software Tools](#) on page 76.



**NOTE:** Standard parameter defaults are available in each chapter of this guide.

**Table 8** Radio Communication Defaults

Parameter	Parameter Number	SSI Number	Default
Radio Communications Host Types	N/A	N/A	SSI Bluetooth Classic (Cradle Host)
Bluetooth Technology Profile Support			
Bluetooth Friendly Name	607	F1h 5Fh	Family Name and Serial Number
Discoverable Mode	610	F1h 62h	General
Wi-Fi Friendly Options			
Wi-Fi Friendly Mode	1299	F8h 05h 13h	Disable
Wi-Fi Friendly Channel Exclusion	1297	F8h 05h 11h	Use All Channels (Standard AFH)
Bluetooth Radio Parameters			
Radio Output Power	1324	N/A	Class 2 Low Power

## Radio Communications

**Table 8** Radio Communication Defaults (Continued)

Parameter	Parameter Number	SSI Number	Default
Link Supervision Timeout	1698	F4h 06h A2h	2 Seconds
HID Host Parameters			
Apple iOS Virtual Keyboard Toggle	1114	F8h 04h 5Ah	Disable
Keyboard Keystroke Delay	N/A	N/A	No Delay (0 msec)
Caps Lock Override	N/A	N/A	Do Not Override Caps Lock Key (Disable)
Barcodes with Unknown Characters	N/A	N/A	Send Barcodes with Unknown Characters
Fast HID Keyboard	1361	F8h 05h 51h	Enable
Numeric Keypad Emulation	N/A	N/A	Enable
Quick Keypad Emulation	1362	F8h 05h 52h	Enable
Keyboard FN1 Substitution	N/A	N/A	Disable
Function Key Mapping	N/A	N/A	Disable
Simulated Caps Lock	N/A	N/A	Disable
Convert Case	N/A	N/A	No Case Conversion
Auto-reconnect Parameters			
Beep on Reconnect Attempt	559	F1h 2Fh	Disable
Reconnect Attempt Interval	558	F1h 2Eh	30 Seconds
Auto-reconnect	604	F1h 5Ch	Immediately
Scanner(s) to Cradle Support			
Modes of Operation	538	F1h 1Ah	Point-to-Point
Bluetooth Classic and/or Low Energy (Cradle Host Only)	1355	F8h 05h 4Bh	Bluetooth Classic and Low Energy
Parameter Broadcast (Cradle Host Only)	148	94h	Enable
Pairing Modes	542	F1h 1Eh	Unlocked
Pair on Contacts	545	F1h 21h	Enable
Toggle Pairing	1322	F8h 05h 2Ah	Disable
Auto Un-Pairing	1708	N/A	Disable
Connection Maintenance Interval	N/A	N/A	15 Minutes
Bluetooth Security			
PIN Code	552	F1h 28h	12345
Variable PIN Code	608	F1h 60h	Static
Bluetooth Security Level	1393	F8h 05h 71h	Low
FIPS Mode	736	F1h E0h	Disable



**Table 8** Radio Communication Defaults (Continued)

Parameter	Parameter Number	SSI Number	Default
General Radio Parameters			
Batch Mode	544	F1h 20h	Normal (Do Not Batch Data)
Persistent Batch Storage	1399	F8h 05h 77h	Disable
Beep on Insertion	288	F0h 20h	Enable
Bluetooth SPP Beep on <BEL>	150	96h	Enable
Beacon Upon Disconnection	2403	F8h 09h 63h	Disable
Beaconing Parameters			
Unpaired Beaconing	2404	F8h 09h 64h	Disable
Beaconing Beep	2405	F8h 09h 65h	Disable
Beacon Frequency	2406	F8h 09h 66h	100 msec
Beacon Battery Threshold	2407	F8h 09h 67h	30%
Beacon ID	2408, 2409	N/A	N/A

## Wireless Beeper Definitions

The definitions lists beep sequences that occur during pairing operations.

**Table 9** Wireless Beeper Definitions

Beeper Sequence	Indication
High/low/high/low beeps	Pairing barcode scanned.
Short low/high beeps	Scanner paired with the cradle.
Short high/low beeps	Scanner unpaired with the cradle.   <b>NOTE:</b> When connected to a remote device using SPP or HID, if a disconnect beep sequence sounds immediately after scanning a barcode, check the host device to determine if it received the transmitted data. The scanner may have transmitted the last barcode scanned after losing the connection.
Long low long/high beeps	Unsuccessful pairing attempt. See <a href="#">Auto-reconnect Parameters</a> .
Long low/long high/long low/ long high beeps	Remote device rejected the connection attempt, possibly due to an attempt to pair with a cradle that is already paired with the maximum number of scanners.
Long high beeps.	The Audio Virtual Tether alarm on scanner is enabled.
Four long low beeps	A transmission error occurred and the data is ignored, due to an improperly configured scanner. Check option setting.

**Table 9** Wireless Beeper Definitions (Continued)

Beeper Sequence	Indication
	During cradle communication, the scanner did not receive acknowledgment of data receipt from the cradle. However, the host may have received the data. Check the host for receipt of the data, and re-scan the barcode if it was not received.
Five high beeps	Emitted every five seconds during a reconnection attempt. See <a href="#">Auto-reconnect Parameters</a> .

## Radio Communications Host Types

Each host type has Bluetooth Classic and Bluetooth Low Energy options.

Bluetooth Low Energy has better Wi-Fi coexistence, as advertising and connection is performed outside of Wi-Fi channels 1, 6, and 11 (2402, 2426, 2480 MHz). Due to its smaller data rate, Bluetooth Low Energy is up to 7 times slower than Bluetooth Classic (0.27 Mbps versus 0.7-2.1 Mbps), and data-intensive activities such as firmware updates can take significantly longer.

To set up the scanner for cradle communication, or to use standard Bluetooth profiles, choose one of the host type options.

**Table 10** Radio Communications Host Type Options

Host Type	Options
<a href="#">Cradle</a>	<ul style="list-style-type: none"> <li>Cradle Bluetooth Classic</li> <li>Cradle Bluetooth Low Energy</li> </ul>
<a href="#">Keyboard Emulation (HID)</a>	<ul style="list-style-type: none"> <li>HID Bluetooth Classic</li> <li>HID Bluetooth Low Energy (Discoverable)</li> </ul>
<a href="#">Simple Serial SSI (SSI)</a>	<ul style="list-style-type: none"> <li>SSI Bluetooth Classic (Non-discoverable)</li> <li>SSI Bluetooth Classic (Discoverable)</li> <li>SSI Bluetooth Low Energy</li> <li>SSI Bluetooth with MFi (iOS Support)</li> </ul>
<a href="#">Serial Port Profile (SPP)</a>	<ul style="list-style-type: none"> <li>SPP Bluetooth Classic (Non-discoverable)</li> <li>SPP Bluetooth Classic (Discoverable)</li> </ul>

## Cradle

Select this host type when connecting a scanner to a communication cradle.



**NOTE:** The scanner automatically tries to reconnect to a remote device upon a disconnection due to the radio losing communication. See [Auto-reconnect Parameters](#) for more information.

### Establishing a Cradle Connection

This procedure is for the initial setup only.

1. Choose the Cradle Bluetooth Classic or Cradle Bluetooth Low Energy option.
2. Choose the pairing barcode on the cradle or place the scanner in the cradle.



\*Cradle Bluetooth Classic

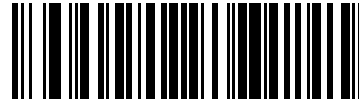

Cradle Bluetooth Low Energy

## Keyboard Emulation (HID)

Select this host type when connecting to a PC/tablet/phone emulating a Bluetooth keyboard.

### HID Bluetooth Classic

This enables the host and scanner to communicate using HID (Human Interface Device) Keyboard Profile over Bluetooth Classic radio. The scanner(s) are discoverable (Peripheral mode) and also support Central mode.

To establish a connection (initial setup only), select `HID Bluetooth Classic` and connect to Central or Peripheral mode:

- Central mode - Scan a pairing barcode with the MAC address of the host device.
- Peripheral mode - From the host, discover Bluetooth devices and select the scanner from the discovered device list.



HID Bluetooth Classic

### HID Bluetooth Low Energy (Discoverable)

This enables the host to establish an HID (Human Interface Device) Keyboard Profile connection with the scanner over a Bluetooth Low Energy radio. The scanner is discoverable (Peripheral mode).

To establish a connection (initial setup only), choose the `HID Bluetooth Low Energy (Discoverable)` option. From the host, discover Bluetooth devices and select the scanner from the discovered device list.



HID Bluetooth Low Energy (Discoverable)

### Simple Serial Interface (SSI)

Select this host type when connecting to a Zebra mobile device or PC/tablet/phone running a Zebra scanner SDK app.

#### SSI Bluetooth Classic (Non-discoverable)

This enables the scanner(s) to establish a connection with a Zebra mobile computer over a Bluetooth Classic radio. The scanner is not discoverable (Central mode).

To establish a connection (initial setup only), choose the `SSI BT Classic (Non-discoverable)` option, and then scan a pairing barcode with the host device's MAC address.



**NOTE:** Additional steps may be necessary depending on host's Bluetooth stack.

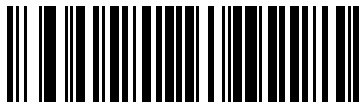

SSI Bluetooth Classic (Non-discoverable)

#### SSI Bluetooth Classic (Discoverable)

This enables communication with Scanner SDK for Android generated apps, and allows the host to establish a connection with the scanner over Bluetooth Classic radio. The scanner is discoverable (Peripheral mode).

To establish a connection (initial setup only), choose the `SSI Bluetooth Classic (Discoverable)` option. From the host, discover Bluetooth devices and select the scanner from the discovered device list.



SSI Bluetooth Classic (Discoverable)

## SSI Bluetooth Low Energy

This enables communication with Scanner SDK for iOS generated apps, and allows the host to establish a connection with the scanner over Bluetooth Low Energy radio. The scanner is discoverable (Peripheral mode).

To establish a connection (initial setup only), choose the SSI Bluetooth Low Energy option. From the host application, select the scanner from the discovered device list.

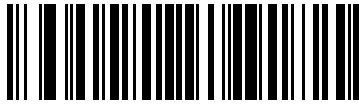

SSI Bluetooth Low Energy

## SSI Bluetooth with MFi (iOS Support)

This enables communication with Scanner SDK for iOS generated apps, and allows an Apple device and scanner to communicate over a Bluetooth Classic radio. The scanner is discoverable (Peripheral Mode) and also supports Central Mode. The scanner must be MadeForiOS (MFi) certified.

To establish a connection (for initial setup only), choose the SSI BT with MFi (iOS Support) option, and then:

- If connecting in Central mode, scan a pairing barcode with the host device MAC address.
- If connecting in Peripheral mode, from the host application, discover Bluetooth devices, and then select the scanner from the discovered device list.



SSI BT with MFi (iOS Support)

## Serial Port Profile (SPP)

Select this host type when connecting to a PC/tablet/phone using a Bluetooth serial connection.

### SPP BT Classic (Non-discoverable)

This enables the scanner to establish an SPP connection with the host over Bluetooth Classic radio. The scanner is not discoverable (Central mode).

To establish a connection (initial setup only), choose the SPP BT Classic (Non-discoverable) option, and then scan a pairing barcode with the MAC address of the host device.

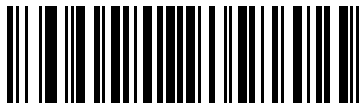

SPP Bluetooth Classic (Non-discoverable)

## SPP BT Classic (Discoverable)

This enables the host to establish an SPP connection with the scanner over Bluetooth Classic radio. The scanner is discoverable (Peripheral mode).

To establish a connection (initial setup only), choose the SPP BT Classic (Discoverable) option. From the host, discover Bluetooth devices and select the scanner from the discovered device list.

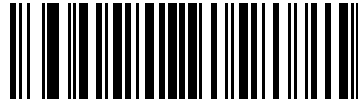

SPP Bluetooth Classic (Discoverable)

## Bluetooth Technology Profile Support

With Bluetooth Technology Profile Support, the scanner communicates directly to the host using Bluetooth technology and does not require the cradle. The scanner supports standard Bluetooth Serial Port Profile (SPP) and HID profiles which enable communication with other Bluetooth devices that support these profiles.

- SPP - The scanner connects to the PC/host via Bluetooth and behaves as if there is a serial connection.
- HID - The scanner connects to the PC/host via Bluetooth and behaves as a keyboard.

## Central/Peripheral Modes

The scanner can be set up as Central or Peripheral mode.

When the scanner is set up as Peripheral mode, it is discoverable and connectible to other devices. When the scanner is set up as Central mode, the Bluetooth address of the remote device to which a connection is requested is required. A pairing option with the remote device address must be created and paired to attempt a connection to the remote device. See [Pairing Barcode Format](#).

### Central Mode

Setting up the scanner as a Central (SPP) requires the Bluetooth address of the remote (Peripheral) device to which the scanner is connecting.

Create and choose a pairing barcode with the remote device address to connect to the remote device. See [Pairing Barcode Format](#).

### Peripheral Mode

If you set up the scanner as Peripheral mode (SPP or HID), it is discoverable and accepts an incoming connection request from a remote device.



**NOTE:** The number of scanners depends on host capability.

## Bluetooth Friendly Name

Parameter # 607 (SSI # F1h 5fh)

You can set a meaningful name for the scanner that appears in the application during device discovery.

By default this is the scanner family name followed by the serial number, e.g., DS3578 123456789ABCDEF. Select `Set Defaults` to revert the scanner to this name; use custom defaults to maintain the user-programmed name through a `Set Defaults` operation.



**NOTE:** If the application allows setting a device name, this takes precedence over the Bluetooth Friendly Name.

To create a Bluetooth Friendly Name, choose `Bluetooth Friendly Name`, and then scan up to 23 characters from [Alphanumeric Barcodes](#). If the name contains less than 23 characters, scan [this option](#) after entering the name.

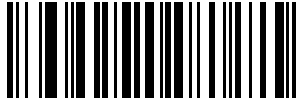

Bluetooth Friendly Name

## Discoverable Mode

### Parameter # 610 (SSI # F1h 62h)

Select a discoverable mode based on the device initiating discovery.

- General Discoverable Mode - The host initiates connection.
- Limited Discoverable Mode - A mobile device initiates connection, and the device does not appear in General Discoverable Mode. Note that it can take longer to discover the device in this mode. The device remains in Limited Discoverable Mode for 30 seconds, and green LEDs flash. After 30 seconds it is non-discoverable. To re-activate Limited Discoverable Mode, press the trigger.



\*General Discoverable Mode (0)

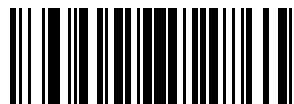

Limited Discoverable Mode (1)

## Wi-Fi Friendly Options

You can set Wi-Fi friendly options.

### Wi-Fi Friendly Mode

#### Parameter # 1299 (SSI # F8h 05h 13h)

Scanners are configurable for Wi-Fi friendly mode.

Choose an option to enable or disable `Wi-Fi Friendly Mode`, and then see [Wi-Fi Channel Exclusion](#) to select any channels to exclude.

When using this feature, configure all scanners in the area for Wi-Fi friendly mode. By default, no Wi-Fi channels are excluded. Since Bluetooth requires a minimum of 20 channels when Wi-Fi channels 1, 6, and 11 are excluded, a smaller number of channels are cut from the hopping sequence. Updating Wi-Fi friendly settings before Bluetooth connection is recommended.



**NOTE:** The scanner remains in sniff mode, and exits sniff mode only during firmware update. If a Wi-Fi channel is excluded from the hopping sequence, AFH turns off. Scanner (and cradle) avoid the selected Wi-Fi channels after establishing connection.

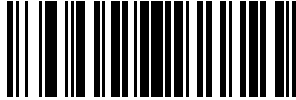

Enable Wi-Fi Friendly Mode (1)



\*Disable Wi-Fi Friendly Mode (0)

## Wi-Fi Friendly Channel Exclusion

### Parameter # 1297 (SSI # F8h 05h 11h)

You can set channels to exclude.

- Exclude Wi-Fi channel 1 - Bluetooth channels 0-21 are excluded from the hopping sequence (2402-2423 MHz).
- Exclude Wi-Fi channel 6 - Bluetooth channels 25-46 are excluded from the hopping sequence (2427 - 2448 MHz).
- Exclude Wi-Fi channel 11 - Bluetooth channels 50-71 are excluded from the hopping sequence (2452 - 2473 MHz).
- Exclude Wi-Fi channel 1, 6 and 11 - Bluetooth channels 2-19 (2404-2421 MHz), 26-45 (2428 - 2447 MHz), and 51-69 (2453 - 2471 MHz) are excluded from the hopping sequence.
- Exclude Wi-Fi channels 1 and 6 - Bluetooth channels 0-21 (2402-2423 MHz) and 25-46 (2427 - 2448 MHz) are excluded from the hopping sequence.
- Exclude Wi-Fi channels 1 and 11 - Bluetooth channels 0-21 (2402-2423 MHz) and 50-71 (2452 - 2473 MHz) are excluded from the hopping sequence.
- Exclude Wi-Fi channel 6 and 11 - Bluetooth channels 25-46 (2427 - 2448 MHz) and 50-71 (2452 - 2473 MHz) are excluded from the hopping sequence.
- Use All Channels (Standard AFH) - Sets all channels to use.



\*Use All Channels (Standard AFH) (0)





Exclude Wi-Fi Channel 1 (1)



Exclude Wi-Fi Channel 6 (2)

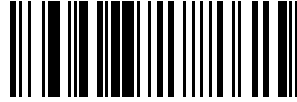

Exclude Wi-Fi Channel 11 (3)

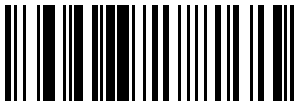

Exclude Wi-Fi Channels 1, 6, and 11 (4)

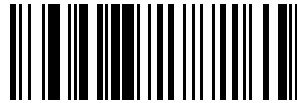

Exclude Wi-Fi Channels 1 and 6 (5)

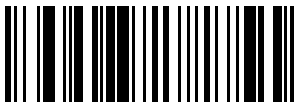

Exclude Wi-Fi Channels 1 and 11 (6)



Exclude Wi-Fi Channels 6 and 11 (7)

## Bluetooth Radio Parameters

You can set Bluetooth timeout settings, radio power, radio state, and wait for connection options.

### Radio Output Power

#### Parameter # 1324

The scanner uses a configurable radio which can be configured to operate in:

- Low power mode as a Class 2 device.
- High power mode as Class 1 device.

Increase the radio output power to increase range. Scan a barcode to select the desired power mode.



\*Class 2 (Low Power)



Class 1 (High Power)

## Link Supervision Timeout

### Parameter # 1698 (SSI # F4h 06h A2h)

Select a time interval to set how quickly the scanner senses that the Bluetooth radio loses connection to the remote device.

A lower value minimizes data loss at the edge of the operating range, while a larger value minimizes disconnects due to the remote device not responding in time. If you are experiencing occasional disconnects and the scanner is able to reconnect, increase the link supervision timeout value.



**NOTE:** The scanner only controls Link Supervision Timeout in Central mode.

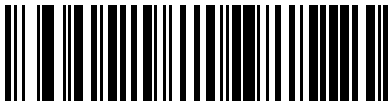

0.5 Seconds (800)

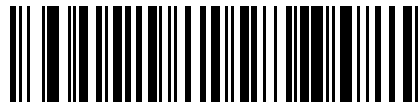

\*2 Seconds (3200)



5 Seconds (8000)



10 Seconds (16000)

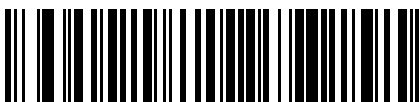

20 Seconds (32000)

## HID Host Parameters

The scanner supports virtual keyboard emulation for the Apple iOS, and keyboard emulation over the Bluetooth HID profile. In this mode the scanner can interact with Bluetooth enabled hosts supporting the HID profile as a Bluetooth keyboard. Scanned data is transmitted to the host as keystrokes.

### Apple iOS Virtual Keyboard Toggle

#### Parameter # 1114 (SSI # F8h 04h 5Ah)

This option enables Apple iOS devices to open and close the iOS virtual keyboard by double-pressing the trigger.



**NOTE:** When this feature is enabled, the scanner may be incompatible with non-Apple iOS devices.



Enable Apple iOS Virtual Keyboard Toggle (1)

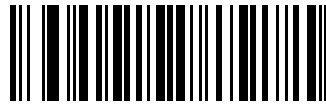

\*Disable Apple iOS Virtual Keyboard Toggle (0)

### Keyboard Keystroke Delay

This parameter sets the delay, in milliseconds, between emulated keystrokes. Select one of the following barcodes to increase the delay when the HID host requires slower data transmission.

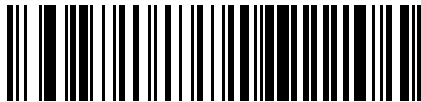

\*No Delay (0 msec)

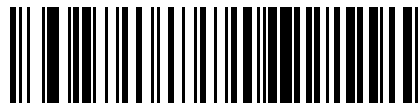

Medium Delay (20 msec)



Long Delay (40 msec)

### Caps Lock Override (Radio)

Select `Override Caps Lock Key` to preserve the case of the data regardless of the state of the Caps Lock key.



**NOTE:** This setting is always enabled for the **Japanese, Windows (ASCII)** keyboard type and cannot be disabled.



Override Caps Lock Key (Enable)

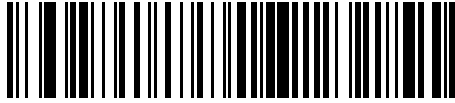

\*Do Not Override Caps Lock Key (Disable)

## Barcodes with Unknown Characters (Radio)

You can send all barcode data except for unknown characters. The scanner issues no error beeps.

This option applies only to the HID Keyboard Emulation device and IBM device. Unknown characters are characters the host does not recognize.

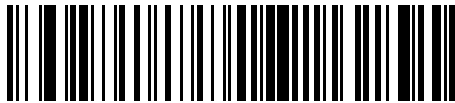

\*Send Barcodes With Unknown Characters

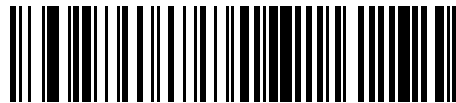

Do Not Send Barcodes With Unknown Characters

## Fast HID Keyboard

**Parameter # 1361 (SSI # F8h 05h 51h)**

You can set this parameter to transmit Bluetooth HID keyboard data at a faster rate.



\*Enable Fast HID Keyboard (1)

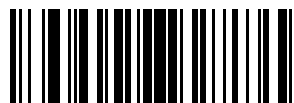

Disable Fast HID Keyboard (0)

## Numeric Keypad Emulation

You can send all characters as ASCII sequences over the numeric keypad.

For example, ASCII A transmits as “ALT make” 0 6 5 “ALT Break”.

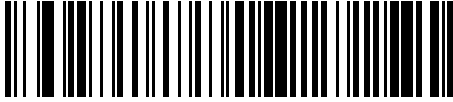

\*Enable Numeric Keypad Emulation



Disable Numeric Keypad Emulation

## Quick Keypad Emulation (Radio)

**Parameter # 1362 (SSI # F8h 05h 52h)**

You can set a quicker method of emulation using the numeric keypad where ASCII sequences are only sent for ASCII characters not found on the keyboard.



**NOTE:** This option applies only to the HID keyboard emulation device when [Keyboard Emulation \(HID\)](#) is enabled.

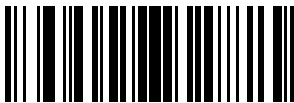

\*Enable Quick Keypad Emulation (1)



Disable Quick Keypad Emulation (0)

## Keyboard FN1 Substitution

You can replace the FN1 character in an EAN-128 barcode with a user-selected Key Category and value. See [FN1 Substitution Values](#) to set the Key Category and Key Value.

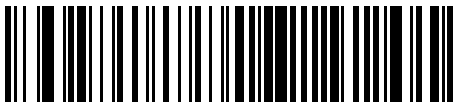

Enable Keyboard FN1 Substitution

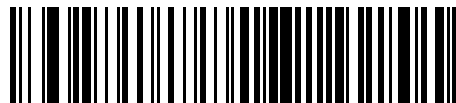

\*Disable Keyboard FN1 Substitution

## Function Key Mapping (Radio)

You can map the keys in bold listed in [ASCII Character Sets](#) in place of the standard key mapping.

ASCII values under 32 are normally sent as control-key sequences. Keys that do not have a bold entry remain the same regardless of this parameter setting.



Enable Function Key Mapping



\*Disable Function Key Mapping

## Simulated Caps Lock (Radio)

You can set **Simulate Caps Lock** to invert upper and lower case characters as if the Caps Lock state is enabled on the keyboard.

- Enable - simulates Caps Lock state on keyboard.
- Disabled - does not simulate Caps Lock state on keyboard.

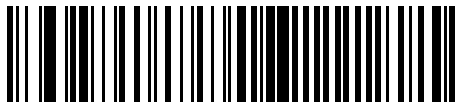

Enable Simulated Caps Lock

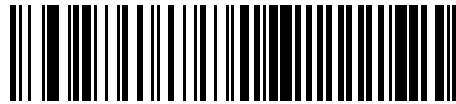

\*Disable Simulated Caps Lock

## Convert Case (Radio)

Select an option to convert all data to the selected case.

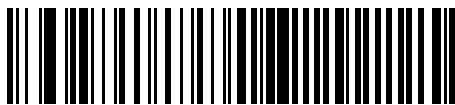

\*No Case Conversion

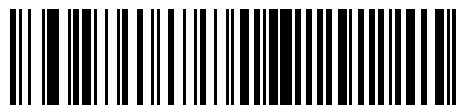

Convert All to Upper Case



Convert All to Lower Case

## Auto-reconnect Parameters

When in SPP Central, Cradle Host mode, or for Bluetooth Keyboard Emulation, the scanner automatically tries to reconnect to a remote device when it disconnects due to losing radio communication.

This occurs if the scanner moves out of range of the remote device, or if the remote device powers down. The scanner tries to reconnect for the period of time specified by the [Reconnect Attempt Interval](#) setting. During that time the green LED blinks.

If auto-reconnect fails due to page timeouts, the scanner lights the red LED, the scanner sounds a page timeout beep (long low/long high), and enters low power mode. To restart the auto-reconnect process, pull the scanner trigger.

If auto-reconnect fails because the remote device rejects the connection attempt, the scanner sounds a connection reject beep sequence (see [Wireless Beeper Definitions](#)) and deletes the remote pairing address. Scan a pairing barcode to attempt a new connection to the remote device.



**NOTE:** If you scan a barcode during the auto-reconnect sequence, a transmission error beep sequence sounds and the data does not transmit to the host. After re-connection, normal scanning operation returns. For error beep sequence definitions, see [Wireless Beeper Definitions](#).

The scanner has memory available for storing a remote Bluetooth address for each Central mode (SPP, Cradle). When switching between modes, the scanner automatically tries to reconnect to the last connected device in that mode.



**NOTE:** Scanning a [Radio Communications Host Type](#) to select another Bluetooth host resets the radio which disables scanning. It takes several seconds for the scanner to re-initialize the radio and enable scanning.

## Beep on Reconnect Attempt

### Parameter # 559 (SSI # F1h F2h)

You can enable audio feedback during a reconnect attempt.

When the scanner disconnects as it moves out of range, it immediately attempts to reconnect. During this time, the green LED blinks. If auto-reconnect fails, the scanner emits a page timeout beep (long low/long high) and the LED stops blinking. Restart the process by pulling the trigger.

- Enabled - the scanner emits 5 short high beeps every 5 seconds during the reconnection attempt, providing an out of range indicator.
- Disabled - the scanner does not emit sound during reconnection attempt.



**NOTE:** To extend the time the scanner attempts to reconnect, see [Reconnect Attempt Interval](#).



Enable Beep on Reconnect Attempt (1)



\*Disable Beep on Reconnect Attempt (0)

## Reconnect Attempt Interval

### Parameter # 558 (SSI # F1h 2Eh)

You can change this time interval after a scanner disconnects as it moves out of range and then tries to reconnect.



\*Attempt to Reconnect for 30 Seconds (6)

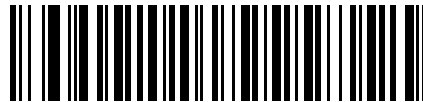

Attempt to Reconnect for 1 Minute (12)



Attempt to Reconnect for 5 Minutes (60)



Attempt to Reconnect for 30 Minutes (360)

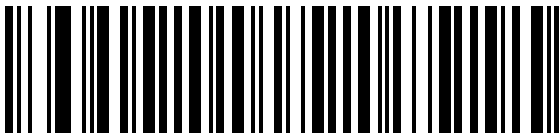

Attempt to Reconnect for 1 Hour (720)



Attempt to Reconnect Indefinitely (0)



Attempt to Reconnect for 2 Hours (1440)



## Auto-reconnect

### Parameter # 604 (SSI # F1h 5Ch)

You can select a reconnect option for the scanner when it disconnects from a remote device:

- Auto-reconnect on Barcode Data - The scanner auto-reconnects when you scan a barcode. A delay can occur when transmitting the first characters. The scanner sounds a decode beep upon barcode scan, followed by a connection, a page timeout, a rejection beep, or a transmission error beep. This option optimizes battery life on the scanner and mobile device. Note that auto-reconnect does not occur on rejection and cable unplug commands.
- Auto-reconnect Immediately - When the scanner loses connection, it attempts to reconnect. If a page timeout occurs, the scanner attempts reconnect on a trigger pull. Select this option if the scanner's battery life is not an issue and you do not want a delay when transmitting the first barcode.



**NOTE:** Auto-reconnect does not occur on rejection and cable unplug commands.

- Disable Auto-reconnect - When the scanner loses connection, you must re-establish it manually.

This feature applies to the following hosts:

- Cradle Bluetooth Classic
- Cradle Bluetooth Low Energy
- HID Bluetooth Classic
- SSI Bluetooth Classic (Non-discoverable)
- SPP Bluetooth Classic (Non-discoverable)

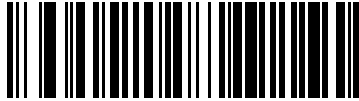

Auto-reconnect on Barcode Data (1)

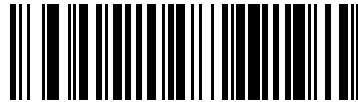

\*Auto-reconnect Immediately (2)

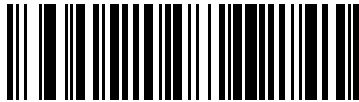

Disable Auto-reconnect (0)

## Sleep Between Attempts

### Parameter # 1778 (SSI # F8h 06h F2h)

You can reduce the potential Wi-Fi interference and extend the scanner battery life by enabling the scanner to go to sleep (low power mode) for the time indicated between reconnect attempts.



**NOTE:** This feature only works when low power mode is enabled on the scanner and when the scanner is not charging in the cradle.



Sleep for 30 Seconds (30)



\*Sleep for 1 minute (60)



Sleep for 2 minutes (120)

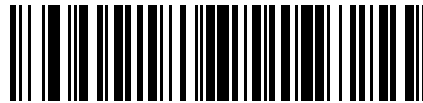

Sleep for 5 minutes (300)

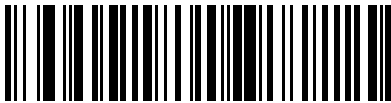

Sleep for 30 minutes (1800)

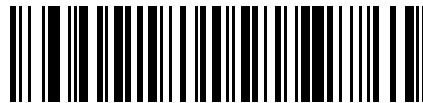

Sleep for 1 hour (3600)

## Number of Retry Attempts

### Parameter # 1779 (SSI # F8h 0h F3h)

You can control how many reconnect and associated sleep attempts to execute. After the number of retries is reached, the scanner no longer attempts to reconnect to the host.



**NOTE:** After the retry period expires, if the trigger is pulled, the scanner restarts the auto-reconnect and sleep sequence.

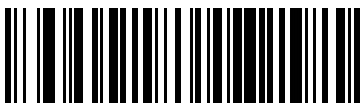

\*Do Not Retry (0)



Retry 5 Times (5)

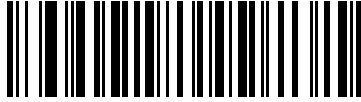

Retry 10 Times (10)



Retry 20 Times (20)

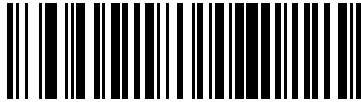

Retry 40 Times (40)

## Scanner(s) to Cradle Support

You can set different options to pair, unpair, and set different cradle preferences for a scanner.

### Modes of Operation

#### Parameter # 538 (SSI # F1h A1h)

The charging cradle with radio supports two radio communication modes of scanner operation for wireless communication.

Select a mode of operation:

- **Point-to-Point** - Only one scanner can connect to the cradle at a time. Pair the scanner to the cradle either by inserting it into the cradle (if [Pair on Contacts](#) is enabled), or by scanning the PAIR barcode on the cradle. Communication can be locked, unlocked (default), or in a lock override state (see [Pairing Modes](#)). In locked mode, you must set a [Connection Maintenance Interval](#) to set the locking interval.
- **Multipoint-to-Point** - Pair up to seven scanners to one cradle. To set this mode, scan the Multipoint-to-Point barcode using the first scanner to connect to the cradle. See [Parameter Broadcast \(Cradle Host Only\)](#) to clone all scanners paired to the cradle after programming the first.



\*Point-to-Point Mode (0)

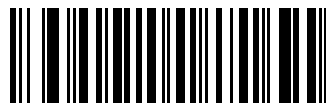

Multipoint-to-Point Mode (1)

### Bluetooth Classic and/or Low Energy (Cradle Host Only)

Parameter # 1355 (SSI # F8h 05h 4Bh)

You can set up the cradle to accept both Bluetooth Classic and Low Energy connections, or Bluetooth Low Energy Only connections.



**NOTE:** You must terminate all Bluetooth Classic connections before selecting Bluetooth Low Energy Only.



\*Bluetooth Classic and Low Energy (0)

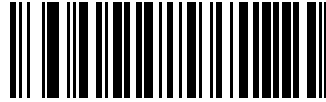

Bluetooth Low Energy Only (1)

## Parameter Broadcast (Cradle Host Only)

### Parameter # 148 (SSI # 94h)

When in Multipoint-to-Point mode, you can enable `Parameter Broadcast` to broadcast all parameter barcodes scanned to all other connected scanners.

If disabled, only the individual scanner processes parameter barcodes and the scanner ignores parameters broadcast from other scanners or from the cradle.

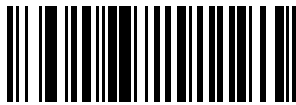

\*Enable Parameter Broadcast (1)

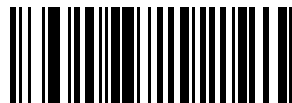

Disable Parameter Broadcast (0)

## Pairing

Pairing is the process by which a scanner initiates communication with a cradle.

Scanning `Multipoint-to-Point` activates multi scanner-to-cradle operation and allows up to seven scanners to pair.

To pair the scanner with the cradle, scan the pairing barcode on the cradle. The scanner emits a high/low/high/low beep sequence to indicate that it decoded the pairing barcode, and then a low/high beep when it establishes a connection with the cradle.



**NOTE:**

Each cradle uses a unique pairing barcode.

Do not scan data or parameters until pairing completes.

When the scanner pairs with the cradle in SPP Central or Cradle Host mode, it attempts to reconnect to a remote device upon a disconnection due to the radio losing communication. For more information see [Auto Reconnect Parameters](#).

## Pairing Modes

### Parameter # 542 (SSI # F1h 1Eh)

The cradle and scanner support two modes of pairing.

- **Unlocked Pairing Mode** - In Point-to-Point mode only, pair (connect) a new scanner to a cradle at any time by either scanning the PAIR barcode on the cradle or by inserting it into the cradle with [Pair on Contacts](#) enabled. This unpairs the previously connected scanner from the cradle.
- **Locked Pairing Mode** - When a cradle is paired (connected) to a scanner (or up to seven scanners in Multipoint-to-Point mode), it rejects any attempt to connect a different scanner. In this mode, you must set a [Pair on Contacts](#).

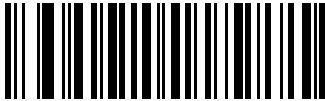

\*Unlocked Pairing Mode (0)



Locked Pairing Mode (1)

## Lock Override

Lock Override overrides a locked scanner base pairing and connects a new scanner. In Multipoint-to-Point mode, this unpairs any disconnected (out of range) scanner first to connect the new scanner.

To use Lock Override, scan Lock Override and then pair the scanner.



Lock Override

## Pair on Contacts

### Parameter # 545 (SSI # F1h 21h)

This parameter pairs the scanner and cradle when you insert the scanner in the cradle. You do not need to scan the pairing barcode on the cradle.

Choose the following:

- Enabled - Scanner pairs on contact and If pairing is successful, the scanner emits a low/high connection beep sequence.
- Disabled - Scanner does not pair on contact.

See [Wireless Beeper Definitions](#) for other beep sequences.

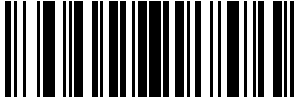

\*Enable Pair On Contacts (1)

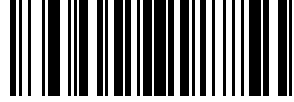

Disable Pair on Contacts (0)

## Pull Trigger Twice to Re-connect

Upon a double trigger press, the scanner attempts to connect to the last known address.

This feature differs from [Auto-reconnect](#) in that the scanner attempts connection only once and keeps the address even on commanded disconnect. The last known address is only cleared upon a reject or with a new successful connection. The address persists over scanner reboot. This feature does not interfere with a double trigger press to open or close an iOS keypad in HID mode.



**NOTE:** This feature only applies to hosts capable of a commanded connection; SPP Peripheral mode and HID BLE hosts do not support this feature.

## Unpairing

Choose Unpair to unpair the scanner, to make the host available for pairing with another scanner.



Unpair

## Toggle Pairing

### Parameter # 1322 (SSI # F8h 05h 2Ah)

The parameter enables a scanner to switch between being paired to a cradle or host (for example, VC80) to being unpaired from the scanner upon toggle.

Choose the following:

- Enabled - Scanner toggles between being paired to being unpaired.
- Disabled - Scanner does not switch pairing on toggle.



Enable Toggle Pairing (1)



\*Disable Toggle Pairing (0)

## Auto Un-Pairing

### Parameter # 1708

The auto un-pair parameter configures the RS6100 to un-pair from the host computer on specific events.

- **Disable (default)** - the RS6100 will not auto un-pair on any events.
- **On cradle insertion** - the RS6100 will un-pair when inserted charging cradle.
- **On reset** - the RS6100 will un-pair if a warm or cold reset occurs.
- **On cradle or reset** - the RS6100 will un-pair on cradle insertion or reset event.



\*Disable



Un-pair on Cradle Insertion



On Reset



On Cradle or Reset

## Pairing Barcode Format

When the scanner is configured as an SPP Central mode, you must create a pairing barcode for the remote Bluetooth device to which the scanner is connecting. You must know the Bluetooth address of the remote device.

To create a pairing barcode, format a Code 128 barcode as follows:

```
<Fnc 3>Bxxxxxxxxxxxxx
```

where:

- B (or LNKB) is the prefix

- xxxxxxxxxxxx represents the 12-character Bluetooth address.

## Pairing Barcode Example

Follow the example to see how a pairing works.

If the Bluetooth address of the remote device is 11:22:33:44:55:66, the pairing barcode is:



B112233445566

Pairing Barcode Content:

'B' or 'LNKB' + Bluetooth Address

## Pairing Barcode Format Using the Scan-To-Connect (STC) Utility

You can use the STC utility to create a pairing barcode in one step by connecting the Zebra Bluetooth scanner to a phone, tablet, or PC by scanning an STC barcode.

The STC utility is available as a standalone utility. Supported operating systems include Windows and Android.

For more information, go to [zebra.com/scantoconnect](http://zebra.com/scantoconnect). Source code is also available for easy app integration.

## Connection Maintenance Interval

### Parameter # 5002

You can set a time period for a scanner to reconnect to a cradle.



**NOTE:** The Connection Maintenance Interval only applies in locked pairing mode (see [Pairing Modes](#)).

When a scanner disconnects from a cradle due to a [Link Supervision Timeout](#), it attempts to reconnect to the cradle for 30 seconds. If auto-reconnect fails, pull the scanner trigger to restart it.

To ensure that a disconnected scanner can reconnect when it moves back in range, the cradle reserves the connection for that scanner for a period of time defined by the Connection Maintenance Interval. To connect another scanner, either wait until this interval expires and then scan the PAIR barcode on the cradle, or scan [Lock Override](#) with the new scanner and then scan the PAIR barcode on the cradle.



**NOTE:** When the cradle is paired to the maximum number of scanners, it stores the remote pairing address of each scanner in memory regardless of the scanner condition (e.g., discharged battery). To change the scanners paired to the cradle, select [Unpairing](#) to unpair each connected scanner, and then scan the PAIR barcode on the cradle with each new scanner.

A shorter Connection Maintenance Interval allows new users to gain access to abandoned connections more quickly, but causes problems for users who leave the work area and return. A longer interval allows existing users to leave the work area for longer periods of time, but ties up the system for new users. To avoid this conflict, users who are going off-shift can scan [Toggle Pairing](#) to make the connection immediately available.



### Setting the Connection Maintenance Interval

To set the Connection Maintenance Interval, choose one of the following options.

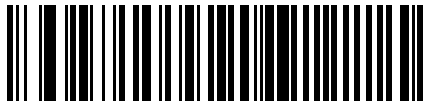

\*15 Minutes (0)



30 Minutes (1)

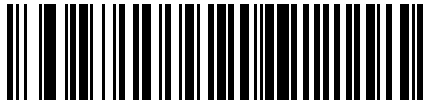

60 Minutes (2)

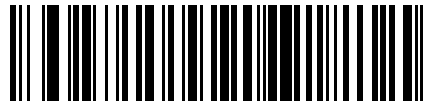

2 Hours (3)

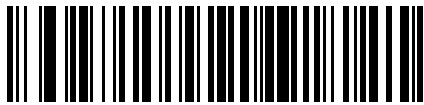

4 Hours (4)



8 Hours (5)

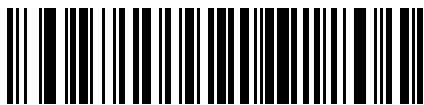

24 Hours (6)



Indefinite (7)

### Bluetooth Security

The scanner supports Bluetooth authentication. Either the remote device or the scanner can request authentication.

## PIN Code

### Parameter # 552 (SSI # F1h 28h)

You can use a PIN code with a scanner.

If the scanner communicates with a host with enabled authentication/encryption, the PIN codes on the scanner and host must match, otherwise pairing fails. To do this, connect the scanner to the host when setting the PIN code, otherwise the new PIN code only takes effect on the scanner. The default PIN code is 12345.



**NOTE:** An extended 16 character PIN code is available for additional security with Open Bluetooth (SPP and HID).

### Setting the PIN Code

Set the PIN code (e.g., password) on the scanner to connect to the host.

1. Scan the Set & Store PIN Code barcode.

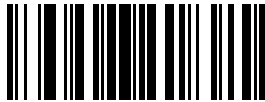

Set & Store PIN Code

2. Scan five barcodes from [Alphanumeric Barcodes](#).
3. Scan [Alphanumeric Barcodes 1](#).

## Variable PIN Code

### Parameter # 608 (SSI # F1h 60h)

In Cradle Host mode with authentication enabled, select the default **Static PIN Code** to use the PIN stored in memory rather than requiring manual entry.



**NOTE:** Only devices using Bluetooth 2.0 or earlier support Variable PIN Code. Do not use this to connect to cradles or devices using Bluetooth 2.1 or later.

The default PIN code is the **Set & Store PIN Code** set previously.

Typically, however, HID devices require entering a variable PIN code with each connection.

### Entering the Variable PIN Code

When attempting connection, if the device application presents a PIN:

1. Scan Variable PIN Code.
2. Re-attempt connection. The scanner emits a beep indicating it is waiting for an alphanumeric entry.
3. Enter the application-provided PIN using the [Alphanumeric Barcodes 1](#).

- 4. Scan [Alphanumeric Barcodes 1](#) if the code is less than 16 characters.



\*Static PIN Code (0)



Variable PIN Code (1)

The scanner discards the variable PIN code after connection.

## Bluetooth Security Level

### Parameter # 1393 (SSI # F8h 05h 71h)

This parameter sets a Bluetooth security level.

Choose one of the following options:

- \*Low - This is designed for ease of connection with most devices. Some devices may not accept this setting. If connection fails, increase this security setting and try again. If connecting to a Bluetooth 2.1 or later device, this setting uses the “just works” method for secure and simple pairing.



**NOTE:** Data is encrypted using the Low security setting if connected to Bluetooth 2.1 or later device.

- Medium - This may require entering a PIN code on initial connection to pair the scanner and device. If connecting to a Bluetooth 2.1 or later device, this setting uses the “passkey entry” method for secure and simple pairing.
- High - This enables “man in the middle” protection for Bluetooth 2.1 and later. Not all devices support this mode.
- Legacy (Bluetooth 2.0 and earlier) - This enables authentication and encryption for legacy pairing.

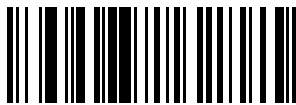

\*Low (0)



Medium (1)

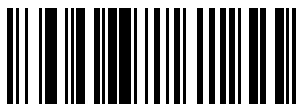

High (2)



Legacy (3)

## FIPS Mode

### Parameter # 736 (SSI # F1h E0h)

The Federal Information Processing Standard (FIPS) 140-2 is a U.S. government computer security standard used to accredit cryptographic modules. FIPS enabled scanners and cradles offer this secure mode of operation.

Choose the following:

- Enabled - Establishes a secure session between the scanner and cradle when connected.
- Disabled - FIPS standards are not used.

When enabled, the scanner lights a yellow LED on each trigger pull to indicate that all data is transmitted securely over Bluetooth. On failure, the scanner sounds a transmission error message on each attempt to transmit data.

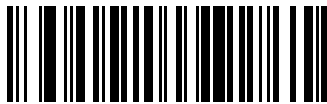

Enable FIPS (1)



\*Disable FIPS (0)

## General Radio Parameters

You can set Batch Mode, Batch Storage, and Beep alert options.

### Batch Mode

#### Parameter # 544 (SSI # F1h 20h)

This parameter enables the scanner to attempt to store barcode data (excluding parameter barcodes) until transmission is initialized, or it stores the maximum number of barcodes.

When the scanner saves a barcode successfully, it emits a good decode beep and flashes the green LED. If the scanner is unable to store a new barcode, it emits a low/high/low/high (out of memory) beep. See [Wireless Beeper Definitions](#) for all definitions.

In all modes, calculate the amount of data (number of barcodes) the scanner can store as follows:



**NOTE:** If you change the batch mode while there is batched data, the new batch mode takes effect only after the scanner sends all previously batched data.

- Normal (default) - Do not batch data. The scanner transmits each barcode when scanned.

- Out of Range Batch Mode - The scanner stores barcode data when it loses connection to a remote device (e.g., when the scanner moves out of range). When the scanner re-establishes connection with the device (e.g., it moves back into range) it transmits the data.
- Standard Batch Mode - The scanner stores barcode data when you scan Enter Batch Mode. Scan Send Batch Data to transmit the data.



**NOTE:** Transmission stops if the scanner loses connection to the remote device.

- Cradle Contact Batch Mode - The scanner stores barcode data when you scan Enter Batch Mode. Insert the scanner into the cradle to transmit the data.



**NOTE:** If you remove the scanner from the cradle during batch data transfer, transmission stops until you re-insert the scanner in the cradle.

- Batch Only Mode - The scanner radio is off and the scanner stores all barcode data. Insert the scanner into the cradle to transmit the data..



**NOTE:** Removing the scanner from the cradle during batch data transfer stops transmission until you re-insert it in the cradle.



**NOTE:** The radio may be turned off during batch data transmission.



**NOTE:** To exit this mode, scan the **Normal (Do Not Batch Data)** barcode.

- Parameter Batch Mode - Use this mode if the cradle and/or scanner is configured with the radio turned off or connected to a non-cradle device. Scan **Enter Parameter Batch Mode** to enter this mode. The scanner stores parameter barcode data intended for the cradle. Insert the scanner into the cradle to transmit the batched parameter data. When data transmission completes, the scanner exits this mode. Alternatively, scan **Exit Parameter Batch Mode** to cancel batching before inserting the scanner in the cradle.

In all modes, transmission stops if the scanner moves out of range, and resumes when the scanner moves back in range. If you scan a barcode during batch data transmission, it is appended to the end of the batched data. Parameter barcodes are not stored.

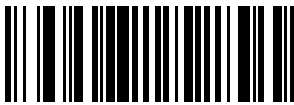

\*Normal (Do Not Batch Data) (0)

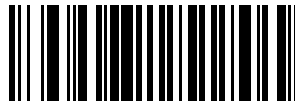

Out of Range Batch Mode (1)

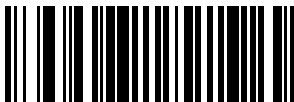

Standard Batch Mode (2)

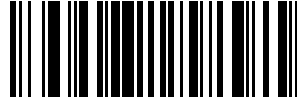

Cradle Contact Batch Mode (3)

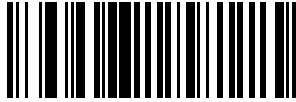

Batch Only Mode (4)

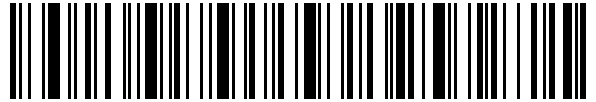

Enter Batch Mode



Send Batch Data



Enter Parameter Batch Mode

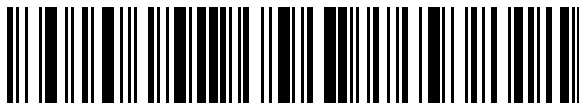

Exit Parameter Batch Mode

## Persistent Batch Storage

### Parameter # 5 (SSI # F1h 21h)

This parameter stores batch data in non-volatile memory and preserves it when the scanner powers down.

Choose the following:

- Enabled - Batch data is stored in memory.
- Disabled - Batch data is not stored in memory.



**NOTE:** Frequently storing batch data with this setting enabled shortens non-volatile memory life.



Enable Persistent Batch Storage (1)



\*Disable Persistent Batch Storage (0)

## Beep on Insertion

### Parameter # 288 (SSI # F0h 20h)

The parameter enables the scanner to emit a short low beep when it is inserted into a cradle and detects power.

Choose the following:

- Enabled - Scanner beeps when inserted in cradle.
- Disabled - Scanner does not beep when inserted in cradle.

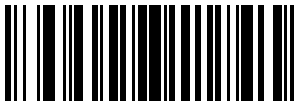

\*Enable Beep on Insertion (1)



Disable Beep on Insertion (0)

## Bluetooth SPP Beep on <BEL>

### Parameter # 150 (SSI # 96h)

This parameter enables the scanner to beep when it detects a <BEL> character on the serial line. <BEL> is issued to alert the user of an illegal entry or other important event.

Choose the following:

- Enabled - Scanner beeps when it detects a <BEL>.
- Disabled - Scanner does not beep when it detects a <BEL>.



**NOTE:** This parameter only applies to SPP (Serial Port Profile), for example, the serial interface on the cradle. In Multipoint-to-Point mode only, the scanner that beeped last sounds Beep on <Bel>.



\*Enable Beep on <BEL> (1)



Disable Beep on <BEL> (0)

## Bluetooth Radio, Linking, and Batch Operation

The scanner has a Bluetooth Class 1 radio which achieves a range of at least 135 m / 440 ft (open air, line of sight). The actual range achieved is influenced by the presence of other radios, shelving, and wall materials, and which cradle is tested. The environments vary widely and often influence radio ranges.

When the scanner moves out of communications range to the base, you can configure it for [Batch Mode](#). The scanner has sufficient on-board memory to store more than 500 barcodes of typical size (UPC/EAN). See [Batch Mode](#) to calculate the amount of data (number of barcodes) the scanner can store.

### Linking the Scanner to an iOS or Android Device

To establish a link between the scanner and the device, scan [HID Keyboard Emulation](#). Then perform one of the following:

- iOS/iPad/iPhone - Select **Settings** > **General** > **Bluetooth** and turn Bluetooth **On**. Choose the scanner from the list of discovered devices to establish a link allowing scanning into any application with keyboard entry.
- Android - If Bluetooth is off, select **Settings** > **Wireless & networks** > **Bluetooth** to turn it on. Select **Bluetooth Settings** and choose the scanner from the list of discovered devices. The scanner usually displays as DSYYYY - xxxxxx, where xxxxxx is the serial number.



**IMPORTANT:** Android devices that require scanning a PIN for connection display a PIN. To enter the PIN, scan [Variable Pin Code](#), and then attempt connection. When the scanner beeps to indicate it is waiting for PIN entry, scan the PIN using [Numeric Barcodes](#). To delete incorrect scanned entries, scan [Cancel](#). For more information, see [Variable Pin Code](#).

## BLE Beacons

### Beacon Upon Disconnection

#### Parameter # 2403 (SSI # F8h 09h 63h)

This parameter controls beacons when the scanner is disconnected from the host device.



**NOTE:** A scanner will still be paired to its host device when it disconnects from the host. Go to [Bluetooth Communications](#) for more information.

- **Enable:** The scanner begins beacons when it disconnects from the host device.
- **Disable:** The scanner does not beacon when it disconnects from the host device.

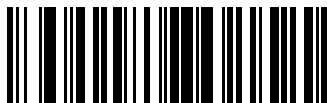

Enable (1)

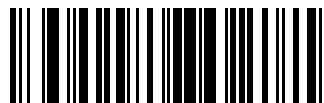

\*Disable (0)



## Unpaired Beacons

### Parameter # 2404 (SSI # F8h 09h 64h )

This parameter controls beaconing when the scanner is not paired to a host device.

- **Enable:** The scanner beacons if it is not paired to a host device. Any LE Bluetooth device will be able to detect the beacon signal.
- **Disable:** The scanner does not beacon when it is not paired to a host device.



Enable beaconing when there is no remote host address (1)



\*Disable beaconing when there is no remote host address (0)

## Beaconing Beep

### Parameter # 2405 (SSI # F8h 09h 65h )

This parameter controls beeping during beaconing.

If beaconing activates because of a low battery level, beeping is disabled to preserve battery power.

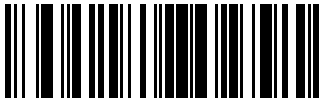

Enable beeping (1)



\*Disable beeping (0)

## Beacon Frequency

### Parameter # 2406 (SSI # F8h 09h 66h)

This parameter defines how often the beacon signal is sent.

Scan the appropriate code to define how often the scanner emits a beacon signal. The shorter interval provides more up-to-date information for tracking applications but has a more significant impact on battery life.



\*100 msec



200 msec



300 msec

## Beacon Battery Threshold

**Parameter # 2407 (SSI # F8h 09h 67h)** This parameter defines the level the battery reaches when beaconing activates.

Scan one of the following codes to set the corresponding battery level. The recommended range is 0-40%.

When the scanner's battery reaches the defined level, and beaconing activates, the scanner enters a power-saving mode. In the power-saving mode:

- pressing the trigger does not result in a scan
- sending data to and from the host device fails

To end the power-saving mode:

- place the scanner in a charger
- replace the battery with one that is more fully charged



**NOTE:** If the scanner battery reaches 0%, there is no way to send a beacon signal to recover the scanner.

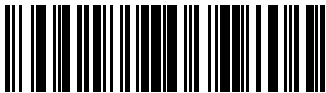

10%

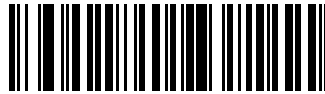

20%



\*30%



35%



37%



40%

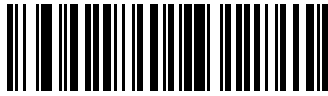

(Disable)

## Beacon ID

Parameters 2408 and 2409 comprise the Beacon ID in the Alt-Beacon packet.

ID1 is automatically generated and defined by Attribute 20036.

### ID2

**Parameter # 2408 (SSI # F8g 09h 68h )** This parameter sets the ID2 portion of the beacon ID.



0xE1E1 (1)



\*0xEBEB (0)

### ID3

**Parameter # 2409 (SSI # F8h 09h 69h)** This parameter sets the ID3 portion of the beacon ID.



0xE2E2 (1)

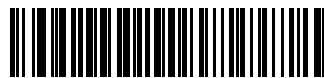

\*0xECDD (0)

# User Preferences and Miscellaneous Options

You can program the scanner to perform various functions, or activate different features. This chapter describes user preference features and provides programming barcodes for selecting these features.

The scanner ships with the settings shown in User Preferences Parameter Defaults. If the default values suit requirements, programming is not necessary.

## Setting User Preference Parameters

To set feature values, scan a single barcode or a short barcode sequence. The settings are stored in non-volatile memory and are preserved even when the scanner powers down.



**NOTE:** Most computer monitors allow scanning barcodes directly on the screen. When scanning from the screen, be sure to set the document magnification to a level where you can see the barcode clearly, and bars and/or spaces do not merge.

If not using the default host, select the host type (see each host chapter for specific host information) after the power-up beeps sound. This is only necessary upon the first power-up when connected to a new host.

To return all features to default values, see [Default Parameters](#). Throughout the programming barcode menus, asterisks indicate (\*) default values.

## User Preference Scanning Sequence Examples

In most cases, scanning one barcode sets the parameter value.

Other parameters require scanning several barcodes. Relevant parameters contain descriptions for this procedure.

## User Preference Errors While Scanning

Unless otherwise specified, to correct an error during a scanning sequence, just re-scan the correct parameter.

## User Preferences/Miscellaneous Options Parameter Defaults

The following table lists defaults for user preferences parameters. Change these values in one of two ways:

- Scan the appropriate barcodes in this chapter. The new value replaces the standard default value in memory. To recall default parameter values, see [Default Parameters](#) on page 126.

## User Preferences and Miscellaneous Options

- Configure the scanner using the 123Scan configuration program. See [123Scan and Software Tools](#) on page 76.



**NOTE:** Standard parameter defaults are available in each chapter of this guide.

**Table 11** User Preferences Parameter Defaults

Parameter	Parameter Number <sup>a</sup>	SSI Number <sup>b</sup>	Default
User Preferences			
Set Default Parameter			N/A
Parameter Barcode Scanning	236	ECh	Enable
Beep After Good Decode	56	38h	Enable
Beeper Volume	140	8Ch	High
Beeper Tone	145	91h	High
Beeper Duration	628	F1h 74h	Short
Suppress Power up Beeps	721	F1h D1h	Do Not Suppress
Trigger Mode	138	8Ah	Level
Hand-held Decode Aiming Pattern	306	F0h 32h	Enable
Picklist Mode	402	F0h 92h	Disable Picklist Mode Always
Continuous Barcode Read	649	F1h 89h	Disable
Unique Barcode Reporting	723	F1h D3h	Enable
Decode Session Timeout	136	88h	9.9 Seconds
Timeout Between Decodes, Same Symbol	137	89h	0.5 Seconds
Enhanced Same Symbol Timeout Mode	1844	F8h 07h 34h	Disable Enhanced Same Symbol Timeout Mode
Same Symbol Report Timeout	1284	F8h 05h 04h	Disable
Swipe Frame Timeout	1226	F8 04h CAh	N/A
Presentation Frame Timeout	1227	F8h 04h CBh	N/A
Fuzzy 1D Processing	514	F1h 02h	Enable Fuzzy 1D Processing
Timeout Between Decodes, Different Symbols	144	90h	0.1 Seconds
Mobile Phone/Display Mode	716	F1h CCh	Normal
PDF Prioritization	719	F4h F1h CFh	Disable
PDF Prioritization Timeout	720	F1h D0h	200 ms
Decoding Illumination	298	F0h 2Ah	Enable
Motion Tolerance	858	F2h 5Ah	Less
Miscellaneous Options			

**Table 11** User Preferences Parameter Defaults (Continued)

Parameter	Parameter Number <sup>a</sup>	SSI Number <sup>b</sup>	Default
Enter Key	N/A	N/A	N/A
Tab Key	N/A	N/A	N/A
Transmit Code ID Character	45	2Dh	None
Prefix Value	99, 105	63h, 69h	7013 <CR><LF>
Suffix 1 Value	98, 104	62h, 68h	7013 <CR><LF>
Suffix 2 Value	100, 106	64h, 6Ah	7013 <CR><LF>
Scan Data Transmission Format	235	EBh	Data As Is
FN1 Substitution Values	103, 109	67h, 6Dh	7013 <CR><LF>
Transmit No Read Message	94	5E	Disable
Low Power Mode	128	80h	Enable

<sup>a</sup> Parameter number decimal values are used for programming via RSM commands.

<sup>b</sup> SSI number hex values are used for programming via SSI commands.

## User Preferences

Set feature values by scanning the desired parameter values.

### Default Parameters

Scan one of the following barcodes to reset the scanner to its default settings.

- Restore Defaults resets all default parameters as follows:
  - If you configured custom default parameter values via the Write to Custom Defaults barcode, scanning the Restore Defaults barcode restores these custom values.
  - If you did not configure custom default parameter values, scanning the Restore Defaults barcode restores the factory default values. Default values are available at the beginning of each chapter.
- Set Factory Defaults clears all custom default values and sets the factory default values. Default values are available at the beginning of each chapter.

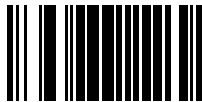

Restore Defaults

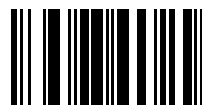

Set Factory Defaults

## Write to Custom Defaults

To create a set of custom defaults, select the desired parameter values in this guide and then scan Write to Custom Defaults.



Write to Custom Defaults

## Parameter Barcode Scanning

### Parameter # 236 (SSI # ECh)

This parameter selects whether to enable or disable the decoding of parameter barcodes, including the Set Defaults barcodes.

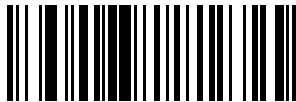

\*Enable Parameter Barcode Scanning (1)

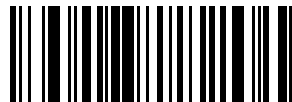

Disable Parameter Barcode Scanning (0)

## Beep After Good Decode

### Parameter # 56 (SSI # 38h)

This parameter selects whether or not the scanner beeps after a good decode. If you select Disable Beep After Good Decode, the beeper still operates during parameter menu scanning and to indicate error conditions.



\*Enable Beep After Good Decode (1)

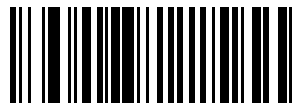

Disable Beep After Good Decode (0)

## Beeper Volume

### Parameter # 140 (SSI # 8Ch)

This parameter selects a beeper volume.

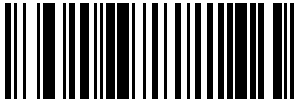

Low Volume (2)



Medium Volume (1)

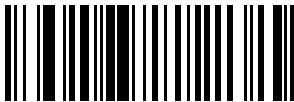

\*High Volume (0)

## Beeper Tone

### Parameter # 145 (SSI # 91h)

This parameter selects a beeper tone for a good decode beep.



Disable Tone (3)



Low Tone (2)



\*Medium Tone (1)



High Tone (0)



Medium to High Tone (2-tone) (4)



## Beeper Duration

### Parameter # 628 (SSI # F1h 74h)

This parameter selects the duration for the good decode beep.



Short Duration (0)



\*Medium Duration (1)

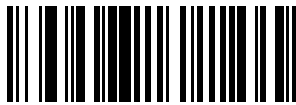

Long Duration (2)

## Suppress Power Up Beeps

### Parameter # 721 (SSI # F1h D1h)

This parameter selects whether or not to suppress the scanner's power-up beeps.

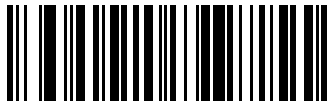

\*Do Not Suppress Power Up Beeps (0)

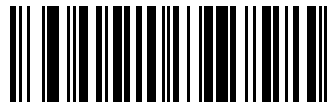

Suppress Power Up Beeps (1)

## Trigger Mode

### Parameter # 138 (SSI # 8Ah)

This parameter allows you to change your scanner's behavior to initiate a decode.

Choose one of the following to select a trigger mode for the scanner:

- Standard (Level) - A trigger press activates decode processing. Decode processing continues until the barcode decodes, you release the trigger or the [Decode Session Timeout](#) occurs. If the trigger is released before the timeout expires, the decode session terminates and no decode occurs.
- Two Stage Option 1 - Upon trigger pull, the aiming pattern appears. When the trigger is released, the scanner activates decode processing, using the currently configured decode session timeout. If the trigger is pulled again while in a decode session, the session is terminated and the aimer appears.

- Two Stage Option 2 -Upon trigger pull, the aiming pattern appears. When the trigger is released, the aiming pattern turns off. Pulling the trigger twice quickly activates decode processing, until the trigger is released.



\*Standard (Level) (0)

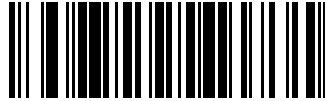

Two Stage Option 1 (14)

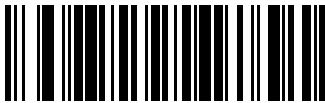

Two Stage Option 2 (15)

## Hand-held Decode Aiming Pattern

### Parameter # 306 (SSI # F0h 32h)

This parameter selects when to project the aiming pattern in hand-held mode:

- Enable Hand-held Decode Aiming Pattern - This projects the aiming pattern during barcode capture.
- Disable Hand-held Decode Aiming Pattern - This turns the aiming pattern off.
- Enable Hand-held Decode Aiming Pattern on PDF - This projects the aiming pattern when the scanner detects a PDF barcode.



**NOTE:** With [Picklist Mode](#) enabled, the decode aiming pattern flashes even if you disable the Hand-held Decode Aiming Pattern.



\*Enable Hand-held Decode Aiming Pattern (2)

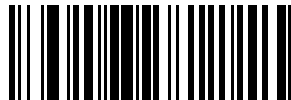

Disable Hand-held Decode Aiming Pattern (0)



Enable Hand-held Decode Aiming Pattern on PDF (3)

## Picklist Mode

### Parameter # 402 (SSI # F0h 92h)

This parameter selects a Picklist Mode. In this mode, you can pick out and decode a barcode from a group of barcodes that are printed close together by placing the aiming pattern on the barcode you want to decode.



**NOTE:** Enabling Picklist Mode overrides the Disable Decode Aiming Pattern options. You can not disable the decode aiming pattern when Picklist Mode is enabled. Enabling Picklist Mode can slow decode speed and hinder the ability to decode longer barcodes.

- Enable Picklist Mode Always - Picklist Mode is always enabled.
- Enable Picklist Mode in Hand-held Mode - Picklist Mode is enabled when the scanner is out of hands-free mode and disabled when the scanner is in presentation mode.
- Enable Picklist Mode in Hands-free Mode - Picklist Mode is enabled when the scanner is in hands-free mode only.
- Disable Picklist Mode Always - Picklist Mode is always disabled.

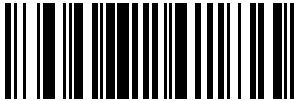

Enable Picklist Mode Always (2)

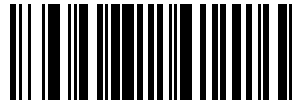

Enable Picklist Mode in Hand-held Mode (1)

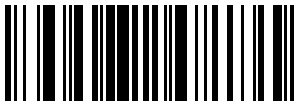

Enable Picklist Mode in Hands-free Mode (3)

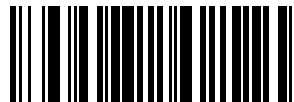

\*Disable Picklist Mode Always (0)

## Continuous Barcode Read

### Parameter # 649 (SSI # F1h 89h)

Enable this parameter to report every barcode while the trigger is pressed.



Enable Continuous Barcode Read (1)

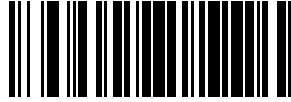

\*Disable Continuous Barcode Read (0)

## Unique Barcode Reporting

### Parameter # 723 (SSI # F1h D3h)

Enable this parameter to report only unique barcodes while the trigger is pressed. This option only applies when Continuous Barcode Read is enabled.



\*Enable Unique Barcode Reporting (1)



Disable Unique Barcode Reporting (0)

## Decode Session Timeout

### Parameter # 136 (SSI # 88h)

This parameter sets the maximum time decode processing continues during a scan attempt. It is programmable in 0.1 second increments from 0.5 to 9.9 seconds. The default timeout is 4.0 seconds.



**NOTE:** The default timeout is 0.75 seconds in temperatures below -20°C (-4°F) with the extended battery installed.

To set a Decode Session Timeout, scan the following barcode, and then scan two barcodes from [Numeric Barcodes](#) that correspond to the desired on time. Enter a leading zero for single digit numbers. For example, to set a Decode Session Timeout of 0.5 seconds, scan this barcode, and then scan the 0 and 5 barcodes. To correct an error or change the selection, scan [Cancel](#).

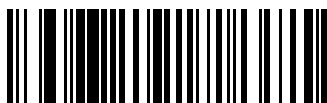

Decode Session Timeout

## Timeout Between Decodes, Same Symbol

### Parameter # 137 (SSI # 89h)

Use this option in presentation mode or Continuous Barcode Read mode to prevent the scanner from continuously decoding the same barcode when it is left in the scanner's field of view. The barcode must be out of the field of view for the timeout period before the scanner reads the same consecutive symbol.

Timeout Between Decodes, Same Symbol is programmable in 0.1 second increments from 0.0 to 9.9 seconds. The default interval is 0.5 seconds.

To select the timeout between decodes for the same symbol, scan the following barcode, and then scan two barcodes from [Numeric Barcodes](#) that correspond to the desired interval, in 0.1 second increments.



Timeout Between Decodes, Same Symbol

### Enhanced Same Symbol Timeout Mode

#### Parameter # 1844 (SSI # F8h 07h 34h)

When two barcodes with the same content but different symbologies are presented at the same time, this parameter determines whether one or both barcodes decode.

- \*Disable Enhanced Same Symbol Timeout Mode - both barcodes decode.
- Enable Enhanced Same Symbol Timeout Mode - only one barcode decodes. Barcodes with the same content but different symbologies are common on some mobile phone applications such as WECHAT.

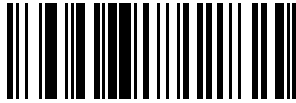

\*Disable Enhanced Same Symbol Timeout Mode (0)

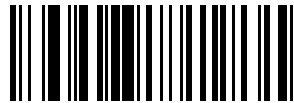

Enable Enhanced Same Symbol Timeout Mode (1)

### Same Symbol Report Timeout

#### Parameter # 1284 (SSI # F8h 05h 04h)

This parameter affects how the Timeout Between Decodes, Same Symbol parameter is applied.

- \*Disable - a barcode in the decode region decodes only once, even if the barcode remains indefinitely in the region.

The user must remove the barcode, and reintroduce the barcode into the region before it decodes a second time.

- Enable - a barcode in the decode region decodes each time the same symbol timeout expires.

Use Enable mode when using fast two-handed scanning of two of the same items. This usage scenario has a tendency to not decode the second of the two items. By enabling this mode the second item unconditionally decodes after the same symbol timeout expires. After enabling this setting the user may need to adjust the [Timeout Between Decodes, Same Symbol](#) so that the second item does not decode too quickly.

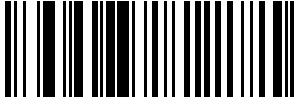

\*Disable (0)

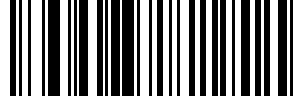

Enable (1)

## Swipe Frame Timeout

### Parameter # 1226 (SSI # F8 04h CAh)

This parameter specifies how much time to spend on processing the frame that is optimized to decode images where the barcode is swiped in front of the scanner.

The range is 11-500 milliseconds. The default is 30 milliseconds.

Scan the barcode below, then scan three digits from [Numeric Bar Codes](#). If a two-digit timeout is desired, scan the zero barcode before scanning the two digits.

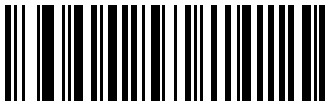

Swipe Frame Timeout (milliseconds)

## Presentation Frame Timeout

### Parameter # 1227 (SSI # F8h 04h CBh)

This parameter specifies how much time to spend on processing the frame that is optimized to decode images where the barcode is presented to the scanner.

The range is 11-500 milliseconds. The default is 35 milliseconds.

Scan the barcode below, then scan three digits from [Numeric Bar Codes](#). If a two-digit timeout is desired, scan the zero barcode before scanning the two digits.

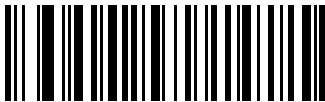

Presentation Frame Timeout (milliseconds)

## Fuzzy 1D Processing

### Parameter # 514 (SSI # F1h 02h)

This parameter is enabled by default to optimize decode performance on 1D barcodes, including damaged and poor quality symbols. Disable this only if you experience time delays when decoding 2D barcodes, or in detecting a no decode.



\*Enable Fuzzy 1D Processing (1)



Disable Fuzzy 1D Processing (0)

### Timeout Between Decodes, Different Symbols

#### Parameter # 144 (SSI # 90h)

Use this option in presentation mode or Continuous Barcode Read to control the time the scanner waits before decoding a different symbol.

Timeout Between Decodes, Different Symbols is programmable in 0.1 second increments from 0.1 to 9.9 seconds. The default is 0.1 seconds.

To select the timeout between decodes for different symbols, scan the following barcode, and then scan two barcodes from [Numeric Barcodes](#) that correspond to the desired interval, in 0.1 second increments.

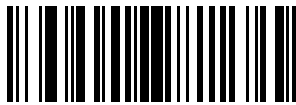

Timeout Between Decodes, Different Symbols

### Mobile Phone/Display Mode

This mode improves barcode reading performance off mobile phones and electronic displays. Scan one of the following barcodes to enable or disable this mode.

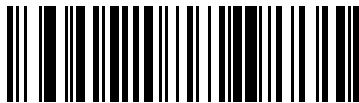

Enable Mobile Phone/Display Mode (3)

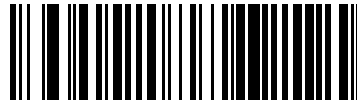

\*Disable Mobile Phone/Display Mode (0)

### PDF Prioritization

#### Parameter # 719 (SSI # F4h F1h CFh)

Enable this parameter to delay decoding certain 1D barcodes by the value specified in PDF Prioritization Timeout.

During the [PDF Prioritization Timeout](#) time, the scanner attempts to decode a PDF417 symbol (for example, on a US driver's license), and if successful, reports this only. If it does not decode (cannot find) a PDF417 symbol, it reports the 1D symbol after the timeout. The 1D symbol must be in the device's field of view for the scanner to report it. This parameter does not affect decoding other symbologies.

The 1D Code 128 barcode lengths include the following:

- 7 to 10 characters
- 14 to 22 characters
- 27 to 28 characters

In addition, a Code 39 barcode with the following lengths are considered to potentially be part of a US driver's license:

- 8 characters
- 12 characters



Enable PDF Prioritization (1)

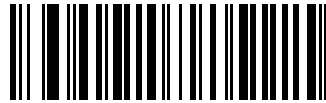

\*Disable PDF Prioritization (0)

## PDF Prioritization Timeout

### Parameter # 720 (SSI # F1h D0h)

If you enabled PDF Prioritization, set this timeout to indicate how long the scanner attempts to decode a PDF417 symbol before reporting the 1D barcode in the field of view.

The PDF Prioritization Timeout range is 0 to 5000 ms, and the default is 200 ms.

Scan the following barcode, and then scan four barcodes from [Numeric Barcodes](#) that specify the timeout in milliseconds. For example, to enter 400 ms, scan the following barcode, and then scan 0400.

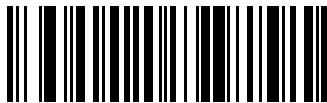

PDF Prioritization Timeout

## Decoding Illumination

### Parameter # 298 (SSI # F0h 2Ah)



This parameter determines whether the scanner turns on illumination to aid decoding. Enabling illumination usually results in superior images and better decode performance. The effectiveness of the illumination decreases as the distance to the target increases.

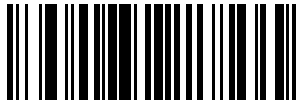

\*Enable Decoding Illumination (1)



Disable Decoding Illumination (0)

### Motion Tolerance

#### Parameter # 858 (SSI # F2h 5Ah)

This parameter selects a motion tolerance option.



**NOTE:** Hand-held Trigger modes only.

- \*Less Motion Tolerance - This provides optimal decoding performance on 1D barcodes.
- More Motion Tolerance - This increases motion tolerance and speeds decoding when scanning a series of 1D barcodes in rapid progression.

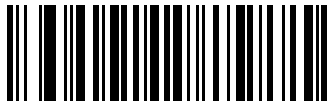

\*Less Motion Tolerance (0)

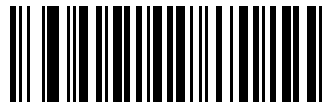

More Motion Tolerance (1)

### Battery Threshold

The following options specify various battery thresholds.

- Battery Status High Threshold - Parameter #1367 When the battery status is above the High Threshold, the battery indicator is green. The default is 50%.
- Battery Status Medium Threshold - Parameter #1368 When the battery status is above the Medium Threshold (and below the High Threshold), the battery indicator is amber. When the battery status is below the Medium Threshold, the battery indicator is red. The default is 20%.
- Battery Status Low Warning Threshold - Parameter #1369 The Low Warning Threshold indicates that the Battery Status is critically low. When the battery status is below this threshold, on every trigger release the scanner issues four short beeps. The default is 10%.

- Battery Health Low Warning Threshold - Parameter #1370 When the battery health is below the Low Health Threshold, all battery indications alternate between red and the appropriate battery status indication. The default is 60%.



**NOTE:** When Battery Health is low, consider replacing the battery.

To set each threshold, scan one of the following barcodes, and then scan two barcodes from [Numeric Barcodes](#) that correspond to the desired percentage from 00 to 99.

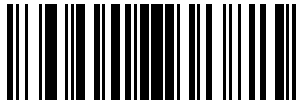

Battery Status High Threshold

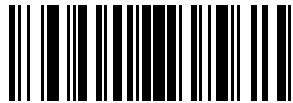

Battery Status Medium Threshold

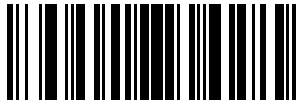

Battery Status Low Warning Threshold

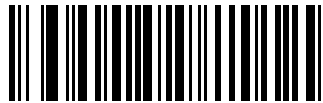

Battery Health Low Warning Threshold

## Miscellaneous Scanner Parameters

This section provides additional barcodes and parameters for miscellaneous options.

### Enter Key

This parameter adds an Enter key (carriage return or line feed) after scanned data.

To program other prefixes and/or suffixes, see [Prefix/Suffix Values](#).

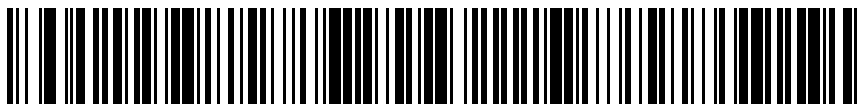

Add Enter Key (Carriage Return/Line Feed)

## Tab Key

This parameter adds a Tab key after scanned data.



Tab Key

## Transmit Code ID Character

### Parameter # 45 (SSI # 2Dh)

A Code ID character identifies the code type of a scanned barcode. This is useful when decoding more than one code type. In addition to any single character prefix selected, the Code ID character is inserted between the prefix and the decoded symbol.

Select no Code ID character, a Symbol Code ID character, or an AIM Code ID character. For Code ID characters, see [Symbol Code Identifiers](#) and [AIM Code Identifiers](#).

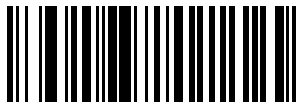

Symbol Code ID Character (2)

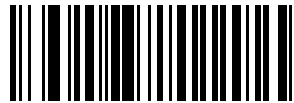

AIM Code ID Character (1)

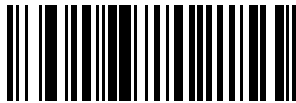

\*None (0)

## Prefix Suffix Values

**Key Category Parameter # P = 99, S1 = 98, S2 = 100**

**Key Category SSI # P = 63h, S1 = 62h, S2 = 64h**

**Decimal Value Parameter # P = 105, S1 = 104, S2 = 106**

**Decimal Value SSI # P = 69h, S1 = 68h, S2 = 6Ah**

This parameter appends up to one prefix or up to two suffix values to scan data for use in data editing. The default prefix and suffix value is 7013 <CR><LF> (Enter key).



**NOTE:** To use Prefix/Suffix values, first set the [Scan Data Transmission Format](#).

To set a value for a prefix or suffix, scan one of the following barcodes, and then scan four barcodes from [Numeric Barcodes](#) that correspond to that value. See [ASCII Character Sets](#) for the four-digit codes.

When using host commands to set the prefix or suffix, set the key category parameter to 1, and then set the 3-digit decimal value. See [ASCII Character Sets](#) for the four-digit codes.

To correct an error or change a selection, scan [Cancel](#).

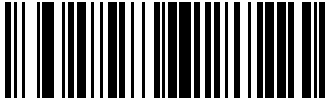

Scan Prefix (7)



Scan Suffix 1 (6)

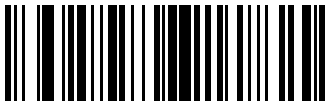

Scan Suffix 2 (8)



Data Format Cancel

## Scan Data Transmission Format

### Parameter # 235 (SSI # EBh)

This parameter selects the scan data format.



**NOTE:** If using this parameter do not use ADF rules to set the prefix/suffix.

To set values for the prefix or suffix, see [Prefix Suffix Values](#).

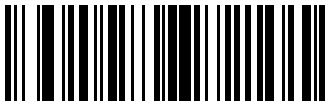

\*Data As Is (0)



<DATA> <SUFFIX 1> (1)



<DATA> <SUFFIX 2> (2)



<DATA> <SUFFIX 1> <SUFFIX 2> (3)

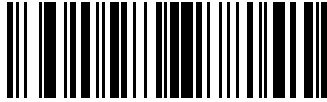

<PREFIX> <DATA > (4)

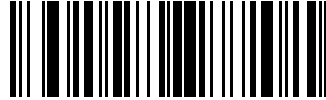

<PREFIX> <DATA> <SUFFIX 1> (5)

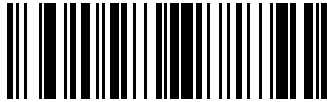

<PREFIX> <DATA> <SUFFIX 2> (6)

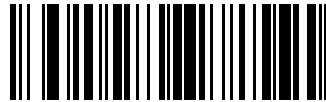

<PREFIX> <DATA> <SUFFIX 1> <SUFFIX 2> (7)

## FN1 Substitution Values

### Key Category Parameter # 103 (SSI # 67h)

### Decimal Value Parameter # 109 (SSI # 6Dh)

Keyboard wedge and USB HID keyboard hosts support a FN1 substitution feature. Enabling this substitutes any FN1 character (0x1b) in an EAN128 barcode with a value. This value defaults to 7013 <CR><LF> (Enter key).

When using host commands to set the FN1 substitution value, set the key category parameter to 1, and then set the 3-digit keystroke value. See the [ASCII Character Set](#) for the current host interface for the desired value.

## FN1 Substitution

Select Enable FN1 Substitution to replace FN1 characters in an EAN128 barcode with a user-selected keystroke (see [FN1 Substitution Values](#)).

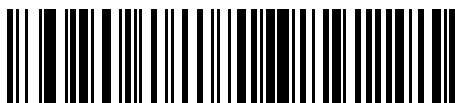

Enable FN1 Substitution

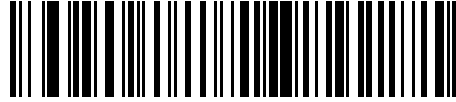

\*Disable FN1 Substitution

### Selecting a FN1 Substitution Value

Select a FN1 substitution value via the following barcode menus.

1. Scan the following barcode.

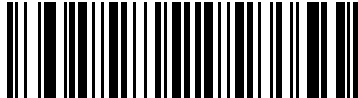

Set FN1 Substitution Value

2. Locate the keystroke desired for FN1 Substitution in the ASCII Character Set table for the current host interface, and enter the 4-digit ASCII value by scanning four barcodes from [Numeric Barcodes](#).

To correct an error or change the selection, scan [Cancel](#).

To enable FN1 substitution for USB HID keyboard, scan the [Enable FN1 Substitution](#) barcode.

### Report Software Version

When contacting support, a support representative may ask you to scan the bar code below to determine the version of software installed in the digital scanner.



Report Software Version

### Transmit No Read Message

#### Parameter # 94 (SSI # 5Eh)

This parameter sets an option for transmitting the No Read (NR) characters.



**NOTE:** If you enable Transmit No Read, and also enable Symbol Code ID Character or AIM Code ID Character for [Transmit Code ID Character](#), the scanner appends the code ID for Code 39 to the NR message.

This does not apply in presentation mode.

- Enable No Read - transmits the characters NR when a successful decode does not occur before trigger release or the [Decode Session Timeout](#) expires.
- Disable No Read - sends nothing to the host if a symbol does not decode.

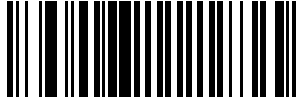

Enable No Read (1)



\*Disable No Read (0)

## Low Power Mode

### Parameter # 128 (SSI # 80h)

This parameter selects whether or not the scanner enters low power mode after a decode attempt or host communication.

This applies to serial and keyboard wedge connections. If disabled, power remains on after each decode attempt.



**NOTE:** The Low Power Mode parameter only applies for non-USB and non-RS485 host interfaces, and when [Trigger Mode](#) is set to Level 1 (Standard).

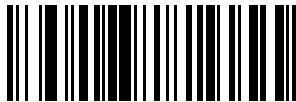

\*Enable Low Power Mode (1)

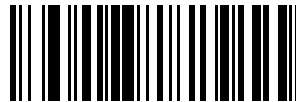

Disable Low Power Mode (0)

# Symbologies

You can program the scanner to perform various functions or activate different features.

This section describes symbology features and provides programming barcodes for selecting these features.

The scanner ships with the settings shown in the [Symbology Parameter Defaults Table](#). If the default values suit requirements, programming is not necessary.

## Symbology Parameter Defaults

Symbology Parameter Defaults lists the defaults for all symbology parameters.

Change these values in one of two ways:

- Choose the appropriate parameter in this section. The new value replaces the standard default value in memory. To recall the default parameter values, see [Default Parameters](#).
- Configure the scanner using the 123Scan configuration program. See [123Scan and Software Tools](#).



**NOTE:** Standard parameter defaults are available in each chapter of this guide.

**Table 12** Symbology Parameter Defaults

Parameter	Parameter Number <sup>a</sup>	SSI Number <sup>b</sup>	Default
<a href="#">Enable/Disable All Code Types</a>			
1D Symbologies			
UPC/EAN/JAN			
<a href="#">UPC-A</a>	1	01h	Enable
<a href="#">UPC-E</a>	2	02h	Enable
<a href="#">UPC-E1</a>	12	0Ch	Disable
<a href="#">EAN-8/JAN 8</a>	4	04h	Enable
<a href="#">EAN-13/JAN 13</a>	3	03h	Enable
<a href="#">Bookland EAN</a>	83	53h	Disable
<a href="#">Bookland ISBN Format</a>	576	F1h 40h	ISBN-10



## Symbologies

**Table 12** Symbology Parameter Defaults (Continued)

Parameter	Parameter Number <sup>a</sup>	SSI Number <sup>b</sup>	Default
ISSN EAN	617	F1h 69h	Disable
Decode UPC/EAN/JAN Supplementals (2 and 5 digits)	16	10h	Ignore
User-Programmable Supplementals Supplemental 1: Supplemental 2:	579 580	F1h 43h F1h 44h	000
UPC/EAN/JAN Supplemental Redundancy	80	50h	10
UPC/EAN/JAN Supplemental AIM ID	672	F1h A0h	Combined
Transmit UPC-A Check Digit	40	28h	Enable
Transmit UPC-E Check Digit	41	29h	Enable
Transmit UPC-E1 Check Digit	42	2Ah	Enable
UPC-A Preamble	34	22h	System Character
UPC-E Preamble	35	23h	System Character
UPC-E1 Preamble	36	24h	System Character
Convert UPC-E to UPC-A	37	25h	Disable
Convert UPC-E1 to UPC-A	38	26h	Disable
EAN/JAN Zero Extend	39	27h	Disable
UCC Coupon Extended Code	85	55h	Disable
Coupon Report	730	F1h DAh	New Coupon Format
UPC Reduced Quiet Zone	1289	F8h 05h 09h	Disable
Digimarc Digital Watermark	1687	F8h 06h 97h	Disable
Code 128			
Code 128	8	08h	Enable
Set Length(s) for Code 128	209, 210	D1h, D2h	1 to 55
GS1-128 (formerly UCC/EAN-128)	14	0Eh	Enable
ISBT 128	84	54h	Enable
ISBT Concatenation	577	F1h 41h	Autodiscriminate
Check ISBT Table	578	F1h 42h	Enable
ISBT Concatenation Redundancy	223	DFh	10
Code 128 <FNC4>	1254	F8h 04h E6h	Honor
Code 128 Security Level	751	F1h EFh	Security Level 1
Code 128 Reduced Quiet Zone	1208	F8h 04h B8h	Disable
Code 39			
Code 39	0	00h	Enable

**Table 12** Symbology Parameter Defaults (Continued)

Parameter	Parameter Number <sup>a</sup>	SSI Number <sup>b</sup>	Default
Trioptic Code 39	13	0Dh	Disable
Convert Code 39 to Code 32 (Italian Pharmacy Code)	86	56h	Disable
Code 32 Prefix	231	E7h	Disable
Set Length(s) for Code 39	18, 19	12h, 13h	1 to 55
Code 39 Check Digit Verification	48	30h	Disable
Transmit Code 39 Check Digit	43	2Bh	Disable
Code 39 Full ASCII Conversion	17	11h	Disable
Code 39 Security Level	750	F1h EEh	Security Level 1
Code 39 Reduced Quiet Zone	1209	F8h 04h B9h	Disable
Code 93			
Code 93	9	09h	Enable
Set Length(s) for Code 93	26, 27	1Ah, 1Bh	1 to 55
Code 11			
Code 11	10	0Ah	Disable
Set Lengths for Code 11	28, 29	1Ch, 1Dh	4 to 55
Code 11 Check Digit Verification	52	34h	Disable
Transmit Code 11 Check Digit(s)	47	2Fh	Disable
Interleaved 2 of 5 (ITF)			
Interleaved 2 of 5 (ITF)	6	06h	Disable
Set Lengths for I 2 of 5	22, 23	16h, 17h	6 to 55
I 2 of 5 Check Digit Verification	49	31h	Disable
Transmit I 2 of 5 Check Digit	44	2Ch	Disable
Convert I 2 of 5 to EAN 13	82	52h	Disable
I 2 of 5 Security Level	1121	F8h 04h 61h	Security Level 1
I 2 of 5 Reduced Quiet Zone	1210	F8h 04h BAh	Disable
Discrete 2 of 5 (DTF)			
Discrete 2 of 5	5	05h	Disable
Set Length(s) for D 2 of 5	20, 21	14h 15h	1 to 55
Codabar (NW - 7)			
Codabar	7	07h	Enable
Set Lengths for Codabar	24, 25	18h, 19h	4 to 55
CLSI Editing	54	36h	Disable

**Table 12** Symbology Parameter Defaults (Continued)

Parameter	Parameter Number <sup>a</sup>	SSI Number <sup>b</sup>	Default
NOTIS Editing	55	37h	Disable
Codabar Security Level	1776	F8h 06h F0h	Security Level 1
Codabar Upper or Lower Case Start/ Stop Characters Detection	855	F2h 57h	Upper Case
Codabar Mod 16 Check Digit Verification	1784	F8 06h F8h	None
Transmit Codabar Check Digit	704	F1h C0h	None
<b>MSI</b>			
MSI	11	0Bh	Disable
Set Length(s) for MSI	30, 31	1Eh, 1Fh	4 to 55
MSI Check Digits	50	32h	One
Transmit MSI Check Digit	46	2Eh	Disable
MSI Check Digit Algorithm	51	33h	Mod 10/Mod 10
<b>Chinese 2 of 5</b>			
Chinese 2 of 5	408	F0h 98h	Disable
<b>Matrix 2 of 5</b>			
Matrix 2 of 5	618	F1h 6Ah	Disable
Set Lengths for Matrix 2 of 5	619 620	F1h 6Bh F1h 6Ch	4 to 55
Matrix 2 of 5 Check Digit	622	F1h 6Eh	Disable
Transmit Matrix 2 of 5 Check Digit	623	F1h 6Fh	Disable
<b>Korean 3 of 5</b>			
Korean 3 of 5	581	F1h 45h	Disable
Inverse 1D	586	F1h 4Ah	Regular
<b>GS1 DataBar</b>			
GS1 DataBar Omnidirectional	338	F0h 52h	Enable
GS1 DataBar Limited	339	F0h 53h	Enable
GS1 DataBar Expanded	340	F0h 54h	Enable
Convert GS1 DataBar to UPC/EAN/JAN	397	F0h 8Dh	Disable
GS1 DataBar Security Level	1706	F8h 06h AAh	Level 3
GS1 DataBar Expanded Security Level	1707	F8h 06h ABh	Level 1
<b>Symbology-Specific Security Features</b>			
Redundancy Level	78	4Eh	1
Security Level	77	4Dh	1

## Symbologies

**Table 12** Symbology Parameter Defaults (Continued)

Parameter	Parameter Number <sup>a</sup>	SSI Number <sup>b</sup>	Default
1D Quiet Zone Level	1288	F8h 05h 08h	1
Intercharacter Gap Size	381	F0h 7Dh	Normal
Composite Codes			
Composite CC-C	341	F0h 55h	Disable
Composite CC-A/B	342	F0h 56h	Disable
Composite TLC-39	371	F0h 73h	Disable
UPC Composite Mode	344	F0h 58h	UPC Never Linked
Composite Beep Mode	398	F0h 8Eh	Beep As Each Code Type is Decoded
GS1-128 Emulation Mode for UCC/EAN Composite Codes	427	F0h ABh	Disable
2D Symbologies			
PDF417	15	0Fh	Enable
MicroPDF417	227	E3h	Disable
Code 128 Emulation	123	7Bh	Disable
Data Matrix	292	F0h 24h	Enable
GS1 Data Matrix	1336	F8h 05h 38h	Disable
Data Matrix Inverse	588	F1h 4Ch	Inverse Autodetect
Maxicode	294	F0h 26h	Disable
QR Code	293	F0h 25h	Enable
GS1 QR	1343	F8h 05h 3Fh	Disable
QR Inverse	587	F1h 4Bh	Regular
MicroQR	573	F1h 3Dh	Enable
Linked QR Mode	1847	737h	Linked QR Only
Aztec	574	F1h 3Eh	Enable
Aztec Inverse	589	F1h 4Dh	Inverse Autodetect
Han Xin	1167	F8h 04h 8Fh	Disable
Han Xin Inverse	1168	F8h 04h 90h	Regular
DotCode	1906	F8 07 72h	Disable
DotCode Prioritize	1937	F8 07 91h	Disable
DotCode Inverse	1907	F8 07 73h	Autodetect
DotCode Mirrored	1908	F8 07 74h	Autodetect
Macro PDF			
Flush Macro PDF Buffer	N/A	N/A	N/A

**Table 12** Symbology Parameter Defaults (Continued)

Parameter	Parameter Number <sup>a</sup>	SSI Number <sup>b</sup>	Default
Abort Macro PDF Entry	N/A	N/A	N/A
Postal Codes			
US Postnet	89	59h	Disable
US Planet	90	5Ah	Disable
Transmit US Postal Check Digit	95	5Fh	Enable
UK Postal	91	5Bh	Disable
Transmit UK Postal Check Digit	96	60h	Enable
Japan Postal	290	F0h 22h	Disable
Australia Post	291	F0h 23h	Disable
Australia Post Format	718	F1h CEh	Autodiscriminate
Netherlands KIX Code	326	F0h 46h	Disable
USPS 4CB/One Code/Intelligent Mail	592	F1h 50h	Disable
UPU FICS Postal	611	F1h 63h	Disable
Mailmark	1337	F8h 05h 39h	Disable
Digimarc Barcode	N/A	N/A	Disable
Posti LAPA 4-State Code	2031	F8 07EF	Disable

<sup>a</sup> Parameter number decimal values are used for programming via RSM commands.

<sup>b</sup> SSI number hex values are used for programming via SSI commands.

## Enable/Disable All Code Types

- Disable All Code Types - Disable all symbologies. This is useful when enabling only a few code types.
- Enable All Code Types - Enable all symbologies. This is useful if you need to disable only a few code types.

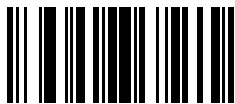

Disable All Code Types

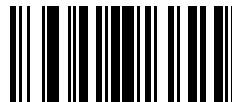

Enable All Code Types

## UPC/EAN/JAN

You can choose one of these parameters to enable UPC, EAN, or JAN settings.

### UPC-A

#### Parameter # 1 (SSI #01h)

This parameter enables or disables UPC-A.

- \*Enabled - enables UPC-A.
- Disabled - disables UPC-A.

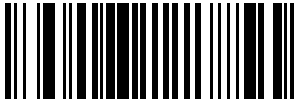

\*Enable UPC-A (1)

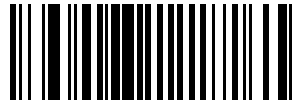

Disable UPC-A (0)

### UPC-E

#### Parameter # 2 (SSI # 02h)

This parameter enables UPC-E.

- \*Enabled - this sets UPC-E to use.
- Disabled - UPC-E is no longer in use.

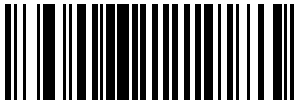

\*Enable UPC-E (1)

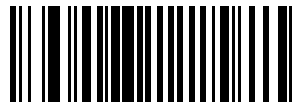

Disable UPC-E (0)

### UPC-E1

#### Parameter # 12 (SSI # 0Ch)

This parameter enables UPC-E1.

- Enabled - This sets UPC-E1 to use.
- Disabled - UPC-E1 is no longer in use.



**NOTE:** UPC-E1 is not a UCC (Uniform Code Council) approved symbology.

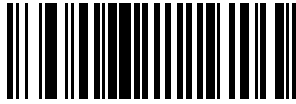

Enable UPC-E1 (1)

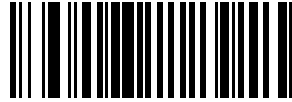

\*Disable UPC-E1 (0)

## EAN-8/JAN-8

### Parameter # 4 (SSI # 04h)

This parameter enables EAN-8/JAN-8.

- Enabled - Sets EAN-8/JAN-8 for use.
- Disabled - EAN-8/JAN-8 is no longer in use.

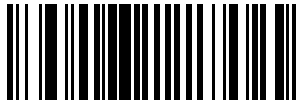

\*Enable EAN-8/JAN-8 (1)

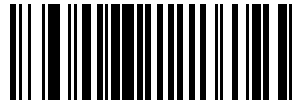

Disable EAN-8/JAN-8 (0)

## EAN-13/JAN-13

### Parameter # 3 (SSI # 03h)

This parameter enables EAN-13/JAN-13.

- Enabled - Sets EAN-13/JAN-13 for use.
- Disabled - EAN-13/JAN-13 is no longer in use.



\*Enable EAN-13/JAN-13 (1)

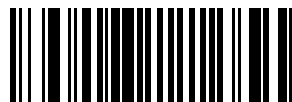

Disable EAN-13/JAN-13 (0)

## Bookland EAN

### Parameter # 83 (SSI # 53h)

This parameter enables Bookland EAN.

- Enabled - This sets Bookland EAN for use.
- Disabled - Bookland EAN is no longer in use.



**NOTE:** If you enable Bookland EAN, select a [Bookland ISBN Format](#). Also set [Decode UPC/EAN/JAN Supplementals](#) to either Decode UPC/EAN/JAN with Supplementals Only, Autodiscriminate UPC/EAN/JAN With Supplementals, or Enable 978/979 Supplemental Mode.

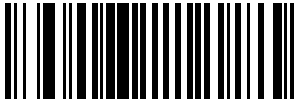

Enable Bookland EAN (1)

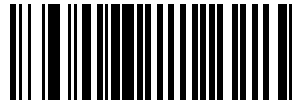

\*Disable Bookland EAN (0)

## Bookland ISBN Format

### Parameter # 576 (SSI # F1h 40h)

If Bookland EAN is enabled, this parameter allows you to choose a format for Bookland data.

- \*Bookland ISBN-10 - The scanner reports Bookland data starting with 978 in traditional 10-digit format with the special Bookland check digit for backward-compatibility. Data starting with 979 is not considered Bookland in this mode.
- Bookland ISBN-13 - The scanner reports Bookland data (starting with either 978 or 979) as EAN-13 in 13-digit format to meet the 2007 ISBN-13 protocol.



**NOTE:** For Bookland EAN to function properly, first enable [Bookland EAN](#) and then set [Decode UPC/EAN/JAN Supplementals](#) to either Decode UPC/EAN/JAN with Supplementals Only, Autodiscriminate UPC/EAN/JAN With Supplementals, or Enable 978/979 Supplemental Mode.

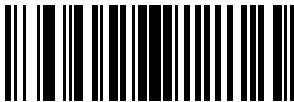

\*Bookland ISBN-10 (0)

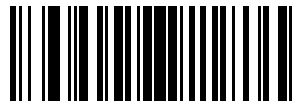

Bookland ISBN-13 (1)

## ISSN EAN

### Parameter # 617 (SSI # F1h 69h)



This parameter enables ISSN EAN.

- Enabled - Sets ISSN EAN for use.
- \*Disabled - ISSN EAN is no longer in use.

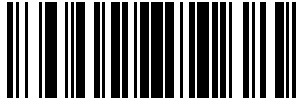

Enable ISSN EAN (1)



\*Disable ISSN EAN (0)

## Decode UPC/EAN/JAN Supplementals

### Parameter # 16 (SSI # 10h)

Supplementals are barcodes appended according to specific format conventions (e.g., UPC A+2, UPC E+2, EAN 13+2). The following options are available:

- Decode UPC/EAN/JAN with Supplementals Only - The scanner only decodes UPC/EAN/JAN symbols with supplemental characters, and ignores symbols without supplementals.
- Ignore UPC/EAN/JAN Supplementals - When presented with a UPC/EAN/JAN plus supplemental symbol, the scanner decodes UPC/EAN/JAN and ignores the supplemental characters.
- Autodiscriminate UPC/EAN/JAN with Supplementals - The scanner decodes UPC/EAN/JAN symbols with supplemental characters immediately. If the symbol does not have a supplemental, the scanner must decode the barcode the number of times set via [UPC/EAN/JAN Supplemental Redundancy](#) on page 156 before transmitting its data to confirm that there is no supplemental.
- Select one of the following Supplemental Mode options to immediately transmit EAN-13 barcodes starting with that prefix that have supplemental characters. If the symbol does not have a supplemental, the scanner must decode the barcode the number of times set via [UPC/EAN/JAN Supplemental](#)

[Redundancy](#) on page 156 before transmitting the data to confirm that there is no supplemental. The scanner transmits UPC/EAN/JAN barcodes that do not have that prefix immediately

- Enable 378/379 Supplemental Mode
- Enable 978/979 Supplemental Mode



**NOTE:** If you select 978/979 Supplemental Mode and are scanning Bookland EAN barcodes, see [Bookland EAN](#) on page 152 to enable Bookland EAN, and select a format using [Bookland ISBN Format](#) on page 152.

- Enable 977 Supplemental Mode
- Enable 414/419/434/439 Supplemental Mode
- Enable 491 Supplemental Mode
- Enable Smart Supplemental Mode - This applies to EAN-13 barcodes starting with any prefix listed previously.
- Supplemental User-Programmable Type 1 - This applies to EAN-13 barcodes starting with a 3-digit user-defined prefix. Set this using [User-Programmable Supplementals](#) on page 156.
- Supplemental User-Programmable Type 1 and 2 - This applies to EAN-13 barcodes starting with either of two 3-digit user-defined prefixes. Set the prefixes using [User-Programmable Supplementals](#) on page 156.
- Smart Supplemental Plus User-Programmable 1 - This applies to EAN-13 barcodes starting with any prefix listed previously or the prefix set using [User-Programmable Supplementals](#) on page 156.
- Smart Supplemental Plus User-Programmable 1 and 2 - This applies to EAN-13 barcodes starting with any prefix listed previously or one of the two user-defined prefixes set using [User-Programmable Supplementals](#) on page 156.



**NOTE:** To minimize the risk of invalid data transmission, select either to decode or ignore supplemental characters.



Decode UPC/EAN/JAN With Supplementals Only  
(1)



\*Ignore UPC/EAN/JAN Supplementals (0)



Autodiscriminate UPC/EAN/JAN with  
Supplementals (2)

# Symbologies



Enable 978/979 Supplemental Mode (5)



Enable 414/419/434/439 Supplemental Mode (6)



Enable Smart Supplemental Mode (3)



Supplemental User-Programmable Type 1 and 2 (10)

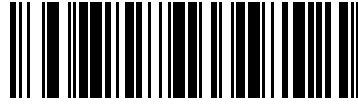

Enable 378/379 Supplemental Mode (4)



Enable 977 Supplemental Mode (7)



Enable 491 Supplemental Mode (8)

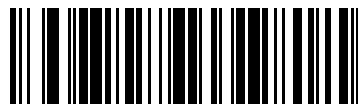

Supplemental User-Programmable Type 1 (9)



Smart Supplemental Plus User-Programmable 1 (11)



Smart Supplemental Plus User-Programmable 1  
and 2 (12)

## User-Programmable Supplementals

**Parameter # 579 (SSI # F4h F1h 43h)**

**Parameter # 580 (SSI # F4h F1h 44h)**

If you selected a Supplemental User-Programmable option, this parameter allows you to set two 3-digit prefixes.

- User-Programmable Supplemental 1 - Sets the first 3-digit prefix. See [Numeric Barcodes](#).
- User-Programmable Supplemental 2 - Sets a 2nd 3-digit prefix, if necessary. See [Numeric Barcodes](#).

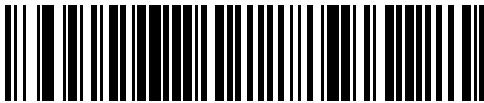

User-Programmable Supplemental 1



User-Programmable Supplemental 2

## UPC/EAN/JAN Supplemental Redundancy

**Parameter # 80 (SSI # 50h)**

If you selected Autodiscriminate UPC/EAN/JAN with Supplementals, this option sets the number of times to decode a symbol without supplementals before transmission. You can enable audio feedback during a reconnect attempt.

The range is from 2-30. Five or above is recommended when decoding a mix of UPC/EAN/JAN symbols with and without supplementals.

To set a redundancy value, scan the following barcode, and then scan two barcodes from [Numeric Barcodes](#) on page 264. Enter a leading zero for single digit numbers. To correct an error or change a selection, scan [Cancel](#) on page 265.

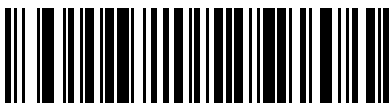

UPC/EAN/JAN Supplemental Redundancy

## UPC/EAN/JAN Supplemental AIM ID Format

**Parameter # 672 (SSI # F1h A0h)**

If Transmit Code ID Character is set to **AIM Code ID Character**, select an output format when reporting UPC/EAN/JAN barcodes with supplementals.

- Separate - Transmit UPC/EAN/JAN with supplementals with separate AIM IDs but one transmission, for example,

```
]E<0 or 4><data>]E<1 or 2>[supplemental data]
```

- Combined - Transmit UPC/EAN/JAN with supplementals with one AIM ID and one transmission. For example, see below.

```
]E3<data+supplemental data>
```

- Separate Transmissions - Transmit UPC/EAN/JAN with supplementals with separate AIM IDs and separate transmissions, for example,

```
]E<0 or 4><data>  
]E<1 or 2>[supplemental data]
```



Separate (0)



\*Combined (1)

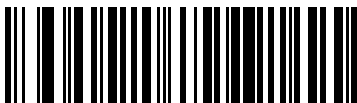

Separate Transmissions (2)

## Transmit UPC-A Check Digit

### Parameter # 40 (SSI # 28h)

This parameter transmits data with or without the UPC-A check digit.

The check digit is the last character of the symbol used to verify the integrity of the data. It is always verified to guarantee the integrity of the data.

- \*Transmit UPC-A Check Digit - Transmits the data with the UPC-A check digit.
- Do Not Transmit UPC-A Check Digit - Transmits the data without the UPC-A check digit.



\*Transmit UPC-A Check Digit (1)

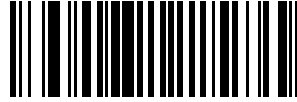

Do Not Transmit UPC-A Check Digit (0)

## Transmit UPC-E Check Digit

### Parameter # 41 (SSI # 29h)

This parameters transmits data with or without the UPC-E check digit.

The check digit is the last character of the symbol used to verify the integrity of the data. It is always verified to guarantee the integrity of the data.

- \*Transmit UPC-E Check Digit - transmits the data with the UPC-E check digit.
- Do Not Transmit UPC-E Check Digit - transmits the data without the UPC-E check digit.

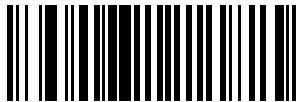

\*Transmit UPC-E Check Digit (1)



Do Not Transmit UPC-E Check Digit (0)

## Transmit UPC-E1 Check Digit

### Parameter # 42 (SSI #2Ah)

This parameters transmits data with or without the UPC-E1 check digit.

The check digit is the last character of the symbol used to verify the integrity of the data. It is always verified to guarantee the integrity of the data.

- \*Transmit UPC-E1 Check Digit - Transmits the data with the UPC-E1 check digit.
- Do Not Transmit UPC-E1 Check Digit - Transmits the data without the UPC-E1 check digit.



\*Transmit UPC-E1 Check Digit (1)



Do Not Transmit UPC-E1 Check Digit (0)

## UPC-A Preamble

### Parameter # 34 (SSI # 22h)

Preamble characters are part of the UPC symbol, and include Country Code and System Character.

Select the appropriate option for transmitting a UPC-A preamble to match the host system:

- Transmit System Character only
- Transmit System Character and Country Code (“0” for USA)
- Transmit no preamble.

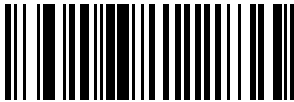

No Preamble (<DATA>) (0)

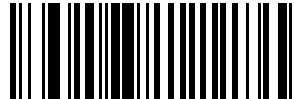

\*System Character (<SYSTEM CHARACTER>  
<DATA>) (1)

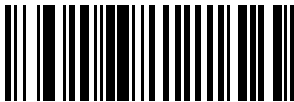

System Character & Country Code (< COUNTRY  
CODE> <SYSTEM CHARACTER> <DATA>) (2)

## UPC-E Preamble

### Parameter # 35 (SSI # 23h)

Preamble characters are part of the UPC symbol, and include Country Code and System Character.

Select the appropriate option for transmitting a UPC-E preamble to match the host system:

- Transmit System Character only
- Transmit System Character and Country Code (“0” for USA)
- Transmit no preamble.



No Preamble (<DATA>) (0)

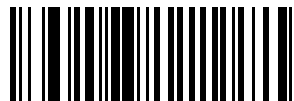

\*System Character (<SYSTEM CHARACTER>  
<DATA>) (1)

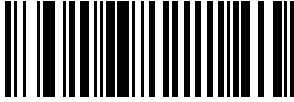

System Character & Country Code (< COUNTRY CODE> <SYSTEM CHARACTER> <DATA>) (2)

## UPC-E1 Preamble

### Parameter # 36 (SSI # 24h)

Preamble characters are part of the UPC symbol, and include Country Code and System Character.

Select the appropriate option for transmitting a UPC-E1 preamble to match the host system:

- Transmit System Character only
- Transmit System Character and Country Code (“0” for USA)
- Transmit no preamble.

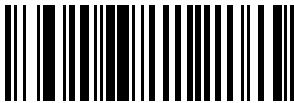

No Preamble (<DATA>) (0)

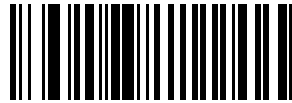

\*System Character (<SYSTEM CHARACTER> <DATA>) (1)

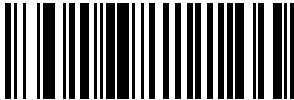

System Character & Country Code (< COUNTRY CODE> <SYSTEM CHARACTER> <DATA>) (2)

## Convert UPC-E to UPC-A

### Parameter # 37 (SSI # 25h)

This parameter converts UPC-E (zero suppressed) decoded data to UPC-A format before transmission.

After conversion, the data follows UPC-A format and is affected by UPC-A programming selections (such as, Preamble, Check Digit).

- \*Enabled - Converts UPC-E decoded data to UPC-A format.
- Disabled - Transmits UPC-E decoded data without conversion to UPC-A.

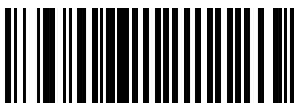

Convert UPC-E to UPC-A (Enable) (1)



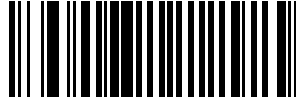

\*Do Not Convert UPC-E to UPC-A (Disable) (0)

## Convert UPC-E1 to UPC-A

### Parameter # 38 (SSI # 26h)

This parameter converts UPC-E1 (zero suppressed) decoded data to UPC-A format before transmission.

After conversion, the data follows UPC-A format and is affected by UPC-A programming selections (e.g., Preamble, Check Digit).

- \*Enabled - converts UPC-E1 decoded data to UPC-A format.
- Disabled - transmits UPC-E1 decoded data without conversion to UPC-A.

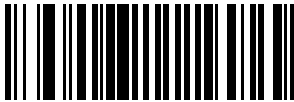

Convert UPC-E1 to UPC-A (Enable) (1)

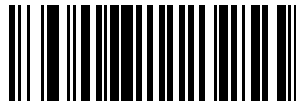

\*Do Not Convert UPC-E1 to UPC-A (Disable) (0)

## EAN/JAN Zero Extend

### Parameter # 39 (SSI # 27h)

This parameter enables or disables decoded EAN-8 symbols to be compatible in length with EAN-13 symbols.

- Enabled - Adds five leading zeros to decoded EAN-8 symbols to make them compatible in length to EAN-13 symbols
- Disabled - Transmits EAN-8 symbols as-is, without adding zeroes.

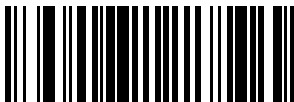

Enable EAN/JAN Zero Extend (1)



\*Disable EAN/JAN Zero Extend (0)

## UCC Coupon Extended Code

### Parameter # 85 (SSI # 55h)

This parameter decodes UPC-A barcodes starting with digit '5', EAN-13 barcodes starting with digit '99', and UPC-A/GS1-128 coupon codes.

- Enabled - Extends decoding for UPC-A, EAN-13, and GS1-128 coupon codes.
- \*Disabled - Does not extend decoding for UPC-A, EAN-13, and GS1-128 coupon codes.



**NOTE:** UPC-A, EAN-13, and GS1-128 must be enabled to use this feature.



**NOTE:** See [UPC/EAN/JAN Supplemental Redundancy](#) to control autodiscrimination of the GS1-128 portion (right half) of a coupon code.

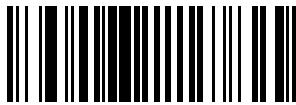

Enable UCC Coupon Extended Code (1)

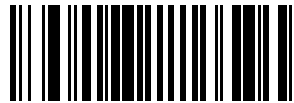

\*Disable UCC Coupon Extended Code (0)

## Coupon Report

### Parameter # 730 (SSI # F1h DAh)

This parameter selects the type of coupon format to support.

- Old Coupon Format - Support UPC-A/GS1-128 and EAN-13/GS1-128.
- New Coupon Format - An interim format to support UPC-A/GS1-DataBar and EAN-13/GS1-DataBar.
- Autodiscriminate Format - Support both Old Coupon Format and New Coupon Format.



Old Coupon Format (0)

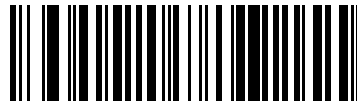

\*New Coupon Format (1)



Autodiscriminate Coupon Format (2)

## UPC Reduced Quiet Zone

### Parameter # 1289 (SSI # F8h 05h 09h)

This parameter enables or disables decoding UPC barcodes with reduced quiet zones (the margins on either side of the barcode).

- Enabled - Enables decoding UPC barcodes with reduced quiet zones.
- \*Disabled - Disables decoding UPC barcodes with reduced quiet zones.



**NOTE:** If you select Enable, select a [1D Quiet Zone Level](#).

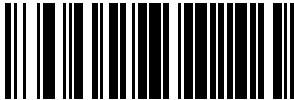

Enable UPC Reduced Quiet Zone (1)

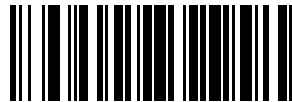

\*Disable UPC Reduced Quiet Zone (0)

## Digimarc Digital Watermarks

### Parameter # 1687 (SSI # F8h 0h 97h)

This parameter enables or disables the Digimarc Digital Watermarks.

- Enabled - Enables the Digimarc Digital Watermarks.
- \*Disabled - Disables the Digimarc Digital Watermarks.



Enable Digimarc Digital Watermarks/DW (1)

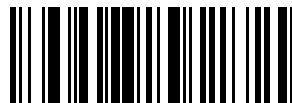

\*Disable Digimarc Digital Watermarks/DW (0)

## Code 128

### Parameter # 8 (SSI #08h)

You can enable or disable Code 128.

- \*Enabled - Enables Code 128.
- Disabled - Disables Code 128.

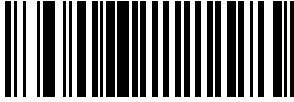

\*Enable Code 128 (1)



Disable Code 128 (0)

## Set Lengths for Code 128

### Parameter # 209 (SSI #D1h)

### Parameter # 210 (SSI #D2h)

This parameter sets lengths for Code 128 to any length, one or two discrete lengths, or lengths within a specific range.

The length of a code refers to the number of characters (for example, human-readable characters), including check digit(s) the code contains. The default is Length Within Range: 1 to 55.



**NOTE:** When setting lengths, enter a leading zero for single digit numbers.

- One Discrete Length - Decode only Code 128 symbols containing a selected length.
- Two Discrete Lengths - Decode only Code 128 symbols containing either of two lengths.
- Length Within Range - Decode Code 128 symbols with a specific length range.
- Any Length - Decode Code 128 symbols containing any number of characters within the scanner's capability.

Select lengths using barcodes in [Numeric Barcodes](#). To correct an error or change the selection, scan [Cancel](#).

For example:

- To decode only Code 128 symbols with 14 characters, scan Code 128 - One Discrete Length, and then scan 1, 4.
- To decode only Code 128 symbols containing either 2 or 14 characters, scan Code 128 - Two Discrete Lengths, and then scan 0, 2, 1, 4.
- To decode Code 128 symbols containing between 4 and 12 characters, scan Code 128 - Length Within Range, and then scan 0, 4, 1, 2.



Code 128 - One Discrete Length



Code 128 - Two Discrete Lengths



\*Code 128 - Length Within Range (Default: Length Within Range: 1 to 55 )

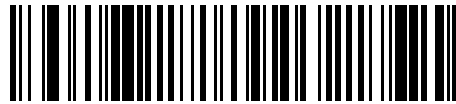

Code 128 - Any Length

## GS1-128 (formerly UCC/EAN-128)

### Parameter # 14 (SSI #0Eh)

You can enable or disable GS1-128.

- \*Enabled - Enables GS1-128.
- Disabled - Disables GS1-128.



\*Enable GS1-128 (1)

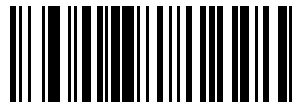

Disable GS1-128 (0)

## ISBT 128

### Parameter # 84 (SSI #54h)

You can enable or disable ISBT 128.

- \*Enabled - enables ISBT 128.
- Disabled - disables ISBT 128.

ISBT 128 is a variant of Code 128 used in the blood bank industry.



\*Enable ISBT 128 (1)

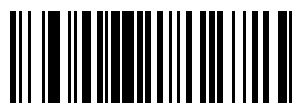

Disable ISBT 128 (0)

## ISBT Concatenation

### Parameter # 577 (SSI #F1h 41h)

This parameter enables and disables ISBT concatenation.

Select an option for concatenating pairs of ISBT code types:

- Enable ISBT Concatenation - There must be two ISBT codes in order for the scanner to decode and perform concatenation. The scanner does not decode single ISBT symbols.
- Disable ISBT Concatenation - The scanner does not concatenate pairs of ISBT codes it encounters.
- Autodiscriminate ISBT Concatenation - The scanner decodes and concatenates pairs of ISBT codes immediately. If only a single ISBT symbol is present, the scanner must decode the symbol the number of times set via [ISBT Concatenation Redundancy](#) before transmitting its data to confirm that there is no additional ISBT symbol.



**NOTE:** For ISBT AutoDetect to operate as expected, both barcodes must be in the field of view simultaneously. This may be difficult to achieve in presentation mode.



**NOTE:** When enabling ISBT Concatenation or Autodiscriminate ISBT Concatenation set Code 128 Security Level to Level 2.

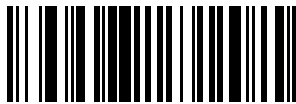

Enable ISBT Concatenation (1)

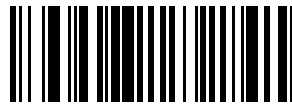

\*Disable ISBT Concatenation (0)

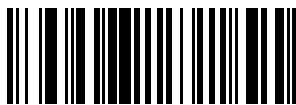

Autodiscriminate ISBT Concatenation (2)

## Check ISBT Table

### Parameter # 578 (SSI #F1h 42h)

This parameter enables or disables the Check ISBT Table to concatenate only those pairs found in this table. Other types of ISBT codes are not concatenated.

- \*Enabled - enables the Check ISBT Table to concatenate only those pairs found in this table.
- Disabled - disables the Check ISBT Table to concatenate only those pairs found in this table.

The ISBT specification includes a table that lists several types of ISBT barcodes that are commonly used in pairs.



\*Enable Check ISBT Table (1)



Disable Check ISBT Table (0)

## ISBT Concatenation Redundancy

### Parameter # 223 (SSI #DFh)

This parameter sets the number of times the scanner must decode an ISBT symbol before determining that there is no additional symbol.

This parameter applies if you set ISBT Concatenation to Autodiscriminate.

Scan the following barcode, and then scan barcodes in [Numeric Barcodes](#) to set a value between 2 and 20. Enter a leading zero for single-digit numbers. To correct an error or change a selection, scan [Cancel](#). The default is 10.



ISBT Concatenation Redundancy

## Code 128 <FNC4>

### Parameter # 1254 (SSI #F8h 04h E6h)

This parameter processes the Code 128 <FNC4> character, and either ignores (removes) the character or honors (does not remove) the character.

- \*Honor Code 128 <FNC4> - The <FNC4> character is processed normally, per Code 128 standard.
- Ignore Code 128 <FNC4> - Strips the <FNC4> character from the decode data. The remaining characters are sent to the host unchanged.



\*Honor Code 128 &lt;FNC4&gt; (0)

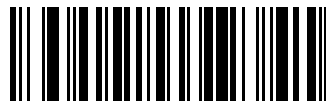

Ignore Code 128 &lt;FNC4&gt; (1)

## Code 128 Security Level

### Parameter # 751 (SSI #F1h EFh)

This parameter enables four levels of decode security for Code 128.

Code 128 barcodes are vulnerable to misdecodes, particularly when Code 128 Lengths is set to Any Length. There is an inverse relationship between security and scanner aggressiveness. Increasing the level of security can reduce scanning aggressiveness, so select only the level of security necessary.

- Code 128 Security Level 0 - The scanner operates in its most aggressive state, while providing sufficient security in decoding most in-spec barcodes.
- Code 128 Security Level 1 - This option eliminates most misdecodes while maintaining reasonable aggressiveness.
- Code 128 Security Level 2 - This option applies greater barcode security requirements if Security Level 1 fails to eliminate misdecodes.
- Code 128 Security Level 3 - If you selected Security Level 2, and misdecodes still occur, select this security level to apply the highest safety requirements.



**NOTE:** Selecting Code 128 Security Level 3 is an extreme measure against mis-decoding severely out-of-spec barcodes, and significantly impairs the decoding ability of the device. If this level of security is required, try to improve the quality of the barcodes.

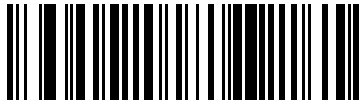

Code 128 Security Level 0 (0)



\*Code 128 Security Level 1 (1)

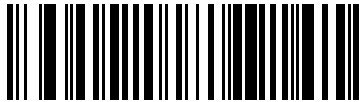

Code 128 Security Level 2 (2)



Code 128 Security Level 3 (3)

## Code 128 Reduced Quiet Zone

### Parameter # 1208 (SSI #F8h 04h B8h)

This parameter enables or disables decoding Code 128 with reduced quiet zones (the margins on either side of the barcode).

If you select Enable, select a [1D Quiet Zone Level](#).

- \*Enabled - enables Code 128 with reduced Quiet Zones.



- Disabled - disables Code 128 with reduced Quiet Zones.



Enable Code 128 Reduced Quiet Zone (1)

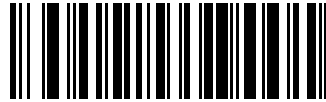

\*Disable Code 128 Reduced Quiet Zone (0)

## Code 39

### Parameter # 0 (SSI #00h)

This parameter enables or disables Code 39.

- \*Enabled - Enables Code 39.
- Disabled - Disables Code 39.

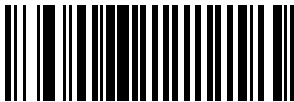

\*Enable Code 39 (1)

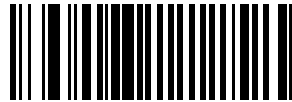

Disable Code 39 (0)

## Trioptic Code 39

### Parameter # 13 (SSI #0Dh)

This parameter enables or disables Trioptic Code 39.

Trioptic Code 39 is a variant of Code 39 used in the marking of computer tape cartridges. Trioptic Code 39 symbols always contain six characters.

- Enabled - enables Trioptic Code 39.
- \*Disabled - disables Trioptic Code 39.



**NOTE:** You cannot enable Trioptic Code 39 and Code 39 Full ASCII simultaneously.

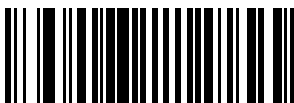

Enable Trioptic Code 39 (1)

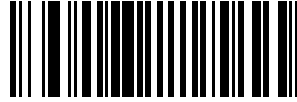

\*Disable Trioptic Code 39 (0)

## Convert Code 39 to Code 32

### Parameter # 86 (SSI #5h)

This parameter enables or disables converting Code 39 to Code 32.

Code 32 is a variant of Code 39 used by the Italian pharmaceutical industry.



**NOTE:** Code 39 must be enabled for this parameter to function.

- Enabled - enables Convert Code 39 to Code 32.
- \*Disabled - disables Convert Code 39 to Code 32.

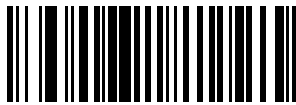

Enable Convert Code 39 to Code 32 (1)

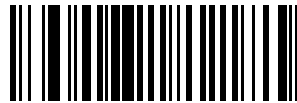

Disable Convert Code 39 to Code 32 (0)

## Code 32 Prefix

### Parameter # 231 (SSI #E7h)

This parameter enables or disables adding the prefix character “A” to all Code 32 barcodes.

- Enabled - enables Code 32 Prefix.
- \*Disabled - disables Code 32 Prefix.



**NOTE:** [Convert Code 39 to Code 32](#) must be enabled for this parameter to function.

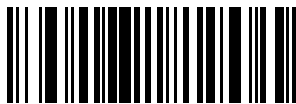

Enable Code 32 Prefix (1)

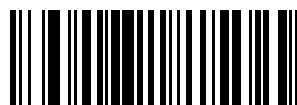

\*Disable Code 32 Prefix (0)

## Set Lengths for Code 39

### L1 Parameter # 18 (SSI #12h)

### L2 Parameter # 19 (SSI #13h)

This parameter set lengths for Code 39.

The length of a code refers to the number of characters (for example, human readable characters), including check digit(s) the code contains. Set lengths for Code 39 to any length, one or two discrete lengths, or lengths within a specific range. If Code 39 Full ASCII is enabled, Length Within Range or Any Length are the preferred options. The default is Length Within Range: 1 to 55.



**NOTE:** When setting lengths, enter a leading zero for single digit numbers.

- One Discrete Length - Decode only Code 39 symbols containing a selected length.
- Two Discrete Lengths - Decode only Code 39 symbols containing either of two lengths.
- Length Within Range - Decode Code 39 symbols with a specific length range.
- Any Length - Decode Code 39 symbols containing any number of characters within the scanner's capability.

Select lengths using barcodes in [Numeric Barcodes](#). To correct an error or change the selection, scan [Cancel](#).

For example:

- To decode only Code 39 symbols with 14 characters, scan Code 39 - One Discrete Length, and then scan 1, 4.
- To decode only Code 39 symbols containing either 2 or 14 characters, scan Code 39 - Two Discrete Lengths, and then scan 0, 2, 1, 4.
- To decode Code 39 symbols containing between 4 and 12 characters, scan Code 39 - Length Within Range, and then scan 0, 4, 1, 2.



Code 39 - One Discrete Length

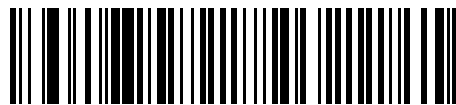

Code 39 - Two Discrete Lengths



\*Code 39 - Length Within Range (Default: Length Within Range: 1 to 55 )



Code 39 - Any Length

## Code 39 Check Digit Verification

### Parameter # 48 (SSI #30h)

This parameter checks the integrity of all Code 39 symbols to verify that the data complies with specified check digit algorithm.

Only Code 39 symbols which include a modulo 43 check digit are decoded. Enable this feature if the Code 39 symbols contain a Modulo 43 check digit.

- Enabled - enables Code 39 Check Digit.
- \*Disabled - disables Code 39 Check Digit.

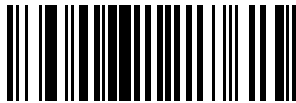

Enable Code 39 Check Digit (1)

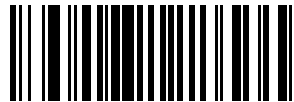

\*Disable Code 39 Check Digit (0)

## Transmit Code 39 Check Digit

### Parameter # 43 (SSI #2Bh)

This parameter transmits Code 39 data with or without the check digit.

- Enabled - enables Transmit Code 39 Check Digit.
- \*Disabled - disables Transmit Code 39 Check Digit.



**NOTE:** [Code 39 Check Digit Verification](#) must be enabled for this parameter to function.



Transmit Code 39 Check Digit (Enable) (1)



\*Do Not Transmit Code 39 Check Digit (Disable) (0)

## Code 39 Full ASCII Conversion

### Parameter # 17 (SSI #11h)

This parameter enables or disables Code 39 Full ASCII.

Code 39 Full ASCII is a variant of Code 39 which pairs characters to encode the full ASCII character set.

- Enabled - enables Code 39 Full ASCII.
- \*Disabled - disables Code 39 Full ASCII.



**NOTE:** You cannot enable Trioptic Code 39 and Code 39 Full ASCII simultaneously.



**NOTE:** Code 39 Full ASCII to Full ASCII Correlation is host-dependent, and is therefore described in the ASCII character set table for the appropriate interface. See [ASCII Character Sets](#).

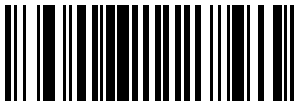

Enable Code 39 Full ASCII (1)

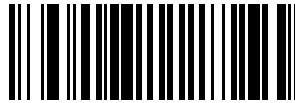

\*Disable Code 39 Full ASCII (0)

## Code 39 Security Level

### Parameter # 750 (SSI #F1h EEh)

This parameter sets the security level for Code 39.

Select increasing levels of security for decreasing levels of barcode quality. There is an inverse relationship between security, and device aggressiveness, so choose only that level of security necessary for any given application.

- Code 39 Security Level 0 - Allows the device to operate in its most aggressive state, while providing sufficient security in decoding most "in-spec" barcodes.
- \*Code 39 Security Level 1 - This setting eliminates most mis-decodes
- Code 39 Security Level 2 - Select this option if Security Level 1 fails to eliminate mis-decodes.
- Code 39 Security Level 3 - If you selected Security Level 2 and mis-decodes still occur, select this security level.



**NOTE:** Selecting Security Level 3 is an extreme measure against mis-decoding severely out of spec barcodes. Selecting this level of security significantly impairs the decoding ability of the device. If you need this level of security, try to improve the quality of the barcodes.



Code 39 Security Level 0 (0)



\*Code 39 Security Level 1 (1)



Code 39 Security Level 2 (2)



Code 39 Security Level 3 (3)

## Code 39 Reduced Quiet Zone

### Parameter # 1209 (SSI #F8h 04h B9h)

This parameter enables or disables decoding Code 39 with reduced quiet zones (the margins on either side of the barcode).

If you select Enable, select a [1D Quiet Zone Level](#).

- \*Enabled - enables Code 39 with reduced Quiet Zones.
- Disabled - disables Code 39 with reduced Quiet Zones.

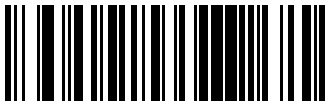

Enable Code 39 Reduced Quiet Zone (1)

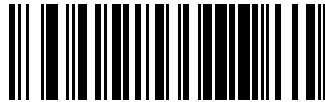

\*Disable Code 39 Reduced Quiet Zone (0)

## Code 93

### Parameter # 9 (SSI #09h)

This parameter enables or disables Code 93.

- \*Enabled - enables Code 93.
- Disabled - disables Code 93.

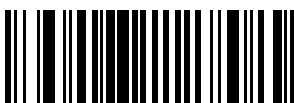

\*Enable Code 93 (1)

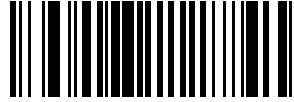

Disable Code 93 (0)

## Set Lengths for Code 93

### Parameter # 26 (SSI #1Ah)

### Parameter # 27 (SSI #1Bh)

This parameter sets the lengths for Code 93 to any length, one or two discrete lengths, or lengths within a specific range.

The length of a code refers to the number of characters (for example, human-readable characters), including check digit(s) the code contains. The default is Length Within Range: 1 to 55.



**NOTE:** When setting lengths, enter a leading zero for single-digit numbers.

- One Discrete Length - Decode only Code 93 symbols containing a selected length.
- Two Discrete Lengths - Decode only Code 93 symbols containing either of two lengths.
- Length Within Range - Decode Code 93 symbols with a specific length range.
- Any Length - Decode Code 93 symbols containing any number of characters within the scanner's capability.

Select lengths using barcodes in [Numeric Barcodes](#). To correct an error or change the selection, scan [Cancel](#).

For example:

- To decode only Code 93 symbols with 14 characters, scan Code 93 - One Discrete Length, and then scan 1, 4.
- To decode only Code 93 symbols containing either 2 or 14 characters, scan Code 93 - Two Discrete Lengths, and then scan 0, 2, 1, 4.
- To decode Code 93 symbols containing between 4 and 12 characters, scan Code 93 - Length Within Range, and then scan 0, 4, 1, 2.

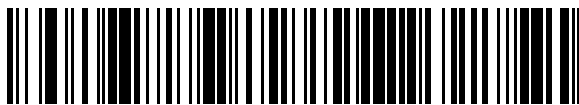

Code 93 - One Discrete Length



Code 93 - Two Discrete Lengths

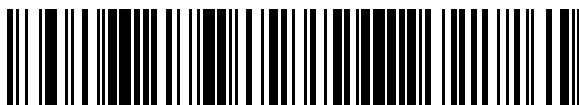

\*Code 93 - Length Within Range (Default: )

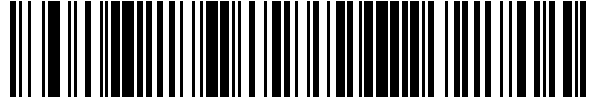

Code 93 - Any Length

## Code 11

### Parameter # 10 (SSI #0Ah)

This parameter enables or disables Code 11.

- \*Enabled - enables Code 11.
- Disabled - disables Code 11.
- .

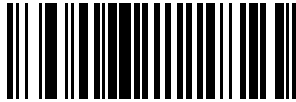

Enable Code 11 (1)

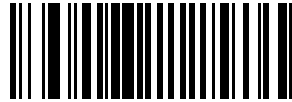

\*Disable Code 11 (0)

## Set Lengths for Code 11

### L1 Parameter # 28 (SSI #1Ch)

### L2 Parameter # 29 (SSI #1Dh)

This parameter set lengths for Code 11.

The length of a code refers to the number of characters (i.e., human readable characters), including check digit(s) the code contains. Set lengths for Code 11 to any length, one or two discrete lengths, or lengths within a specific range. The default is Length Within Range: 4 to 55.



**NOTE:** When setting lengths, enter a leading zero for single digit numbers.

- One Discrete Length - Decode only Code 11 symbols containing a selected length.
- Two Discrete Lengths - Decode only Code 11 symbols containing either of two lengths.
- Length Within Range - Decode Code 11 symbols with a specific length range.
- Any Length - Decode Code 11 symbols containing any number of characters within the scanner's capability.

Select lengths using barcodes in [Numeric Barcodes](#). To correct an error or change the selection, scan [Cancel](#).



For example:

- To decode only Code 11 symbols with 14 characters, scan Code 11 - One Discrete Length, and then scan 1, 4.
- To decode only Code 11 symbols containing either 2 or 14 characters, scan Code 11 - Two Discrete Lengths, and then scan 0, 2, 1, 4.
- To decode Code 11 symbols containing between 4 and 12 characters, scan Code 11 - Length Within Range, and then scan 0, 4, 1, 2.

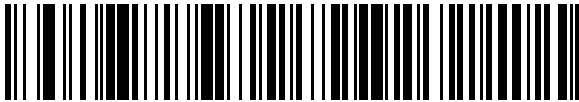

Code 11 - One Discrete Length

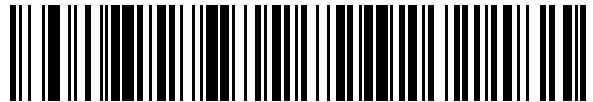

Code 11 - Two Discrete Lengths

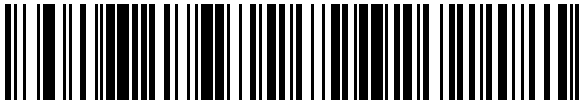

\*Code 11 - Length Within Range (Default: Length Within Range: 1 to 55 )



Code 11 - Any Length

## Code 11 Check Digit Verification

### Parameter # 52 (SSI #34h)

This parameter checks the integrity of all Code 11 symbols to verify that the data complies with specified check digit algorithm.

- \*Disabled - disables Code 11 Check Digit.
- One Check Digit - enables Code 11 to check one digit.
- Two Check Digits - enables Code 11 to check 2 digits.



\*Disable (0)

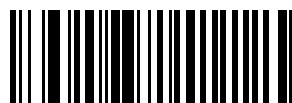

One Check Digit (1)

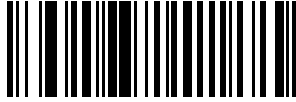

Two Check Digits (2)

## Transmit Code 11 Check Digits

### Parameter # 47 (SSI #2Fh)

This parameter transmits Code 11 data with or without the check digit.

- Enabled - enables Transmit Code 11 Check Digit.
- \*Disabled - disables Transmit Code 11 Check Digit.



**NOTE:** [Code 11 Check Digit Verification](#) must be enabled for this parameter to function.

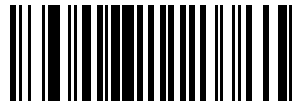

Transmit Code 11 Check Digit(s) (Enable) (1)

\*Do Not Transmit Code 11 Check Digit(s) (Disable)  
(0)

## Interleaved 2 of 5 (I 2 of 5)

### Parameter # 6 (SSI #06h)

This parameter enables or disables I 2 of 5.

- \*Enabled - enables I 2 of 5.
- Disabled - disables I 2 of 5.



\*Enable Interleaved 2 of 5 (1)

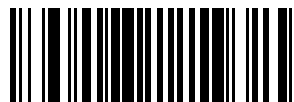

Disable Interleaved 2 of 5 (0)

## Set Lengths for Interleaved 2 of 5 (I 2 of 5)

### L1 Parameter # 22 (SSI #16h)

## L2 Parameter # 23 (SSI #17h)

This parameter set lengths for I 2 of 5.

The length of a code refers to the number of characters (for example, human-readable characters), including check digit(s) the code contains. Set lengths for I 2 of 5 to any length, one or two discrete lengths, or lengths within a specific range. The default is Length Within Range: 6 to 55. The maximum range is 0 - 55.



**NOTE:** When setting lengths, enter a leading zero for single digit numbers.

- One Discrete Length - Decode only I 2 of 5 symbols containing a selected length.
- Two Discrete Lengths - Decode only I 2 of 5 symbols containing either of two lengths.
- Length Within Range - Decode I 2 of 5 symbols with a specific length range.
- Any Length - Decode I 2 of 5 symbols containing any number of characters within the scanner's capability.



**NOTE:** Due to the construction of the I 2 of 5 symbology, it is possible for a scan line covering only a portion of the code to transmit as a complete scan, yielding less data than is encoded in the barcode. To prevent this, select specific lengths (I 2 of 5 - One Discrete Length, Two Discrete Lengths) for I 2 of 5 applications, or increase the [Security Level](#).

Select lengths using barcodes in [Numeric Barcodes](#). To correct an error or change the selection, scan [Cancel](#).

For example:

- To decode only I 2 of 5 symbols with 14 characters, scan I 2 of 5 - One Discrete Length, and then scan 1, 4.
- To decode only I 2 of 5 symbols containing either 2 or 14 characters, scan I 2 of 5 - Two Discrete Lengths, and then scan 0, 2, 1, 4.
- To decode I 2 of 5 symbols containing between 4 and 12 characters, scan I 2 of 5 - Length Within Range, and then scan 0, 4, 1, 2.

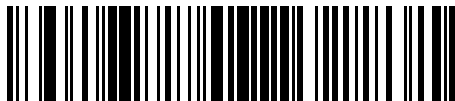

I 2 of 5 - One Discrete Length

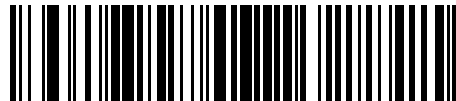

I 2 of 5 - Two Discrete Lengths

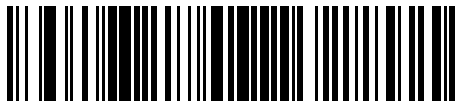

\*I 2 of 5 - Length Within Range (Default: Length Within Range: 6 to 55)

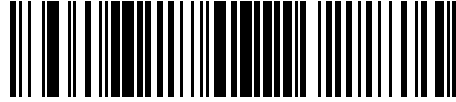

I 2 of 5 - Any Length

## Interleaved 2 of 5 (I 2 of 5) Check Digit Verification

### Parameter # 49 (SSI #31h)

This parameter enables or disables checking the integrity of all I 2 of 5 symbols to verify the data complies with either the specified Uniform Symbology Specification (USS) or the Optical Product Code Council (OPCC) check digit algorithm.

- \*Disable - disables checking the integrity of all I 2 of 5 symbols to verify the data complies.
- USS Check Digit - enables checking the integrity of USS.
- OPCC Check Digit - enables checking the integrity of OPCC.



\*Disable (0)



USS Check Digit (1)



OPCC Check Digit (2)

## Transmit I 2 of 5 Check Digit

### Parameter # 44 (SSI #2Ch)

This parameter enables or disables transmission of I 2 of 5 data with or without the check digit.

- Enabled - enables transmission of check digit.
- \*Disabled - disables transmission of check digit.

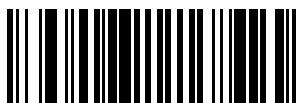

Transmit I 2 of 5 Check Digit (Enable) (1)



\*Do Not Transmit I 2 of 5 Check Digit (Disable) (0)

## Convert Interleaved 2 of 5 (I 2 of 5) to EAN-13

### Parameter # 82 (SSI #52h)

This parameter enables or disables converting 14-character I 2 of 5 codes to EAN-13, and then transmitting to the host as EAN-13.

- Enabled - enables converting 14-character I 2 of 5 codes to EAN-13.
- \*Disabled - disables converting 14-character I 2 of 5 codes to EAN-13.



**NOTE:** The I 2 of 5 code must be enabled, and the code must have a leading zero and a valid EAN-13 check digit.

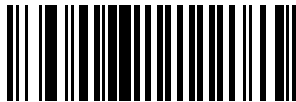

Convert I 2 of 5 to EAN-13 (Enable) (1)



\*Do Not Convert I 2 of 5 to EAN-13 (Disable) (0)

## Interleaved 2 of 5 (I 2 of 5) Security Level

### Parameter # 1121 (SSI #F8h 04h 61h)

This parameter sets the security level for I 2 of 5.

I 2 of 5 barcodes are vulnerable to misdecodes, particularly when I 2 of 5 Lengths is set to Any Length. The scanner offers four levels of decode security for I 2 of 5 barcodes. There is an inverse relationship between security and scanner aggressiveness. Increasing the level of security can reduce scanning aggressiveness, so select only the level of security necessary.

- I 2 of 5 Security Level 0: The scanner operates in its most aggressive state, while providing sufficient security in decoding most in-spec barcodes.
- I 2 of 5 Security Level 1: A barcode must be successfully read twice, and satisfy certain safety requirements before being decoded. This default setting eliminates most misdecodes.
- I 2 of 5 Security Level 2: This option applies greater barcode security requirements if Security Level 1 fails to eliminate misdecodes.
- I 2 of 5 Security Level 3: If you selected Security Level 2, and misdecodes still occur, select this security level. The highest safety requirements are applied. A barcode must be successfully read three times before being decoded.



**NOTE:** Selecting this option is an extreme measure against mis-decoding severely out-of-spec barcodes, and significantly impairs the decoding ability of the scanner. If this level of security is required, try to improve the quality of the barcodes.



I 2 of 5 Security Level 0 (0)

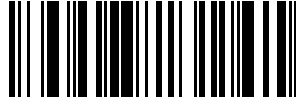

\*I 2 of 5 Security Level 1 (1)



I 2 of 5 Security Level 2 (2)

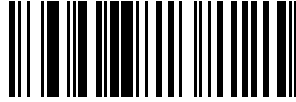

I 2 of 5 Security Level 3 (3)

## Interleaved 2 of 5 (I 2 of 5) Reduced Quiet Zone

### Parameter # 1210 (SSI #F8h 04h B9h)

This parameter enables or disables decoding I 2 of 5 with reduced quiet zones (the margins on either side of the barcode).

If you select Enable, select a [1D Quiet Zone Level](#).

- Enabled - enables I 2 of 5 with reduced Quiet Zones.
- \*Disabled - disables I 2 of 5 with reduced Quiet Zones.

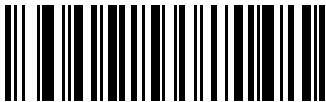

Enable I 2 of 5 Reduced Quiet Zone (1)

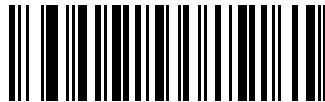

\*Disable I 2 of 5 Reduced Quiet Zone (0)

## Discrete 2 of 5 (D 2 of 5)

### Parameter # 5 (SSI #05h)

This parameter enables or disables D 2 of 5.

- Enabled - enables D 2 of 5.
- \*Disabled - disables D 2 of 5.



Enable Discrete 2 of 5 (1)

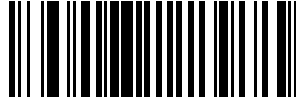

\*Disable Discrete 2 of 5 (0)

## Set Lengths for Discrete 2 of 5 (D 2 of 5)

L1 Parameter # 20 (SSI #14h)

L2 Parameter # 21 (SSI #15h)

This parameter set lengths for D 2 of 5.

The length of a code refers to the number of characters (for example, human-readable characters), including check digit(s) the code contains. Set lengths for D 2 of 5 to any length, one or two discrete lengths, or lengths within a specific range. The default is Length Within Range: 1 to 55. The maximum range is 1 - 55.



**NOTE:** When setting lengths, enter a leading zero for single digit numbers.

Scan one of the following barcodes to select a length option:

- One Discrete Length - Decode only D 2 of 5 symbols containing a selected length.
- Two Discrete Lengths - Decode only D 2 of 5 symbols containing either of two lengths.
- Length Within Range - Decode D 2 of 5 symbols with a specific length range.
- Any Length - Decode D 2 of 5 symbols containing any number of characters within the scanner's capability.



**NOTE:** Due to the construction of the D 2 of 5 symbology, it is possible for a scan line covering only a portion of the code to transmit as a complete scan, yielding less data than is encoded in the barcode. To prevent this, select specific lengths (D 2 of 5 - One Discrete Length, Two Discrete Lengths) for D 2 of 5 applications.

Select lengths using barcodes in [Numeric Barcodes](#). To correct an error or change the selection, scan [Cancel](#).

For example:

- To decode only D 2 of 5 symbols with 14 characters, scan D 2 of 5 - One Discrete Length, and then scan 1, 4.
- To decode only D 2 of 5 symbols containing either 2 or 14 characters, scan D 2 of 5 - Two Discrete Lengths, and then scan 0, 2, 1, 4.
- To decode D 2 of 5 symbols containing between 4 and 12 characters, scan D 2 of 5 - Length Within Range, and then scan 0, 4, 1, 2.



D 2 of 5 - One Discrete Length

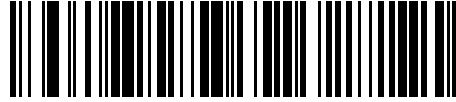

D 2 of 5 - Two Discrete Lengths



\*D 2 of 5 - Length Within Range (Default: Length Within Range: 1 to 55 )

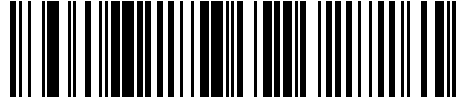

D 2 of 5 - Any Length

## Codabar (NW - 7)

### Parameter # 7 (SSI #07h)

This parameter enables or disables Codabar.

- \*Enabled - enables Codabar.
- Disabled - disables Codabar.

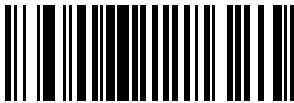

\*Enable Codabar (1)

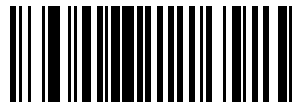

Disable Codabar (0)

## Set Lengths for Codabar

### L1 Parameter # 24 (SSI #18h)

### L2 Parameter # 25 (SSI #19h)

This parameter set lengths for Codabar.

The length of a code refers to the number of characters (for example, human-readable characters), including check digit(s) the code contains. Set lengths for Codabar to any length, one or two discrete lengths, or lengths within a specific range. The default is Length Within Range: 4 to 55.



**NOTE:** When setting lengths, enter a leading zero for single-digit numbers.

- One Discrete Length - Decode only Codabar symbols containing a selected length.
- Two Discrete Lengths - Decode only Codabar symbols containing either of two lengths.



- Length Within Range - Decode Codabar symbols with a specific length range.
- Any Length - Decode Codabar symbols containing any number of characters within the scanner's capability.

Select lengths using barcodes in [Numeric Barcodes](#). To correct an error or change the selection, scan [Cancel](#).

For example:

- To decode only Codabar symbols with 14 characters, scan Codabar - One Discrete Length, and then scan 1, 4.
- To decode only Codabar symbols containing either 2 or 14 characters, scan Codabar - Two Discrete Lengths, and then scan 0, 2, 1, 4.
- To decode Codabar symbols containing between 4 and 12 characters, scan Codabar - Length Within Range, and then scan 0, 4, 1, 2.



Codabar - One Discrete Length

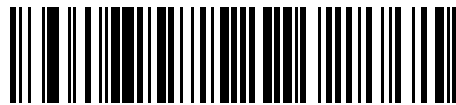

Codabar - Two Discrete Lengths

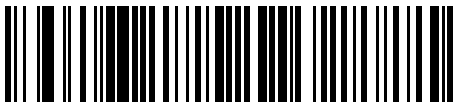

\*Codabar - Length Within Range (Default: Length Within Range: 4 to 55 )

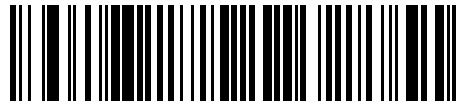

Codabar - Any Length

## CLSI Editing

### Parameter # 54 (SSI #36h)

This parameter enables or disables CLSI editing.

Select Enable CLSI Editing to strip the start and stop characters and insert a space after the first, fifth, and tenth characters of a 14-character Codabar symbol if the host system requires this data format.

- Enabled - enables CLSI editing.
- \*Disabled - disables CLSI editing.



**NOTE:** Symbol length does not include start and stop characters.

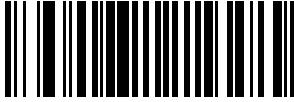

Enable CLSI Editing (1)

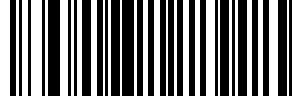

\*Disable CLSI Editing (0)

## NOTIS Editing

### Parameter # 55 (SSI #37h)

This parameter enables or disables NOTIS editing which strips the start and stop characters from a decoded Codabar symbol if the host system requires this data format.

- Enabled - enables NOTIS editing.
- \*Disabled - disables NOTIS editing.

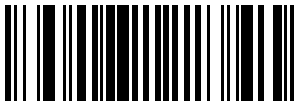

Enable NOTIS Editing (1)

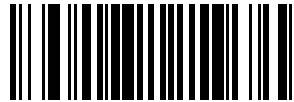

\*Disable NOTIS Editing (0)

## Codabar Security Level

### Parameter # 1776 (SSI #F8h 06h F0h)

This parameter sets the security level for Codabar 39.

The scanner offers four levels of decode security for Codabar barcodes. There is an inverse relationship between security and scanner aggressiveness. Increasing the level of security can reduce scanning aggressiveness, so select only the level of security necessary.

- Codabar Security Level 0: This setting allows the scanner to operate in its most aggressive state, while providing sufficient security in decoding most in-spec barcodes.
- Codabar Security Level 1: This default setting eliminates most misdecodes.
- Codabar Security Level 2: Select this option with greater barcode security requirements if Security Level 1 fails to eliminate misdecodes.
- Codabar Security Level 3: If you selected Security Level 2, and misdecodes still occur, select this security level to apply the highest safety requirements.



**NOTE:** Selecting this option is an extreme measure against mis-decoding severely out-of-spec barcodes, and significantly impairs the decoding ability of the scanner. If this level of security is required, try to improve the quality of the barcodes.



Codabar Security Level 0 (0)

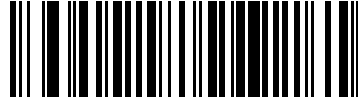

\*Codabar Security Level 1 (1)



Codabar Security Level 2 (2)

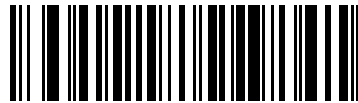

Codabar Security Level 3 (3)

## Codabar Upper or Lower Case Start/Stop Characters

### Parameter # 855 (SSI #F2h 57h)

This parameter selects whether to transmit upper case or lower case Codabar start/stop characters.

- Lower Case (1) - enables lower case start/stop characters.
- \*Upper Case (0) - enables upper case start/stop characters.

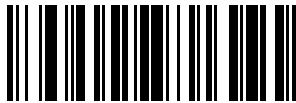

Lower Case (1)



\*Upper Case (0)

## Codabar Mod 16 Check Digit Verification

### Parameter # 1784 (SSI #F8h 06h F8h)

This parameter checks the Codabar Mod 16 check digit to verify that the data complies with the specified check digit algorithm.

- Enabled - enables check digit.
- \*Disabled - disables check digit.



Enable Codabar Mod 16 Check digit (1)



\*Disable Codabar Mod 16 Check digit (0)

## Transmit Codabar Check Digit

### Parameter # 704 (SSI #F1h C0h)

This parameter selects whether or not to transmit the Codabar check digit(s).

- Enabled - enables check digit transmission.
- \*Disabled - disables check digit transmission.

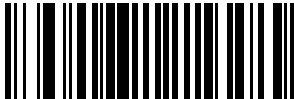

Enable Codabar Check Digit Transmission (1)



\*Disable Codabar Check Digit Transmission (0)

## MSI

### Parameter # 11 (SSI #0Bh)

This parameter enables or disables MSI.

- Enabled - enables MSI.
- \*Disabled - disables MSI.



Enable MSI (1)



\*Disable MSI (0)

## Set Lengths for MSI

L1 Parameter # 30 (SSI #1Eh)

L2 Parameter # 31 (SSI #1Fh)

This parameter set lengths for MSI.

The length of a code refers to the number of characters (for example, human-readable characters), including check digit(s) the code contains. Set lengths for MSI to any length, one or two discrete lengths, or lengths within a specific range. The default is Length Within Range: 4 to 55.



**NOTE:** When setting lengths, enter a leading zero for single-digit numbers.

Scan one of the following barcodes to select a length option:

- One Discrete Length - Decode only MSI symbols containing a selected length.
- Two Discrete Lengths - Decode only MSI symbols containing either of two lengths.
- Length Within Range - Decode MSI symbols with a specific length range.
- Any Length - Decode MSI symbols containing any number of characters within the scanner's capability.



**NOTE:** Due to the construction of the MSI symbology, it is possible for a scan line covering only a portion of the code to transmit as a complete scan, yielding less data than is encoded in the barcode. To prevent this, select specific lengths (MSI - One Discrete Length, Two Discrete Lengths) for MSI applications.

Select lengths using barcodes in [Numeric Barcodes](#). To correct an error or change the selection, scan [Cancel](#).

For example:

- To decode only MSI symbols with 14 characters, scan MSI - One Discrete Length, and then scan 1, 4.
- To decode only MSI symbols containing either 2 or 14 characters, scan MSI - Two Discrete Lengths, and then scan 0, 2, 1, 4.
- To decode MSI symbols containing between 4 and 12 characters, scan MSI - Length Within Range, and then scan 0, 4, 1, 2.

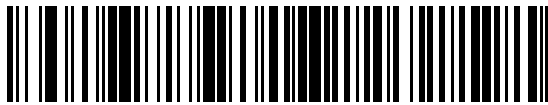

MSI - One Discrete Length

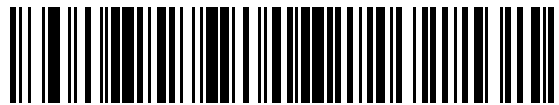

MSI - Two Discrete Lengths

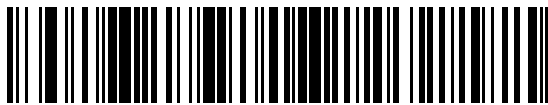

\*MSI - Length Within Range (Default: Length Within Range: 4 to 55)

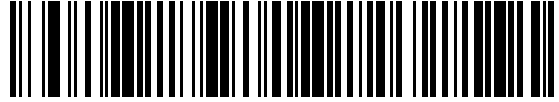

MSI - Any Length

## MSI Check Digits

### Parameter # 50 (SSI #32h)

This parameter checks the MSI check digit to verify that the data complies with the specified check digit algorithm.

With MSI symbols, one check digit is mandatory and always verified by the reader. The second check digit is optional. If the MSI codes include two check digits, select the Two MSI Check Digits option to enable verification of the second check digit.

- 0 - Does not check the MSI check digit; decodes MSI with no check digit.
- 1 - This is for MSI barcodes with one check digit. This is the default.
- 2 - This is for MSI barcodes with two check digits.

See [MSI Check Digit Algorithm](#) to select second digit algorithms.



No MSI Check Digit (0)



\*One MSI Check Digits (1)



Two MSI Check Digit (2)

## Transmit MSI Check Digit(s)

### Parameter # 46 (SSI #2Eh)

This parameter transmits MSI data with or without the check digit.

- Enabled - transmits MSI data with check digit.
- \*Disabled - does not transmit MSI data check digit.

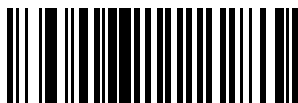

Transmit MSI Check Digit(s) (Enable) (1)

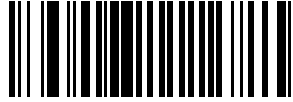

\*Do Not Transmit MSI Check Digit(s) (Disable) (0)

## MSI Check Digit Algorithm

### Parameter # 51 (SSI #33h)

This parameter selects the algorithm used to encode the check digit.

Two algorithms are available for verifying the second MSI check digit. Select one of the following options to select the algorithm used to encode the check digit.

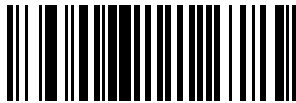

MOD 11/MOD 10 (0)

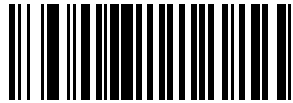

\*MOD 10/MOD 10 (1)

## Chinese 2 of 5

### Parameter # 408 (SSI #98h)

This parameter enables or disables Chinese 2 of 5.

- Enabled - enables Chinese 2 of 5.
- \*Disabled - disables Chinese 2 of 5.



Enable Chinese 2 of 5 (1)

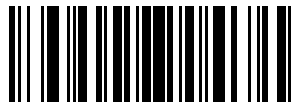

\*Disable Chinese 2 of 5 (0)

## Matrix 2 of 5

### Parameter # 618 (SSI #F1h 6Ah)

This parameter enables or disables Matrix 2 of 5.

- Enabled - enables Matrix 2 of 5.

- \*Disabled - disables Matrix 2 of 5.



Enable Matrix 2 of 5 (1)



\*Disable Matrix 2 of 5 (0)

## Set Lengths for Matrix 2 of 5

**L1 Parameter # 619 (SSI #F1h 6Bh)**

**L2 Parameter # 620 (SSI #F1h 6Ch)**

This parameter set lengths for Matrix 2 of 5.

The length of a code refers to the number of characters (for example, human-readable characters), including check digit(s) the code contains. Set lengths for Matrix 2 of 5 to any length, one or two discrete lengths, or lengths within a specific range. The default is One Discrete Length: 4 to 55.



**NOTE:** When setting lengths, enter a leading zero for single-digit numbers.

Scan one of the following barcodes to select a length option:

- One Discrete Length - Decode only Matrix 2 of 5 symbols containing a selected length.
- Two Discrete Lengths - Decode only Matrix 2 of 5 symbols containing either of two lengths.
- Length Within Range - Decode Matrix 2 of 5 symbols with a specific length range.
- Any Length - Decode Matrix 2 of 5 symbols containing any number of characters within the scanner's capability.

Select lengths using barcodes in [Numeric Barcodes](#). To correct an error or change the selection, scan [Cancel](#).

For example:

- To decode only Matrix 2 of 5 symbols with 14 characters, scan Matrix 2 of 5 - One Discrete Length, and then scan 1, 4.
- To decode only Matrix 2 of 5 symbols containing either 2 or 14 characters, scan Matrix 2 of 5 - Two Discrete Lengths, and then scan 0, 2, 1, 4.
- To decode Matrix 2 of 5 symbols containing between 4 and 12 characters, scan Matrix 2 of 5 - Length Within Range, and then scan 0, 4, 1, 2.



Matrix 2 of 5 - One Discrete Length





Matrix 2 of 5 - Two Discrete Lengths

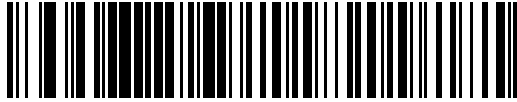

\*Matrix 2 of 5 - Length Within Range (Default: )



Matrix 2 of 5 - Any Length

## Matrix 2 of 5 Check Digit

### Parameter # 622 (SSI #F1h 6Eh)

This parameter determines whether to include the Matrix 2 of 5 check digit with the barcode data.

The check digit is the last character of the symbol used to verify the integrity of the data.

- Enabled - enables Matrix 2 of 5 Check Digit.
- \*Disabled - disables Matrix 2 of 5 Check Digit.

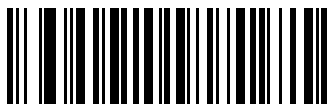

Enable Matrix 2 of 5 Check Digit (1)

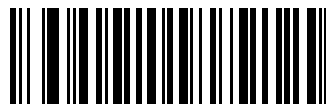

\*Disable Matrix 2 of 5 Check Digit (0)

## Transmit Matrix 2 of 5 Check Digit

### Parameter # 623 (SSI #F1h 6Fh)

This parameter transmits Matrix 2 of 5 data with or without the check digit.

- Transmit - enables Transmit Matrix 2 of 5 Check Digit.
- \*Do Not Transmit - does not Transmit Matrix 2 of 5 Check Digit.

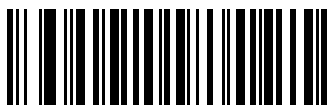

Transmit Matrix 2 of 5 Check Digit (1)



\*Do Not Transmit Matrix 2 of 5 Check Digit (0)

## Korean 3 of 5

### Parameter # 581 (SSI #F1h 45h)

This parameter enables or disables Korean 3 of 5.

- Enabled - enables Korean 3 of 5.
- \*Disabled - disables Korean 3 of 5.



**NOTE:** The length for Korean 3 of 5 is fixed at 6.

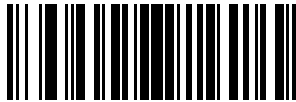

Enable Korean 3 of 5 (1)

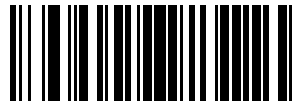

\*Disable Korean 3 of 5 (0)

## Inverse 1D

### Parameter # 586 (SSI #F1h 4Ah)

This parameter sets the 1D inverse decoder setting.

- Regular Only - The scanner decodes regular 1D barcodes only.
- Inverse Only - The scanner decodes inverse 1D barcodes only.
- Inverse Autodetect - The scanner decodes both regular and inverse 1D barcodes.



**NOTE:** This parameter does not apply to GS1 DataBarcode types.



**NOTE:** The Inverse 1D setting may impact Composite or Inverse Composite decoding.



\*Regular (0)



Inverse Only (1)



Inverse Autodetect (2)

## GS1 DataBar

The variants of GS1 DataBar are DataBar Omnidirectional, DataBar Limited, and DataBar Expanded. The limited and expanded versions have stacked variants. Choose to enable or disable each variant of the GS1 DataBar.

### GS1 DataBar Omnidirectional (formerly GS1 DataBar-14)

#### Parameter # 338 (SSI #F0h 52h)

This parameter enables or disables GS1 DataBar Omnidirectional.

- \*Enabled - enables GS1 DataBar Omnidirectional.
- Disabled - disables GS1 DataBar Omnidirectional.



\*Enable GS1 DataBar Omnidirectional (1)

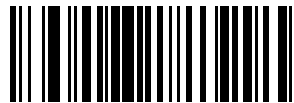

Disable GS1 DataBar Omnidirectional (0)

### GS1 DataBar Limited

#### Parameter # 339 (SSI #F0h 53h)

This parameter enables or disables GS1 DataBar Limited.

- \*Enabled - enables GS1 DataBar Limited.
- Disabled - disables GS1 DataBar Limited.

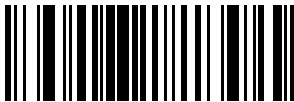

\*Enable GS1 DataBar Limited (1)

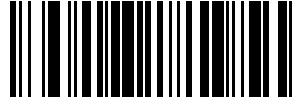

Disable GS1 DataBar Limited (0)

## GS1 DataBar Expanded

### Parameter # 340 (SSI #F0h 54h)

This parameter enables or disables GS1 DataBar Expanded.

- \*Enabled - enables GS1 DataBar Expanded.
- Disabled - disables GS1 DataBar Expanded.

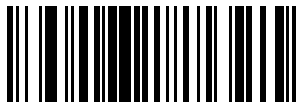

\*Enable GS1 DataBar Expanded (1)

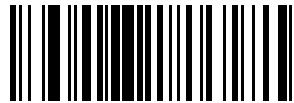

Disable GS1 DataBar Expanded (0)

## Convert GS1 DataBar to UPC/EAN/JAN

### Parameter # 397 (SSI #F0h, 8Dh)

This parameter enables or disables Convert GS1 DataBar to UPC/EAN/JAN.

- Enabled - enables Convert GS1 DataBar to UPC/EAN/JAN.
- \*Disabled - disables Convert GS1 DataBar to UPC/EAN/JAN.

This parameter only applies to GS1 DataBar Omnidirectional and GS1 DataBar Limited symbols not decoded as part of a Composite symbol. Enable Convert GS1 DataBar to UPC/EAN/JAN strips the leading '010' from DataBar Omnidirectional and DataBar Limited symbols encoding a single zero as the first digit, and then reports as EAN-13.

For barcodes beginning with between two and five zeros, this strips the leading '0100' and reports the barcode as UPC-A. The [UPC-A Preamble](#) option that transmits the system character and country code applies to converted barcodes. Note that neither the system character nor the check digit can be stripped.



Enable Convert GS1 DataBar to UPC/EAN/JAN (1)



\*Disable Convert GS1 DataBar to UPC/EAN/JAN (0)

## GS1 DataBar Security Level

### Parameter # 1706 (SSI #F8h 06h AAh)

This parameter sets the security level for GS1 DataBar.

The scanner offers four levels of decode security for GS1 DataBar (GS1 DataBar Omnidirectional, GS1 DataBar Limited, GS1 DataBar Expanded) barcodes.

- Security Level 0 - The scanner operates in its most aggressive state, while providing sufficient security decoding most in-spec barcodes.
- Security Level 1 - This setting eliminates most misdecodes while maintaining reasonable aggressiveness.
- Security Level 2 - Select this option with greater barcode security requirements if Security Level 1 fails to eliminate misdecodes.
- \*Security Level 3 - If you selected Security Level 2 and misdecodes still occur, select this security level to apply the highest safety requirements.

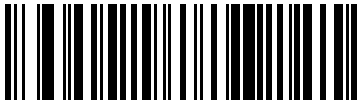

GS1 DataBar Security Level 0 (0)



GS1 DataBar Security Level 1 (1)



GS1 DataBar Security Level 2 (2)



\*GS1 DataBar Security Level 3 (3)

## GS1 DataBar Expanded Security Level

### Parameter # 1707 (SSI #F8h 06h ABh)

This parameter set the expanded security level for GS1 DataBar.

The scanner offers four levels of decode security for GS1 DataBar Expanded:

- Security Level 0 - The scanner operates in its most aggressive state, while providing sufficient security decoding most in-spec barcodes.
- \*Security Level 1 - This setting eliminates most misdecodes while maintaining reasonable aggressiveness.
- Security Level 2 - Select this option with greater barcode security requirements if Security Level 1 fails to eliminate misdecodes.

- Security Level 3 - If you selected Security Level 2 and misdecodes still occur, select this security level to apply the highest safety requirements.



GS1 DataBar Expanded Security Level 0 (0)



\*GS1 DataBar Expanded Security Level 1 (1)



GS1 DataBar Expanded Security Level 2 (2)



GS1 DataBar Expanded Security Level 3 (3)

## Symbology-Specific Security Features

These security features are unique to the Symbology section.

### Redundancy Level

#### Parameter # 78 (SSI #4Eh)

This parameter selects the redundancy level appropriate for the barcode quality.

Select higher redundancy levels for decreasing levels of barcode quality. As redundancy levels increase, the scanner's aggressiveness decreases.

- \*Redundancy Level 1 - The scanner must read the following code types twice before decoding:
  - Codabar (8 characters or less)
  - MSI (4 characters or less)
  - D 2 of 5 (8 characters or less)
  - I 2 of 5 (8 characters or less)
- Redundancy Level 2 - The scanner must read all code types twice before decoding.

- Redundancy Level 3 - The scanner must read code types other than the following twice before decoding, but must read the following codes three times:
  - Codabar (8 characters or less)
  - MSI (4 characters or less)
  - D 2 of 5 (8 characters or less)
  - I 2 of 5 (8 characters or less)
- Redundancy Level 4 - The scanner must read all code types three times before decoding.

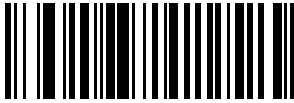

\*Redundancy Level 1 (1)



Redundancy Level 2 (2)

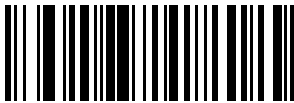

Redundancy Level 3 (3)



Redundancy Level 4 (4)

## Security Level

### Parameter # 77 (SSI #4Dh)

This parameter sets the security level.

The scanner offers four levels of decode security, which include the Code 128 family, UPC/EAN/JAN, and Code 93. Select increasing levels of security for decreasing levels of scanning quality. There is an inverse relationship between security and scanner aggressiveness, so choose only that level of security necessary for the application.

- Security Level 0 - The scanner operates in its most aggressive state, while providing sufficient security decoding most in-spec barcodes.
- Security Level 1 - This default setting eliminates most mis-decodes.
- Security Level 2 - Select this option if Security Level 1 fails to eliminate mis-decodes.
- Security Level 3 - If you selected Security Level 2 and mis-decodes still occur, select this security level.



**NOTE:** Selecting this option is an extreme measure against mis-decoding severely out-of-spec barcodes, and significantly impairs the decoding ability of the scanner. If this level of security is required, try to improve the quality of the barcodes.

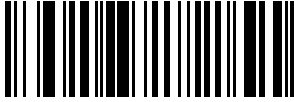

Security Level 0 (0)

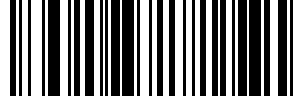

\*Security Level 1 (1)

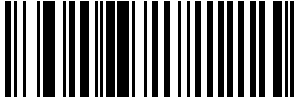

Security Level 2 (2)

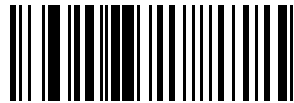

Security Level 3 (3)

## 1D Quiet Zone Level

### Parameter # 1288 (SSI #F8h 05h 08h)

This parameter sets the level of aggressiveness when setting a reduced quiet zone (the margin on either side of a barcode), and applies to symbologies enabled by a Reduced Quiet Zone parameter.

Because higher levels increase the decoding time and risk of mis-decodes, Zebra strongly recommends enabling only the symbologies which require higher quiet zone levels, and leaving Reduced Quiet Zone disabled for all other symbologies. Options are:

- 1D Quiet Zone Level 0 - The scanner performs normally in terms of quiet zone.
- \*1D Quiet Zone Level 1 - The scanner performs more aggressively in terms of quiet zone.
- 1D Quiet Zone Level 2 - The scanner only requires a quiet zone at the end of barcode for decoding.
- 1D Quiet Zone Level 3 - The scanner decodes anything in terms of quiet zone or end of barcode.



1D Quiet Zone Level 0 (0)

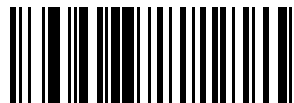

\*1D Quiet Zone Level 1 (1)



1D Quiet Zone Level 2 (2)



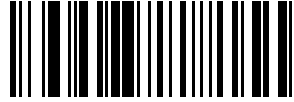

1D Quiet Zone Level 3 (3)

## Intercharacter Gap Size

### Parameter # 381 (SSI #F0h 7Dh)

This parameter enables a device to tolerate large intercharacter gap sizes.

The Code 39 and Codabar symbologies have an intercharacter gap that is typically quite small. Due to various barcode printing technologies, this gap can grow larger than the maximum size allowed, preventing the scanner from decoding the symbol. If this problem occurs, scan the Large Intercharacter Gaps parameter to tolerate these out-of-specification barcodes.

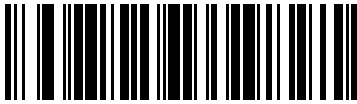

\*Normal Intercharacter Gaps (6)

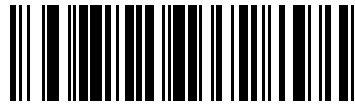

Large Intercharacter Gaps (10)

## Composite

Composites link symbols or barcodes together and they are read by a scanner as one object.

### Composite CC-C

#### Parameter # 341 (SSI #F0h 55h)

This parameter enables or disables Composite barcodes of type CC-C.

- Enabled - enables CC-C.
- \*Disabled - disables CC-C.

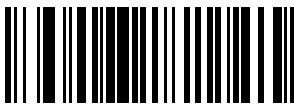

Enable CC-C (1)

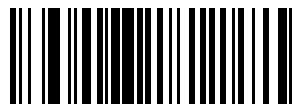

\*Disable CC-C (0)

## Composite CC-A/B

### Parameter # 342 (SSI #F0h 56h)

This parameter enables or disables CC-A/B.

- Enabled - enables CC-A/B.
- \*Disabled - disables CC-A/B.

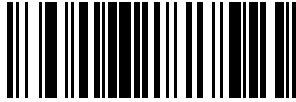

Enable CC-A/B (1)

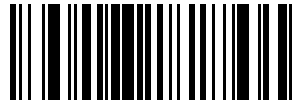

\*Disable CC-A/B (0)

## Composite TLC-39

### Parameter # 371 (SSI #F0h 73h)

This parameter enables or disables TLC-39.

- Enabled - enables TLC-39.
- \*Disabled - disables TLC-39.

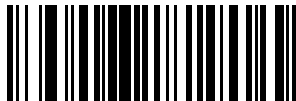

Enable TLC39 (1)

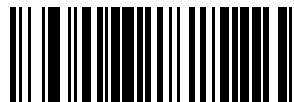

\*Disable TLC39 (0)

## UPC Composite Mode

### Parameter # 344 (SSI #F0h 58h)

This parameter links UPC symbols with a 2D symbol during transmission as if they were one symbol.

- \*UPC Never Linked - Transmit UPC barcodes regardless of whether a 2D symbol is detected.
- UPC Always Linked - Transmit UPC barcodes and the 2D portion. If 2D is not present, do not transmit the barcode.
- Autodiscriminate UPC Composites - The scanner determines if there is a 2D portion, then transmits the UPC, as well as the 2D portion if present.

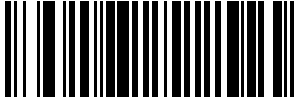

\*UPC Never Linked (0)

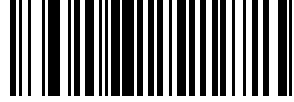

UPC Always Linked (1)

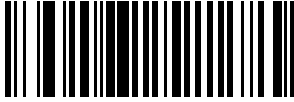

Autodiscriminate UPC Composites (2)

## Composite Beep Mode

### Parameter # 398 (SSI #F0h 8Eh)

This parameter selects the number of decode beeps that sound upon decoding a Composite.

- Single Beep - after both are decoded.
- \*Beep for each code type - as each code type is decoded.
- Double Beep - after both are decoded.



Single Beep After Both are Decoded (0)

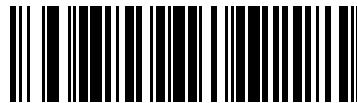

\*Beep as Each Code Type is Decoded (1)



Double Beep After Both are Decoded (2)

## GS1-128 Emulation Mode for UCC/EAN Composite Codes

### Parameter # 427 (SSI #F0h ABh)

This parameter enables or disables GS1-128 Emulation Mode for UCC/EAN Composite Codes.

- Enabled - enables GS1-128 Emulation Mode for UCC/EAN Composite Codes.
- \*Disabled - disables GS1-128 Emulation Mode for UCC/EAN Composite Codes.



Enable GS1-128 Emulation Mode for UCC/EAN Composite Codes (1)

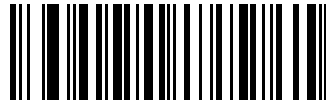

\*Disable GS1-128 Emulation Mode for UCC/EAN Composite Codes (0)

## 2D Symbologies

The following parameters are specific to 2D Symbologies.

### PDF417

#### Parameter # 15 (SSI 0Fh)

This parameter enables or disables PDF417.

- \*Enabled - enables PDF417.
- Disabled - disables PDF417.



\*Enable PDF417 (1)

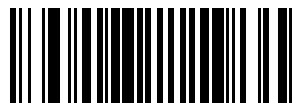

Disable PDF417 (0)

### MicroPDF417

#### Parameter # 227 (SSI #E3h)

This parameter enables or disables MicroPDF417

- Enabled - enables MicroPDF417.
- \*Disabled - disables MicroPDF417.



Enable MicroPDF417 (1)

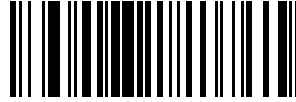

\*Disable MicroPDF417 (0)

## Code 128 Emulation

### Parameter # 123 (SSI #7Bh)

This parameter transmits data from certain MicroPDF417 symbols as Code 128.

You must enable [AIM Code Characters](#) for this parameter to work.

Enable Code 128 Emulation to transmit these MicroPDF417 symbols with one of the following prefixes:

]C1 if the first codeword is 903–905

]C2 if the first codeword is 908 or 909

]C0 if the first codeword is 910 or 911

Disable Code 128 Emulation to transmit these MicroPDF417 symbols with one of the following prefixes:

]L3 if the first codeword is 903–905

]L4 if the first codeword is 908 or 909

]L5 if the first codeword is 910 or 911



**NOTE:** Linked MicroPDF codewords 906, 907, 912, 914, and 915 are not supported. Use GS1 Composites instead.



Enable Code 128 Emulation (1)

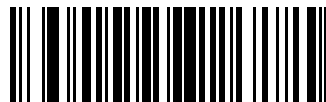

\*Disable Code 128 Emulation (0)

## Data Matrix

### Parameter # 292 (SSI #F0h 24h)

This parameter enables or disables Data Matrix.

- \*Enabled - enables Data Matrix.
- Disabled - disables Data Matrix.

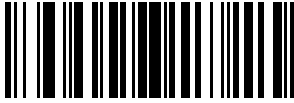

\*Enable Data Matrix (1)



Disable Data Matrix (0)

## GS1 Data Matrix

### Parameter # 1336 (SSI #F8h 05h 38h)

This parameter enables or disables GS1 Data Matrix.

- Enabled - enables GS1 Data Matrix.
- \*Disabled - disables GS1 Data Matrix.

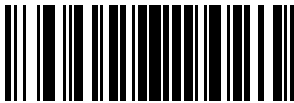

Enable GS1 Data Matrix (1)

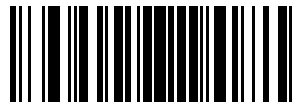

\*Disable GS1 Data Matrix (0)

## Data Matrix Inverse

### Parameter # 588 (SSI #F1h 4Ch)

This parameter selects the Data Matrix inverse decoder setting.

- Regular Only - The scanner decodes regular Data Matrix barcodes only.
- Inverse Only - The scanner decodes inverse Data Matrix barcodes only.
- \*Inverse Autodetect - The scanner decodes both regular and inverse Data Matrix barcodes.



Regular Only (0)



Inverse Only (1)



\*Inverse Autodetect (2)

## Maxicode

### Parameter # 294 (SSI #F0h 26h)

This parameter enables or disables Maxicode.

- Enabled - enables Maxicode.
- \*Disabled - disables Maxicode.

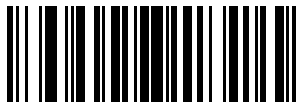

Enable Maxicode (1)

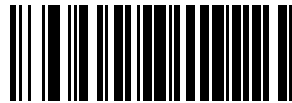

\*Disable Maxicode (0)

## QR Code

### Parameter # 293 (SSI #F0h 25h)

This parameter enables or disables QR Code.

- \*Enabled - enables QR Code.
- Disabled - disables QR Code.



**NOTE:** Enabling this also enables QR Mirrored and Linked QR.



\*Enable QR Code (1)

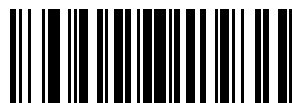

Disable QR Code (0)

## GS1 QR

### Parameter # 1343 (SSI #F8h 05h 3Fh)

This parameter enables or disables GS1 QR.

- Enabled\* - enables GS1 QR
- Disabled - disables GS1 QR.

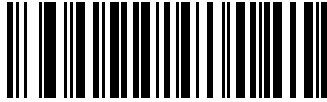

Enable\* GS1 QR (1)



Disable GS1 QR (0)

## QR Inverse

### Parameter # 587 (SSI #F1h 4Bh)

This parameter sets the QR inverse decoder setting.

- \*Regular Only - The scanner decodes regular QR barcodes only.
- Inverse Only - The scanner decodes inverse QR barcodes only.
- Inverse Autodetect - The scanner decodes both regular and inverse QR barcodes.

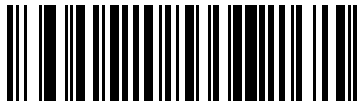

\*Regular Only (0)



Inverse Only (1)



Inverse Autodetect (2)

## MicroQR

### Parameter # 573 (SSI #F1h 3Dh)

This parameter enables or disables MicroQR.

- \*Enabled - enables MicroQR.



- Disabled - disables MicroQ.



\*Enable MicroQR (1)

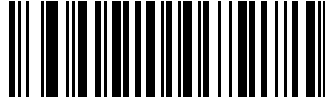

Disable MicroQR (0)

## Linked QR Mode

### Parameter # 1847 (SSI #737h)

This parameter selects a linked QR mode.

- \*Linked QR Only - The scanner does not decode individual QR symbols from a set of linked QR codes.
- Individual QR With Headers - The scanner decodes individual QR symbols from a set of linked QR codes and retains the header information and data.
- Individual QR No Headers - The scanner decodes individual QR symbols from a set of linked QR codes and transmits the data without header information.

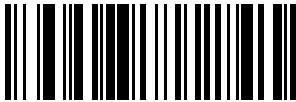

\*Linked QR Only (0)

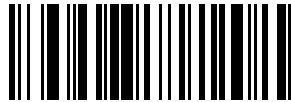

Individual QR With Headers (1)



Individual QR No Headers (2)

## Aztec

### Parameter # 574 (SSI #F1h 3Eh)

This parameter enables or disables Aztec.

- \*Enabled - enables Aztec.
- Disabled - disables Aztec.



**NOTE:** Enabling this also enables Linked Aztec.

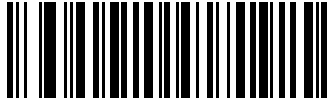

\*Enable Aztec (1)

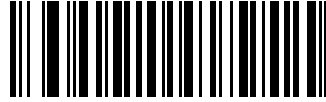

Disable Aztec (0)

## Aztec Inverse

### Parameter # 589 (SSI #F1h 4Dh)

This parameter selects the Aztec inverse decoder setting.

- Regular Only - The scanner decodes regular Aztec barcodes only.
- Inverse Only - The scanner decodes inverse Aztec barcodes only.
- \*Inverse Autodetect - The scanner decodes both regular and inverse Aztec barcodes.



Regular Only (0)

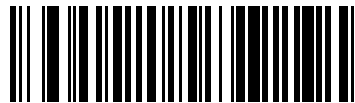

Inverse Only (1)



\*Inverse Autodetect (2)

## Han Xin

### Parameter # 1167 (SSI #F8h 04h 8Fh)

This parameter enables or disables Han Xin.

- Enabled - enables Han Xin.
- \*Disabled - disables Han Xin.



Enable Han Xin (1)

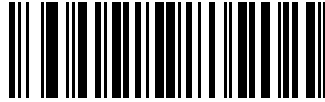

\*Disable Han Xin (0)

## Han Xin Inverse

### Parameter # 1168 (SSI #F8h 04h 90h)

This parameter selects a Han Xin inverse decoder setting.

- \*Regular Only - The scanner decodes Han Xin barcodes with normal reflectance only.
- Inverse Only - The scanner decodes Han Xin barcodes with inverse reflectance only.
- Inverse Autodetect - The scanner decodes both regular and inverse Han Xin barcodes.

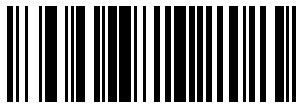

\*Regular Only (0)

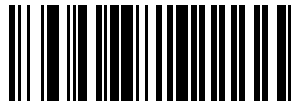

Inverse Only (1)

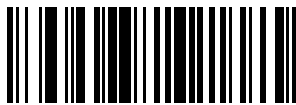

Inverse Autodetect (2)

## Grid Matrix

### Parameter # 1718 (SSI #F8 06h B6h)

This parameter enables or disables Grid Matrix.

- Enabled - enables Grid Matrix.
- \*Disabled - disables Grid Matrix.



Enable Grid Matrix (1)



\*Disable Grid Matrix (0)

## DotCode

### Parameter # 1906 (SSI #F8 07 72h)

You can enable or disable DotCode.

- Enabled - enables DotCode.
- \*Disabled - disables DotCode.



\*Disable DotCode

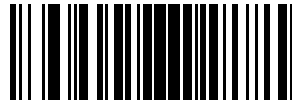

Enable Dotcode

## DotCode Prioritize

### Parameter # 1937 (SSI #F8 07 91h)

This parameter enables or disables giving priority to DotCode decoding versus other symbologies.

- Disabled - disables DotCode as a priority.
- \*Enabled - enables DotCode as a priority.

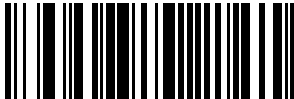

Disable

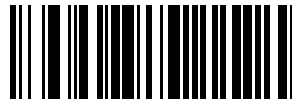

\*Enable

## DotCode Inverse

### Parameter # 1907 (SSI #F8 07 73h)

This parameter selects the DotCode Inverse decoder setting.

- Regular Only - the device decodes DotCode Inverse codes with normal reflectance only.
- Inverse Only - the device decodes DotCode Inverse codes with inverse reflectance only.
- Inverse Autodetect - the device decodes DotCode Inverse codes with both normal and inverse reflectance.

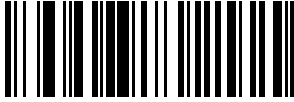

Regular (0)



Inverse Only (1)



\*Autodetect (2)

## DotCode Mirrored

### Parameter # 1908 (SSI #F8 07 74h)

This parameter sets a DotCode Mirror decoder setting.

- Never - decodes non-mirrored DotCode codes only.
- Always - decodes mirrored DotCode codes only.
- \*Autodetect - decodes both mirrored and non-mirrored DotCode codes.

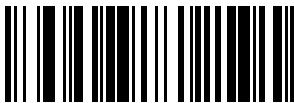

Never (0)

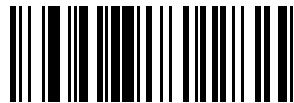

Always (1)



\*Autodetect

## Macro PDF Features

Macro PDF is a special feature for combining multiple PDF symbols into one file. The scanner can decode symbols encoded with this feature, and can store more than 64 Kb of decoded data from up to 50 MacroPDF symbols.

When printing, keep each Macro PDF sequence separate, as each sequence has unique identifiers. Do not mix barcodes from several Macro PDF sequences, even if they encode the same data. When scanning a Macro PDF sequence, scan the entire sequence without interruption. When scanning a mixed sequence, two long low beeps (low/low) indicate an inconsistent file ID or inconsistent symbology error.

## Macro PDF User Indications

In this mode the scanner provides the following feedback.



**NOTE:** The beep only sounds if the \*BEEPER\_ON signal is connected.



**NOTE:** The T columns indicate whether the symbol transmitted to the host (N = No transmission).

User Scans	Passthrough All Symbols		Transmit Any Symbol in Set		Buffer All Symbols	
	Beep	T	Beep	T	Beep	T
Last Macro PDF in set	Decode beep	Y	Decode beep	Y	Decode beep	Y
Any Macro PDF in set except last	Decode beep	Y	Decode beep	Y	2 short low	N
Macro PDF is not in current set	Decode beep	Y	2 long low	N	2 long low	N
Invalid Macro PDF formatting	Decode beep	Y	2 long low	N	2 long low	N
Macro PDF from set was already scanned	Decode beep	Y	4 long low	N	4 long low	N
Out of Macro PDF memory	N/A	N/A	3 long low	N	3 long low	N
A non-Macro PDF scanned during a set	N/A	N/A	4 long low	N	4 long low	N
Flush Macro PDF	Low high	N	5 long low	N	5 long low	Y
Abort Macro PDF	High low high low	N	High low high low	N	High low high low	N

## Flush Macro PDF Buffer

This parameter flushes the buffer of all decoded Macro PDF data stored to that point, transmits it to the host device, and aborts from Macro PDF mode.

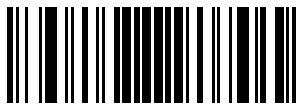

Flush Macro PDF Buffer

## Abort Macro PDF Entry

This parameter clears all currently-stored Macro PDF data in the buffer without transmission and aborts from Macro PDF mode.



Abort Macro PDF Entry

## Postal Codes

These parameters are regarding postal codes from around the globe.

### US Postnet

#### Parameter # 89 (SSI #59h)

This parameter enables or disables US Postnet.

- Enabled - enables US Postnet.
- \*Disabled - disables US Postnet.

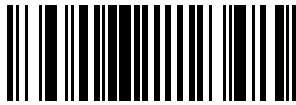

Enable US Postnet (1)

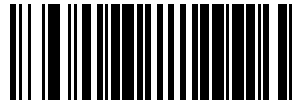

\*Disable US Postnet (0)

### US Planet

#### Parameter # 90 (SSI #5Ah)

This parameter enables or disables US Planet.

- Enabled - enables US Planet.
- \*Disabled - disables US Planet.



Enable US Planet (1)

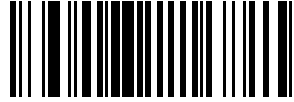

\*Disable US Planet (0)

## Transmit US Postal Check Digit

### Parameter # 95 (SSI # 5Fh)

This parameter selects whether to transmit US Postal data, which includes both US Postnet and US Planet, with or without the check digit.

- \*Transmit - transmit US Postal with Check Digit.
- Do Not Transmit - do not transmit US Postal with Check Digit.

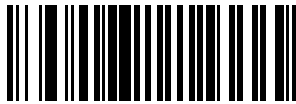

\*Transmit US Postal Check Digit (1)

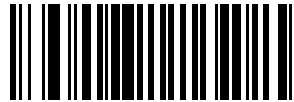

Do Not Transmit US Postal Check Digit (0)

## UK Postal

### Parameter # 91 (SSI # 5Bh)

This parameter enables or disables UK Postal.

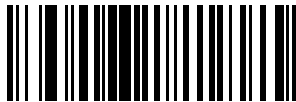

Enable UK Postal (1)

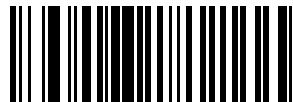

\*Disable UK Postal (0)

## Transmit UK Postal Check Digit

### Parameter # 96 (SSI # 60h)

This parameter enables or disables Transmit UK Postal Check Digit.

Scan one of the following barcodes to select whether to transmit UK Postal data with or without the check digit.



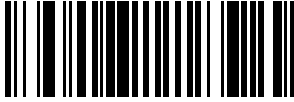

\*Transmit UK Postal Check Digit (1)



Do Not Transmit UK Postal Check Digit (0)

## Japan Postal

### Parameter # 290 (SSI # F0h, 22h)

This parameter enables or disables Japan Postal.

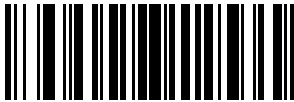

Enable Japan Postal (1)

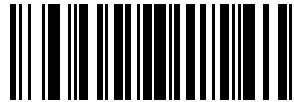

\*Disable Japan Postal (0)

## Australia Post

### Parameter # 291 (SSI # F0h, 23h)

This parameter enables or disables Australia Post.



Enable Australia Post (1)

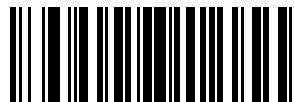

\*Disable Australia Post (0)

## Australia Post Format

### Parameter # 718 (SSI # F1h, CEh)

This parameter enables or disables Australia Post Format.

- Autodiscriminate (or Smart mode) - Decode the Customer Information Field using the N and C Encoding Tables.



**NOTE:** This option increases the risk of misdecodes because the encoded data format does not specify the Encoding Table used for encoding.

- Raw Format - Output raw bar patterns as a series of numbers 0 through 3.
- Alphanumeric Encoding - Decode the Customer Information Field using the C Encoding Table.
- Numeric Encoding - Decode the Customer Information Field using the N Encoding Table.

For more information on Australia Post Encoding Tables, refer to the Australia Post Customer Barcoding Technical Specifications available at [auspost.com.au](http://auspost.com.au).



\*Autodiscriminate (0)

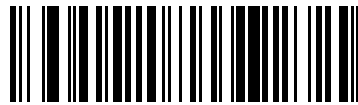

Raw Format (1)



Alphanumeric Encoding (2)



Numeric Encoding (3)

## Netherlands KIX Code

**Parameter # 326 (SSI # F0h, 46h)**

This parameter enables or disables Netherlands KIX Code.

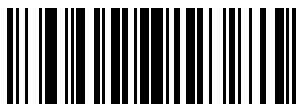

Enable Netherlands KIX Code (1)

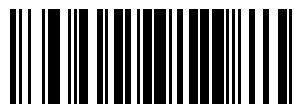

\*Disable Netherlands KIX Code (0)

## USPS 4CB/One Code/Intelligent Mail

**Parameter # 592 (SSI # F1h 50h)**

## Symbologies

This parameter enables or disables USPS 4CB/One Code/Intelligent Mail.

Scan one of the following barcodes to enable or disable USPS 4CB/One Code/Intelligent Mail.



Enable USPS 4CB/One Code/Intelligent Mail (1)

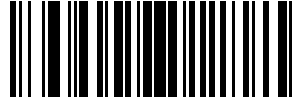

\*Disable USPS 4CB/One Code/Intelligent Mail (0)

## UPU FICS Postal

### Parameter # 611 (SSI # F1h 63h)

This parameter enables or disables Code 39.

Scan one of the following barcodes to enable or disable UPU FICS Postal.

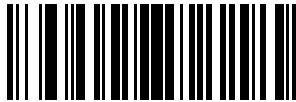

Enable UPU FICS Postal (1)

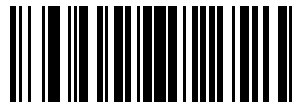

\*Disable UPU FICS Postal (0)

## Mailmark

### Parameter # 1337 (SSI # F8h 05h 39h)

This parameter enables or disables Mailmark.

Scan one of the following barcodes to enable or disable Mailmark.



\*Disable Mailmark (0)



Enable Mailmark (1)

## Digimarc Barcode

Digimarc Barcode is an invisible machine-readable code reported as UPC-A, UPC-E, EAN-13, or RSS Expanded.



**NOTE:** Converting the Digimarc reported code types to other barcode types is not supported.

AIM and Symbol code IDs are supported for the reported Digimarc code types.

Scan one of the following barcodes to enable or disable Digimarc Barcode.

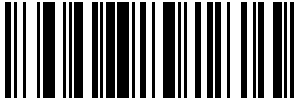

Enable Digimarc Barcode

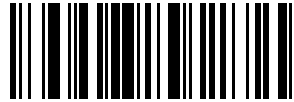

\*Disable Digimarc Barcode

## Posti LAPA 4-State Code

### Parameter # 2031 (SSI #F8 07EF)

This parameter enables or disables Posti LAPA.

- \*Disabled - disable Posti LAPA.
- Enabled - enables Posti LAPA.



\*Disable Posti LAPA (0)

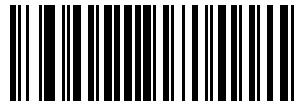

Enable Posti LAPA (1)

# OCR Programming

This chapter describes how to set up the scanner for OCR programming. The scanner can read 6 to 60 point OCR typeface. It supports font types OCR-A, OCR-B, MICR-E13B, and US Currency Serial Number.

OCR is not as secure as a barcode. To decrease OCR misdecodes and speed OCR reading, set an accurate OCR template and character subset, and use a check digit.

All OCR fonts are disabled by default. You can enable OCR-A and OCR-B at the same time, but not other combined font types.

## OCR Parameter Defaults

OCR Programming Defaults lists the defaults for OCR parameters. Change these values in one of two ways:

- Scan the appropriate barcodes in this chapter. The new value replaces the standard default value in memory. To recall default parameter values, see [Default Parameters](#).
- Configure the scanner using the 123Scan configuration program. See [123Scan and Software Tools](#).



**NOTE:** Standard parameter defaults are available in each chapter of this guide.

**Table 13** OCR Programming Defaults

Parameter	Parameter Number	SSI Number	Default
OCR-A	680	F1h A8h	Disable
OCR-A Variant	684	F1h ACh	Full ASCII
OCR-B	681	F1h A9h	Disable
OCR-B Variant	685	F1h ADh	Full ASCII
MICR E13B	682	F1h AAh	Disable
US Currency Serial Number	683	F1h ABh	Disable
OCR Orientation	687	F1h AFh	0o
OCR Lines	691	F1h B3h	1
OCR Minimum Characters	689	F1h B1h	3
OCR Maximum Characters	690	F1h B2h	100
OCR Subset	686	F1h AEh	Selected font variant

**Table 13** OCR Programming Defaults (Continued)

Parameter	Parameter Number	SSI Number	Default
OCR Quiet Zone	695	F1h B7h	50
OCR Template	547	F1h 23h	99999999
OCR Check Digit Modulus	688	F1h B0h	1
OCR Check Digit Multiplier	700	F1h BCh	1212121212
OCR Check Digit Validation	694	F1h B6h	None
Inverse OCR	856	F2h 58h	Regular
OCR Redundancy	1770	F8h 06h EAh	Level 1

## OCR Programming Parameters

The OCR programming parameters enable scanners to read font types for OCR-A, OCR-B, MICR-E13B, and US Currency Serial Numbers.

### OCR-A

#### Parameter # 680 (SSI # F1h A8h)

This parameter enables scanners to read OCR-A fonts.

- Enabled - OCR-A can be read by the scanner.
- Disabled - OCR-A fonts will not be read by the scanner.



**NOTE:** OCR is not as secure as a barcode. To decrease OCR misdecodes and speed OCR reading, set an accurate OCR template and character subset, and use a check digit. See [OCR Subset](#) and [OCR Template](#).



Enable OCR-A (1)



\*Disable OCR-A (0)

### OCR-A Variant

#### Parameter # 684 (SSI # F1 ACh)

This parameter enables scanners to read OCR-A font variants.

The font variant sets a processing algorithm and default character subset for the given font. Select the most appropriate font variant to optimize performance and accuracy.

OCR-A supports the following variants:

- OCR-A Full ASCII

```
!"#$%()*+,-./0123456789<>ABCDEFGHIJKLMNOPQRSTUVWXYZ\^
```

- OCR-A Reserved 1

```
$*+-. /0123456789ABCDEFGHIJKLMNOPQRSTUVWXYZ
```

- OCR-A Reserved 2

```
$*+-. /0123456789<>ABCDEFGHIJKLMNOPQRSTUVWXYZ
```

- OCR-A Banking

```
-0123456789<>
```

Special banking characters output as the following representative characters:

- ℥ outputs as f
- ₣ outputs as c
- ₤ outputs as h



**NOTE:** Enable OCR-A before setting this parameter. If disabling OCR-A, set the variant to OCR-A Full ASCII.

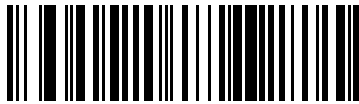

\*OCR-A Full ASCII (0)



OCR-A Reserved 1 (1)

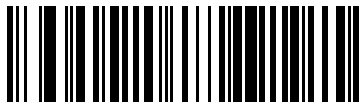

OCR-A Reserved 2 (2)



OCR-A Banking (3)

## OCR-B

Parameter # 681 (SSI # F1h A9h)

This parameter enables scanners to read OCR-B fonts.

- Enabled - OCR-B can be read by the scanner.
- Disabled - OCR-B fonts will not be read by the scanner..



**NOTE:** OCR is not as secure as a barcode. To decrease OCR misdecodes and speed OCR reading, set an accurate OCR template and character subset, and use a check digit. See [OCR Subset](#) and [OCR Template](#).

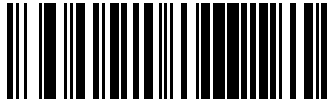

Enable OCR-B (1)

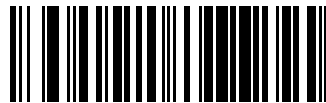

\*Disable OCR-B (0)

## OCR-B Variant

### Parameter # 685 (SSI # F1h ADh)

This parameter enables scanners to read OCR-A font variants.

OCR-A supports the following variants:

- OCR-B Full ASCII

```
!#$%()*+,-./0123456789<>ABCDEFGHIJKLMNPOQRSTUVWXYZ^|Ñ
```

- OCR-B Banking

```
#+-0123456789<>JNP|
```

- OCR-B Limited

```
+,-./0123456789<>ACENPSTVX
```

- OCR-B ISBN 10-Digit Book Numbers

```
-0123456789>BCEINPSXz
```

- OCR-B ISBN 10 or 13-Digit Book Numbers

```
-0123456789>BCEINPSXz
```

- OCR-B Travel Document Version 1 (TD1) 3-Line ID Cards



-0123456789<ABCDEFGHIJKLMNOPQRSTUVWXYZ

- OCR-B Travel Document Version 2 (TD2) 2-Line ID Cards

-0123456789<ABCDEFGHIJKLMNOPQRSTUVWXYZ

- OCR-B Travel Document 2 or 3-Line ID Cards Auto-Detect

!#\$%()\*+,-./0123456789<>ABCDEFGHIJKLMNOPQRSTUVWXYZ^|Ñ

- OCR-B Passport

-0123456789<ABCDEFGHIJKLMNOPQRSTUVWXYZÑ

- OCR-B Visa Type A

-0123456789<ABCDEFGHIJKLMNOPQRSTUVWXYZ

- OCR-B Visa Type B

-0123456789<ABCDEFGHIJKLMNOPQRSTUVWXYZÑ

- OCR-B ICAO Travel Documents

This allows reading either TD1, TD2, Passport, Visa Type A, or Visa Type B without switching between these options. It automatically recognizes the travel document read.

Selecting one of the ISBN Book Numbers automatically applies the appropriate ISBN checksum, so setting this is not required.

Selecting the following OCR-B variants automatically sets the appropriate [OCR Lines](#). These five variants invoke extensive special algorithms and checking for that particular document type:

Variant	OCR Lines Setting
Passport	2
TD1 ID Cards	3
TD2 ID Cards	2
Visa Type A	2
Visa Type B	2

If you set one of these variants with both OCR-A and OCR-B enabled, only the specified travel document is read without reading OCR-A. Returning OCR-B variant to its default (Full ASCII) allows reading OCR-A.

For the best performance in passport reading, fix the target passport and the scanner in place (6.5 - 7.5”).



**NOTE:** Enable OCR-B before setting this parameter. If disabling OCR-B, set the variant to OCR-B Full ASCII.



OCR-B ISBN 10 or 13-Digit Book Numbers (7)



OCR-B Travel Document Version 1 (TD1) 3 Line ID Cards (3)



OCR-B Travel Document Version 2 (TD2) 2-Line ID Cards (8)



Travel Document 2 or 3-Line ID Cards Auto-Detect (20)

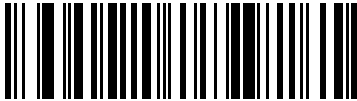

OCR-B Passport (4)



OCR-B Visa Type A (9)



OCR-B Visa Type B (10)



OCR-B ICAO Travel Documents (11)

## MICR E13B

### Parameter # 682 (SSI # F1h AAh)

This parameter enables scanners to read MICR E13B fonts.

MICR E 13B uses the following characters:

1 2 3 4 5 6 7 8 9 0 . : ; ' " ' " ' "

TOAD characters (Transit, On Us, Amount, and Dash) output as the following representative characters:

• outputs as **t**

• outputs as **a**

• outputs as **o**

• outputs as **d**

- Enabled - MICR E13B fonts can be read by the scanner.
- Disabled - MICR E13B fonts will not be read by the scanner..



**NOTE:** OCR is not as secure as a barcode. To decrease OCR misdecodes and speed OCR reading, set an accurate OCR template and character subset, and use a check digit. See [OCR Subset](#) and [OCR Template](#).



Enable MICR E13B (1)

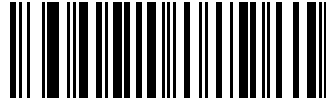

\*Disable MICR E13B (0)

## US Currency Serial Number

### Parameter # 683 (SSI # F1h ABh)

This parameter enables scanners to read US Currency Serial Numbers.

- Enabled - US Currency Serial Numbers can be read by the scanner.
- Disabled - US Currency Serial Numbers will not be read by the scanner..



**NOTE:** OCR is not as secure as a barcode. To decrease OCR misdecodes and speed OCR reading, set an accurate OCR template and character subset, and use a check digit. See [OCR Subset](#) and [OCR Template](#).



Enable US Currency (1)



\*Disable US Currency (0)

## OCR Orientation

### Parameter # 687 (SSI # F1h AFh)

This parameter specifies the orientation of the OCR to read to the imaging engine.

- OCR Orientation 0o
- OCR Orientation 270o clockwise (or 90o counterclockwise)
- OCR Orientation 180o (upside down)
- OCR Orientation 90o clockwise
- OCR Orientation Omnidirectional

Setting an incorrect orientation can cause misdecodes.

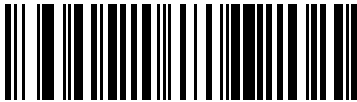

\*OCR Orientation 0o (0)

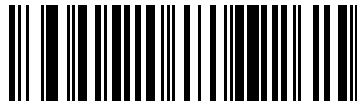

OCR Orientation 270o Clockwise (1)

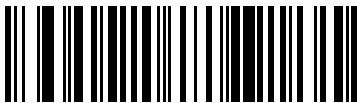

OCR Orientation 180o Clockwise (2)



OCR Orientation 90o Clockwise (3)

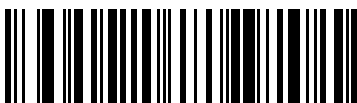

OCR Orientation Omnidirectional (4)

## OCR Lines

### Parameter # 691 (SSI # F1h B3h)

This parameter selects the number of OCR lines to decode.

Selecting Visas, TD1, or TD2 ID cards automatically sets the appropriate **OCR Lines**. Also see [OCR-B Variant](#).



\*OCR 1 Line (1)

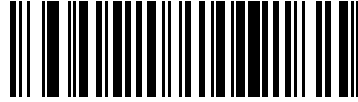

OCR 2 Lines (2)



OCR 3 Lines (3)

## OCR Minimum Characters

### Parameter # 689 (SSI # F1h B1h)

This parameter selects the minimum number of OCR characters (not including spaces) per line to decode.

Scan OCR Minimum Characters, then scan a three-digit number between 003 and 100 using the barcodes in [Numeric Barcodes](#) representing the number of OCR characters to decode. Strings of OCR characters less than the minimum are ignored.

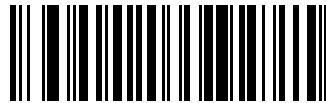

OCR Minimum Characters

## OCR Maximum Characters

### Parameter # 690 (SSI # F1h B2h)

This parameter selects the maximum number of OCR characters (including spaces) per line to decode.

Scan OCR Maximum Characters, then scan a three-digit number between 003 and 100 using the barcodes in [Numeric Barcodes](#) representing the number of OCR characters to decode. Strings of OCR characters greater than the maximum are ignored.



OCR Maximum Characters

## OCR Subset

### Parameter # 686 (SSI # F1h AEh)

This parameter creates an OCR subset to define a custom group of characters in place of a preset font variant.

For example, if scanning only numbers and the letters A, B, and C, create a subset of just these characters to speed decoding. This applies a designated OCR Subset across all enabled OCR fonts.

To cancel an OCR subset, for OCR-A or OCR-B, scan OCR-A variant Full ASCII, or OCR-B variant Full ASCII.

For MICR E13B or US Currency Serial Number, create a subset which includes all allowed characters in that character set, or scan an option from the [Default Parameters](#) and re-program the scanner.

## Setting or Modifying the OCR Font Subset

To set or modify the OCR Font Subset, follow this procedure.

1. Enable the appropriate OCR font(s).
2. Scan the **OCR Subset** barcode.

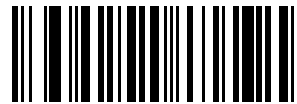

OCR Subset

3. Scan numbers and letters from [Alphanumeric Barcodes](#) to form the OCR Subset.
4. Scan [OCR Subset](#).

## OCR Quiet Zone

### Parameter # 695 (SSI # F1h B7h)

This parameter sets the OCR quiet zone.

The scanner stops scanning a field when it detects a sufficiently wide blank space. The width of this space is defined by the End of Field option. Used with parsers that tolerate slanted characters, the End of Field count is approximately a count of 8 for a character width. For example, if set to 15, then two character widths are an end of line indicator for the parser. Larger end of field numbers require bigger quiet zones at each end of text line.

Scan quiet zone, then scan a two-digit number using the numeric keypad in [Alphanumeric Barcodes](#). The range of the quiet zone is 20 - 99.



OCR Quiet Zone

## OCR Template

### Parameter # 547 (SSI # F1h 23h)

This parameter creates a template for precisely matching scanned OCR characters to a desired input format.

Carefully constructing an OCR template eliminates scanning errors.

To set or modify the OCR decode template, scan [OCR Template](#), and then scan barcodes on the following pages that correspond to numbers and letters to form the template expression. Finally, scan **End of Message**.

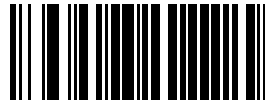

OCR Template



End of Message

## Required Digit (9)

Only a numeric character is allowed in this position.

Template	Valid data	Valid data	Invalid data
99999	12987	30517	123AB

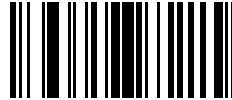

9

## Required Alpha (A)

Only an alpha character is allowed in this position.

Template	Valid data	Valid data	Invalid data
AAAAA	ABCDE	UVWXY	12FGH

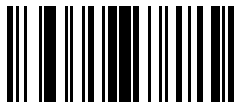

A

## Optional Alphanumeric (1)

An alphanumeric character is accepted in this position if present. Optional characters are not allowed as the first character(s) in a field of like characters.

Template	Valid data	Valid data	Invalid data
99991	1234A	12345	1234<

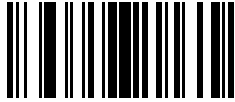

1

**Optional Alpha (2)**

An alpha character is accepted in this position if present. Optional characters are not allowed as the first character(s) in a field of like characters.

Template	Valid data	Valid data	Invalid data
AAAA2	ABCDE	WXYZ	ABCD6

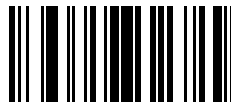

2

**Alpha or Digit (3)**

An alphanumeric character is required in this position to validate the incoming data.

Template	Valid data	Valid data	Invalid data
33333	12ABC	WXYZ34	12AB<



3

**Any Including Space & Reject (4)**

Any character is accepted in this position, including space and reject. An underscore (\_) represents rejects in the output. This is a good selection for troubleshooting.

Template	Valid data	Valid data
99499	12\$34	34 98

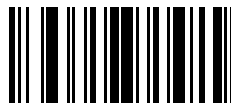

4



### Any except Space & Reject (5)

Any character is accepted in this position, except a space or reject.

Template	Valid data	Valid data	Invalid data
55999	A.123	*Z456	A BCD



5

### Optional Digit (7)

A numeric character is accepted if present. Optional characters are not allowed as the first character(s) in a field of like characters.

Template	Valid data	Valid data	Invalid data
99977	12345	789	789AB



7

### Digit or Fill (8)

Any numeric or fill character is accepted in this position.

Template	Valid data	Valid data	Valid data
88899	12345	>>789	<<789

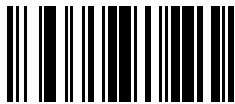

8

### Alpha or Fill (F)

Any alpha or fill character is accepted in this position.

Template	Valid data	Valid data	Valid data
AAAFF	ABCXY	LMN>>	ABC<5

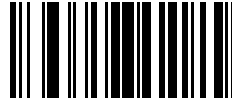

F

### Optional Space ( )

A space is accepted if present. Optional characters are not allowed as the first character(s) in a field of like characters.

Template	Valid data	Valid data	Invalid data
99 99	12 34	1234	67891

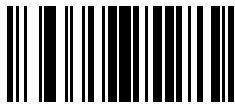

Space

### Optional Small Special (.)

A special character is accepted if present. Optional characters are not allowed as the first character(s) in a field of like characters. Small special characters are - , and .

Template	Valid data	Valid data	Invalid data
AA.99	MN.35	XY98	XYZ12



.

### Other Template Operators

These template operators assist in capturing, delimiting, and formatting scanned OCR data.

#### Literal String (" and +)

Use either of these delimiting characters surrounding characters from the alphanumeric keyboard in [Alphanumeric Barcodes](#) to define a literal string within a template that must be present in scanned OCR data. There are two characters used to delimit required literal strings; if one of the delimiter characters is present in the desired literal string, use the other delimiter.

Template	Valid data	Invalid data
"35+BC"	35+BC	AB+22



“



+

## New Line (E)

To create a template of multiple lines, add **E** between the template of each single line.

Template	Valid data	Valid data	Invalid data
999EAAAA	321	987	XYZW
	BCAD	ZXYW	12



E

## String Extract (C)

This operator, combined with others, defines a string of characters to extract from the scanned data. The string extract is structured as follows:

CbPe

Where:

- C is the string extract operator
- b is the string begin delimiter
- P is the category (one or more numeric or alpha characters) describing the string representation
- e is the string end delimiter

Values for b and e can be any scannable character. They are included in the output stream.

Template	Incoming data	Output
C>A>	XQ3>ABCDE>	>ABCDE>
	->ATHRUZ>123	>ATHRUZ>
	1ABCXYZ	No Output

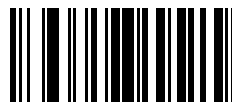

C

## Ignore to End of Field (D)

This operator causes all characters after a template to be ignored. Use this as the last character in a template expression. Examples for the template 999D:

Template	Incoming data	Output
999D	123-PED	123
	357298	357
	193	193

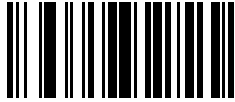

D

## Skip Until (P1)

This operator skips over characters until a specific character type or a literal string is detected. It can be used in two ways:

`P1ct`

Where:

- P1 is the Skip Until operator
- c is the type of character that triggers the start of output
- t is one or more template characters

`P1"s"t`

Where:

- P1 is the Skip Until operator
- "s" is one or more literal string characters (for example, "+") that trigger the start of output
- t is one or more template characters

The trigger character or literal string is included in output from a Skip Until operator, and the first character in the template should accommodate this trigger.

Template	Incoming data	Output
P1"PN"AA9999	123PN9876	PN9876
	PN1234	PN1234
	X-PN3592	PN3592



P



1

**Skip Until Not (P0)**

This operator skips over characters until a specific character type or a literal string is not matched in the output stream. It can be used in two ways:

P0ct

Where:

- P0 is the Skip Until Not operator
- c is the type of character that triggers the start of output
- t is one or more template characters

P0"s"t

Where:

- P0 is the Skip Until Not operator
- "s" is one or more literal string characters (for example, "+") that trigger the start of output
- t is one or more template characters

The trigger character or literal string is not included in output from a Skip Until Not operator.

Template	Incoming data	Output
POA9999	BPN3456	3456
	PN1234	1234
	5341	No output
P0"PN"9999	PN3456	3456
	5341	No output
	PNPN7654	7654



P

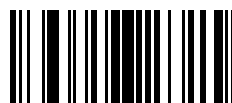

0

### Repeat Previous (R)

This operator allows a template character to repeat one or more times, allowing the capture of variable-length scanned data. The following examples capture two required alpha characters followed by one or more required digits:

Template	Incoming data	Output
AA9R	AB3	AB3
	PN12345	PN12345
	32RM52700	No output

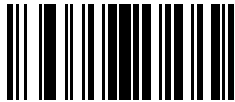

R

### Scroll Until Match (S)

This operator steps through scanned data one character at a time until the data matches the template.

Template	Incoming data	Output
S99999	AB3	No Output
	PN12345	12345
	32RM52700	52700

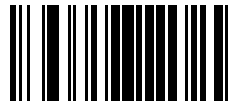

S

### Multiple Templates

This feature sets up multiple templates for OCR decoding.

To create multiple templates, see [OCR Template](#), and for each template in the multiple template string, using a capital letter X as a separator between templates.

For example, set the OCR template as **99999XAAAAA** to decode OCR strings of either **12345** or **ABCDE**.

### Template Examples

Following are sample templates with descriptions of valid data for each definition.

Field Definition	Description
"M" 99977	<b>M</b> followed by three digits and two optional digits.

```
"X"997777"X"
```

**X** followed by two digits, four optional digits, and an X.

```
9959775599
```

Two digits followed by any character, a digit, two optional digits, any two characters, and two digits.

```
A55" - "999" - "99
```

A letter followed by two characters, a dash, three digits, a dash, and two digits.

```
33A" . "99
```

Two alphanumeric characters followed by a letter, a period, and two digits.

```
999992991
```

Five digits followed by an optional alpha, two digits, and an optional alphanumeric.

```
"PN98"
```

Literal field - **PN98**

## OCR Check Digit Modulus

### Parameter # 688 (SSI # F1h B0h)

This parameter sets the OCR module check digit calculation.

The check digit is the last digit (in the right-most position) in an OCR string and improves the accuracy of the collected data. The calculation is performed on incoming data to determine this check digit, based on the numeric weight of the alpha and numeric characters. See [OCR Check Digit Multiplier](#). If the incoming data does not match the check digit, the data is considered corrupt.

The selected check digit option does not take effect until you set [OCR Check Digit Validation](#).

To choose the Check Digit Modulus, such as 10 for Modulus 10, scan OCR Check Digit, and then scan a three-digit number from 001 to 099 representing the check digit using the numeric keypad in [Numeric Barcodes](#).

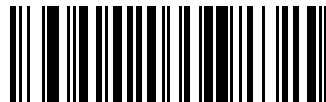

OCR Check Digit

## OCR Check Digit Multiplier

### Parameter # 700 (SSI # F1h BCh)

This parameter sets OCR check digit multipliers for character positions.

For check digit validation, each character in scanned data has an assigned weight to use in calculating the check digit. The scanner OCR ships with the following weight equivalents:

O = 0

A = 10

K = 20

U = 30

1 = 1	B = 11	L = 21	V = 31
2 = 2	C = 12	M = 22	W = 32
3 = 3	D = 13	N = 23	X = 33
4 = 4	E = 14	O = 24	Y = 34
5 = 5	F = 15	P = 25	Z = 35
6 = 6	G = 16	Q = 26	Space = 0
7 = 7	H = 17	R = 27	
8 = 8	I = 18	S = 28	
9 = 9	J = 19	T = 29	

All other characters are equivalent to one (1).

You can define the multiplier string if it is different from the default.



**NOTE:** 123456789A (for ISBN, Product Add Right to Left. See [OCR Check Digit Validation](#))

For example:

ISBN	0	2	0	1	1	8	3	9	9	4
Multiplier	10	9	8	7	6	5	4	3	2	1
Product	0	18	0	7	6	40	12	27	18	4
Product add	0+	18+	0+	7+	6+	40+	12+	27+	18+	4= 132

ISBN uses Modulus 11 for the check digit. In this case, 132 is divisible by 11, so it passes the check digit.

To set the check digit multiplier, scan OCR Check Digit Multiplier, and then scan numbers and letters to form the multiplier string before scanning End of Message from [Alphanumeric Barcodes](#)



OCR Check Digit Multiplier

## OCR Check Digit Validation

### Parameter # 694 (SSI # F1h B6h)

This parameter protects against scanning errors by applying a check digit validation scheme.

#### None

No check digit validation, indicating no check digit is applied.



\*No Check Digit (0)



## Product Add Left to Right

This parameter helps validate the check digit.

Each character in the scanned data is assigned a numeric value (see [OCR Check Digit Multiplier](#)). Each digit representing a character in the scanned data is multiplied by its corresponding digit in the multiplier, and the sum of these products is computed. The check digit passes if this sum modulo Check Digit Modulus is zero.

For example:

Scanned data numeric value is 132456 (check digit is 6)

Check digit multiplier string is 123456

Digit	1	3	2	4	5	6	
Multiplier	1	2	3	4	5	6	
Product	1	6	6	16	25	36	
Product add	1+	6+	6+	16+	25+	36=	90

The Check Digit Modulus is 10. It passes because 90 is divisible by 10 (the remainder is zero).

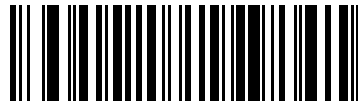

Product Add Left to Right (3)

## Product Add Right to Left

This parameter changes the order of the numeric values the check digit multiplier uses with the Check Digit Modulus.

Each character in the scanned data is assigned a numeric value (see [OCR Check Digit Multiplier](#)). The check digit multiplier is reversed in order. Each value representing a character in the scanned data is multiplied by its corresponding digit in the reversed multiplier, resulting in a product for each character in the scanned data. The sum of these products is computed. The check digit passes if this sum modulo Check Digit Modulus is zero.

For example:

Scanned data numeric value is 132459 (check digit is 9)

Check digit multiplier string is 123456

Digit	1	3	2	4	5	9	
Multiplier	6	5	4	3	2	1	
Product	6	15	8	12	10	9	
Product add	6+	15+	8+	12+	10+	9=	60

The Check Digit Modulus is 10. It passes because 60 is divisible by 10 (the remainder is 0).



Product Add Right to Left (1)

## Digit Add Left to Right

This parameter adds individual digits from left to right to use in the Check Digit Modulus.

Each character in the scanned data is assigned a numeric value (see [OCR Check Digit Multiplier](#)). Each value representing a character in the scanned data is multiplied by its corresponding digit in the multiplier, resulting in a product for each character in the scanned data. The sum of each individual digit in all of the products is then calculated. The check digit passes if this sum modulo Check Digit Modulus is zero.

For example:

Scanned data numeric value is 132456 (check digit is 6)

Check digit multiplier string is 123456

Digit	1	3	2	4	5	6	
Multiplier	1	2	3	4	5	6	
Product	1	6	6	16	25	36	
Digit add	1+	6+	6+	1+6+	2+5+	3+6=	36

The Check Digit Modulus is 12. It passes because 36 is divisible by 12 (the remainder is 0).



Digit Add Left to Right (4)

## Digit Add Right to Left

This parameter adds individual digits from right to left to use in the Check Digit Modulus.

Each character in the scanned data is assigned a numeric value (see [OCR Check Digit Multiplier](#)). The check digit multiplier is reversed in order. Each value representing a character in the scanned data is multiplied by its corresponding digit in the reversed multiplier, resulting in a product for each character in the scanned data. The sum of each individual digit in all of the products is then calculated. The check digit passes if this sum modulo Check Digit Modulus is zero.

For example:

Scanned data numeric value is 132456 (check digit is 6)

Check digit multiplier string is 123456

Digit	1	3	2	4	5	6	
Multiplier	6	5	4	3	2	1	
Product	6	15	8	12	10	6	
Digit add	6+	1+5+	8+	1+2+	1+0+	6=	30

The Check Digit Modulus is 10. It passes because 30 is divisible by 10 (the remainder is 0).



Digit Add Right to Left (2)

### Product Add Right to Left Simple Remainder

This parameter reverses the order of the check digit multiplier before adding the product to use in the Check Digit Modulus.

Each character in the scanned data is assigned a numeric value (see [OCR Check Digit Multiplier](#)). The check digit multiplier is reversed in order. Each value representing a character in the scanned data is multiplied by its corresponding digit in the reversed multiplier, resulting in a product for each character in the scanned data. The sum of these products **except for the check digit's product** is computed. The check digit passes if this sum modulo Check Digit Modulus is equal to the check digit's product.

For example:

Scanned data numeric value is 122456 (check digit is 6)

Check digit multiplier string is 123456

Digit	1	2	2	4	5	6
Multiplier	6	5	4	3	2	1
Product	6	10	8	12	10	6
Product add	6+	10+	8+	12+	10=	46

The Check Digit Modulus is 10. It passes because 46 divided by 10 leaves a remainder of 6.



Product Add Right to Left Simple Remainder (5)

### Digit Add Right To Left Simple Remainder

This parameter reverses the order of the check digit multiplier before adding the product and checking the remainder to use in the Check Digit Modulus.

Each character in the scanned data is assigned a numeric value (see [OCR Check Digit Multiplier](#)). The check digit multiplier is reversed in order. Each value representing a character in the scanned data is multiplied by its corresponding digit in the reversed multiplier, resulting in a product for each character in the scanned data. The sum of each individual digit in all of the products **except for the check digit's product** is then calculated. The check digit passes if this sum modulo Check Digit Modulus is equal to the check digit's product.

For example:

Scanned data numeric value is 122459 (check digit is 6)Check digit multiplier string is 123456

Digit	1	2	2	4	5	9
Multiplier	6	5	4	3	2	1

Product	6	10	8	12	10		9
Digit add	6+	1+0+	8+	1+2+	1+0=	19	9

The Check Digit Modulus is 10. It passes because 19 divided by 10 leaves a remainder of 9.



Digit Add Right to Left Simple Remainder (6)

### Health Industry - HIBCC43

This parameter is the health industry module 43 check digit standard.

The check digit is the modulus 43 sum of all the character values in a given message, and is printed as the last character in a given message.

Example:

Supplier Labelling Data Structure: + A 1 2 3 B J C 5 D 6 E 7 1

Sum of values: 41+10+1+2+3+11+19+12+5+13+6+14+7+1 = 145

Divide 145 by 43. The quotient is 3 with a remainder of 16. The check digit is the character corresponding to the value of the remainder, which in this example is 16, or G. The complete Supplier Labeling Data Structure, including the check digit, therefore is:

A 1 2 3 B J C 5 D 6 E 7 1 G

#### Numeric Value Assignments for Computing HIBC LIC Data Format Check Digit

0 = 0	9 = 9	I = 18	R = 27	- = 36
1 = 1	A = 10	J = 19	S = 28	. = 37
2 = 2	B = 11	K = 20	T = 29	Space = 38
3 = 3	C = 12	L = 21	U = 30	\$ = 39
4 = 4	D = 13	M = 22	V = 31	/ = 40
5 = 5	E = 14	N = 23	W = 32	+ = 41
6 = 6	F = 15	O = 24	X = 33	% = 42
7 = 7	G = 16	P = 25	Y = 34	
8 = 8	H = 17	Q = 26	Z = 35	



Health Industry - HIBCC43 (9)

### Inverse OCR

Parameter # 856 (SSI # F2h 58h)

This parameter can read white or light words on a black or dark background.

- Regular Only - Decode regular OCR (black on white) strings only.
- Inverse Only - Decode inverse OCR (white on black) strings only.
- Autodiscriminate - Decode both regular and inverse OCR strings.

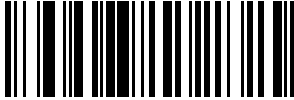

\*Regular Only (0)

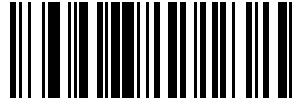

Inverse Only (1)

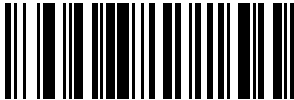

Autodiscriminate (2)

## OCR Redundancy

### Parameter # 1770 (SSI # F8h 06h EAh)

This parameter adjusts the number of times to decode an OCR text string before transmission.

There are three levels of OCR decode redundancy. There is an inverse relationship between the redundancy level and OCR decoding aggressiveness. Increasing the level of the redundancy can reduce OCR scanning aggressiveness, so select only the level of redundancy necessary.

- OCR Redundancy Level 1 - This setting allows the scanner to operate in its most aggressive state while providing sufficient accuracy in decoding most in-spec OCR text strings.
- OCR Redundancy Level 2 - This setting eliminates most misdecodes while maintaining reasonable aggressiveness.
- OCR Redundancy Level 3 - Select this option with greater redundancy requirements if OCR Redundancy Level 2 fails to eliminate misdecodes.



\*OCR Redundancy Level 1 (1)



OCR Redundancy Level 2 (2)



OCR Redundancy Level 3 (3)

# Maintenance and Troubleshooting

This chapter provides suggested RS6100 troubleshooting and maintenance.

## Maintenance

Cleaning the scan window is the basic maintenance required. A dirty window can affect scanning performance.

- Do not allow abrasive material to touch the window.
- Remove any dirt particles with a damp cloth.
- Wipe the window using a tissue moistened with ammonia/water.
- Do not spray water or other cleaning liquids directly into the window.

## Battery Safety Guidelines

- The area in which the RS6100 units are charged should be clear of debris and combustible materials or chemicals. Particular care should be taken where the device is charged in a non-commercial environment.
- Do not use incompatible batteries and chargers. If you have any questions about the compatibility of a battery or a charger, contact Zebra Support. See [Service Information](#) for contact information.
- Do not crush, puncture, or place a high degree of pressure on the battery.
- Follow battery usage, storage, and charging guidelines.
- Improper battery use may result in a fire, explosion, or other hazard.
- To charge the mobile device battery, the battery and charger temperatures must be between +41°F and +104°F (5°C and +40°C)
- Do not disassemble or open, crush, bend or deform, puncture, or shred.
- Severe impact from dropping any battery-operated device on a hard surface could cause the battery to overheat.
- Do not short circuit a battery or allow metallic or conductive objects to contact the battery terminals.
- Do not modify or remanufacture, attempt to insert foreign objects into the battery, immerse or expose to water or other liquids, or expose to fire, explosion, or other hazard.
- Do not leave or store the equipment in or near areas that might get very hot, such as in a parked vehicle or near a radiator or other heat source. Do not place battery into a microwave oven or dryer.

- Battery usage by children should be supervised.
- Please follow local regulations to promptly dispose of used re-chargeable batteries.
- Do not dispose of batteries in fire.
- Seek medical advice immediately if a battery has been swallowed.
- In the event of a battery leak, do not allow the liquid to come in contact with the skin or eyes. If contact has been made, wash the affected area with large amounts of water and seek medical advice.
- If you suspect damage to your equipment or battery, call Customer Support to arrange for inspection. See [Service Information](#) for contact information.

### Long Term Storage

When storing the RS6100 for a long period of time, it is recommended to remove the battery. When returning the RS6100 to everyday operation, install a fully charged battery.

### Cleaning the Finger Strap and Comfort Pad

It may be necessary to wash the finger strap and comfort pad when they become soiled.

1. Remove the strap and comfort pads.  
See [Replacing the Finger Strap](#) and [Replacing the Comfort Pad](#).
2. Hand wash in cold water with dish soap. Do not use bleach. Air dry. Do not use a hand dryer.
3. Leave the comfort pad to air dry in a shaded area.

### Replacing the Comfort Pad

1. Slide the strap out of the buckle.
2. Remove the comfort pad from the RS6100.

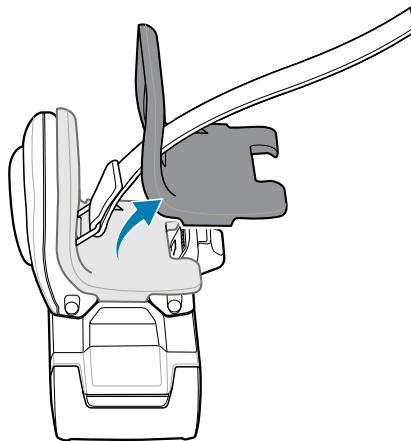

3. Position the comfort pad onto the RS6100 as shown.



4. Press the comfort pad onto the RS6100 until it locks into place.

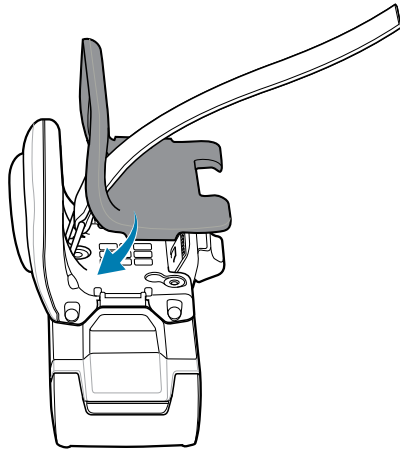

## Trigger Assembly Replacement

To replace the single or double trigger assembly:



**NOTE:** After installing a different type of trigger, reboot the RS6100 to recognize the new trigger.

1. Push the trigger assembly latch in, while lifting the assembly away from the RS6100.

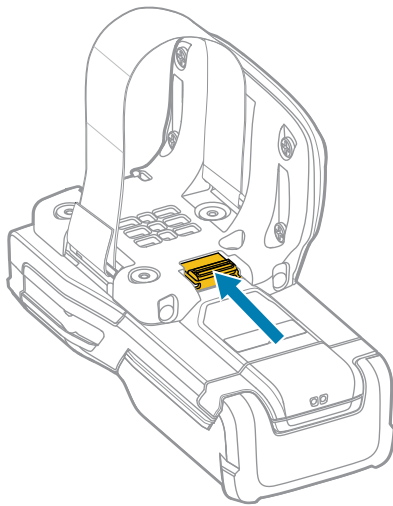

2. Lift the trigger assembly off of the RS6100.

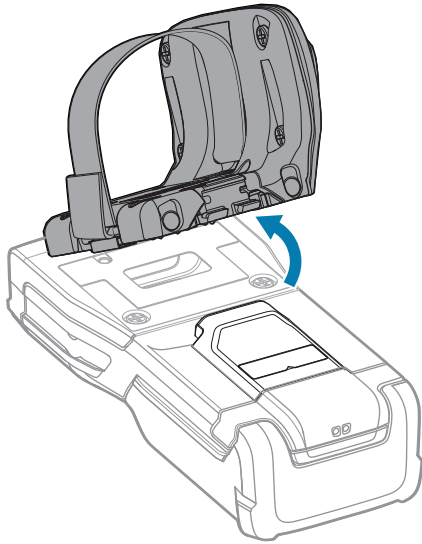

3. Position the new trigger assembly to align with the back of the RS6100.

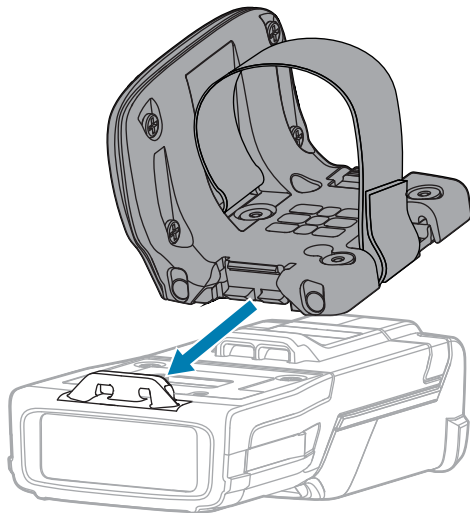

4. Lower the assembly onto the housing and snap into place.

## Replacing the Finger Strap

1. Use a finger tip to press the strap release latch on the buckle.
2. Remove the finger strap from the buckle.

3. Push in the strap pin and pull the finger strap to remove the strap pin from the trigger assembly.

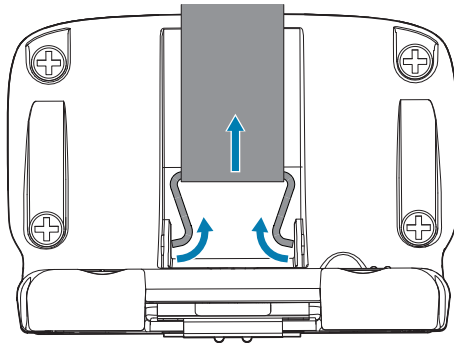

4. Align the strap pin of the new finger strap with the slot in the trigger swivel assembly.

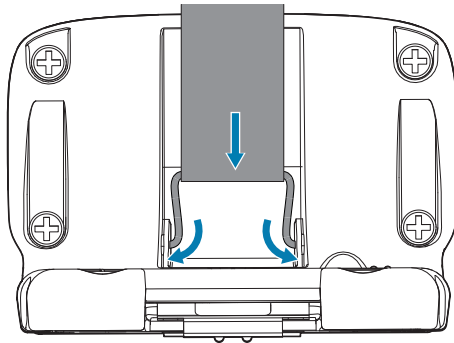

5. Guide the strap pin into the slots of the trigger swivel assembly.
6. Pull up on the strap to snap the strap pin into the slots.
7. Slide the other end of the strap into the buckle.
8. Press the buckle closed.

## Troubleshooting the RS6100

**Table 14** RS6100 Troubleshooting

Problem	Cause	Solution
Laser aiming pattern does not display when pressing the scan trigger.	Battery is not charged.	Replace or charge battery.
	Power is not applied to RS6100.	Replace or charge RS6100 battery.
	Scan application on the mobile computer is not functioning.	Restart the scanning application on the mobile computer.
	RS6100 does not respond.	Reset the RS6100 (see <a href="#">Resetting the RS6100</a> ).
RS6100 does not decode a barcode.	Barcode is unreadable.	Verify that the barcode is not defective, i.e., smudged or damaged.
	Exit window is dirty.	Clean exit window with a lens tissue. Tissues for eyeglasses work well. Do not use tissues coated with lotion (see <a href="#">Maintenance</a> ).

**Table 14** RS6100 Troubleshooting (Continued)

Problem	Cause	Solution
	Barcode symbology is not supported or enabled.	See your system administrator.
	Bluetooth link is disconnected.	Reestablish Bluetooth connection (see <a href="#">Radio Communication</a> ).
Scanner loses connection to the host device after a firmware update.	Differences in supported parameters after a firmware update cause the Bluetooth connection to reset.	Manually scan a pairing barcode to reconnect to the host computer.



**NOTE:** If after performing these checks the RS6100 still experiences problems, contact the distributor or call Zebra Support. See [Service Information](#).

## Troubleshooting Cradles

**Table 15** Cradle Troubleshooting

Problem	Cause	Solution
Device battery is not charging.	Device was removed from cradle or cradle was unplugged from AC power.	Ensure cradle is receiving power. Ensure device is seated correctly. Confirm main battery is charging. The battery fully charges in approximately four hours.
	Battery is faulty.	Verify that other batteries charge properly. If so, replace the faulty battery (see <a href="#">Installing the Battery</a> ).
	The device is not fully seated in the cradle.	Remove and re-insert the device into the cradle, ensuring it is firmly seated.
	Ambient temperature of the cradle is too warm or too cold.	Move the cradle to an area where the ambient temperature is between 5 °C and 40 °C (41 °F and 105 °F).



**NOTE:** If after performing these checks the RS6100 still experiences problems, contact the distributor or call Zebra Support. See [Service Information](#).

# Specifications

For device technical specifications, go to [zebra.com/rs6100](http://zebra.com/rs6100).

## 2-Bay Charge Only Charger Technical Specifications

Physical specifications and requirements for the 2-Bay Charger.

**Table 16** 2-Bay Charge Only Charger Technical Specifications

Item	Description
Dimensions	Height: 180 mm (7.09 in.) Width: 48 mm (1.89 in.) Depth: 19 mm (0.75 in.)
Weight	96 g (3.39 oz)
Input Voltage	5 V DC, 1 A
Operating Temperature	-20°C to 50°C (-4°F to 122°F)
Storage Temperature	-40°C to 70°C (-40°F to 158°F)
Charging Temperature	5°C to 40°C (41°F to 105°F)
Humidity	5 to 95% non-condensing
Drop	75 cm (30 in.) drops to concrete at room temperature
Electrostatic Discharge (ESD)	+/- 15 kV air discharge +/- 8 kV contact discharge

## 4-Slot Charge Only Cradle Technical Specifications

Physical specifications and requirements for the 4-Slot Cradle.

**Table 17** 4-Slot Charge Only Cradle Technical Specifications

Item	Description
Dimensions	Height: 87.97 mm (3.46 in.) Width: 97.52 mm (3.84 in.) Depth: 136.25 mm (5.36 in.)
Weight	433 g (15.27 oz.)
Input Voltage	12 VDC
Power Consumption	50 watts
Operating Temperature	5°C to 40°C (41°F to 105°F)
Storage Temperature	-40°C to 70°C (-40°F to 158°F)
Charging Temperature	10°C to 40°C (50°F to 105°F)
Humidity	5% to 95% non-condensing
Drop	75 cm (30 in.) drops to concrete at room temperature.
Electrostatic Discharge (ESD)	+/- 15 kV air discharge +/- 8 kV contact discharge

## 8-Slot Battery Charger Technical Specifications

Physical specifications and requirements for the 4-Slot Cradle.

**Table 18** 8-Slot Battery Charger Technical Specifications

Item	Description
Dimensions	Height: 83.64 mm (3.29 in.) Width: 97.52 mm (3.84 in.) Depth: 137.29 mm (5.4 in.)
Weight	486 g (17.14 oz.)
Input Voltage	12 VDC
Power Consumption	50 watts
Operating Temperature	5°C to 40°C (41°F to 105°F)
Storage Temperature	-40°C to 70°C (-40°F to 158°F)
Charging Temperature	10°C to 40°C (50°F to 105°F)
Humidity	5% to 95% non-condensing
Drop	75 cm (30 in.) drops to concrete at room temperature.
Electrostatic Discharge (ESD)	+/- 15 kV air discharge +/- 8 kV contact discharge

## 20-Slot Battery Charger Technical Specifications

Physical specifications and requirements for the 20-slot charging cradle.

**Table 19** 20-Slot Battery Charger Technical Specifications

Item	Description
Dimensions	Height: 523 mm (20.59 in.) Width: 221 mm (8.7 in.) Depth: 131 mm (5.16 in.)
Weight	2,660 g (93.3 oz)
Input Voltage	12 VDC
Power Consumption	50 watts
Operating Temperature	0°C to 50°C (32°F to 122°F)
Storage Temperature	-40°C to 70°C (-40°F to 158°F)
Charging Temperature	0°C to 40°C (32°F to 104°F)
Humidity	5% to 95% non-condensing
Drop	30 in. (75 cm) to concrete at room temperature
Electrostatic Discharge (ESD)	+/- 20 kV air discharge +/- 10 kV contact discharge

## 40-Slot Charging Cradle Technical Specifications

Physical specifications and requirements for the 40-slot Cradle.

**Table 20** 40-Slot Charging Cradle Technical Specifications

Item	Description
Dimensions	Height: 540 mm (21.26 in.) Width: 150 mm (5.91 in.) Depth: 190 mm (7.24 in.)
Weight	3200 g (7.15 oz)
Input Voltage	12 VDC
Power Consumption	50 watts
Operating Temperature	5°C to 40°C (41°F to 104°F)
Storage Temperature	-40°C to 70°C (-40°F to 158°F)
Charging Temperature	0°C to 40°C (32°F to 104°F)
Humidity	5% to 95% non-condensing
Drop	75 cm (30 in.) drops to concrete at room temperature.

**Table 20** 40-Slot Charging Cradle Technical Specifications (Continued)

Item	Description
Electrostatic Discharge (ESD)	+/-20 kV air discharge +/-10 kV contact discharge

## Bluetooth Adapter Technical Specifications

Physical specifications and requirements for the Bluetooth Adapter.

**Table 21** Bluetooth Adapter Technical Specifications

Item	Description
Dimensions	Height: 113 mm (4.45 in.) Width: 60.1 mm (2.37 in.) Depth: 31mm (1.22 in.)
Weight	98 g (3.46 oz)
Input Power Requirements	5 V DV, 200 mA
Operating Temperature	-20°C to 50°C (-4°F to 122°F)
Storage Temperature	-40°C to 70°C (-40°F to 158°F)
Humidity	5 to 95% non-condensing
Drop	75 cm (30 in.) drops to concrete at room temperature.
Electrostatic Discharge (ESD)	+/- 15 kV air discharge +/- 8 kV contact discharge

## Decode Distances

**Table 22** SE55 Decode Distances

Symbology	Typical Working Range (inches/centimeters) @ 20 Ft-Cd Minimum	
	Near (in. / cm)	Far (in. / cm)
3 mil Code 39	2.7 / 6.9	16.2 / 41.1
5 mil Code 39	2.5 / 6.4	26.6 / 67.6
5 mil PDF417	2.8 / 7.1	19.6 / 49.9
6.67 mil PDF417	2.6 / 6.6	25.6 / 65.0
80% UPCA	2.0 / 5.0	55.5 / 141
100% UPCA	2.5 / 6.4	71 / 180
10 mil Data Matrix	2.2 / 5.6	27.1 / 68.8



**Table 22** SE55 Decode Distances (Continued)

Symbology	Typical Working Range (inches/centimeters) @ 20 Ft-Cd Minimum	
	Near (in. / cm)	Far (in. / cm)
15 mil Code 128 (4 in. wide)	7.2 / 18.2	72 / 181
20 mil Code 39	-	109 / 277
55 mil Code 39	-	293 / 744
100 mil Code 39	-	554 / 1407

# Programming Reference

This section provides symbol and AIM code identifiers.

## Symbol Code Identifiers

**Table 23** Symbol Code Characters

Code Character	Code Type
A	UPC-A, UPC-E, UPC-E1, EAN-8, EAN-13
B	Code 39, Code 32
C	Codabar
D	Code 128, ISBT 128, ISBT 128 Concatenated
E	Code 93
F	Interleaved 2 of 5
G	Discrete 2 of 5, or Discrete 2 of 5 IATA
H	Code 11
J	MSI
K	GS1-128
L	Bookland EAN
M	Trioptic Code 39
N	Coupon Code
R	GS1 DataBar Family
S	Matrix 2 of 5
T	UCC Composite, TLC 39
U	Chinese 2 of 5
X	ISSN EAN, PDF417, Macro PDF417, Micro PDF417
z	Aztec, Aztec Rune
P00	Data Matrix
P01	QR Code, MicroQR

**Table 23** Symbol Code Characters (Continued)

Code Character	Code Type
P02	Maxicode
P03	US Postnet
P04	US Planet
P05	Japan Postal
P06	UK Postal
P08	Netherlands KIX Code
P09	Australia Post
P0A	USPS 4CB/One Code/Intelligent Mail
P0B	UPU FICS Postal
P0C	Mailmark
P0D	Grid Matrix
P0G	GS1 Data Matrix
P0H	Han Xin
P0Q	GS1 QR
P0X	Signature Capture

## AIM Code Identifiers

Each AIM Code Identifier contains the three-character string ]cm where:

] = Flag Character (ASCII 93)

c = Code Character (see table below)

m = Modifier Character (see table below)

**Table 24** AIM Code Characters

Code Character	Code Type
A	Code 39, Code 39 Full ASCII, Code 32
C	Code 128, ISBT 128, ISBT 128 Concatenated, GS1-128, Coupon (Code 128 portion)
d	Data Matrix, GS1 Data Matrix
E	UPC/EAN, Coupon (UPC portion)
e	GS1 DataBar Family

**Table 24** AIM Code Characters (Continued)

Code Character	Code Type
F	Codabar
G	Code 93
g	Grid Matrix
H	Code 11
h	Han Xin
I	Interleaved 2 of 5
L	PDF417, Macro PDF417, Micro PDF417
L2	TLC 39
M	MSI
Q	QR Code, MicroQR, GS1 QR
S	Discrete 2 of 5, IATA 2 of 5
U	Maxicode
z	Aztec, Aztec Rune
X	Bookland EAN, ISSN EAN, Trioptic Code 39, Chinese 2 of 5, Matrix 2 of 5, Korean 3 of 5, US Postnet, US Planet, UK Postal, Japan Postal, Australia Post, Netherlands KIX Code, USPS 4CB/One Code/ Intelligent Mail, UPU FICS Postal, Mailmark, Signature Capture

The modifier character is the sum of the applicable option values based on the following table.

**Table 25** Modifier Characters

Code Type	Option Value	Option
Code 39	0	No check character or Full ASCII processing.
	1	Reader has checked one check character.
	3	Reader has checked and stripped check character.
	4	Reader has performed Full ASCII character conversion.
	5	Reader has performed Full ASCII character conversion and checked one check character.
	7	Reader has performed Full ASCII character conversion and checked and stripped check character.
	Example: A Full ASCII barcode with check character W, A+I+MI+DW, is transmitted as JA7AIMID where 7 = (3+4).	
Trioptic Code 39	0	No option specified at this time. Always transmit 0.
	Example: A Trioptic barcode 412356 is transmitted as JX0412356	
Code 128	0	Standard data packet, no Function code 1 in first symbol position.
	1	Function code 1 in first symbol character position.
	2	Function code 1 in second symbol character position.

**Table 25** Modifier Characters (Continued)

Code Type	Option Value	Option
		Example: A Code (EAN) 128 barcode with Function 1 character FNC1 in the first position, AIMID is transmitted as ]C1AIMID
I 2 of 5	0	No check digit processing.
	1	Reader has validated check digit.
	3	Reader has validated and stripped check digit.
		Example: An I 2 of 5 barcode without check digit, 4123, is transmitted as ]I04123
Codabar	0	No check digit processing.
	1	Reader has checked check digit.
	3	Reader has stripped check digit before transmission.
		Example: A Codabar barcode without check digit, 4123, is transmitted as ]F04123
Code 93	0	No options specified at this time. Always transmit 0.
		Example: A Code 93 barcode 012345678905 is transmitted as ]G0012345678905
MSI	0	Check digits are sent.
	1	No check digit is sent.
		Example: An MSI barcode 4123, with a single check digit checked, is transmitted as ]M14123
D 2 of 5	0	No options specified at this time. Always transmit 0.
		Example: A D 2 of 5 barcode 4123, is transmitted as ]S04123
UPC/EAN	0	Standard data packet in full EAN format, i.e., 13 digits for UPC-A, UPC-E, and EAN-13 (not including supplemental data).
	1	Two digit supplemental data only.
	2	Five digit supplemental data only.
	3	Combined data packet comprising 13 digits from EAN-13, UPC-A or UPC-E symbol and 2 or 5 digits from supplemental symbol.
	4	EAN-8 data packet.
		Example: A UPC-A barcode 012345678905 is transmitted as ]E0012345678905
Bookland EAN	0	No options specified at this time. Always transmit 0.
		Example: A Bookland EAN barcode 123456789X is transmitted as ]X0123456789X
ISSN EAN	0	No options specified at this time. Always transmit 0.
		Example: An ISSN EAN barcode 123456789X is transmitted as ]X0123456789X
Code 11	0	Single check digit
	1	Two check digits
	3	Check characters validated but not transmitted.

**Table 25** Modifier Characters (Continued)

Code Type	Option Value	Option
GS1 DataBar Family		No option specified at this time. Always transmit 0. GS1 DataBar Omnidirectional and GS1 DataBar Limited transmit with an Application Identifier "01". Note: In GS1-128 emulation mode, GS1 DataBar is transmitted using Code 128 rules (i.e., ]C1).
		Example: A GS1 DataBar Omnidirectional barcode 0110012345678902 is transmitted as ]e00110012345678902.
EAN.UCC Composites (GS1 DataBar, GS1-128, 2D portion of UPC composite)		Native mode transmission. Note: UPC portion of composite is transmitted using UPC rules.
	0	Standard data packet.
	1	Data packet containing the data following an encoded symbol separator character.
	2	Data packet containing the data following an escape mechanism character. The data packet does not support the ECI protocol.
	3	Data packet containing the data following an escape mechanism character. The data packet supports the ECI protocol.
		GS1-128 emulation Note: UPC portion of composite is transmitted using UPC rules.
	1	Data packet is a GS1-128 symbol (i.e., data is preceded with ]JC1).
PDF417, Micro PDF417	0	Reader set to conform to protocol defined in 1994 PDF417 symbology specifications. Note: When this option is transmitted, the receiver cannot reliably determine whether ECIs have been invoked or whether data byte 92DEC has been doubled in transmission.
	1	Reader set to follow the ECI protocol (Extended Channel Interpretation). All data characters 92DEC are doubled.
	2	Reader set for Basic Channel operation (no escape character transmission protocol). Data characters 92DEC are not doubled. Note: When decoders are set to this mode, unbuffered Macro symbols and symbols requiring the decoder to convey ECI escape sequences cannot be transmitted.
	3	The barcode contains a GS1-128 symbol, and the first codeword is 903-907, 912, 914, 915.
	4	The barcode contains a GS1-128 symbol, and the first codeword is in the range 908-909.
	5	The barcode contains a GS1-128 symbol, and the first codeword is in the range 910-911.
		Example: A PDF417 barcode ABCD, with no transmission protocol enabled, is transmitted as ]L2ABCD.
Data Matrix	0	ECC 000-140, not supported.
	1	ECC 200.
	2	ECC 200, FNC1 in first or fifth position.
	3	ECC 200, FNC1 in second or sixth position.
	4	ECC 200, ECI protocol implemented.

**Table 25** Modifier Characters (Continued)

Code Type	Option Value	Option
	5	ECC 200, FNC1 in first or fifth position, ECI protocol implemented.
	6	ECC 200, FNC1 in second or sixth position, ECI protocol implemented.
GS1 Data Matrix	2	ECC 200, FNC1 in first or fifth position.
MaxiCode	0	Symbol in Mode 4 or 5.
	1	Symbol in Mode 2 or 3.
	2	Symbol in Mode 4 or 5, ECI protocol implemented.
	3	Symbol in Mode 2 or 3, ECI protocol implemented in secondary message.
QR Code	0	Model 1 symbol.
	1	Model 2 / MicroQR symbol, ECI protocol not implemented.
	2	Model 2 symbol, ECI protocol implemented.
	3	Model 2 symbol, ECI protocol not implemented, FNC1 implied in first position.
	4	Model 2 symbol, ECI protocol implemented, FNC1 implied in first position.
	5	Model 2 symbol, ECI protocol not implemented, FNC1 implied in second position.
	6	Model 2 symbol, ECI protocol implemented, FNC1 implied in second position.
GS1 QR	3	Model 2 symbol, ECI protocol not implemented, FNC1 implied in first position.
Aztec	0	Aztec symbol.
	C	Aztec Rune symbol.
Han Xin	0	Generic data, no special features are set. The transmitted data does not follow the AIM ECI protocol.
	1	ECI protocol enabled. There is at least one ECI mode encoded. Transmitted data must follow the AIM ECI protocol.
Mailmark	0	No option specified at this time. Always transmit 0.

# Numeric Barcodes

For parameters requiring specific numeric values, scan the appropriately numbered barcode(s).

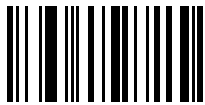

0

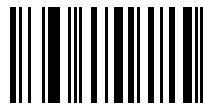

1

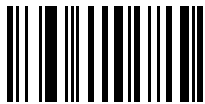

2



3

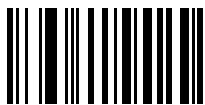

4



5

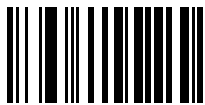

6





7



8



9

## Cancel

To correct an error or change a selection, scan the barcode below.

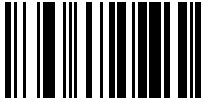

Cancel

# Alphanumeric Barcodes

For parameters requiring specific alphanumeric values, scan the appropriately numbered barcode(s).

## Cancel

To correct an error or change a selection, scan the barcode below.

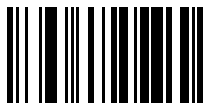

Cancel

## Alphanumeric Barcodes 1

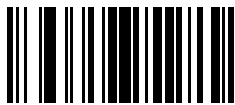

Space

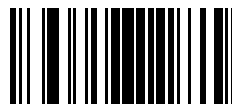

#

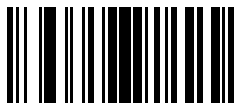

\$



%

# Alphanumeric Barcodes



\*



+



-

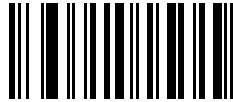

.



/

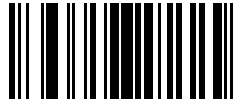

!

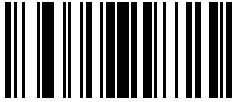

“



&



<

# Alphanumeric Barcodes



)



;



=



?

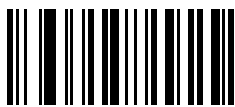

[



(



:

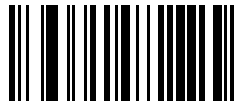

<



>

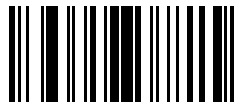

@

# Alphanumeric Barcodes



\



]



^

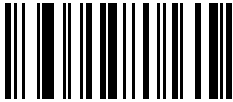

-



`



**NOTE:** Do not confuse the following barcodes with those on the numeric keypad.

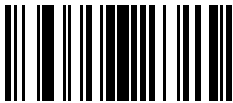

0

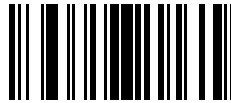

1

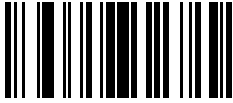

2

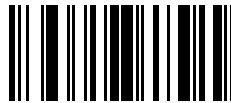

3

# Alphanumeric Barcodes



4



5



6

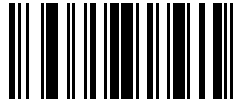

7

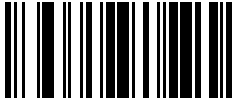

8

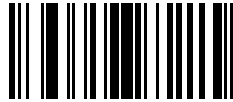

9

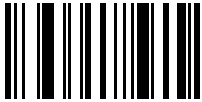

End of Message

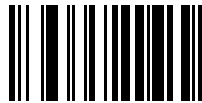

Cancel

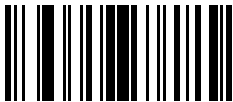

A

# Alphanumeric Barcodes



C



E

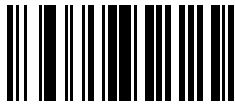

G

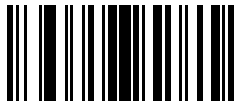

I



K

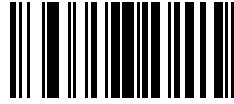

B

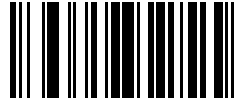

D

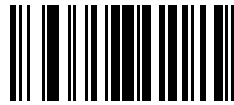

F

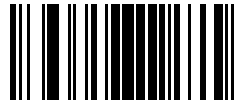

H



J

# Alphanumeric Barcodes



M



O

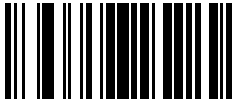

Q

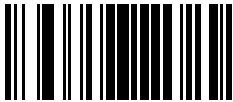

S



L



N

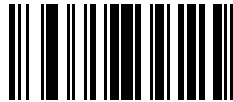

P

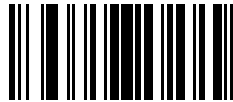

R

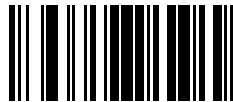

T



# Alphanumeric Barcodes



U



V

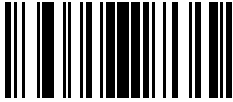

W

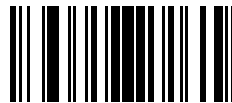

X

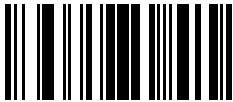

Y



Z



a

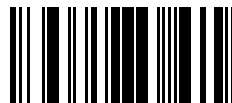

b



c

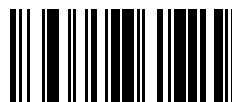

d

# Alphanumeric Barcodes



e



g

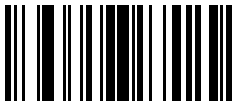

i



k

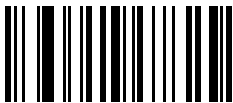

m



f



h

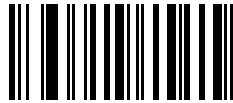

j

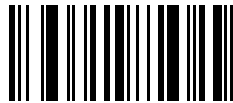

l



n

# Alphanumeric Barcodes



o

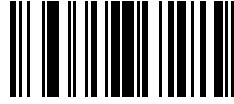

p

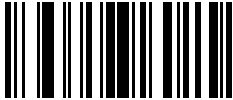

q

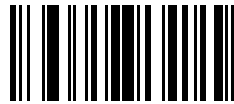

r

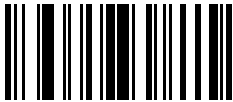

s

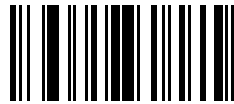

t



u

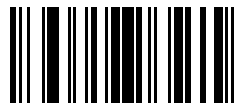

v



w

# Alphanumeric Barcodes



y

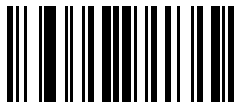

{



}



x

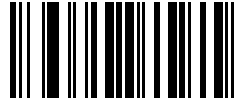

z

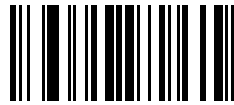

|

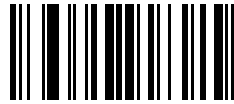

~

# Sample Barcodes

This section provides sample barcodes.

## Sample Code 39



## Sample Code 93

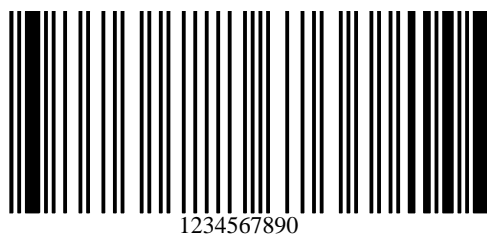

## Sample UPC/EAN

UPC-A, 100%



**UPC-E**



**EAN-8**



**EAN-13, 100%**

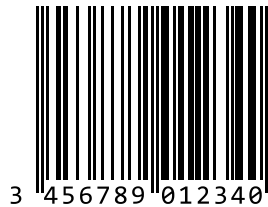

**Sample Code 128**



**Sample Interleaved 2 of 5**



**Sample GS1 DataBar**

**GS1 DataBar Omnidirectional**



**NOTE:** GS1 DataBar Omnidirectional must be enabled to read the following barcode (see [GS1 DataBar Omnidirectional \(formerly GS1 DataBar-14\)](#) on page 195 ).

## Sample Barcodes



### GS1 DataBar Limited



**NOTE:** DataDataBar Limited must be enabled to read the following barcode (see [GS1 DataBar Limited](#) on page 195).



### GS1 DataBar Expanded



**NOTE:** DataBar Expanded must be enabled to read the following barcode (see [GS1 DataBar Expanded](#) on page 196).



## Sample PDF417

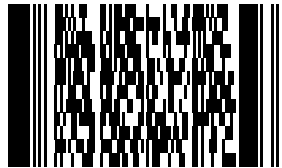

## Sample Data Matrix

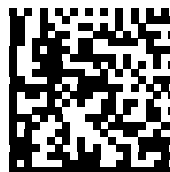

123456789abcdefghijklmnopqrstuvwxy

### Sample Maxicode

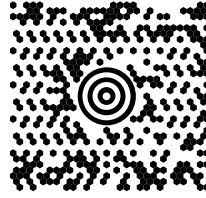

### Sample QR Code

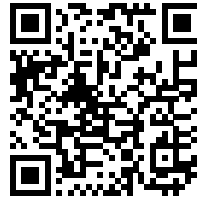

0123456789ABCDEFGHIJKLMN0PQRSTUVWXYZ0123456789ABCDEFGHIJKLMN0PQRSTUVWXYZ0123456789

### Sample Aztec



0123456789ABCDEFGHIJKLMN0PQRSTUVWXYZ0123456789ABCDEFGHIJKLMN0PQRSTUVWXYZ  
WXYZ01234567890123456789ABCDEFGHIJKLMN0PQRSTUVWXYZ0123456789ABCDEFGHI  
JKLMN0PQRSTUVWXYZ0123456789

### Sample Grid Matrix



**NOTE:** Grid Matrix must be enabled to read the following bar code (see [Grid Matrix](#)).

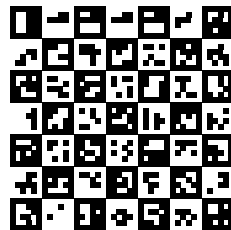



### Sample US Postnet



### Sample UK Postal



# Country Codes

This chapter provides instructions for configuring the keyboard when the scanner is operating in Bluetooth HID mode.

To select a code page for the country keyboard type, go to Country Keyboard Types (Country Codes).

Throughout the programming barcode menus, default values are indicated with an asterisk (\*).

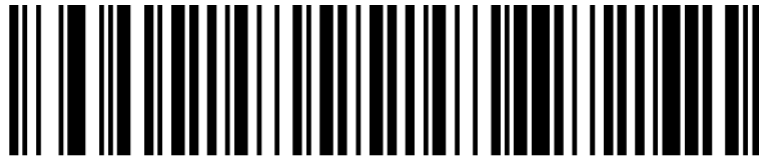

\*US English (North American) — Feature/Option

\*Indicates Default

# Country Keyboard Types (Country Codes)

Scan the barcode corresponding to the keyboard type. This setting applies only to the Bluetooth Keyboard (HID) device.



**NOTE:** For best results when using international keyboards, enable [Quick Keypad Emulation](#)



**IMPORTANT:** Some country keyboard barcode types are specific to certain Windows Operating Systems (such as XP and Windows 7 or higher). Barcodes requiring a specific Windows OS are noted in their barcode captions. Use the **French International** barcode for Belgian French keyboards.

# Country Code Barcodes

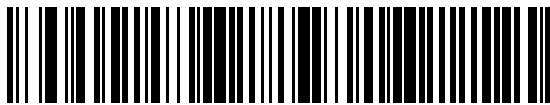

\*US English (North American)



US English (Mac)

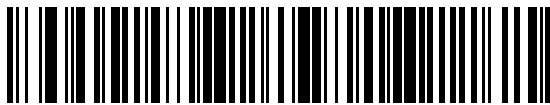

Albanian

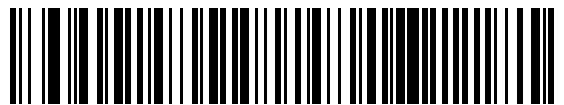

Arabic (101)



Arabic (102)



Arabic (102) AZERTY



Azeri (Latin)

## Country Code Barcodes



Belarusian

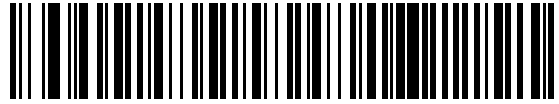

Azeri (Cyrillic)

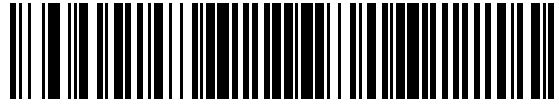

Bosnian (Latin)

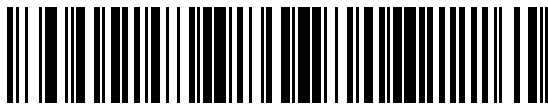

Bosnian (Cyrillic)

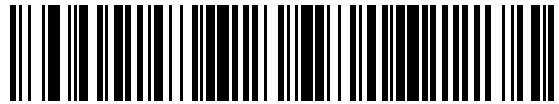

Bulgarian (Latin)

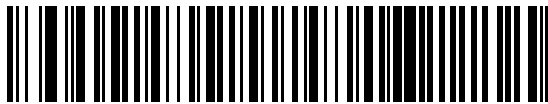

Bulgarian Cyrillic (Typewriter) (Bulgarian -Windows XP Typewriter - Windows 7 or higher)

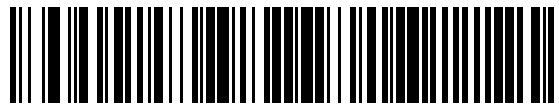

Canadian French Win7



Canadian French (Legacy)



Canadian Multilingual Standard



Chinese (ASCII)

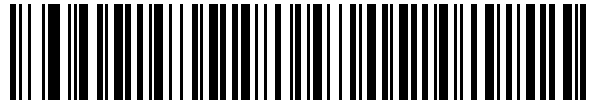

Chinese (Simplified)\*

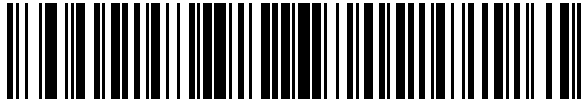

Chinese (Traditional)\*

\*For CJK keyboard types, see [CJK Decode Control](#).

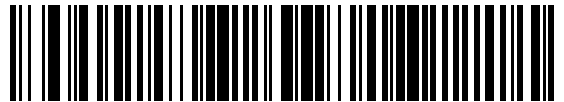

Croatian



Czech



Czech (Programmer)



Czech (QWERTY)



Danish



Dutch (Netherlands)

## Country Code Barcodes

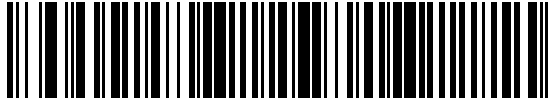

Faeroese



French (France)

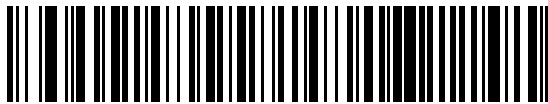

French (Canada) 95/98



Galician



Estonian



Finnish

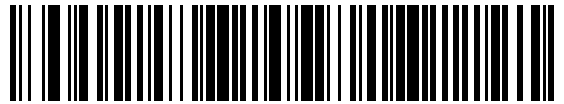

French International (Belgian French)

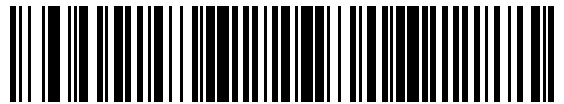

French (Canada) 2000/XP\*

\*Note that there is also a country code barcode for Canadian Multilingual Standard. Be sure to select the appropriate barcode for your host system.



German

## Country Code Barcodes

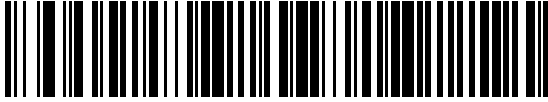

Greek Latin

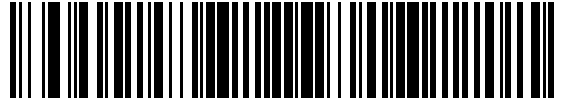

Greek (220) Latin

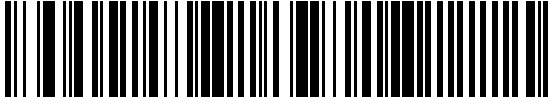

Greek (319) Latin

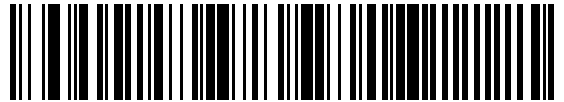

Greek

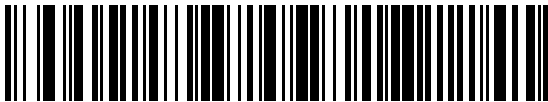

Greek (220)

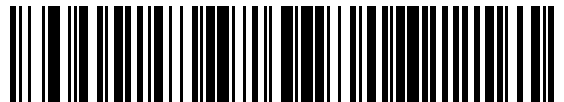

Greek (319)

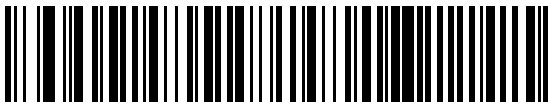

Greek Polytonic



Hebrew Israel

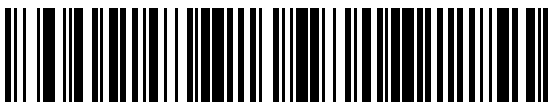

Hungarian



## Country Code Barcodes



Icelandic



Italian



Japanese (ASCII)

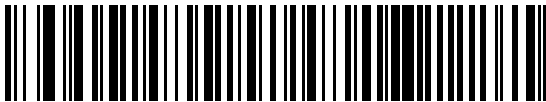

Kazakh

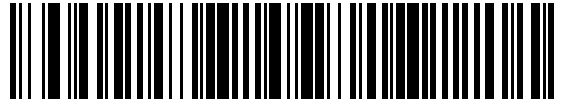

Hungarian\_101KEY



Irish



Italian (142)



Japanese (SHIFT-JIS)\*

\*For CJK keyboard types, see [CJK Decode Control](#).

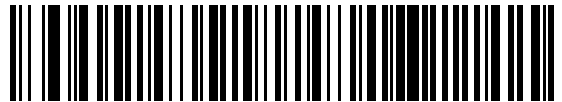

Korean (ASCII)

## Country Code Barcodes

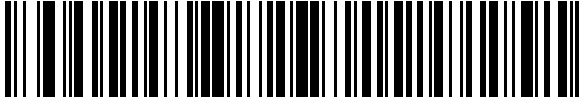

Korean (Hangul)\*

\*For CJK keyboard types, see [CJK Decode Control](#).

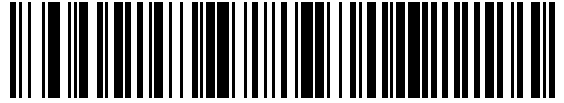

Kyrgyz



Latin American



Latvian



Latvian (QWERTY)

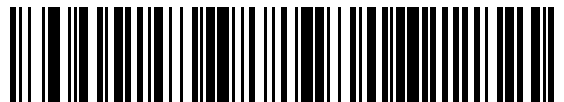

Lithuanian



Lithuanian (IBM)

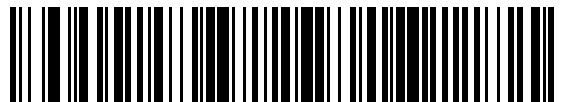

Macedonian (FYROM)



Maltese\_47KEY

## Country Code Barcodes



Norwegian

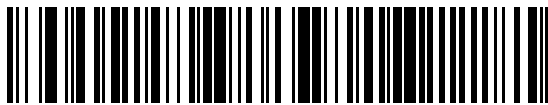

Polish (Programmer)

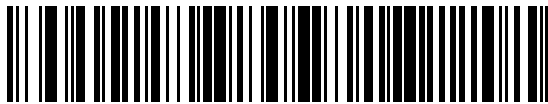

Portuguese (Brazilian ABNT)



Portuguese (Portugal)



Romanian (Legacy) (Windows 7 or higher)



Mongolian

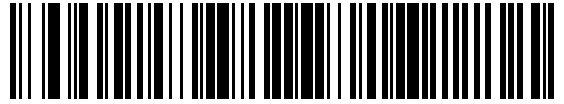

Polish (214)

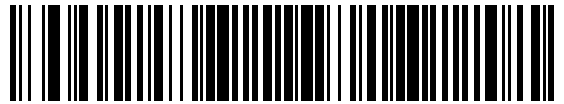

Portuguese (Brazil) (Windows XP)

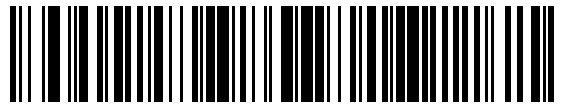

Portuguese (Brazilian ABNT2)



Romanian (Windows XP)

## Country Code Barcodes

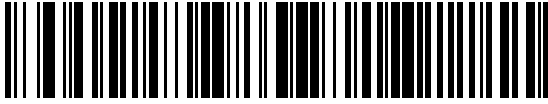

Romanian (Programmer) (Windows 7 or higher)

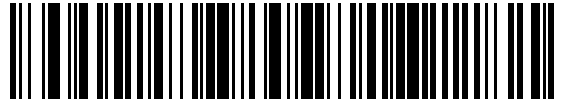

Romanian (Standard) (Windows 7 or higher)



Russian (Typewriter)

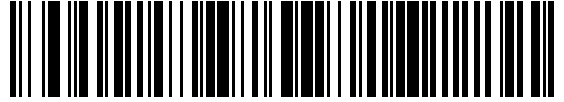

Russian

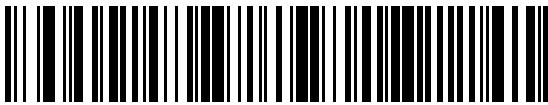

Serbian (Cyrillic)



Serbian (Latin)

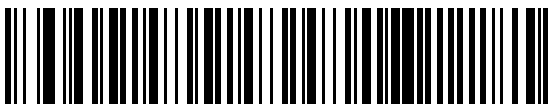

Slovak (QWERTY)



Slovak

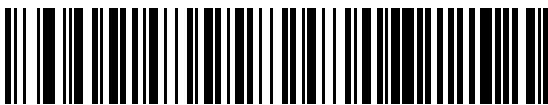

Spanish



Slovenian

## Country Code Barcodes



Swedish



Spanish (Variation)

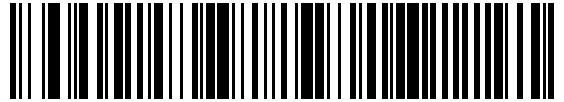

Swiss French



Swiss German

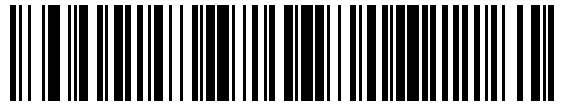

Tatar

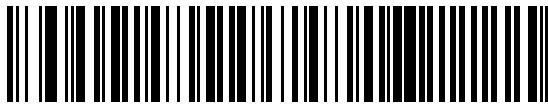

Thai (Kedmanee)

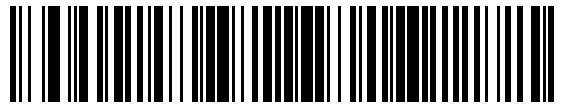

Turkish F



Turkish Q



UK English

## Country Code Barcodes

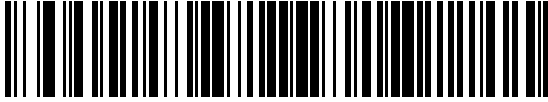

Ukrainian



US Dvorak

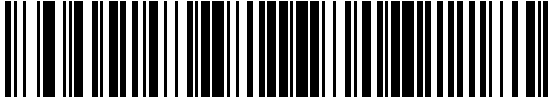

US Dvorak Left

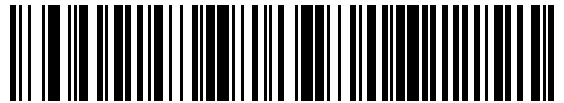

US Dvorak Right

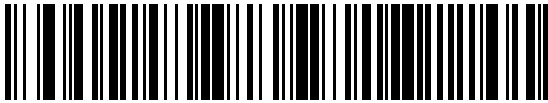

US International

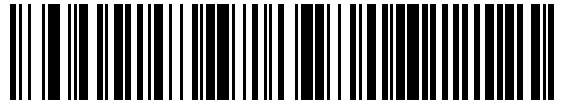

Uzbek

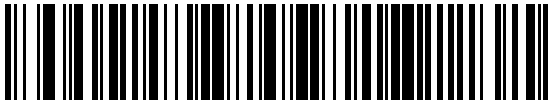

Vietnamese

# Country Code Pages

This chapter provides barcodes for selecting code pages for the country keyboard type selected in Country Codes.

If the default code page in [Country Code Pages](#) is appropriate for your selected country keyboard type, you do not need to scan a country code page barcode.



**NOTE:** ADF rules can also specify a code page based on the symbology and other ADF criteria. Refer to the Advanced Data Formatting Programmer Guide.

## Country Code Page Defaults

The table in this section lists the code page default for each country keyboard.

**Table 26** Country Code Page Defaults

Country Keyboard	Code Page Default
US English (North American)	Windows 1252
US English (Mac)	Mac CP10000
Albanian	Windows 1250
Arabic 101	Windows 1256
Arabic 102	Windows 1256
Arabic 102 AZERTY	Windows 1256
Azeri Latin	Windows 1254
Azeri Cyrillic	Windows 1251
Belarusian	Windows 1251
Bosnian Latin	Windows 1250
Bosnian Cyrillic	Windows 1251
Bulgarian Latin	Windows 1250
Bulgarian Cyrillic	Windows 1251
Canadian French Win7	Windows 1252
Canadian French (Legacy)	Windows 1252
Canadian Multilingual	Windows 1252

**Table 26** Country Code Page Defaults (Continued)

Country Keyboard	Code Page Default
Croatian	Windows 1250
Chinese ASCII	Windows 1252
Chinese (Simplified)	Windows 936, GBK
Chinese (Traditional)	Windows 950, Big5
Czech	Windows 1250
Czech Programmers	Windows 1250
Czech QWERTY	Windows 1250
Danish	Windows 1252
Dutch Netherland	Windows 1252
Estonian	Windows 1257
Faeroese	Windows 1252
Finnish	Windows 1252
French (France)	Windows 1252
French (Canada) 95/98	Windows 1252
French (Canada) 2000/XP	Windows 1252
French International (Belgian French)	Windows 1252
Galician	Windows 1252
German	Windows 1252
Greek Latin	Windows 1252
Greek220 Latin	Windows 1253
Greek319 Latin	Windows 1252
Greek	Windows 1253
Greek220	Windows 1253
Greek319	Windows 1253
Greek Polytonic	Windows 1253
Hebrew Israel	Windows 1255
Hungarian	Windows 1250
Hungarian_101KEY	Windows 1250
Icelandic	Windows 1252
Irish	Windows 1252
Italian	Windows 1252
Italian_142	Windows 1252
Japanese ASCII	Windows 1252



**Table 26** Country Code Page Defaults (Continued)

Country Keyboard	Code Page Default
Japanese (Shift-JIS)	Windows 932, Shift-JIS
Kazakh	Windows 1251
Korean ASCII	Windows 1252
Korean (Hangul)	Windows 949, Hangul
Kyrgyz Cyrillic	Windows 1251
Latin America	Windows 1252
Latvian	Windows 1257
Latvian QWERTY	Windows 1257
Lithuanian	Windows 1257
Lithuanian_IBM	Windows 1257
Macedonian -FYROM	Windows 1251
Maltese_47KEY	Windows 1252
Mongolian-Cyrillic	Windows 1251
Norwegian	Windows 1252
Polish_214	Windows 1250
Polish Programmer	Windows 1250
Portuguese Brazil	Windows 1252
Portuguese Brazilian ABNT	Windows 1252
Portuguese Brazilian ABNT2	Windows 1252
Portuguese Portugal	Windows 1252
Romanian	Windows 1250
Romanian Legacy	Windows 1250
Romanian Standard	Windows 1250
Romanian Programmer	Windows 1250
Russian	Windows 1251
Russian Typewriter	Windows 1251
Serbian Latin	Windows 1250
Serbian Cyrillic	Windows 1251
Slovak	Windows 1250
Slovak QWERTY	Windows 1250
Slovenian	Windows 1250
Spanish	Windows 1252
Spanish Variation	Windows 1252

**Table 26** Country Code Page Defaults (Continued)

Country Keyboard	Code Page Default
Swedish	Windows 1252
Swiss French	Windows 1252
Swiss German	Windows 1252
Tatar	Windows 1251
Thai-Kedmanee	Windows 874
Turkish F	Windows 1254
Turkish Q	Windows 1254
Ukrainian	Windows 1251
United Kingdom	Windows 1252
United States	Windows 1252
US Dvorak	Windows 1252
US Dvorak Left Hand	Windows 1252
US Dvorak Right Hand	Windows 1252
US International	Windows 1252
Uzbek Cyrillic	Windows 1251
Vietnamese	Windows 1258

## Country Code Page Barcodes

### Parameter # 961

Scan the barcode corresponding to the country keyboard code page.

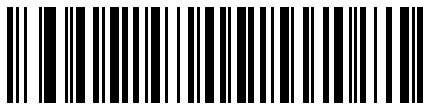

Windows 1250 Latin 2, Central European

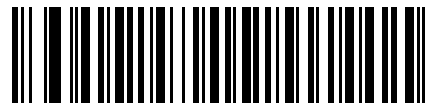

Windows 1251 Cyrillic, Slavic



Windows 1252 Latin 1, Western European



Windows 1254 Latin 5, Turkish

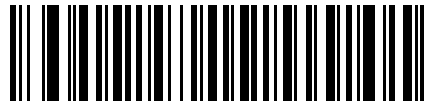

Windows 1256 Arabic

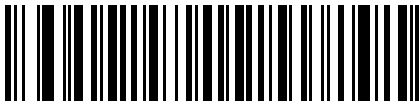

Windows 1258 Vietnamese

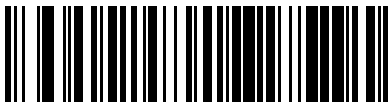

Windows 20866 Cyrillic KOI8-R



Windows 1253 Greek

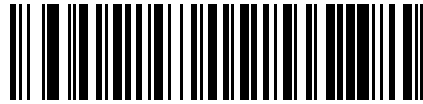

Windows 1255 Hebrew

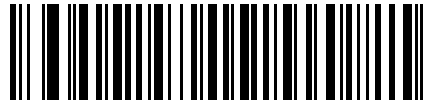

Windows 1257 Baltic

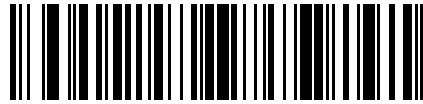

Windows 874 Thai

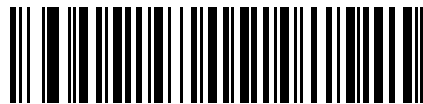

Windows 932 Japanese Shift-JIS



Windows 936 Simplified Chinese GBK



Windows 54936 Simplified Chinese GB18030



Windows 949 Korean Hangul

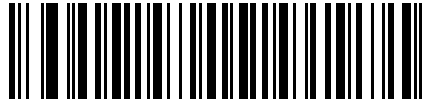

Windows 950 Traditional Chinese Big5

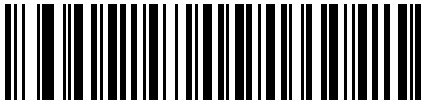

MS-DOS 437 Latin US

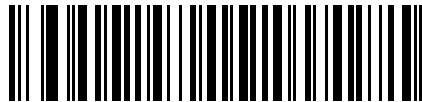

MS-DOS 737 Greek

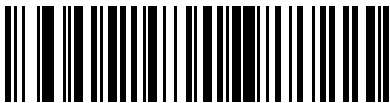

MS-DOS 775 Baltic

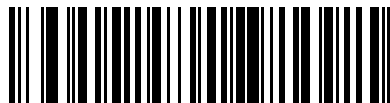

MS-DOS 850 Latin 1

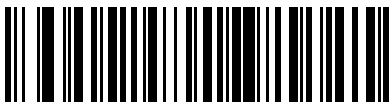

MS-DOS 852 Latin 2



MS-DOS 857 Turkish

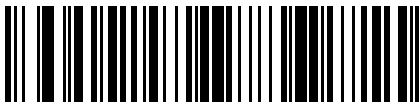

MS-DOS 861 Icelandic

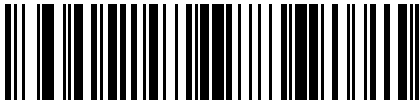

MS-DOS 863 French Canada

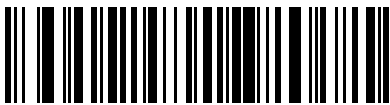

MS-DOS 866 Cyrillic

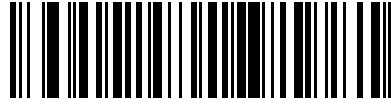

MS-DOS 855 Cyrillic

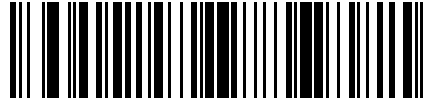

MS-DOS 860 Portuguese

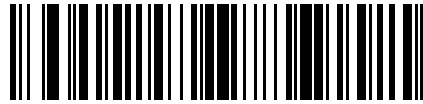

MS-DOS 862 Hebrew

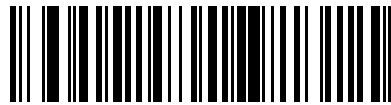

MS-DOS 865 Nordic

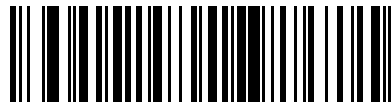

MS-DOS 869 Greek 2



ISO 8859-1 Latin 1, Western European



ISO 8859-2 Latin 2, Central European



ISO 8859-3 Latin 3, South European

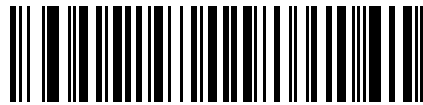

ISO 8859-4 Latin 4, North European

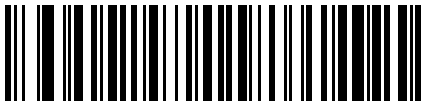

ISO 8859-5 Cyrillic

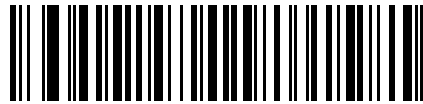

ISO 8859-6 Arabic



ISO 8859-7 Greek

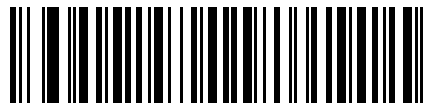

ISO 8859-8 Hebrew

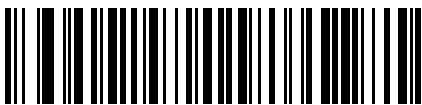

ISO 8859-9 Latin 5, Turkish



ISO 8859-10 Latin 6, Nordic



ISO 8859-11 Thai



ISO 8859-13 Latin 7, Baltic



ISO 8859-14 Latin 8, Celtic



ISO 8859-15 Latin 9

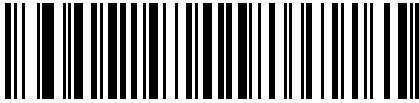

ISO 8859-16 Latin 10, South-Eastern European



UTF-8

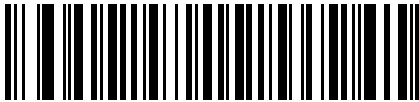

UTF-16LE UTF-16 Little Endian

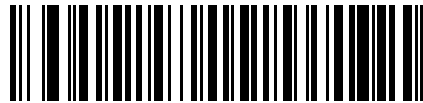

UTF-16BE UTF-16 Big Endian

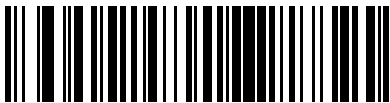

Mac CP10000 Roman

# CJK Decode Control

This appendix describes control parameters for CJK (Chinese, Japanese, Korean) barcode decode through USB HID Keyboard Emulation mode.



**NOTE:** Because ADF does not support CJK character processing, there is no format manipulation for CJK output.

## CJK Control Parameters

### Unicode Output Control

#### Parameter # 973

For a Unicode encoded CJK barcode, select one of the following options for Unicode output:

- Universal Output to Unicode and MBCS Application - This default method applies to Unicode and MBCS expected applications, such as MS Word and Notepad on a Windows host.



**NOTE:** To support Unicode universal output, set up the registry table for the Windows host. See [Unicode/CJD Decode Setup with Windows Host](#).

- Output to Unicode Application Only - This method applies only to Unicode expected applications, such as MS Word and WordPad, but not Notepad.

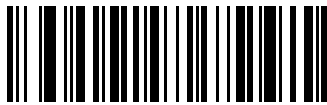

\*Universal Output (0)

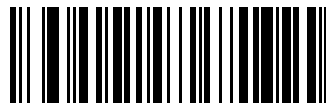

Unicode Application Only (1)

### CJK Output Method to Windows Host

#### Parameter # 972



For a national standard encoded CJK barcode, select one of the following options for CJK output to a Windows host:

- **Universal CJK Output** - This is the default universal CJK output method for US English IME or Chinese/Japanese/Korean ASCII IME on a Windows host. This method converts CJK characters to Unicode and emulates the characters when transmitting to the host. Use the [Unicode Output Control](#) parameter to control Unicode output.



**NOTE:** To support universal CJK output, set up the registry table for the Windows host. See [Unicode/CJK Decode Setup Windows Host](#).

- **Other options for CJK output** - With the following methods, the scanner sends the CJK character hexadecimal internal code (Nei Ma) value to the host, or converts the CJK character to Unicode and sends the hexadecimal Unicode value to the host. When using these methods, the Windows host must select the corresponding IME to accept the CJK character. See [Unicode/CJK Decode Setup Windows Host](#).
- **Japanese Unicode Output**
- **Simplified Chinese GBK Code Output**
- **Simplified Chinese Unicode Output**
- **Korean Unicode Code Output**
- **Traditional Chinese Big5 Code Output** (Windows XP)
- **Traditional Chinese Big5 Code Output** (Windows 7)
- **Traditional Chinese Unicode Code Output** (Windows XP)
- **Traditional Chinese Unicode Code Output** (Windows 7)



**NOTE:** The Unicode emulate output method depends on the host system (Windows XP or Windows 7).



\*Universal CJK Output (0)

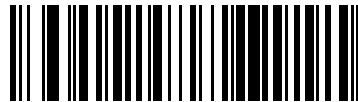

Japanese Unicode Output (34)



Chinese (Simplified) GBK Output (1)



Chinese (Simplified) Unicode Output (2)



Korean Unicode Output (50)

(for Korean Unicode Output, select Simplified Chinese Unicode IME on the Windows host)

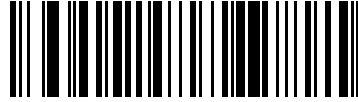

Chinese (Traditional) Big5 Output (Windows XP) (1)



Chinese (Traditional) Big5 Output (Windows 7) (19)

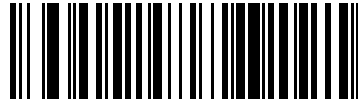

Chinese (Traditional) Unicode Output (Windows XP) (18)

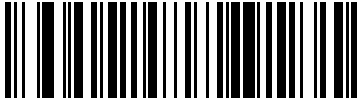

Chinese (Traditional) Unicode Output (Windows 7) (20)

## Non-CJK UTF Barcode Output

### Parameter # 960

Some country keyboard type layouts contain characters that do not exist in the default code page (see below). Although the default code page can not encode these characters in a barcode, they can be encoded in the UTF-8 barcode. Scan the following barcode to output the Unicode values by emulation mode.



**NOTE:** Use this special country keyboard type to decode the non-CJK UTF-8 barcode. After decoding, re-configure the scanner to use the original country keyboard type.

Use US English IME on Windows. See [Unicode Output Control](#).



Non-CJK UTF-8 Emulation Output

**Missing Characters for Country Keyboard Type: Tatar, Uzbek, Mongolian, Kyrgyz, Kazakh and Azeri**

Default code page: CP1251

Missing characters:

#	#
#	#
#	#
#	#
#	#
#	#
#	#
#	#
#	#
#	#
₰	
#	#
#	#
#	#
#	#
#	#

#### Missing Characters for Country Keyboard Type: Romanian (Standard)

Default code page: CP1250

Missing characters:

ș	Ș
ț	Ț

#### Missing Characters for Country Keyboard Type: Portuguese-Brazilian (ABNT), Portuguese-Brazilian (ABNT2)

Default code page: CP1252

Missing character: #

#### Missing Characters for Country Keyboard Type: Azeri-Latin

Default code page: CP1254

Missing characters: ə, Ə

## Unicode/CJK Decode Setup with Windows Host

This section describes how to set up CJK decode with a Windows host.

### Setting Up the Windows Registry Table for Unicode Universal Output

To support the Unicode universal output method, set up the Windows host registry table as follows:

1. Select **Start > Run > regedt32** to start the registry editor.

- Under **HKEY\_Current\_User\Control Panel\Input Method**, set **EnableHexNumpad** to **1** as follows:

```
[HKEY_CURRENT_USER\Control Panel\Input Method]
```

```
"EnableHexNumpad" = "1"
```

If this key does not exist, add it as type **REG\_SZ** (string value).

- Reboot the computer to implement the registry change.

## Adding CJK IME on Windows

To add the desired CJK input language:

- Click **Start > Control Panel**.
- If the Control Panel opens in category view, select **Switch to Classic View** in the top left corner.
- Select **Regional and Language Options**.
- Click the **Language** tab.
- Under **Supplemental Language Support**, select the **Install Files for East Asian Languages** check box if not already selected, and click **Apply**. This may require a Windows installation CD to install the required files. This step ensures that the East Asian Languages (CJK) are available.
- Under **Text Services and Input Language**, click **Details**.
- Under **Installed Services**, click **Add**.
- In the **Add Input Language** dialog box, choose the CJK input language and keyboard layout or Input Method Editor (IME) to add.
- Click **OK** twice. The language indicator appears in the system tray (at bottom right corner of the desktop by default). To switch between input languages (keyboard languages) select the language indicator in the system tray.
- Select the language indicator in the system tray to select the desired country keyboard type.
- Verify that the characters displayed on each country's keyboard appear.

## Selecting the Simplified Chinese Input Method on the Host

To select the Simplified Chinese input method:

- Select Unicode/GBK input on Windows XP: **Chinese (Simplified) - NeiMa**, then click the input bar to select **Unicode** or **GBK NeiMa** input.

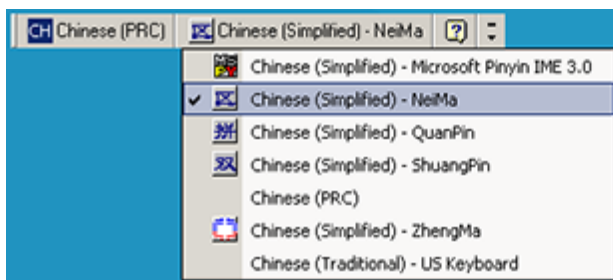

Or



- Select Unicode/GBK input on Windows 7: **Chinese (Simplified) - Microsoft Pinyin New Experience Input Style**, then select **Tool Menu > Secondary Inputs > Unicode Input** or **GB Code Input**.

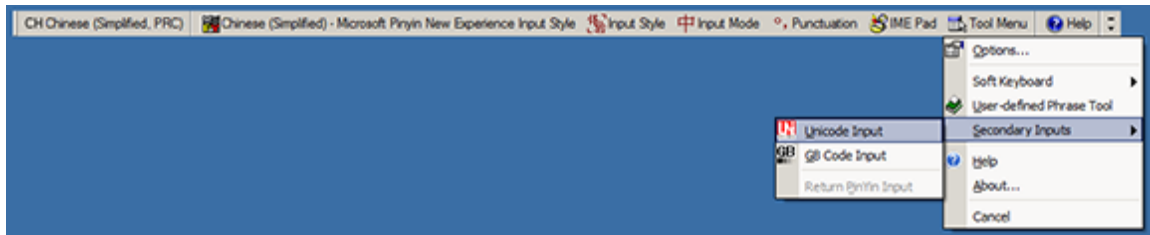

## Selecting the Traditional Chinese Input Method on the Host

To select the Traditional Chinese input method:

- Select Unicode input on Windows XP: **Chinese (Traditional) - Unicode**

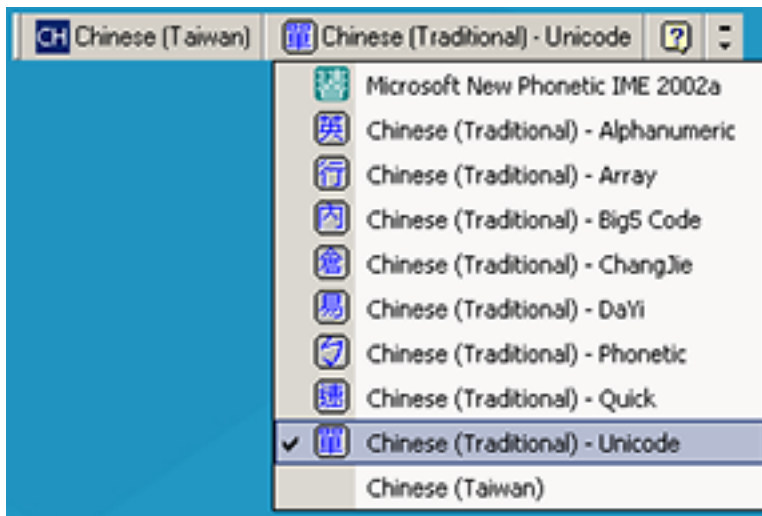

- Select Big5 input on Windows XP: **Chinese (Traditional) - Big5 Code**

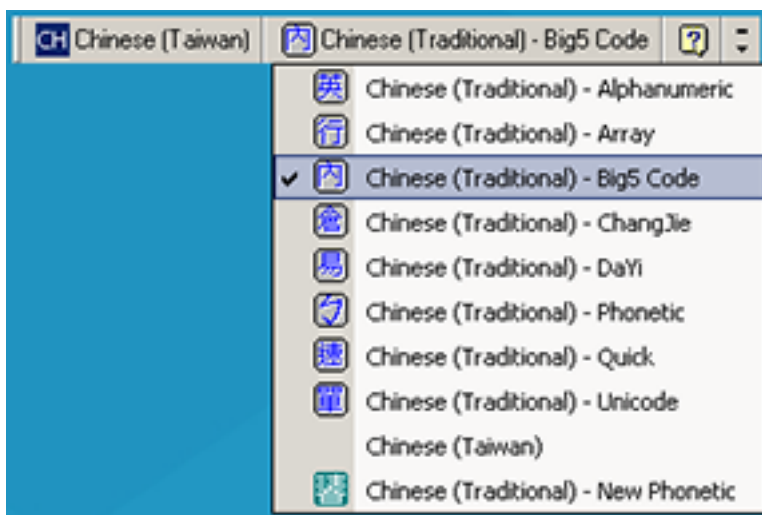

- Select Unicode/Big5 input on Windows 7: **Chinese (Traditional) - New Quick**. This option support both Unicode and Big5 input.

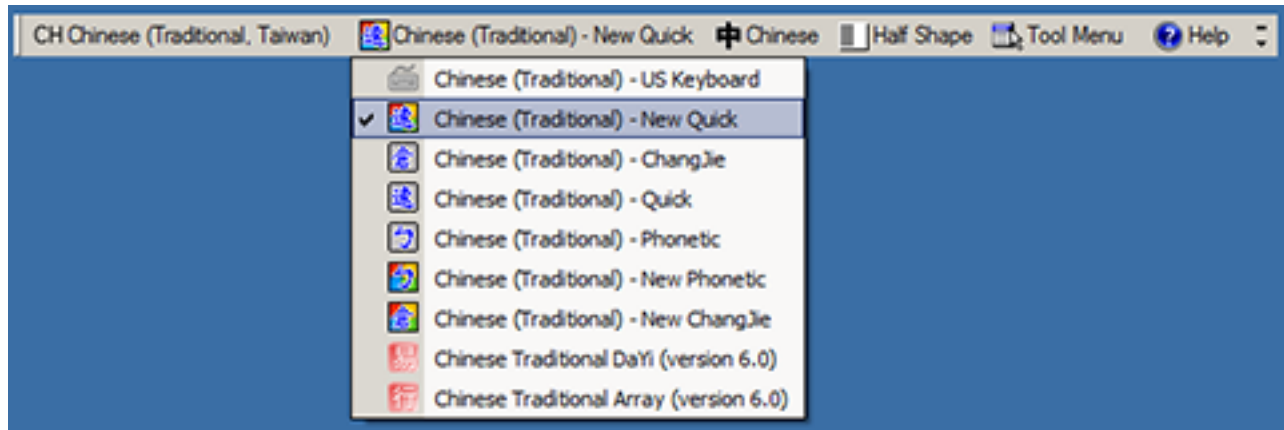

# ASCII Character Sets



**NOTE:** For the Keyboard Wedge Interface, Code 39 Full ASCII interprets the barcode special character (\$ + % /) preceding a Code 39 character and assigns an ASCII character value to the pair. For example, if you enable Code 39 Full ASCII and scan +B, it transmits as b, %J as ?, and %V as @. Scanning ABC%l outputs the keystroke equivalent of ABC >.

ASCII Value (Prefix/ Suffix Value)	Full ASCII Code 39 Encode Char	Keystroke	ASCII Character (Applies to RS-232 Only)
1000	%U	CTRL 2	NUL
1001	\$A	CTRL A	SOH
1002	\$B	CTRL B	STX
1003	\$C	CTRL C	ETX
1004	\$D	CTRL D	EOT
1005	\$E	CTRL E	ENQ
1006	\$F	CTRL F	ACK
1007	\$G	CTRL G	BELL
1008	\$H	CTRL H/BACKSPACE <sup>a</sup>	BCKSPC
1009	\$I	CTRL I/HORIZONTAL TAB <sup>b</sup>	HORIZ TAB
1010	\$J	CTRL J	LF/NW LN
1011	\$K	CTRL K	VT
1012	\$L	CTRL L	FF
1013	\$M	CTRL M/ENTER <sup>c</sup>	CR/ENTER
1014	\$N	CTRL N	SO
1015	\$O	CTRL O	SI
1016	\$P	CTRL P	DLE
1017	\$Q	CTRL Q	DC1/XON
1018	\$R	CTRL R	DC2
1019	\$S	CTRL S	DC3/XOFF
1020	\$T	CTRL T	DC4
1021	\$U	CTRL U	NAK

## ASCII Character Sets

ASCII Value (Prefix/ Suffix Value)	Full ASCII Code 39 Encode Char	Keystroke	ASCII Character (Applies to RS-232 Only)
1022	\$V	CTRL V	SYN
1023	\$W	CTRL W	ETB
1024	\$X	CTRL X	CAN
1025	\$Y	CTRL Y	EM
1026	\$Z	CTRL Z	SUB
1027	%A	CTRL [	ESC
1028	%B	CTRL \	FS
1029	%C	CTRL ]	GS
1030	%D	CTRL 6	RS
1031	%E	CTRL -	US
1032	Space	Space	Space
1033	/A	!	!
1034	/B	"	"
1035	/C	#	#
1036	/D	\$	\$
1037	/E	%	%
1038	/F	&	&
1039	/G	'	'
1040	/H	(	(
1041	/I	)	)
1042	/J	*	*
1043	/K	+	+
1044	/L	,	,
1045	-	-	-
1046	.	.	.
1047	/o	/	/
1048	0	0	0
1049	1	1	1
1050	2	2	2
1051	3	3	3
1052	4	4	4
1053	5	5	5
1054	6	6	6
1055	7	7	7
1056	8	8	8



## ASCII Character Sets

ASCII Value (Prefix/ Suffix Value)	Full ASCII Code 39 Encode Char	Keystroke	ASCII Character (Applies to RS-232 Only)
1057	9	9	9
1058	/Z	:	:
1059	%F	;	;
1060	%G	<	<
1061	%H	=	=
1062	%I	>	>
1063	%J	?	?
1064	%V	@	@
1065	A	A	A
1066	B	B	B
1067	C	C	C
1068	D	D	D
1069	E	E	E
1070	F	F	F
1071	G	G	G
1072	H	H	H
1073	I	I	I
1074	J	J	J
1075	K	K	K
1076	L	L	L
1077	M	M	M
1078	N	N	N
1079	O	O	O
1080	P	P	P
1081	Q	Q	Q
1082	R	R	R
1083	S	S	S
1084	T	T	T
1085	U	U	U
1086	V	V	V
1087	W	W	W
1088	X	X	X
1089	Y	Y	Y
1090	Z	Z	Z
1091	%K	[	[

## ASCII Character Sets

ASCII Value (Prefix/ Suffix Value)	Full ASCII Code 39 Encode Char	Keystroke	ASCII Character (Applies to RS-232 Only)
1092	%L	\	\
1093	%M	]	]
1094	%N	^	^
1095	%O	_	_
1096	%W	`	`
1097	+A	a	a
1098	+B	b	b
1099	+C	c	c
1100	+D	d	d
1101	+E	e	e
1102	+F	f	f
1103	+G	g	g
1104	+H	h	h
1105	+I	i	i
1106	+J	j	j
1107	+K	k	k
1108	+L	l	l
1109	+M	m	m
1110	+N	n	n
1111	+O	o	o
1112	+P	p	p
1113	+Q	q	q
1114	+R	r	r
1115	+S	s	s
1116	+T	t	t
1117	+U	u	u
1118	+V	v	v
1119	+W	w	w
1120	+X	x	x
1121	+Y	y	y
1122	+Z	z	z
1123	%P	{	{
1124	%Q		
1125	%R	}	}
1126	%S	~	~

## ASCII Character Sets

ASCII Value (Prefix/ Suffix Value)	Full ASCII Code 39 Encode Char	Keystroke	ASCII Character (Applies to RS-232 Only)
1127			Undefined
7013			ENTER

<sup>a</sup> The keystroke in bold transmits only if you enabled Function Key Mapping. Otherwise, the unbold keystroke transmits.

<sup>b</sup> The keystroke in bold transmits only if you enabled Function Key Mapping. Otherwise, the unbold keystroke transmits.

<sup>c</sup> The keystroke in bold transmits only if you enabled Function Key Mapping. Otherwise, the unbold keystroke transmits.

**Table 27** ALT Key Character Set

ALT Keys	Keystroke
2045	ALT -
2050	ALT 2
2054	ALT 6
2064	ALT @
2065	ALT A
2066	ALT B
2067	ALT C
2068	ALT D
2069	ALT E
2070	ALT F
2071	ALT G
2072	ALT H
2073	ALT I
2074	ALT J
2075	ALT K
2076	ALT L
2077	ALT M
2078	ALT N
2079	ALT O
2080	ALT P
2081	ALT Q
2082	ALT R
2083	ALT S
2084	ALT T
2085	ALT U

**Table 27** ALT Key Character Set (Continued)

ALT Keys	Keystroke
2086	ALT V
2087	ALT W
2088	ALT X
2089	ALT Y
2090	ALT Z
2091	ALT [
2092	ALT \
2093	ALT ]



**NOTE:** GUI Shift Keys - The Apple™ iMac keyboard has an apple key on either side of the space bar. Windows-based systems have a GUI key to the left of the left ALT key, and to the right of the right ALT key.

**Table 28** GUI Key Character Set

GUI Key	Keystroke
3000	Right Control Key
3048	GUI 0
3049	GUI 1
3050	GUI 2
3051	GUI 3
3052	GUI 4
3053	GUI 5
3054	GUI 6
3055	GUI 7
3056	GUI 8
3057	GUI 9
3065	GUI A
3066	GUI B
3067	GUI C
3068	GUI D
3069	GUI E
3070	GUI F
3071	GUI G
3072	GUI H

**Table 28** GUI Key Character Set (Continued)

GUI Key	Keystroke
3073	GUI I
3074	GUI J
3075	GUI K
3076	GUI L
3077	GUI M
3078	GUI N
3079	GUI O
3080	GUI P
3081	GUI Q
3082	GUI R
3083	GUI S
3084	GUI T
3085	GUI U
3086	GUI V
3087	GUI W
3088	GUI X
3089	GUI Y
3090	GUI Z

**Table 29** PF Key Character Set

PF Keys	Keystroke
4001	PF 1
4002	PF 2
4003	PF 3
4004	PF 4
4005	PF 5
4006	PF 6
4007	PF 7
4008	PF 8
4009	PF 9
4010	PF 10
4011	PF 11
4012	PF 12

**Table 29** PF Key Character Set (Continued)

PF Keys	Keystroke
4013	PF 13
4014	PF 14
4015	PF 15
4016	PF 16

**Table 30** F Key Character Set

F Keys	Keystroke
5001	F 1
5002	F 2
5003	F 3
5004	F 4
5005	F 5
5006	F 6
5007	F 7
5008	F 8
5009	F 9
5010	F 10
5011	F 11
5012	F 12
5013	F 13
5014	F 14
5015	F 15
5016	F 16
5017	F 17
5018	F 18
5019	F 19
5020	F 20
5021	F 21
5022	F 22
5023	F 23
5024	F 24

**Table 31** Numeric Key Character Set

Numeric Keypad	Keystroke
6042	*
6043	+
6044	Undefined
6045	-
6046	.
6047	/
6048	0
6049	1
6050	2
6051	3
6052	4
6053	5
6054	6
6055	7
6056	8
6057	9
6058	Enter
6059	Num Lock

**Table 32** Extended Key Character SetExtended Keypad

Extended Keypad	Keystroke
7001	Break
7002	Delete
7003	Pg Up
7004	End
7005	Pg Dn
7006	Pause
7007	Scroll Lock
7008	Backspace
7009	Tab
7010	Print Screen
7011	Insert
7012	Home

**Table 32** Extended Key Character SetExtended Keypad (Continued)

Extended Keypad	Keystroke
7013	Enter
7014	Escape
7015	Up Arrow
7016	Dn Arrow
7017	Left Arrow
7018	Right Arrow



# RSM Attributes

Remote Scanner Manager (RSM) attributes can be used to query information, like Serial Number and Battery Percentage, from a connected RS6100 scanner. The following table describes various attributes and their attribute numbers.

**Table 33** Remote Scanner Manager (RSM) Attributes

Attribute Description	Attribute Number
Model Number	533
Serial Number	534
Date of Manufacture	535
Date of Service	536
Bluetooth MAC Address	541
Firmware Version	20004
Battery Voltage	30010
Battery Percentage	30012
Battery State of Health	30013
Battery Model Number	30017
Battery Manufacture Date	30018
Battery Full Charge Capacity	30020

# BLE Beacons Parameter Defaults

BLE Beacons can be customized by programming various parameters and attributes.

BLE Beacons is designed to prevent the loss of scanners. A scanner emits an alert when it is about to lose its connection to a host device. Loss of connection may result when the scanner:

- reaches a low battery level
- stays inactive for too long
- moves too far away from the host

To enable beacons, one of the following three parameters must be enabled:

- [Beacon Upon Disconnection](#)
- [Unpaired Beacons](#)
- [Beacon Battery Threshold](#)



**NOTE:** Beacons is disabled when the Beacon Battery, Beacons Upon Disconnection, and Unpaired Beacons parameters are disabled.

You can program all of the specific definitions for triggering the BLE Beacons alert using the parameters listed in the following parameter defaults table.

## BLE Beacons Parameter Defaults

**Table 34** BLE Beacons Parameter Defaults

Parameter	Parameter Number	Default
<a href="#">Low Power Mode*</a>	128	Enable
<a href="#">Reconnect Attempt Interval</a>	558	30 seconds
<a href="#">Auto-reconnect</a>	604	Immediately
<a href="#">Bluetooth Friendly Name*</a>	607	N/A
<a href="#">Discoverable Mode*</a>	610	General
<a href="#">Apple iOS Virtual Keyboard Toggle*</a>	1114	Disable
<a href="#">Wi-Fi Friendly Channel Exclusion*</a>	1297	Use all Channels (Standard AFH)
<a href="#">Wi-Fi Friendly Mode*</a>	1299	Disable

**Table 34** BLE Beacons Parameter Defaults (Continued)

Radio Output Power	1324	High
Battery Threshold	1367, 1368, 1369	N/A
Bluetooth Security Level*	1393	N/A
Link Supervision Timeout*	1698	2 seconds
Auto Un-Pairing	1708	Disable
Beacon Upon Disconnection	2403	Disable
Unpaired Beacons	2404	Disable
Beacons Beep	2405	Disable
Beacon Frequency	2406	100
Beacon Battery Threshold	2407	30
Beacon ID	N/A	N/A
Scanner Alias	2410	Bluetooth-Friendly Name

 **NOTE:** \*Configure these parameters before pairing the scanner with a host device. Changing these parameters in a connected scanner may cause it to reset.

**Table 35** BLE Beacons Attributes

Attribute	Attribute Number
Model Number	533
Serial Number	534
Date of Manufacture	535
Date of Service	536
Bluetooth MAC Address	541
Paging Activate	6032
ATT Beacon Command	6052
Firmware Version	20004
Device Type	20007
Ring Scanner Firmware Package Version	20012
Beacon ID	20036
Ring Scanner Battery Status	30009
Battery Percentage	30012
Battery State of Health	30013
Battery Model Number	30017
Battery Manufacture Date	30018

## Beaconing and Battery Use

Use the following table to estimate how long a scanner will scan before entering into power-saving mode.

Beaconing and scanning both use battery power. The following table shows how well the battery performs when the battery threshold (parameter 2407) is set to the default value of 37% at various temperatures. These results were calculated assuming:

- use of an extended battery
- beginning the shift with a fully charged battery
- scanning with a 100% success rate

Scans per Minute	Room Temperature	-20°C	-30°C
8	Exceeds	Exceeds	Meets Marginally
10	Meets Easily	Exceeds	Meets Marginally
12	Meets Easily	Meets Easily	Meets Marginally
16	Meets Marginally	Meets Marginally	Meets Marginally

A battery beacons for a minimum of 48 hours before it is fully drained. The beaconing battery life is calculated assuming:

- beaconing occurs within the operating temperature of the scanner
- use of an extended battery
- beaconing begins with a battery level of 37%

## BLE Beaconing Attributes

### Model Number

Attribute #533

number of the scanner. This electronic output matches the printout on the physical device label.

Type	S
Size (Bytes)	18
User Mode Access	R
Values	Variable

### Serial Number

Attribute #534

Unique serial number assigned in the manufacturing facility. This electronic output matches the printout on the physical device label, for example M1J26F45V.

Type	S
Size (Bytes)	16

User Mode Access	R
Values	Variable

## Date of Manufacture

Attribute #535

Date of device manufacture assigned in the manufacturing facility. This electronic output matches the printout on the physical device label, for example 30APR14 (which reads the 30th of April 2014).

Type	S
Size (Bytes)	7
User Mode Access	R
Values	Variable

## Firmware Version

Attribute #20004

The scanner's operating system version. For example, NBRFMAAC or PAAAABS00-007-R03D0.

Type	S
Size (Bytes)	Variable
User Mode Access	R
Values	Variable

# Communication Protocol Functionality

This section provides information about functionality supported via communication (cable) interface. [The following table](#) lists supported scanner functionality by communication protocol.

**Table 36** Communication Interface Functionality

Communication Interfaces	Functionality		
	Data Transmission	Remote Management	Image and Video Transmission
USB			
HID Keyboard Emulation	Supported	Not Available	Not Available
CDC COM Port Emulation	Supported	Not Available	Not Available
SSI over CDC COM Port Emulation	Supported	Supported	Supported
IBM Table-top USB	Supported	Supported	Not Available
IBM Hand-held USB	Supported	Supported	Not Available
USB OPOS Hand-held	Supported	Supported	Not Available
Symbol Native API (SNAPI) without Imaging Interface	Supported	Supported	Not Available
Symbol Native API (SNAPI) with Imaging Interface	Supported	Supported	Supported
RS-232			
Standard RS-232	Supported	Not Available	Not Available
ICL RS-232	Supported	Not Available	Not Available
Fujitsu RS-232	Supported	Not Available	Not Available
Wincor-Nixdorf RS-232 Mode A	Supported	Not Available	Not Available
Wincor-Nixdorf RS-232 Mode B	Supported	Not Available	Not Available
Olivetti ORS4500	Supported	Not Available	Not Available
Omron	Supported	Not Available	Not Available
CUTE	Supported	Not Available	Not Available
OPOS/JPOS	Supported	Not Available	Not Available
SSI	Supported	Supported	Supported

**Table 36** Communication Interface Functionality (Continued)

Communication Interfaces	Functionality		
	Data Transmission	Remote Management	Image and Video Transmission
IBM 4690			
Hand-held Scanner Emulation (Port 9B)	Supported	Not Available	Not Available
Table-top Scanner Emulation (Port 17)	Supported	Supported	Not Available
Non-IBM Scanner Emulation (Port 5B)	Supported	Supported	Not Available
Keyboard Wedge			
IBM PC/AT & IBM PC Compatibles	Supported	Not Available	Not Available
IBM AT Notebook	Supported	Not Available	Not Available

