

# MC93XX

Mobile Computer

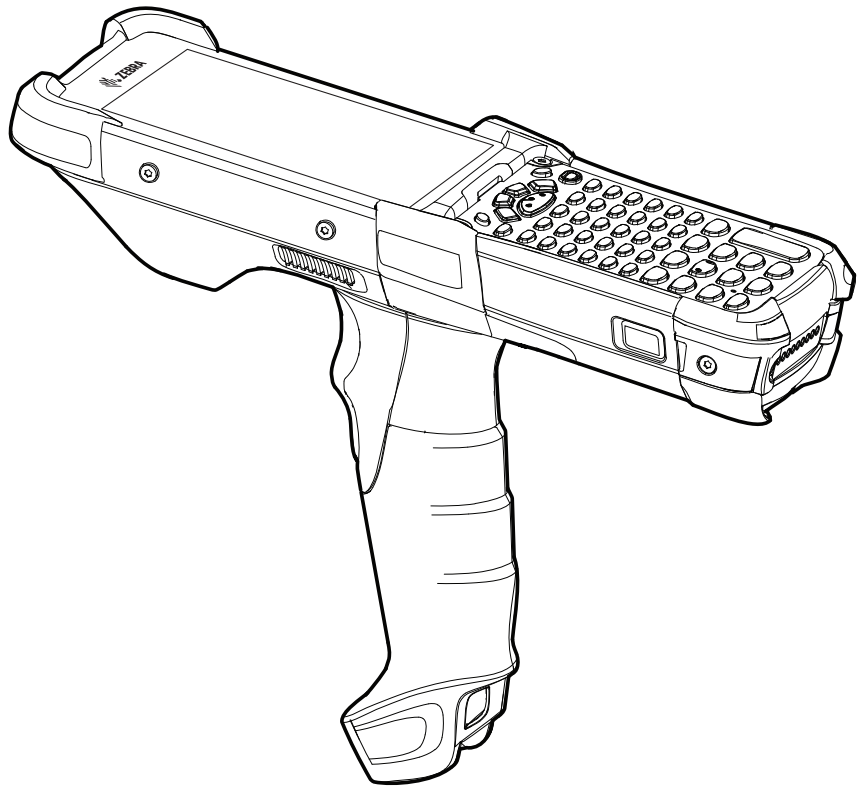

## User Guide

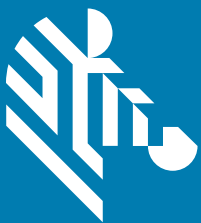

**ZEBRA**

# Copyright

ZEBRA and the stylized Zebra head are trademarks of Zebra Technologies Corporation, registered in many jurisdictions worldwide. Google, Android, Google Play and other marks are trademarks of Google LLC. All other trademarks are the property of their respective owners. ©2020 Zebra Technologies Corporation and/or its affiliates. All rights reserved.

COPYRIGHTS & TRADEMARKS: For complete copyright and trademark information, go to [www.zebra.com/copyright](http://www.zebra.com/copyright).

WARRANTY: For complete warranty information, go to [www.zebra.com/warranty](http://www.zebra.com/warranty).

END USER LICENSE AGREEMENT: For complete EULA information, go to [www.zebra.com/eula](http://www.zebra.com/eula).

# Terms of Use

- Proprietary Statement

This manual contains proprietary information of Zebra Technologies Corporation and its subsidiaries (“Zebra Technologies”). It is intended solely for the information and use of parties operating and maintaining the equipment described herein. Such proprietary information may not be used, reproduced, or disclosed to any other parties for any other purpose without the express, written permission of Zebra Technologies.

- Product Improvements

Continuous improvement of products is a policy of Zebra Technologies. All specifications and designs are subject to change without notice.

- Liability Disclaimer

Zebra Technologies takes steps to ensure that its published Engineering specifications and manuals are correct; however, errors do occur. Zebra Technologies reserves the right to correct any such errors and disclaims liability resulting therefrom.

- Limitation of Liability

In no event shall Zebra Technologies or anyone else involved in the creation, production, or delivery of the accompanying product (including hardware and software) be liable for any damages whatsoever (including, without limitation, consequential damages including loss of business profits, business interruption, or loss of business information) arising out of the use of, the results of use of, or inability to use such product, even if Zebra Technologies has been advised of the possibility of such damages. Some jurisdictions do not allow the exclusion or limitation of incidental or consequential damages, so the above limitation or exclusion may not apply to you.

# Revision History

Changes to the original guide are listed below:

Change	Date	Description
-01 Rev A	03/2019	Initial release.
-02 Rev A	07/2019	Updated to include MC93XX freezer configuration.
-03 Rev A	10/2019	Updated to include SE4750 Direct Part Marking (DPM)/Direct Part Marking - Wide (DPW), SE4770 scanner, and additional keypads.
-04 Rev A	02/2020	Updated Installing a microSD Card section with supported SD cards.
-05 Rev A	03/2020	Changed KeyManager to KeyMappingMgr in the Keypads chapter.

# Table of Contents

Copyright .....	2
Terms of Use .....	2
Revision History .....	2
<b>About This Guide .....</b>	<b>10</b>
Introduction .....	10
Documentation Set .....	10
Configurations .....	11
Software Versions .....	11
Chapter Descriptions .....	12
Notational Conventions .....	12
Related Documents .....	13
Service Information .....	13
Provide Documentation Feedback .....	14
<b>Getting Started .....</b>	<b>15</b>
Introduction .....	15
Unpacking .....	15
Device Features .....	16
Setup .....	19
Installing a microSD Card .....	19
Backup Power .....	24
Charging Temperature .....	24
Charging Spare Batteries .....	24
Google Account Setup .....	24
Zebra Visibility Services .....	25
Replacing the Battery in the Device .....	25
Hot Swap Mode .....	27
Accessing Device Settings .....	28
Battery Management .....	28

## Table of Contents

Monitoring Battery Usage .....	28
Low Battery Notification .....	29
Battery Optimization .....	29
Real-Time Clock Backup .....	30
Setting the Date and Time .....	30
Display Settings .....	30
Setting the Screen Brightness .....	30
Setting Screen Timeout .....	31
Setting Screen Rotation .....	31
Setting Font Size .....	31
Setting Display Size .....	32
Ambient Display .....	33
Touch Panel Mode .....	33
Keyboard Backlight .....	34
Setting Notification LED .....	35
General Sound Setting .....	35
Wake-Up Sources .....	36
<b>Using the Device .....</b>	<b>38</b>
Introduction .....	38
Google Mobile Services .....	38
Home Screen .....	38
Home Screen .....	39
Setting Home Screen Rotation .....	39
Status Bar .....	40
Status Icons .....	40
Notification Icons .....	42
Managing Notifications .....	42
Setting App Notifications .....	43
Viewing Notification Settings for All Apps .....	44
Controlling Lock Screen Notifications .....	44
Notification Indicator .....	44
Quick Access Panel .....	44
Editing Icons on Quick Settings .....	45
App Shortcuts and Widgets .....	46
Adding an App Shortcut to the Home Screen .....	46
Adding a Widget to the Home Screen .....	46
Moving Items on the Home Screen .....	47
Removing an App Shortcut or Widget from the Home Screen .....	47
Folders .....	47
Creating a Folder .....	47
Naming Folders .....	47
Removing a Folder .....	48

## Table of Contents

Home Screen Wallpaper .....	48
Using the Touchscreen .....	48
Keyboards .....	49
Virtual Keyboard Configuration .....	49
Enabling Virtual Keyboards .....	49
Switching Between Virtual Keyboards .....	49
Physical Keyboard Configuration .....	49
Enabling Physical Keyboards .....	49
Using the Enterprise Keyboard .....	49
Numeric Tab .....	50
Alpha Tab .....	50
Additional Character Tab .....	50
Scan Tab .....	51
Do Not Disturb Feature .....	51
Limit Sounds and Vibrations .....	51
Total Silence .....	51
Alarms Only .....	52
Priority Notifications Only .....	52
Silence Sounds During Certain Times .....	53
Silence Sounds During Events and Meetings .....	53
Turn Sounds Back On .....	53
Override Do Not Disturb for Specific Apps .....	54
Apps .....	54
Accessing Apps .....	57
Switching Between Recent Apps .....	57
Un-Locking the Screen .....	58
Smart Lock .....	60
Resetting the Device .....	61
Performing a Soft Reset .....	62
Performing a Hard Reset .....	62
Suspend Mode .....	62
Transferring Files with a Host Computer via USB .....	62
Transferring Files .....	62
Transferring Photos .....	63
Disconnect from the Host Computer .....	63
<b>Applications .....</b>	<b>64</b>
Introduction .....	64
Battery Manager .....	64
Heater Control .....	67
Status .....	67
Advanced .....	68
Files .....	70

## Table of Contents

Contacts .....	71
Adding a Contact .....	71
Editing Contacts .....	71
Deleting Contacts .....	71
Camera .....	72
Taking Photos .....	73
Taking a Panoramic Photo .....	74
Recording Videos .....	74
Photo Settings .....	75
Rear Camera .....	76
Video Settings .....	76
Rear Camera .....	77
Photos .....	78
Working with Albums .....	79
Sharing an Album .....	80
Deleting an Album .....	80
Working with Photos .....	81
Viewing and Browsing Photos .....	81
Cropping a Photo .....	81
Setting a Photo as a Contact Icon .....	82
Sharing a Photo .....	82
Deleting a Photo .....	83
Working with Videos .....	83
Watching a Video .....	83
Sharing a Video .....	83
Deleting a Video .....	83
DataWedge Demonstration .....	84
Scanner Selection .....	85
Sound Recorder .....	86
PTT Express Voice Client .....	86
PTT Audible Indicators .....	87
PTT Notification Icons .....	87
Enabling PTT Communication .....	87
Selecting a Talk Group .....	88
PTT Communication .....	88
Creating a Group Call .....	88
Responding with a Private Response .....	88
Disabling PTT Express Voice Client Communication .....	89
RxLogger .....	90
RxLogger Utility .....	91
Diagnostic Tool .....	92
Settings .....	95
Battery Test Information .....	95

## Table of Contents

GPS Test Information .....	96
System Test Information .....	96
WLAN Test Information .....	96
WWAN Test Information .....	96
Bluetooth Test Information .....	96
Device Central .....	97
Paging an RS6000 Ring Scanner .....	98
<b>Data Capture.....</b>	<b>99</b>
Introduction .....	99
Integrated Imager .....	99
Operational Modes .....	99
Laser Scanner .....	100
RS507/RS507X Hands-Free Imager .....	100
RS6000 Bluetooth Ring Scanner .....	100
DS3678 Digital Scanner .....	100
Scanning Considerations .....	101
Barcode Capture with Imager .....	101
Barcode Capture with Laser Scanner .....	102
Scanning with RS507/RS507X Hands-Free Imager .....	103
Scanning with RS6000 Bluetooth Ring Scanner .....	105
Scanning with the DS3608 USB Scanner or DS3678 Bluetooth Scanner .....	106
Pairing the RS507/RS507X/RS6000 Hands-Free Imager .....	107
Pairing Using Near Field Communication .....	107
Pairing in HID Mode Using Near Field Communication .....	108
Pairing Using Simple Serial Interface (SSI) .....	109
Pairing Using Bluetooth Human Interface Device .....	110
Pairing a Bluetooth Scanner .....	111
Pairing Using Bluetooth Human Interface Device .....	111
DataWedge .....	112
Enabling DataWedge .....	113
Disabling DataWedge .....	113
<b>Wireless .....</b>	<b>114</b>
Introduction .....	114
Wireless Local Area Networks .....	114
Connecting to a Wi-Fi Network .....	114
Removing a Wi-Fi Network .....	116
Bluetooth .....	116
Adaptive Frequency Hopping .....	116

## Table of Contents

Security .....	117
Bluetooth Profiles .....	117
Bluetooth Power States .....	118
Bluetooth Radio Power .....	118
Enabling Bluetooth .....	118
Disabling Bluetooth .....	119
Discovering Bluetooth Device(s) .....	119
Changing the Bluetooth Name .....	119
Connecting to a Bluetooth Device .....	119
Selecting Profiles on the Bluetooth Device .....	120
Unpairing a Bluetooth Device .....	120
Using a Bluetooth Headset .....	120
Near Field Communications .....	120
Reading NFC Cards .....	121
Sharing Information Using NFC .....	122
Cast .....	122
<b>Accessories .....</b>	<b>123</b>
Introduction .....	123
MC93XX Accessories .....	123
1-Slot USB Charge Cradle with Spare Battery Charger .....	127
Charging the Battery .....	128
Charging Temperature .....	128
4-Slot Charge Only ShareCradle .....	129
Charging the Battery .....	129
Battery Charging in the 4-Slot Charge Only ShareCradle .....	130
Charging Temperature .....	130
4-Slot Ethernet ShareCradle .....	131
Battery Charging in the 4-Slot Ethernet ShareCradle .....	131
Charging Temperature .....	132
4-Slot Spare Battery Charger .....	133
16-Slot Spare Battery Charger .....	134
USB Charge/Com Snap-on Cup .....	135
Connecting the USB Charge Cable to Device .....	136
Connecting the USB Charge/Com Snap-on Cup Cable to Host Computer .....	136
Charging the Device .....	138
Disconnecting the USB Charge/Com Snap-on Cup .....	138
MC93XX Charge Only Adapter .....	140
Charge Only Adapter Installation .....	141
Rubber Boot .....	143
Installing the Hand Strap .....	145
Un-powered Forklift Mount .....	146



<b>Maintenance and Troubleshooting .....</b>	<b>148</b>
Introduction .....	148
Maintaining the Device .....	148
Battery Safety Guidelines .....	148
Cleaning Instructions .....	149
Approved Cleanser Active Ingredients .....	149
Harmful Ingredients .....	149
Device Cleaning Instructions .....	150
Special Cleaning Notes .....	150
Cleaning Materials Required .....	150
Cleaning Frequency .....	150
Cleaning the Device .....	150
Housing .....	150
Display .....	150
Exit Window .....	151
Cleaning Battery Connectors .....	151
Cleaning Cradle Connectors .....	151
Troubleshooting .....	152
MC93XX .....	152
 <b>Specifications.....</b>	 <b>155</b>
Introduction .....	155
MC93XX Technical Specifications .....	155
 <b>Keypads .....</b>	 <b>159</b>
Introduction .....	159
Removing and Replacing Keypads .....	159
58-Keys Alpha Numeric Function Keypad .....	163
53-Keys Standard Keypad .....	166
53-Keys IBM-5250 Emulator Keypad .....	169
53-Keys IBM-3270 Emulator Keypad .....	172
53-Keys VT Emulator Keypad .....	175
43-Keys Shifted Alpha Keypad .....	178
34-Keys Numeric Keypad .....	181
29-Keys Shifted Alpha Keypad .....	184
Keypad Special Functions .....	187
Special Characters .....	188
 <b>Index.....</b>	 <b>190</b>

# About This Guide

## Introduction

This guide provides information about using the MC93XX mobile computer and accessories.



**NOTE:** Screens pictured in this guide are samples and can differ from actual screens.

## Documentation Set

The documentation set provides information for specific user needs, and includes:

- MC93XX Quick Start Guide - describes how to get the device up and running.
- MC93XX User Guide - describes how to use the device.
- MC93XX Integrator Guide - describes how to set up the device and accessories.
- MC93XX Regulatory Guide - provides all regulatory, service, and EULA information for the device.

## Configurations

MC93XX used in this guide refers to all configurations, except where noted. MC93XX refers to the Trigger configuration.

This guide covers the following configurations:

Table 1 Configurations

Configuration	Radios	Display	Memory	Data Capture Options	Operating System
MC93XX–G Base	WLAN: IEEE 802.11 a/b/g/n/ac/d/h/i/r/w WPAN: Bluetooth v5.0 Low Energy	4.3" WVGA (800 x 480) LCD	4 GB RAM / 32 GB Flash	SE965 1D, SE4750-SR 2D, SE4850-ER 2D SE4750DPM SE4750DPW SE4770 2D	Android-based GMS 8.1.0
Package 1 MC93XX–G Base + NFC (Tap to Pair) + Vibrator Motor	WLAN: IEEE 802.11 a/b/g/n/ac/d/h/i/r/w WPAN: Bluetooth v5.0 Low Energy	4.3" WVGA (800 x 480) LCD	4 GB RAM / 32 GB Flash	SE965 1D, SE4750-SR 2D, SE4850-ER 2D SE4750DPM SE4750DPW SE4770 2D	Android-based GMS 8.1.0
Package 2 Package 1 + Front and Rear Facing Cameras	WLAN: IEEE 802.11 a/b/g/n/ac/d/h/i/r/w WPAN: Bluetooth v5.0 Low Energy	4.3" WVGA (800 x 480) LCD	4 GB RAM / 32 GB Flash	SE965 1D, SE4750-SR 2D, SE4850-ER 2D SE4770 2D	Android-based GMS 8.1.0
MC93XX-G Freezer + NFC (Tap to Pair) + Vibrator Motor	WLAN: IEEE 802.11 a/b/g/n/ac/d/h/i/r/w WPAN: Bluetooth v5.0 Low Energy	4.3" WVGA (800 x 480) LCD. Optically Bonded to the Touch Panel.	4 GB RAM / 32 GB Flash	SE965 1D, SE4750-SR 2D, SE4850-ER 2D SE4770 2D	Android-based GMS 8.1.0

## Software Versions

To determine the current software versions:

1. Swipe down from the Status bar to open the Quick Settings bar.
2. Touch  > **System**.
3. Touch **About phone**.

4. Scroll to view the following information:

- **Status**
- **Battery information**
- **SW components**
- **Legal information**
- **Model**
- **Android version**
- **Android security patch level**
- **Kernel version**
- **Build Fingerprint**
- **Build number.**

To determine the device serial number, touch **About phone > Status**.

- **Serial number**

## Chapter Descriptions

Topics covered in this guide are as follows:

- [Getting Started](#) provides information on getting the device up and running for the first time.
- [Using the Device](#) provides basic instructions for using the device with Android OS, including powering on and resetting the device.
- [Applications](#) describes the applications installed on the device.
- [Data Capture](#) provides information for capturing barcode data using the internal scanner and optional scan modules and Bluetooth scanner.
- [Wireless](#) provides information on the various wireless options.
- [Accessories](#) describes the available accessories and how to use them with the device.
- [Maintenance and Troubleshooting](#) includes instructions on cleaning and storing the device, and provides troubleshooting solutions for potential problems during device operation.
- [Specifications](#) provides the technical specifications for the device.
- [Keypads](#) provides keypad descriptions and special character generation tables.

## Notational Conventions

The following conventions are used in this document:

- **Bold** text is used to highlight the following:
  - Dialog box, window and screen names
  - Drop-down list and list box names
  - Check box and radio button names
  - Icons on a screen
  - Key names on a keypad
  - Button names on a screen.

- Bullets (•) indicate:
  - Action items
  - Lists of alternatives
  - Lists of required steps that are not necessarily sequential.
- Sequential lists (for example, those that describe step-by-step procedures) appear as numbered lists.

## Related Documents

- MC93XX Mobile Computer Quick Start Guide, p/n MN-003413-xx
- MC93XX Regulatory Guide, p/n MN-003409-xx
- MC93XX Mobile Computer Integrator Guide, p/n MN-003445-xx
- RS507/RS507X Hands-free Imager Product Reference Guide, p/n 72E-12082-xx
- DS36X8 Product Reference Guide, p/n MN-002689-xx
- RS6000 User Guide, MN-002704-xx
- DS2278 Digital Scanner Product Reference Guide, p/n, MN-002915-xx.

For the latest version of this guide and all guides, go to: <http://www.zebra.com/support>.

## Service Information

If you have a problem with your equipment, contact Customer Support for your region. Contact information is available at: [www.zebra.com/support](http://www.zebra.com/support).

When contacting support, please have the following information available:

- Serial number of the unit (found on manufacturing label)
- Model number or product name (found on manufacturing label)
- Software type and version number

Customer Support responds to calls by email or telephone within the time limits set forth in support agreements.

If the problem cannot be solved by Customer Support, you may need to return the equipment for servicing and will be given specific directions. We are not responsible for any damages incurred during shipment if the approved shipping container is not used. Shipping the units improperly can possibly void the warranty. Remove the microSD card from the device before shipping for service.

If the device was purchased from a business partner, contact that business partner for support.

If the manufacturing label is worn or missing, use an NFC enabled device to read the NFC tag under the battery compartment. You can download the NFC Reader application for free from the Google Play store.

Figure 1 Manufacturing Label Location

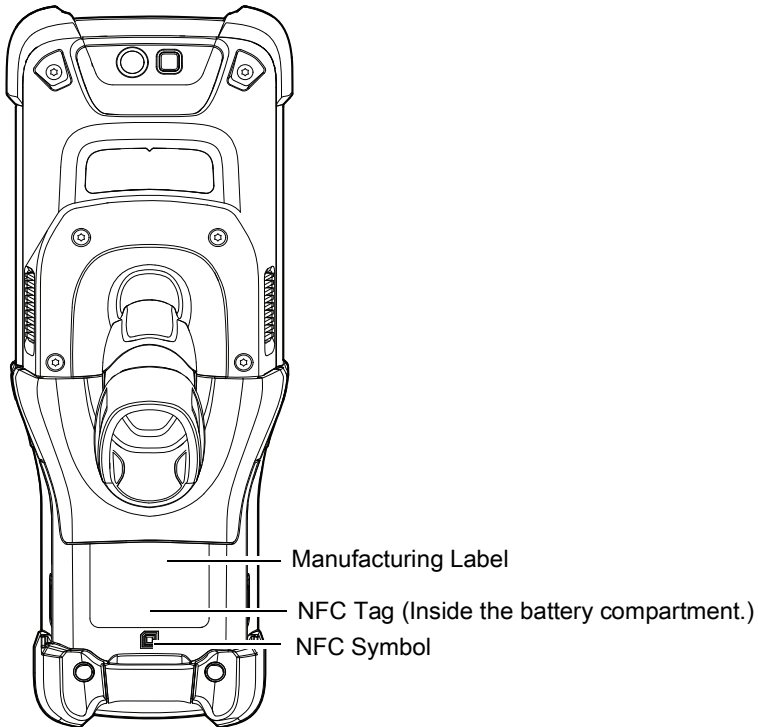

## Provide Documentation Feedback

If you have comments, questions, or suggestions about this guide, send an email to [EVM-Techdocs@zebra.com](mailto:EVM-Techdocs@zebra.com).

# Getting Started

## Introduction

This chapter provides the features of the device and explains how to set it up for the first time.

## Unpacking

Carefully remove all protective material from the device and save the shipping container for later storage and shipping.

Verify the following items are in the box:

- Device
- Lithium-ion battery
- Regulatory Guide.

Inspect the equipment for damage. If any equipment is missing or damaged, contact the Zebra Support Center immediately.

## Device Features

Figure 2 MC93XX Front View

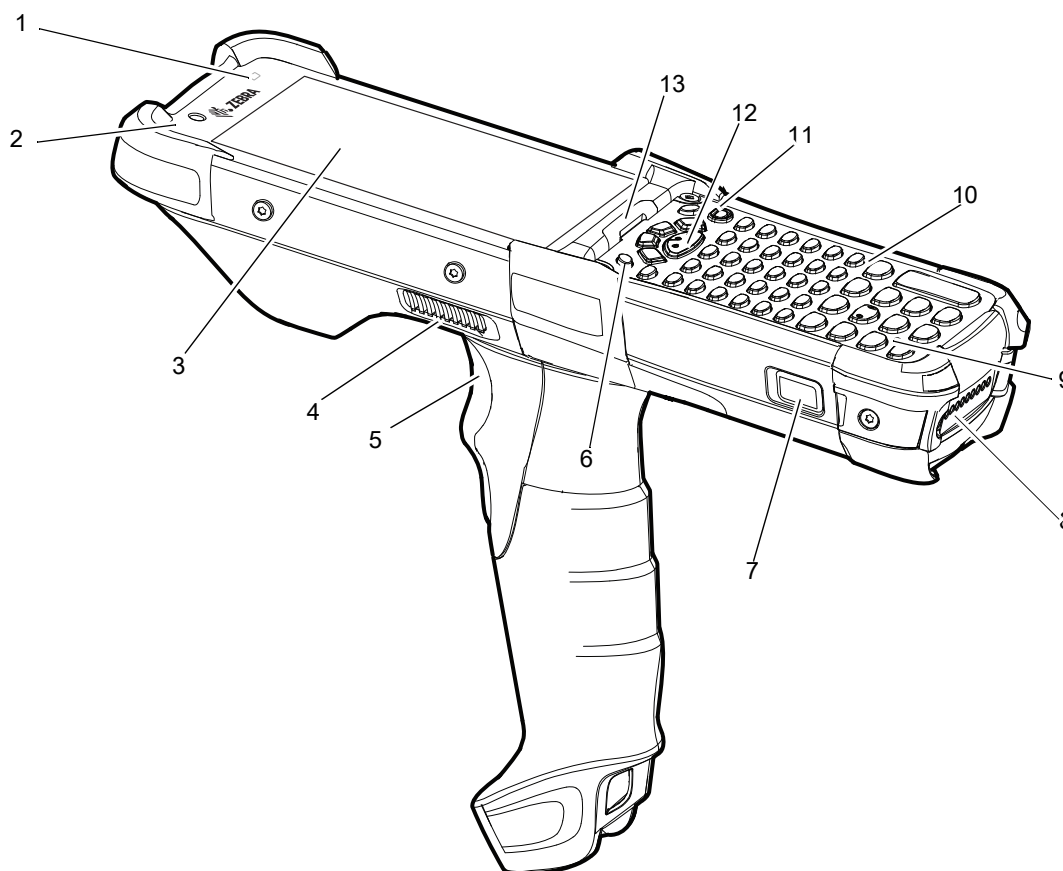

Table 2 MC93XX Features - Front View

Number	Item	Function
1	Ambient Light Sensor	Controls display and keyboard backlight.
2	Front Facing Camera	Use to take photos and videos. <b>NOTE:</b> The front camera is available only on the premium configurations.
3	Display	Displays all information needed to operate the device.
4	Speaker Side Port	Provides audio output for video and music playback.
5	Trigger	Initiates data capture when a scan application is enabled.
6	P1 - Dedicated PTT Key	Initiates push-to-talk communications (programmable).
7	Battery Release Latch	Releases the battery from the device. <b>NOTE:</b> To release the battery, simultaneously press the battery release latches on both the sides of the device.



Table 2 MC93XX Features - Front View (Continued)

Number	Item	Function
8	Battery	Provides power for operating the device.
9	Microphone	Use for communications in Handset mode.
10	Keypad	Use to enter data and navigate on screen functions.
11	Power Button	Press and hold to turn on the device. Press to turn on or off the screen. Press and hold to select one of these options: <b>Power off</b> - Turn off the device. <b>Restart</b> - Restart the device when software stops responding.
12	Center Scan Button	Initiates data capture when a scan application is enabled.
13	Charger/Decode Status LED	Indicates battery charging status while charging, app generated notifications, and data capture status.

Figure 3 MC93XX Back View

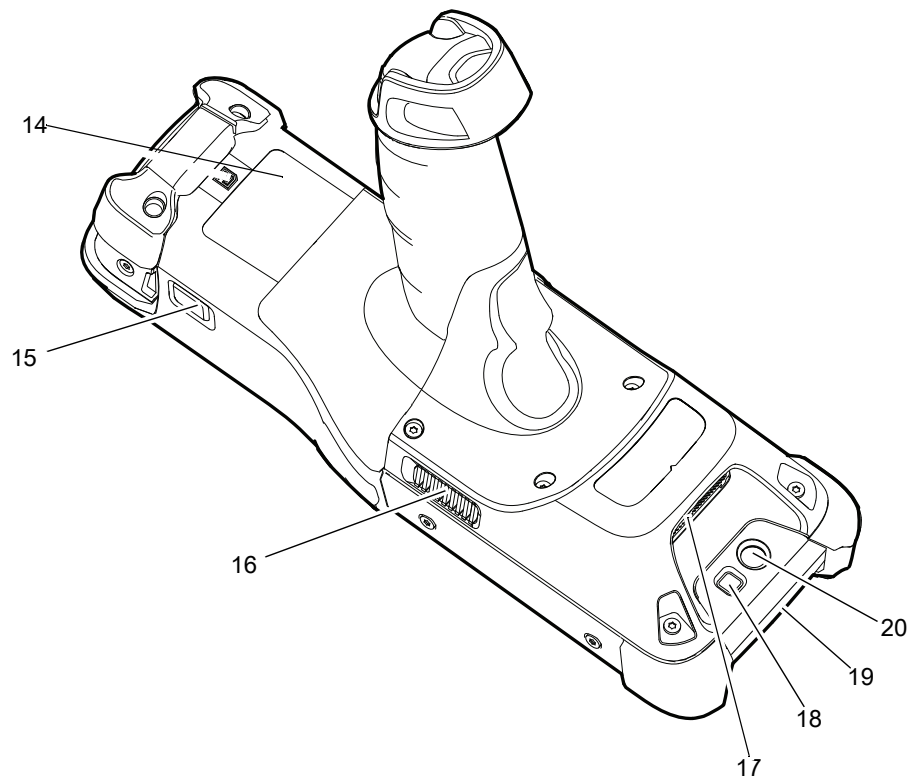

Table 3 MC93XX Features - Back View

Number	Item	Function
14	Passive NFC Tag (Inside the battery compartment.)	Provides secondary product label information (configuration, serial number and manufacture data code) in the event that the readable product label is worn or missing.
15	Battery Release Latch	Releases the battery from the device.
16	Side Speaker Port	Provides audio output for video and music playback.
17	Scanner Exit Window	Provides data capture using the scanner/imager.
18	Camera Flash	Provides illumination for the camera.  <b>NOTE:</b> Camera is available only on some configurations.
19	NFC Antenna	Provides communication with other NFC-enabled devices.  <b>NOTE:</b> NFC antenna is available only on the premium configurations.
20	Rear Camera	Takes photos and videos.  <b>NOTE:</b> The rear camera is available only on the premium configurations.

## Setup

To start using the device for the first time:

- Install a microSD card (optional)
- Install the battery
- Charge the device
- Power on the device.

## Installing a microSD Card

The microSD card slot provides secondary non-volatile storage. The slot is located under the keypad module. Refer to the documentation provided with the card for more information, and follow the manufacturer's recommendations for use. It is strongly recommended that prior to use, you must format the microSD card on the device.



**NOTE:** The following microSD cards were tested and are validated for use with the MC93XX:

- SanDisk 16GB (SDSDQ-016G-A11M)
- SanDisk 32GB (SDSDQ-032G-A11M)
- SanDisk 64GB (SDSDQUA-064G-U46A)
- SanDisk 128GB (SDSDQUI-128G-A46)
- SanDisk 200GB (SDSDQUAN-200G-A4A).



**CAUTION:** Follow proper electrostatic discharge (ESD) precautions to avoid damaging the microSD card. Proper ESD precautions include, but are not limited to, working on an ESD mat and ensuring that the operator is properly grounded.

1. Power off the device.
2. Remove the battery.
3. Using a Torx T8 screwdriver with a large grip, remove the two keypad latch screws from inside the battery slot.

Figure 4 Remove Keypad Latch Screws

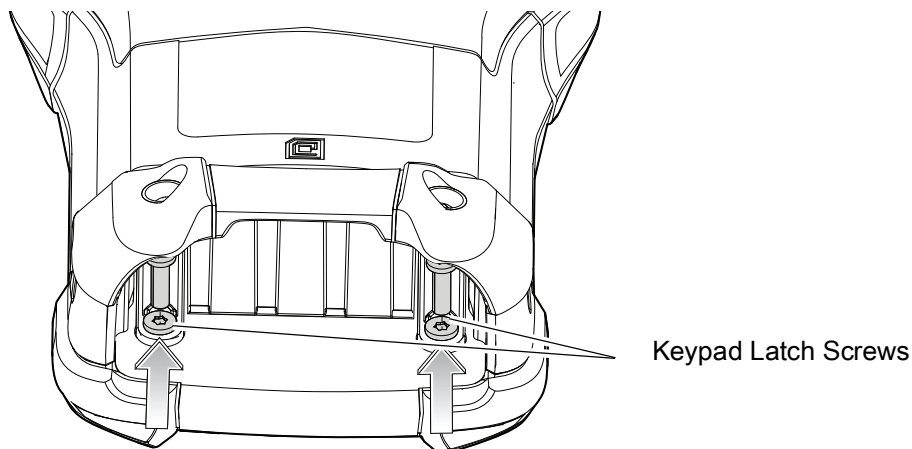

- Slide the keypad latches toward the bottom of the device.

Figure 5 Release Keypad Latches

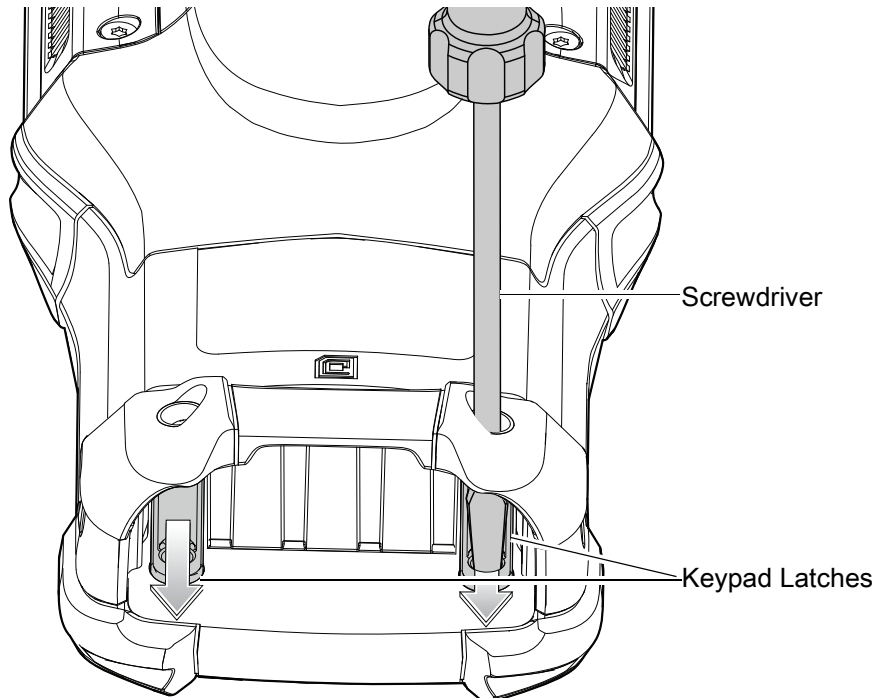

**NOTE:** If the keypad latches are hard to move, use a screwdriver to gently slide them towards the bottom of the device.

- Turn the device over so that the keypad is visible.
- Using a Torx T8 screwdriver with a large grip, remove the two keypad assembly screws from the top of the keypad.

Figure 6 Remove Keypad

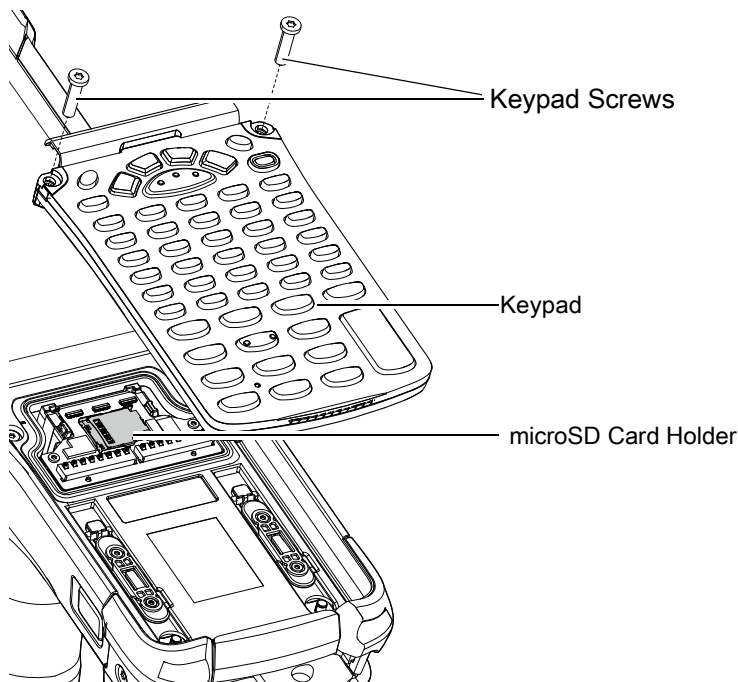

7. Lift the keypad from the device.
8. Slide the microSD card holder to the Open position.

Figure 7 Open microSD Card Holder

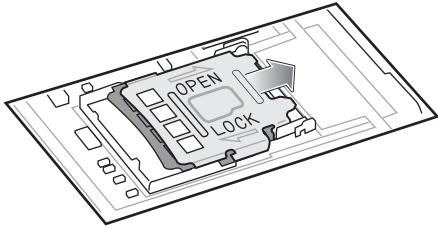

9. Lift the microSD card holder.

Figure 8 Lift microSD Card Holder

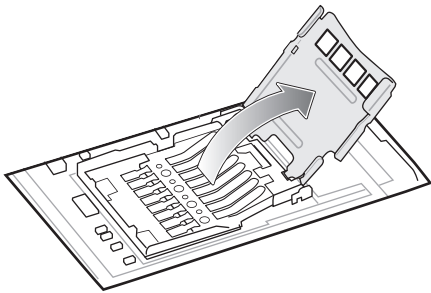

10. Insert the microSD card into the card holder door ensuring that the card slides into the holding tabs on each side of the door.

Figure 9 Insert microSD Card into Holder

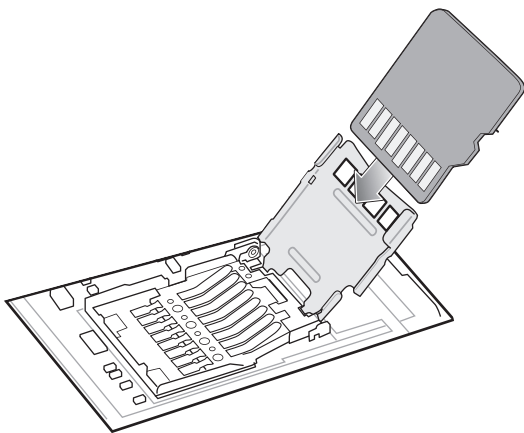

11. Close the microSD card holder door and slide the door to the Lock position.

Figure 10 Close and Lock microSD Card in Holder

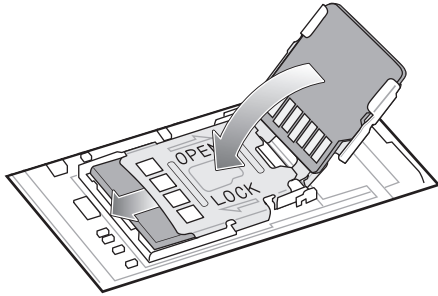

12. Align the keypad along the bottom ridge of the device, and then lay it flat.

Figure 11 Replace Keypad

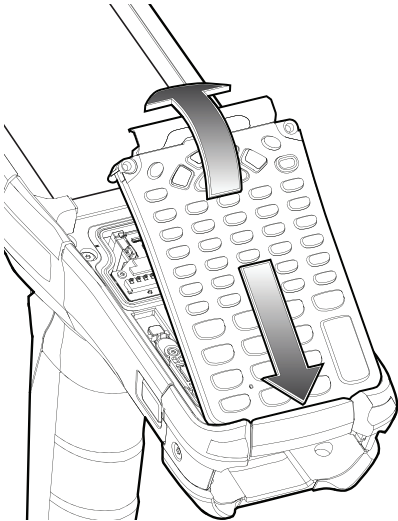

- Using a Torx T8 screwdriver with a large grip and a long shaft, secure the keypad to the device using the two screws. Torque screws to 5.8 kgf-cm or 5.0 lbf-in.

Figure 12 Replace Keypad Screws

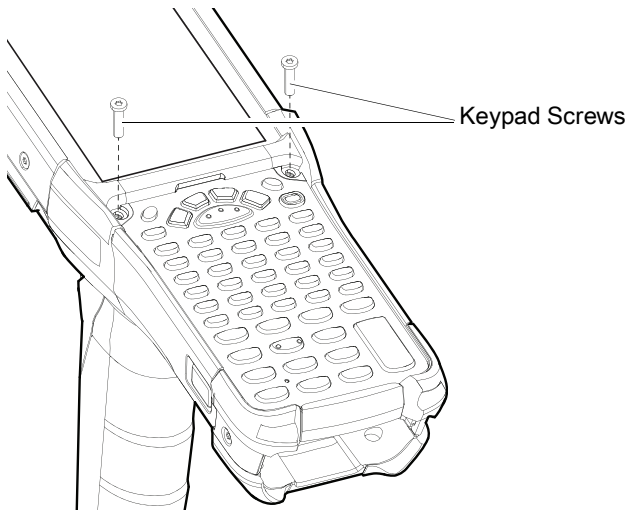

- Turn the device over so that the keypad latches are visible.

- Slide both the keypad latches toward the top of the device.

Figure 13 Slide Keypad Latches

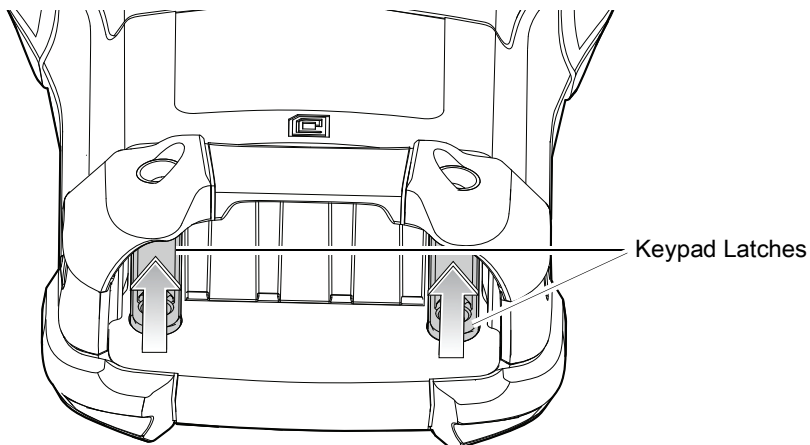

- Using a Torx T8 screwdriver, replace the two keypad latch screws inside the battery slot and torque to 5.8 kgf-cm or 5.0 lbf-in.

Figure 14 Replace Keypad Latch Screws

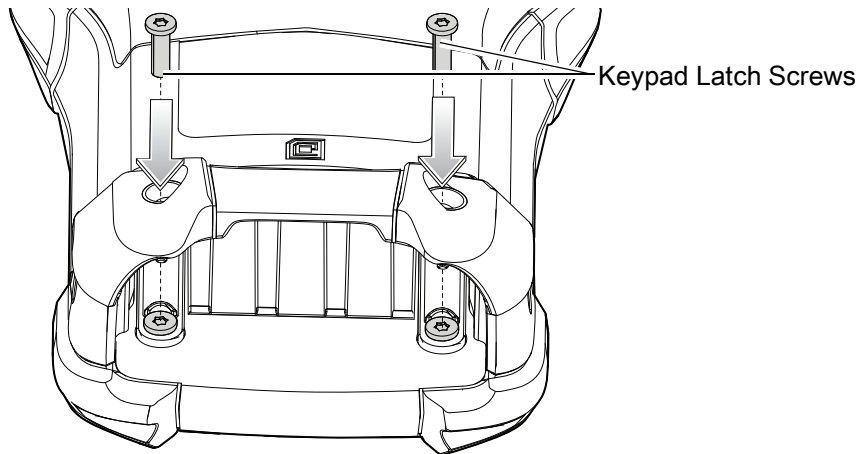

- Insert the battery.
- Press and hold the Power key to power on the device.

## Backup Power

The device is equipped with a super-capacitor (supercap) to provide backup power to the device when the main battery is removed. The supercap will retain random access memory (RAM) data in memory for approximately five minutes after the main battery is removed during Hot Swap.



**IMPORTANT:** The supercap is automatically charged from the main battery and requires approximately fifteen minutes to fully charge.

## Charging Temperature

Charge batteries in temperatures from 0°C to 40°C (32°F to 104°F). The device or cradle always performs battery charging in a safe and intelligent manner. At higher temperatures, for example at approximately +37°C (+98°F), the device or cradle may for small periods of time alternately enable and disable battery charging to keep the battery at acceptable temperatures. The device and cradle indicates when charging is disabled due to abnormal temperatures via its LED.

## Charging Spare Batteries

See the Accessories section for information on using accessories to charge spare batteries.

## Google Account Setup



**NOTE:** You must connect the device to the internet in order to set up a Google™ account. A Google account is only required on devices with GMS software.



The first time the device starts, the Setup Wizard displays. Follow the on-screen instructions to set up a Google account, configure Google Pay™ for purchasing items from the Google Play™ store, to enter your personal information, and enable backup or restore features.

### Zebra Visibility Services

The device captures and provides device analytics to a system administrator. The first time the device boots (or after a Factory reset), the **Zebra Services** agreement screen displays.

Figure 15 Zebra Services

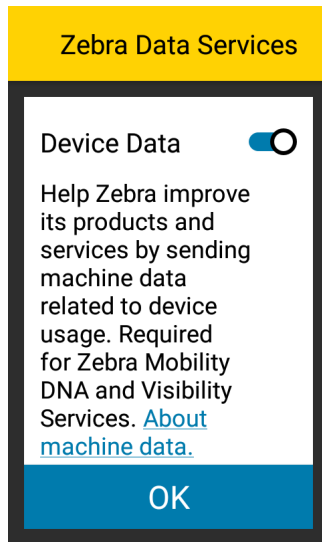

1. Touch the **Device Data** switch to disable the device from sending analytics data. Zebra recommends keeping this option enabled.
2. Touch **OK**.

### Replacing the Battery in the Device

To replace the battery:

1. Push in the two primary Battery Release buttons.

The battery ejects slightly. With Hot Swap mode, when you remove the battery, the display turns off and the device enters a low power state. The device retains RAM data for approximately five minutes. Replace the battery within five minutes to preserve memory persistence.

Figure 16 Primary Battery Releases

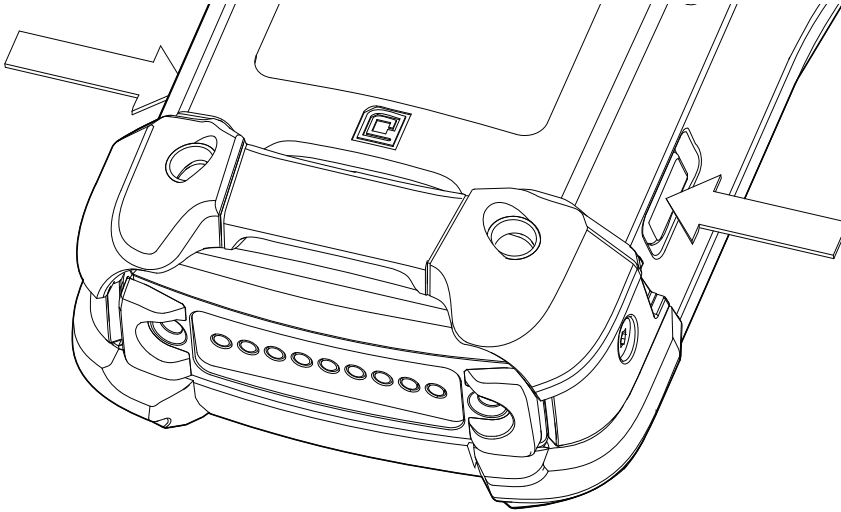

2. Push in the secondary battery release buttons on the sides of the battery.

Figure 17 Secondary Battery Releases

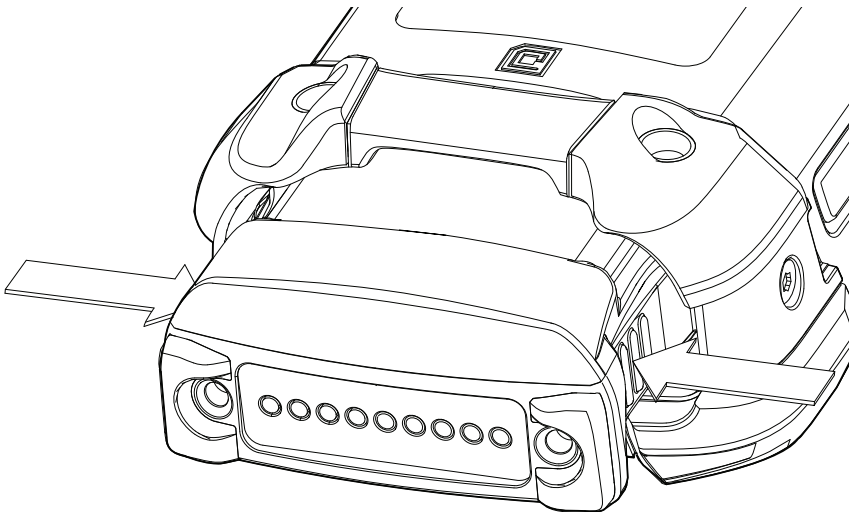

3. Remove the battery from the battery slot.

Figure 18 Remove Battery

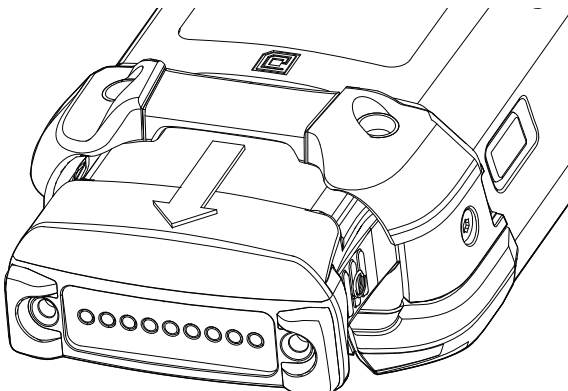

4. Align the battery with the battery slot.

Figure 19 Inserting the Battery

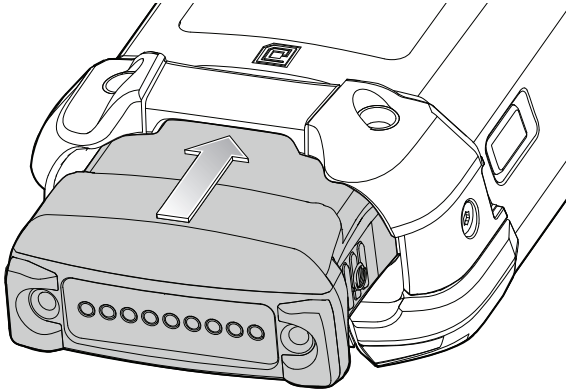

5. Push the battery into the battery slot.
6. Press battery firmly into the battery well. Ensure that both the battery release buttons on the sides of the device return to the home position. You will hear an audible click sound indicating that both the battery release buttons on the sides of the device have returned to the home position locking the battery in place.

Figure 20 Press Battery In

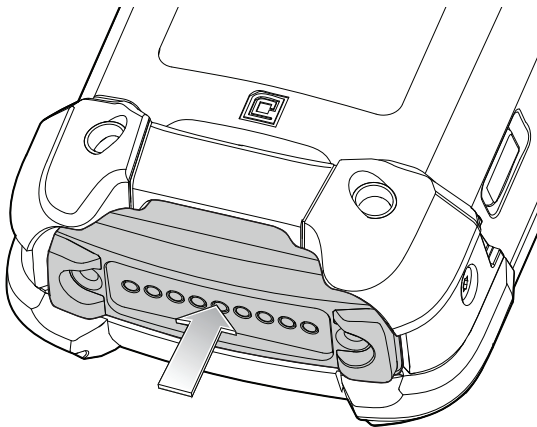

7. Press the Power button to turn on the device.

## Hot Swap Mode

The device provides a Hot Swap mode where you can replace the battery without powering off the device. When you remove the battery, the display turns off and the device enters the Hot Swap mode. WLAN and Bluetooth connectivity are retained for the first 30 seconds (indicated by a flashing amber LED). After 30 seconds, the device enters a critical suspend mode with RAM data persistence for approximately 5 minutes. In the critical suspend mode, WLAN and Bluetooth radios are disabled and will only resume if you insert a battery with sufficient charge into the device.



**CAUTION:** To prevent damage to the device, DO NOT perform a hot swap during a device boot up session.





**IMPORTANT:** The supercap requires time to recharge after performing a Hot Swap or after the main battery is fully depleted. It can take up to 15 minutes to fully charge the supercap. Hot Swap mode will not retain data

unless the supercap is fully charged.

### Accessing Device Settings

To access device settings:

1. Swipe down from the Status bar to open the Quick Settings bar and then touch .
2. On the Home screen, swipe up from the bottom of the screen and touch .

## Battery Management



**NOTE:** Prior to checking the battery charge level, remove the device from any AC power source (cradle or cable).

To check the charge status of the main battery, open **Settings** and touch **System > About phone > Battery Information**.

**Battery present status** indicates if the battery is present and **Battery level** lists the battery charge (as a percentage of fully charged). The battery percentage can also be viewed next to the battery icon in the quick access panel. Swipe down with two fingers from the status bar to open the quick access panel.

### Monitoring Battery Usage

The **Battery** screen provides battery charge details, power management options, and a list of apps that consume the most battery power.

Use the power management options to extend battery life, or touch an app to display details about its power consumption. Different apps display different information. Some apps include buttons that open screens with settings to adjust power use. Use the **DISABLE** or **FORCE CLOSE** buttons to turn off apps that consume too much power.



1. Swipe down from the Status bar to open the Quick Settings bar and then touch .
2. Touch **Battery**.

Figure 21 Battery Screen

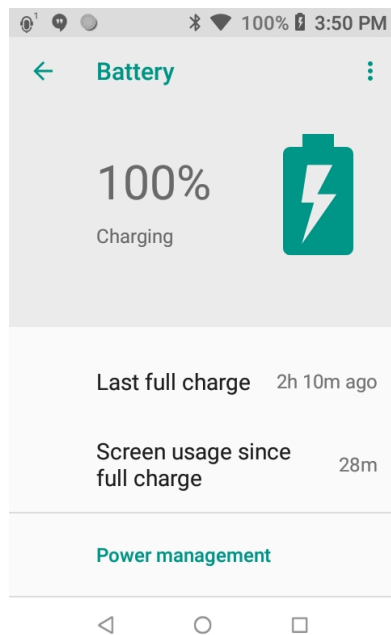

## Low Battery Notification

When the battery state of charge drops below 15% on the standard battery and 30% on the freezer battery, a notification displays indicating a low battery. The battery status icon changes to . You must either replace or charge the battery using one of the charging accessories.

When the battery state of charge drops below 9% on the standard battery and 20% on the freezer battery, a notification displays indicating a very low battery. The battery status icon changes to . You must either replace or charge the battery using one of the charging accessories.

When the battery state of charge drops below 6% on the standard and freezer batteries, the device goes into critical suspend mode to retain data. The screen turns off. You must replace the battery or charge the device using one of the charging accessories to retain data.



**NOTE:** If you place a device with a deeply discharged battery on a device charger, the battery has to pre-charge to an operational voltage level before the device can resume operation. This is indicated via the blinking amber LED. You must avoid deeply discharging the battery as it can reduce the overall battery health.

## Battery Optimization

Observe the following battery saving tips:

- Set the screen to turn off after a short period of non-use.
- Reduce screen brightness.
- Turn off all wireless radios when not in use.
- Turn off automatic syncing for Email, Calendar, Contacts, and other apps.
- Minimize use of apps that keep the device from suspending, for example, music and video apps.

### Real-Time Clock Backup

The device provides a Real-time Clock (RTC) backup feature. The device saves the system time at regular intervals to a backup file in persistent storage.

If the system time is not the latest when the device re-boots, the device uses the time from the backup file to update the RTC. Wi-Fi authentication certificates are validated using the restored time. Using the correct time from the Wi-Fi network, the system time and the RTC are updated.

### Setting the Date and Time

You are only required to set the time zone or set the date and time if the wireless LAN does not support Network Time Protocol (NTP).

To set the date and time:

1. Swipe down from the Status bar to open the Quick Settings bar and then touch .
2. Touch **System > Date & time**.
3. Touch **Automatic date & time** to disable automatic date and time synchronization.
4. Touch **Update Interval**.
5. Select the interval time to synchronize your device time from the network.
6. Touch **Set date**.
7. In the calendar, set today's date.
8. Touch **OK**.
9. Touch **Set time**.
10. Touch the green circle, drag to the current hour and then release.
11. Touch the green circle, drag to the current minute and then release.
12. Touch **AM** or **PM**.
13. Touch **OK**.
14. Touch **Select time zone**.
15. Select the current time zone from the list.
16. Touch **Use 24-hour format**.
17. Touch

### Display Settings

Use Display settings to change the screen brightness, enable night light, change the background image, enable screen rotation, control the keyboard backlight, set sleep time, and change font size.

#### Setting the Screen Brightness

To manually set the screen brightness using the touchscreen:

1. Swipe down with two fingers from the Status bar to open the Quick Access panel.
2. Slide the icon to adjust the screen brightness level.



Figure 22 Brightness Slider



To manually set the screen brightness using the keypad see Keypad Special Functions.

## Setting Screen Timeout

To set the screen sleep time:

1. Swipe down from the Status bar to open the Quick Settings bar and then touch .
2. Touch **Display > Sleep**.
3. Select one of the sleep values.
  - **15 seconds**
  - **30 seconds**
  - **1 minute**
  - **2 minutes**
  - **5 minutes**
  - **10 minutes**
  - **30 minutes** (default)
  - **Never**
4. Touch .

## Setting Screen Rotation

By default, screen rotation is disabled.

To enable screen rotation:

1. Swipe down from the Status bar to open the Quick Settings bar and then touch .
2. Touch **Display > Advanced**.
3. Touch **Auto-rotate screen**.



**NOTE:** To change the Home screen rotation, see Setting Home Screen Rotation.

4. Touch .

## Setting Font Size

To set the size of the font in system apps:

1. Swipe down from the Status bar to open the Quick Settings panel and then touch .

2. Touch **Display > Advanced**.
3. Touch **Font size**.

Figure 23 Font Settings

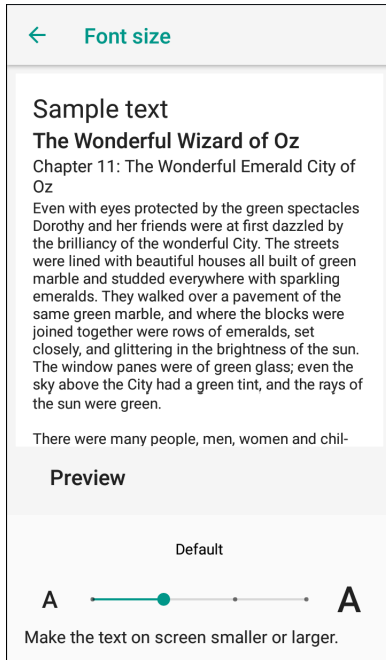

4. Select one of the font size values.
  - Small
  - Default
  - Large
  - Largest.
5. Touch .

## Setting Display Size

By default, display size is set to default.

To change the display size:



1. Swipe down from the Status bar to open the Quick Settings bar and then touch .
2. Touch **Display > Advanced**.
3. Touch **Display size**.
4. Touch - and + to change the display size.
  - Small
  - Default
  - Large.
5. Touch .



## Ambient Display

The Ambient display setting wakes the screen when notifications are received.

To disable ambient display:

1. Swipe down from the Status bar to open the Quick Settings bar and then touch .
2. Touch **Display > Advanced**.
3. Touch **Ambient display**.
4. In the **When to show** section, enable or disable an option using the switch.
5. Touch .

## Touch Panel Mode

The device display is able to detect touches using a finger, a conductive-tip stylus, or gloved finger.



**NOTE:** A glove can be made of medical latex, leather, cotton, or wool.  
For optimal performance use a Zebra certified stylus.



1. Swipe down from the Status bar to open the Quick Settings bar and then touch .
2. Touch **Display > Advanced**.
3. Touch **Touch panel mode**.

Figure 24 Touch Panel Mode Dialog Box

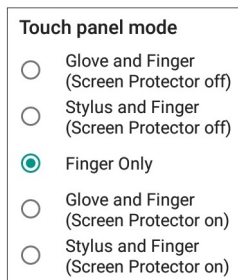

4. Select:
  - a. **Glove and Finger (Screen Protector off)** to use a finger or a gloved finger on the screen without a screen protector.
  - b. **Stylus and Finger (Screen Protector off)** to use a finger or a stylus on the screen without a screen protector.
  - c. **Finger Only** to use a finger on the screen.
  - d. **Glove and Finger (Screen Protector on)** to use a finger or a gloved finger on the screen with a screen protector.
  - e. **Stylus and Finger (Screen Protector on)** to use a finger or a stylus on the screen with a screen protector.
5. Touch .

## Keyboard Backlight

To manually set the keyboard backlight brightness and timeout using the touchscreen:

1. Swipe down from the Status bar to open the Quick Settings bar and then touch .
2. Touch **Display > Advanced**.
3. Touch **Keyboard backlight**.

Figure 25 Keyboard Light



4. Touch Keyboard light level, and then slide the icon to adjust the brightness level.

Figure 26 Brightness SliderLight

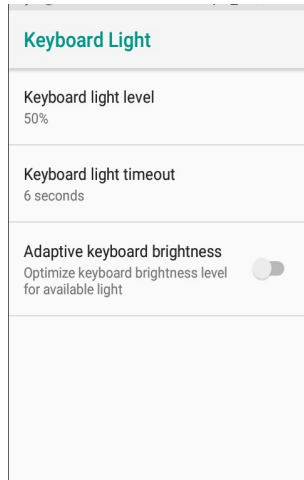

5. Touch Keyboard light timeout and select one of the timeout values.
  - **6 seconds** (default)
  - **10 seconds**
  - **15 seconds**
  - **30 seconds**
  - **1 minute**
  - **2 minutes**
  - **5 minutes**
  - **Always on**
6. By default, Adaptive keyboard brightness is enabled, touch the switch to enable the device to automatically adjust the display backlight based on ambient lighting condition.





**NOTE:** If you use the keyboard keys to adjust the keyboard backlight, the system disables Automatic Keyboard backlight adjustments.

7. Touch .

## Setting Notification LED

The Charging/Notification LED lights blue when an application, such as email and VoIP, generates a programmable notification or to indicate when the device is connected to a Bluetooth device. By default, LED notifications are enabled. To change the notification setting:

1. Swipe down with two fingers from the status bar to open the quick access panel and then touch .
2. Touch **Apps & notifications > Notifications**.
3. Touch **Blink light** to toggle the notification on or off.
4. Touch .

## General Sound Setting

Use the **Sound** settings to configure media and alarm volumes.

To access sound settings:





1. Swipe down from the Status bar to open the Quick Settings bar and then touch .
2. Touch **Sound**.
3. Touch an option to set sounds.

Figure 27 Sound Screen

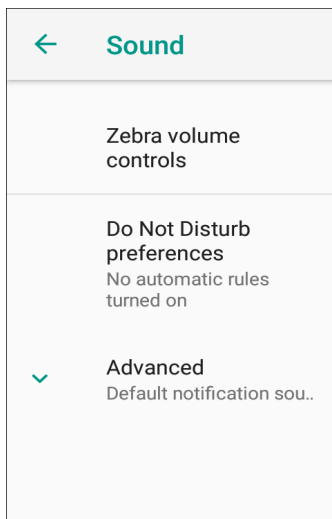

- **Zebra volume controls**
  - **Ring volume** - Controls the ringtone volume.
  - **Media volume** - Controls the music, games, and media volume.
  - **Alarm volume** - Controls the alarm clock volume.
  - **Notifications volume** - Controls the notification volume.
  - **Scanner volume** - Controls the scanner volume.
- **Volume presets**
  -  - Mutes the ring, notifications, and scanner so that the device does not make sounds or vibrate.
  -  - All sounds except media and alarms are silenced and vibrate mode is active.

-  - Enables all sounds at the user defined levels.
- **Do Not Disturb preferences** - Mutes some or all sounds and vibrations.
  - **Priority only allows** - Use to set the priorities for the following:
    - **Reminders** - Switch on or off.
    - **Events** - Switch on or off.
    - **Alarms** - This is always enabled.
  - **Block visual disturbances**
    - **Block when screen is on** - This option prevents notifications from displaying over the screen (peeking) while you are actively using the device.
    - **Block when screen is off** - This option prevents notifications from turning on the screen or pulsing the LED light when a new notification is received while you are not using the device.
  - **Automatic rules** - Choose when to automatically silence the device. Touch a default rule, such as Weekend or Weeknight, or create your own rule. To create your own rule, tap **Add more** and then **Time rule**.
- **Phone ringtone** - Touch to select a sound to play when the phone rings.
- **Advanced** - Touch to display advanced sound options.
  - **Default notification sound** - Touch to select a sound to play for all system notifications.
  - **Default alarm sound** - Touch to select a sound to play for alarms.
  - **Other sounds and vibrations**
    - **Screen locking sounds** - Play a sound when locking and unlocking the screen (default – enabled).
    - **Charging sounds** - Not applicable.
    - **Touch sounds** - Play a sound when making screen selections (default – enabled).
    - **Vibrate on tap** - Vibrate the device when making screen selections (default – disabled).
    - **Key press sounds** - Play a sound when making keyboard button selections (default – disabled)



**NOTE:** You can adjust the sound volume which is set at a default of 50% for the key press. Go to **Settings > System > Languages & input > Physical keyboard > Volume on keypress**, and set the volume as required.

- **Emergency alerts** - Touch to configure emergency broadcast settings and notifications.

## Wake-Up Sources

By default the device wakes from suspend mode when you press the power button. You can configure the device to wake when you press the PTT or Scan buttons on the left side of the device.

The P1 key only wakes the unit in its default configuration (when it acts as the PTT key). The SCAN key (if enabled), and the Grip Trigger will wake the unit from suspend for all key mappings.



**NOTE:** The P2 can be mapped as a trigger key and can act as a wake-up source. However, if it is mapped to something else, the P2 key will not wake the device.

1. Swipe down with two fingers from the status bar to open the quick access panel and then touch .
2. Touch **Wake-Up Sources**.

Figure 28 Wake-Up Sources



3. Touch one or more of the options:

- By default **P1** is enabled. Touch **P1** check box to disable the right scan button.
- Touch **SCAN** check box to enable the right scan button. A check appears in the check box.
- By default **GRIP\_TRIGGER** is enabled. Touch **GRIP\_TRIGGER** check box to disable the left scan button.

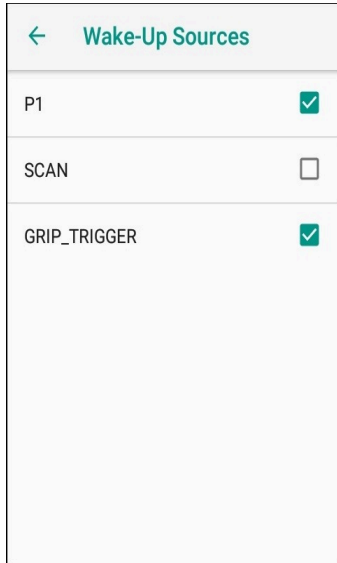
4. Touch ○.

# Using the Device

## Introduction

This chapter describes the screens, status and notification icons, and controls on the device, and provides basic instructions for using the device.

## Google Mobile Services



**NOTE:** This section applies to Google Mobile Services (GMS) devices only.

Devices with GMS contain apps and services that provide additional functionality.

GMS includes:

- Apps - GMS adds a variety of Google apps and associated widgets including Chrome, Gmail, Drive, and Maps.
- Services:
  - Speech to Text - Allows for free format speech to text in many languages for both connected and disconnected network. Launch by touching the microphone icon on the keyboard.
  - TalkBack Service - Provides spoken feedback on various parts of the user interface. To enable, go to **Settings > Accessibility**.
  - Network Location Provider - Adds a location provider which uses mobile network tower information and Wi-Fi access point information to provide a location without using GPS. To enable, go to **Settings > Security & location > Location**.
  - Widevine DRM - Enables Digital Rights Management (DRM) so that protected streaming video content can be played. Enable DRM Info from the Google Play™ store.
  - Google Cloud Messaging - Allows the device to receive data from the server and other devices on the same connection.
  - Backup and Restore - Allows the users settings and apps to be backed up to a Google server and subsequently restored from that server after a factory reset.
  - Google Accounts - Create and use a Google account to synchronize mail, files, music, photos, contacts and calendar events.

## Home Screen

Turn on the device to display the Home screen. Depending on the configuration, the Home screen may appear different. Contact your system administrator for more information.

After a suspend or screen time-out, the Home screen displays with the lock slider. Touch the screen and slide up to unlock. For screen locking information, see Un-Locking the Screen.

The Home screen provides additional screens for placement of widgets and shortcuts. Swipe the screen left or right to view the additional screens.

### Home Screen

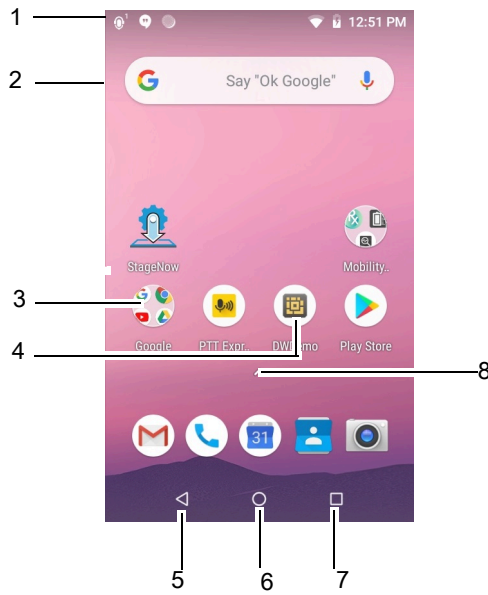

The Home screen consists of the following:

Table 4 Home Screen Items

Item	Description
1 — Status Bar	Displays the time, status icons (right side), and notification icons (left side). For more information see Status Bar and Managing Notifications.
2 — Widgets	Launches stand-alone applications that run on the Home screen. See App Shortcuts and Widgets for more information.
3 — Folder	Contains apps.
4 — Shortcut Icons	Opens applications installed on the device. See App Shortcuts and Widgets for more information.
5 — Back	Displays the previous screen.
6 — Home	Displays the Home screen.
7 — Recent Button	Displays recently used applications.
8 — All Apps Icon	Opens the APPS window.

### Setting Home Screen Rotation

By default the **Home** screen rotation is disabled.

To enable **Home** screen rotation:

1. Touch and hold anywhere on the **Home** screen until the options appear.
2. Touch **HOME SETTINGS**.
3. Touch the **Allow Home screen rotation** switch.
4. Touch .
5. Rotate the device.

Figure 29 Rotated Home Screen

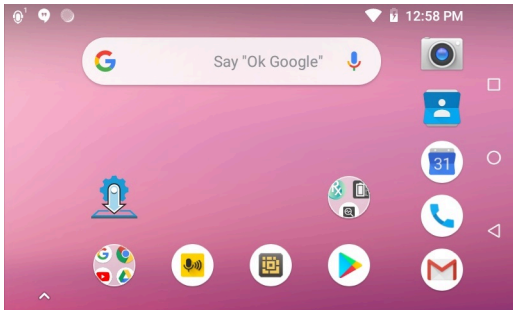

## Status Bar

The Status bar displays the time, notification icons (left side), and status icons (right side).



**NOTE:** Some Status icons may not appear in the Status bar if there are too many icons to display.

Figure 30 Notification and Status Icons



If there are more notifications than can fit in the Status bar, two dots display indicating that more notifications exist. Swipe down from the Status bar to open the Notification panel and view all notifications and status.





















## Status Icons

Table 5 Status Icons

Icon	Description
	Alarm is active.
	Main battery is fully charged.
	Main battery is partially drained.

















Table 5 Status Icons (Continued)

Icon	Description
	Main battery charge is low.
	Main battery charge is very low.
	Main battery is charging.
	All sounds, except media and alarms, are silenced and vibrate mode is active.
	Do Not Disturb mode active.
	Airplane Mode is active. All radios are turned off.
	Bluetooth is on.
	The device is connected to a Bluetooth device.
	Connected to a Wi-Fi network.
	Not connected to a Wi-Fi network or no Wi-Fi signal.
	Connected to an Ethernet network.
	Speakerphone enabled.
	Indicates that the Orange key is locked.
	Indicates that the Blue key is pressed.
	Indicates that the Blue key is locked.
	Indicates that the ALT key is pressed.
	Indicates that the CTRL key is pressed.
	Indicates that the Shift key is pressed.
	Indicates that the Shift key is locked.
	Indicates that the Large Key Indicator is selected. <b>NOTE:</b> To enable the large key indicator, go to Settings > Accessibility > Display > Large Key Indicator.
	Indicates that the Blue Key and SHIFT key are pressed enabling CAPSLOCK.

## Notification Icons

Table 6 Notification Icons

Icon	Description
	Main battery is low.
	More notifications are available for viewing.
	Data is syncing.
	Indicates an upcoming event. GMS devices only.
	Open Wi-Fi network is available.
	Song is playing.
	Problem with sign-in or sync has occurred.
	Device is uploading data.
	Device is downloading data when animated and download is complete when static.
	Device is connected to or disconnected from virtual private network (VPN).
	Preparing internal storage by checking it for errors.
	USB debugging is enabled on the device.
	Indicates that RxLogger app is running.
	Indicates the Bluetooth scanner is connected to the device.
	Indicates the RS6000 is connected to the device in HID mode.

## Managing Notifications

Notification icons report the arrival of new messages, calendar events, alarms, and ongoing events. When a notification occurs, an icon appears in the Status bar with a brief description. See Notification Icons for a list of possible notification icons and their description. Open the Notification panel to view a list of all the notifications.

To open the Notification panel, drag the Status bar down from the top of the screen.

Figure 31 Notification Panel

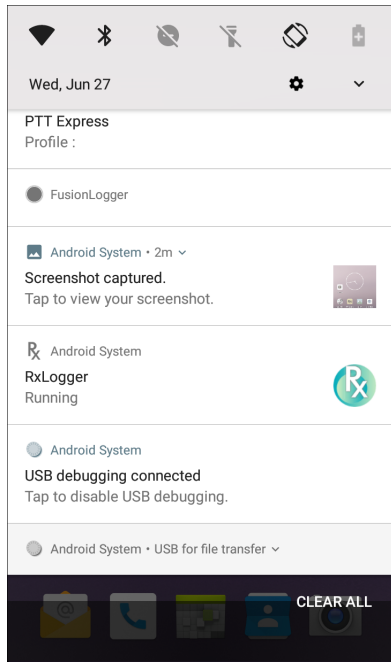

To respond to a notification, open the Notification panel and then touch a notification. The Notification panel closes and the corresponding app opens.

To clear all notifications, open the Notification panel and then touch **CLEAR ALL**. All event-based notifications are removed. Ongoing notifications remain in the list.

To close the Notification panel, swipe the Notification panel up.

## Setting App Notifications

To set notification settings for a specific app:

1. Swipe down from the Status bar to open the Quick Settings bar and then touch **⚙️**.
2. Touch **Apps & notifications > Notifications > App notifications**.
3. Select an app.
4. Select an available option:
  - **On / Off** - Select to turn all notifications from this app **On** (default) or **Off**.
  - **Allow notification dot** - Do not allow this app to add a notification dot to the app icon.
  - **Allow interruptions** - Do not allow notifications from this app to make sound, vibrate, or pop notifications on the screen.
  - **Override Do Not Disturb** - Allow these notifications to interrupt when Do Not Disturb is set to Priority Only.
  - **Categories** - Do not allow specific types of notifications from this app.
  - **Additional settings in the app** - Open the app settings.



**NOTE:** To change the notification settings for an app, slide the notification slightly left or right and touch **⚙️**.

## Viewing Notification Settings for All Apps

To view the notification settings for all apps:

1. Swipe down from the Status bar to open the Quick Settings bar and then touch .
2. Touch **Apps & Notifications**.
3. Scroll down to **Notifications** to view how many apps have notifications turned off.
4. To set or view notifications settings for a specific app, see Setting App Notifications.

## Controlling Lock Screen Notifications

To control whether notifications can be seen when the device is locked:

1. Swipe down from the Status bar to open the Quick Settings bar and then touch .
2. Touch **Apps & notifications > Notifications**.
3. Touch **On the lock screen** and select one of the following:
  - **Show all notification content** (default)
  - **Don't show notifications at all**.

## Notification Indicator

The Charging/Notification LED lights blue when an app, such as email and VoIP, generates a programmable notification or to indicate when the device is connected to a Bluetooth device. By default, LED notifications are enabled.

To change the notification setting:

1. Swipe down from the Status bar to open the Quick Settings bar and then touch .
2. Touch **Apps & notifications > Notifications**.
3. Touch **Blink light** to toggle the notification on or off.

## Quick Access Panel

Use the Quick Access panel to access frequently used settings (for example, Airplane mode).

Figure 32 Quick Settings Bar

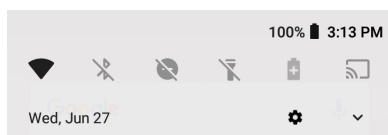

To see the full Quick Access panel:

- If the device is locked, swipe down once.
- If the device is unlocked, swipe down once with two fingers, or twice with one finger.
- If the Quick Settings bar is open, touch the Down arrow.

Figure 33 Quick Access Panel

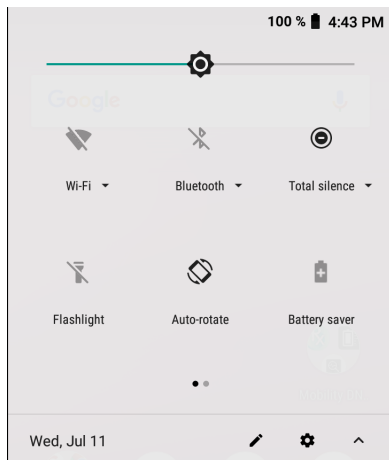

**NOTE:** Not all icons are pictured. Icons may vary.

To change a setting, touch the icon:

- Display brightness - Use the slider to decrease or increase the brightness of the screen.
- Wi-Fi network - Turn Wi-Fi on or off. To open Wi-Fi settings, touch the Wi-Fi network name.
- Bluetooth settings - Turn Bluetooth on or off. To open Bluetooth settings, touch **Bluetooth**.
- Do not disturb - Control how and when to receive notifications.
- Airplane mode - Turn Airplane mode on or off. When Airplane mode is on the device does not connect to Wi-Fi or Bluetooth.
- Auto-rotate - Lock the device's orientation in portrait or landscape mode or set to automatically rotate.
- Flashlight - Turn flashlight on or off. Turn camera flash on or off.

The thermal protection safety feature for the camera provides the following behavior if the temperature range is 40°C or above:

- If the flashlight is kept on for a certain period of time, it is automatically turned off and cannot be turned back on for a period of time until it has cooled off.
- During the cooling off period, the camera cannot be turned on. If you attempt to use the camera, a message displays indicating to try again after a period of time.
- Cast - Share phone content on Chromecast or a television with Google Cast built-in. Touch cast screen to display a list of devices, then touch a device to begin casting.

## Editing Icons on Quick Settings



The first several setting tiles from the Quick Access panel become the Quick Settings bar.

To move a setting tile:



1. Open the Quick Access panel.
2. Touch .
3. Touch and drag a setting tile to another location.
4. Release the tile.

5. Touch  to save tiles and return to the Quick Access panel.

To add a setting tile:

1. Open the Quick Access panel.
2. Touch .
3. Slide the Quick Settings panel up to reveal additional tiles.
4. Touch and drag a setting tile from the **Drag to add tiles** area to the main area.
5. Release the tile.
6. Touch  to save tiles and return to Quick Access panel.

To remove a setting tile:

1. Open the Quick Access panel.
2. Touch .
3. Touch and drag a setting tile to the **Drag here to remove** area.
4. Release the tile.
5. Touch  to save tiles and return to Quick Access panel.

## App Shortcuts and Widgets

App shortcuts placed on the Home screen allow quick and easy access to apps. Widgets are self-contained apps placed on the Home screen to access frequently used features.

### Adding an App Shortcut to the Home Screen

To add an app shortcut to the Home screen:

1. Go to the desired Home screen.
2. Swipe up from the bottom of the screen.
3. Scroll through the list to find the app icon.
4. Touch and hold the icon until the Home screen appears.
5. Position the icon on the screen and then release.

### Adding a Widget to the Home Screen

To add a widget to the Home screen:

1. Go to the desired Home screen.
2. Touch and hold until the menu appears.
3. Touch **WIDGETS**.
4. Scroll through the list to find the widget.
5. Touch and hold the widget until the Home screen appears.

6. Position the widget on the screen and then release.

### Moving Items on the Home Screen

To move app shortcuts or widgets on the Home screen:

1. Touch and hold the item until it floats on the screen.
2. Drag the item to a new location. Pause at the edge of the screen to drag the item onto an adjacent Home screen.
3. Lift finger to place the item on the Home screen.

### Removing an App Shortcut or Widget from the Home Screen

To remove an app shortcut or widget from the Home screen:

1. Go to the desired Home screen.
2. Touch and hold the app shortcut or widget icon until it floats on the screen.
3. Drag the icon to **X Remove** at the top of the screen and then release.

## Folders

Use **Folders** to organize similar applications together. Tap the folder to open and display items in the folder.

### Creating a Folder

There must be at least two app icons on the Home screen.

To create a folder:

1. Go to the desired Home screen.
2. Touch and hold one app icon.
3. Drag the icon and stack on top of another icon.
4. Lift and release.

### Naming Folders

To name a folder:

1. Touch the folder.

Figure 34 Open Folder

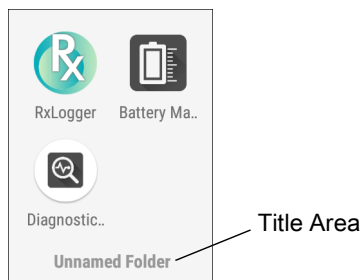

2. Touch the title area and enter a folder name using the keyboard.
3. Touch  on the keyboard.
4. Touch anywhere on the Home screen to close the folder. The folder name appears under the folder.

### Removing a Folder

To remove a folder:

1. Touch and hold the folder icon until it enlarges.
2. Drag the folder to **X Remove** and release.

### Home Screen Wallpaper

To change the Home screen wallpaper:

1. Touch and hold the screen until the menu appears.
2. Touch **WALLPAPERS**.
3. Touch **Photos** or **Gallery** to select a photo or select one of the pre-installed wallpapers.
4. Touch **Set wallpaper**.

### Using the Touchscreen

Use the multi-tap sensitive screen to operate the device.

- Tap - Tap to:
  - Select items on the screen.
  - Type letters and symbols using the on-screen keyboard.
  - Press on-screen buttons.
- Tap and Hold - Tap and hold:
  - An item on the Home screen to move it to a new location or to the trash.
  - An item in Apps to create a shortcut on the Home screen.
  - The Home screen to open a menu for customizing the Home screen.
  - An empty area on the Home screen until the menu appears.
- Drag - Tap and hold an item for a moment and then move finger on the screen until reaching the new position.
- Swipe - Move finger up and down or left and right on the screen to:
  - Unlock the screen.
  - View additional Home screens.
  - View additional app icons in the Launcher window.
  - View more information on an app's screen.
- Double-tap - Tap twice on a web page, map, or other screen to zoom in and out.
- Pinch - In some apps, zoom in and out by placing two fingers on the screen and pinching them together (to zoom out) or spreading them apart (to zoom in).



## Keyboards

The device provides the following types of keyboards:

- Gboard
- Enterprise Keyboard



**NOTE:** By default the Enterprise and Virtual Keyboards are disabled.

## Virtual Keyboard Configuration



### Enabling Virtual Keyboards

To enable virtual keyboards:

1. Swipe down from the Status bar to open the Quick Settings bar and then touch .
2. Touch **System > Languages & input > Virtual keyboard**.
3. Touch **Show virtual keyboard**.
4. Touch **Manage keyboards**.
5. Touch a keyboard to enable.

### Switching Between Virtual Keyboards

To switch between keyboards, touch in a text box to display the current keyboard.

- On the Gboard keyboard, touch and hold .
- On the Enterprise keyboard, touch .

## Physical Keyboard Configuration

### Enabling Physical Keyboards

To enable physical keyboards:

1. Swipe down from the Status bar to open the Quick Settings bar and then touch .
2. Touch **System > Languages & input > Physical keyboard**.
3. In the **Keyboard assistance** area, touch **Show virtual keyboard**.
4. Touch **Keyboard shortcuts helper** to view available shortcuts.
5. In the **Keyboard press** area, touch **Sound on keypress**.
6. Touch **Volume on keypress** to adjust the audible click on keypress. The default volume is set at 50%.

## Using the Enterprise Keyboard

The Enterprise Keyboard contains the following keyboards:

- Numeric

- Alpha
- Special characters
- Data capture.



**NOTE:** The Enterprise keyboard supports English (US), English (UK), French, German, Spanish and Italian. When a keyboard language is selected in Settings, the corresponding keyboard language displays.

## Numeric Tab

To access the numeric keyboard, touch the **123** tab. The keys displayed vary on the app being used. For example, an arrow displays in **Contacts**, however **Done** displays in **Email** account setup.

Figure 35 Numeric Keyboard

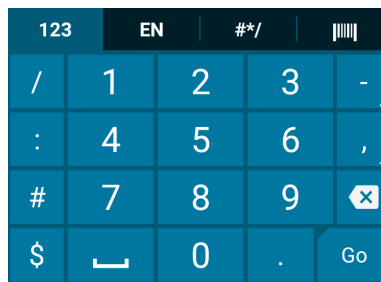
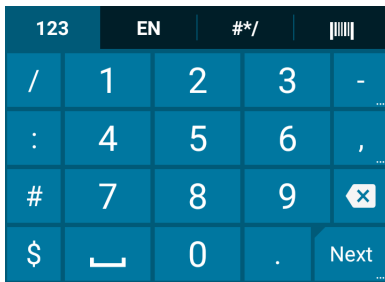

## Alpha Tab

To access the alpha keyboard, touch the EN tab.

Figure 36 Alpha Keyboard



## Additional Character Tab

To access additional characters, touch the **#\*/** tab.

Figure 37 Symbols Keyboard

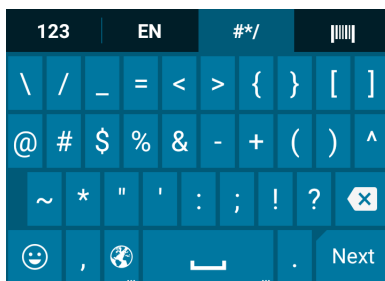

Touch 😊 to enter emoji icons in a text message.

Figure 38 Emoji Keyboard

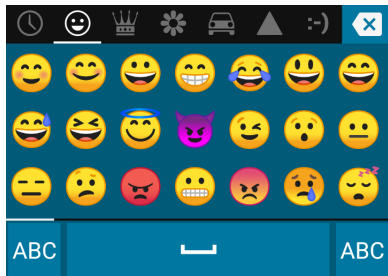

Touch **ABC** to return to the Symbols keyboard.

### Scan Tab

The Scan tab provides an easy data capture feature for scanning barcodes.

Figure 39 Scan Keyboard



## Do Not Disturb Feature

This mode mutes the device so that it does not make sounds or vibrate.

For example, use Do Not Disturb to:

- Automatically limit sounds at night or during events
- Mute interruptions other than alarms
- Get alerted to messages only from favorite contacts.

### Limit Sounds and Vibrations

Mute the device completely, or let through the important alarms or important calls.

### Total Silence

To completely mute the device so that it does not make a sound or vibrate, choose **Total silence**.

In Total silence mode:

- Alarms do not make noise.
- Device does not vibrate or make sounds when receiving a message, or notification.
- Sounds from music, videos, games, and other media are muted.



**NOTE:** All alarms are silenced in Total silence mode.

1. Swipe down with two fingers from the Status bar to open the Quick Access panel.
2. Touch **Do not disturb > Total silence**.
3. Choose **Until you turn it off** or select a time period.
4. Touch **Done**.

When Total Silence is on,  appears in the quick access panel and the Status bar.

To turn off Total Silence, open quick access panel and touch **Total silence**.

### Alarms Only

To mute the device so that you hear alarms, choose **Alarms only**. This option does not mute sounds from music, videos, games, or other media.

1. Swipe down with two fingers from the status bar to open the quick access panel.
2. Touch **Do not disturb > Alarms only**.
3. Choose **Until you turn it off** or select a time period.
4. Touch **Done**.

When Alarms Only is on,  appears in the quick access panel and the Status Bar.

To turn off Alarms Only, open the Quick Access panel and touch **Alarms only**.



**NOTE:** To quickly turn on Alarms Only, with the screen on, press and hold the Volume Down button until the volume is all the way down. Then, press Volume Down again to turn on Alarms Only.

To turn off Alarms Only, press either the Volume Up or Volume Down button and the touch **END NOW** in the alert message.

### Priority Notifications Only

To only be interrupted by important notifications, choose **Priority only**. This option does not mute sounds from music, videos, games, or other media.

Before turning on Priority Only mode, set the notification priorities:

1. Swipe down from the status bar to open the quick settings bar and then touch .
2. Touch **Sound > Do not disturb > Priority only allows**.
3. Set priorities.
  - **Alarms:** Disabled by default.
  - **Reminders and Events:** Switch on or off.
  - **Messages:** Choose **From anyone**, **From contacts only**, **From starred contacts only**, or **none**. To star contacts, use the **Contacts** applications.
  - **Repeat callers:** Choose whether to let the device ring if the same person calls again within 15 minutes.

After setting notification priorities, turn on Priority Only mode to limit interruptions. The priority notifications make a sound or vibrate based on the current ringer volume, but other notifications will be silenced.

1. Swipe down with two fingers from the status bar to open the quick access panel.

2. Touch **Do not disturb > Priority only**.
3. Choose **Until you turn it off** or select a time period.
4. Tap **Done**.

When Priority Only is on,  appears in the quick access panel and the Status Bar.

To turn off Priority Only, open quick access panel and touch **Priority only**.

### Silence Sounds During Certain Times

To automatically silence the device during certain times, like at night or on weekends:



1. Swipe down from the Status bar to open the Quick Settings bar and then touch .
2. Touch **Sound > Do Not Disturb preferences**.
3. Touch a default **Weekend** or **Weeknight**. Or, to make a new rule, touch **Add more > Time rule**.
4. Enter a rule name.
5. Touch **OK**.
6. Edit the new rule:
  - **Rule name** - Rename the rule.
  - **Days, Start time, and End time** - Set the rule's schedule.
  - **Do Not Disturb preferences** - Choose whether the rule uses **Alarms only**, **Priority only**, or **Total silence**.
  - **Alarm can override end time** - Allow the alarm to continue to make sound until the next alarm begins.
7. Touch the On/Off switch at the top to turn on the rule.

### Silence Sounds During Events and Meetings

To automatically silence the device during events or meetings, set an event rules.

1. Swipe down from the Status bar to open the Quick Settings bar and then touch .
2. Touch **Sound > Do Not Disturb preferences**.
3. To edit the default rule, touch **Event**. Or, to create a new rule, touch **Add rule > Event rule**.
4. Edit the rule settings.
  - **Rule name** - Rename the rule.
  - **During events for** - Select which Google Calendar events the rule uses.
  - **Where reply is** - Set to: **Yes, Maybe, or Not replied, Yes or Maybe, or Yes**.
  - **Do Not Disturb preferences** - Choose whether the rule uses **Priority only**, **Alarms only**, or **Total silence**.
5. Touch the On/Off switch at the top to turn on the rule.

### Turn Sounds Back On

When the device is in Do Not Disturb mode, Alarms only or Priority only display as , or Total silence displays as .

To turn off Do Not Disturb, either:

- In the Quick Access panel, touch **Alarms only**, **Priority only**, or **Total silence**.
- Press the Volume Down button and touch **End Now**.

## Override Do Not Disturb for Specific Apps

To let through notifications from specific apps:

1. Swipe down from the Status bar to open the Quick Settings bar and then touch .
2. Touch **Apps & notifications > Notifications > App notifications**.
3. Touch an app.
4. Touch **Override Do Not Disturb**.

## Apps

The **APPS** screen displays icons for all installed apps. The table below lists the apps installed on the device. Refer to the device Integrator Guide for Android Version 8.1 for information on installing and uninstalling apps.

Table 7 Apps









Icon	Description
	<b>Battery Manager</b> - Displays battery information, including charge level, status, health and wear level.
	<b>Bluetooth Pairing Utility</b> – Use to pair with the device by scanning a barcode.
	<b>Calculator</b> - Provides the basic and scientific arithmetic functions.
	<b>Calendar</b> - Use to manage events and appointments.
	<b>Camera</b> - Take photos or record videos. For more information see Camera.
	<b>Chrome</b> - Use to access the Internet or intranet.
	<b>Clock</b> - Use to schedule alarms for appointments or as a wake-up.
	<b>Contacts</b> - Use to manage contact information. See Contacts for more information.

Table 7 Apps (Continued)



Icon	Description
	<b>DataWedge</b> - Enables data capture using the imager.
	<b>Device Central</b> - Use to display detailed information about the device and connected peripherals. See Device Central for more information.
	<b>Diagnostic Tool</b> - Use to diagnose the device.
	<b>Drive</b> - Upload photos, videos, documents, and other files to personal storage site.
	<b>Duo</b> - A one-to-one video calling app (WWAN only).
	<b>DWDemo</b> - Provides a way to demonstrate the data capture features using the imager. See DataWedge Demonstration for more information.
	<b>Email</b> - Use to send and receive email.
	<b>Files</b> - Organize and manage files on the device. See Files for more information.
	<b>Gmail</b> - Use to send and receive email using a Google email account.
	<b>Google</b> - Launches Google™ search app.
	<b>Hangouts</b> - Use to communicate with friends using text messages and photos.
	<b>Heater Control</b> - Use to check the status on the heater and sensors when using the device in cold environments. For more information, see Heater Control.
	<b>Keep</b> - Use to create, edit, and share notes.
	<b>License Manager</b> - Use to manage software licenses on the device.

Table 7 Apps (Continued)













Icon	Description
	<b>Maps</b> - Use to see your location on a map (with public transit, traffic, or satellite overlays). Search for any business or place of interest. Provides turn-by-turn navigation with voice guidance, traffic-avoidance, and alternate routes, for drivers, cyclists, walkers, and users of public transportation.
	<b>Photos</b> - Use to sync photos with Google account. For more information, see Photo Settings.
	<b>Play Movies &amp; TV</b> - View movies and video on your device.
	<b>Play Music</b> - Use to listen to music.
	<b>Play Store</b> - Download music, movies, books, and Android apps and games from the Google Play Store.
	<b>PTT Express</b> - Use to launch PTT Express client for VoIP communication.
	<b>RxLogger</b> - Use to diagnose device and app issues. See the device Integrator Guide for Android Version 8.1 for more information.
	<b>RxLogger Utility</b> - Use to view, backup, and archive RxLogger data.
	<b>Settings</b> - Use to configure the device.
	<b>Sound Recorder</b> - Use to record audio.
	<b>StageNow</b> - Allows the device to stage a device for initial use by initiating the deployment of settings, firmware, and software.
	<b>Velocity</b> - Opens the Ivanti (formerly Wavelink) terminal emulation app.
	<b>Voice Search</b> - Use to perform searches by asking questions.



Table 7 Apps (Continued)

Icon	Description
	<b>Worry Free Wifi Analyzer</b> - A diagnostic intelligent app. Use to diagnose surrounding area and display network stats, such as coverage hole detection, or AP in vicinity. Refer to the Worry Free Wi-Fi Analyzer Administrator Guide for Android.
	<b>YouTube</b> - Use to view videos on the YouTube™ web site.
	<b>Zebra Bluetooth</b> - Use to configure Bluetooth logging.

## Accessing Apps

All apps installed on the device are accessed using the **APPS** window.

1. On the Home screen, swipe up from the bottom of the screen.

Figure 40 APPS Window Example

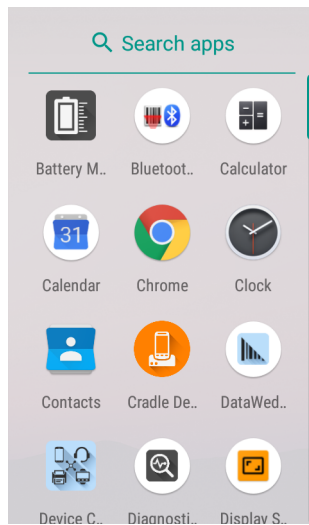

Slide the **APPS** window up or down to view more app icons. Touch an icon to open the app.

## Switching Between Recent Apps

To switch between recent apps:

1. Touch . A window appears on the screen with icons of recently used apps.

Figure 41 Recently Used Apps



2. Slide the apps displayed up and down to view all recently used apps.
3. Swipe left or right to remove app from the list and force close the app.
4. Touch an icon to open an app or touch ◀ to return to the current screen.

## Un-Locking the Screen

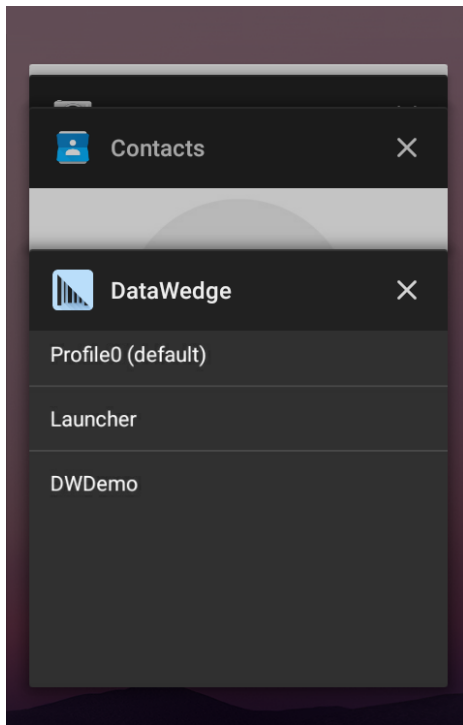
Use the Lock screen to protect access to data on the device. Some email accounts require locking the screen. Refer to the device Integrator Guide for information on setting up the locking feature.

When locked, a pattern, PIN, or password is required to unlock the device. Press the Power button to lock the screen. The device also locks after a pre-defined time-out.

Press and release the Power button to wake the device. The Lock screen displays. Swipe the screen up to unlock. If the Pattern screen unlock feature is enabled, the Pattern screen appears instead of the Lock screen. If the PIN or Password screen unlock feature is enabled, enter the PIN or password after unlocking the screen.

Figure 42 Lock Screen

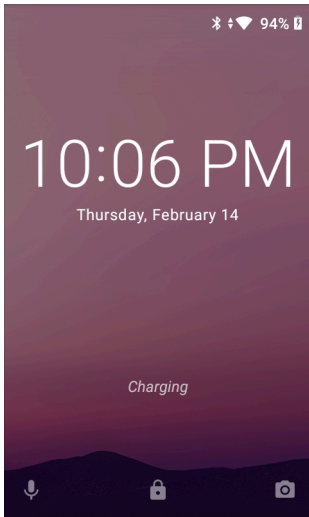

Figure 43 PIN Screen

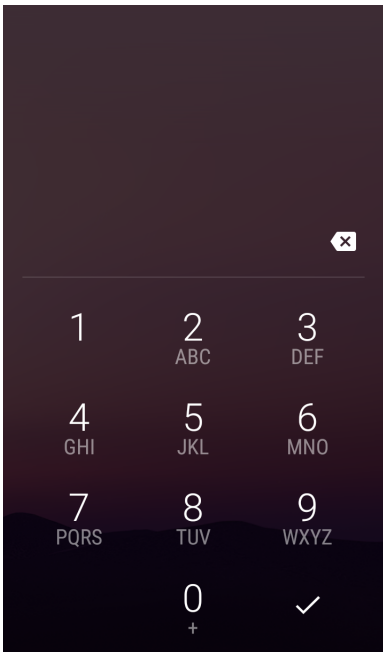
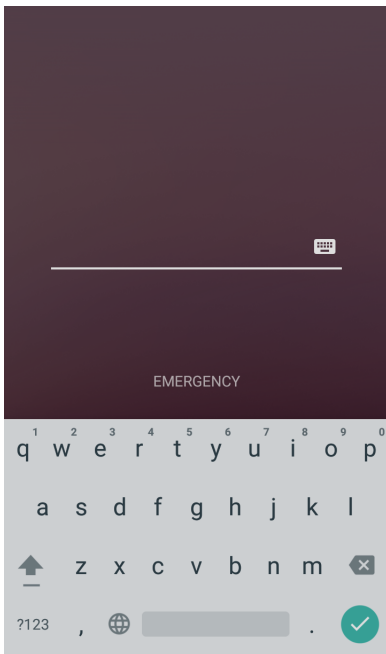

Figure 44 Pattern Screen



Figure 45 Password Screen



## Smart Lock

Keep the device unlocked in some situations, like when the device is in your holster or near a specific location. With Smart Lock, the user will not need to unlock the device with a PIN, pattern, or password.

To enable Smart Lock:

1. Ensure that a screen lock feature (PIN, pattern, or password) is enabled.
2. Swipe down from the Status bar to open the Quick Settings bar and then touch .
3. Touch **Security & location > Smart Lock**.
4. Enter the PIN, pattern, or password to continue.

Figure 46 Smart Lock Screen



5. Select one of the options:
  - **On-body detection**
  - **Trusted places**
  - **Trusted devices**
  - **Trusted face**
  - **Voice Match.**
6. Follow the on-screen instructions for setting up each option.

## Resetting the Device

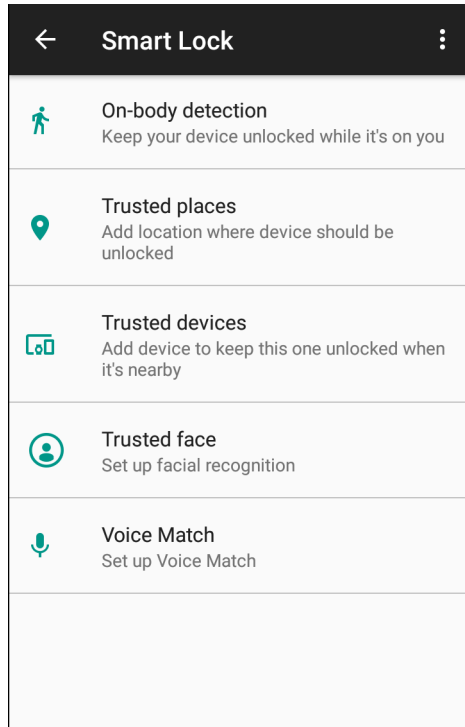
The reset functions include the following:

- Soft reset
- Hard reset
- Enterprise reset- Refer to the device Integrator Guide for more information.
- Factory reset - Refer to the device Integrator Guide for more information.

## Performing a Soft Reset

Perform a soft reset if applications stop working.

1. Press and hold the Power button until the menu appears.
2. Touch **Restart**.  
The device reboots.

## Performing a Hard Reset



**CAUTION:** Performing a hard reset with a microSD card installed in the device may cause damage or data corruption to the microSD card. All un-saved data is lost after performing a hard reset.

Perform a hard reset if the device stops responding.

1. Simultaneously press the Power, Center Scan and Trigger buttons for at least four seconds.
2. When the screen turns off, release the buttons.  
The device reboots.

## Suspend Mode

The device goes into suspend mode when you press the Power button or after a period of inactivity (set in the Display settings window).

To wake the device from Suspend mode, press the Power button or the configured wake-up sources. The Lock screen displays. Swipe the screen up to unlock. If the Pattern screen unlock feature is enabled, the Pattern screen appears instead of the Lock screen. If the PIN or Password screen unlock feature is enabled, enter the PIN or password after unlocking the screen. See Un-Locking the Screen.



**NOTE:** If you enter the PIN, password, or pattern incorrectly five times, you must wait 30 seconds before trying again. If you forget the PIN, password, or pattern contact your system administrator.

The device will wake on the detection of AC/DC power if it is either in suspend mode or powered off.

## Transferring Files with a Host Computer via USB

Connect the device to a host computer using a USB cradle to transfer files between the device and the host computer.

When connecting the device to a host computer, follow the host computer's instructions for connecting and disconnecting USB devices, to avoid damaging or corrupting files.

## Transferring Files



**NOTE:** Use Transfer files to copy files between the device (internal memory) and the host computer.

1. Place the device into a USB cradle or into the USB snap on cup.
2. Pull down the Notification panel and touch **USB charging this device**.  
By default, **Charge this device** is selected.

Figure 47 Use USB to Dialog Box

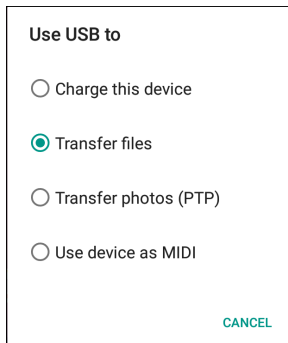

3. Touch **Transfer files**.
4. On the host computer, open a file explorer application.
5. Locate the **device** as a portable device.
6. Open the **Internal storage** folder.
7. Copy files to and from the device or delete files as required.

## Transferring Photos

To transfer photos using Photo Transfer Protocol:



**NOTE:** Use Photo Transfer Protocol (PTP) to copy photos from the internal memory to the host computer.

1. Place the device into a USB cradle.
2. Pull down the Notification panel and touch **USB charging this device**.
3. Touch **Transfer photos (PTP)**.
4. On the host computer, open a file explorer application.
5. Open the **Internal storage** folder.
6. Copy or delete photos as required.

## Disconnect from the Host Computer

To disconnect the device from the host computer:



**CAUTION:** Carefully follow the host computer's instructions to disconnect USB devices correctly to avoid losing information.

1. On the host computer, unmount the device.
2. Remove the device from the cradle.

# Applications

## Introduction

This section describes the applications installed on the device.

## Battery Manager

The **Battery Manager** provides detailed information about the battery.

To open Battery Manager, swipe up from the bottom of the Home screen and touch .



Figure 48 Battery Manager Screen

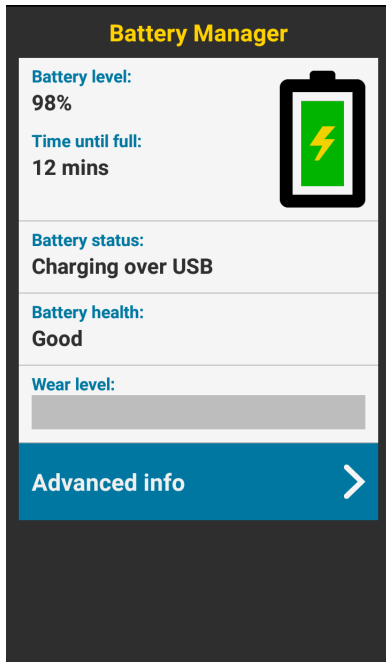



Table 8 Battery Icon Description

Battery Icon	Description
	Battery charge level.
	Battery charging.
	Battery charge level is below 15 (Standard Battery) and 9% (Freezer Battery)%.

- **Battery level** - The current battery charge level as a percentage. Displays -% when level is unknown.
- **Time until full** - The amount of time until the battery is fully charged.
- **Time since charging** - The amount of time since the device began charging.
- **Time until empty** - The amount of time until the battery is empty.
- **Battery status**
  - **Not charging** - The device is not charging.
  - **Charging over AC** - The device is connected to AC power and charging.
  - **Charging over USB** - The device is connected to a host computer with a USB cable and charging.
  - **Discharging** - That the battery is discharging.
  - **Full** - That the battery is fully charged.
  - **Unknown** - The battery status is unknown.

- **Battery health** - The health of the battery. If a critical error occurs,  appears. Touch to view the error description.
  - **Decommission** - The battery is past its useful life and should be replaced. See system administrator.
  - **Good** - The battery is good.
  - **Charge error** - An error occurred while charging. See system administrator.
  - **Over Current** - An over-current condition occurred. See system administrator.
  - **Dead** - The battery has no charge. Replace the battery.
  - **Over Voltage** - An over-voltage condition occurred. See system administrator.
  - **Below Temperature** - The battery temperature is below the operating temperature. See system administrator.
  - **Failure Detected** - A failure has been detected in the battery. See system administrator.
  - **Unknown** - See system administrator.
- **Wear level** - The health of the battery in graphical form. When the wear level exceeds 80%, the bar color changes to red.
- **Advanced info** - Touch to view additional battery information.
  - **Battery present status** - Indicates that the battery is present.
  - **Battery level** - The battery charge level as a percentage of scale.
  - **Battery scale** - The battery scale level used to determine battery level (100).
  - **Battery voltage** - The current battery voltage in millivolts.
  - **Battery temperature** - The current battery temperature in degrees Centigrade.
  - **Battery technology** - The type of battery.
  - **Battery current** - The average current into or out of the battery over the last second in mAh.
  - **Battery manufacture date** - The date of manufacture.
  - **Battery serial number** - The battery serial number. The number matches the serial number printed on the battery label.
  - **Battery part number** - The battery part number.
  - **Battery rated capacity** - Lists the rated capacity of the backup battery in mAh.
  - **Battery decommission status** - Indicates if the battery is past its life span.
    - **Battery Good** - The battery is in good health.
    - **Decommissioned Battery** - The battery is past its useful life and should be replaced.
  - **Base cumulative charge** - Cumulative charge using Zebra charging equipment only.
  - **Battery present capacity** - Maximum amount of charge that could be pulled from the battery under the present discharge conditions if the battery were fully charged.
  - **Battery health percentage** - With a range from **0** to **100**, this is the ratio of “present\_capacity” to “design\_capacity” at a discharge rate of “design\_capacity”.
  - **% decommission threshold** - The default % decommission threshold for a gifted battery as 80%.
  - **Battery present charge** - Amount of usable charge remaining in the battery at present under the current discharge conditions.
  - **Battery total cumulative charge** - The total accumulated charge in all chargers.
  - **Battery time since first use** - The time passed since the battery was placed in a Zebra terminal for the first time.
  - **Battery error status** - The error status of the battery.
  - **App version** - The application version number.

## Heater Control

The Heater Control application provides information about the sensors and heater applicable to the freezer device. To open the Heater Control, swipe up from the bottom of the Home screen and touch .



**IMPORTANT:** Heater Control app is only applicable to freezer configurations.

The scanner exit window heater ensures optimum scanner performance in freezer applications.

## Status

Figure 49 Heater Control - Status

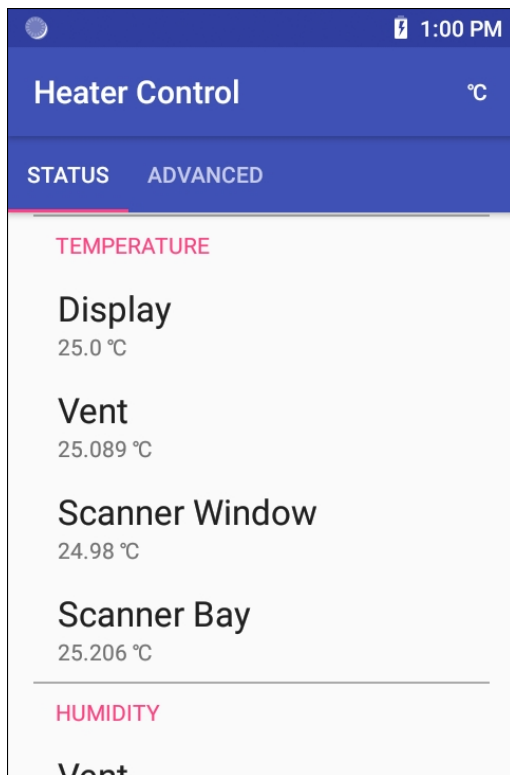

The Status tab displays:

**TEMPERATURE** for the following:

- Display
- Vent
- Scanner Window
- Scanner Bay.

**HUMIDITY** for the following:

- Vent

**HEATER** for the following:

- Scanner Window (default - enabled). This option should always be enabled for the heater to function properly. Disable this option only if you are performing debugging activities on the heater system.

## Advanced

Figure 50 Heater Control - Advanced

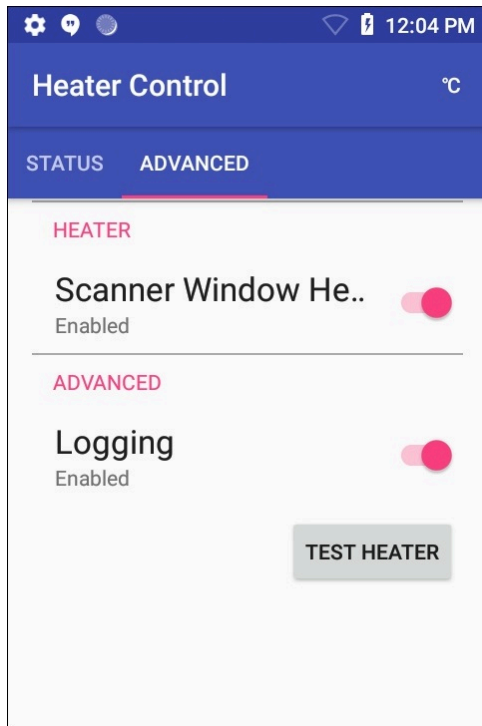

- In the **HEATER** area, tap to disable **SCANNER WINDOW HEATER**. By default this option is enabled.
- In the **ADVANCED** area, tap to enable **LOGGING**. Logging allows you to log data for the heating system (heaters and sensors). The data resides in the `/sdcard/HeaterLogs` location in a `.csv` file on the device.
- Click **TEST HEATER** to perform a diagnostic test on the heating system.



**NOTE:** Heater tests must be performed in an ambient environment with temperature of less than +30° C.

Figure 51 Heater Test

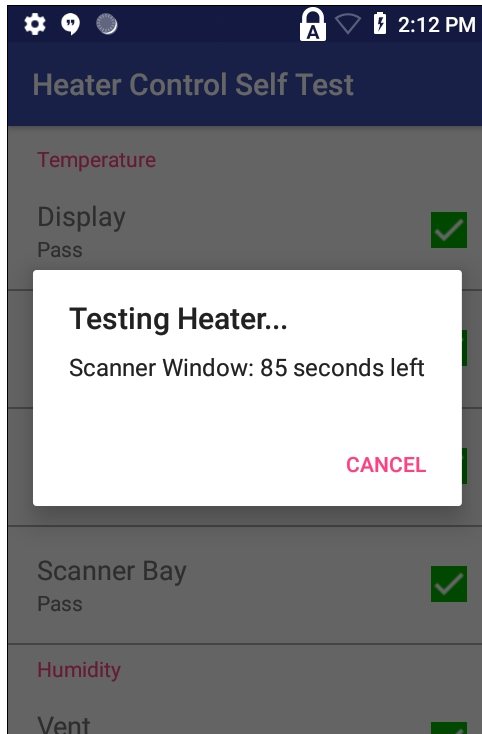

Once the tests are complete the results screen displays.

Figure 52 Heater Test (Status after Functional Check)

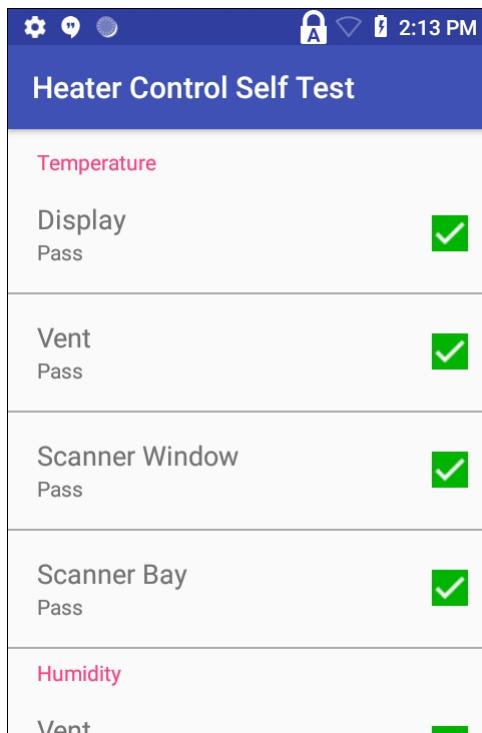

## Files

Use the **Files** app to view and manage files on the device.







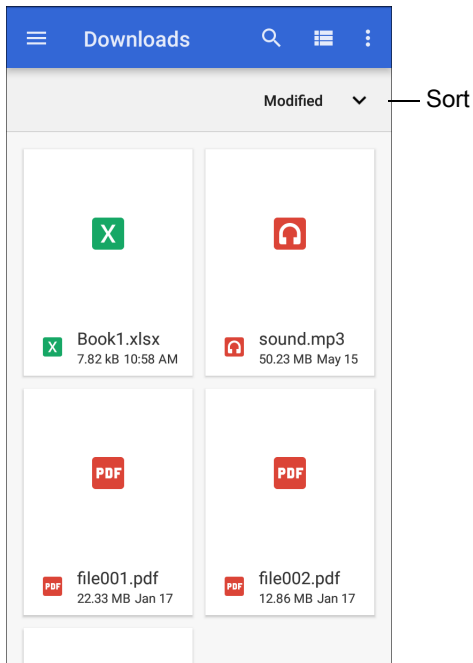

To open **Files**, swipe up from the bottom of the screen and touch .

Figure 53 Files Screen



- Touch and hold an item to open the File Operations menu. Select an option:
  -  - Share the file with other devices.
  -  - Delete the file.
  -  - View additional options.
    - **Open with** - Select which app is used to open the file.
    - **Select all** - Select all folders and files.
    - **Copy to...** - Copy the file.
    - **Move to...** - Move the file or folder to a new location.
    - **Compress** - Compress the selected file(s) into a ZIP file.
    - **Rename** - Rename the file.
- Touch the Sort drop-down to sort files by name, type, size, or date.
-  - View all file locations.
-  - Search for a specific file on the device.
-  /  - Change the folder to display items as a list / grid.
-  - Open the options menu.
  - **New Window** - Create a new Files window.
  - **New Folder** - Create a new folder.
  - **Select all** - Select all folders and files.
  - **Show/Hide internal storage** - Show or hide internal storage.

## Contacts

Use the **Contacts** app to manage contacts.

From a Home or Apps screen, touch **Contacts** to open to the main list of contacts. Contacts are listed in alphabetical order. Swipe up or down to scroll through the list.

### Adding a Contact

1. In the **Contacts** app, touch .
2. If there is more than one account with contacts, touch the one you want to use.
3. Type the contact's name and other information. Touch a field to start typing, and swipe down to view all categories.
4. To open a menu with preset labels, such as Home or Work for an email address, touch the label to the right of the item of contact information. Or, to create your own label, touch **Custom** in the menu.
5. Touch the check mark next to **Add New Contact**.

### Editing Contacts

1. In the **Contacts** app, touch a contact name to edit.
2. Touch .
3. Edit the contact information.
4. Touch **SAVE**.

### Deleting Contacts

1. In the **Contacts** app, touch a contact name to delete.
2. Touch .
3. Touch **Delete**.
4. Touch **DELETE** to confirm.

## Camera

This section provides information for taking photos and recording videos using the integrated digital cameras.



The device saves photos and videos on the microSD card, if installed and the storage path is changed manually. By default, or if a microSD card is not installed, the device saves photos and videos on the internal storage. On SDM660 platform-based products, you can use the imager and camera simultaneously. By default, third-party camera applications are associated with the Datawedge Profile0 where scanning is enabled. In these applications the Scan button initiates the scan session. If you do not want scanning to be enabled in the application, you must associate a new Datawedge profile with the application and disable scanning.



**NOTE:** The native Google camera application is associated with a hidden DataWedge profile. The scanning functionality is temporarily disabled when the Google camera application is being used. If a third-party camera application is utilized the scanning functionality will not be disabled allowing the simultaneous use of the scanner and the camera. This will have a direct impact on the image quality. It is strongly recommended that you use the native Google camera application.



## Taking Photos





**NOTE:** See Photo Settings for camera setting descriptions.

1. Swipe up from the bottom of the Home screen and touch **Camera**.

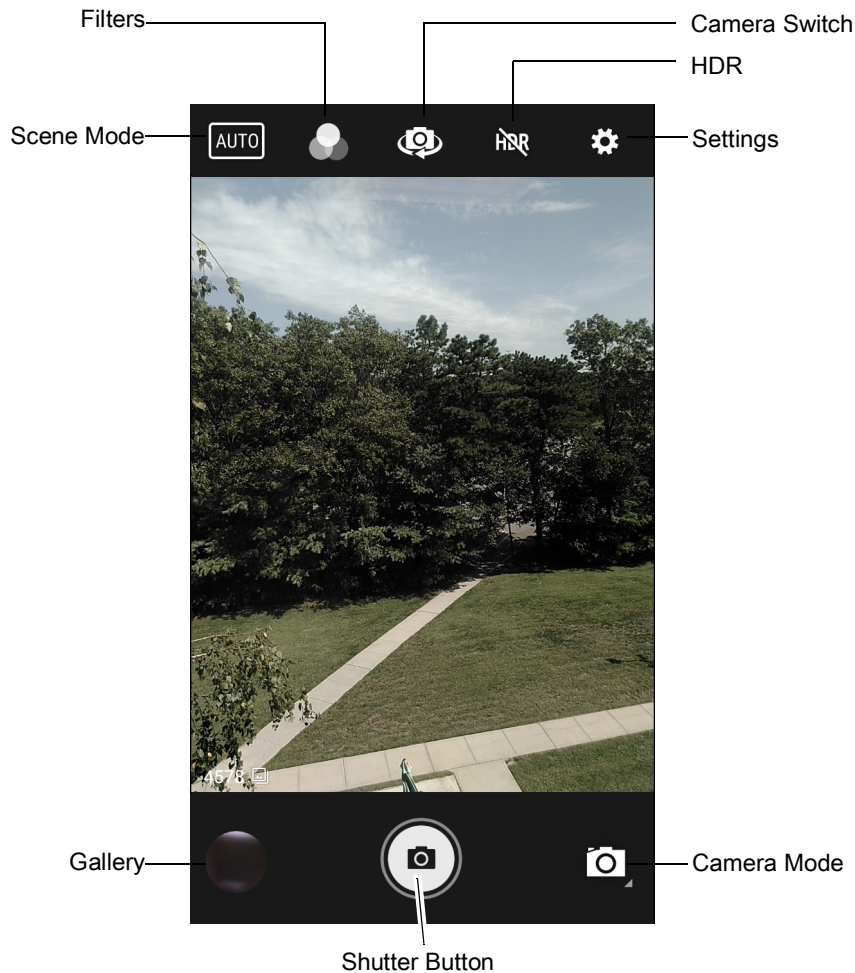
Figure 54 Camera Mode



2. If necessary, touch the Camera Mode icon and touch .
3. To switch between the rear camera and front camera (if available), touch .
4. Frame the subject on the screen.
5. To zoom in or out, press two fingers on the display and pinch or expand fingers. The zoom controls appear on the screen.
6. Touch an area on the screen to focus. The focus circle appears. The two bars turn green when in focus.
7. Touch .
 

The camera takes a photo and a shutter sound plays.

The photo momentarily displays as a thumbnail in the lower left corner.



## Taking a Panoramic Photo

Panorama mode creates a single wide image by panning slowly across a scene.

1. Swipe up from the bottom of the Home screen and touch **Camera**.

Figure 55 Panoramic Mode



2. Touch the Camera Mode icon and touch .
3. Frame one side of the scene to capture.
4. Touch  and slowly pan across the area to capture. A small white square appears inside the button indicating the capture is in progress.  
If you are panning too quickly, the message **Too fast** appears.
5. Touch  to end the shot. The panorama appears immediately and a progress indicator displays while it saves the image.

## Recording Videos





1. Swipe up from the bottom of the Home screen and touch **Camera**.
2. Touch the camera mode menu and touch .

Figure 56 Video Mode



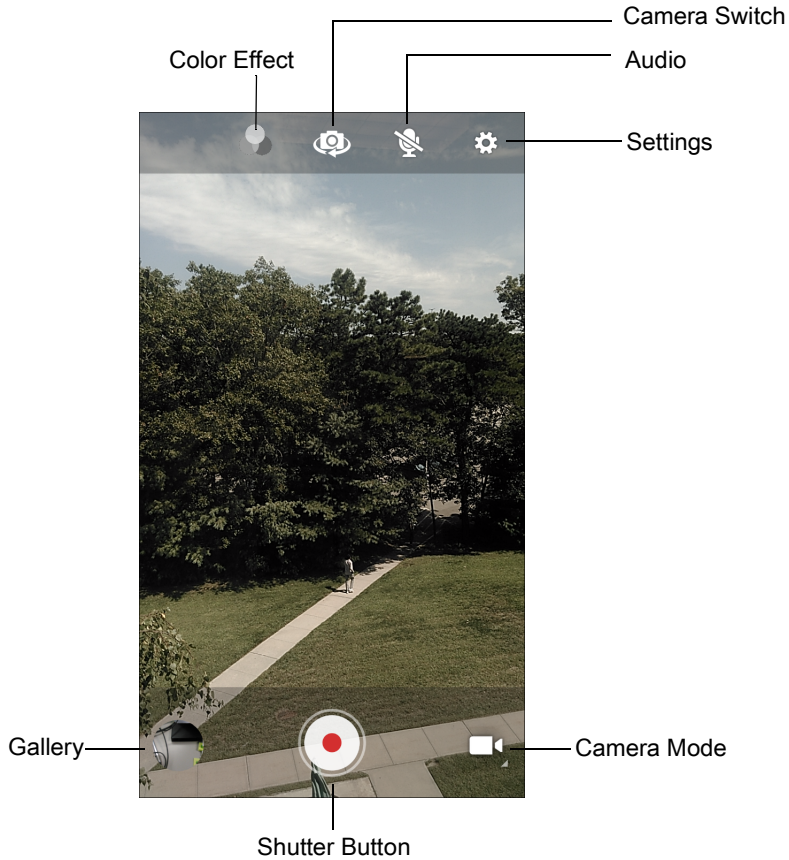







3. To switch between the rear camera and front camera (if available), touch .
4. Point the camera and frame the scene.
5. To zoom in or out, press two fingers on the display and pinch or expand fingers. The zoom controls appear on the screen.
6. Touch  to start recording.  
The video time remaining appears in the top left of the screen.
7. Touch  to the end recording.  
The video momentarily displays as a thumbnail in the lower left corner.

## Photo Settings

In Photo mode, photo settings appear on screen. Touch  to display the photo settings options.







## Rear Camera

- **Flash** - Select whether the camera relies on its light meter to decide whether a flash is necessary, or to turn it on or off for all shots.
  -  **Off** - Disable flash.
  -  **Auto** - Adjust flash automatically depending upon light meter (default).
  -  **On** - Enable flash upon taking a photo.
- **Picture size** - The size (in pixels) of the photo to: **13M pixels** (default), **8M pixels**, **5M pixels**, **3M pixels**, **HD 1080**, **2M pixels**, **HD720**, **1M pixels**, **WVGA**, **VGA**, or **QVGA**.
- **Picture quality** - Set the picture quality setting to: **Low**, **Standard** (default) or **High**.
- **Countdown timer** - Select **Off** (default), **2 seconds**, **5 seconds** or **10 seconds**.
- **Storage** – Set the location to store the photo to: **Phone** or **SD Card**.
- **Face Detection** - Select to turn face detection **Off** (default) or **On**.
- **ISO** - Set camera sensitivity to light to: **Auto** (default), **ISO Auto (HJR)**, **ISO100**, **ISO200**, **ISO400**, **ISO800** or **ISO1600**.
- **Exposure** - Set the exposure settings to: **+2**, **+1**, **0**(default), **-1** or **-2**.
- **White balance** - Select how the camera adjusts colors in different kinds of light, to achieve the most natural-looking colors:
  -  **Incandescent** - Adjust the white balance for incandescent lighting.
  -  **Fluorescent** - Adjust the white balance for florescent lighting.
  -  **Auto** - Adjust the white balance automatically (default).
  -  **Daylight** - Adjust the white balance for daylight.
  -  **Cloudy** - Adjust the white balance for a cloudy environment.
- **Chroma Flash** - Sets the camera to take two pictures, one with flash and one without flash. The two images are combined to produce a final image with the sharpness and clarity and bright color tones from a picture with the flash, coupled with the natural colors of a picture without a flash. Options: **Off** (default) or **On**.
- **Redeye reduction** - Helps eliminate redeye effect. Options: **Disabled** (default), or **Enable**.
- **ZSL** - Set the camera to immediately take a picture when the button is pressed (default – enabled).
- **Anti Banding** - Allows the camera to avoid problems caused by artificial light sources that are not constant. These sources cycle (flicker) fast enough to go unnoticed to the human eye, appearing continuous. The camera's eye (its sensor) can still see this flicker. Options: **Auto** (default), **60 Hz**, **50 Hz**, or **Off**.

## Video Settings

In Video mode, video settings appear on screen. Touch  to display the video settings options.

### Rear Camera

- **Flash** - Select whether Rear-facing Camera relies on its light meter to decide whether a flash is necessary, or to turn it on or off for all shots.
  -  **Off** - Disable flash (default).
  -  **Torch** - Turn flash on continuously.
- **Video quality** - Set video quality to: **HD 1080p** (default), **HD 720p**, **SD 480p**.
- **Video duration** - Set to: **30 seconds (MMS)**, or **30 minutes** (default).
- **Storage** – Set the location to store the photo to: **Phone** (default) or **SD Card**.
- **White balance** - Select how the camera adjusts colors in different kinds of light, to achieve the most natural-looking colors.
  -  **Incandescent** - Adjust the white balance for incandescent lighting.
  -  **Fluorescent** - Adjust the white balance for florescent lighting.
  -  **Auto** - Adjust the white balance automatically (default).
  -  **Daylight** - Adjust the white balance for daylight.
  -  **Cloudy** - Adjust the white balance for a cloudy environment.
- **Image Stabilization** - Set to reduce blurry videos due to device movement. Options: **On** or **Off** (default).

## Photos



**NOTE:** The device supports the following image formats: jpeg, gif, png, and bmp.

The device supports the following video formats: H.263, H.264, and MPEG4 Simple Profile.

Available on device with GMS only.

Use **Photos** to:

- View photos
- Play videos
- Perform basic editing of photos
- Set photos as wallpaper
- Set photos as a contact photo
- Share photos and videos.

**Photos** presents all photos and videos stored on the internal memory.

To open **Photos**, swipe up from the bottom of the Home screen and touch **Photos**.

By default, **Photos** opens to the photos view.

Figure 57 Photos View

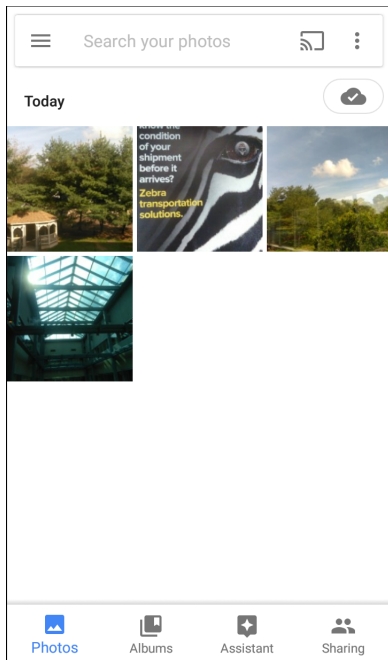

Touch **Albums** to view photos sorted by albums.

Figure 58 Albums View

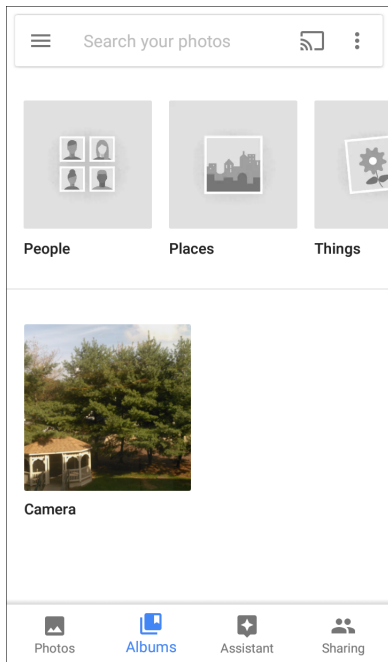

- Touch an album to view its contents. The photos and videos in the album appear in chronological order.
- Touch a photo or video in an album to view it.
- Touch ← to return to the main screen.

## Working with Albums

Albums are groups of images and videos in folders. Touch an album to open it. The photos and videos are listed in a chronologically ordered grid. The name of the album displays at the top of the screen.

Figure 59 Photos Inside an Album

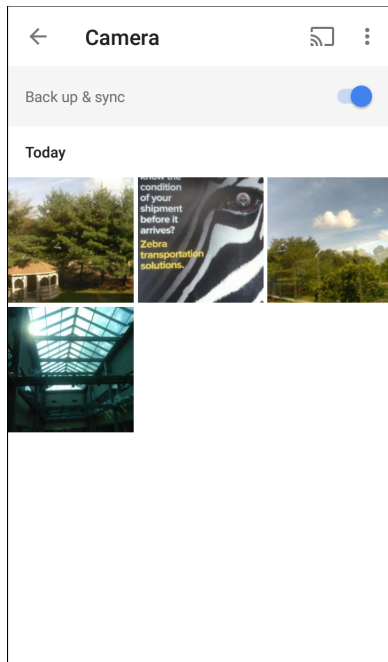

Swipe up to scroll through the images.

## Sharing an Album

1. Swipe up from the bottom of the Home screen and touch **Photos**.
2. Touch **Albums**.
3. Touch an album.
4. Touch **⋮** > **Select**.
5. Select all photos in the album.
6. Touch **🔗**. The Share menu opens.
7. Touch an app to share the selected albums.
8. Follow the instructions within the selected app.

## Deleting an Album

To delete an album and its contents:

1. Swipe up from the bottom of the Home screen and touch **Photos**.
2. Touch **Albums**.
3. Touch an album.
4. Touch **⋮** > **Select**.
5. Select all photos in the album.
6. Touch **🗑️**.



7. Touch **Move to trash** to delete the album.

## Working with Photos

Use **Photos** to view photos on the internal memory.

## Viewing and Browsing Photos

1. Swipe up from the bottom of the Home screen and touch **Photos**.
2. Touch a photo.

Figure 60 Photo Example

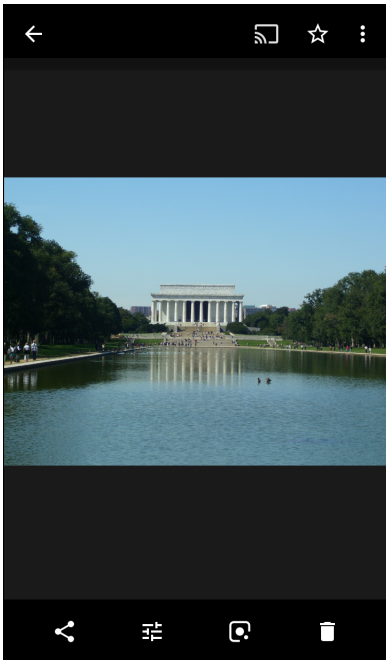

3. Swipe left or right to view the next or previous photo in the album.
4. Turn the device to view the photo in upright (portrait) or sideways (landscape) orientation. The photo is displayed (but not saved) in the new orientation.
5. Touch the photo to view the controls.
6. Double-tap the screen to zoom in, or pinch two fingers together or spread them apart to zoom in or out.
7. Drag the photo to view parts that are not in view.

## Cropping a Photo



1. Swipe up from the bottom of the Home screen and touch **Photos**.
2. Touch a photo to view the controls.
3. Touch  > . The cropping tool appears.

Figure 61 Cropping Tool



4. Use the cropping tool to select the portion of the photo to crop.
  - Drag from the inside of the cropping area to move it.
  - Drag an edge of the cropping area to resize it to any proportion.
5. Touch **DONE**.
6. Touch **SAVE** to save a copy of the cropped photo. The original version is retained.

## Setting a Photo as a Contact Icon

1. Swipe up from the bottom of the Home screen and touch **Photos**.
2. Touch the photo to open it.
3. Touch **⋮** > **Use as**.
4. Touch **Contact photo**.
5. In the **Contacts** app, touch a contact.
6. Touch the white box and crop the photo accordingly.
7. Touch **Done**.

## Sharing a Photo

1. Swipe up from the bottom of the Home screen and touch **Photos**.
2. Touch an album to open it.
3. Touch a photo to open it.
4. Touch **📧**.

5. Touch the app to use to share the selected photo.
6. Follow the instructions within the selected app.

### Deleting a Photo

1. Swipe up from the bottom of the Home screen and touch **Photos**.
2. Touch a photo to open it.
3. Touch .
4. Touch **MOVE TO TRASH**.

### Working with Videos

Use **Photos** to view and share videos.

#### Watching a Video

1. Swipe up from the bottom of the Home screen and touch **Photos**.
2. Touch a video to play.
3. Touch the screen to view the playback controls.

#### Sharing a Video

1. Swipe up from the bottom of the Home screen and touch **Photos**.
2. Touch a video to open it.
3. Touch . The Share menu appears.
4. Touch the app to use to share the selected video.
5. Follow the instructions within the selected app.

#### Deleting a Video

1. Swipe up from the bottom of the Home screen and touch **Photos**.
2. Touch a video to open it.
3. Touch .
4. Touch **MOVE TO TRASH** to delete the video.

## DataWedge Demonstration



**NOTE:** DataWedge is enabled on the Home screen. To disable this feature, go to the DataWedge settings and disable the **Launcher** profile.

Use **DataWedge Demonstration** to demonstrate data capture functionality.

Figure 62 DataWedge Demonstration Window

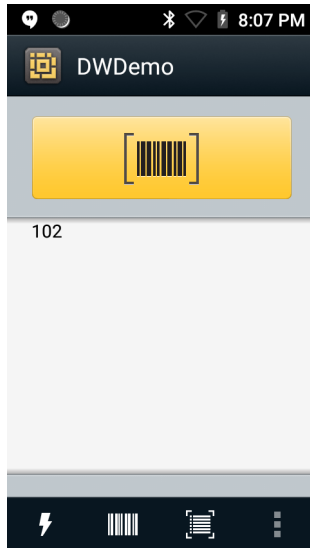





Table 9 DataWedge Demonstration Icons

	Icon	Description
Illumination		Imager illumination is on. Touch to turn illumination off.
		Imager illumination is off. Touch to turn illumination on.
Data Capture		The data capture function is through the internal imager.
		A Bluetooth scanner is connected.
		A Bluetooth scanner is not connected.
		The data capture function is through the rear camera.

Table 9 DataWedge Demonstration Icons (Continued)

	Icon	Description
Scan Mode		Imager is in picklist mode. Touch to change to normal scan mode.
		Imager is in normal scan mode. Touch to change to picklist mode.
		Opens a menu to view the application information or to set the application DataWedge profile.



**NOTE:** See the device Integrator Guide for Android Version 8.1 for information on DataWedge configuration.

## Scanner Selection

To select a scanner, touch  > **Settings** > **Scanner selection**.

See Data Capture for more information.

Either press the programmable button or touch the yellow scan button to capture data. The data appears in the text field below the yellow button.

## Sound Recorder

Use **Sound Recorder** to record audio messages.

Recordings are saved on the microSD card (if installed) or the internal storage and are available in the Play Music application (GMS devices).

Figure 63 Sound Recorder Application

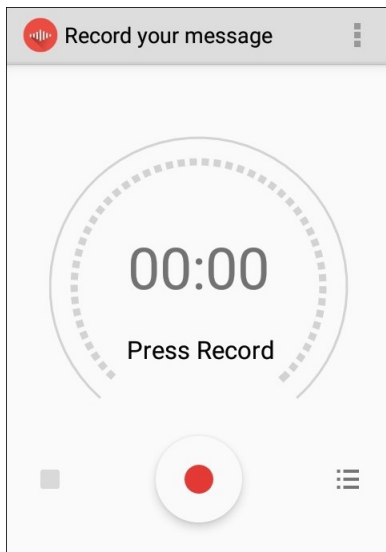

## PTT Express Voice Client



**NOTE:** PTT Express Voice Client enables Push-To-Talk (PTT) communication between disparate enterprise devices. Leveraging existing Wireless Local Area Network (WLAN) infrastructure, PTT Express delivers simple PTT communication without requiring a voice communication server.

- **Group Call:** Press and hold the PTT (Talk) button to start communicating with other voice client users.
- **Private Response:** Double-press the PTT button to respond to the originator of the last broadcast or to make a Private Response.

## PTT Audible Indicators







The following tones provide helpful cues when using the voice client.

- **Talk Tone:** Double chirp. Plays when the Talk button is depressed. This is a prompt for you to start talking.
- **Access Tone:** Single beep. Plays when another user just finished a broadcast or response. You can now initiate a Group Broadcast or Private Response.
- **Busy Tone:** Continuous tone. Plays when the Talk button is depressed and another user is already communicating on the same talkgroup. Plays after the maximum allowed talk time is reached (60 seconds).
- **Network Tone:**
  - Three increasing pitch beeps. Plays when PTT Express acquires the WLAN connection and the service is enabled.
  - Three decreasing pitch beeps. Plays when PTT Express loses the WLAN connection or the service is disabled.

## PTT Notification Icons

Notification icons indicate the current state of the PTT Express Voice client.

Table 10 PTT Express Icon Descriptions

Status Icon	Description
	The PTT Express Voice client is disabled.
	The PTT Express Voice client is enabled but not connected to a WLAN.
	The PTT Express Voice client is enabled, connected to a WLAN, and listening on the Talk Group indicated by the number next to the icon.
	The PTT Express Voice client is enabled, connected to a WLAN, and communicating on the Talk Group indicated by the number next to the icon.
	The PTT Express Voice client is enabled, connected to a WLAN, and in a private response.
	The PTT Express Voice client is enabled and muted.
	The PTT Express Voice client is enabled but it is not able to communicate due to a VoIP telephony call in progress.

## Enabling PTT Communication

1. Swipe up from the bottom of the Home screen and touch .
2. Slide the **Enable/Disable Switch** to the **ON** position. The button changes to **ON**.

## Selecting a Talk Group

One of 32 Talk Groups can be selected by PTT Express users. However, only one talk group may be enabled at a time on the device. Touch one of the 32 Talk Groups. The selected Talk Group is highlighted.

## PTT Communication



**NOTE:** This section describes the default PTT Express client configuration. Refer to the PTT Express V1.2 User Guide for detailed information on using the client.

Figure 64 PTT Button



## Creating a Group Call

1. Press and hold the PTT button (or the Talk button on the headset) and listen for the talk tone.  
If you hear a busy tone, release the button and wait a moment before making another attempt. Ensure that PTT Express and the WLAN are enabled.
2. Start talking after hearing the talk tone.



**NOTE:** Holding the button for more than 60 seconds (default) drops the call, allowing others to make Group calls. Release the button when finished talking to allow others to make calls.

## Responding with a Private Response



The Private Response can only be initiated once a Group Call has been established. The initial Private Response is made to the originator of the Group Call.

1. Wait for an access tone.
2. Within 10 seconds, double-press the PTT button, and listen for the talk tone.



3. If you hear a busy tone, release the button and wait a moment before making another attempt. Ensure that PTT Express and the WLAN are enabled.
4. Start talking after the talk tone plays.
5. Release the button when finished talking.

### Disabling PTT Express Voice Client Communication

1. Swipe up from the bottom of the Home screen and touch .
2. Slide the **Enable/Disable Switch** to the **OFF** position. The button changes to **OFF**.
3. Touch .

## RxLogger

RxLogger is a comprehensive diagnostic tool that provides app and system metrics. Create custom plug-ins that work seamlessly with this tool. RxLogger diagnoses device and application issues, and tracks information for: CPU load, memory load, memory snapshots, battery consumption, power states, wireless logging, TCP dumps, Bluetooth logging, logcat, ANR dumps, etc. All logs and files generated are saved in flash storage on the device (internal or external).

Figure 65 RxLogger

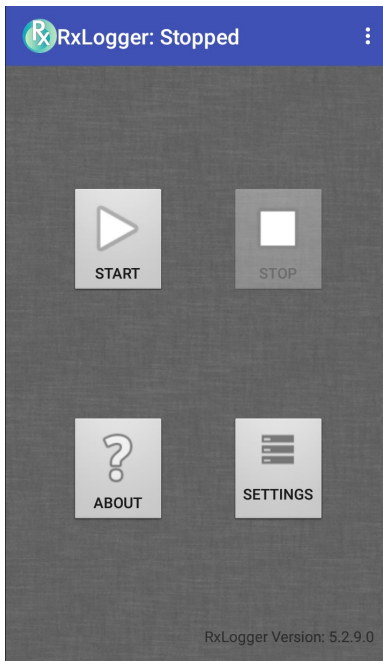

## RxLogger Utility

RxLogger Utility is a data monitoring application for viewing logs in the device while RxLogger is running. Access the logs and RxLogger Utility features in the App View or the Overlay View.

In the App View, view logs in the RxLogger Utility.

Figure 66 RxLogger Utility App View

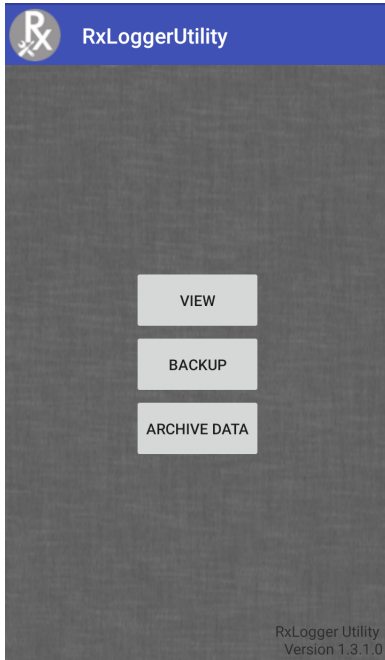

Refer to the [RxLogger Utility](#) for detailed information on the RxLogger Utility.

## Diagnostic Tool

The **Diagnostic Tool** is a utility that determines the health of the device. Use the Diagnostic Tool to troubleshoot the device.

1. Swipe up from the bottom of the Home screen and touch .

Figure 67 Diagnostic Tool



2. Touch **RUN TEST**. The app tests all enabled subsystems (by default, only the Battery and System tests). See Settings to enable subsystem tests.

Figure 68 Test Passed Screen

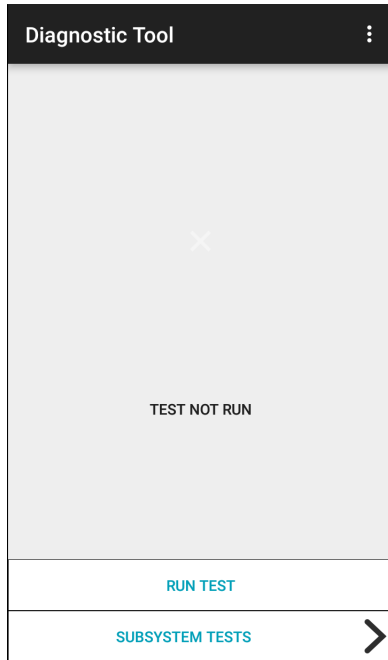
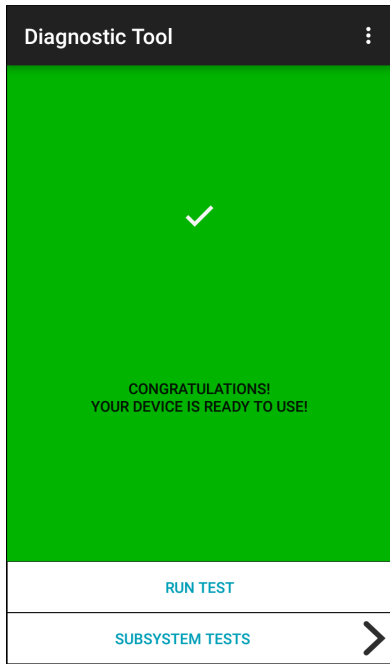
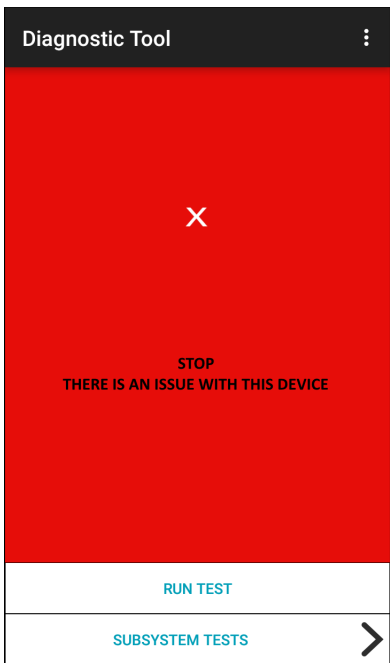
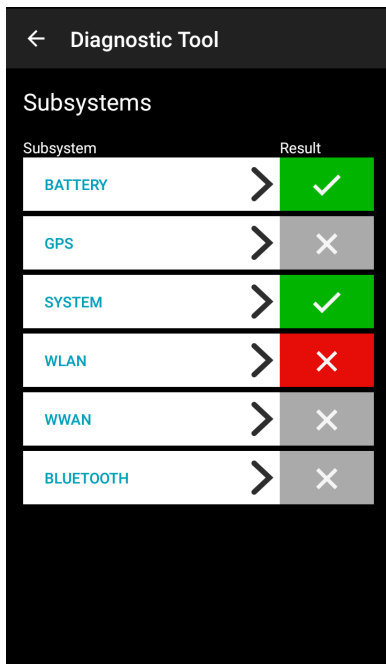

Figure 69 Test Failed Screen



3. To view each subsystem test, touch **Subsystem Tests**.

Figure 70 Subsystem Screen



4. Touch one of the subsystems to view details.

Table 11 Subsystem Test Result Indicators



Status Icon	Description
	Test passed.
	Test failed.
	Test not supported or not enabled.

Figure 71 Battery Subsystem Details

The screenshot shows a 'Diagnostic Tool' interface with a 'Battery Test' section. Under 'Statistics', there are seven rows of data:

Statistic	Value	Indicator
Battery Level	78%	Green checkmark
Battery Voltage	4.024 V	Information icon (i)
Status	Charging	Information icon (i)
Power Source	USB Power	Information icon (i)
Temperature	26.0° C	Green checkmark
Health Percentage	100%	Green checkmark
Backup Battery Voltage	0 V	Information icon (i)

## Settings

By default only the Battery and System tests are enabled. To enable other tests:

1. Touch **☰** > **Settings**.
2. Touch to the left of the test name. A green box with a checkmark appears.
3. Touch **SAVE**.
4. Touch **Yes** to confirm.
5. Touch **◀**.

## Battery Test Information

The Battery Test obtains the following information:

- **Battery Level** - Current battery charge level
- **Battery Voltage** - Current battery voltage
- **Status** - Whether the battery is charging (on AC power) or discharging (on battery power)
- **Power Source** - Whether the device is receiving power from the battery or from an external source
- **Temperature** - Current battery temperature
- **Health Percentage** - Indicates the ratio of present capacity to design capacity at a discharge rate of design capacity.
- **Backup Battery Voltage** - Backup battery voltage. The MC93XX has a supercapacitor and not a backup battery, so this statistic will always display as 0 V.
- **Manufacture Date** - Manufacture date of the battery.

## GPS Test Information

Not supported on this device.

## System Test Information

Use the System Test to determine if the CPU or memory loads are too high, there are too many processes running on the device, or storage on the device is almost full.

The System Test obtains the following information:

- **CPU Load** - Amount of CPU being used
- **Free Physical Memory** - Amount of RAM available
- **Free Storage** - Amount of internal Flash memory available
- **Process Count** - Number of processes currently running.

## WLAN Test Information

If the WiFi radio is not present or disabled, skip this test. This test determines if the device's WLAN configuration is correct or whether there is any connection with an access point or network.

The WLAN test obtains the following information:

- **WLAN Enabled** - WLAN radio is enabled or disabled
- **WLAN Status** - Current status of association with the access point
- **ESSID** - Name of the wireless network
- **BSSID** - MAC address of the connected access point
- **MAC Address** - Device's MAC address
- **Signal** - Strength of the Wi-Fi signal (in dBm)
- **IP Address** - IP address of the device.

## WWAN Test Information

Not supported on this device.

## Bluetooth Test Information

The Bluetooth Test obtains the following information:

- **Enabled** - Whether the Bluetooth radio is enabled or disabled
- **Status** - Whether the device is paired to another Bluetooth device
- **Connectable/Discoverable** - Whether the device is discoverable or able to connect
- **Address** - Bluetooth radio MAC address
- **Name** - Bluetooth name for the device.



## Device Central

**Device Central** displays detailed information about the device and connected peripherals and supports the following Zebra devices:

- RS507/RS507X Hands-free Imager
- RS6000 Bluetooth Ring Scanner
- DS3678 Digital Scanner.

Device Central features include:

- Discovering and pairing with supported peripherals via Bluetooth or corded connection.
- Paging a connected RS6000 Ring Scanner.
- Displaying the connection status of peripherals.
- Displaying information for a connected peripheral in the notification bar.

Figure 72 Device Central Screen

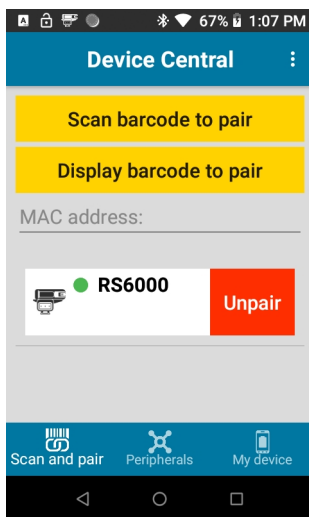

## Paging an RS6000 Ring Scanner

Use **Page** button to easily locate the currently connected RS6000 Ring Scanner:

1. With the RS6000 Ring Scanner connected, swipe up from the bottom of the Home screen, and touch .



**NOTE:** The RS6000 Ring Scanner must be within 10 m (32 ft) of the device.

2. Touch RS6000. The Device Details screen displays.

Figure 73 Page RS6000

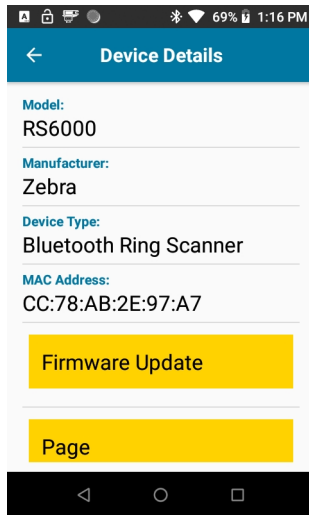

3. Under the RS6000 peripheral information, touch **Page** to page the RS6000. The paged RS6000 beeps and vibrates.

To stop paging, press the scan trigger of the RS6000. On a triggerless RS6000, reset the RS6000 to stop paging. Refer to the RS6000 User Guide.

# Data Capture

## Introduction

This chapter provides information for capturing barcode data using the internal camera and optional scan modules and Bluetooth scanner.

The device offers the following data capture options:

- Imager (SE4750-SR 2D, SE4850-ER 2D, SE4770 2D, SE4750DPM, and SE4750DPW).
- Laser Scanner (SE965 1D).
- Bluetooth (RS507/RS507X Hands-free imager, RS6000 Bluetooth Ring Scanner, and DS3678 Digital Barcode Scanner).



**NOTE:** DataWedge is installed and enabled on the device by default.

By default, the good decode beep is set to system volume (Notifications). The good decode beep can be set to another sound (Music and Media), and the volume can be independently controlled. See the DataWedge section in the Integrator Guide for more information.

## Integrated Imager

The device with an integrated 2D imager has the following features:

- Omnidirectional reading of a variety of barcode symbologies, including the most popular linear, postal, PDF417, Digimarc, and 2D matrix code types.
- Advanced intuitive laser aiming cross-hair and dot aiming for easy point-and-shoot operation.

The imager uses imaging technology to take a picture of a barcode, and executes state-of-the-art software decoding algorithms to extract the barcode data from the image.

## Operational Modes

The device with an integrated imager supports two modes of operation, listed below. Activate each mode by pressing the Scan button.

- Decode mode - The device attempts to locate and decode enabled barcodes within its field of view. The imager remains in this mode as long as you hold the scan button, or until it decodes a barcode.



**NOTE:** To enable Pick List Mode, configure in DataWedge or set in an application using a API command.

- Pick List mode - Selectively decode a barcode when more than one barcode is in the device's field of view by moving the aiming crosshair or dot over the required barcode. Use this feature for pick

lists containing multiple barcodes and manufacturing or transport labels containing more than one barcode type (either 1D or 2D).

### Laser Scanner

The device with a laser scanner has the following features:

- Reading of a variety of barcode symbologies, including the most popular linear, and 1D code types.
- Intuitive laser aiming for easy point-and-shoot operation.

### RS507/RS507X Hands-Free Imager

The RS507/RS507X Hands-free Imager is a wearable barcode scan solution for both 1D and 2D barcode symbologies.

Figure 74 RS507/RS507X Hands-Free Imager

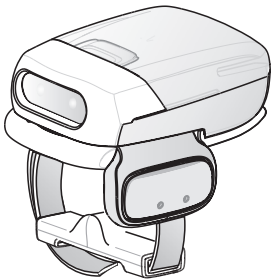

Refer to the RS507/RS507X Hands-free Imager Product Reference Guide for more information.

### RS6000 Bluetooth Ring Scanner

The RS6000 Bluetooth Ring Scanner is a wearable barcode scan solution for both 1D and 2D barcode symbologies.

Figure 75 RS6000 Bluetooth Ring Scanner

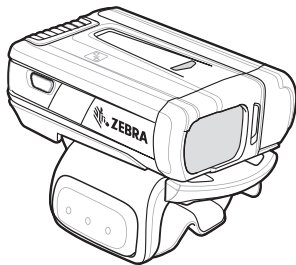

Refer to the RS6000 Bluetooth Ring Scanner Product Reference Guide for more information.

### DS3678 Digital Scanner

The cordless DS3678 combines superior 1D and 2D omnidirectional barcode scanning performance and advanced ergonomics in a lightweight design. See the DS36X8 Product Reference Guide for more information.

Figure 76 DS3678 Digital Scanner

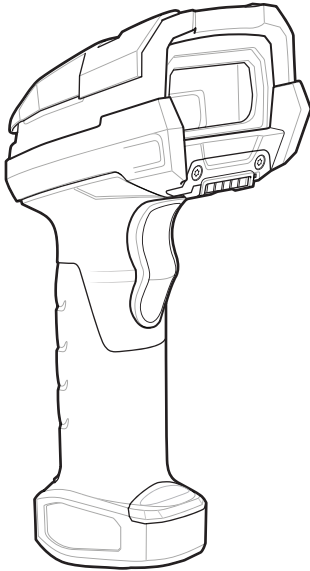

## Scanning Considerations

Typically, scanning is a simple matter of aim, scan, and decode, with a few quick trial efforts to master it. However, consider the following to optimize scanning performance:

- **Range:** Scanners decode best over a particular working range — minimum and maximum distances from the barcode. This range varies according to barcode density and scanning device optics. Scan within range for quick and constant decodes; scanning too close or too far away prevents decodes. Move the scanner closer and further away to find the right working range for the barcodes being scanned.
- **Angle:** Scanning angle is important for quick decodes. When the illumination/flash reflects directly back into the imager, the specular reflection can blind/saturate the imager. To avoid this, scan the barcode so that the beam does not bounce directly back. Do not scan at too sharp an angle; the scanner needs to collect scattered reflections from the scan to make a successful decode. Practice quickly shows what tolerances to work within.
- Hold the device farther away for larger symbols.
- Move the device closer for symbols with bars that are close together.



**NOTE:** Scanning procedures depend on the app and device configuration. An app may use different scanning procedures from the one listed above.

## Barcode Capture with Imager

To capture barcode data:

1. Ensure that an application is open on the device and a text field is in focus (text cursor in text field).
2. Point the top of the device at a barcode.

Figure 77 Barcode Scanning – MC93XX

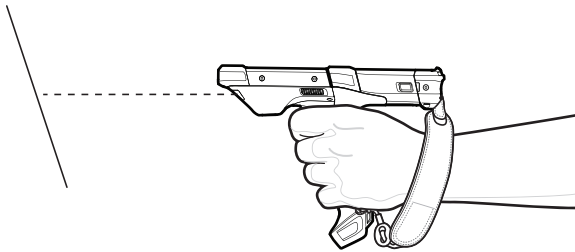

3. Press and hold the Scan button or Trigger.  
The red laser aiming pattern turns on to assist in aiming.
4. Ensure the barcode is within the area formed by the cross-hairs in the aiming pattern. The aiming dot is used for increased visibility in bright lighting conditions.  
The Scan LEDs light green and a beep sounds, by default, to indicate the barcode was decoded successfully. Note that when the device is in Pick List Mode, the device does not decode the barcode until the center of the crosshair touches the barcode.

Figure 78 Aiming Pattern: Standard and Extended Range

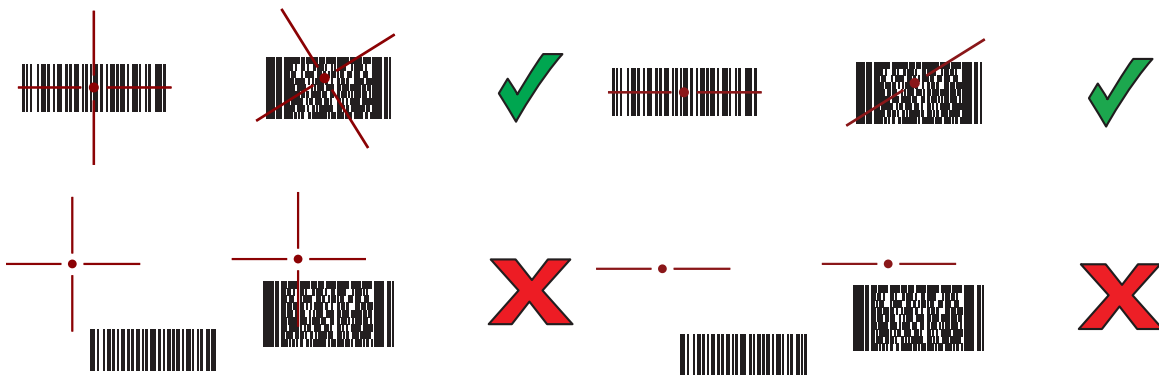

Figure 79 Pick List Mode with Multiple Barcodes in Aiming Pattern: Standard and Extended Range



5. Release the scan button or Trigger.
6. The barcode content data appears in the text field.

## Barcode Capture with Laser Scanner

To capture barcode data:

1. Ensure that an application is open on the device and a text field is in focus (text cursor in text field).

2. Point the top of the device at a barcode.
3. Point the scan exit window at a barcode.

Figure 80 Barcode Scanning – MC93XX

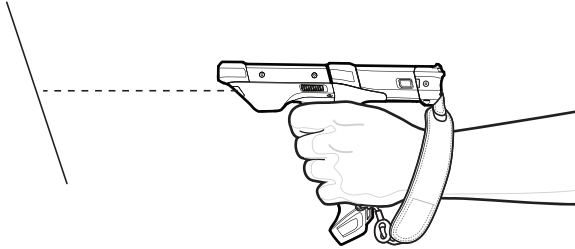

4. Press and hold the Scan button.

The red scan line turns on to assist in aiming. Ensure that the scan line crosses every bar and space of the barcode.

The Scan LEDs light green and a beep sounds, by default, to indicate the barcode was decoded successfully.

Figure 81 Linear Scanner Aiming Pattern



5. Release the scan button.
6. The captured data appears in the text field.

## Scanning with RS507/RS507X Hands-Free Imager

To read a barcode, a scan-enabled app is required. The device contains the DataWedge app that allows you to enable the scanner to decode barcode data and display the barcode content.

To scan with the RS507/RS507X:

1. Pair the RS507/RS507X with the device. See [Pairing Bluetooth Scanners](#) or [Pairing Using Bluetooth Human Interface Device](#) for more information.
2. Ensure that an app is open on the device and a text field is in focus (text cursor in text field).
3. Point the RS507/RS507X at a barcode.

Figure 82 Barcode Scanning with RS507/RS507X

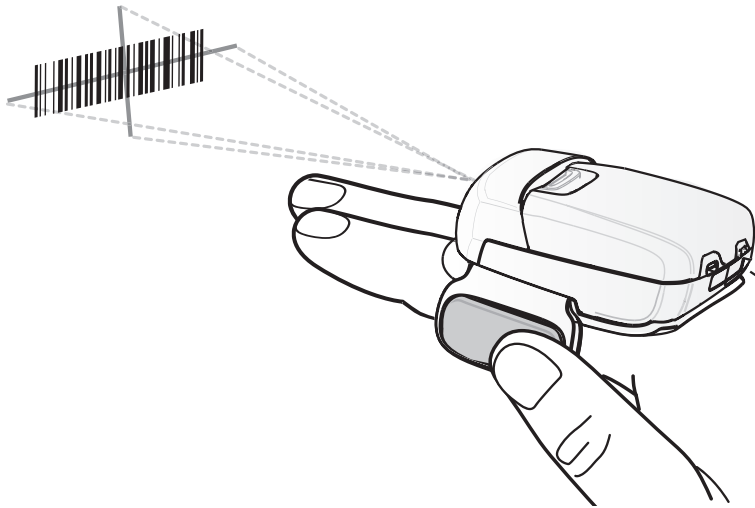

4. Press and hold the trigger.

The red laser aiming pattern turns on to assist in aiming. Ensure the barcode is within the area formed by the cross-hairs in the aiming pattern. The aiming dot increases visibility in bright lighting conditions.

The RS507/RS507X LEDs light green and a beep sounds to indicate the barcode was decoded successfully. When the RS507/RS507X is in Pick List mode, the RS507/RS507X does not decode the barcode until the center of the crosshair touches the barcode.

Figure 83 RS507/RS507X Aiming Pattern



Figure 84 RS507/RS507X Pick List Mode with Multiple Barcodes in Aiming Pattern



5. The captured data appears in the text field.



## Scanning with RS6000 Bluetooth Ring Scanner

To read a barcode, a scan-enabled app is required. Devices that contain the Zebra DataWedge app allows you to enable the scanner to decode barcode data and display the barcode content.

To scan with the RS6000:

1. Pair the RS6000 with the device. See Pairing Using Bluetooth Human Interface Device for more information.
2. Ensure that an app is open on the device and a text field is in focus (text cursor in text field).
3. Point the RS6000 at a barcode.

Figure 85 Barcode Scanning with RS6000

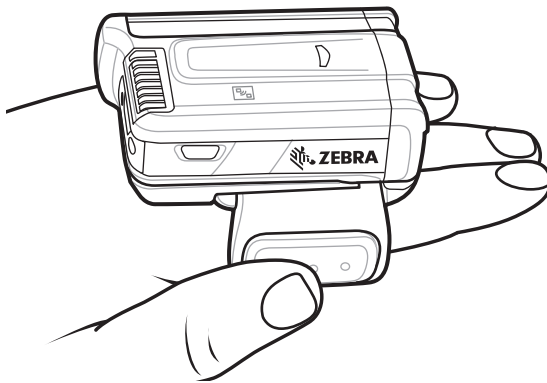

4. Press and hold the trigger.

The red laser aiming pattern turns on to assist in aiming. Ensure the barcode is within the area formed by the cross-hairs in the aiming pattern. The aiming dot increases visibility in bright lighting conditions.

The RS6000 LEDs light green and a beep sounds to indicate the barcode was decoded successfully. When the RS6000 is in Pick List mode, the RS6000 does not decode the barcode until the center of the crosshair touches the barcode.

Figure 86 RS6000 Aiming Pattern

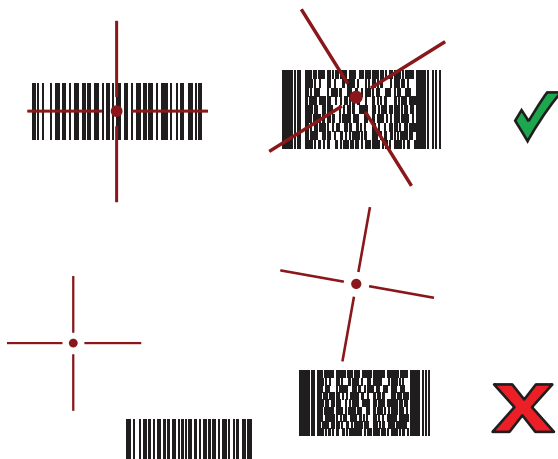

Figure 87 RS6000 Pick List Mode with Multiple Barcodes in Aiming Pattern



5. The captured data appears in the text field.

## Scanning with the DS3608 USB Scanner or DS3678 Bluetooth Scanner

To scan with the DS3608 or DS3678:

1. Pair the scanner with the device. For more information, see [Connecting a USB Scanner for the DS3608](#) or [Pairing Bluetooth Scanners for the DS3678](#).
2. Ensure that an app is open on the device and a text field is in focus (text cursor in text field).
3. Point the scanner at a barcode.

Figure 88 Barcode Scanning (DS3678 shown)

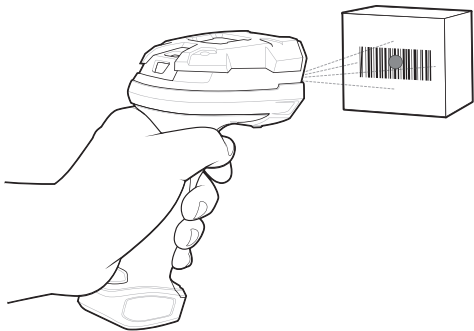

4. Press and hold the trigger.

Ensure the barcode is within the area formed by the aiming pattern. The aiming dot increases visibility in bright lighting conditions.

Figure 89 DS3608/DS3678 Aiming Pattern

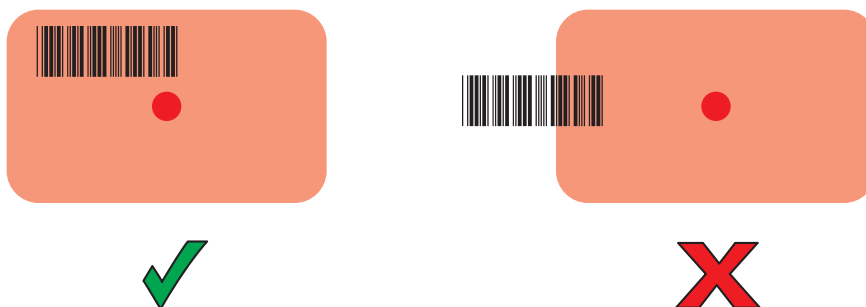
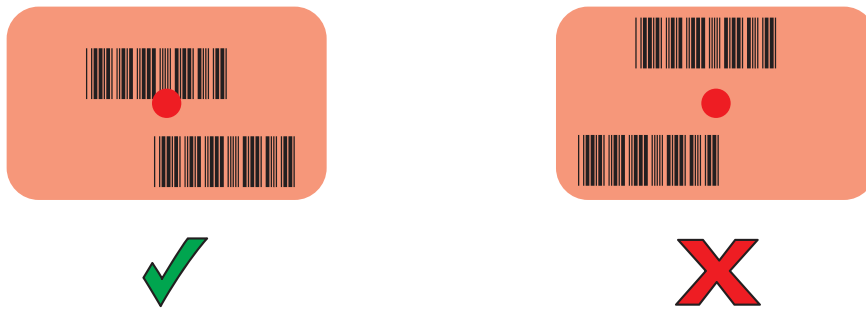

Figure 90 DS3608/DS3678 Pick List Mode with Multiple Barcodes in Aiming Pattern



5. The captured data appears in the text field.

## Pairing the RS507/RS507X/RS6000 Hands-Free Imager

To connect the RS507/RS507X or RS6000 imager to the device, use one of the following methods:

- Near Field Communication (NFC) (RS6000 only)
- Simple Serial Interface (SSI)
- Bluetooth Human Interface Device (HID) Mode.

## Pairing Using Near Field Communication



**NOTE:** NFC is supported on the premium configurations of the device.

The MC93XX provides the ability to pair the RS6000 using NFC.

1. Ensure that NFC is enabled on the MC93XX.
2. Align the NFC icon on the RS6000 with the NFC icon on the back of the MC93XX.

The Status LED blinks blue indicating that the RS6000 is attempting to establish connection with the MC93XX. When connection is established, the Status LED turns off and the RS6000 emits a single string of low/high beeps.

A notification appears on the MC93XX screen.

The  icon appears in the Status bar.

Figure 91 Align NFC Antennas

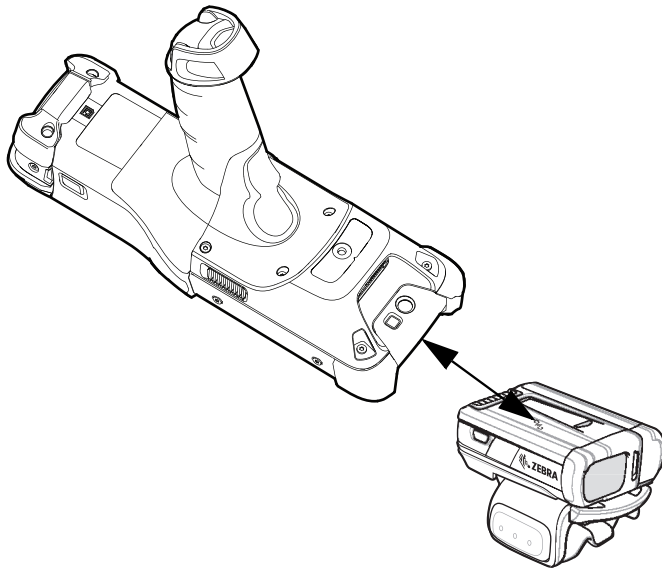

The MC93XX pairs with the RS6000 and  appears in the Status bar.



**NOTE:** Not all Zebra devices support NFC readers and the Tap-to-Pair feature.

## Pairing in HID Mode Using Near Field Communication

The MC93XX provides the ability to pair the RS6000 in HID Mode using NFC.



**NOTE:** NFC is supported on the premium and premium + configurations of the device and only with the RS6000.

1. Ensure that NFC is enabled on the MC93XX.
2. Ensure that Bluetooth is enabled on both devices.
3. Ensure that the Bluetooth device to discover is in discoverable mode.
4. Ensure that the two devices are within 10 meters (32.8 feet) of one another.
5. Place the RS6000 in Human Interface Device (HID) mode. If the RS6000 is already in HID mode, skip to step 6.
  - a. Remove the battery from the RS6000.
  - b. Press and hold the Restore key.
  - c. Install the battery onto the RS6000.
  - d. Keep holding the Restore key for about five seconds until a chirp is heard and the Scan LEDs flash green.
  - e. Scan the barcode below to place the RS6000 in HID mode.

Figure 92 Bluetooth HID Barcode



6. Remove the battery from the RS6000.
7. Re-install the battery into the RS6000.
8. Align the NFC icon on the RS6000 with the NFC icon on the MC93XX.

The Status LED blinks blue indicating that the RS6000 is attempting to establish connection with the MC93XX. When connection is established, the Status LED turns off and the RS6000 emits a single string of low/high beeps.

A notification appears on the MC93XX screen.



The  icon appears in the Status bar.

Figure 93 Align NFC Antennas



The MC93XX pairs with the RS6000 and  appears in the Status bar.

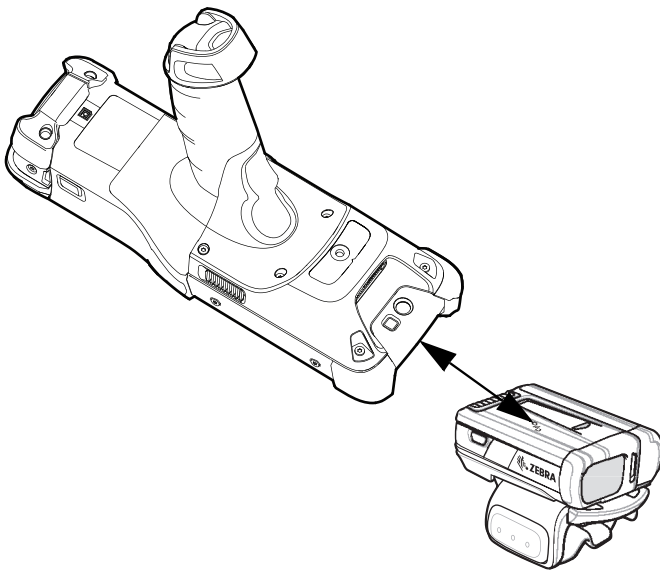

**NOTE:** Not all Zebra devices support NFC readers and the Tap-to-Pair feature.

## Pairing Using Simple Serial Interface (SSI)

To pair the RS507/RS507X or RS6000 with the device using SSI.

1. Swipe up from the bottom of the Home screen and touch .

Figure 94 Bluetooth Pairing Utility



2. Using the RS507/RS507X or RS6000, scan the barcode on the screen.

The RS507/RS507X or RS6000 emits a string of high/low/high/low beeps. The Scan LED flashes green indicating that the RS507/RS507X or RS6000 is attempting to establish connection with the device. When connection is established, the Scan LED turns off and the RS507/RS507X or RS6000 emits one string of low/high beeps.

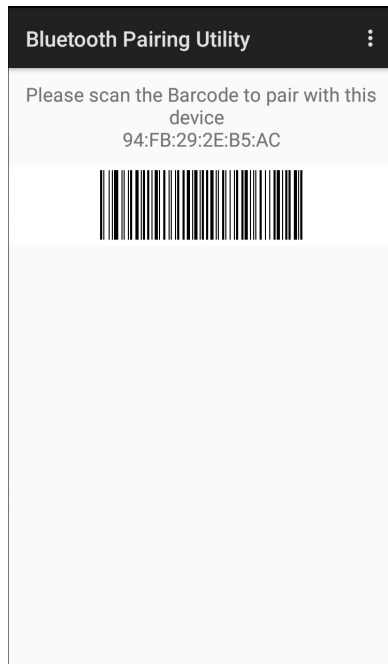
A notification appears on the Notification panel and the  icon appears in the Status bar.

## Pairing Using Bluetooth Human Interface Device

To pair the RS507/RS507X or RS6000 with the device using Human Interface Device (HID):

1. Ensure that Bluetooth is enabled on both devices.
2. Ensure that the Bluetooth device to discover is in discoverable mode.
3. Ensure that the two devices are within 10 meters (32.8 feet) of one another.
4. Place the RS507/RS507X or RS6000 in HID mode. If the RS507/RS507X or RS6000 is already in HID mode, skip to step 5.
  - a. Remove the battery from the RS507/RS507X or RS6000.
  - b. Press and hold the Restore key.
  - c. Install the battery onto the RS507/RS507X or RS6000.
  - d. Keep holding the Restore key for about five seconds until a chirp is heard and the Scan LEDs flash green.
  - e. Scan the barcode below to place the RS507/RS507X or RS6000 in HID mode.

Figure 95 RS507 Bluetooth HID Barcode



Figure 96 RS6000 Bluetooth HID Barcode

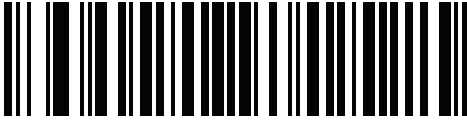

5. Remove the battery from the RS507/RS507X or RS6000.
6. Re-install the battery into the RS507/RS507X or RS6000.
7. Swipe down from the Status bar to open the Quick Access panel and then touch .
8. Touch **Bluetooth**.
9. Touch **Pair new device**. The device begins searching for discoverable Bluetooth devices in the area and displays them under **Available devices**.
10. Scroll through the list and select RS507/RS507X or RS6000.

The device connects to the RS507/RS507X or RS6000 and **Connected** appears below the device name. The Bluetooth device is added to the **Paired devices** list and a trusted (“paired”) connection is established.

A notification appears on Notification panel and the  icon appears in the Status bar.

## Pairing a Bluetooth Scanner

Connect the scanner to the device using one of the following methods:

- Simple Serial Interface (SSI) mode
- Bluetooth Human Interface Device (HID) mode.

## Pairing Using Bluetooth Human Interface Device

To pair the scanner with the device using HID:

1. Remove the battery from the scanner.
2. Replace the battery.
3. After the scanner reboots, scan the barcode below to place the scanner in HID mode.

Figure 97 Bluetooth HID Classic Barcode

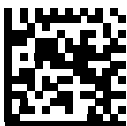

4. On the device, swipe down from the Status bar to open the Quick Access panel and then touch .

5. Touch **Bluetooth**.
6. Touch **Pair new device**. The device begins searching for discoverable Bluetooth devices in the area and displays them under **Available devices**.
7. Scroll through the list and select XXXXX xxxxxx, where XXXXX is the scanner and xxxxxx is the serial number.

The device connects to the scanner, the scanner beeps once and **Connected** appears below the device name. The Bluetooth device is added to the **Paired devices** list and a trusted (“paired”) connection is established.



## DataWedge

DataWedge is a utility that adds advanced barcode scanning capability to any application without writing code. It runs in the background and handles the interface to built-in barcode scanners. The captured barcode data is converted to keystrokes and sent to the target application as if it was copied and pasted, or typed on the keypad.



To configure DataWedge refer to the device Integrator Guide or Product Reference Guide.



## Enabling DataWedge

1. Swipe up from the bottom of the Home screen and touch .
2. Touch  > **Settings**.
3. Touch the **DataWedge enabled** checkbox. A blue checkmark appears in the checkbox indicating that DataWedge is enabled.
4. Touch .

## Disabling DataWedge

1. Swipe up from the bottom of the Home screen and touch .
2. Touch  > **Settings**.
3. Touch the **DataWedge enabled** checkbox. A blue checkmark disappears from the checkbox indicating that DataWedge is disabled.
4. Touch .

# Wireless

## Introduction

This section provides information on the wireless features:

- Wireless Local Area Network (WLAN)
- Bluetooth

## Wireless Local Area Networks

Wireless local area networks (WLANs) allow the device to communicate wirelessly inside a building. Before using the device on a WLAN, the facility must be set up with the required hardware to run the WLAN (sometimes known as infrastructure). The infrastructure and the device must both be properly configured to enable this communication.

Refer to the documentation provided with the infrastructure (access points (APs), access ports, switches, Radius servers, etc.) for instructions on how to set up the infrastructure.

Once the infrastructure is set up to enforce the chosen WLAN security scheme, use the **Wireless & networks** settings configure the device to match the security scheme.

The device supports the following WLAN security options:

- Open
- Wireless Equivalent Privacy (WEP)
- Wi-Fi Protected Access (WPA)/WPA2 Personal (PSK)
- Extensible Authentication Protocol (EAP).

The **Status** bar displays icons that indicate Wi-Fi network availability and Wi-Fi status.



**NOTE:** To extend the life of the battery, turn off Wi-Fi when not in use.

## Connecting to a Wi-Fi Network

To connect to a Wi-Fi network:

1. Swipe down from the Status bar to open the Quick Access panel.

Figure 98 Quick Access Panel

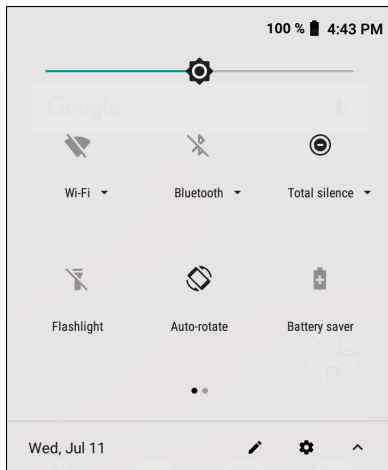

2. Touch **Wi-Fi** to open the **Wi-Fi** screen. The device searches for WLANs in the area and lists them.

Figure 99 Wi-Fi Screen

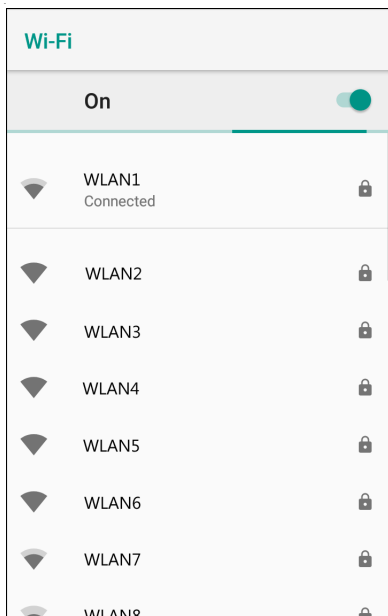



3. Scroll through the list and select the desired WLAN network.
4. For open networks, touch profile once or press and hold and then select **Connect to network** or for secure networks enter the required password or other credentials then touch **Connect**. See the system administrator for more information.

The device obtains a network address and other required information from the network using the dynamic host configuration protocol (DHCP) protocol. To configure the device with a fixed internet protocol (IP) address, Refer to the device Integrator Guide for more information.

5. In the Wi-Fi setting field, **Connected** appears indicating that the device is connected to the WLAN.

## Removing a Wi-Fi Network

To remove a remembered or connected network:

1. Swipe down from the status bar to open the quick access panel and then touch .
2. Touch **Network & Internet > W-Fi**.
3. Scroll down to the bottom of the list and touch **Saved networks**.
4. Touch the name of the network.
5. In the dialog box, touch **FORGET**.
6. Touch .

## Bluetooth

Bluetooth devices can communicate without wires, using frequency-hopping spread spectrum (FHSS) radio frequency (RF) to transmit and receive data in the 2.4 GHz Industry Scientific and Medical (ISM) band (802.15.1). Bluetooth wireless technology is specifically designed for short-range (10 m (32.8 ft)) communication and low power consumption.

Devices with Bluetooth capabilities can exchange information (for example, files, appointments, and tasks) with other Bluetooth enabled devices such as printers, access points, and other mobile devices.

The device supports Bluetooth Low Energy. Bluetooth Low Energy is targeted at applications in the healthcare, fitness, security, and home entertainment industries. It provides reduced power consumption and cost while maintaining standard Bluetooth range.

## Adaptive Frequency Hopping

Adaptive Frequency Hopping (AFH) is a method of avoiding fixed frequency interferers, and can be used with Bluetooth voice. All devices in the piconet (Bluetooth network) must be AFH-capable in order for AFH to work. There is no AFH when connecting and discovering devices. Avoid making Bluetooth connections and discoveries during critical 802.11b communications. AFH for Bluetooth consists of four main sections:

- Channel Classification - A method of detecting an interference on a channel-by-channel basis, or pre-defined channel mask.
- Link Management - Coordinates and distributes the AFH information to the rest of the Bluetooth network.
- Hop Sequence Modification - Avoids interference by selectively reducing the number of hopping channels.
- Channel Maintenance - A method for periodically re-evaluating the channels.

When AFH is enabled, the Bluetooth radio “hops around” (instead of through) the 802.11b high-rate channels. AFH coexistence allows enterprise devices to operate in any infrastructure.

The Bluetooth radio in this device operates as a Class 2 device power class. The maximum output power is 2.5 mW and the expected range is 10 m (32.8 ft). A definition of ranges based on power class is difficult to obtain due to power and device differences, and whether in open space or closed office space.



**NOTE:** It is not recommended to perform Bluetooth wireless technology inquiry when high rate 802.11b operation is required.

## Security

The current Bluetooth specification defines security at the link level. Application-level security is not specified. This allows application developers to define security mechanisms tailored to their specific need. Link-level security occurs between devices, not users, while application-level security can be implemented on a per-user basis. The Bluetooth specification defines security algorithms and procedures required to authenticate devices, and if needed, encrypt the data flowing on the link between the devices. Device authentication is a mandatory feature of Bluetooth while link encryption is optional.

Pairing of Bluetooth devices is accomplished by creating an initialization key used to authenticate the devices and create a link key for them. Entering a common personal identification number (PIN) in the devices being paired generates the initialization key. The PIN is never sent over the air. By default, the Bluetooth stack responds with no key when a key is requested (it is up to user to respond to the key request event). Authentication of Bluetooth devices is based-upon a challenge-response transaction. Bluetooth allows for a PIN or passkey used to create other 128-bit keys used for security and encryption. The encryption key is derived from the link key used to authenticate the pairing devices. Also worthy of note is the limited range and fast frequency hopping of the Bluetooth radios that makes long-distance eavesdropping difficult.

Recommendations are:

- Perform pairing in a secure environment
- Keep PIN codes private and do not store the PIN codes in the device
- Implement application-level security.

## Bluetooth Profiles

The device supports the Bluetooth services listed in the table below:

Table 12 Bluetooth Profiles

Profile	Description
Service Discovery Protocol (SDP)	Handles the search for known and specific services as well as general services.
Serial Port Profile (SPP)	Allows use of RFCOMM protocol to emulate serial cable connection between two Bluetooth peer devices. For example, connecting the device to a printer.
Object Push Profile (OPP)	Allows the device to push and pull objects to and from a push server.
Advanced Audio Distribution Profile (A2DP)	Allows the device to stream stereo-quality audio to a wireless headset or wireless stereo speakers.
Audio/Video Remote Control Profile (AVRCP)	Allows the device to control A/V equipment to which a user has access. It may be used in concert with A2DP.
Personal Area Network (PAN)	Allows the use of Bluetooth Network Encapsulation Protocol to provide L3 networking capabilities over a Bluetooth link. Only PANU role is supported.
Human Interface Device Profile (HID)	Allows Bluetooth keyboards, pointing devices, gaming devices and remote monitoring devices to connect to the device.
Headset Profile (HSP)	Allows a hands-free device, such as a Bluetooth headset, to place and receive calls on the device.
Hands-Free Profile (HFP)	Allows car hands-free kits to communicate with the device in the car.

Table 12 Bluetooth Profiles (Continued)

Profile	Description
Phone Book Access Profile (PBAP)	Allows exchange of Phone Book Objects between a car kit and a mobile device to allow the car kit to display the name of the incoming caller; allow the car kit to download the phone book so you can initiate a call from the car display.
Out of Band (OOB)	Allows exchange of information used in the pairing process. Pairing is completed using the Bluetooth radio, but requires information from the OOB mechanism. Using OOB with NFC enables pairing when devices simply get close, rather than requiring a lengthy discovery process.
Symbol Serial Interface (SSI)	Allows for communication with Bluetooth Imager.
Generic Attribute Profile (GATT)	Provides profile discovery and description services for Bluetooth Low Energy protocol. It defines how attributes are grouped together into sets to form services.
Dial Up Networking (DUN)	Provides a standard to access the Internet and other dial-up services over Bluetooth.
Generic Access Profile (GAP)	Use for device discovery and authentication.
OBject EXchange (OBEX)	Facilitates the exchange of binary objects between devices.

## Bluetooth Power States

The Bluetooth radio is off by default:

- Suspend - When the device goes into suspend mode, the Bluetooth radio stays on.
- Airplane Mode - When the device is placed in Airplane Mode, the Bluetooth radio turns off. When Airplane mode is disabled, the Bluetooth radio returns to the prior state. When in Airplane Mode, the Bluetooth radio can be turned back on if desired.

## Bluetooth Radio Power



Turn off the Bluetooth radio to save power or if entering an area with radio restrictions (for example, an airplane). When the radio is off, other Bluetooth devices cannot see or connect to the device. Turn on the Bluetooth radio to exchange information with other Bluetooth devices (within range). Communicate only with Bluetooth radios in close proximity.



**NOTE:** To achieve the best battery life, turn off radios when not in use.



### Enabling Bluetooth

To enable Bluetooth:

1. Swipe down from the Status bar to open the Quick Access panel.
2. Touch  to turn Bluetooth on.
3. Touch .

## Disabling Bluetooth

To disable Bluetooth:

1. Swipe down from the Status bar to open the Quick Access panel.
2. Touch  to turn Bluetooth off.
3. Touch .



## Discovering Bluetooth Device(s)

The device can receive information from discovered devices without pairing. However, once paired, the device and a paired device exchange information automatically when the Bluetooth radio is on. To find Bluetooth devices in the area:

1. Ensure that Bluetooth is enabled on both devices.
2. Ensure that the Bluetooth device to discover is in discoverable mode.
3. Ensure that the two devices are within 10 meters (32.8 feet) of one another.
4. Swipe down from the Status bar to open the Quick Access panel.
5. Touch **Bluetooth**.
6. Touch **MORE SETTINGS**. The **Bluetooth** screen appears.
7. Touch **Pair new device**. The device begins searching for discoverable Bluetooth devices in the area and displays them under **Available devices**.
8. Scroll through the list and select a device. The Bluetooth pairing request dialog box appears.
9. Touch **Pair** on both devices.
10. The Bluetooth device is added to the **Paired devices** list and a trusted (“paired”) connection is established.

## Changing the Bluetooth Name

By default, the device has a generic Bluetooth name that is visible to other devices when connected.

1. Swipe down from the Status bar to open the Quick Access panel and then touch .
2. Touch **Connected devices > Bluetooth**.
3. If Bluetooth is not on, move the switch to turn Bluetooth on.
4. Touch **Device name**.
5. Enter a name and touch **RENAME**.
6. Touch .

## Connecting to a Bluetooth Device



Once paired, connect to a Bluetooth device.

1. Swipe down from the Status bar to open the Quick Access panel and then touch .
2. Touch **Connected device > Bluetooth**.

3. In the list, touch the unconnected Bluetooth device.  
When connected, **Connected** appears below the device name.



## Selecting Profiles on the Bluetooth Device

Some Bluetooth devices have multiple profiles. To select a profile:

1. Swipe down from the Status bar to open the Quick Access panel and then touch .
2. Touch **Connected Devices > Bluetooth**.
3. In the **Paired Devices** list, touch  next to the device name.
4. Turn on or off a profile to allow the device to use that profile.
5. Touch .

## Unpairing a Bluetooth Device

To unpair a Bluetooth device and erase all pairing information:

1. Swipe down from the Status bar to open the Quick Access panel and then touch .
2. Touch **Connected devices > Bluetooth**.
3. In the **Paired Devices** list, touch  next to the device name.
4. Touch **FORGET**.
5. Touch .

## Using a Bluetooth Headset

Use a Bluetooth headset for audio communication when using an audio-enabled app. Using the NFC (Tap to pair) option, you can easily connect to Bluetooth with a Zebra Headset (HS3100). See Bluetooth for more information on connecting a Bluetooth headset to the device. Set the volume appropriately before putting on the headset. When a Bluetooth headset is connected, the speakerphone is muted.

## Near Field Communications

NFC/HF RFID is a short-range wireless connectivity technology standard that enables secure transaction between a reader and a contactless smartcard. The technology is based on ISO/IEC 14443 type A and B (proximity), ISO/IEC 15693 (vicinity), and FeliCa standards, using the HF 13.56 MHz unlicensed band. The device supports the following operating modes:

- Reader mode
- Peer-to-Peer communication
- Card Emulation mode.

Using NFC, the device can:

- Read contactless cards such as contactless tickets, ID cards and ePassport.
- Read and write information to contactless cards such as SmartPosters and tickets, as well as devices with NFC interface such as vending machines.



- Read information from supported medical sensors.
- Pair with supported Bluetooth devices such as printers (ex. ZQ5x, ZD5x), ring scanners (ex. RS6000), and headsets (ex. HS3100).
- Exchange data with another NFC device.
- Emulate contactless card such as ticket or SmartPoster.

The device NFC antenna is positioned to read NFC cards from the top of the device while the device is being held.

### Reading NFC Cards

To read NFC cards:

1. Launch an NFC enabled application.
2. Hold device as shown.
3. Move the device close to the NFC card until it detects the card.
4. Hold the card steadily until the transaction is complete (usually indicated by the application).

Figure 100 Reading Cards



## Sharing Information Using NFC

You can beam content like a web page, contact cards, pictures, YouTube links or location information from your screen to another device by bringing the devices together back to back.

Make sure both devices are unlocked, support NFC, and have both NFC and Android Beam turned on.

1. Open a screen that contains a web page, video, photo or contact.
2. Move the front of the device toward the front of the other device.

Figure 101 Sharing Data Using NFC

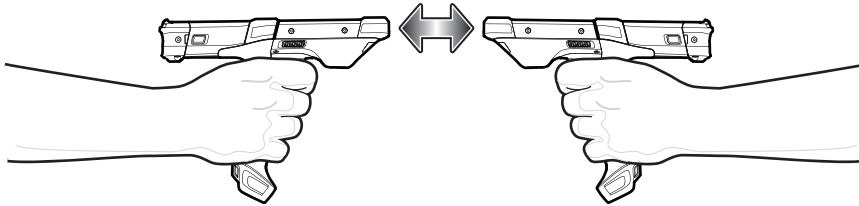



When the devices connect, a sound emits, the image on the screen reduces in size, the message **Touch to beam** displays.

3. Touch anywhere on the screen.  
The transfer begins.

## Cast

Use **Cast** to mirror the device screen on a Miracast enabled wireless display.

1. Swipe down from the Status bar to open the Quick Settings bar and then touch .
2. Touch **Connected Devices**.
3. Touch **Cast**.
4. Touch  > **Enable wireless display**. The device searches for nearby Miracast devices and lists them.
5. Touch a device to begin casting.
6. Touch .

# Accessories

## Introduction

This chapter provides information for using the accessories for the device.

## MC93XX Accessories

The table below lists the accessories available for the device.

Table 13 MC93XX Accessories

Accessory	Part Number	Description
<b>Cradles</b>		
1-Slot USB Charge Cradle with Spare Battery Charger	CRD-MC93-2SUCHG-01	Charges the MC93XX main battery and a spare battery, and synchronizes the MC93XX with a host computer through a USB connection. Requires power supply (PWR-BGA12V50W0WW), DC line cord (CBL-DC-388A1-01) and a country specific grounded AC line cord.
4-Slot Charge Only ShareCradle	CRD-MC93-4SCHG-01	Charges up to four MC93XXs. Requires power supply (PWR-BGA12V108W0WW), DC line cord (CBL-DC-381A1-01) and a country specific grounded AC line cord.
4-Slot Ethernet ShareCradle	CRD-MC93-4SETH-01	Charges up to four MC93XXs through the main battery and synchronizes the devices with a host computer through an Ethernet connection. Requires power supply (PWR-BGA12V108W0WW), DC line cord (CBL-DC-381A1-01) and a country specific grounded AC line cord.
<b>Chargers</b>		
4-Slot Spare Battery Charger	SAC-MC93-4SCHG-01	Charges up to four MC93XX spare batteries. Requires power supply (PWR-BGA12V50W0WW), DC line cord (CBL-DC-388A1-01) and a country specific grounded AC line cord.

## Accessories

Table 13 MC93XX Accessories (Continued)

Accessory	Part Number	Description
16-Slot Spare Battery Charger	SAC-MC93-16SCHG-01	Charges up to 16 MC93XX spare batteries. Requires power supply (PWR-BGA12V108W0WW), DC line cord (CBL-DC-381A1-01) and a country specific grounded AC line cord.
Power Supply	PWR-BGA12V50W0WW	Provides 12 VDC, 4.16A power to the 1-Slot USB Charge Cradle and the 4-Slot Spare Battery Charger. Requires a DC line cord (CBL-DC-388A1-01) and a country specific grounded AC line cord.
Power Supply	PWR-BGA12V108W0WW	Provides 12 VDC, 9A power to the 4-Slot Charge Cradle with 4-Slot Battery Charger, and 16-Slot Battery Charger. Requires a DC line cord (CBL-DC-381A1-01) and a country specific grounded AC line cord.
Power Supply	PWR-WUA5V12W0US	Provides 5 VDC, 2.5A power to the USB Charge Cable. Includes plug adapter for use in the United States.
Power Supply	PWR-WUA5V12W0GB	Provides 5 VDC, 2.5A power to the USB Charge Cable. Includes plug adapter for use in the European Union.
Power Supply	PWR-WUA5V12W0EU	Provides 5 VDC, 2.5A power to the USB Charge Cable. Includes plug adapter for use in the United Kingdom.
Power Supply	PWR-WUA5V12W0AU	Provides 5 VDC, 2.5A power to the USB Charge Cable. Includes plug adapter for use in Australia.
Power Supply	PWR-WUA5V12W0CN	Provides 5 VDC, 2.5A power to the USB Charge Cable. Includes plug adapter for use in China.
Power Supply	PWR-WUA5V12W0IN	Provides 5 VDC, 2.5A power to the USB Charge Cable. Includes plug adapter for use in India.
US AC Line Cord	23844-00-00R	Provides power to 3-wire power supplies PWR-BGA12V50W0WW and PWR-BGA12V108W0WW.
DC Line Cord	CBL-DC-381A1-01	Provides power from the power supply (PWR-BGA12V108W0WW) to the 4-Slot Charge Only Cradle, 4-Slot Ethernet Cradle, and 16-Slot Battery Charger.
DC Line Cord	CBL-DC-388A1-01	Provides power from the power supply (PWR-BGA12V150W0WW) to the 1-Slot USB Charge Cradle and 4-Slot Battery Charger.

## Accessories

Table 13 MC93XX Accessories (Continued)

Accessory	Part Number	Description
<b>Cables</b>		
USB Charge/Com Snap-On Cup  <b>NOTE:</b> A separate USB cable and power supply is required to support fast charging. USB (Type-C) Cable is required to allow communication from the snap-on to the PC/laptop.	CBL-MC93-USBCHG-01	Provides power and/or communication over USB to the device. Requires wall adapter/power supply PWR-WUA5V12W0xx.
1-Slot Cradle USB Cable	CBL-TC2X-USBC-01	Provides USB communication through the 1-Slot USB cradle to the host computer.
<b>Miscellaneous</b>		
Cradle Adapter	ADP-MC93-CRDCUP-01	MC93XX Charge Only Adapter for backwards compatibility with MC9XX cradles. Works with MC9XX 1-Slot USB Cradle, and 4-Slot Charge Only Cradle.
7000mAh PowerPrecision+ standard battery	BTRY-MC93-STN-01	Replacement standard battery.
	BTRY-MC93-STN-10	Replacement standard battery (10-pack).
	BTRY-MC93-STN-IN	Replacement standard battery (India).
5000mAh PowerPrecision+ freezer battery	BTRY-MC93-FRZ-01	Replacement freezer battery.
	BTRY-MC93-FRZ-10	Replacement freezer battery (10-pack).
7000mAh PowerPrecision+ non-incendive battery	BTRY-MC93-NI-01	Replacement non-incendive battery.
	BTRY-MC93-NI-10	Replacement non-incendive battery (10-pack).
MC93XX Hand Strap	SG-MC93-HDSTPG-01	Replacement hand strap for the MC93XX Hand strap loop holds an optional stylus (SG-TC7X-STYLUS-03).
MC93 Soft Holster for Gun	SG-MC9X-SHLSTG-01	Provides a soft, clip on holster and a shoulder strap for the MC93XX.
MC93 Rubber Boot for Gun	SG-MC93-RBTG-01	Provides additional protection for wear and tear of the MC93XX.
Screen Protector	MISC-MC93-SCRN-01	Provides additional protection for display (5-pack).
Stylus and Tether	SG-TC7X-STYLUS-03	Conductive carbon-filled stylus for capacitive touch panel; includes coiled tether (3-pack).
Un-powered Forklift Mount	MNT-MC93-FLCH-01	Un-powered forklift mount. Allows installing the device on a roll bar or square surface of a forklift. Includes:  Forklift holder (MNT-MC93-FLCH-01), RAM double socket arm for 1" ball (MNT-RAM-B201U), and RAM forklift clamp 2.5" max width square rail base with 1" ball (MNT-RAM-B247U25).

## Accessories

Table 13 MC93XX Accessories (Continued)

Accessory	Part Number	Description
34-key Numeric Keypad	KYPD-MC9334FNR-01	34-key Numeric Keypad
43-key Shifted Alpha Keypad	KYPD-MC9343FN-01	43-key Shifted Alpha Keypad
53-key 3270 Emulator Keypad	KYPD-MC93533270-01	53-key 3270 Emulator Keypad
53-key Keypad (Alpha-Numeric)	KYPD-MC93535250-01	53-key Keypad (Alpha-Numeric)
53-key 5250 Emulator Keypad	KYPD-MC9353ANR-01	53-key 5250 Emulator Keypad
53-key VT Emulator Keypad	KYPD-MC9353VT-01	53-key VT Emulator Keypad
58-Keys OmniiXT15f Keypad	KYPD-MC9358ANR-01	58-Keys OmniiXT15f Keypad
29-Keys Shifted Alpha Keypad	KYPD-MC9329NMR-01	29-Keys Shifted Alpha Keypad
34-key Numeric Keypad (10 Pack)	KYPD-MC9334FNR-10	34-key Numeric Keypad (10 Pack)  <b>NOTE:</b> The 10 pack order includes a keypad installation tool.
43-key Shifted Alpha Keypad (10 Pack)	KYPD-MC9343FN-10	43-key Shifted Alpha Keypad (10 Pack)  <b>NOTE:</b> The 10 pack order includes a keypad installation tool.
53-key 5250 Emulator Keypad (10 Pack)	KYPD-MC93535250-10	53-key 5250 Emulator Keypad (10 Pack)  <b>NOTE:</b> The 10 pack order includes a keypad installation tool.
53-key VT Emulator Keypad (10 Pack)	KYPD-MC9353VT-10	53-key VT Emulator Keypad (10 Pack)  <b>NOTE:</b> The 10 pack order includes a keypad installation tool.
53-key Keypad (Alpha-Numeric) (10 Pack)	KYPD-MC9353ANR-10	53-key Keypad (Alpha-Numeric) (10 Pack)  <b>NOTE:</b> The 10 pack order includes a keypad installation tool.
58-Keys OmniiXT15f Keypad	KYPD-MC9358ANR-10	58-Keys OmniiXT15f Keypad (10 Pack)  <b>NOTE:</b> The 10 pack order includes a keypad installation tool.
29-Keys Shifted Alpha Keypad	KYPD-MC9329NMR-10	29-Keys Shifted Alpha Keypad (10 Pack)  <b>NOTE:</b> The 10 pack order includes a keypad installation tool.

## 1-Slot USB Charge Cradle with Spare Battery Charger

The 1-Slot USB Charge Cradle with spare battery:

- Provides 9 VDC power to operate the mobile computer and charge the battery.
- Provides 4.2 VDC power to charge the spare battery.
- Provides a USB port for data communication between the mobile computer and a host computer or other USB devices, for example, a printer.
- Synchronizes information between the mobile computer and a host computer. With customized or third party software, it can also synchronize the mobile computer with corporate databases.
- Compatible with the following batteries:
  - 7000mAh PowerPrecision+ standard battery
  - 5000mAh PowerPrecision+ freezer battery
  - 7000mAh PowerPrecision+ non-incendive battery.

Figure 102 1-Slot USB Charge Cradle with Spare Battery Charger

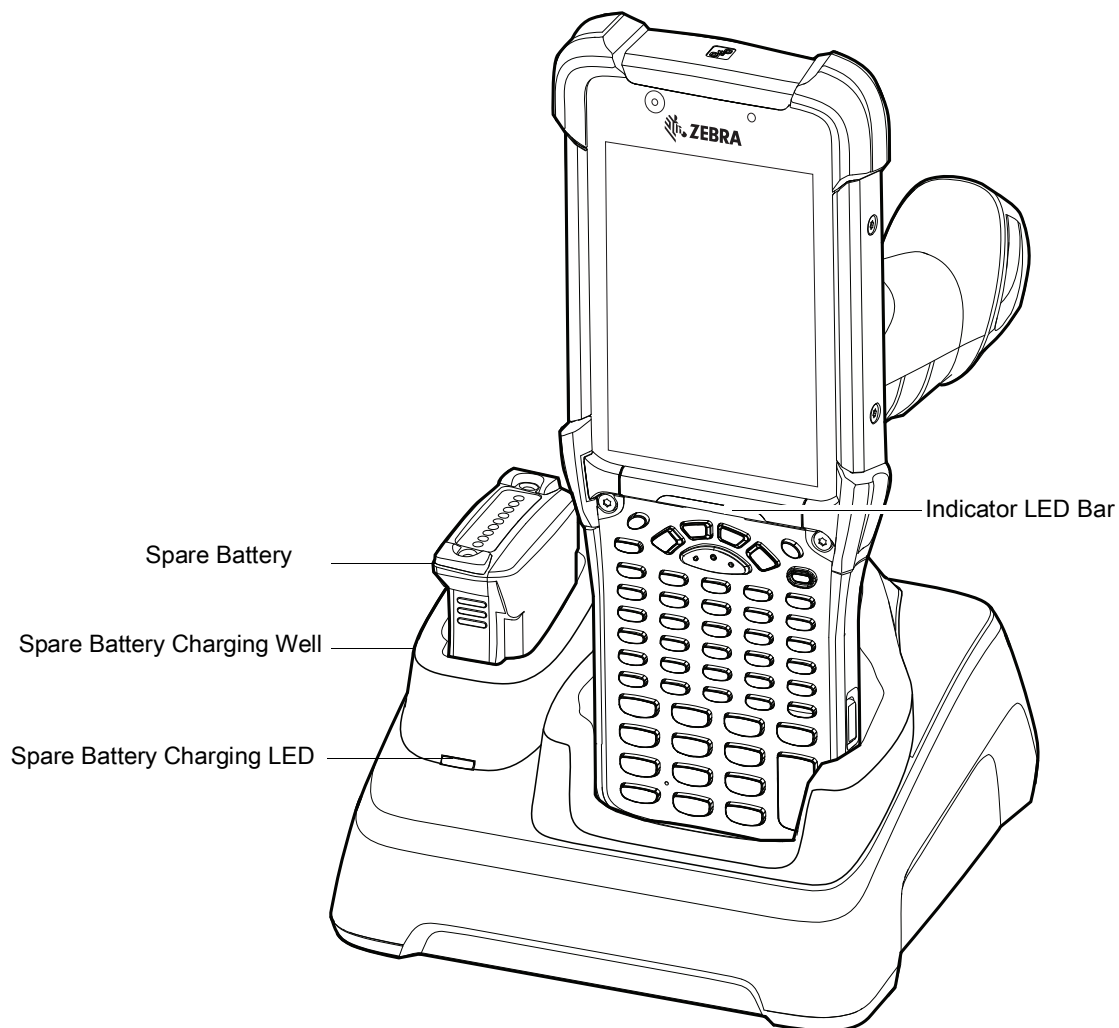

## Charging the Battery



**NOTE:** To function properly, remove the lower part of the rubber boot or the entire rubber boot before placing in a charging cradle.

1. Ensure that the cradle is connected to power.
2. Slide the device into the slot in the cradle. The devices Charge LED Indicator, indicates the battery charging status. For charging status, see LED Charging Indicators.

Figure 103 Device Battery Charging

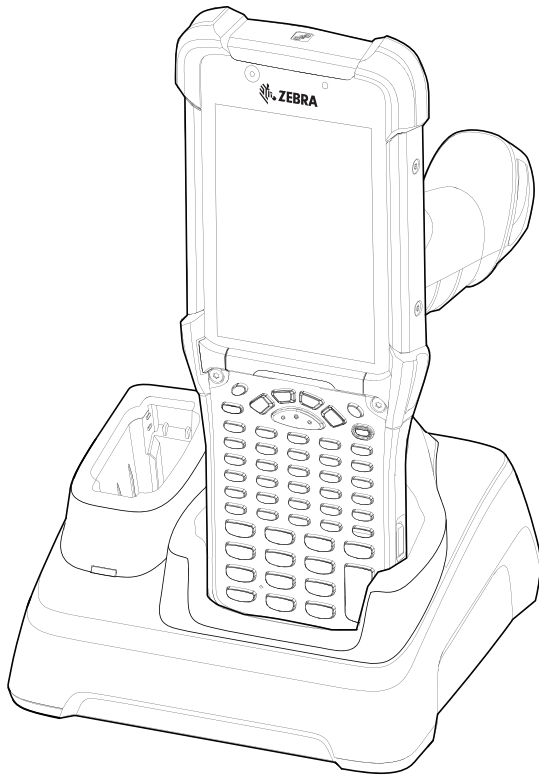

3. Gently press down on the device to ensure proper contact.
4. When charging is complete, remove the device from the cradle slot.

## Charging Temperature

Charge batteries in temperatures from 0°C to 40°C (32°F to 104°F). The device or cradle always performs battery charging in a safe and intelligent manner. At higher temperatures, for example at approximately +37°C (+98°F), the device or cradle may for small periods of time alternately enable and disable battery charging to keep the battery at acceptable temperatures. The device and cradle indicates when charging is disabled due to abnormal temperatures via its LED.



## 4-Slot Charge Only ShareCradle

The 4-Slot Charge Only ShareCradle:

- Provides 9 VDC power to operating the mobile computer and charge the battery.
- Simultaneously charges up to four mobile computers.
- Compatible with devices using the following batteries:
  - 7000mAh PowerPrecision+ standard battery
  - 5000mAh PowerPrecision+ freezer battery
  - 7000mAh PowerPrecision+ non-incendive battery.

Figure 104 4-Slot Charge Only ShareCradle

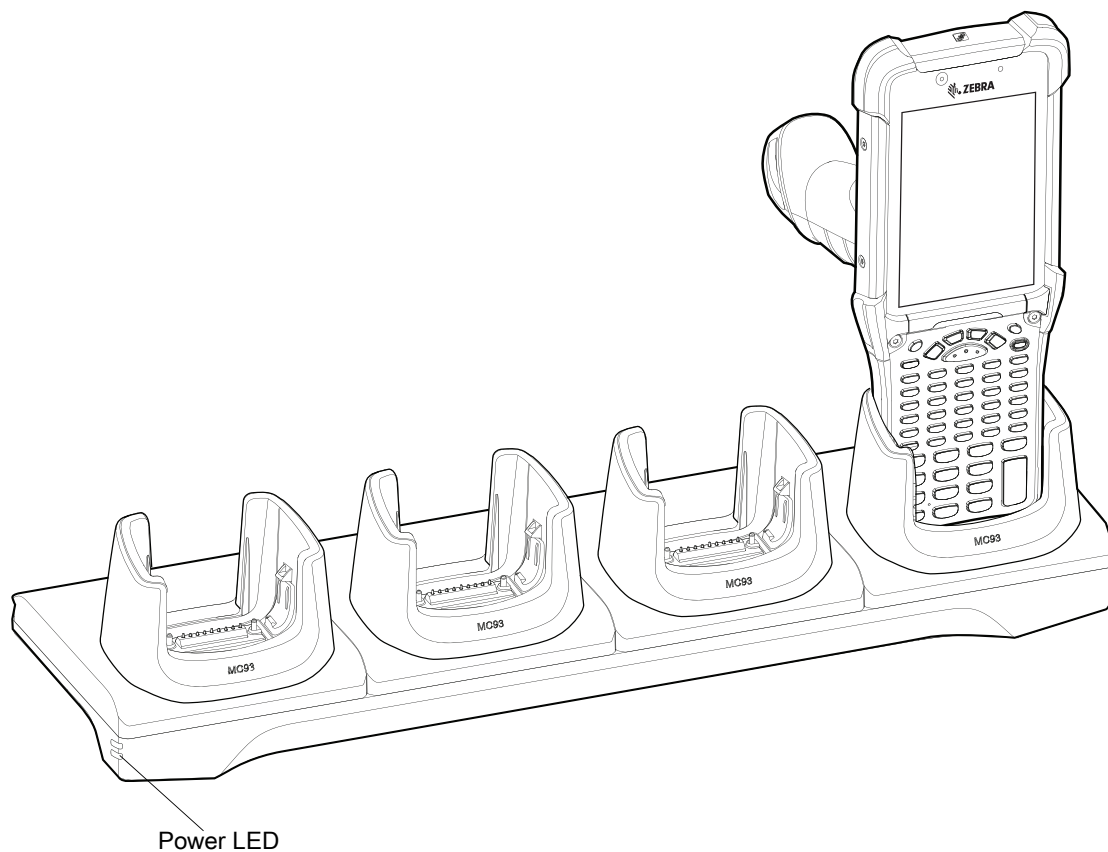

## Charging the Battery



**NOTE:** To function properly, remove the lower part of the rubber boot or the entire rubber boot before placing in a charging cradle.

1. Ensure that the cradle is connected to power.
2. Slide the mobile computer into the slot in the cradle. The mobile computer Charge LED Indicator, indicates the mobile computer battery charging status.

3. Gently press down on the device to ensure proper contact.
4. When charging is complete, remove the mobile computer from the cradle slot.

### **Battery Charging in the 4-Slot Charge Only ShareCradle**

The MC93XX's Charge LED indicates the status of the battery charging in the MC93XX. See LED Charge Indicators for charging status indications.

The 7000mAh PowerPrecision+ standard battery charges from 0% to 90% in less than 3.5 hours at room temperature using a Zebra accessory.

The 5000mAh PowerPrecision+ freezer battery charges from 0% to 90% in less than 2.5 hours at room temperature using a Zebra accessory.

The 7000mAh PowerPrecision+ non-incendive battery charges from 0% to 90% in less than 3.5 hours at room temperature using a Zebra accessory.

### **Charging Temperature**

Charge batteries in temperatures from 0°C to 40°C (32°F to 104°F). The device or cradle always performs battery charging in a safe and intelligent manner. At higher temperatures, for example at approximately +37°C (+98°F), the device or cradle may for small periods of time alternately enable and disable battery charging to keep the battery at acceptable temperatures. The device and cradle indicates when charging is disabled due to abnormal temperatures via its LED.

## 4-Slot Ethernet ShareCradle

The 4-Slot Ethernet ShareCradle:

- Provides 9 VDC power to operating the mobile computer and charge the battery.
- Simultaneously charges up to four mobile computers.
- Compatible with devices using the following batteries:
  - 7000mAh PowerPrecision+ standard battery
  - 5000mAh PowerPrecision+ freezer battery
  - 7000mAh PowerPrecision+ non-incendive battery.

Figure 105 4-Slot Ethernet ShareCradle

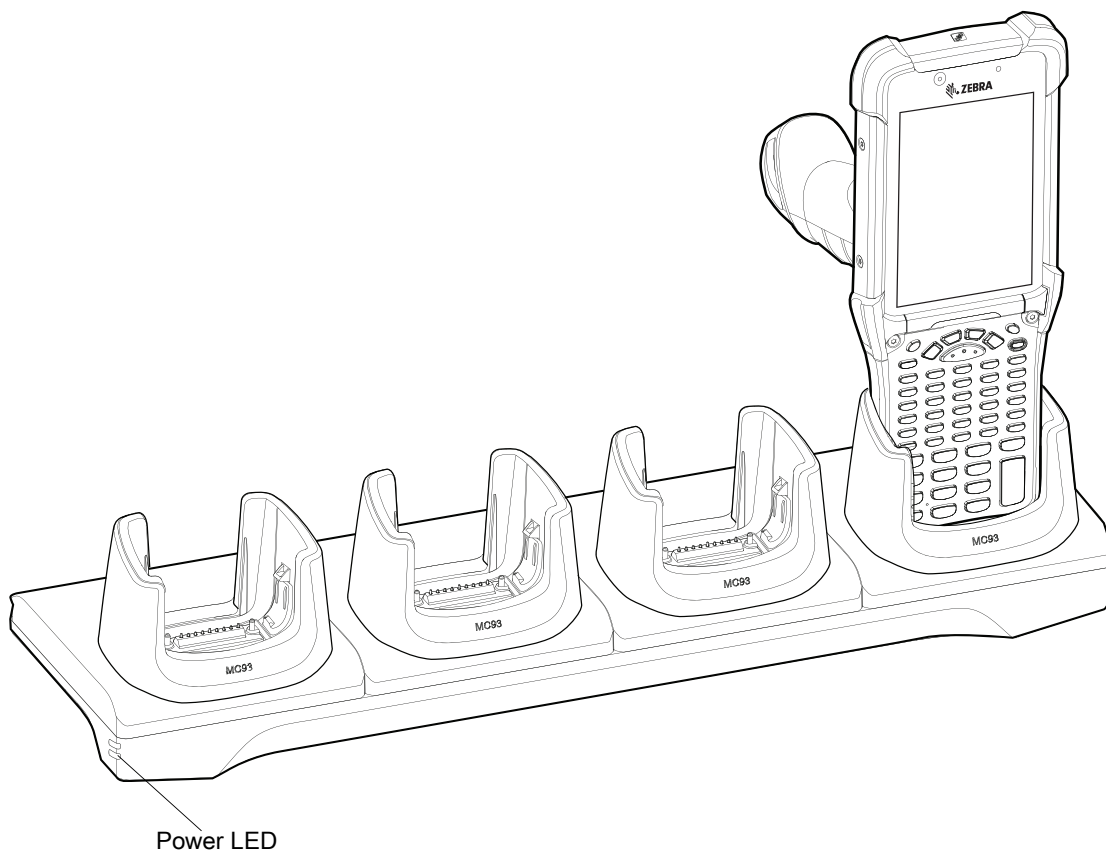

### Battery Charging in the 4-Slot Ethernet ShareCradle

The MC93XX's Charge LED indicates the status of the battery charging in the MC93XX. See LED Charge Indicators for charging status indications.

The 7000mAh PowerPrecision+ standard battery charges from 0% to 90% in less than 3.5 hours at room temperature using a Zebra accessory.

The 5000mAh PowerPrecision+ freezer battery charges from 0% to 90% in less than 2.5 hours at room temperature using a Zebra accessory.

The 7000mAh PowerPrecision+ non-incendive battery charges from 0% to 90% in less than 3.5 hours at room temperature using a Zebra accessory.

### **Charging Temperature**

Charge batteries in temperatures from 0°C to 40°C (32°F to 104°F). The device or cradle always performs battery charging in a safe and intelligent manner. At higher temperatures, for example at approximately +37°C (+98°F), the device or cradle may for small periods of time alternately enable and disable battery charging to keep the battery at acceptable temperatures. The device and cradle indicates when charging is disabled due to abnormal temperatures via its LED.

## 4-Slot Spare Battery Charger



**CAUTION:** Ensure that you follow the guidelines for battery safety described in Battery Safety Guidelines.

The 4-Slot Spare Battery Charger:

- Charges up to four spare batteries.
- Provides 4.2 VDC power to charge the spare battery.
- Compatible with the following batteries:
  - 7000mAh PowerPrecision+ standard battery
  - 5000mAh PowerPrecision+ freezer battery
  - 7000mAh PowerPrecision+ non-incendive battery.

Figure 106 4-Slot Spare Battery Charger

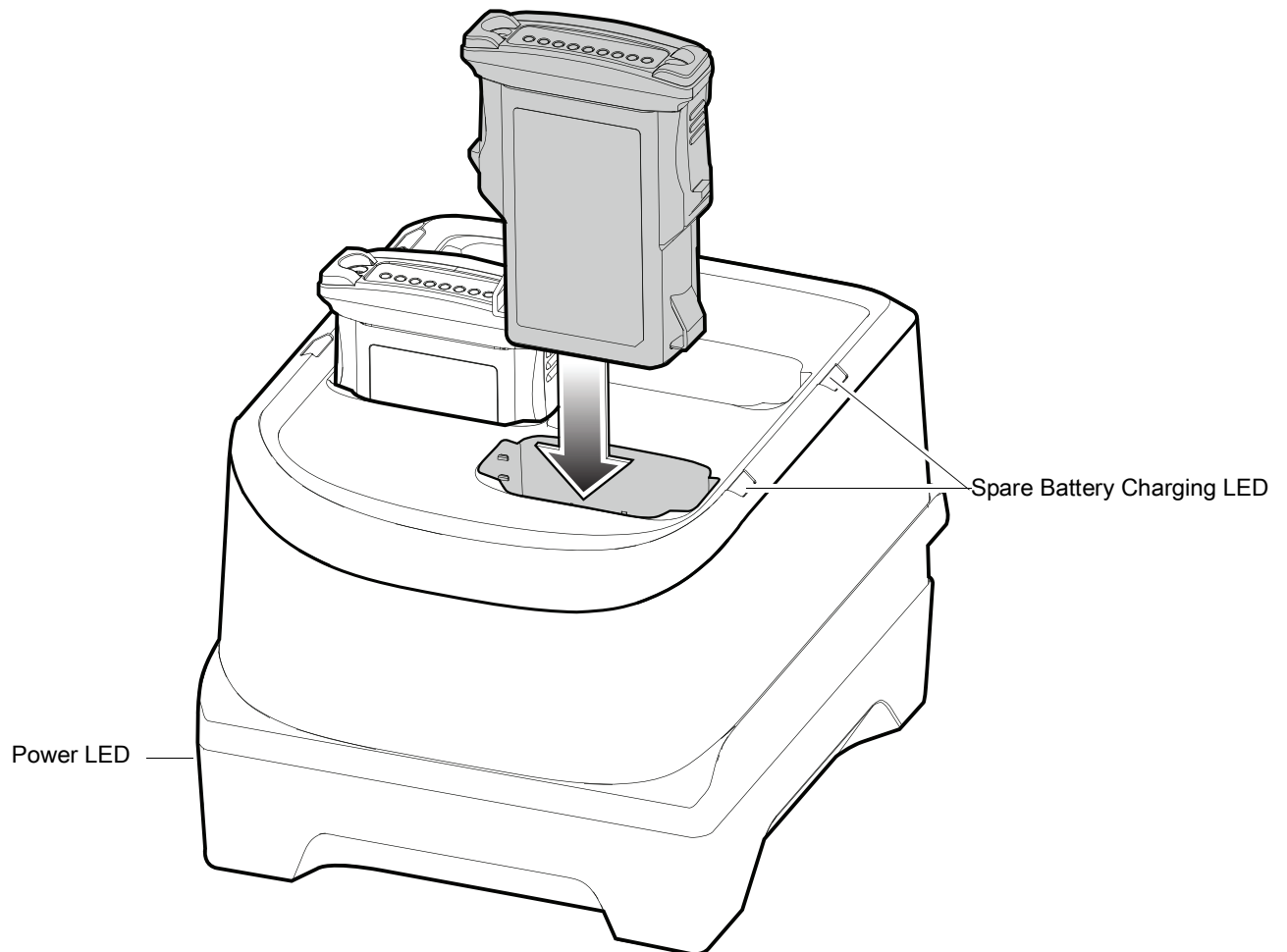

## 16-Slot Spare Battery Charger



**CAUTION:** Ensure that you follow the guidelines for battery safety described in Battery Safety Guidelines.

The 16-Slot Spare Battery Charger:

- Charges up to 16 spare batteries.
- Provides 4.2 VDC power to charge the spare battery.
- Compatible with the following batteries:
  - 7000mAh PowerPrecision+ standard battery
  - 5000mAh PowerPrecision+ freezer battery
  - 7000mAh PowerPrecision+ non-incendive battery.

Figure 107 16-Slot Spare Battery Charger

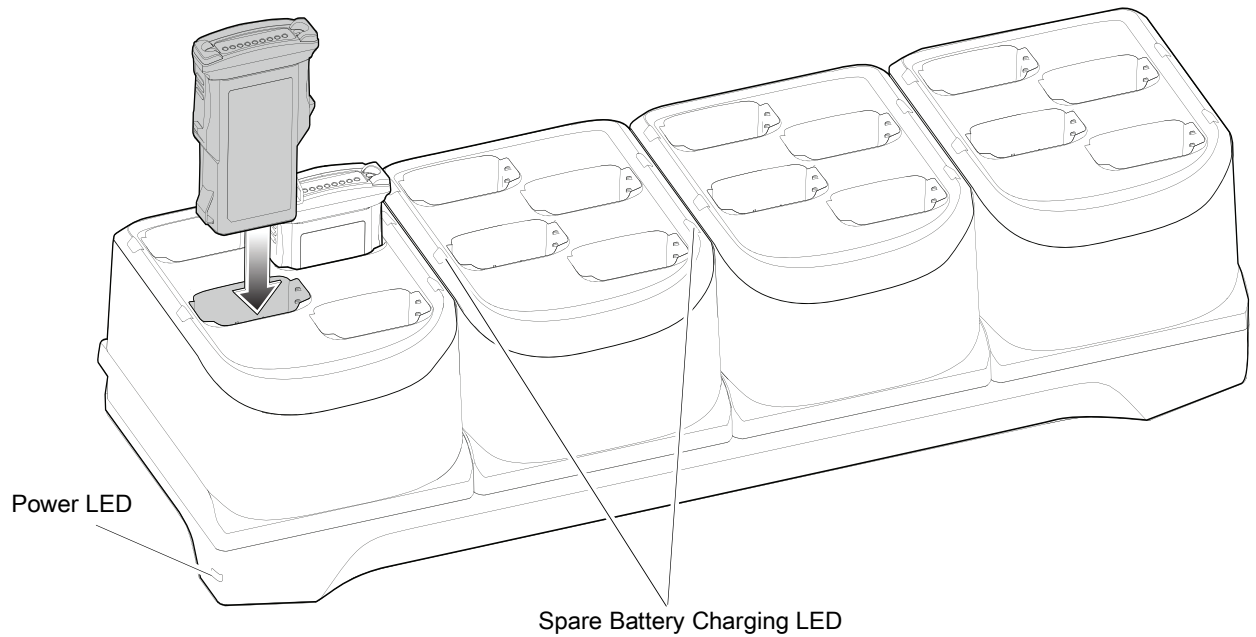

## USB Charge/Com Snap-on Cup

The USB Charge/Com Snap-on Cup:

- Provides 5 VDC power to operate the device and to charge the battery.
- Provides power and/or communication with the host computer over USB to the device.
- Compatible with devices using the following batteries:
  - 7000mAh PowerPrecision+ standard battery
  - 5000mAh PowerPrecision+ freezer battery
  - 7000mAh PowerPrecision+ non-incendive battery.

Figure 108 USB Charge/Com Snap-on Cup

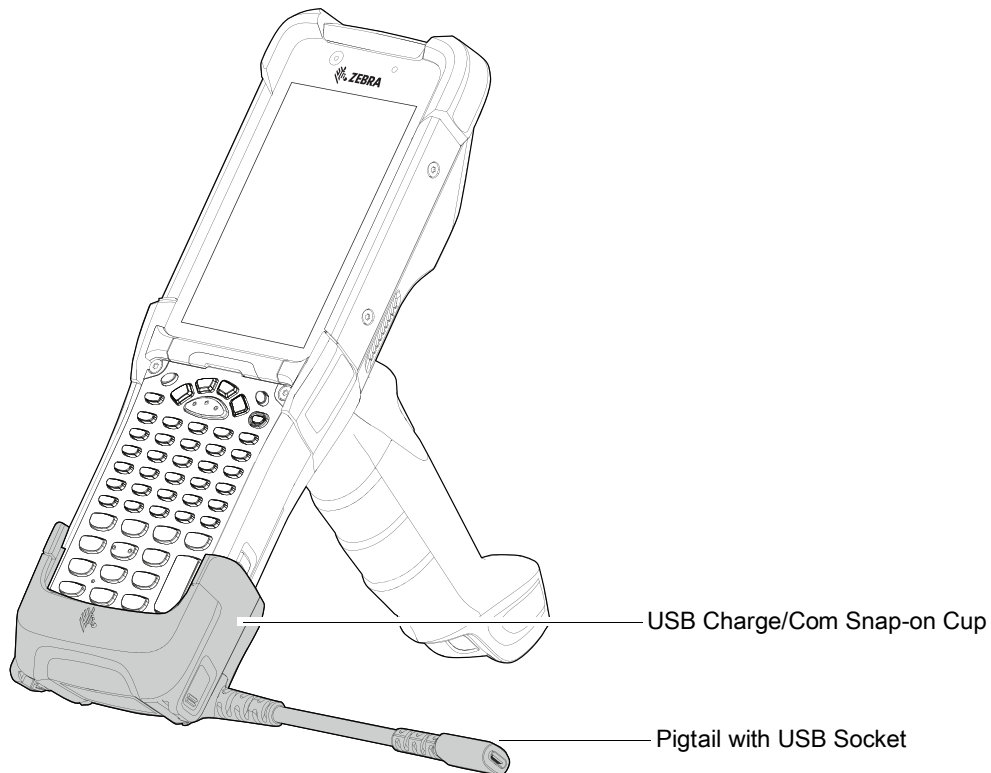

## Connecting the USB Charge Cable to Device



**NOTE:** To function properly, remove the lower part of the rubber boot or the entire rubber boot before placing in a charging cradle.

To connect the USB Charge Cable to the device, insert the USB Charge Cable straight onto the device until the device touches the bottom of the cable cup.

Figure 109 Connecting the USB Charge Cable

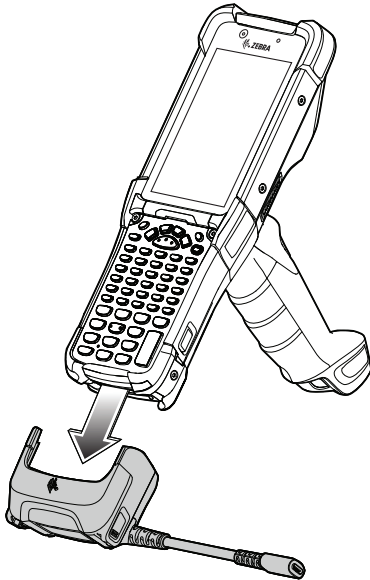

## Connecting the USB Charge/Com Snap-on Cup Cable to Host Computer

To connect the USB Charge/Com Snap-on Cup cable to a host computer:

1. Connect the USB Charge/Com Snap-on Cup to the device.
2. Connect the USB connector to a host computer.



Figure 110 Connecting USB Charge/Com Snap-on Cup to Host Computer

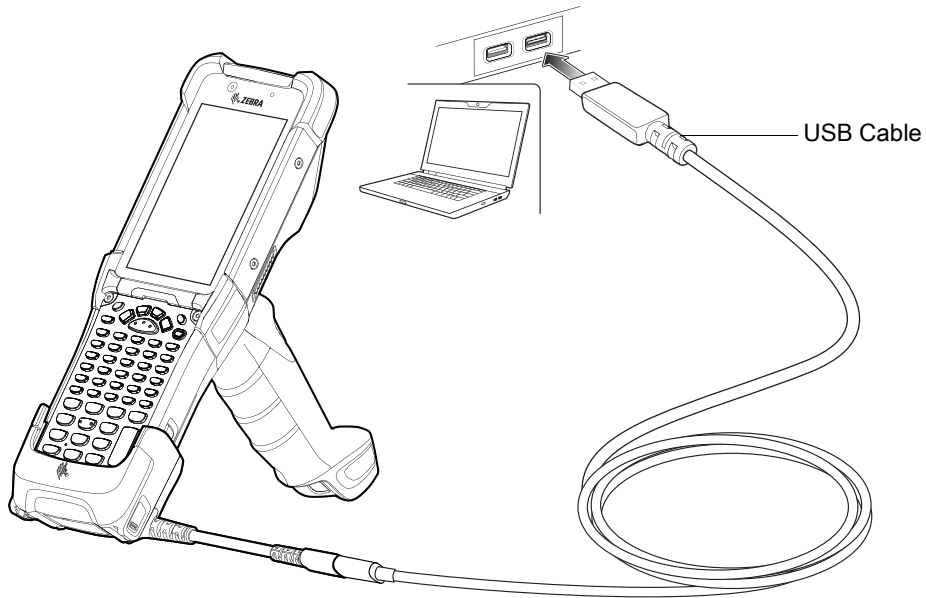

## Charging the Device

To charge the device using the USB Charge/Com Snap-on Cup:

1. Connect the USB Charge/Com Snap-on Cup to the device.
2. Connect the USB connector of the power supply.
3. Plug the power supply into a power outlet.

Figure 111 Charging the Device

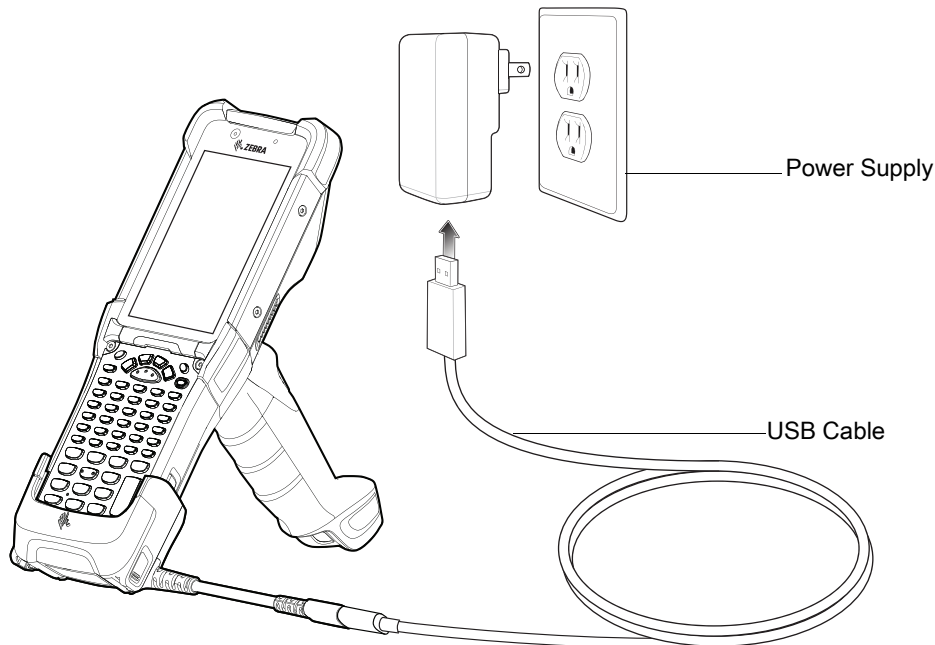

## Disconnecting the USB Charge/Com Snap-on Cup

To disconnect the USB Charge/Com Snap-on Cup from the device:

1. Depress the two latches on either side of the cup.
2. Pull the cup off the bottom of the device.

Figure 112 Disconnecting the USB Charge/Com Snap-on Cup

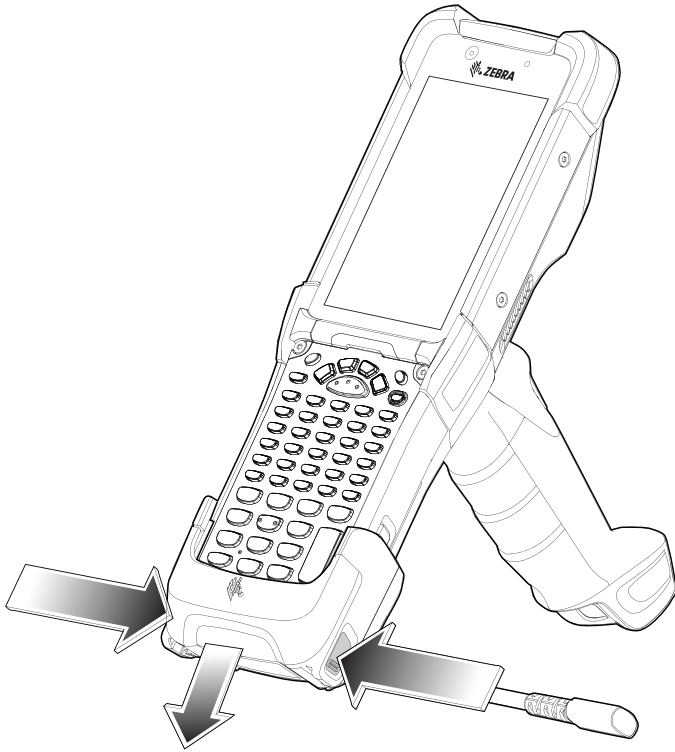

## MC93XX Charge Only Adapter

Use the Charge Only Adapter for backwards compatibility with the MC9XXX cradles and the MC93XX mobile computer.

- Charge Only Adapter supports terminal charging only for the MC9XXX 1-Slot Cradle and 4-Slot Cradle.
- Charge Only Adapter provides charge only and no communication when used with the MC9XXX cradles.

Figure 113 MC9X 1-Slot Cradle Charge Only Adapter

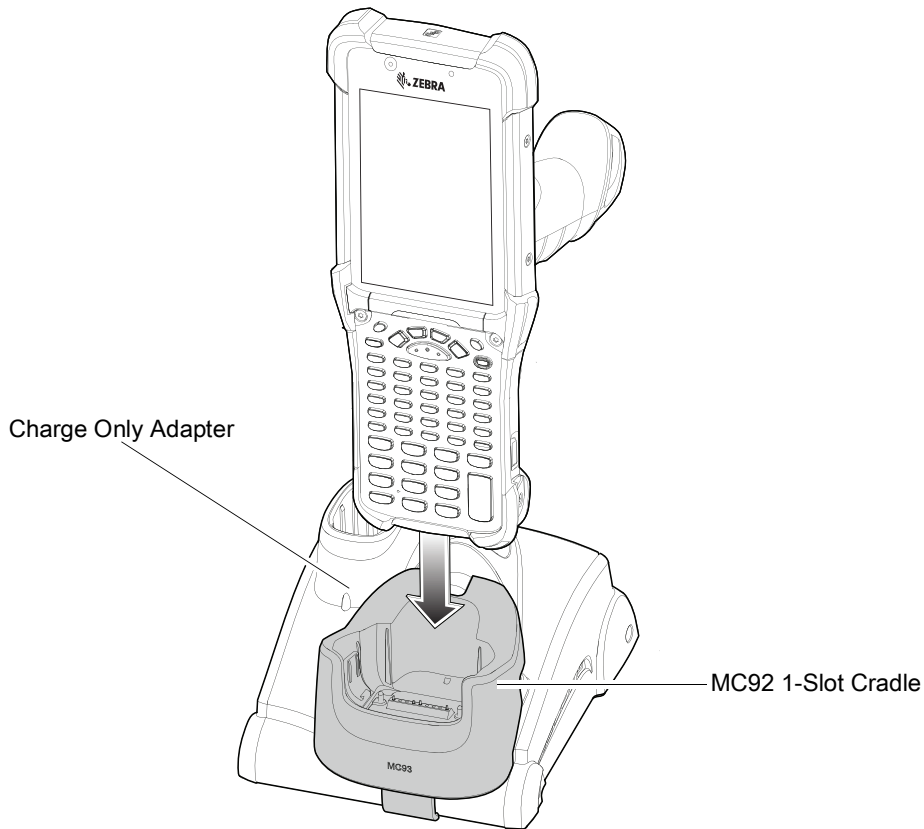
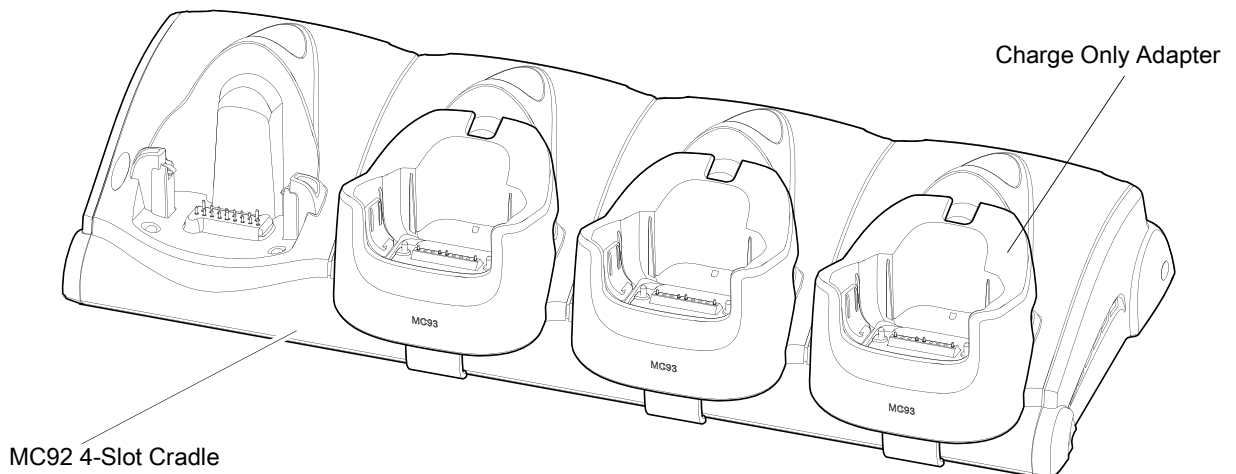

Figure 114 MC9X 4-Slot Cradle Charge Only Adapter



## Charge Only Adapter Installation

To install the Charge Only Adapter:

1. Clean the MC9XXX cradle and contacts surface as specified with an alcohol wipe, using a back and forth motion with your finger.  
For more information about cleaning, refer to the MC93XX Mobile Computer User Guide.

Figure 115 Clean MC9XXX Cradle Contacts and Surfaces

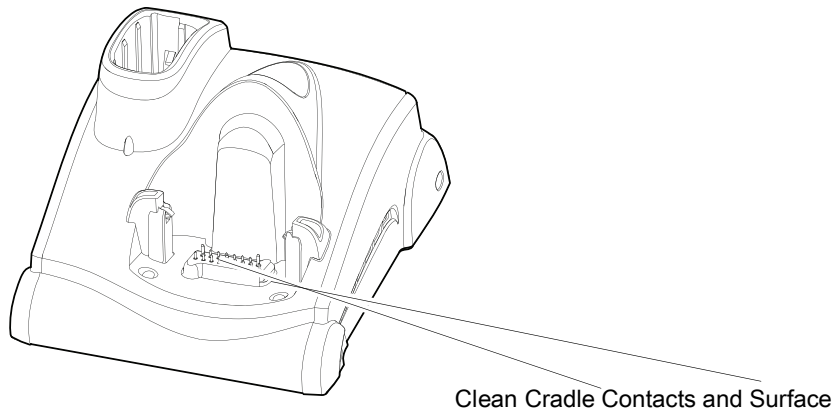

2. Peel and remove the adhesive from the back of the adapter.

Figure 116 Peel and Remove Adhesive

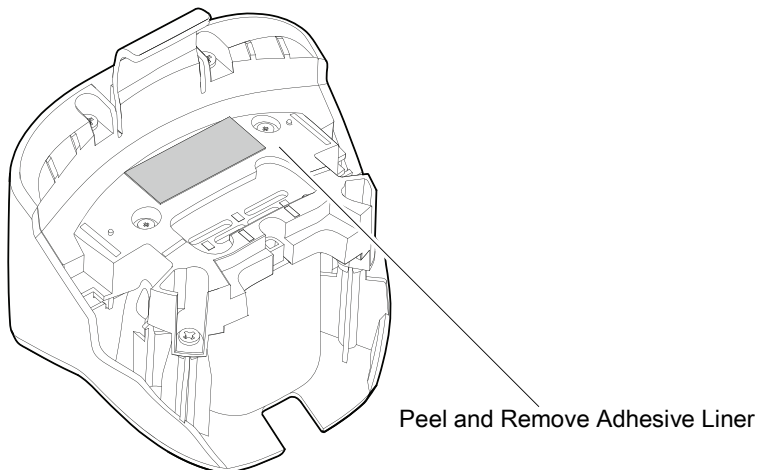

3. Insert the adapter into the MC9XXX cradle and adhere to the bottom of the cradle.

Figure 117 Insert Adapter into Cradle

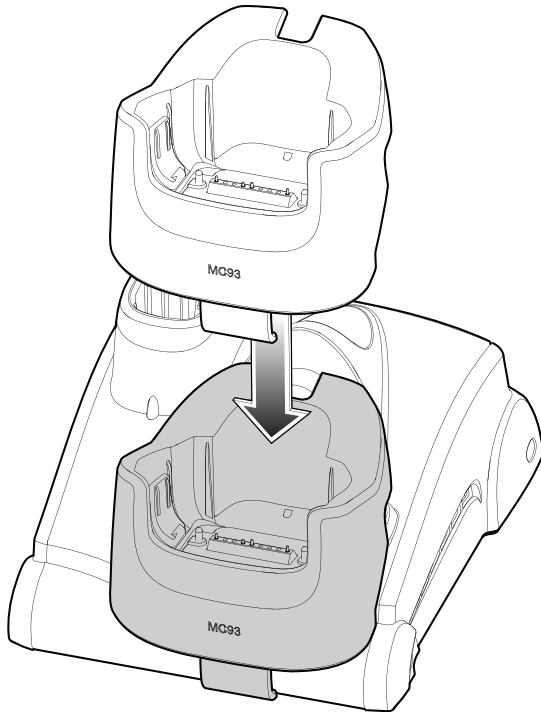

4. Insert the device into the cradle.

Figure 118 Insert Device into Cradle

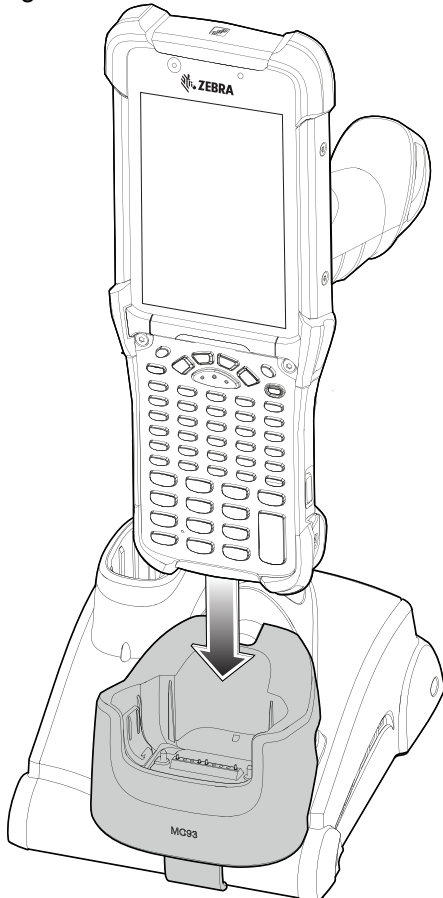

## Rubber Boot

To attach the rubber boot:

1. If using the rubber boot with a device with the SE965 laser scanner, retain the shim (default assembly). If using the rubber boot with a device with either the SE4750SR or the SE4850ER imager, you must snap-off the shim by pushing it through.

Figure 119 Remove the Shim

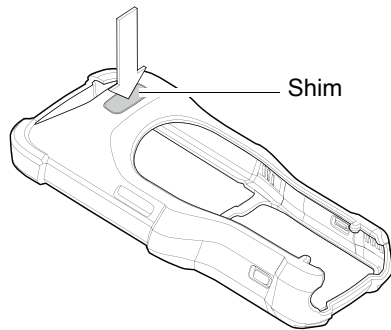

2. Slide the top of the device into the top of the rubber boot.

Figure 120 Slide the Rubber Boot

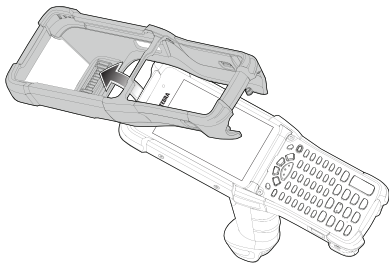

3. Grasp the bottom of the rubber boot and place over the bottom of the device.

Figure 121 Attach the Top of the Rubber Boot

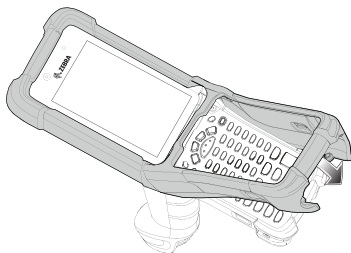

4. Turn the device over and ensure that the two alignment tabs completely fit into the two alignment slots on the device.

Figure 122 Align tabs

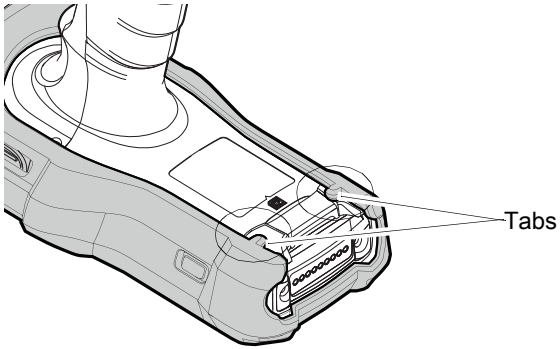

**NOTE:** To charge the device in a cradle, completely remove the rubber boot.



## Installing the Hand Strap

To install the hand strap:

1. Thread and pull-through the short section through the opening near the base of the trigger handle.

Figure 123 Insert Loop Through Handle Slot

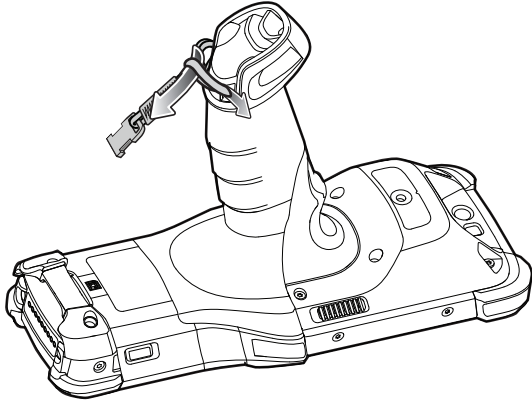

2. Thread and pull-through the longer section through the opening near the battery.

Figure 124 Pull-through Hand Strap Near Battery

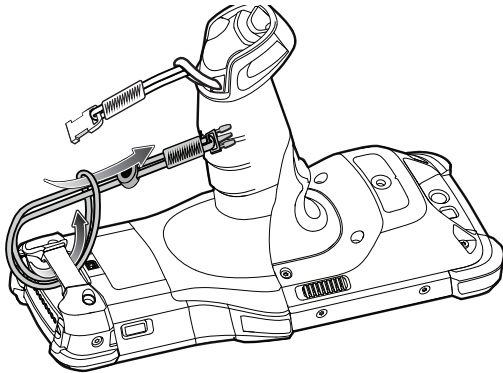

3. Attach the two plastic ends together.

Figure 125 Attach Plastic Ends Together

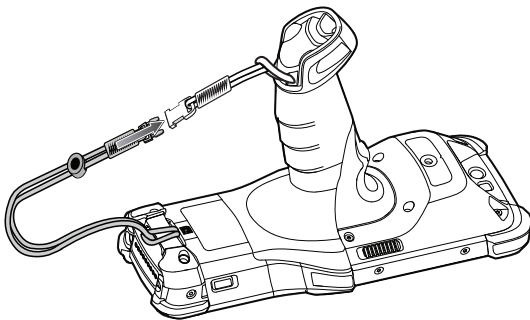

## Un-powered Forklift Mount

The Un-powered Forklift Mount on a forklift allows you to place the device in a holder. The forklift mount does not provide charging or communication to the device. Install the Forklift Mount on a square surface or roll bar of a forklift. The mount supports portrait (vertical) orientation only.

To install the MC93XX in an un-powered forklift mount holder:

1. Secure the RAM Clamp Base to the forklift mounting surface using two screws and nuts.
2. Attach the RAM Socket Arm to the RAM Clamp Base and the Forklift Mount Holder.
3. Turn the Socket Arm hand-screw clockwise until tight.

Figure 126 Insert Device into Forklift Mount Holder

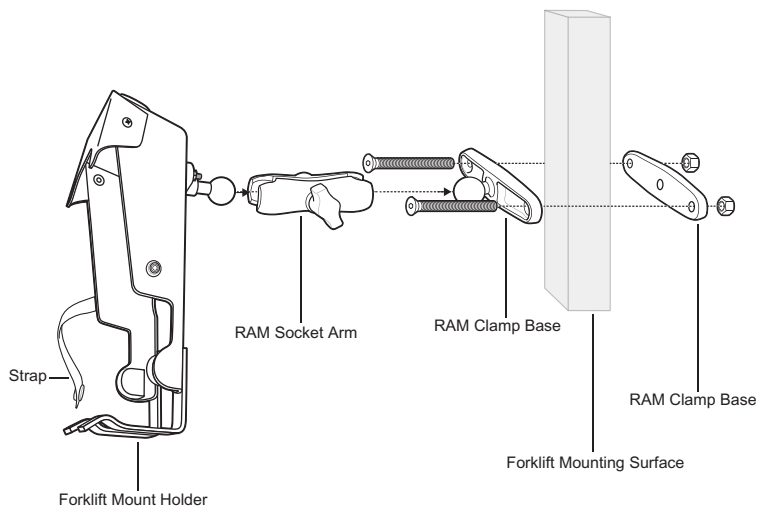

4. Insert the device into the Forklift Mount Holder at a 45° angle in one of two ways (shown below).
5. Rotate and snap the device into place.
6. If required, secure the device with the rubber strap, and snap it into place.

Figure 127 Insert Device into Forklift Mount Holder, Rotate and Snap (Option 1)

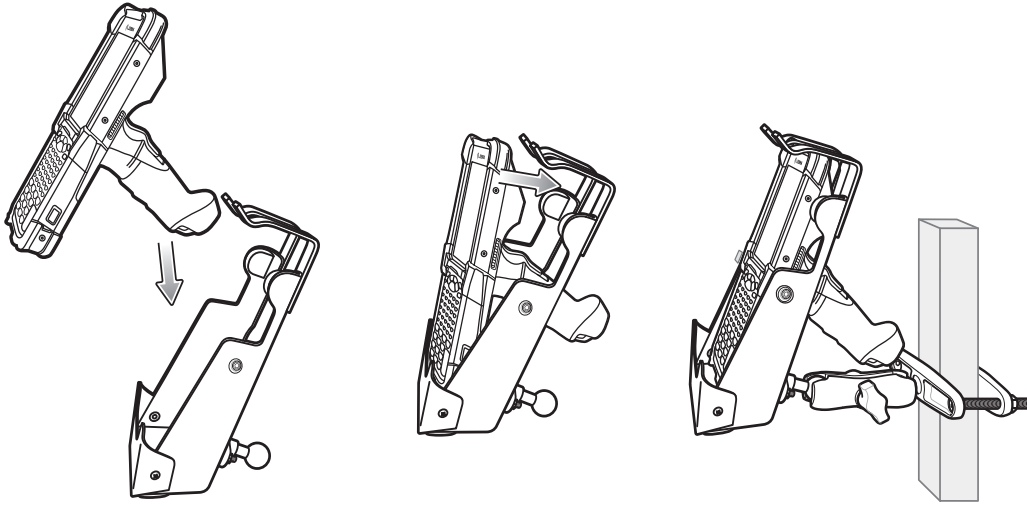
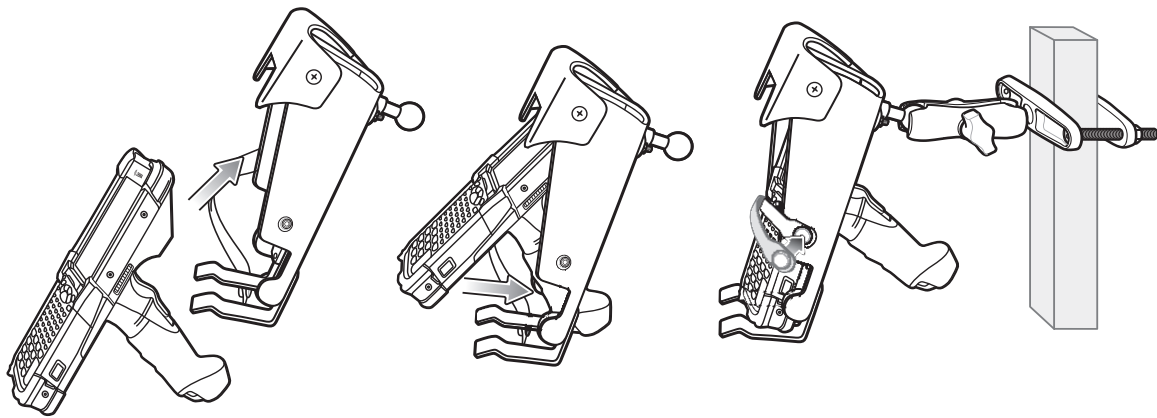

Figure 128 Insert Device into Forklift Mount Holder, Rotate and Snap (Option 2)



**NOTE:** Use strap in this orientation for added retention of the device.

# Maintenance and Troubleshooting

## Introduction

This chapter includes instructions on cleaning and storing the device, and provides troubleshooting solutions for potential problems during operation.

## Maintaining the Device

For trouble-free service, observe the following tips when using the device:

- To avoid scratching the screen, use a Zebra approved capacitive touch panel compatible stylus intended for use with a touch-sensitive screen. Never use an actual pen or pencil or other sharp object on the surface of the device screen.
- The touch-sensitive screen of the device is glass. Do not drop the device or subject it to strong impact.
- Protect the device from temperature extremes. Do not leave it on the dashboard of a car on a hot day, and keep it away from heat sources.
- Do not store the device in any location that is dusty, damp, or wet.
- Use a soft lens cloth to clean the device. If the surface of the device screen becomes soiled, clean it with a soft cloth moistened with an approved cleanser. For a list of approved cleansers, see Approved Cleanser Active Ingredients.
- Periodically replace the rechargeable battery to ensure maximum battery life and product performance. Battery life depends on individual usage patterns.

## Battery Safety Guidelines

- The area in which the units are charged should be clear of debris and combustible materials or chemicals. Particular care should be taken where the device is charged in a non commercial environment.
- Follow battery usage, storage, and charging guidelines found in this guide.
- Improper battery use may result in a fire, explosion, or other hazard.
- To charge the mobile device battery, the ambient battery and charger temperatures must be between +32°F and +104°F (0°C and +40°C).
- Do not use incompatible batteries and chargers, including non-Zebra batteries and chargers. Use of an incompatible battery or charger may present a risk of fire, explosion, leakage, or other hazard. If you have any questions about the compatibility of a battery or a charger, contact the Global Customer Support Center.
- For devices that utilize a USB port as a charging source, the device shall only be connected to products that bear the USB-IF logo or have completed the USB-IF compliance program.
- Do not disassemble or open, crush, bend or deform, puncture, or shred the battery.

- Severe impact from dropping any battery-operated device on a hard surface could cause the battery to overheat.
- Do not short circuit a battery or allow metallic or conductive objects to contact the battery terminals.
- Do not modify or remanufacture, attempt to insert foreign objects into the battery, immerse or expose to water or other liquids, or expose to fire, explosion, or other hazard.
- Do not leave or store the equipment in or near areas that might get very hot, such as in a parked vehicle or near a radiator or other heat source. Do not place battery into a microwave oven or dryer.
- Battery usage by children should be supervised.
- Please follow local regulations to properly dispose of used re-chargeable batteries.
- Do not dispose of batteries in fire.
- In the event of a battery leak, do not allow the liquid to come in contact with the skin or eyes. If contact has been made, wash the affected area with water for 15 minutes, and seek medical advice.
- If you suspect damage to your equipment or battery, contact Customer Support to arrange for inspection.

## Cleaning Instructions



**CAUTION:** Always wear eye protection.

Read warning label on alcohol product before using.

If you have to use any other solution for medical reasons please contact the Global Customer Support Center for more information.



**WARNING:** Avoid exposing this product to contact with hot oil or other flammable liquids. If such exposure occurs, unplug the device and clean the product immediately in accordance with these guidelines.

## Approved Cleanser Active Ingredients

100% of the active ingredients in any cleaner must consist of one or some combination of the following: isopropyl alcohol, bleach/sodium hypochlorite<sup>1</sup> (see important note below), or mild dish soap.



**IMPORTANT:** Use pre-moistened wipes and do not allow liquid cleaner to pool.

<sup>1</sup>When using sodium hypochlorite (bleach) based products, always follow the manufacturer's recommended instructions: use gloves during application and remove the residue afterwards with a damp alcohol cloth or a cotton swab to avoid prolonged skin contact while handling the device.

Due to the powerful oxidizing nature of sodium hypochlorite, the metal surfaces on the device are prone to oxidation (corrosion) when exposed to this chemical in the liquid form (including wipes). In the event that these type of disinfectants come in contact with metal on the device, prompt removal with an alcohol-dampened cloth or cotton swab after the cleaning step is critical.

## Harmful Ingredients

The following chemicals are known to damage the plastics on the device and should not come in contact with the device: acetone; ketones; ethers; aromatic and chlorinated hydrocarbons; aqueous or alcoholic alkaline solutions; ethanolamine; toluene; trichloroethylene; benzene; carbolic acid and TB-lysoform.

Many vinyl gloves contain phthalate additives, which are often not recommended for medical use and are known to be harmful to the housing of the device.

## Device Cleaning Instructions

Do not apply liquid directly to the device. Dampen a soft cloth or use pre-moistened wipes. Do not wrap the device in the cloth or wipe, instead gently wipe the unit. Be careful not to let liquid pool around the display window or other places. Before use, allow the unit to air dry.



**NOTE:** For thorough cleaning, it is recommended to first remove all accessory attachments, such as hand straps or cradle cups, from the mobile device and to clean them separately.

## Special Cleaning Notes

The device should not be handled while wearing vinyl gloves containing phthalates, or before hands are washed to remove contaminant residue after gloves are removed.

If products containing any of the harmful ingredients listed above are used prior to handling the device, such as hand sanitizer that contain ethanolamine, hands must be completely dry before handling the device to prevent damage to the device.



**IMPORTANT:** If the battery connectors are exposed to cleaning agents, thoroughly wipe off as much of the chemical as possible and clean with an alcohol wipe. It is also recommended to install the battery in the terminal prior to cleaning and disinfecting the device to help minimize buildup on the connectors.

When using cleaning/disinfectant agents on the device, it is important to follow the directions prescribed by the cleaning/disinfectant agent manufacturer.

## Cleaning Materials Required

- Alcohol wipes
- Lens tissue
- Cotton-tipped applicators
- Isopropyl alcohol
- Can of compressed air with a tube.

## Cleaning Frequency

The cleaning frequency is at the customer's discretion due to the varied environments in which the mobile devices are used and may be cleaned as frequently as required. When dirt is visible, it is recommended to clean the mobile device to avoid build up of particles which make the device more difficult to clean later on.

## Cleaning the Device

### Housing

Thoroughly wipe the housing, including all buttons and triggers, using an approved alcohol wipe.

### Display

The display can be wiped down with an approved alcohol wipe, but care should be taken not to allow any pooling of liquid around the edges of the display. Immediately dry the display with a soft, non-abrasive cloth to prevent streaking.

## Exit Window

Wipe the exit window periodically with a lens tissue or other material suitable for cleaning optical material such as eyeglasses.

## Cleaning Battery Connectors

To clean the battery connectors:

1. Remove the main battery from the mobile computer.
2. Dip the cotton portion of the cotton-tipped applicator in isopropyl alcohol.
3. To remove any grease or dirt, rub the cotton portion of the cotton-tipped applicator back-and-forth across the connectors on the battery and terminal sides. Do not leave any cotton residue on the connectors.
4. Repeat at least three times.
5. Use a dry cotton-tipped applicator and repeat steps 3 and 4. Do not leave any cotton residue on the connectors.
6. Inspect the area for any grease or dirt and repeat the cleaning process if necessary.



**CAUTION:** After cleaning the battery connectors with bleach-based chemicals, follow the Battery Connector Cleaning instructions to remove bleach from the connectors.

## Cleaning Cradle Connectors

To clean the connectors on a cradle:

1. Remove the DC power cable from the cradle.
2. Dip the cotton portion of the cotton-tipped applicator in isopropyl alcohol.
3. Rub the cotton portion of the cotton-tipped applicator along the pins of the connector. Slowly move the applicator back-and-forth from one side of the connector to the other. Do not leave any cotton residue on the connector.
4. All sides of the connector should also be rubbed with the cotton-tipped applicator.
5. Remove any lint left by the cotton-tipped applicator.
6. If grease and other dirt can be found on other areas of the cradle, use a lint-free cloth and alcohol to remove.
7. Allow at least 10 to 30 minutes (depending on ambient temperature and humidity) for the alcohol to air dry before applying power to cradle.

If the temperature is low and humidity is high, longer drying time is required. Warm temperature and low humidity requires less drying time.



**CAUTION:** After cleaning the cradle connectors with bleach-based chemicals, follow the Cleaning Cradle Connectors instructions to remove bleach from the connectors.

# Troubleshooting

## MC93XX

The following tables provides typical problems that might arise and the solution for correcting the problem.

Table 14 Troubleshooting the MC93XX

Problem	Cause	Solution
When pressing the power button the device does not turn on.	Battery not charged.	Charge or replace the battery in the device.
	Battery not installed properly.	Install the battery properly.
	System crash.	Perform a reset.
When pressing the power button the device does not turn on but LED bar blinks.	Battery charge is at a level where data is maintained but battery should be re-charged.	Charge or replace the battery in the device.
Battery did not charge.	Battery failed.	Replace battery. If the device still does not operate, perform a reset.
	Device removed from cradle while battery was charging.	Insert device in cradle. The 7,000 mAh battery fully charges in less than five hours at room temperature.
	Extreme battery temperature.	Battery does not charge if ambient temperature is below 0°C (32°F) or above 40°C (104°F).
Cannot see characters on display.	Device not powered on.	Press the Power button.
During data communication with a host computer, no data transmitted, or transmitted data was incomplete.	Device removed from cradle or disconnected from host computer during communication.	Replace the device in the cradle, or reattach the communication cable and re-transmit.
	Incorrect cable configuration.	See the system administrator.
	Communication software was incorrectly installed or configured.	Perform setup.
During data communication over Wi-Fi, no data transmitted, or transmitted data was incomplete.	Wi-Fi radio is not on.	Turn on the Wi-Fi radio.
	You moved out of range of an access point.	Move closer to an access point.



Table 14 Troubleshooting the MC93XX

Problem	Cause	Solution
During data communication over Bluetooth, no data transmitted, or transmitted data was incomplete.	Bluetooth radio is not on.	Turn on the Bluetooth radio.
	You moved out of range of another Bluetooth device.	Move within 10 meters (32.8 feet) of the other device.
No sound.	Volume setting is low or turned off.	Adjust the volume.
Device shuts off.	Device is inactive.	The display turns off after a period of inactivity. Set this period to 15 seconds, 30 seconds, 1, 2, 5, 10 or 30 minutes.
	Battery is depleted.	Replace the battery.
Tapping the window buttons or icons does not activate the corresponding feature.	The device is not responding.	Reset the device.
A message appears stating that the device memory is full.	Too many files stored on the device.	Delete unused memos and records. If necessary, save these records on the host computer (or use an SD card for additional memory).
	Too many applications installed on the device.	Remove user-installed applications on the device to recover memory. Select <b>⚙️ &gt; Storage &gt; FREE UP SPACE &gt; REVIEW RECENT ITEMS</b> . Select the unused program(s) and tap <b>FREE UP</b> .
The device does not decode with reading bar code.	Scanning application is not loaded.	Load a scanning application on the device or enable DataWedge. See the system administrator.
	Unreadable bar code.	Ensure the symbol is not defaced.
	Distance between exit window and bar code is incorrect.	Place the device within proper scanning range.
	Device is not programmed for the bar code.	Program the device to accept the type of bar code being scanned. Refer to the EMDK or DataWedge application.
	Device is not programmed to generate a beep.	If the device does not beep on a good decode, set the application to generate a beep on good decode.
	Battery is low.	If the scanner stops emitting a laser beam upon a trigger press, check the battery level. When the battery is low, the scanner shuts off before the device low battery condition notification. Note: If the scanner is still not reading symbols, contact the distributor or the Global Customer Support Center.

Table 14 Troubleshooting the MC93XX

Problem	Cause	Solution
Device cannot find any Bluetooth devices nearby.	Too far from other Bluetooth devices.	Move closer to the other Bluetooth device(s), within a range of 10 meters (32.8 feet).
	The Bluetooth device(s) nearby are not turned on.	Turn on the Bluetooth device(s) to find.
	The Bluetooth device(s) are not in discoverable mode.	Set the Bluetooth device(s) to discoverable mode. If needed, refer to the device's user documentation for help.
Cannot unlock device.	User enters incorrect password.	If you enter an incorrect password eight times, you are requested to enter a code before trying again. If you forgot the password, contact your system administrator.
Battery pack communication error.	The battery is not inserted properly.	Remove and reinsert the battery into the device.
	The battery is properly inserted, however, when the terminal is in an active vibration environment or has fallen from a high vantage point (more than 8 ft), it might interrupt battery communication.	Remove and reinsert the battery into the device.
	The battery communication pin is damaged.	Remove the battery and insert a new battery into the device.

# Specifications

## Introduction

The following sections provide technical specification for the device.

## MC93XX Technical Specifications

The following table summarizes the MC93XX's intended operating environment and technical hardware specifications.

Table 15 MC93XX Technical Specifications

Item	Description
<b>Physical Characteristics</b>	
Dimensions	9.4 in L x 3.45 in W x 7.4 in H 240 mm L x 88 mm W x 189 mm H
Weight	26.9 oz./765g with battery
Display	4.3" WVGA (800 x 480), color display
Imager Window	Corning® Gorilla® Glass
Touch Panel	Dual mode capacitive touch with finger, gloved finger or stylus input (conductive stylus sold separately), Screen Protector, Corning® Gorilla® Glass touch panel with air gap (standard model) or optically bonded (freezer model).
Backlight	LED backlight display
Battery	7000mAh PowerPrecision+ standard battery 5000mAh PowerPrecision+ freezer battery 7000mAh PowerPrecision+ non-incendive battery
Expansion Slot	User accessible microSD slot. Supports up to 32 GB microSDHC and up to 256 GB microSDXC.
Network Connections	USB 2.0 High Speed (Host & Client), WLAN and WPAN (Bluetooth)
Notification	Audible tone; Multi-color LED bar (between keyboard and display), and haptic feedback.
Keypad Options	53 Key Standard, 53 Key Terminal Emulation (VT, 5250, and 3270), 43 Key Shifted Alpha, 34 Key Numeric, 58-Keys OmniXT15f, and 29-Keys Shifted Alpha.

## Specifications

Table 15 MC93XX Technical Specifications (Continued)

Item	Description
Voice	Speaker, Microphone, PTT Voice (Internal Speaker and Bluetooth Wireless Headset Support).
Audio	Speaker
<b>Performance Characteristics</b>	
CPU	Qualcomm Snapdragon™ 660 octa-core, 2.2 GHz
Operating System	Android 8.1 Oreo with Zebra's Restricted Mode for control over GMS and other services.
Memory	4 GB RAM/32 GB Flash pSLC.
Output Power (USB)	USB: 5 VDC @ 500 mA max.
<b>User Environment</b>	
Operating Temperature	Standard: -4°F to 122°F/-20°C to +50°C Freezer: -22°F to 122°F/-30°C to +50°C
Storage Temperature	-40°F to 158°F/-40°C to 70°C
Charging Temperature	0°C to 40°C (32°F to 104°F)
Humidity	Standard: 5% to 95%, non-condensing Freezer: 5% to 95%, condensing
Drop Specification	<b>Standard:</b> 8 ft. (2.4m) drops to concrete across temperature per MIL-STD-810G. <b>Freezer:</b> 7 ft. (2.1m) drops to concrete across temperature per MIL-STD-810G.
Tumble Specification	4,000 3.3 ft. (1m) tumbles; meets and exceeds IEC tumble specification.
Sealing	IP67 and IP65 per IEC sealing specification.
Vibration	4 g's PK Sine (5 Hz to 2 kHz); 0.04 g 2/Hz Random (20 Hz to 2 kHz); 60 minute duration per axis, 3 axis
Thermal Shock	-40°C to 70°C (-40°F to 158°F) rapid transition.
Electrostatic Discharge (ESD)	+/-15kVdc air discharge +/-8kVdc direct discharge +/-8kVdc indirect discharge
<b>Interactive Sensor Technology (IST)</b>	
Ambient Light Sensor	Ambient light sensor used to auto adjust display and keyboard back light brightness.
Motion Sensor	3-axis accelerometer provides motion-sensing for dynamic screen orientation.
<b>Wireless LAN Data Communications</b>	
Radio	IEEE 802.11 a/b/g/n/ac/d/h/i/r/k/w; Wi-Fi certified; IPv4, IPv6, 2x2 MU-MIMO
Data Rates	<b>5GHz:</b> 802.11a/n/ac — up to 866.7 Mbps <b>2.4GHz:</b> 802.11b/g/n — up to 300 Mbps

## Specifications

Table 15 MC93XX Technical Specifications (Continued)

Item	Description
Operating Channels	Channel 1-13 (2412-2472 MHz); Chan 36-165 (5180-5825 MHz) Channel Bandwidth: 20, 40, 80 MHz Actual operating channels/ frequencies and bandwidths depend on regulatory rules and certification agency.
Security and Encryption	WEP (40 or 104 bit); WPA/WPA2 Personal (TKIP and AES); WPA/WPA2 Enterprise (TKIP and AES) - EAP-TTLS (PAP, MSCHAP, MSCHAPv2), EAP-TLS, PEAPv0-MSCHAPv2, PEAPv1-EAP-GTC and LEAP, EAP-PWD Data in Motion: FIPS 140-2 Level 1 Data at Rest: FIPS 140-2 Level 1
Certifications	WFA (802.11n, WMM-PS, 802.11ac, PMF, WMM-AC, Voice Enterprise, WiFi Direct and WPS 2.0)
Fast Roam	PMKID caching; Cisco CCKM; 802.11r; OKC
<b>Wireless PAN Data</b>	
Bluetooth	Class II, Bluetooth V5.0 with BR/EDR and Bluetooth Low Energy (BLE) Support
<b>Communication and Messaging</b>	
Workforce Connect PTT Express (included) provides instant push-to-talk small group communications across Wi-Fi networks. Workforce Connect PTT Pro (supported) provides a scalable network agnostic push-to-talk solution which also includes messaging, location services and two-way radio integration. Workforce Connect Voice client (supported) enables the MC9300 to function as a full featured mobile telephone with multi-line capability across Wi-Fi networks.	
<b>Device Approvals and Compliance</b>	
TAA (Optional on select configurations)	Trade Agreement Act optional on select configurations Complaint, FIPS 140-2 (DIM & DAR) support; FIPS 140-2 Level 1: Data in Motion and Data at Rest
Non-Incendive (NI) (Optional on select configurations)	Suitable for use in Class I, II, III Div 2 Safety: cULus Listing - ISA/ANSA 12.12.01 Gases: Class I - Groups A, B, C, D Dusts: Class II - Groups F, G Fibers & Flyings: Class III -20°C ≤ Ta ≤ +50°C T6
<b>Peripherals and Accessories</b>	
Cradles	Single slot USB/Charge, Four-slot charger only.
Battery Chargers	4-slot battery charger and 16-slot battery charger.
Other Accessories	USB/charge snap-on cup, forklift holder, soft holster, screen protector, hand strap, stylus

## Specifications

Table 15 MC93XX Technical Specifications (Continued)

Item	Description
<b>Data Capture</b>	
Scanning	<p><b>SE965:</b> 1D standard range scan engine.</p> <p><b>SE4750-SR:</b> Standard Range omnidirectional 1D/2D imaging engine reads 1D and 2D symbols. (Premium only).</p> <p><b>SE4850-ER:</b> Extended range omnidirectional 1D/2D imaging engine reads 1D and 2D symbols.</p> <p><b>SE4750DPM:</b> Omnidirectional 1D and 2D imaging engine reads Direct Part Marking.</p> <p><b>SE4750DPW:</b> Omnidirectional 1D and 2D imaging engine reads wide 1D and Direct Part Marking.</p> <p><b>SE4770-SR:</b> Standard range next generation omnidirectional 1D/2D imaging engine.</p>
Camera	<p><b>Front:</b> 5MP fixed focus and 2.0 aperture.</p> <p><b>Rear:</b> 13MP autofocus, 2.2 aperture, flash LED generates balanced white light, support torch mode, and supports rear camera barcode scanning.</p>
Near Field Communications (NFC)	Tap to Pair, ISO 14443 Type A and B, FeliCa cards in Reader Mode, ISO 15693 cards, P2P mode and Card Emulation via Host (HCE) support.
<b>Data Capture Options</b>	
Laser Decode Capability	Code 39, Code 128, Code 93, Codabar, Code 11, Discrete 2 of 5, Interleaved 2 of 5, EAN-8, EAN-13, MSI, UPCA, UPCE, UPC/EAN supplementals, Coupon Code, Trioptic 39, Webcode, RSS-14, RSS Limited, RSS Expanded, Chinese 2 of 5
Imaging Decode Capability	Code 39, Code 128, Code 93, Codabar, Code 11, Interleaved 2 of 5, Discrete 2 of 5, MSI, EAN-8, EAN-13, UPCA, UPCE, UPC/EAN supplementals, Coupon Code, Trioptic 39, Webcode, TLC39, Composite AB, Composite C, Micro PDF-417, PDF-417, Macro PDF-417, (Macro) Micro PDF-417, QR Code, RSS Expanded, RSS Limited, RSS-14, Data Matrix, Maxi Code, US Postnet, US Planet, UK 4-state, Australian 4-state, Canadian 4-state, Japanese 4-state, Dutch Kix, Chinese 2 of 5, USPS 4-state (US4CB), Aztec, microQR, Dotcode

# Keypads

## Introduction

The device has the following interchangeable modular keypads:

- 58-key Alpha Numeric Function keypad
- 53-key Standard keypad
- 53-key IBM-5250 Emulator keypad
- 53-key IBM-3270 Emulator keypad
- 53-key VT Emulator keypad
- 43-key Shifted Alpha keypad
- 34-key Numeric keypad
- 29-key Shifted Alpha keypad.

To support specialized applications, you can change the modular keypads in the field when required.

## Removing and Replacing Keypads

1. Power off the device.
2. Remove the battery.
3. Using a Torx T8 screwdriver with a large grip, remove the two keypad latch screws from inside the battery slot.

Figure 129 Remove Keypad Latch Screws

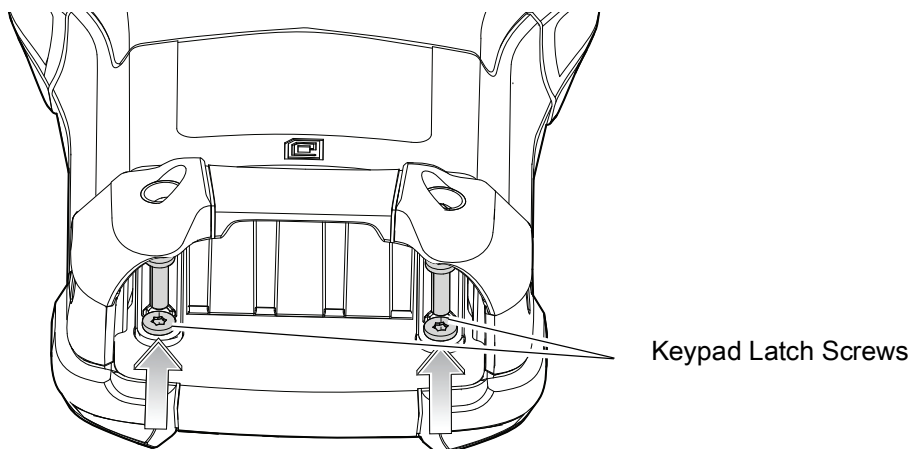

- Slide the keypad latches toward the bottom of the device.

Figure 130 Release Keypad Latches

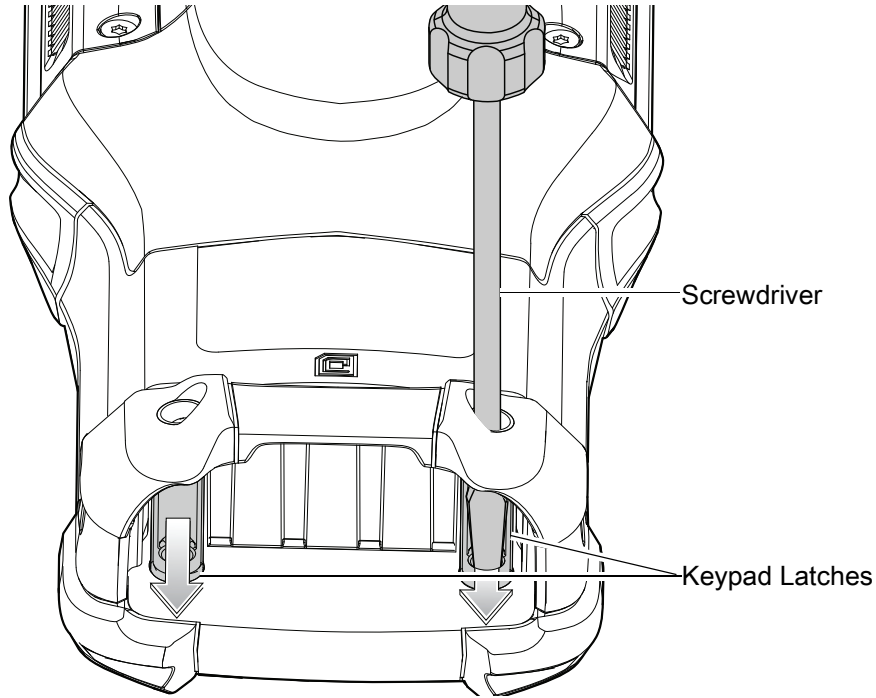

**NOTE:** If the keypad latches are hard to move, use a screwdriver to gently slide them towards the bottom of the device.

- Turn the device over so that the keypad is visible.
- Using a Torx T8 screwdriver with a large grip, remove the two keypad assembly screws from the top of the keypad.

Figure 131 Remove Keypad

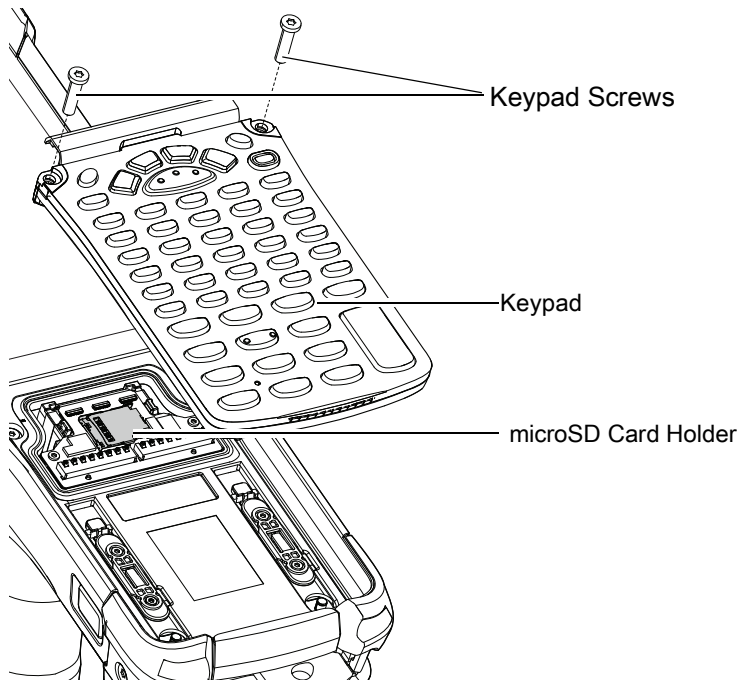



7. Lift the keypad from the device.
8. Align the keypad along the bottom ridge of the device, and then lay it flat.

Figure 132 Replace Keypad

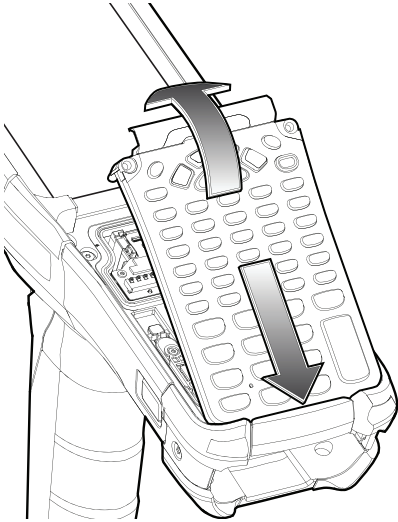

9. Using a Torx T8 screwdriver with a large grip and a long shaft, secure the keypad to the device using the two screws. Torque screws to 5.8 kgf-cm or 5.0 lbf-in.

Figure 133 Replace Keypad Screws

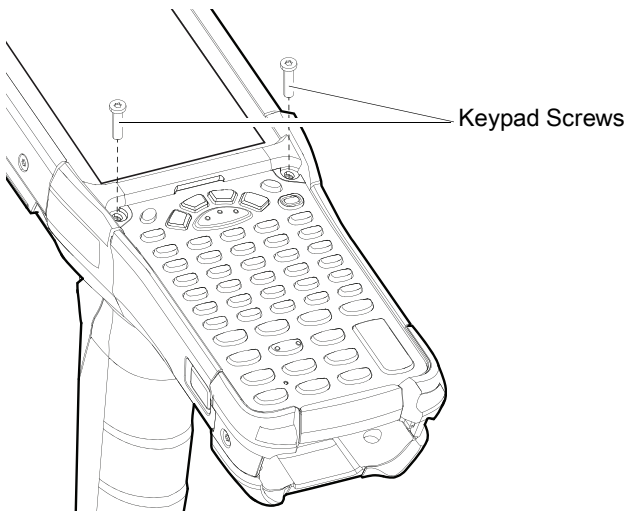

10. Turn the device over so that the keypad latches are visible.

11. Slide both the keypad latches toward the top of the device.

Figure 134 Slide Keypad Latches

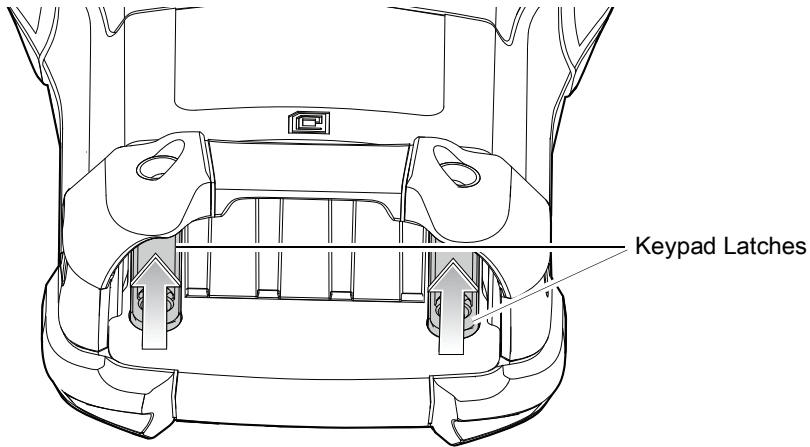

12. Using a Torx T8 screwdriver, replace the two keypad latch screws inside the battery slot and torque to 5.8 kgf-cm or 5.0 lbf-in.

Figure 135 Replace Keypad Latch Screws

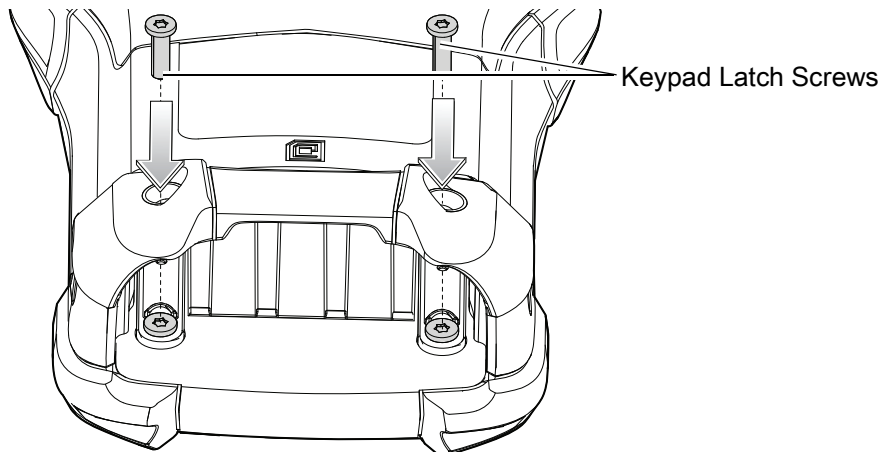

13. Insert the battery.

14. Press and hold the Power key to power on the device.

## 58-Keys Alpha Numeric Function Keypad

The 58-key keypad contains a Power button, application keys, scroll keys and function keys. The keypad is color-coded to indicate the alternate function key (blue) values. Note that keypad functions can be changed by an application so the device's keypad may not function exactly as described. See the Key Descriptions table for key and button details, and the Keypad Special Functions table for the keypad's various functions.

Figure 136 58-Keys Alpha Numeric Function Keypad

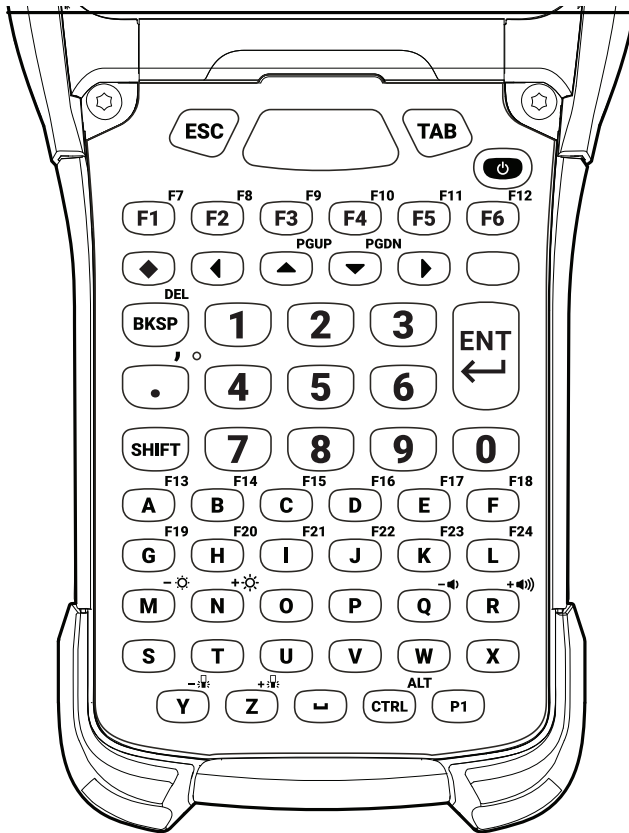

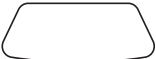

Table 16 58-Key Alpha Numeric Function Keypad Key Descriptions

Key	Description
Power (Red) 	Turns the device on and off. Performs a warm boot and a hard reset. See Resetting the Device for more information.
P1 	User programmable key. By default, P1 is the dedicated PTT key.
Scan (Yellow) 	Activates the scanner/imager in a scan enabled application.

## Keypads

Table 16 58-Key Alpha Numeric Function Keypad Key Descriptions (Continued)























Key	Description
ESC 	Exits the current operation.
TAB 	Tab function.
Up and Down 	Moves up and down from one item to another.
Left and Right 	Moves left and right from one item to another.
Alpha 	Use the alpha keys for alphabetic characters.
BKSP 	Backspace function.
SPACE 	Space function.
Numeric/Application 	The numeric keys generate keycodes 0 to 9.
Function (blue) 	<p>Press and release the blue function key to activate the keypad alternate functions (shown on the keypad in Blue). Press the Blue function key once to put the keyboard into one-shot mode. The  icon appears on the Status bar. Press the Blue function key again the keypad is locked in function mode, and the  icon appears in the Status bar. Press and release the Blue function key a third time to return to the default keypad functions, and the  icon clears.</p> <p>Press the blue function key and SHIFT to activate CAPSLOCK mode, the  icon appears.</p>
Control 	<p>Press and release the CTRL key to activate the keypad alternate CTRL functions. The  icon appears in the status bar.</p> <p>Press the Blue key followed by the CTRL key to activate the keypad alternate ALT functions. The  icon appears in the status bar.</p>

Table 16 58-Key Alpha Numeric Function Keypad Key Descriptions (Continued)

Key	Description																		
	<p>Press and release the SHIFT key to activate the keypad alternate SHIFT functions. The  icon appears in the status bar. After pressing another key, the keypad returns to the non-shift state.</p> <p>Press and release the SHIFT key twice to enable the Shift Lock state. The  icon appears in the status bar. Press and release the SHIFT key again to disable the Shift Lock state.</p>																		
	<p>Produces a period for alpha entries and a decimal point for numeric entries.</p>																		
	<p>Provides a 3x3 matrix on the screen with nine additional symbols. With a single tap you can select via touch input or the keyboard, 1-9 numerical keys. Double tapping the Diamond key locks the 3x3 grid, and you can select multiple keys. Pressing the Diamond key a third time closes the 3x3 matrix. You can modify the symbols in the 3x3 matrix using the StageNow utility in the KeyMappingMgr settings.</p> <div style="text-align: center; border: 1px solid gray; padding: 5px; margin: 10px 0;"> <table style="border-collapse: collapse; width: 100%;"> <tr> <td style="text-align: center; font-size: small;">1</td> <td style="text-align: center; font-size: small;">2</td> <td style="text-align: center; font-size: small;">3</td> </tr> <tr> <td style="text-align: center;"> </td> <td style="text-align: center;">[</td> <td style="text-align: center;">]</td> </tr> <tr> <td style="text-align: center; font-size: small;">4</td> <td style="text-align: center; font-size: small;">5</td> <td style="text-align: center; font-size: small;">6</td> </tr> <tr> <td style="text-align: center;">£</td> <td style="text-align: center;">:</td> <td style="text-align: center;">€</td> </tr> <tr> <td style="text-align: center; font-size: small;">7</td> <td style="text-align: center; font-size: small;">8</td> <td style="text-align: center; font-size: small;">9</td> </tr> <tr> <td style="text-align: center;">~</td> <td style="text-align: center;">@</td> <td style="text-align: center;">-</td> </tr> </table> </div> <p><b>NOTE:</b> This is the default symbol layout for this keyboard.</p>	1	2	3		[	]	4	5	6	£	:	€	7	8	9	~	@	-
1	2	3																	
	[	]																	
4	5	6																	
£	:	€																	
7	8	9																	
~	@	-																	
	<p>Executes a selected item or function.</p>																		

## 53-Keys Standard Keypad

The 53-key keypad contains a Power button, application keys, scroll keys and function keys. The keypad is color-coded to indicate the alternate function key (blue) values. Note that keypad functions can be changed by an application so the device's keypad may not function exactly as described. See the Key Descriptions table for key and button details, and the Keypad Special Functions table for the keypad's various functions.

Figure 137 53-Keys Standard Keypad

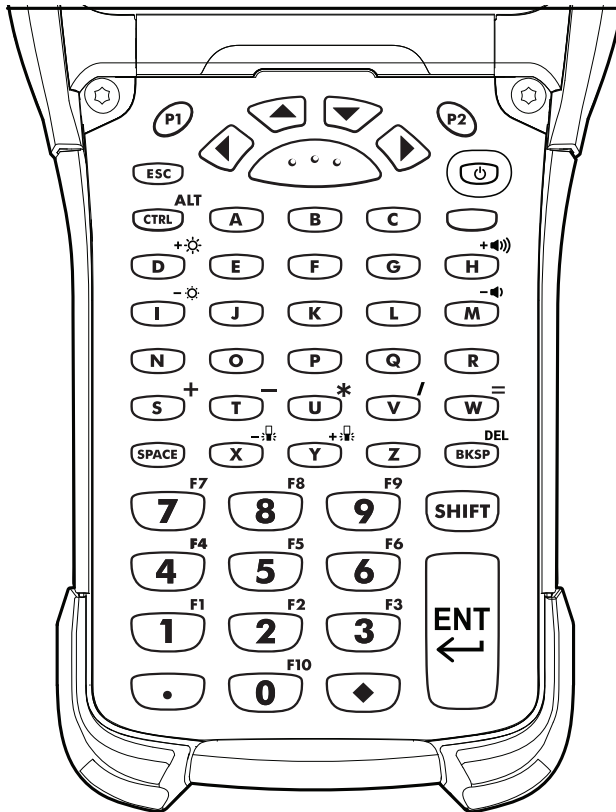





Table 17 53-Key Standard Keypad Key Descriptions

Key	Description
Power (Red) 	Turns the device on and off. Performs a warm boot and a hard reset. See Resetting the Device for more information.
P1 / P2 	User programmable keys: <ul style="list-style-type: none"> <li>• By default, P1 is the dedicated PTT key.</li> <li>• By default, P2 acts like another Scan key.</li> </ul>
Scan (Yellow) 	Activates the scanner/imager in a scan enabled application.

## Keypads

Table 17 53-Key Standard Keypad Key Descriptions (Continued)



















Key	Description
Up and Down 	Moves up and down from one item to another.
Left and Right 	Moves left and right from one item to another.
ESC 	Exits the current operation.
Alpha 	Use the alpha keys for alphabetic characters.
SPACE/BKSP 	Space and backspace functions.
Numeric/Application 	The numeric keys generate keycodes 0 to 9.
Function (blue) 	<p>Press and release the blue function key to activate the keypad alternate functions (shown on the keypad in Blue). Press the Blue function key once to put the keyboard into one-shot mode. The  icon appears on the Status bar. Press the Blue function key again the keypad is locked in function mode, and the  icon appears in the Status bar. Press and release the Blue function key a third time to return to the default keypad functions, and the  icon clears.</p> <p>Press the blue function key and SHIFT to activate CAPSLOCK mode, the  icon appears.</p>
Control ALT 	<p>Press and release the CTRL key to activate the keypad alternate CTRL functions. The  icon appears in the status bar.</p> <p>Press the Blue key followed by the CTRL key to activate the keypad alternate ALT functions. The  icon appears in the status bar.</p>
Shift 	<p>Press and release the SHIFT key to activate the keypad alternate SHIFT functions. The  icon appears in the status bar. After pressing another key, the keypad returns to the non-shift state.</p> <p>Press and release the SHIFT key twice to enable the Shift Lock state. The  icon appears in the status bar. Press and release the SHIFT key again to disable the Shift Lock state.</p>

Table 17 53-Key Standard Keypad Key Descriptions (Continued)

Key	Description																		
Period/Decimal Point 	Produces a period for alpha entries and a decimal point for numeric entries.																		
Diamond 	<p>Provides a 3x3 matrix on the screen with nine additional symbols. With a single tap you can select via touch input or the keyboard, 1-9 numerical keys. Double tapping the Diamond key locks the 3x3 grid, and you can select multiple keys. Pressing the Diamond key a third time closes the 3x3 matrix. You can modify the symbols in the 3x3 matrix using the StageNow utility in the KeyMappingMgr settings.</p> <div style="border: 1px solid gray; padding: 5px; width: fit-content; margin: 10px auto;"> <table style="border-collapse: collapse; text-align: center; font-size: 0.8em;"> <tr> <td style="border: 1px solid gray; padding: 2px;">7</td> <td style="border: 1px solid gray; padding: 2px;">8</td> <td style="border: 1px solid gray; padding: 2px;">9</td> </tr> <tr> <td style="border: 1px solid gray; padding: 2px;"> </td> <td style="border: 1px solid gray; padding: 2px;">[</td> <td style="border: 1px solid gray; padding: 2px;">]</td> </tr> <tr> <td style="border: 1px solid gray; padding: 2px;">4</td> <td style="border: 1px solid gray; padding: 2px;">:</td> <td style="border: 1px solid gray; padding: 2px;">6</td> </tr> <tr> <td style="border: 1px solid gray; padding: 2px;">£</td> <td style="border: 1px solid gray; padding: 2px;">@</td> <td style="border: 1px solid gray; padding: 2px;">€</td> </tr> <tr> <td style="border: 1px solid gray; padding: 2px;">1</td> <td style="border: 1px solid gray; padding: 2px;">2</td> <td style="border: 1px solid gray; padding: 2px;">3</td> </tr> <tr> <td style="border: 1px solid gray; padding: 2px;">~</td> <td style="border: 1px solid gray; padding: 2px;">-</td> <td style="border: 1px solid gray; padding: 2px;"></td> </tr> </table> </div> <p><b>NOTE:</b> This is the default symbol layout for this keyboard.</p>	7	8	9		[	]	4	:	6	£	@	€	1	2	3	~	-	
7	8	9																	
	[	]																	
4	:	6																	
£	@	€																	
1	2	3																	
~	-																		
Enter 	Executes a selected item or function.																		

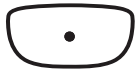

## 53-Keys IBM-5250 Emulator Keypad

The IBM-5250 emulator keypad contains a Power button, application keys, scroll keys and a function key. The keypad is color-coded to indicate the alternate function key (blue) values. Note that keypad functions can be changed by an application so the device's keypad may not function exactly as described. See the Key Descriptions table for key and button details, and the Keypad Special Functions table for the keypad's various functions.

Figure 138 53-Keys IBM-5250 Emulator Keypad

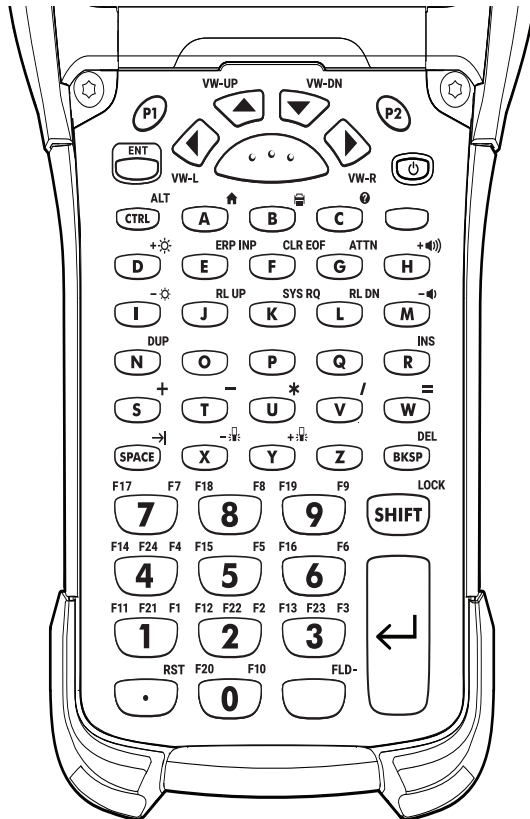

✓ **NOTE:** The IBM-5250 emulator configuration is only used when the device is running the 5250 emulation software.

# Keypads

Table 18 IBM-5250 Emulator Descriptions























Key	Description
Power (red) 	Turns the device on and off. Performs a warm boot and a hard reset. See Resetting the Device for more information.
P1/P2 	User programmable keys: <ul style="list-style-type: none"> <li>• By default, P1 is the dedicated PTT key.</li> <li>• By default, P2 acts like another Scan key.</li> </ul>
Scan (yellow) 	Activates the scanner/imager in a scan enabled application.
Up and Down VW-UP VW-DN 	Moves up and down from one item to another.
Left and Right 	Moves left and right from one item to another.
ENT 	The enter key.
Alpha 	Use the alpha keys for alphabetic characters.
SPACE/BKSP 	Space and backspace functions.
Application F11 F1 F12 F2 F13 F3 	The numeric keys generate keycodes 0 to 9.
Function (blue) 	Press and release the blue function key to activate the keypad alternate functions (shown on the keypad in Blue). Press the Blue function key once to put the keyboard into one-shot mode. The  icon appears on the Status bar. Press the Blue function key again the keypad is locked in function mode, and the  icon appears in the Status bar. Press and release the Blue function key a third time to return to the default keypad functions, and the  icon clears. Press the blue function key and SHIFT to activate CAPSLOCK mode, the  icon appears.
Control ALT 	Press and release the CTRL key to activate the keypad alternate CTRL functions. The  icon appears in the status bars. Press the Blue key followed by the CTRL key to activate the keypad alternate ALT functions. The  icon appears in the status bar.

Table 18 IBM-5250 Emulator Descriptions (Continued)

Key	Description																		
<p>Shift</p> 	<p>Press and release the SHIFT key to activate the keypad alternate SHIFT functions. The  icon appears in the status bar. After pressing another key, the keypad returns to the non-shift state.</p> <p>Press and release the SHIFT key twice to enable the Shift Lock state. The  icon appears in the status bar. Press and release the SHIFT key again to disable the Shift Lock state.</p>																		
<p>Period/Decimal Point</p> 	<p>Produces a period for alpha entries and a decimal point for numeric entries.</p>																		
<p>Diamond</p> 	<p>Provides a 3x3 matrix on the screen with nine additional symbols. With a single tap you can select via touch input or the keyboard, 1-9 numerical keys. Double tapping the Diamond key locks the 3x3 grid, and you can select multiple keys. Pressing the Diamond key a third time closes the 3x3 matrix. You can modify the symbols in the 3x3 matrix using the StageNow utility in the KeyMappingMgr settings.</p> <div style="border: 1px solid gray; padding: 5px; width: fit-content; margin: 10px auto;"> <table style="border-collapse: collapse; text-align: center;"> <tr> <td style="border: 1px solid gray; padding: 2px;">7</td> <td style="border: 1px solid gray; padding: 2px;">8</td> <td style="border: 1px solid gray; padding: 2px;">9</td> </tr> <tr> <td style="border: 1px solid gray; padding: 2px;"> </td> <td style="border: 1px solid gray; padding: 2px;">[</td> <td style="border: 1px solid gray; padding: 2px;">]</td> </tr> <tr> <td style="border: 1px solid gray; padding: 2px;">4</td> <td style="border: 1px solid gray; padding: 2px;">5</td> <td style="border: 1px solid gray; padding: 2px;">6</td> </tr> <tr> <td style="border: 1px solid gray; padding: 2px;">£</td> <td style="border: 1px solid gray; padding: 2px;">:</td> <td style="border: 1px solid gray; padding: 2px;">€</td> </tr> <tr> <td style="border: 1px solid gray; padding: 2px;">1</td> <td style="border: 1px solid gray; padding: 2px;">2</td> <td style="border: 1px solid gray; padding: 2px;">3</td> </tr> <tr> <td style="border: 1px solid gray; padding: 2px;">~</td> <td style="border: 1px solid gray; padding: 2px;">@</td> <td style="border: 1px solid gray; padding: 2px;">-</td> </tr> </table> </div> <p><b>NOTE:</b> This is the default symbol layout for this keyboard.</p>	7	8	9		[	]	4	5	6	£	:	€	1	2	3	~	@	-
7	8	9																	
	[	]																	
4	5	6																	
£	:	€																	
1	2	3																	
~	@	-																	
<p>FIELD_EXIT</p> 	<p>Executes a selected item or function.</p>																		

## 53-Keys IBM-3270 Emulator Keypad

The IBM-3270 emulator keypad contains a Power button, application keys, scroll keys and a function key. The keypad is color-coded to indicate the alternate function key (blue, green, orange) values. Note that keypad functions can be changed by an application so the device's keypad may not function exactly as described. See the Key Descriptions table for key and button details.

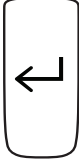
Figure 139 53-Keys IBM-3270 Emulator Keypad

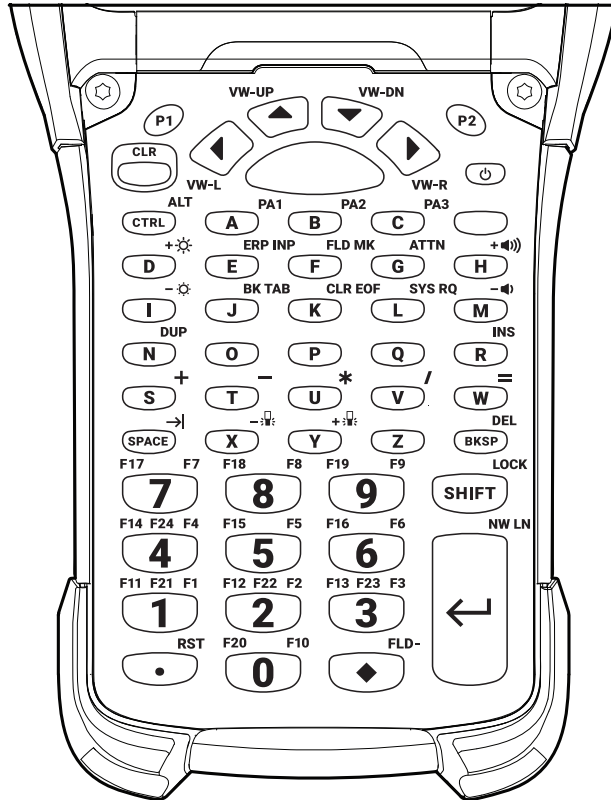

✓ **NOTE:** The IBM-3270 emulator configuration is only used when the device is running the 3270 emulation software.

Table 19 IBM-3270 Emulator Descriptions



Key	Description
Power (red) 	Turns the device on and off. Performs a warm boot and a hard reset. See Resetting the Device for more information.
P1/P2 	User programmable keys: <ul style="list-style-type: none"> <li>• By default, P1 is the dedicated PTT key.</li> <li>• By default, P2 acts like another Scan key.</li> </ul>
Scan (yellow) 	Activates the scanner/imager in a scan enabled application.

Table 19 IBM-3270 Emulator Descriptions (Continued)













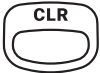







Key	Description
Up and Down <b>VW-UP</b> <b>VW-DN</b> 	Moves up and down from one item to another.
Left and Right  <b>VW-L</b> <b>VW-R</b>	Moves left and right from one item to another.
CLR 	The clear key.
Alpha <b>PA1</b> <b>PA2</b> <b>PA3</b> 	Use the alpha keys for alphabetic characters.
SPACE/BKSP 	Space and backspace functions.
Application <b>F11 F21 F1</b> <b>F12 F22 F2</b> <b>F13 F23 F3</b> 	The numeric keys generate keycodes 0 to 9.
Function (Blue) 	<p>Press and release the Blue function key to activate the keypad alternate functions (shown on the keypad in Blue). Press the Blue function key once to put the keyboard into one-shot mode. The  icon appears on the Status bar. Press the Blue function key again the keypad is locked in function mode, and the  icon appears in the Status bar. Press and release the Blue function key a third time to return to the default keypad functions, and the  icon clears.</p> <p>Press the blue function key and SHIFT to activate CAPSLOCK mode, the  icon appears.</p>
Control <b>ALT</b> 	<p>Press and release the CTRL key to activate the keypad alternate CTRL functions (shown on the keypad in Green). The  icon appears in the status bars.</p> <p>Press the Blue key followed by the CTRL key to activate the keypad alternate ALT functions. The  icon appears in the status bar.</p>
Shift <b>LOCK</b> 	<p>Press and release the SHIFT key to activate the keypad alternate SHIFT functions (shown on the keypad in Orange). The  icon appears in the status bar. After pressing another key, the keypad returns to the non-shift state.</p> <p>Press and release the SHIFT key twice to enable the Shift Lock state. The  icon appears in the status bar. Press and release the SHIFT key again to disable the Shift Lock state.</p>

Table 19 IBM-3270 Emulator Descriptions (Continued)

Key	Description
Period/Decimal Point <b>RST</b> 	Produces a period for alpha entries and a decimal point for numeric entries.
Diamond <b>FLD-</b> 	Provides a 3x3 matrix on the screen with nine additional symbols. With a single tap you can select via touch input or the keyboard, 1-9 numerical keys. Double tapping the Diamond key locks the 3x3 grid, and you can select multiple keys. Pressing the Diamond key a third time closes the 3x3 matrix. You can modify the symbols in the 3x3 matrix using the StageNow utility in the KeyMappingMgr settings.   <p><b>NOTE:</b> This is the default symbol for this keyboard.</p>
ENTER <b>NW LN</b> 	Executes a selected item or function.

## 53-Keys VT Emulator Keypad

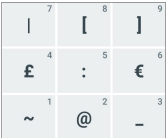
The VT emulator keypad contains a Power button, application keys, scroll keys and a function key. The keypad is color-coded to indicate the alternate function key (blue) values. Note that keypad functions can be changed by an application so the device's keypad may not function exactly as described. See the Key Descriptions table for key and button details, and the Keypad Special Functions table for the keypad's various functions.

Figure 140 53-Keys VT Emulator Keypad

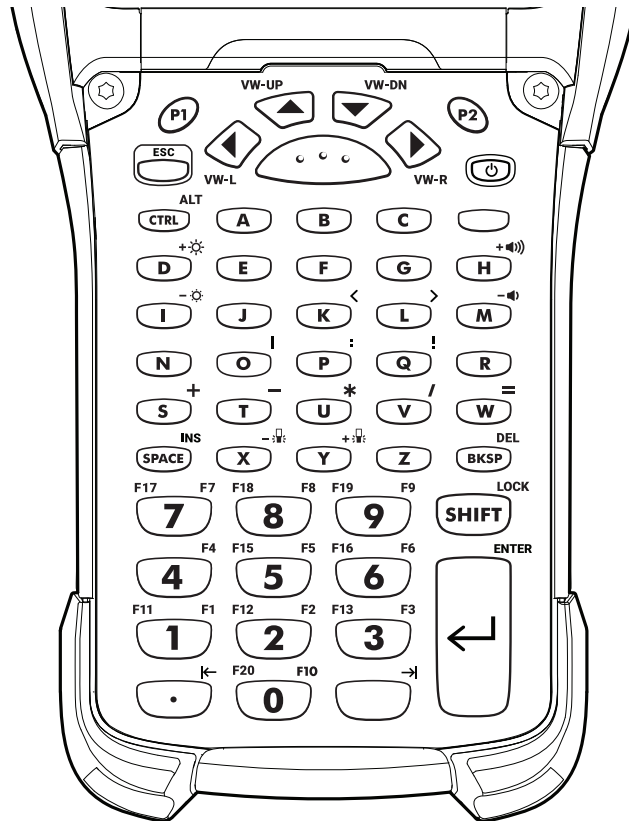

✓ **NOTE:** The VT emulator configuration is only used when the device is running the VT emulation software.

Table 20 VT Emulator Descriptions



Key	Description
Power (red) 	Turns the device on and off. Performs a warm boot and a hard reset. See Resetting the Device for more information.
P1/P2 	User programmable keys: <ul style="list-style-type: none"> <li>• By default, P1 is the dedicated PTT key.</li> <li>• By default, P2 acts like another Scan key.</li> </ul>
Scan (yellow) 	Activates the scanner/imager in a scan enabled application.

Table 20 VT Emulator Descriptions (Continued)















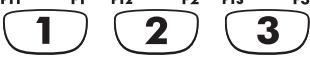



Key	Description
Up and Down <b>VW-UP</b> <b>VW-DN</b> 	Moves up and down from one item to another.
Left and Right  <b>VW-L</b> <b>VW-R</b>	Moves left and right from one item to another.
ESC 	Exits the current operation.
Alpha 	Use the alpha keys for alphabetic characters.
SPACE/BKSP 	Space and backspace functions.
Application <b>F11</b> <b>F1</b> <b>F12</b> <b>F2</b> <b>F13</b> <b>F3</b> 	The numeric keys generate keycodes 0 to 9. These keys can also be assigned to an application.
Function (blue) 	<p>Press and release the blue function key to activate the keypad alternate functions (shown on the keypad in Blue). Press the Blue function key once to put the keyboard into one-shot mode. The  icon appears on the Status bar. Press the Blue function key again the keypad is locked in function mode, and the  icon appears in the Status bar. Press and release the Blue function key a third time to return to the default keypad functions, and the  icon clears.</p> <p>Press the blue function key and SHIFT to activate CAPSLOCK mode, the  icon appears.</p>
Control <b>ALT</b> 	<p>Press and release the CTRL key to activate the keypad alternate CTRL functions. The  icon appears in the status bar.</p> <p>Press the Blue key followed by the CTRL key to activate the keypad alternate ALT functions. The  icon appears in the status bar.</p>
Shift <b>LOCK</b> 	<p>Press and release the SHIFT key to activate the keypad alternate SHIFT functions. The  icon appears in the status bar. After pressing another key, the keypad returns to the non-shift state.</p> <p>Press and release the SHIFT key twice to enable the Shift Lock state. The  icon appears in the status bar. Press and release the SHIFT key again to disable the Shift Lock state.</p>



Table 20 VT Emulator Descriptions (Continued)

Key	Description									
<p>Period/Decimal Point</p> 	<p>Produces a period for alpha entries and decimal point for numeric entries.</p>									
<p>Diamond</p> 	<p>Provides a 3x3 matrix on the screen with nine additional symbols. With a single tap you can select via touch input or the keyboard, 1-9 numerical keys. Double tapping the Diamond key locks the 3x3 grid, and you can select multiple keys. Pressing the Diamond key a third time closes the 3x3 matrix. You can modify the symbols in the 3x3 matrix using the StageNow utility in the KeyMappingMgr settings.</p> <div style="border: 1px solid gray; padding: 5px; margin: 10px 0;"> <table style="border-collapse: collapse; text-align: center; width: 100%;"> <tr> <td style="border: 1px solid gray; width: 33px; height: 33px;">7  </td> <td style="border: 1px solid gray; width: 33px; height: 33px;">8  </td> <td style="border: 1px solid gray; width: 33px; height: 33px;">9  </td> </tr> <tr> <td style="border: 1px solid gray; width: 33px; height: 33px;">4 £</td> <td style="border: 1px solid gray; width: 33px; height: 33px;">5 :</td> <td style="border: 1px solid gray; width: 33px; height: 33px;">6 €</td> </tr> <tr> <td style="border: 1px solid gray; width: 33px; height: 33px;">1 ~</td> <td style="border: 1px solid gray; width: 33px; height: 33px;">2 @</td> <td style="border: 1px solid gray; width: 33px; height: 33px;">3 -</td> </tr> </table> </div> <p><b>NOTE:</b> This is the default symbol layout for this keyboard.</p>	7 	8 	9 	4 £	5 :	6 €	1 ~	2 @	3 -
7 	8 	9 								
4 £	5 :	6 €								
1 ~	2 @	3 -								
<p>Enter</p> 	<p>Executes a selected item or function.</p>									

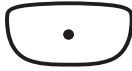
### 43-Keys Shifted Alpha Keypad

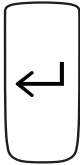
The 43-key keypad contains a **Power** button, application keys, scroll keys and a function key. The keypad is color-coded to indicate the alternate function key (blue) values and the alternate ALPHA key (orange) values. Note that keypad functions can be changed by an application so the MC93XX's keypad may not function exactly as described. See the Key Descriptions table for key and button details, and the Keypad Special Functions table for the keypad's various functions.

Figure 141 43-Keys Shifted Alpha Keypad

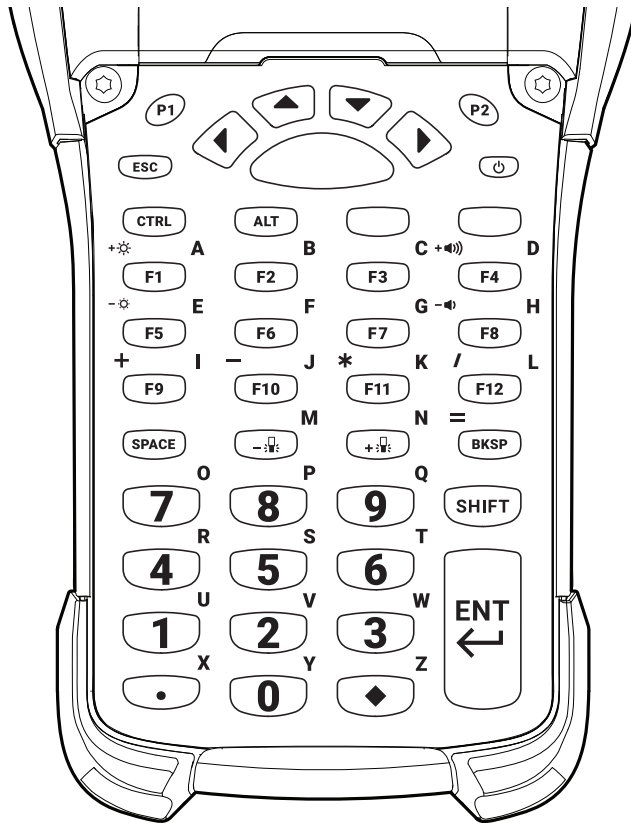

Table 21 43 Shifted Alpha Descriptions



Key	Description
Power (red) 	Turns the device on and off. Performs a warm boot and a hard reset. See Resetting the Device for more information.
P1/P2 	User programmable keys: <ul style="list-style-type: none"> <li>• By default, P1 is the dedicated PTT key.</li> <li>• By default, P2 acts like another Scan key.</li> </ul>
Scan (yellow) 	Activates the scanner/imager in a scan enabled application.

Table 21 43 Shifted Alpha Descriptions (Continued)























Key	Description
Up and Down 	Moves up and down from one item to another.
Left and Right 	Moves left and right from one item to another.
ESC 	Exits the current operation.
CTRL 	Press and release the CTRL key to activate the keypad alternate CTRL functions. The <b>C</b> icon appears in the status bars.
ALT 	Press the Blue key followed by the CTRL key to activate the keypad alternate ALT functions. The <b>A</b> icon appears in the status bar.
SPACE/BKSP 	Space and backspace functions.
Application 	The numeric keys generate keycodes 0 to 9.
Function (Blue) 	Press and release the blue function key to activate the keypad alternate functions (shown on the keypad in Blue). Press the Blue function key once to put the keyboard into one-shot mode. The  icon appears on the Status bar. Press the Blue function key again the keypad is locked in function mode, and the  icon appears in the Status bar. Press and release the Blue function key a third time to return to the default keypad functions, and the  icon clears. Press the blue function key and SHIFT to activate CAPSLOCK mode, the  icon appears.
Function (Orange) 	Press and release the blue function key to activate the alpha key functions (shown on the keypad in Orange). Press and release the Orange function key to activate the keypad alternate functions (shown on the keypad in Orange). Press the Orange function key once to put the keyboard into one-shot mode. The  icon appears on the Status bar. Press the Orange function key again the keypad is locked in function mode, and the  icon appears in the Status bar. Press and release the Orange function key a third time to return to the default keypad functions, and the  icon clears.

Table 21 43 Shifted Alpha Descriptions (Continued)

Key	Description									
<p>Shift</p> 	<p>Press and release the SHIFT key to activate the keypad alternate SHIFT functions. The  icon appears in the status bar. After pressing another key, the keypad returns to the non-shift state.</p> <p>Press and release the SHIFT key twice to enable the Shift Lock state. The  icon appears in the status bar. Press and release the SHIFT key again to disable the Shift Lock state.</p>									
<p>Period/Decimal Point</p> 	<p>Produces a period for alpha entries and a decimal point for numeric entries.</p>									
<p>Diamond</p> 	<p>Provides a 3x3 matrix on the screen with nine additional symbols. With a single tap you can select via touch input or the keyboard, 1-9 numerical keys. Double tapping the Diamond key locks the 3x3 grid, and you can select multiple keys. Pressing the Diamond key a third time closes the 3x3 matrix. You can modify the symbols in the 3x3 matrix using the StageNow utility in the KeyMappingMgr settings.</p> <div style="border: 1px solid gray; padding: 5px; margin: 10px 0;"> <table style="border-collapse: collapse; text-align: center; width: 100%;"> <tr> <td style="border: 1px solid gray; width: 33px; height: 33px;">7  </td> <td style="border: 1px solid gray; width: 33px; height: 33px;">8 [</td> <td style="border: 1px solid gray; width: 33px; height: 33px;">9 ]</td> </tr> <tr> <td style="border: 1px solid gray; width: 33px; height: 33px;">4 £</td> <td style="border: 1px solid gray; width: 33px; height: 33px;">5 :</td> <td style="border: 1px solid gray; width: 33px; height: 33px;">6 €</td> </tr> <tr> <td style="border: 1px solid gray; width: 33px; height: 33px;">1 ~</td> <td style="border: 1px solid gray; width: 33px; height: 33px;">2 @</td> <td style="border: 1px solid gray; width: 33px; height: 33px;">3 -</td> </tr> </table> </div> <p><b>NOTE:</b> This is the default symbol layout for this keyboard.</p>	7 	8 [	9 ]	4 £	5 :	6 €	1 ~	2 @	3 -
7 	8 [	9 ]								
4 £	5 :	6 €								
1 ~	2 @	3 -								
<p>Enter</p> 	<p>Executes a selected item or function.</p>									

## 34-Keys Numeric Keypad

The 34-key keypad contains a **Power** button, application keys, scroll keys and a function key. The keypad is color-coded to indicate the alternate function key (blue) values and the alternate Shift key values. Note that keypad functions can be changed by an application so the MC93XX's keypad may not function exactly as described. See the Key Descriptions table for key and button details.

Figure 142 34-Keys Numeric Keypad

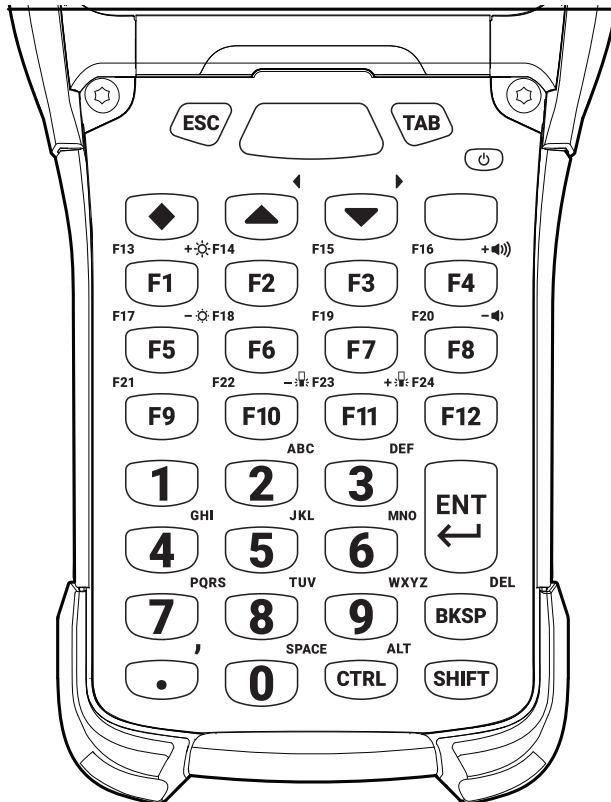

Table 22 34-Keys Descriptions





















Key	Description												
Power (red) 	Turns the device on and off. Performs a warm boot and a hard reset. See Resetting the Device for more information.												
Diamond 	Provides a 3x3 matrix on the screen with nine additional symbols. With a single tap you can select via touch input or the keyboard, 1-9 numerical keys. Double tapping the Diamond key locks the 3x3 grid, and you can select multiple keys. Pressing the Diamond key a third time closes the 3x3 matrix. You can modify the symbols in the 3x3 matrix using the StageNow utility in the KeyMappingMgr settings.  <table border="1" style="margin-left: auto; margin-right: auto; border-collapse: collapse; text-align: center;"> <tr> <td style="padding: 2px 5px;">1</td> <td style="padding: 2px 5px;">2</td> <td style="padding: 2px 5px;">3</td> </tr> <tr> <td style="padding: 2px 5px;"> </td> <td style="padding: 2px 5px;">[</td> <td style="padding: 2px 5px;">]</td> </tr> <tr> <td style="padding: 2px 5px;">£</td> <td style="padding: 2px 5px;">:</td> <td style="padding: 2px 5px;">€</td> </tr> <tr> <td style="padding: 2px 5px;">~</td> <td style="padding: 2px 5px;">@</td> <td style="padding: 2px 5px;">-</td> </tr> </table> <p><b>NOTE:</b> This is the default symbol layout for this keyboard.</p>	1	2	3		[	]	£	:	€	~	@	-
1	2	3											
	[	]											
£	:	€											
~	@	-											
ESC 	Exits the current operation.												
TAB 	Tab function.												
Scan (yellow) 	Activates the scanner/imager in a scan enabled application.												
Up and Down 	Moves up and down from one item to another.												
BKSP 	Space and backspace functions.												
Application 	The numeric keys generate keycodes 0 to 9.												

Table 22 34-Keys Descriptions (Continued)

Key	Description
Function (blue) 	<p>Press and release the blue function key to activate the keypad alternate functions (shown on the keypad in Blue). Press the Blue function key once to put the keyboard into one-shot mode. The  icon appears on the Status bar. Press the Blue function key again the keypad is locked in function mode, and the  icon appears in the Status bar. Press and release the Blue function key a third time to return to the default keypad functions, and the  icon clears.</p> <p>Press the Blue key followed by the CTRL key to activate the keypad alternate ALT functions. The  icon appears in the status bar.</p> <p>Press the blue function key and SHIFT to activate CAPSLOCK mode, the  icon appears.</p>
CTRL 	<p>Press and release the CTRL key to activate the keypad alternate CTRL functions. The  icon appears in the status bars.</p>
Shift 	<p>Press and release the SHIFT key to activate the keypad alternate SHIFT functions. The  icon appears in the status bar. After pressing another key, the keypad returns to the non-shift state.</p> <p>Press and release the SHIFT key twice to enable the Shift Lock state. The  icon appears in the status bar. Press and release the SHIFT key again to disable the Shift Lock state.</p>
Period/Decimal Point 	<p>Produces a period for alpha entries and a decimal point for numeric entries.</p>
ENT 	<p>Executes a selected item or function.</p>

## 29-Keys Shifted Alpha Keypad

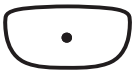
The 29-key keypad contains a **Power** button, application keys, scroll keys and a function key. Note that keypad functions can be changed by an application so the MC93XX's keypad may not function exactly as described. See the Key Descriptions table for key and button details, and the Keypad Special Functions table for the keypad's various functions.

Figure 143 29-Keys Keypad

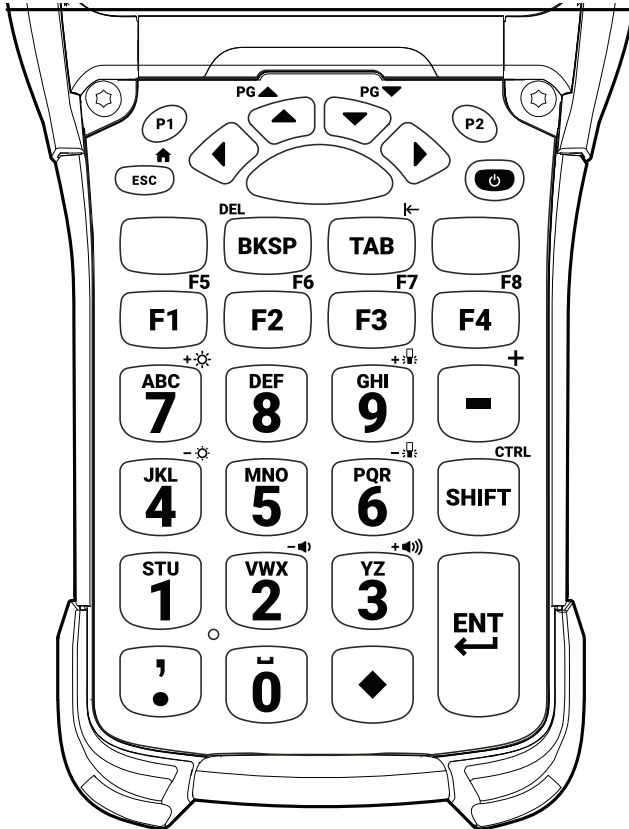





Table 23 29-Keys Descriptions

Key	Description
Power (red) 	Turns the device on and off. Performs a warm boot and a hard reset. See Resetting the Device for more information.
P1/P2 	User programmable keys: <ul style="list-style-type: none"> <li>• By default, P1 is the dedicated PTT key.</li> <li>• By default, P2 acts like another Scan key.</li> </ul>
Scan (yellow) 	Activates the scanner/imager in a scan enabled application.
Up and Down 	Moves up and down from one item to another.



## Keypads

Table 23 29-Keys Descriptions (Continued)





















Key	Description
Left and Right 	Moves left and right from one item to another.
ESC 	Exits the current operation.
Shift 	<p>Press and release the SHIFT key to activate the keypad alternate SHIFT functions. The  icon appears in the status bar. After pressing another key, the keypad returns to the non-shift state.</p> <p>Press and release the SHIFT key twice to enable the Shift Lock state. The  icon appears in the status bar. Press and release the SHIFT key again to disable the Shift Lock state.</p>
BKSP 	Backspace function.
TAB 	Tab function.
Application 	The numeric keys generate keycodes 0 to 9.
Application 	The application keys.
Function (Blue) 	<p>Press and release the blue function key to activate the keypad alternate functions (shown on the keypad in Blue). Press the Blue function key once to put the keyboard into one-shot mode. The  icon appears on the Status bar. Press the Blue function key again the keypad is locked in function mode, and the  icon appears in the Status bar. Press and release the Blue function key a third time to return to the default keypad functions, and the  icon clears.</p> <p>Press the blue function key and SHIFT to activate CAPSLOCK mode, the  icon appears.</p>
Function (Orange) 	<p>Press and release the blue function key to activate the alpha key functions (shown on the keypad in Orange).</p> <p>Press and release the Orange function key to activate the keypad alternate functions (shown on the keypad in Orange). Press the Orange function key once to put the keyboard into one-shot mode. The  icon appears on the Status bar. Press the Orange function key again the keypad is locked in function mode, and the  icon appears in the Status bar. Press and release the Orange function key a third time to return to the default keypad functions, and the  icon clears.</p>







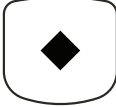
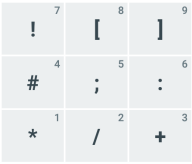

Table 23 29-Keys Descriptions (Continued)

Key	Description
Period/Decimal Point 	Produces a period for alpha entries and a decimal point for numeric entries.
Diamond 	Provides a 3x3 matrix on the screen with nine additional symbols. With a single tap you can select via touch input or the keyboard, 1-9 numerical keys. Double tapping the Diamond key locks the 3x3 grid, and you can select multiple keys. Pressing the Diamond key a third time closes the 3x3 matrix. You can modify the symbols in the 3x3 matrix using the StageNow utility in the KeyMappingMgr settings.   <p><b>NOTE:</b> This is the default symbol layout for this keyboard.</p>
Enter 	Executes a selected item or function.

## Keypad Special Functions

The keypad special functions are color coded on the keypads. For example, on the 53-key keypad, the display backlight icon is blue indicating that the blue function key must be selected first to access the display backlight.

Table 24 Keypad Special Functions

Icon	Special Function	58 Key (Omni XT15f)	53 Key (Standard, 5250, 3270, VT)	43 Key	34 Key (Omni XT15f)	29 Key
	Decreases the keyboard backlight intensity.	Blue key+Y	Blue key + X	Keylight+Down	Blue key+F10	Blue key+7
	Increases the keypad backlight intensity.	Blue key+Z	Blue key + Y	Keylight+Up	Blue key+F11	Blue key+9
	Increases display backlight intensity.	Blue key+N	Blue key + D	Blue key+F1	Blue key+F1	Blue key+7
	Decreases display backlight intensity.	Blue key+M	Blue key + I	Blue key+F5	Blue key+F5	Blue key+4
	Increases overall system volume.	Blue key+R	Blue key + H	Blue key+F4	Blue key+F4	Blue key+3
	Decreases overall system volume.	Blue key+Q	Blue key + M	Blue key+F8	Blue key+F8	Blue key+2
<b>ALT</b>	Enables Alt keypad functions.  <b>NOTE:</b> Only applicable if the Large Key Indicator is enabled.	Blue key+CTRL	Blue key + CTRL	ALT	Blue key+CTRL	
	Caps Lock	Blue key+SHIFT	BLUE + SHIFT	Blue key+SHIFT	Blue key SHIFT	
	Sends TAB character (forward tab).	TAB	Blue key + Space	Blue key+SPACE	TAB	TAB



**NOTE:** Use of display and keypad backlighting can significantly reduce battery life.

## Special Characters

The keypads can be selected as necessary to support specialized applications. The keypads contain a **Power** button, application keys, scroll keys and function keys. The keypad is color-coded to indicate the alternate function key (blue/orange) values. The following table details special character generation. Characters can also be generated using the keyboard input panel.



**NOTE:** Shift-1 through Shift-0 only applies to the Standard 53-key keyboard. On the 5250, 3270, and VT 53-key keyboards the Shift + <num> combinations generate F11-F20 keys.

Table 25 Special Character Generation Map

Special Character	58 Key (Omni XT15f)	53 Key (Standard, 5250, 3270, VT)	43 Key	34 Key (Omni XT15f)	29 Key
[ (open square bracket)	Diamond+2	Blue Key+E	Diamond+8	Diamond+2	Diamond+8
] (close square bracket)	Diamond+3	Blue Key+F	Diamond+9	Diamond+3	Diamond+9
/ (forward slash)	Not Applicable	Blue Key+V	Blue Key+F12	Not Applicable	Blue Key+8
\ (backslash)	Not Applicable	Blue Key+G	Not Applicable	Not Applicable	Not Applicable
= (equal sign)	Not Applicable	Blue Key+W	Blue Key+Bksp	Not Applicable	Blue Key+5
; (semi-colon)	Not Applicable	Blue Key+R	Not Applicable	Not Applicable	Diamond+5
` (apostrophe)	Not Applicable	Blue Key+J	Not Applicable	Not Applicable	Not Applicable
, (comma)	Shift+. (Dot)	Blue Key+A	Not Applicable	Blue Key+. (Dot)	Not Applicable
. (period)	Dot	Blue Key+B	Not Applicable	Dot	Not Applicable
! (exclamation sign)	Shift+1	Shift+1	Shift+1	Shift+1	Shift+1
@ (at sign)	Shift+2	Shift+2	Shift+2	Shift+2	Shift+2
# (pound sign)	Shift+3	Shift+3	Shift+3	Shift+3	Shift+3
\$ (dollar sign)	Shift+4	Shift+4	Shift+4	Shift+4	Shift+4
% (percent sign)	Shift+5	Shift+5	Shift+5	Shift+5	Shift+5
^ (carat)	Shift+6	Shift+6	Shift+6	Shift+6	Shift+6
& (ampersand)	Shift+7	Shift+7	Shift+7	Shift+7	Shift+7
* (asterisk)	Shift+8	Blue Key+U Shift+8	Blue Key+F11, Shift+8	Shift+8	Shift+8
( (open parenthesis)	Shift+9	Shift+9	Shift+9	Shift+9	Shift+9

## Keypads

Table 25 Special Character Generation Map (Continued)

Special Character	58 Key (Omni XT15f)	53 Key (Standard, 5250, 3270, VT)	43 Key	34 Key (Omni XT15f)	29 Key
) (close parenthesis)	Shift+0	Shift+0	Shift+0	Shift+0	Shift+0
' (single quote)	Not Applicable	Blue Key+C	Not Applicable	Not Applicable	Not Applicable
" (double quote)	Not Applicable	Shift+Blue Key+C	Not Applicable	Not Applicable	Not Applicable
+ (plus sign)	Not Applicable	Blue Key+S	Blue Key+F9	Not Applicable	Orange Key+ - (Minus)
- (dash)	Not Applicable	Blue Key+N, Blue Key+T	Blue Key+F10	Not Applicable	Minus key
: (colon)	Diamond+5	Shift+Blue Key+R	Diamond+5	Diamond+5	Diamond+6
< (less than sign)	Shift+Blue Key+. (Dot)	Shift+Blue Key+A	Not Applicable	Shift + Blue Key+. (Dot)	Shift+ Orange Key+ . (Dot)
> (greater than sign)	Shift+. (Dot)	Shift+Blue Key+B	Shift+. (Dot)	Shift+. (Dot)	Shift+. (Dot)
? (question mark)	Not Applicable	Shift+Blue Key+V	Shift+Blue Key+F12	Not Applicable	Shift +Blue Key+8
_ (underscore)	Diamond+9	Shift+Blue Key+N	Diamond+3	Diamond+9	Shift + - (Minus)
{ (open curly bracket)	Not Applicable	Shift+Blue Key+E	Not Applicable	Not Applicable	Not Applicable
} (close curly bracket)	Not Applicable	Shift+Blue Key+F	Not Applicable	Not Applicable	Not Applicable
~ (tilde)	Diamond+7	Shift+Blue Key+J	Diamond+1	Diamond+7	Not Applicable
(pipe)	Diamond+1	Shift+Blue Key+G	Diamond+7	Diamond+1	Not Applicable

# Index

## Numerics

16-slot spare battery charger	134
29 keys keypad	184
3270 emulator keypad	172
34 keys numeric keypad	181
43 keys shifted alpha keypad	178
4-slot spare battery charger	133
5250 emulator keypad	169
53-key standard keypad	166
58-key alpha numeric function keypad	163
5-slot ethernet cradle	131

## A

accessories	123
adaptive frequency hopping	116
alarms only	52
albums	79
deleting	80
sharing	80
working with albums	79
ambient display setting	33
approved cleanser	149
approved cleanser active ingredients	149
apps	54
accessing	57
adding shortcuts	46
battery manager	64
camera	72
datawedge demonstration	84
device central	97
diagnostic tool	92
files	70
photos	78
PTT Express	86
RxLogger	90
RxLogger Utility	91
shortcuts	46
sound recorder	86

## B

backlight	187
backlight intensity	187
backup power	24
barcode capture	
imager	101
laser scanner	102
barcode scanning	
DS3678 digital scanner	100
integrated imager	99
battery	
monitor usage	28
battery low notification	29
battery management	28
battery level	28
battery present status	28
battery manager	64
battery optimization	29
battery safety guidelines	148
beeper volume	187
bluetooth	114, 116
change name	119
disabling	119
discovering devices	119
enabling	118
headset	120
PIN	117
power states	118
profiles	117
security	117

## C

camera	54, 72
photo settings	75
rear camera photo settings	76
rear camera video settings	77
recording videos	74
taking panoramic photos	74
taking photos	73
video settings	76

- camera settings . . . . . 75, 76
  - cast . . . . . 122
  - change bluetooth name . . . . . 119
  - characters, special . . . . . 188
  - charge only adapter . . . . . 140
  - charging spare batteries . . . . . 24
  - cleaning . . . . . 149, 150
    - battery connectors . . . . . 151
    - camera and exit window . . . . . 151
    - cradle connectors . . . . . 151
    - display . . . . . 150
    - frequency . . . . . 150
    - housing . . . . . 150
    - instructions . . . . . 149
    - materials . . . . . 150
  - cleaning instructions . . . . . 150
  - connect to WLAN . . . . . 114
  - contacts . . . . . 71
    - adding . . . . . 71
    - deleting . . . . . 71
    - editing . . . . . 71
  - cradle
    - connector cleaning . . . . . 151
- D**
- data capture
    - DS3678 digital scanner . . . . . 100
    - integrated imager . . . . . 99
  - datawedge . . . . . 112
    - disable . . . . . 113
    - enable . . . . . 113
  - datawedge demonstration . . . . . 84
  - device central . . . . . 97
    - paging an RS6000 ring scanner . . . . . 98
  - device settings
    - accessing . . . . . 28
  - diagnostic tool . . . . . 92
    - battery test information . . . . . 95
    - bluetooth test information . . . . . 96
    - gps test information . . . . . 96
    - settings . . . . . 95
    - system test information . . . . . 96
    - wlan test information . . . . . 96
    - wwan test information . . . . . 96
  - disable bluetooth . . . . . 119
  - disconnect host computer . . . . . 63
  - discover bluetooth devices . . . . . 119
  - display backlight intensity . . . . . 187
  - display settings . . . . . 30
  - display size . . . . . 32
  - do not disturb feature . . . . . 51
  - DS3678
    - pairing . . . . . 111
    - pairing using Bluetooth HID . . . . . 111
    - scanning . . . . . 106
  - DS3678 digital scanner
    - barcode scanning . . . . . 100
    - data capture . . . . . 100
- E**
- EAP . . . . . 114
  - enable bluetooth . . . . . 118
- F**
- features
    - MC93XX . . . . . 16
  - file transfer . . . . . 62
  - files . . . . . 70
  - finger usage . . . . . 33
  - folders . . . . . 47
    - creating . . . . . 47
    - naming . . . . . 47
    - removing . . . . . 48
  - font size . . . . . 31
- G**
- general sound setting . . . . . 35
  - google
    - account setup . . . . . 24
    - mobile services . . . . . 38
- H**
- hand strap . . . . . 145
  - hard reset . . . . . 62
  - harmful ingredients . . . . . 149
  - home screen . . . . . 38
    - moving items . . . . . 47
    - rotation . . . . . 39
  - home screen wallpaper . . . . . 48
  - hot swap mode . . . . . 27
- I**
- install microSD card . . . . . 19
  - integrated imager
    - barcode scanning . . . . . 99
    - data capture . . . . . 99
    - operational modes . . . . . 99
- K**
- key descriptions
    - 29 shifted alpha . . . . . 184
    - 34 keys . . . . . 182
    - 43 shifted alpha . . . . . 178

## Index

- 53-key ..... 166
- 58-key ..... 163
- IBM-32700 ..... 172
- IBM-5250 ..... 170
- special functions ..... 187
- VT ..... 175
- keyboards ..... 49
  - additional character tab ..... 50
  - alpha tab ..... 50
  - configuration ..... 49
  - numeric tab ..... 50
- keypads
  - 29 keys ..... 184
  - 3270 emulator ..... 172
  - 34 keys numeric ..... 181
  - 43 keys shifted alpha ..... 178
  - 5250 emulator ..... 169
  - 53-key ..... 166
  - 58-key ..... 163
  - special functions ..... 187
  - types ..... 159
  - VT emulator ..... 175
- L**
- laser scanner ..... 100
- lock screen notifications ..... 44
- M**
- maintenance ..... 148
  - approved cleanser active ingredients ..... 149
  - battery safety guidelines ..... 148
  - clean battery connectors ..... 151
  - clean camera and exit window ..... 151
  - clean cradle connectors ..... 151
  - clean display ..... 150
  - clean housing ..... 150
  - cleaning frequency ..... 150
  - cleaning instructions ..... 149
  - cleaning materials required ..... 150
  - device cleaning instructions ..... 150
  - harmful ingredients ..... 149
  - maintaining the device ..... 148
  - special cleaning notes ..... 150
- managing notifications ..... 42
- MC93XX
  - features ..... 16
- monitor battery usage ..... 28
- N**
- near field communications ..... 120
- NFC ..... 120
  - reading cards ..... 121
- sharing information ..... 122
- notational conventions ..... 12
- notification icons ..... 42
- notifications
  - lock screen ..... 44
  - managing ..... 42
  - priority notifications only ..... 52
- O**
- operational modes
  - decode mode ..... 99
  - pick list mode ..... 99
- P**
- pairing
  - DS3678 ..... 111
  - RS507/RS6000 hands-free imager ..... 107
  - using Bluetooth HID (RS507/RS6000) ..... 110
  - using Bluetooth HID(DS3678) ..... 111
  - using simple serial interface(RS507/RS6000) ..... 109
- panoramic ..... 74
- photo transfer ..... 63
- photos ..... 78
  - camera settings ..... 75
  - cropping ..... 81
  - deleting ..... 83
  - deleting albums ..... 80
  - deleting videos ..... 83
  - panoramic ..... 74
  - setting as contact icons ..... 82
  - sharing ..... 82
  - sharing albums ..... 80
  - sharing videos ..... 83
  - taking ..... 73
  - viewing and browsing ..... 81
  - watching videos ..... 83
  - working with albums ..... 79
  - working with photos ..... 81
  - working with videos ..... 83
- PTT Express
  - audible indicators ..... 87
  - disabling communication ..... 89
  - enabling communication ..... 87
  - group calls ..... 88
  - notification icons ..... 87
  - private response ..... 88
  - talk groups ..... 88
  - Voice Client ..... 86
- PTT-Express
  - PTT communication ..... 88



## Q

quick access panel	44
quick settings	
edit icons	45

## R

reading NFC cards	121
remove wi-fi	116
replacing battery	25
reset device	61
hard reset	62
soft reset	62
RS507	
scanning	103
RS507 hands-free imager	100
RS507 scanning	103, 106
RS507/RS6000	
pairing	107
pairing using Bluetooth HID	110
pairing using simple serial interface	109
RS6000	
bluetooth ring scanner	100
scanning	105
RS6000 scanning	105
rubber boot	143
RxLogger	90
RxLogger Utility	91

## S

scanning	
considerations	101
DS3678	106
RS507	103
RS6000	105
screen font size	31
screen rotation	31
security	114
sensors	156
setting	
camera	75, 76
notification LED	35
wakeup sources	36
settings	
accessing	28
ambient display	33
camera photos	75
camera videos	76
display	30
do not disturb	51
general sound	35
home screen wallpaper	48
limit sounds and vibrations	51

override do not disturb for specific apps	54
priority notifications only	52
setup	19
sharing information using NFC	122
soft reset	62
software version	12
software versions	11
sound recorder	86
special characters	188
status bar	40

## T

taking a panoramic photo	74
touch mode	33
transferring files using USB	62
troubleshooting	152

## U

USB	62
-----	----

## V

videos	
camera settings	76
deleting	83
recording	74
sharing	83
watching	83
working with videos	83
volume	187
VT emulator keypad	175

## W

wakeup sources	36
WEP	114
widgets	46
adding	46
wi-fi network	114
wireless local area network	114
WLAN	114
WPA	114

