

LENOVO THINKSTATION P920, P720, P520, & P520C

# BROADCOM STORAGE CONFIGURATION



---

## Contents

**OVERVIEW**

**SECTION 1 – STORAGE CONTROLLER DETAILS**

**SECTION 2 – THINKSTATION P920 SUPPORT**

**SECTION 3 – THINKSTATION P720 SUPPORT**

**SECTION 4 – THINKSTATION P520 SUPPORT**

**SECTION 5 – THINKSTATION P520C SUPPORT**

**SECTION 6 – CONFIGURING RAID ARRAYS**

**SECTION 7 – DELETING RAID ARRAYS**

**SECTION 8 - GLOSSARY**

**SECTION 9 – DOCUMENT REVISION HISTORY**

---

## Overview

The purpose of this document is to provide a high-level guidance for users on how to configure their SATA, SAS, and NVMe storage options using one of the optional Broadcom storage controllers in the ThinkStation P520c, P520, P720, and P920. These ThinkStation systems are capable of supporting up to eight SATA and SAS HDDs/SSDs up to 12Gb/s maximum theoretical throughput. It is important to note that SATA, SAS, and NVMe devices are supported with the Broadcom storage controller.

## Section 1 – Storage Controller Details

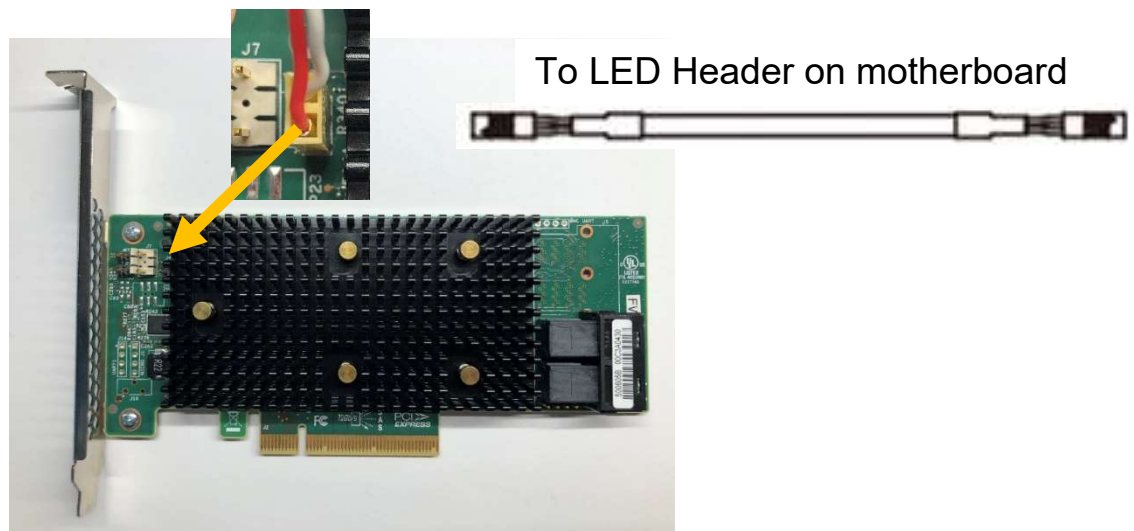

### Broadcom 9440-8i (SAS3408) I/O Controller (IOC) Adapter

Maximum Number of Drives	63 SAS/SATA 4 NVME Up to 32 Virtual Drives
Connection Method	2x Mini-SAS HD x4 SFF-8643 ports HDD LED Cable <sup>1</sup>
Drive Type Supported	3.5" SATA HDD (7200rpm) 2.5" SATA SSD 2.5" SAS HDD 2.5" (U.2) NVME SSD
RAID Level Support	RAID 0 RAID 1 RAID 5 RAID 10
Adapter Speed	PCI Express 3.1 x8 lane Maximum drive throughput is 12Gb/s.

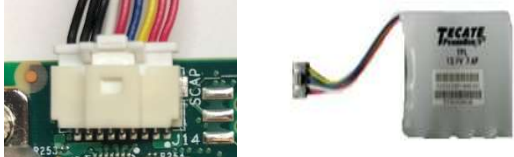

<sup>1</sup> Connects to “J6” on the Broadcom adapter and “LED\_SAS\_HD1” on the motherboard.

## Broadcom 9460-16i (SAS3516) RAID-On-Chip (ROC) Adapter

Maximum Number of Drives	240 SAS/SATA 24 NVME Up to 32 Virtual Drives
Connection Method	4x Mini-SAS HD x4 SFF-8643 ports HDD LED Cable <sup>2</sup>
Drive Type Supported	3.5" SATA HDD (7200rpm) 2.5" SATA SSD 2.5" SAS HDD 2.5" (U.2) NVME SSD
RAID Level Support	RAID 0 RAID 1 RAID 5 RAID 10 RAID 6
Adapter Speed	PCI Express 3.1 x8 lane Maximum drive throughput is 12Gb/s.
Options	Supercap (cache backup battery pack) <ul style="list-style-type: none"> <li>- Cache Memory: 4GB 2133MHz DDR4 SDRAM</li> </ul>  <ul style="list-style-type: none"> <li>- RAID Supercap Holder Kit</li> </ul> 

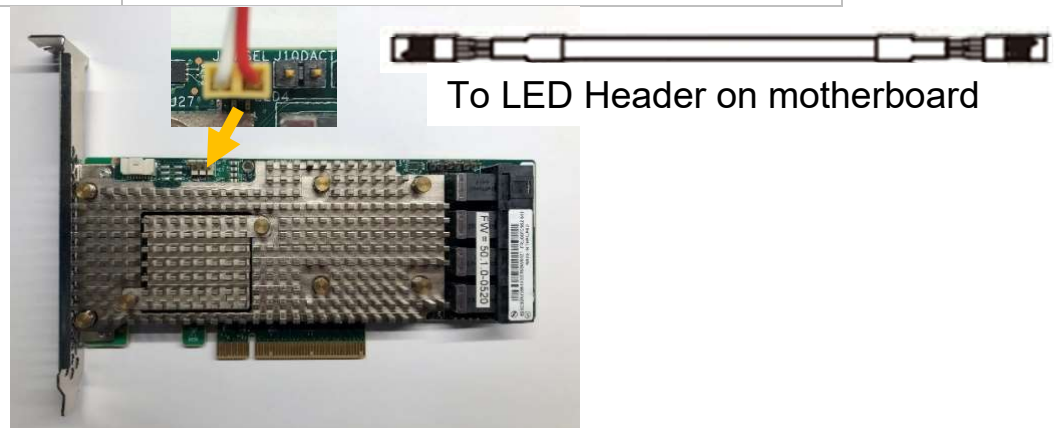

<sup>2</sup> Connects to "J6" on the Broadcom adapter and "LED\_SAS\_HD1" on the motherboard.

---

## Section 2 – ThinkStation P920 Support

### Level of Support Summary

Maximum Number of Drives	8
Connection Method	Tool-less FLEX tray blind-mounted to a backplane (BCA). BCA is standard.
Drive Locations	Drives install into HDD Bays via FLEX Tray.
Hardware Required	BCA-S <sup>3</sup> or BCA-P <sup>4</sup> Blind HDD FLEX Tray Assembly. Broadcom 9440-8i IOC or Broadcom 9460-16i ROC.
Drive Type Supported	3.5" SATA HDD (7200rpm) 2.5" SATA SSD 2.5" SAS HDD 2.5" (U.2) NVME SSD
RAID Level Support	RAID 0 RAID 1 RAID 5 RAID 10 RAID 6 <sup>5</sup>
Drive Speed	Maximum drive throughput is 12Gb/s. Actual data throughput will depend on the drive.

---

<sup>3</sup> BCA-S comes standard in P920.

<sup>4</sup> BCA-P is required for use of U.2 PCIe storage devices.

<sup>5</sup> RAID 6 is only supported on the Broadcom 9460-16i ROC Adapter.

# How to Utilize the Broadcom for SATA/SAS Hard Drives

In the P920 system, drives are always connected through the use of Blind Connect Assemblies (BCA). When using the optional Broadcom storage controller, up to four (4) drives can be connected to each BCA. This gives the P920 support for up to eight (8) drives with the Broadcom storage controller via two BCA's.

All connections on the BCA's are active ports for SATA/SAS using the Broadcom storage controller.

S/X 1 and S/X 2 get connected to S/X 1 and S/X 2 of the Broadcom adapter respectively.

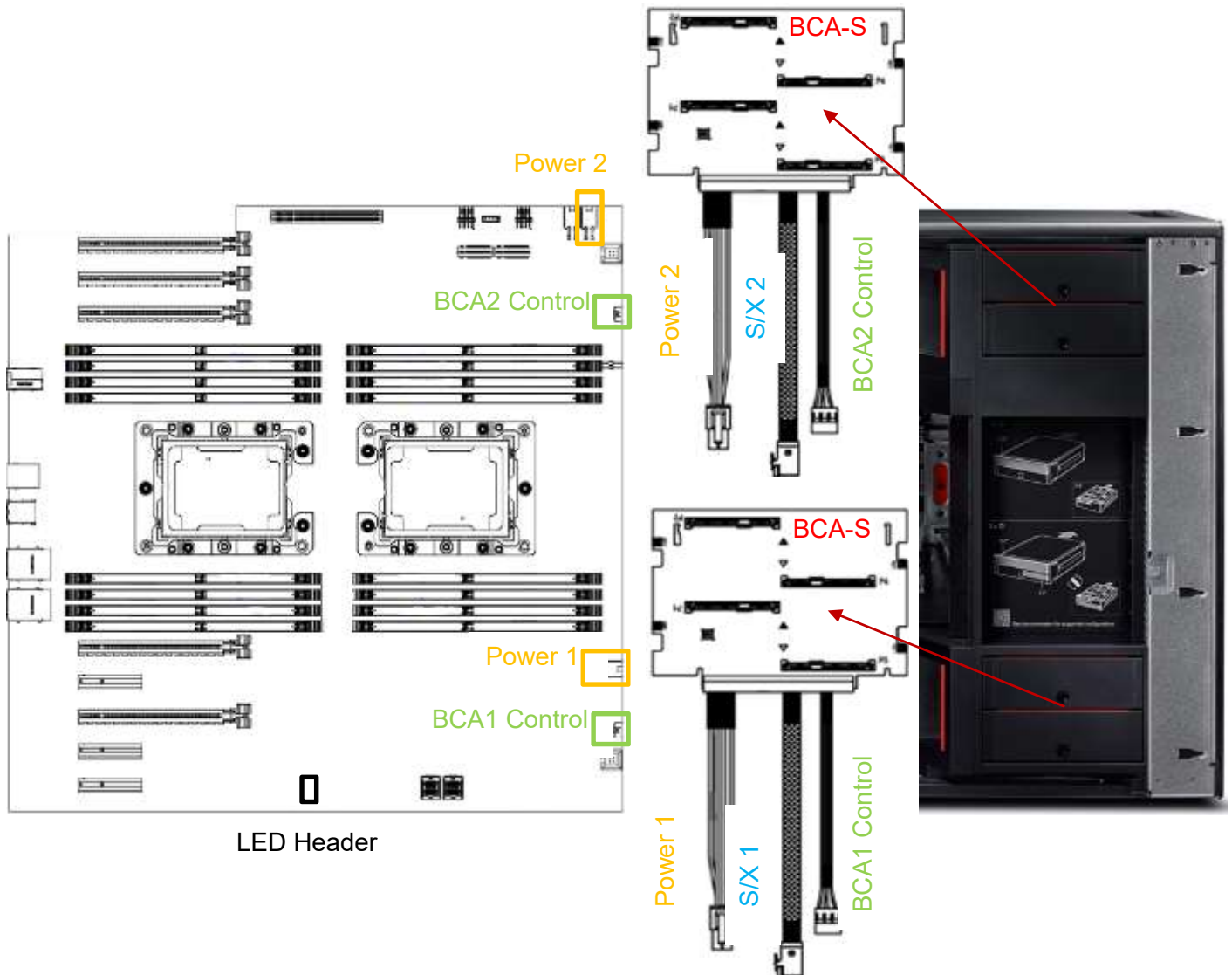

## Section 3 – ThinkStation P720 Support

### Level of Support Summary

<b>Blind Connect Assembly (BCA)</b>	
Maximum Number of Drives	8
Connection Method	Tool-less FLEX tray blind-mounted to a backplane (BCA).
Drive Locations	Drives install into HDD Bays via FLEX Tray.
Hardware Required	Broadcom 9440-8i IOC or Broadcom 9460-16i ROC BCA-S or BCA-P Blind HDD FLEX Tray Assembly
Drive Type Supported	3.5" SATA HDD (7200rpm) 2.5" SATA SSD 2.5" SAS HDD
RAID Level Support	RAID 0 RAID 1 RAID 5 RAID 10 RAID 6 <sup>6</sup>
Drive Speed	Maximum drive throughput is 12Gb/s. Actual data throughput will depend on the drive.
Drive Bay Configuration	0,1,2,3,4 drive bays used → dual BCA-S with 4 blind connect FLEX trays.

<sup>6</sup> RAID 6 is only supported on the Broadcom 9460-16i ROC Adapter.



<b>Manual Connect Option</b>	
Maximum Number of Drives	4
Connection Method	LSI to HDD manual tray cable.
Drive Locations	Drives install into HDD Bays via FLEX Tray. One drive per FLEX tray.
Hardware Required	Broadcom 9440-8i IOC or Broadcom 9460-16i ROC LSI to HDD manual tray cable (see picture below) Manual HDD FLEX Tray Assembly
Drive Type Supported	3.5" SATA HDD (7200rpm) 2.5" SATA SSD 2.5" SAS HDD
RAID Level Support	RAID 0 RAID 1 RAID 5 RAID 10 RAID 6 <sup>7</sup>
Drive Speed	Maximum drive throughput is 12Gb/s. Actual data throughput will depend on the drive.

### LSI to HDD manual tray cable

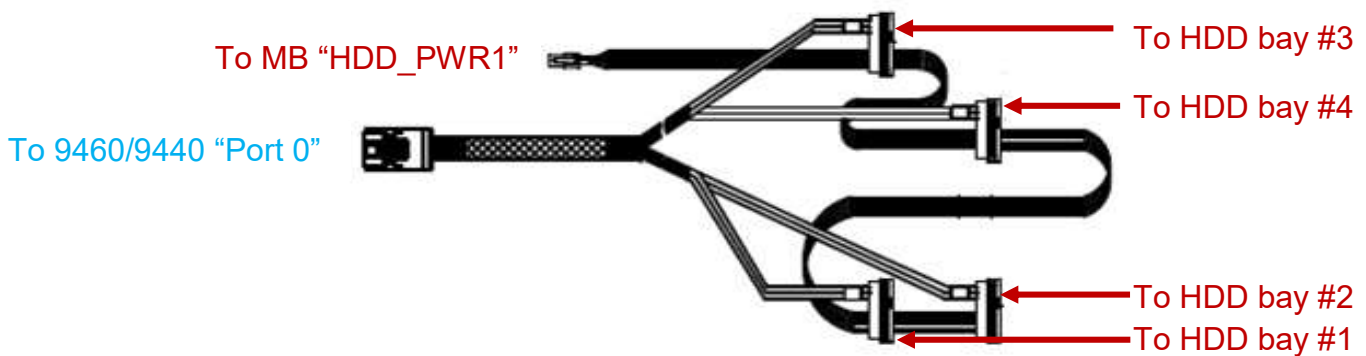

<sup>7</sup> RAID 6 is only supported on the Broadcom 9460-16i ROC Adapter.

# How to Utilize the Broadcom for SATA/SAS Drives

There are two connection methods supported when utilizing the Broadcom storage controllers in the P720. Total drive support varies depending on the connection method with the Broadcom SATA/SAS/NVMe controller.

## Blind Connect Assembly (BCA) Option

All connections on the BCA's are active ports for SATA/SAS using the Broadcom storage controller.

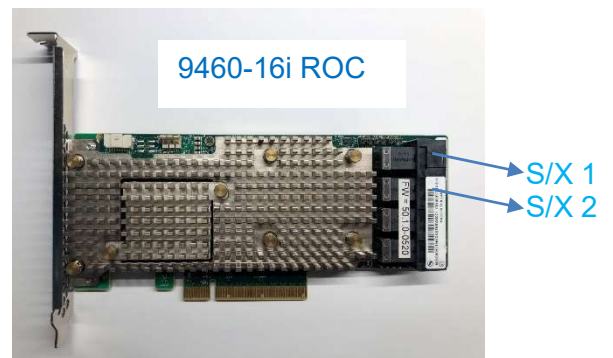
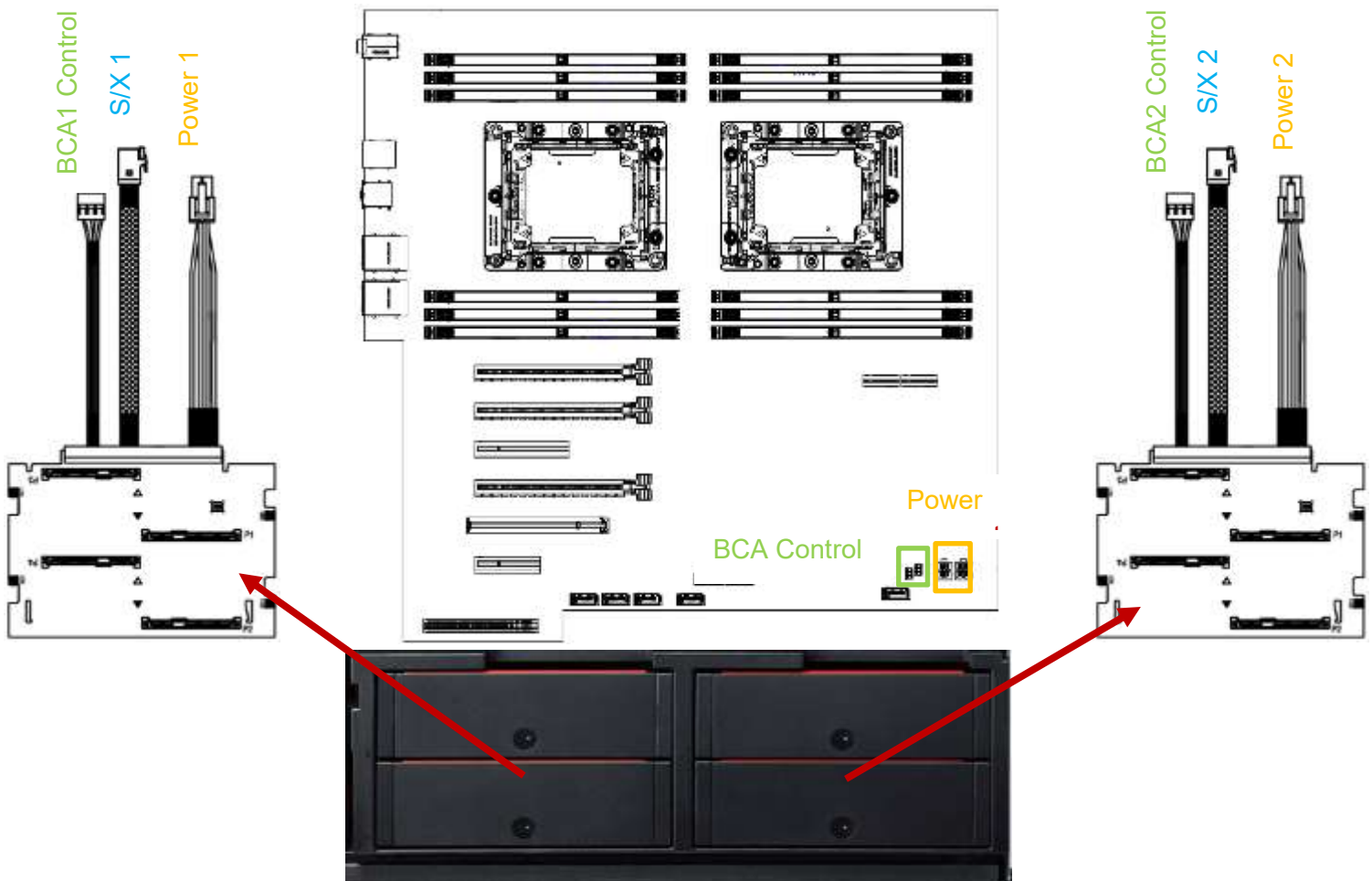

Optionally, in the P720 system, SATA/SAS drives can be connected to the Broadcom SATA/SAS controller via the manual connect method. This consists of using the LSI to HDD manual tray cable. Total drive support with the Broadcom SATA/SAS/NVMe controller using the manual connect method supports up to 4 drives.

### HDD/SSD Manual Connect Option

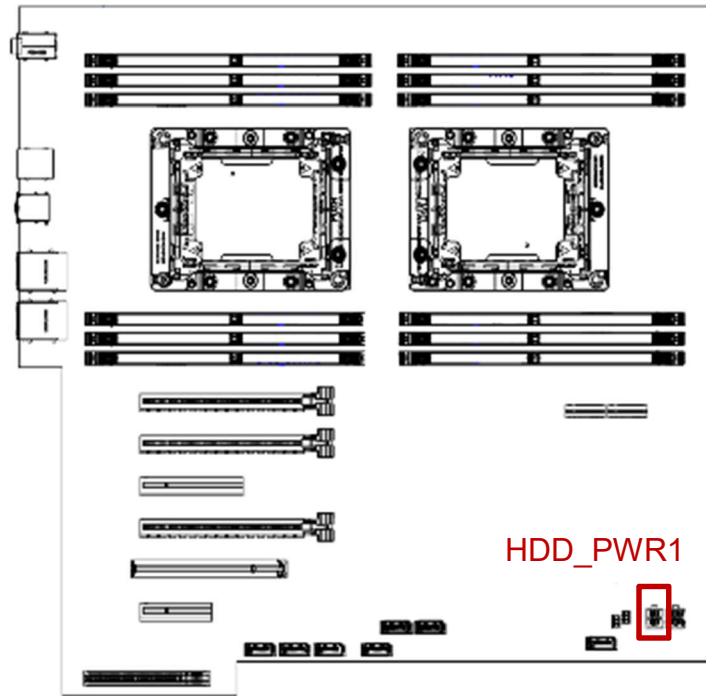

To HDD bay #1  
To HDD bay #2

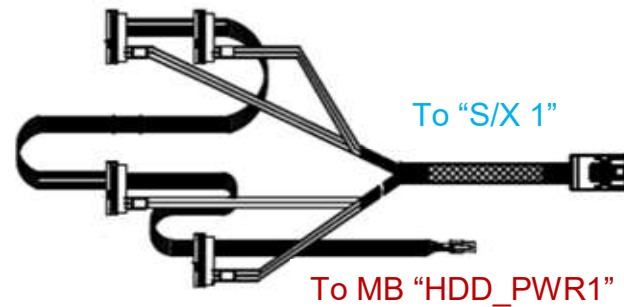
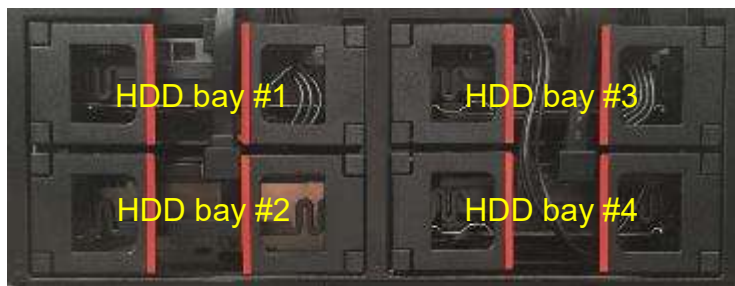

To HDD bay #4  
To HDD bay #3



## Section 4 – ThinkStation P520 Support

### Level of Support Summary

<b>Maximum Number of Drives</b>	4
<b>Connection Method</b>	LSI to HDD manual tray cable.
<b>Drive Locations</b>	Drives install into HDD Bays via FLEX Tray. One drive per FLEX tray.
<b>Hardware Required</b>	Broadcom 9440-8i IOC or Broadcom 9460-16i ROC LSI to HDD manual tray cable (see picture below) Manual HDD FLEX Tray Assembly
<b>Drive Type Supported</b>	3.5" SATA HDD (7200rpm) 2.5" SATA SSD 2.5" SAS HDD
<b>RAID Level Support</b>	RAID 0 RAID 1 RAID 5 RAID 10 RAID 6 <sup>8</sup>
<b>Drive Speed</b>	Maximum drive throughput is 12Gb/s. Actual data throughput will depend on the drive.

LSI to HDD manual tray cable

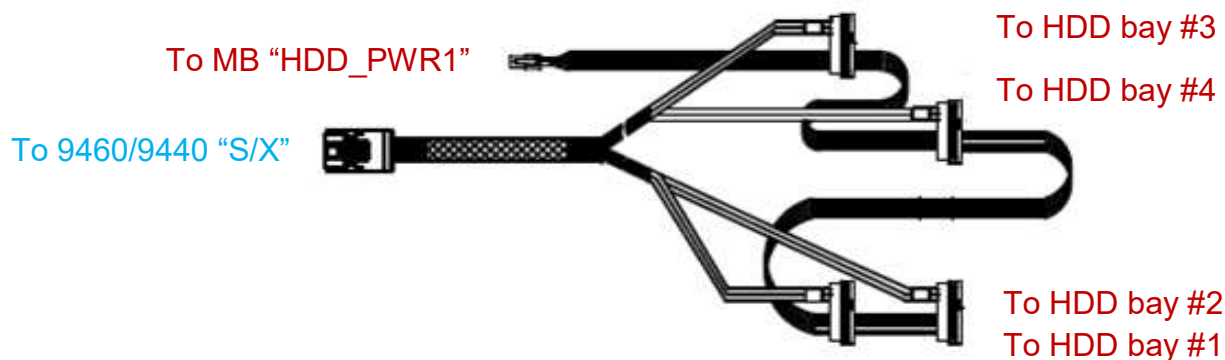

<sup>8</sup> RAID 6 is only supported on the Broadcom 9460-16i ROC Adapter.

# How to Utilize the Broadcom for SATA/SAS Drives

In the P520 system, SATA/SAS drives are connected to the Broadcom SATA/SAS controller via the manual connect method. This consists of manually cabling both power and data to each drive individually. Total drive support with the Broadcom SATA/SAS controller supports up to 4 drives.

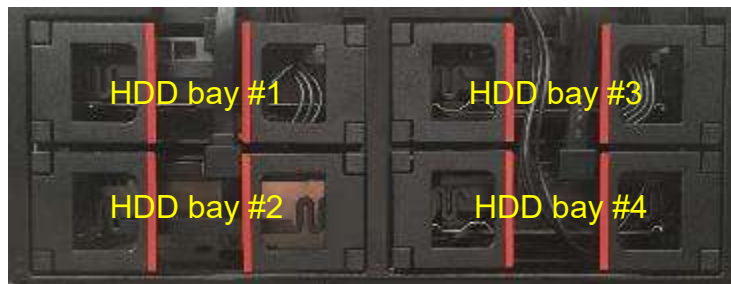
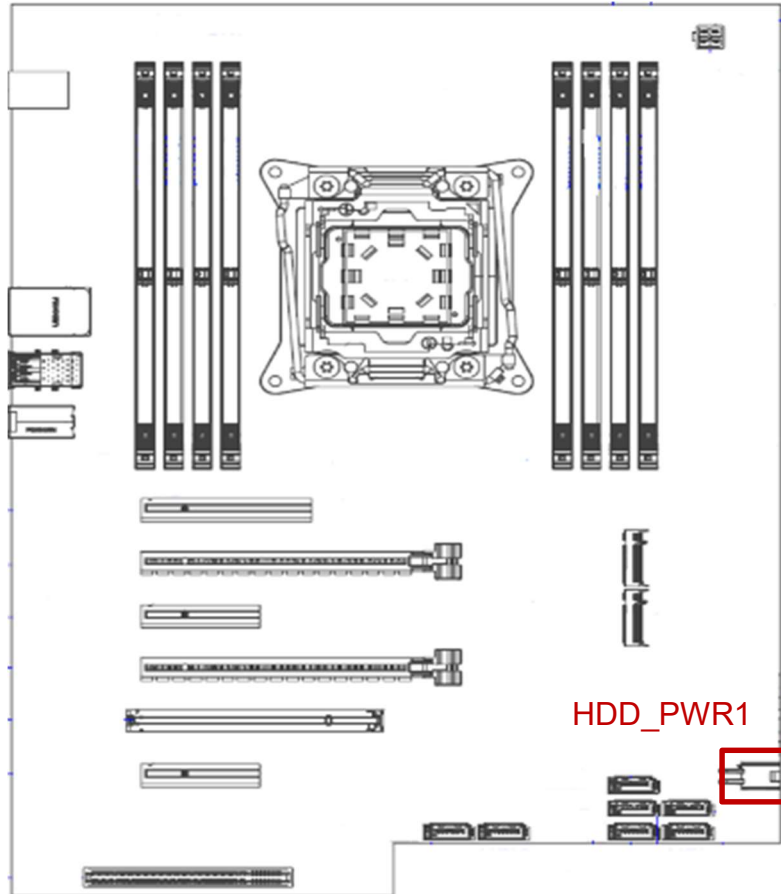

## Section 5 – ThinkStation P520c Support

### Level of Support Summary

<b>Maximum Number of Drives</b>	4
<b>Connection Method</b>	Mini SAS HD to SATA/SAS cable, 4 drops, 750mm
<b>Drive Locations</b>	2 Drives install into HDD Bays via FLEX Tray. 2 Drives install into FLEX Bays. <sup>9</sup>
<b>Flex Bay Options</b>	5.25" Slim ODD and HDD cage
<b>Hardware Required</b>	Broadcom 9440-8i IOC Mini SAS HD to SATA/SAS cable, 4 drops,
<b>Drive Type Supported</b>	3.5" SATA HDD (7200rpm) 2.5" SATA SSD 2.5" SAS HDD
<b>RAID Level Support</b>	RAID 0 RAID 1 RAID 5 RAID 10
<b>Drive Speed</b>	Maximum drive throughput is 12Gb/s. Actual data throughput will depend on the drive.

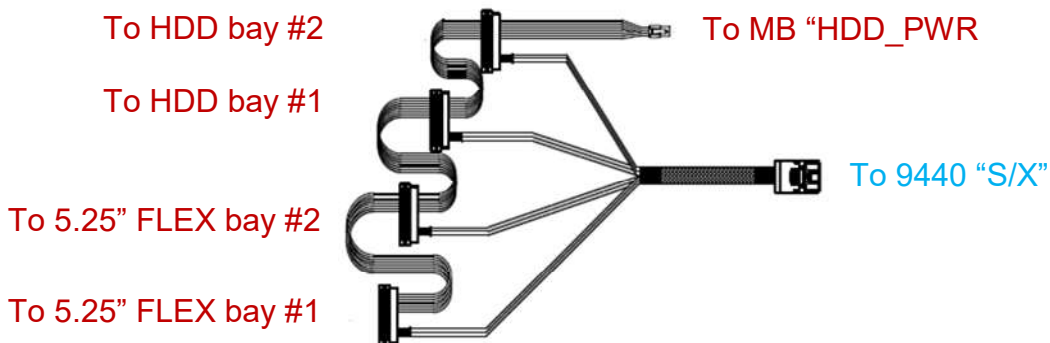

<sup>9</sup> SATA HDD's/SSDs in the FLEX bays need to utilize the 5.25" Slim ODD and HDD cage.

## How to Utilize the Broadcom for SATA/SAS Drives

In the P520c system, SATA/SAS drives are connected to the Broadcom SATA/SAS controller via the manual connect method. This consists of manually cabling both power and data to each drive individually. Total drive support with the Broadcom SATA/SAS controller supports up to 4 drives (2 drives in the HDD bays and 2 drives in the Flex bays).

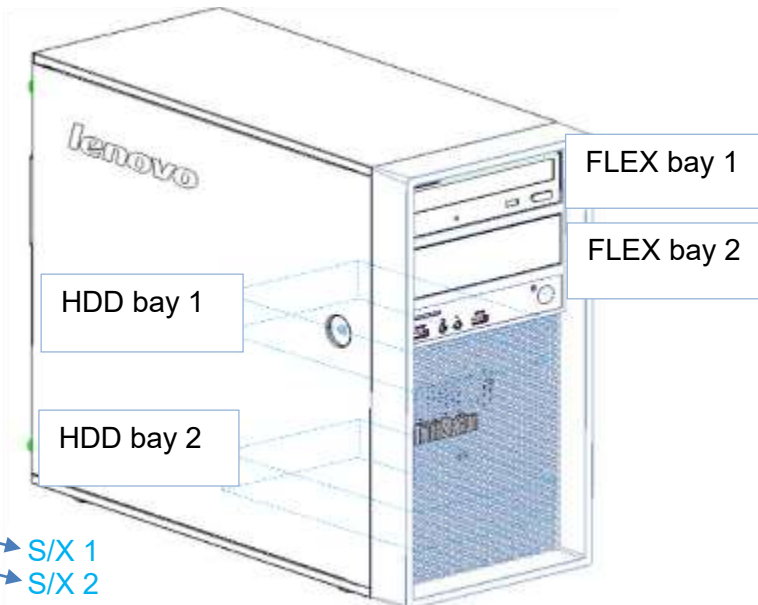
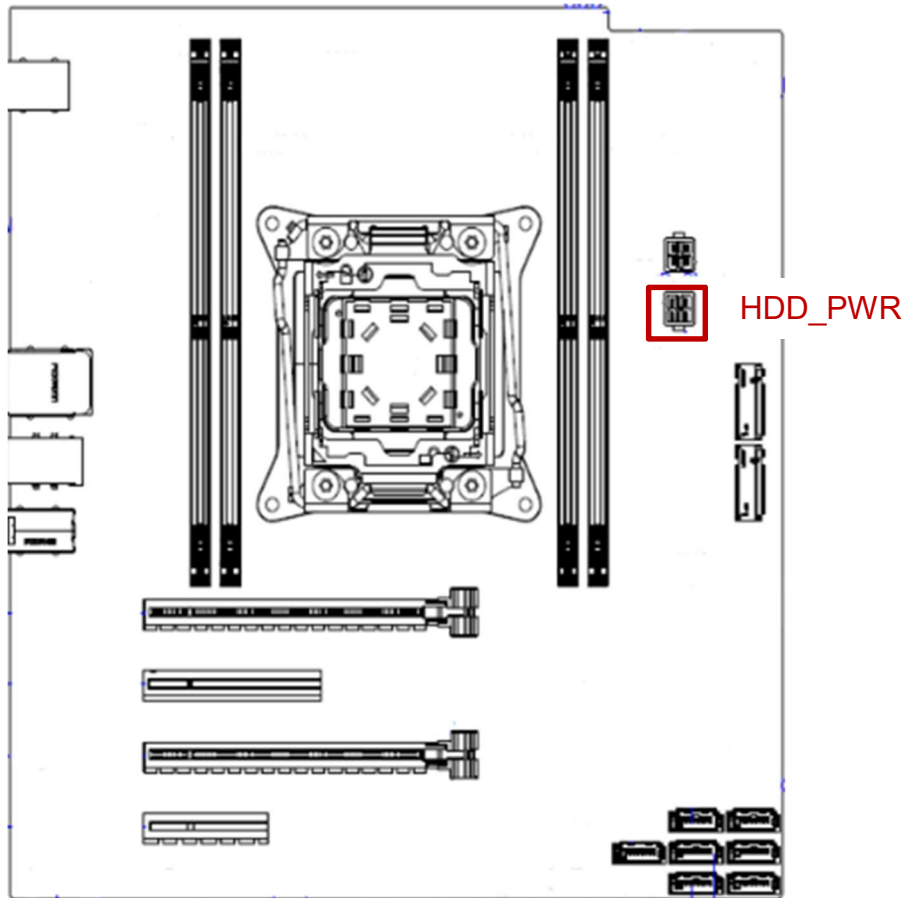

---

## Section 6 – Configuring RAID Arrays

Follow the instructions below to create a basic RAID array using the Broadcom SATA/SAS controller.

1. Install the drives for the RAID array into the system. See the above sections to determine the correct hardware and placement of the storage devices.
2. Power on the system and press the 'F1' function key at the 'Lenovo' splash screen indicated below to enter BIOS.

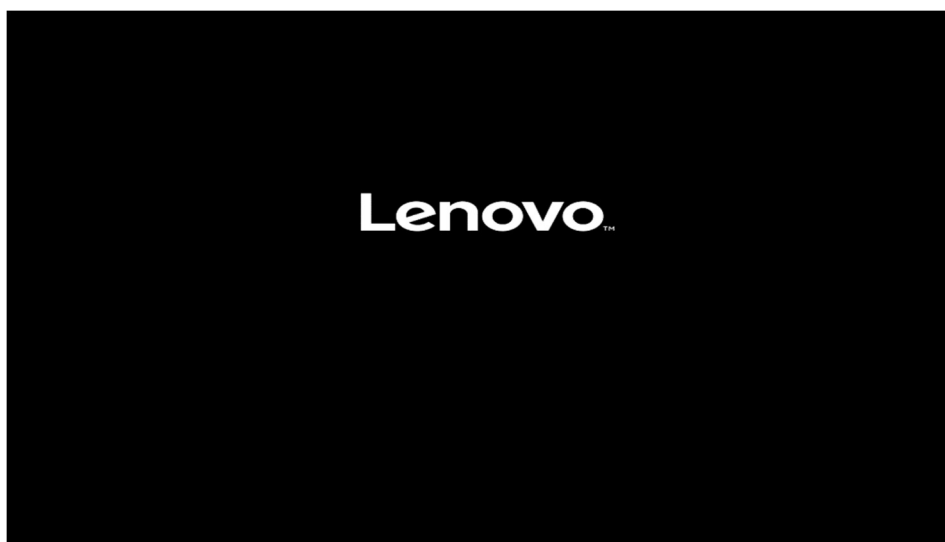

3. Select the "Setup" menu option at the screen indicated below.



Version 1.01 BIOS Copyright (C) 2017 Lenovo or Megalabs, Inc.



- Select the “Advanced” menu (left) and “AVAGO MegaRAID > Configuration Utility” menu (right) at the screen indicated below.



- Select the “Main Menu” option.

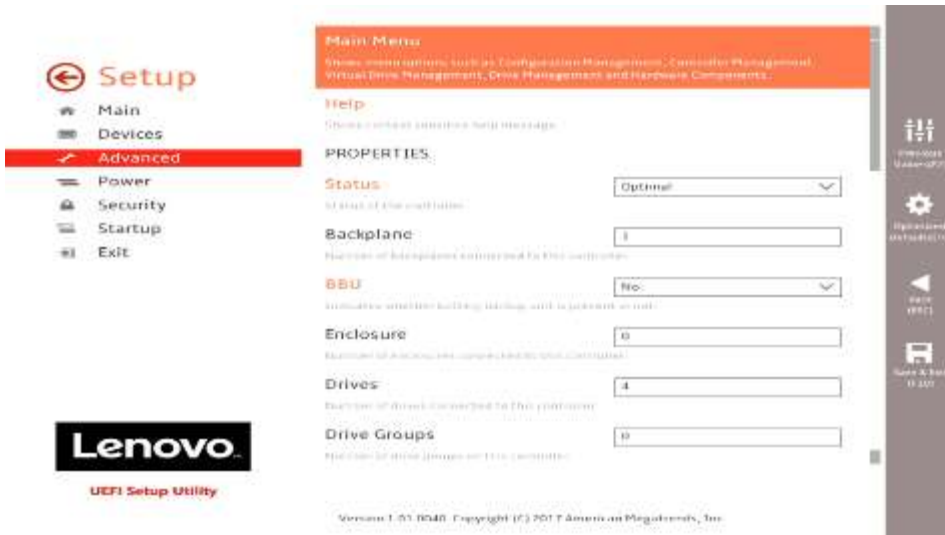

6. Select "Configuration Management".



7. Select "Make Unconfigured Good".



- Select the disks to use in the RAID array that are not listed as “Unconfigured Good” and select “OK”.



- Select the checkbox next to “Confirm” and select “Yes”.

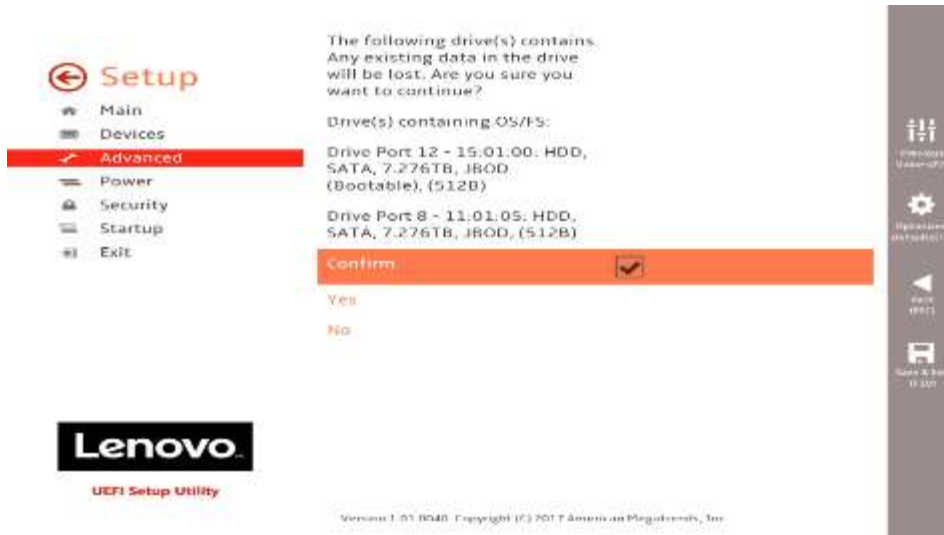

- Select “OK”.



11. Select “Create Virtual Drive”.



12. Select the drop-down menu next to “Select RAID Level” and select the RAID array type to configure.



13. Select on the “Select Drives” option.



14. Select the drop-down menu next to “Select Media Type” and select “Both” to show all drives configured on the Broadcom card.

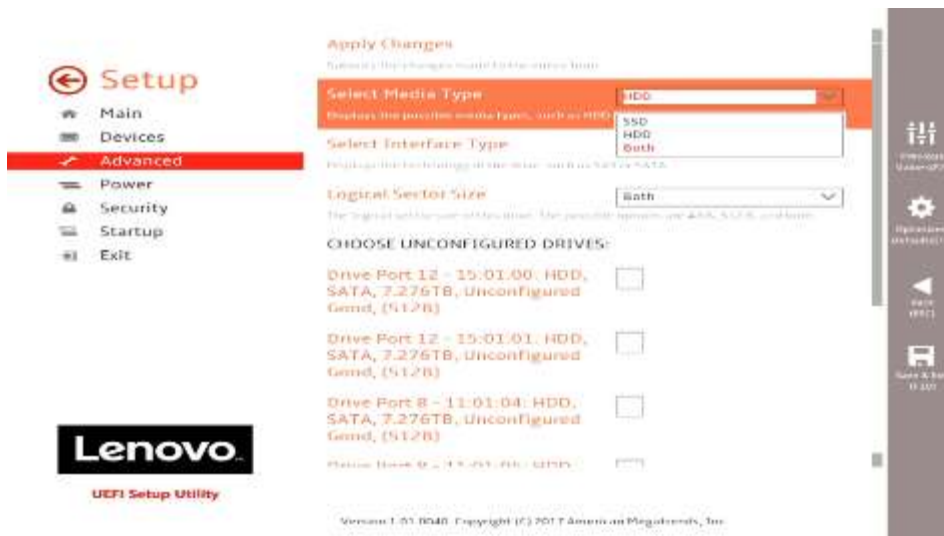

15. Select each drive to use as part of the RAID array and select “Apply Changes”.



16. Select “OK”.



17. Select “Save Configuration”.



18. Select the checkbox next to “Confirm” and select “Yes”.

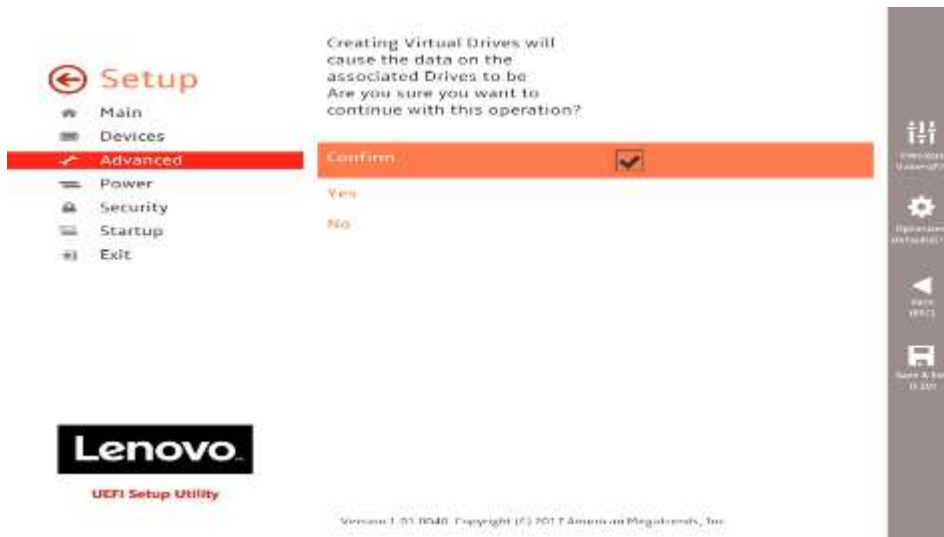

19. Select “OK”.



20. RAID array successfully created screen should look something like this.



21. To view the created RAID array(s), select “Virtual Drive Management”.



22. Select the virtual drive group to view properties.



23. Once finished with creating the RAID array(s), press function 'F10' to 'Save and 'Exit' BIOS.





---

## Section 7 – Deleting RAID Arrays

Follow the instructions below to delete an existing RAID array using the Broadcom SATA/SAS controller.

1. Power on the system and press the 'F1' function key at the 'Lenovo' splash screen indicated below to enter BIOS.

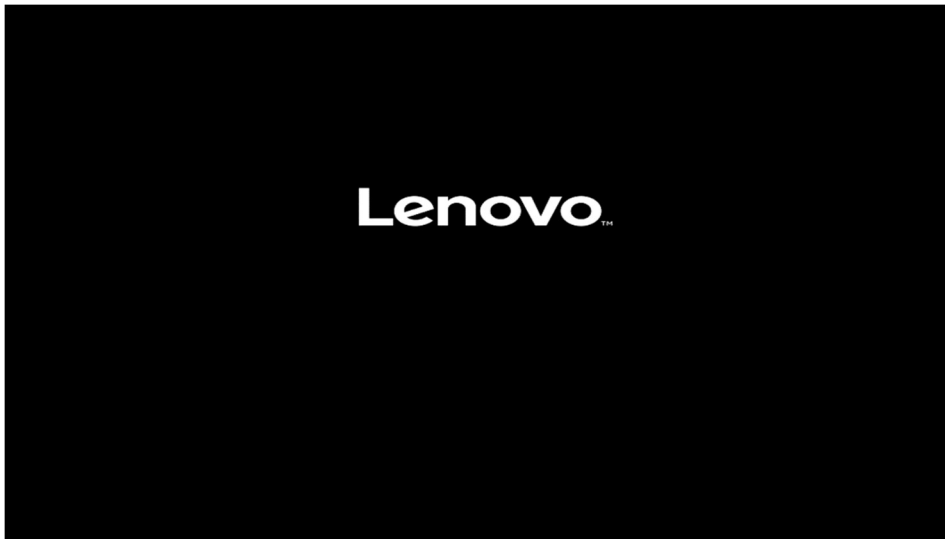

2. Select the "Setup" menu option at the screen indicated below.



3. Select the “Advanced” menu (left) and “AVAGO MegaRAID > Configuration Utility” menu (right) at the screen indicated below.



4. Select the “Main Menu” option.

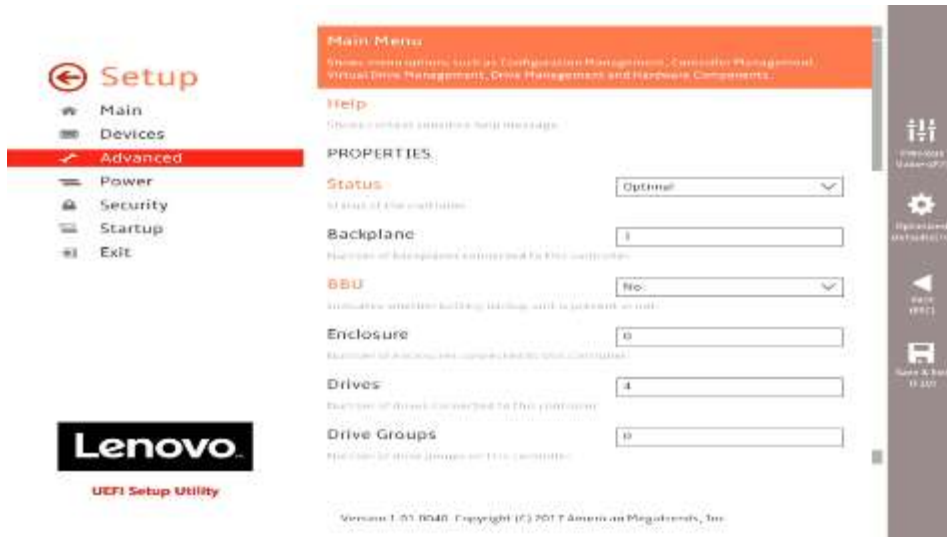

5. Select “Virtual Drive Management”.



24. Select the virtual drive group to view properties.



25. In the virtual drive group properties window, select the dropdown menu next to “Operation” to perform a specific operation on the drive group. One of the options is to delete the virtual drive group.

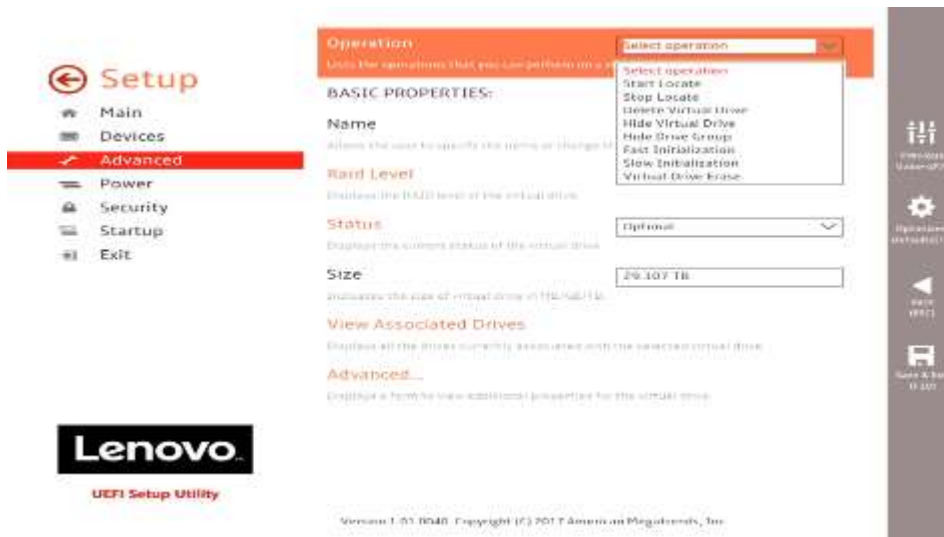

## Section 8 - Glossary

### Blind Connect Assembly (BCA)

**BCA-S:** Blind Connect Assembly consisting of four 8482-SFF ports (supporting SAS and SATA drives). The assembly also contains the following cable connections:

- One 4-pin power connector that connects to the motherboard.
- One mini-SAS HD connector labeled "S/X" that connects to either the onboard Intel controller or the Broadcom controller

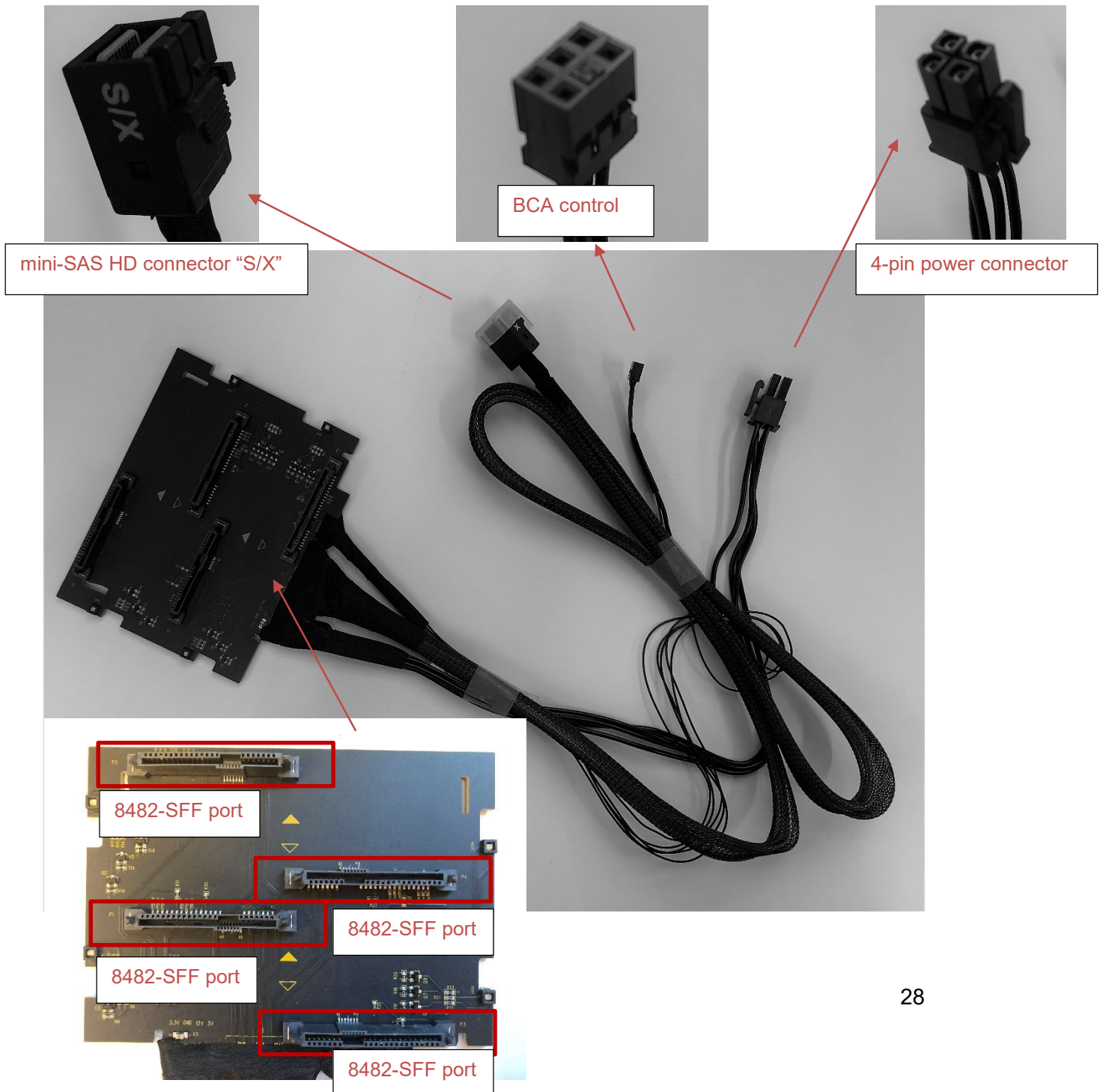

**BCA-P:** Blind Connect Assembly consisting of two 8639-SFF (U.2) ports (supporting PCIe, SAS, or SATA drives) and two 8482-SFF ports (supporting SAS or SATA drives). The assembly also contains the following cable connections:

- One 4-pin power connector that connects to the motherboard.
- Two mini-SAS HD connectors that connect to the Broadcom adapter (for PCIe connections).
- One mini-SAS HD connector labeled “S/X” that connects to either the onboard Intel controller or the Broadcom controller.

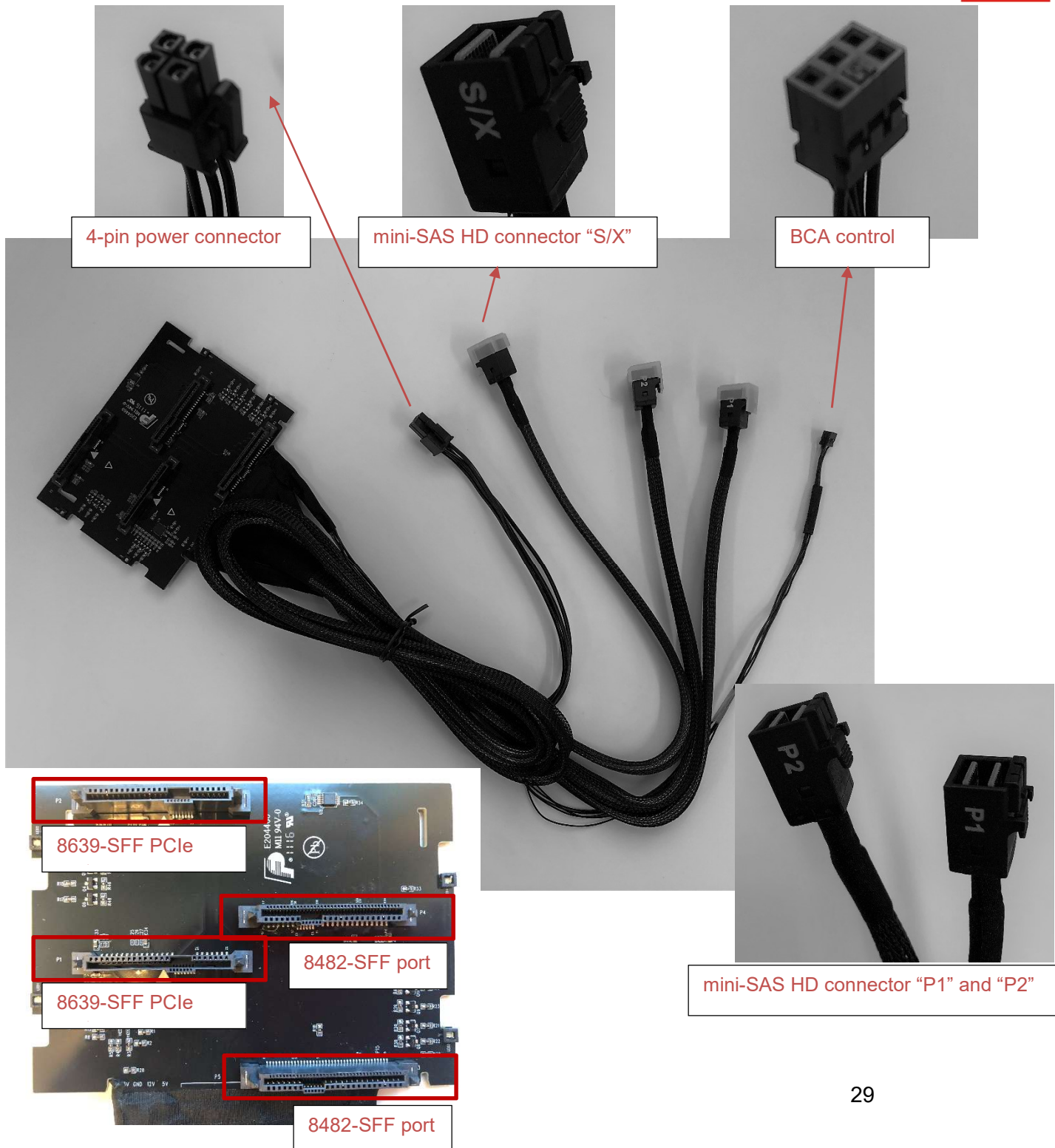

Connector Type	Drives Supported
8639-SFF (U.2) PCIe port	SATA
	SAS (only with Broadcom controller)
	NVMe (U.2 only)
8482-SFF port	SATA
	SAS (only with Broadcom controller)

**FLEX Tray**



Blind Connect FLEX Tray : Tool-less tray that can hold up to two drives and utilizes a “pull-bar” style handle to connect drive(s) to the BCA

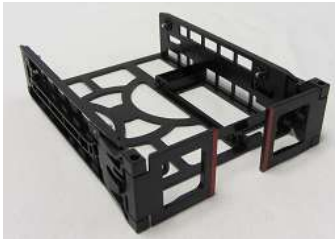

Manual Connect FLEX Tray : Tool-less tray that can hold up to two drives. These trays utilize hinged pulls that open and allow for cable access and manual cable connections.

---

## Section 9 – Document Revision History

Version	Date	Author	Changes/Updates
1.4	3/6/2019	Jason Moebs	Updates throughout.
1.3	3/4/2019	Jason Moebs	Updates throughout.
1.2	2/28/2019	Jason Moebs	Updates throughout.
1.1	2/4/2019	Jason Moebs	Updates throughout.
1.0	10/10/2018	Jason Moebs	Initial launch release.