

# VC8300

8" and 10" Vehicle-Mounted  
Computer



**ZEBRA**

**Product Reference Guide**  
for Android™ 11

ZEBRA and the stylized Zebra head are trademarks of Zebra Technologies Corporation, registered in many jurisdictions worldwide. Google, Android, Google Play and other marks are trademarks of Google LLC. All other trademarks are the property of their respective owners. ©2021 Zebra Technologies Corporation and/or its affiliates. All rights reserved.

Information in this document is subject to change without notice. The software described in this document is furnished under a license agreement or nondisclosure agreement. The software may be used or copied only in accordance with the terms of those agreements.

For further information regarding legal and proprietary statements, please go to:

SOFTWARE: [zebra.com/linkoslegal](https://zebra.com/linkoslegal).

COPYRIGHTS: [zebra.com/copyright](https://zebra.com/copyright).

WARRANTY: [zebra.com/warranty](https://zebra.com/warranty).

END USER LICENSE AGREEMENT: [zebra.com/eula](https://zebra.com/eula).

## Terms of Use

### Proprietary Statement

This manual contains proprietary information of Zebra Technologies Corporation and its subsidiaries (“Zebra Technologies”). It is intended solely for the information and use of parties operating and maintaining the equipment described herein. Such proprietary information may not be used, reproduced, or disclosed to any other parties for any other purpose without the express, written permission of Zebra Technologies.

### Product Improvements

Continuous improvement of products is a policy of Zebra Technologies. All specifications and designs are subject to change without notice.

### Liability Disclaimer

Zebra Technologies takes steps to ensure that its published Engineering specifications and manuals are correct; however, errors do occur. Zebra Technologies reserves the right to correct any such errors and disclaims liability resulting therefrom.

### Limitation of Liability

In no event shall Zebra Technologies or anyone else involved in the creation, production, or delivery of the accompanying product (including hardware and software) be liable for any damages whatsoever (including, without limitation, consequential damages including loss of business profits, business interruption, or loss of business information) arising out of the use of, the results of use of, or inability to use such product, even if Zebra Technologies has been advised of the possibility of such damages. Some jurisdictions do not allow the exclusion or limitation of incidental or consequential damages, so the above limitation or exclusion may not apply to you.

# Contents

<b>About this Guide.....</b>	<b>11</b>
Configurations.....	11
Notational Conventions.....	12
Icon Conventions.....	12
Service Information.....	12
Determining Software Versions.....	13
Determining the Serial Number.....	13
<b>Getting Started.....</b>	<b>14</b>
Unpacking the Device.....	14
Removing the Protective Film from the Display.....	14
Security.....	15
Initial Operation Safety Considerations.....	15
Power Supply/Cable Safety.....	15
External Devices Safety.....	16
Device Features.....	16
Front Keys.....	19
LED Indicators.....	20
Powering Up the Device.....	21
Powering Down the Device.....	21
Setting Up WLAN.....	21
Heater Status.....	21
<b>Installation.....</b>	<b>22</b>
Mounting Instructions.....	22

Installing the Device.....	22
Electrical Guidelines.....	22
Wiring Guidelines.....	23
Wiring Vehicle Power to the Device.....	24
Installing the External Antenna.....	24
Forklift Battery Replacement Conditions.....	26
Starting from Cold Soak.....	27
Pre-Heat Mode.....	27
Installing the Power Pre-Regulator.....	27
Non-Vehicle Installations.....	30
Wiring for Screen Blanking.....	30
Installing the Speaker and Microphone.....	32
<b>Using the Device.....</b>	<b>33</b>
Home Screen.....	33
Setting Home Screen Rotation.....	34
Status Bar.....	34
Managing Notifications.....	37
Opening the Quick Access Panel.....	38
Editing Icons on the Quick Settings Bar.....	39
Battery Management.....	39
Monitoring Battery Usage.....	39
Low Battery Notification.....	40
Waking the Device.....	40
USB Communication.....	40
Transferring Files.....	40
Transferring Photos.....	41
Disconnecting from the Host Computer.....	41
<b>Settings.....</b>	<b>42</b>
Accessing Settings.....	42
Display Settings.....	42
Setting the Screen Brightness Manually.....	42

Setting Night Light.....	42
Setting Screen Timeout.....	43
Setting Screen Rotation.....	43
Setting Font Size.....	43
Setting Lock Screen Notifications.....	44
Setting Touch Panel Mode.....	44
Setting the Date and Time.....	44
Setting Keyboard Backlight.....	45
General Sound Setting.....	45
Sound Options.....	46
Remapping a Button.....	46
Keyboards.....	47
Keyboard Configuration.....	47
Using the Android and Gboard Keyboards.....	47
Enterprise Keyboard.....	48
Integrated Keyboard.....	49
Soft Input Panel.....	50
Language Usage.....	51
Changing the Language Setting.....	51
Adding Words to the Dictionary.....	51
Notifications.....	51
<b>Applications.....</b>	<b>52</b>
Installed Applications.....	52
Accessing Apps.....	53
Switching Between Recent Apps.....	53
Battery Manager.....	54
Opening Battery Manager.....	54
Battery Manager Information.....	54
DataWedge Demonstration.....	55
DataWedge Demonstration Icons.....	56
Selecting a Scanner.....	56
Heater Control.....	56
PTT Express Voice Client.....	58

PTT Audible Indicators.....	58
PTT Notification Icons.....	58
Enabling PTT Communication.....	59
Selecting a Talk Group.....	59
PTT Communication.....	59
RxLogger.....	60
RxLogger Configuration.....	60
Configuration File.....	60
Enabling Logging.....	60
Disabling Logging.....	61
Extracting Log Files.....	61
Backing Up Data.....	61
RxLogger Utility.....	61
VC Settings.....	62
Display.....	62
Peripheral Power.....	62
Ignition Detection.....	62
Switching WIFI Antennas.....	63
Built-In Speaker.....	63
Screen Blanking.....	63
Velocity.....	63
<b>Data Capture.....</b>	<b>64</b>
Imaging.....	65
Operational Modes.....	65
Scanning Considerations.....	66
Connecting an RS-232 Scanner.....	66
Connecting a USB Scanner to a Device.....	67
Connecting Using Simple Serial Interface.....	67
Connecting Using HID Mode.....	68
Scanning with the DS3678 Bluetooth Scanner.....	69
Scanning with the LI3678 Linear Imager.....	71
Scanning with the DS3578 Bluetooth Scanner.....	72
Scanning with the RS507/RS507X Hands-Free Imager.....	74

Scanning with the RS5100 Ring Scanner.....76

Scanning with the RS6000 Bluetooth Ring Scanner..... 78

Pairing a Bluetooth Ring Scanner.....80

    Pairing Using Simple Serial Interface (SSI)..... 80

    Pairing Using Bluetooth Human Interface Device..... 81

Pairing a Bluetooth Scanner.....82

    Pairing Using Simple Serial Interface.....82

    Pairing Using Bluetooth Human Interface Device..... 82

Supported Devices..... 83

    LI3678 Supported Decoders..... 83

    DS3578 Supported Decoders..... 83

    DS3678 Supported Decoders..... 84

    RS507/RS507x Supported Decoders.....85

    RS5100 Supported Decoders.....86

    RS6000 Supported Decoders.....87

**Wireless..... 88**

Wireless Local Area Networks..... 88

    Connecting to a Wi-Fi Network..... 89

    Removing a Wi-Fi Network..... 89

WLAN Configuration..... 89

    Configuring a Secure Wi-Fi Network.....89

    Manually Adding a Wi-Fi Network..... 90

    Configuring for a Proxy Server..... 92

    Configuring the Device to Use a Static IP Address..... 92

    Wi-Fi Preferences..... 93

    Additional Wi-Fi Settings..... 93

    Wi-Fi Direct..... 94

Bluetooth..... 94

    Adaptive Frequency Hopping..... 94

    Security..... 95

    Bluetooth Profiles..... 95

    Bluetooth Power States..... 96

    Bluetooth Radio Power..... 96

Discovering Bluetooth Device(s).....	97
Changing the Bluetooth Name.....	97
Connecting to a Bluetooth Device.....	97
Selecting Profiles on the Bluetooth Device.....	98
Unpairing a Bluetooth Device.....	98
Cast.....	98
<b>Accessories and Mounting.....</b>	<b>99</b>
Device Accessories.....	99
Related Accessory Documents.....	100
VC8300 Antenna Options.....	101
VC8300 Mounting Accessories.....	102
MT43XX RAM Mount.....	103
Assembling the Optional Mounts.....	104
Assembling the Quick Release MT4200.....	107
Attaching MT4200 to VC8300.....	107
<b>Application Deployment.....</b>	<b>109</b>
Security.....	109
Secure Certificates.....	109
Installing a Secure Certificate.....	109
Configuring Credential Storage Settings.....	110
Android Development Tools.....	110
Android Development Workstation.....	110
Enabling Developer Options.....	111
EMDK for Android.....	111
StageNow for Android.....	111
GMS Restricted.....	112
ADB USB Setup.....	112
Enabling USB Debugging.....	112
Application Installation Methods.....	113
Installing Applications Using a USB Drive.....	113
Installing Applications Using the USB Connection.....	114



Installing Applications Using the Android Debug Bridge.....	114
Installing Applications Using the Wireless Android Debug Bridge.....	115
Uninstalling an Application.....	116
Android System Update.....	117
Performing a System Update Using USB Drive.....	117
Performing a System Update Using ADB.....	118
Performing a System Update Using Wireless ADB.....	119
Verifying System Update Installation.....	120
Android Enterprise Reset.....	120
Performing an Enterprise Reset Using ADB.....	121
Performing an Enterprise Reset Using Wireless ADB.....	122
Performing an Enterprise Reset Using USB Drive.....	124
Android Factory Reset.....	125
Performing a Factory Reset Using ADB.....	125
Performing a Factory Reset Using Wireless ADB.....	126
Performing a Factory Reset Using a USB Drive.....	128
Android Storage.....	129
Random Access Memory.....	129
Internal Storage.....	129
External Storage.....	130
Managing Apps.....	130
App Details.....	131
Managing Downloads.....	131
<b>Maintenance and Troubleshooting.....</b>	<b>132</b>
Cleaning the Device.....	132
Housing.....	132
Cleaning the Touchscreen.....	132
Housing.....	132
Touchscreen.....	132
Troubleshooting.....	133
Resetting the Device.....	133
Troubleshooting the Device.....	134

**Specifications..... 137**  
    Drill Hole Dimensions.....137

# About this Guide

This guide provides instructions for setting up, operating, configuring, and maintaining the VC8300 vehicle-mount computer. Screens and windows pictured in this guide are samples and can differ from actual screens.



**WARNING:** Before transporting, assembling, and starting the computer, please read this manual carefully and follow all the safety guidelines and requirements.

## Configurations

The VC8300 offers different configurations to suit various work requirements.

**Table 1** Configurations

Configuration	Radios	Display	Memory	Operating System
VC8300-8 Standard	WLAN: IEEE 802.11 a/b/g/n/ac/d/h/i/r/w WPAN: Bluetooth v5.0 Low Energy	8" WVGA (1280 x 780) LCD	4 GB RAM / 32 GB Flash	Android-based, Google™ Mobile Services (GMS) 11
VC8300-8 Freezer	WLAN: IEEE 802.11 a/b/g/n/ac/d/h/i/r/w WPAN: Bluetooth v5.0 Low Energy	8" WVGA (1280 x 780) LCD	4 GB RAM / 32 GB Flash	Android-based, Google™ Mobile Services (GMS) 11
VC8300-10 Standard	WLAN: IEEE 802.11 a/b/g/n/ac/d/h/i/r/w WPAN: Bluetooth v5.0 Low Energy	10" XGA (1024 x 768) LCD	4 GB RAM / 32 GB Flash	Android-based, Google™ Mobile Services (GMS) 11
VC8300-10 Freezer	WLAN: IEEE 802.11 a/b/g/n/ac/d/h/i/r/w WPAN: Bluetooth v5.0 Low Energy	10" XGA (1024 x 768) LCD	4 GB RAM / 32 GB Flash	Android-based, Google™ Mobile Services (GMS) 11

## Notational Conventions

The following conventions are used in this document:

- **Bold** text is used to highlight the following:
  - Dialog box, window, and screen names
  - Drop-down list and list box names
  - Checkbox and radio button names
  - Icons on a screen
  - Key names on a keypad
  - Button names on a screen
- Bullets (•) indicate:
  - Action items
  - List of alternatives
  - Lists of required steps that are not necessarily sequential.
- Sequential lists (for example, those that describe step-by-step procedures) appear as numbered lists.

## Icon Conventions

The documentation set is designed to give the reader more visual clues. The following graphic icons are used throughout the documentation set.



**NOTE:** The text here indicates information that is supplemental for the user to know and that is not required to complete a task. The text here indicates information that is important for the user to know.



**IMPORTANT:** The text here indicates information that is important for the user to know.



**CAUTION:** If the precaution is not heeded, the user could receive a minor or moderate injury.



**WARNING:** If danger is not avoided, the user CAN be seriously injured or killed.



**DANGER:** If danger is not avoided, the user WILL be seriously injured or killed.

## Service Information

If you have a problem with your equipment, contact Zebra Global Customer Support for your region. Contact information is available at: [zebra.com/support](https://zebra.com/support).

When contacting support, please have the following information available:

- Serial number of the unit
- Model number or product name
- Software type and version number

Zebra responds to calls by email, telephone, or fax within the time limits set forth in support agreements.

If your problem cannot be solved by Zebra Customer Support, you may need to return your equipment for servicing and will be given specific directions. Zebra is not responsible for any damages incurred during shipment if the approved shipping container is not used. Shipping the units improperly can possibly void the warranty.

If you purchased your Zebra business product from a Zebra business partner, contact that business partner for support.

## Determining Software Versions

Before contacting Customer Support, determine the current software version on your device.

1. Swipe down from the Status bar with two fingers to open the Quick Access panel, and then touch .
2. Touch **About phone**.
3. Touch **Android version**.

## Determining the Serial Number

Before contacting Customer Support, determine the serial number of your device.

1. Touch **About phone**.
2. Touch **Model & hardware**.
3. Touch **Serial number**.

# Getting Started

The VC8300 is a rugged, vehicle-mounted computer running the Android 11 operating system. Wireless communications are supported over a 802.11 WLAN network. The Bluetooth module supports Bluetooth printers and scanners.

The VC8300-8 contains an integrated keyboard in either QWERTY or AZERTY alphanumeric keyboard layout. It features 54 keys, 12 direct function keys, and a power button.

The VC8300-10 can be used with or without an external keyboard. There are six programmable macro keys on the front bezel and when used with the Blue modifier key, provides six additional programmable keys.

The VC8300 is intended for use in commercial and industrial applications with a focus on real-time wireless data transactions with options suiting materials handling applications in warehouses, manufacturing facilities, ports, yards, and freezers.

## Unpacking the Device

Before operating the unit for the first time, carefully read [Security](#) on page 15.

1. Carefully remove all protective material from the device and save the shipping container for later storage and shipping.
2. Verify the following items are in the box:
  - 8" or 10" Vehicle-mounted computer
  - Quick Start Guide
3. Inspect the equipment for damage. If any equipment is missing or damaged, contact the Global Customer Support Center immediately.
4. Before using the device for the first time, remove the protective shipping film that covers the scan window, display, and camera window.

## Removing the Protective Film from the Display

The front display of the device is protected during transport by a transparent film. This film should remain on the front display during assembly to avoid damage to the front display surface. Only remove the film once all of the assembly work has been completed.

### Security

In order to prevent injury and damage, observe the following safety guidelines prior to assembly and commissioning. The device is a multifunction vehicle computer for stationary and mobile use in commercial environments such as warehouses, manufacturing, yard/ports, and freezers. Different or extraordinary usage is not permitted. For resulting damage, the user/operator of the device is solely responsible. This also applies to any changes that you make to the device. Compliance with the safety guidelines is particularly important for the proper use of this device. The manufacturer assumes no liability for any and all damages that can be attributed to non-compliance with these guidelines.

### Initial Operation Safety Considerations

- Installation/Initial Operation - Perform device installation in accordance with [Installation](#) on page 22. Specifically, pay special attention to the various electrical potentials of the vehicle. Some vehicles have a chassis that is connected to one of the battery supply lines (DC+ or DC-), while most electrically-driven forklift vehicles have floating chassis, connected to neither DC+ or DC-. See [Wiring Vehicle Power to the Device](#) on page 24 for required wiring of vehicle power and fusing for the device.
- Risk of injury during transit or installation - The unit can fall during transit or installation and cause injury. Always ensure that there are two persons available when installing or removing the device.
- Ensure that no persons are injured in case the mounting bracket breaks - The device may not be installed in such a way that persons can be injured during a breaking of the mounting bracket (for example, fatigue break). If the device is mounted in a place where people can be injured if the bracket breaks, apply appropriate safety measures (for example, install a security cable in addition to the device bracket).

### Power Supply/Cable Safety

The main power cord shall comply with the national safety regulations of the country where the equipment is to be used.

- Operation in an emergency - In case of an emergency (such as damage to the power cable or housing, or ingress of liquid or other foreign bodies), disconnect the device immediately from the power supply. Contact technical support staff at once.
- Protection of the power supplies - If, after replacement, the fuse fed by the internal power supply blows, send the device for servicing immediately.
- Danger of electrocution when cleaning/servicing the device - In order to avoid electrocution, always disconnect the device from the power supply before cleaning or servicing the device.
- Do not exceed maximum voltage when charging the vehicle battery - While charging the vehicle battery, disconnect the device from the battery or ensure that the maximum allowed input voltage of the device is not exceeded.
- Do not switch on devices with damaged cables or plugs - Do not use the device if a cable or plug is damaged. Replace damaged parts immediately.
- Do not connect or disconnect cables during storms - Cables must never be connected or disconnected during an electrical storm.

## External Devices Safety

The use of additional wiring and other peripheral devices, which are not recommended or sold by the manufacturer, can result in fire, electrocution or personal injury.

- If a power supply is used, only use the power supply recommended by the manufacturer.
- Before connecting or disconnecting peripheral devices (exception: USB devices), disconnect the device from the power supply to avoid serious damage to both the device and the connected devices.

## Device Features

Figure 1 VC8300-8 Front View



1	Capacitive touch screen
2	Power button
3	Programmable keys
4	Blue modifier key
5	Pairing bar code
6	Enter key
7	Diamond key



8	Speaker
9	Unpairing bar code
10	Programmable keys
11	Warning LED
12	Power LED - (Power indicator (green/amber), warning indicator (red), application programmable indicator (blue).)

**Figure 2** VC8300-10 Front View



1	Capacitive touch screen  <b>NOTE:</b> The freezer units have a Resistive touch screen.
2	Pairing bar code
3	Power button
4	Speaker volume/display brightness
5	Diamond key
6	Programmable keys
7	Blue modifier key
8	Speaker
9	Unpairing bar code

10	Power LED (Power indicator (green/amber), warning indicator (red), application programmable indicator (blue).)
----	--

**Figure 3** VC8300 Top View

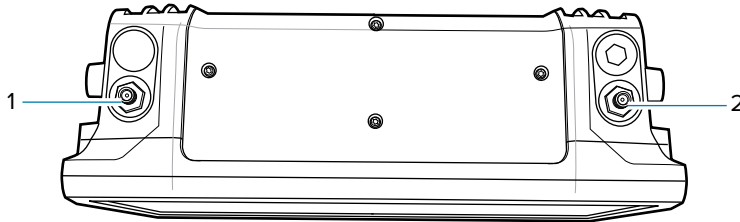

1	ANT 1 (Reverse Polarity SMA Jack (WLAN & BT) / External Main Antenna)
2	ANT 2 (Reverse Polarity SMA Jack (WLAN) / External Aux Antenna)



**NOTE:** Optional external Wi-Fi antennas are not shipped with the device and must be ordered as a separate accessory. The device can be switched between internal and external antenna.

**Figure 4** VC8300 Rear View with Dust Cover

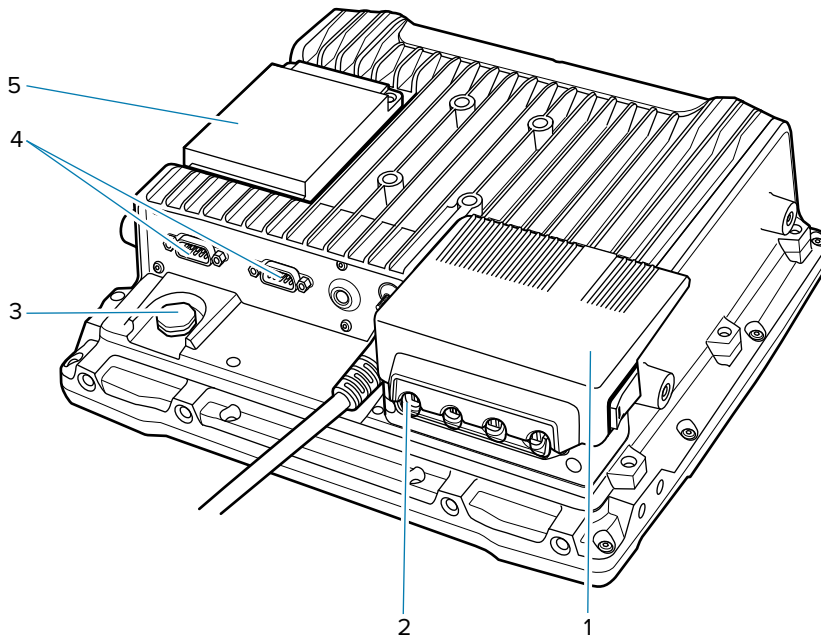

1	Dust cover
2	Strain relief (four)
3	Vent
4	RS-232 (two)
5	UPS battery

**Figure 5** VC8300 Rear View without Dust Cover

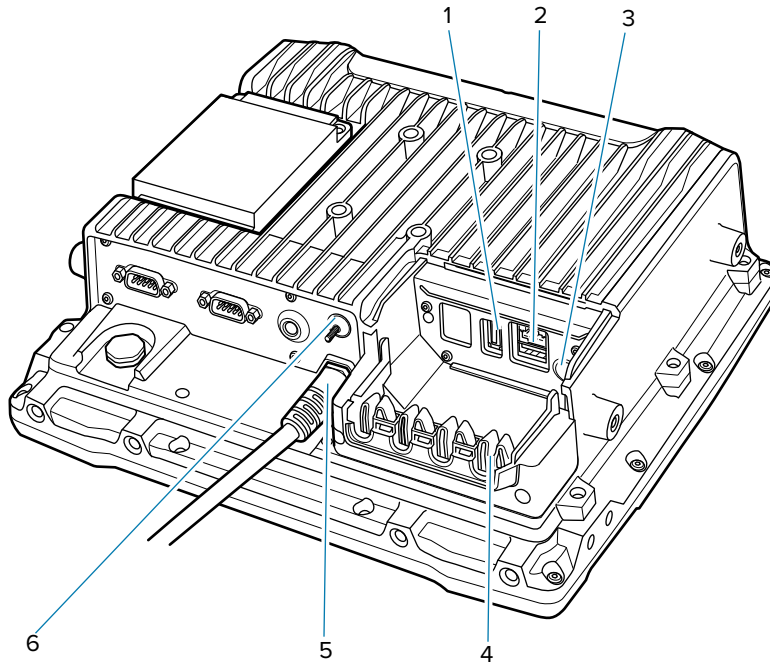

1	Standard USB with BC 1.2
2	Powered USB
3	Speaker/Mic for M1000 only
4	Strain relief
5	Power
6	Ground lug

## Front Keys

This section describes the device's front bezel keys.

**Table 2** VC8300-8 Front Keys

Front	Function
Power	Powers the device on or off. Use to reset the device. See <a href="#">Resetting the Device</a> on page 133.
Diamond key	Opens the special character soft input panel.
Blue (modifier) key	Modifies the programmable macro keys allowing for an additional six programmable keys. Press <b>Blue</b> twice to lock the key on. To unlock press <b>Blue</b> once again.
Function keys	Function keys perform special, custom-defined functions within an application. These keys are accessed by pressing one of the dedicated function keys on the keyboard, or through the appropriate [Blue] key sequence.

**Table 2** VC8300-8 Front Keys (Continued)

Front	Function
Keyboard	Use to enter text.
<b>Bar Codes</b>	
Pairing bar code	Pair peripheral Bluetooth scanners to the device.
Unpairing bar code	Un-pair peripheral Bluetooth scanners to the device.
<b>Speaker</b>	
Front speaker	Located on front bezel.

**Table 3** VC8300-10 Front Keys

Front	Function
Power	Powers the device on or off. Use to reset the device. See <a href="#">Resetting the Device</a> on page 133.
Diamond key	Opens the on-screen keyboard.
Speaker/Display	Speaker volume and display brightness adjustment button. Use - to decrease the brightness and + to increase the brightness. Press <b>Blue</b> and then use - to decrease the volume, and + to increase the volume.
Blue (modifier) key	Modifies programmable macro keys allowing for an additional six programmable keys. Press <b>Blue</b> twice to lock the key on. To unlock press <b>Blue</b> once again.
Programmable keys	Six programmable keys. When used with the <b>Blue</b> key, six additional programmable keys are provided. Keys can be mapped in the Key Programmer settings. By default, the programmable keys are mapped as F1 through F12.
<b>Bar Codes</b>	
Pairing bar code	Pair peripheral Bluetooth scanners to the device.
Unpairing bar code	Un-pair peripheral Bluetooth scanners to the device.
<b>Speaker</b>	
Front speaker	Located on the front bezel.

## LED Indicators

This section describes the devices' LED indicators.

**Table 4** LED Indicators

Indicator	State	Description
Power	Off	The device has no power and cannot be turned on.
	Amber	The device has power and can be turned on.
	Flashing Amber	The unit is pre-heating.
	Solid Green	The unit is ON, operating from external power.

**Table 4** LED Indicators (Continued)

Indicator	State	Description
	Slow Flashing Green	The device is running with UPS/Internal Battery power, no external power available.
	Fast Flashing Green	The device is in Sleep mode. Press <b>Power</b> to wake the device.
Warning	Off	No battery or charger faults.
	Solid Red	Battery temperature is out of range for charging.
	Blinking Red	Any other battery/charging fault. For example, communication fault, charge timeout, or defective battery pack.
Blue Key  <b>NOTE:</b> Only on VC8300-10	Off	Blue modifier is not activated.
	Blinking blue	Blue Key is pressed once.
	Solid blue	Blue key is pressed twice. (Blue modifier mode is active.)

## Powering Up the Device

Power up the device after connecting all of the devices.



**CAUTION:** Make sure there is a suitable disconnecting device such as a power switch or circuit breaker in the power supply circuit. See [Installing the Device](#) on page 22 for more information.

1. Connect to an appropriate power supply.
2. Press and hold **Power** for approximately 5 seconds.

The device startup screen appears.

## Powering Down the Device

Always shut down the device as follows:

1. Press **Power** until the menu appears on the screen.
2. Touch **Power off**.

## Setting Up WLAN

To connect to a WLAN, see [Wireless](#) on page 88.

## Heater Status

The device offers a unique heater system that enables continuous operations in freezer environments. See [Heater Control](#) on page 56 for information about the heater settings.

# Installation

This section describes different ways to install the device.

The device can be installed in a variety of ways:

- Position the device horizontally on a desk or mounted on a vehicle console.
- Wall mount the device using the optional wall mount. See [VC8300 Mounting Accessories](#).
- Overhead mount on a lift truck cage using mounting hardware.

Depending on the vibration resistance and pivoting demands, mounting brackets, clamp feet or RAM mount elements can also be used to attach the device. Contact your Zebra sales office to find out more about the range of available installation options.



**WARNING:** The unit could fall during transit or installation/mounting and cause injury. Always ensure that there are two people available when installing or removing the device.

## Mounting Instructions

Follow and retain the mounting instructions included with the assembly kit when installing the device. See [VC8300 Mounting Accessories](#) on page 102.

## Installing the Device

This section describes electrical information and wiring guidelines to adhere to when installing the device.

### Electrical Guidelines

There are various electrical potentials when installing the unit on a vehicle such as a forklift.



**WARNING:** Most electrically driven forklift vehicles have floating chassis connected to neither DC + or DC-. However, electrical faults can cause the battery + or - to be connected to the chassis via low resistance paths. All connected peripherals must be completely isolated.

The device accepts DC power sources with a minimum of 10 VDC nominal and 48 VDC nominal. A Power Pre-regulator is required for voltages above 48 VDC nominal.

Applying a voltage above 48 VDC nominal without the pre-regulator or reversing polarity may result in permanent damage to the device and voids the product warranty.



**CAUTION:** Attach the device connecting cable as close to the battery as possible. Connecting the device to large electrical loads, such as converters for the forklift motor may result in random restarts, malfunctions and/or irreparable damage to the device.

To connect devices fed by other power sources to the device, such as printers, power up the peripheral devices at the same time or after the device to avoid start-up problems, malfunctions, or irreparable damage to the device.

### Wiring Guidelines

The metal chassis of the device is equipped with a ground lug (1) located on the underside adjacent to the power cable to provide additional ground to the vehicle. It is strongly recommended that a grounding strap is used to connect the ground stud on the vehicle-mount to a solid, reliable contact point on the main portion of the vehicle chassis. It must not be connected to a battery negative or terminal block.

**Figure 6** Ground Lug

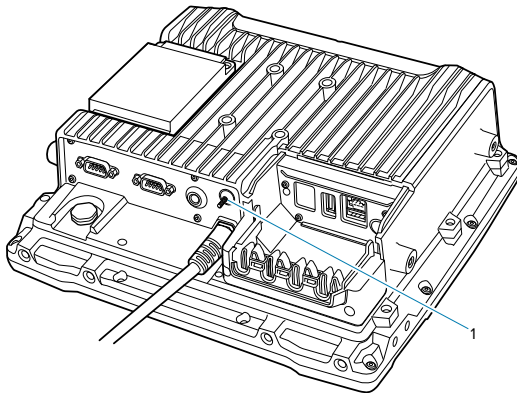

As with other vehicle cables, carefully consider the routing of the ground strap to ensure it does not pose a hazard to the operator or the safe operation of the vehicle. If necessary, secure the ground strap with cable ties or some other mechanical means to prevent loops or loose lengths of wire from catching on stationary items when the vehicle is in motion.

Before installing the cables between the mount and other devices, consider the following:

- Ensure that drilling holes do not damage the vehicle or its wiring.
- Protect cable runs from pinching, overheating and physical damage.
- Use grommets to protect cables that pass through metal.
- Use plastic straps and tie-downs to secure cables and connectors in their desired location, away from areas where they may get snagged or pulled.
- Keep cables away from heat sources, grease, battery acid and other potential hazards.
- Keep cables away from control pedals and other moving parts that may damage the cables or interfere with the operation of the vehicle.



**CAUTION:** Make sure the cables run inside the roll cage of the vehicle.

If the device is installed in an environment where earth ground is present such as a vehicle with metal wheels running on a metal track, or is powered by the AC/DC adapter in a permanent installation, the ground lug must be connected to the ground structure.

### Wiring Vehicle Power to the Device

An extension power cable is used to wire the device to the truck battery (order cable separately, see [Device Accessories](#) on page 99). Wire this cable to a filtered, fused (15A max) accessory supply on the vehicle. Follow the installation instructions supplied with the extension cable.

Additional wiring (minimum 14 gauge), connectors or disconnects used should be rated for at least 300 VDC, 15A.



**WARNING:** Applying voltage above the input voltage rating or reversing polarity may result in permanent damage to the device and void the product warranty.

When connecting the extension power cable:

- If a power extension cable with ignition sense is used, ensure that the ignition sense wires (18AWG wires in red and black leads) and the power wires (14AWG in red and black leads) are reliably secured away from each other, or are separated with reliably secured certified insulation. Minimum 2.8 mm distance, or 0.4 mm distance through insulation is required for the separation.
- The red lead of the 14AWG power cables attach to the vehicles battery positive terminal. The 14AWG black lead connects to the vehicle's battery negative terminal. This should be connected to a proper terminal block and not to the vehicle body. An optional grounding strap wire (sourced separately) may be connected to the ground lug of the VC8300 terminal connector bay and to the vehicle chassis.
- You may have the option to connect power before or after the key switch. Though the VC8300 is equipped with a UPS, a proper shut down is recommended using the Power Off procedure. If it is wired after the key switch, the operator must shut down the device using the Power Off procedure before turning off the vehicle. If it is wired before the key switch, then to avoid excessive drain on the vehicle battery, either the operator should shut it down when the vehicle is to be left off for an extended period, or the ignition cable shut down wire should be connected and the device configured to shut down automatically.
- An appropriate fuse type must be used with the power extension cable according to the installation instructions. For main power cable, use 3AB, 15A, 250V, slow blow fuse. For ignition sense input, use 3AB, 0.3A, 250V, slow blow fuse.



**NOTE:** The device supports the ignition sense feature that detects when the ignition switch or key switch is On or Off to allow automatic computer start up or shut down (with delay as needed).

When wiring the ignition sense wires (18AWG in red and black), the red 18AWG wire is connected to a positive DC voltage source switched on by the ignition. The black 18AWG wire is connected to ground reference of this switched ignition source.

### Installing the External Antenna

There are various antennas available for the device. For more information, see [Device Accessories](#) on page 99.

1. Align the antenna connector with the connector on top of the device.
2. Insert the antenna connector onto the device connector.



3. Tighten the antenna connector.

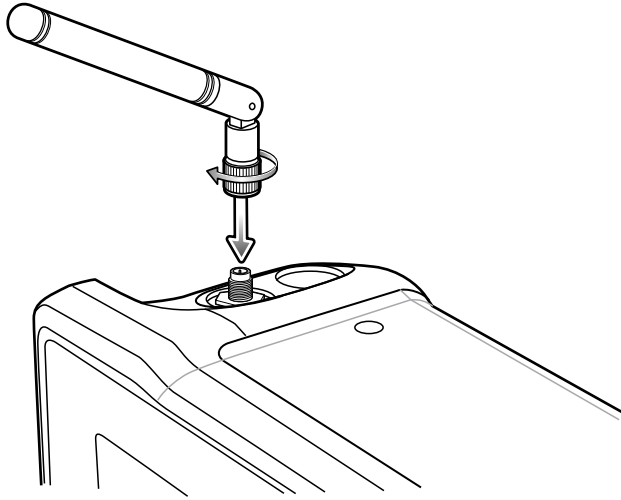

4. Swipe up from the bottom of the Home screen and touch .
5. Touch **Choose Antenna**.
6. Touch **External Antenna**.

### Positioning the Device in the Vehicle

When positioning the device on the vehicle:

- The driver's field of view must be kept free.
- Plan for sufficient space if a keyboard and scanner are installed with the device.
- No part of the device may project beyond the vehicle.

### Assembly Steps

Before fastening the device to the vehicle:

- Configure shut down automation.
- Prepare the forklift such as ignition connection and correct voltage.
- It is recommended to fasten the bracket to the vehicle and then install the device to the bracket.

### Installing the Device on a Forklift

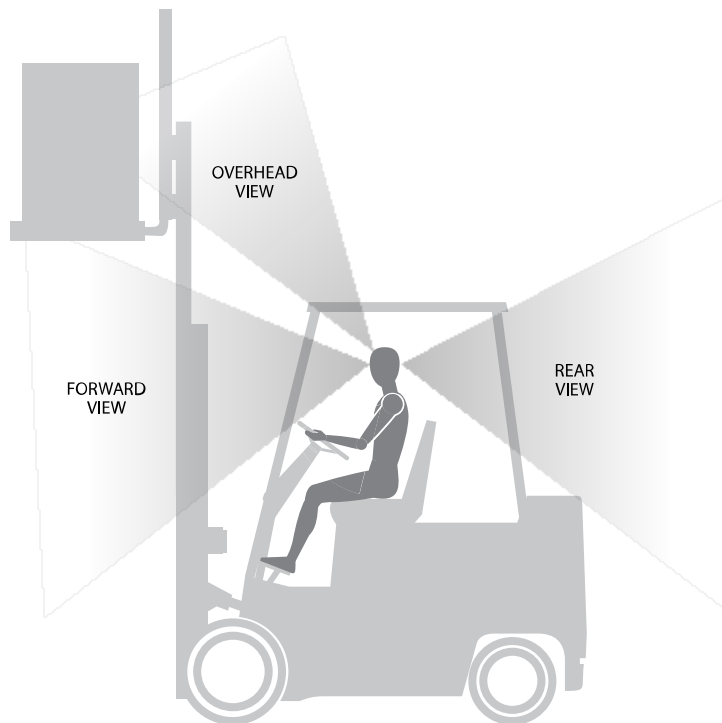

**NOTE:** If installing peripherals, allow enough space when selecting a mounting location.

**Figure 7** View Obstruction Considerations

1. Attach the desired mount to the device. See [VC8300 Mounting Accessories](#) on page 102 for detailed mounting options and instructions.
2. Attach the mounted VC8300 to the vehicle and position in a location that does not obstruct the operator's view.
3. If using an external antenna, connect the antenna in a vertical position to the device.



**CAUTION:** Tighten peripherals with thumbscrews by hand only. Do not use tools for tightening thumbscrews.

4. Connect peripherals to the device. Place the cables in the strain relief brackets inside the dust cover and replace the dust cover (see [VC8300 Rear View with Dust Cover](#)).
5. Connect the device to the vehicle DC supply.
6. Press **Power** to turn the device On or Off (see [VC8300-8 Front View](#) or [VC8300-10 Front View](#)).

## Forklift Battery Replacement Conditions

The device maintains the normal function of applications and connections during and after forklift battery replacement.

Replace the forklift battery at any point during a shift and/or while the device is fully running.

The forklift battery may be replaced under the following condition: Device external temperature range: -30°C to +50° C (-22°F to 122°F).

The VC8300 is equipped with an Uninterrupted Power Supply (UPS) which allows running it for a minimum of 30 minutes when the main power source (usually the fork truck battery) is disconnected.

During forklift battery replacement (the device is running on UPS battery), both Android and the device are monitoring the remaining UPS battery capacity. The default Low Battery notification threshold is set to 30%. The Critical Battery threshold is set to 7%. If the UPS battery is discharged below 7%, the device automatically shuts down.

### Starting from Cold Soak

The device can start up from a saturated cold soak at  $-30^{\circ}\text{C}$  ( $-22^{\circ}\text{F}$ ) (or above) internal temperature when a valid external DC power source is present.



**NOTE:** Applies to freezer configurations only.

The device design minimizes wait time from a  $-30^{\circ}\text{C}$  ( $-22^{\circ}\text{F}$ ) cold soak to load the OS and have internal heaters to assist system warm-up.

From a  $-30^{\circ}\text{C}$  ( $-22^{\circ}\text{F}$ ) cold soak condition, the device's battery heater may be activated to warm the UPS battery to an acceptable charging temperature if charging is needed. The conditions and time to heat the battery are managed by the system. The OS load time and device ready for use time are independent of warming the battery.

### Pre-Heat Mode

When the device is powered down or suspended and the system temperature is below  $-25^{\circ}\text{C}$  ( $-13^{\circ}\text{F}$ ), the device enters pre-heat mode when the user presses **Power**. This warms up critical internal components with the heater elements prior to boot up.



**NOTE:** Applies to freezer configurations only.

When in Pre-heat mode the Power LED blinks amber.

The pre-heat mode lasts no longer than 15 minutes. The freezer configuration spends less time in Pre-heat mode due to the additional Touch Panel heater.

The device remains powered down or suspended during Pre-heat mode. Once the system reaches the adequate temperature, the device automatically boots up. The user is not required to press **Power**.

The device does not enter Pre-heat mode if it is outside the operating temperature range ( $-30^{\circ}\text{C}$  to  $50^{\circ}\text{C}$  ( $-22^{\circ}\text{F}$  to  $122^{\circ}\text{F}$ )).

### Installing the Power Pre-Regulator

The pre-regulator is a DC/DC power supply and is available as an accessory. It should be used when the power source (usually the forklift truck battery) exceeds the input range of the VC8300 power supply (for example, trucks equipped with a 72 VDC battery).

It is recommended that all connections be secured with electrical tape or heat shrink to prevent contaminants from degrading the connection.



**IMPORTANT:** The Zebra power extension cable positive lead is red and the negative lead is black.

1. Attach the pre-regulator cable male connector to the Zebra power extension cable which is installed on the vehicle.

2. Connect the pre-regulator cable female connector either directly to the device's power cable, or to the power extension cable.

**Figure 8** Connections To Vehicle DC Supply - Without Power Pre-regulator For vehicles with DC power 48V or less

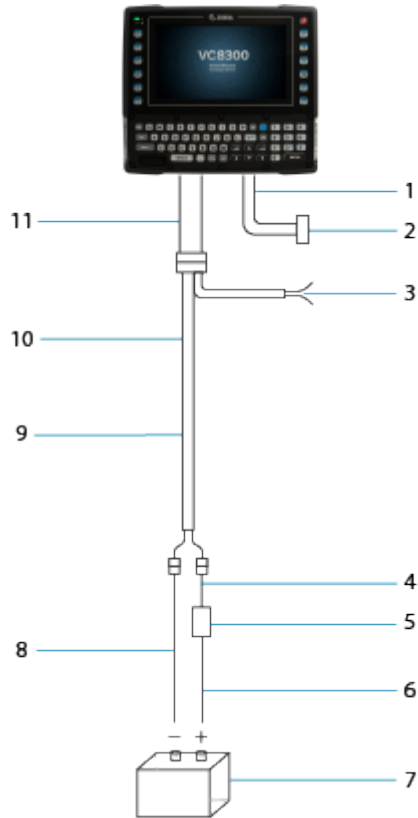

1	DB9 Cable
2	Lines to screen-blanking sensor (optional)
3	Lines to ignition switch (optional)
4	Extension power cable
5	Fuse
6	Positive Connection
7	Vehicle DC Power Source (12 VDC to 48 VDC nominal)
8	Negative Connection
9	Power Extension with Ignition Sense (p/n CA1220)
10	Power Extension without Ignition Sense (p/n CA1210)

11	Power Cable
----	-------------

**Figure 9** Connections To Vehicle DC Supply - With Power Pre-regulator For vehicles with DC power greater than 48V

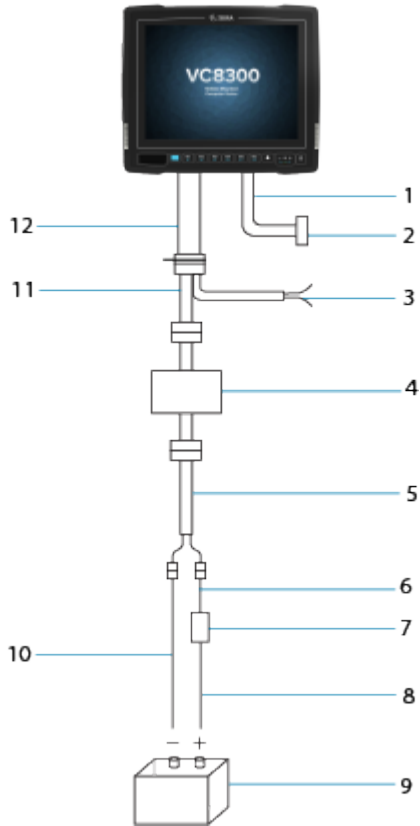

1	DB9 Cable
2	Lines to screen-blanking sensor (optional)
3	Lines to ignition switch (optional)
4	Power pre-regulator
5	Power Extension without Ignition Sense (p/n CA1210)
6	Extension Wire
7	Fuse
8	Positive Connection
9	Vehicle DC Power Source (12 VDC to 48 VDC nominal)
10	Negative Connection
11	Power Extension for Pre-Regulator with Ignition Sense (p/n CA1230)
12	Power Cable

## Non-Vehicle Installations

Using AC power, the device can be mounted at fixed locations adjacent to cross-dock doors, manufacturing stations, or in offices. Use the 100/240 VAC Power Supply (p/n PS1450) to power the computer from an AC source.



**IMPORTANT:** The AC/DC power supply is only intended for use at room temperature conditions such as an office environment.

### Power On/Off with Ignition

The device is equipped with an ignition sense feature that shuts down the device when the vehicle ignition is turned off, and can power on the device when the ignition is switched on. To use this feature, a power extension cable with ignition sense wires must be used and installed properly on the vehicle.

The cable in the following illustration is the power extension cable (p/n CA1220) with two wires used to connect to vehicle ignition. The red and black leads of the two 18AWG wires that connect to the key switch of the ignition and ground, respectively. Once the wires are connected, the VC8300 may switch on or off depending on the state of the vehicle ignition key. See [VC Settings](#) on page 62 to select power settings.



**IMPORTANT:** When connecting to an ignition switch using the power extension cable with ignition sense wires, ensure that the wires of different polarities are reliably secured away from each other, or are separated with reliably secured certified insulation. A minimum distance of 2.8mm (or 0.4mm distance through insulation) is required for the separation.

The thinner wires (18 AWG) are used for Ignition Sense wires while the thicker wires (14AWG) are used for Vehicle Power and Ground. Identify them carefully and Do Not confuse them.

An appropriate fuse type must be used with the power extension cable according to the installation instructions. For the main power cable, use 3AB, 15A, 250V, slow blow fuse. For ignition sense input, use 3AB, 0.3A, 250V, slow blow fuse.

**Figure 10** Power Extension Cable Kit with Optional Ignition Sense Wires (p/n CA1220)

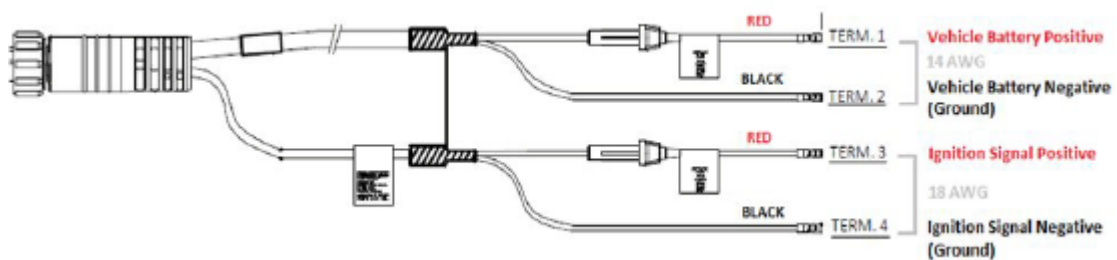

## Wiring for Screen Blanking

To use screen blanking, connect one of the two DB9 serial ports (using CA1300 Screen Blanking cable) on the device to a switch. Activate this switch electrically (for example, motion sensor) or mechanically (for example, pedal switch) when the vehicle is in motion.

**Figure 11** Connecting the Switch to the DB9 Cable

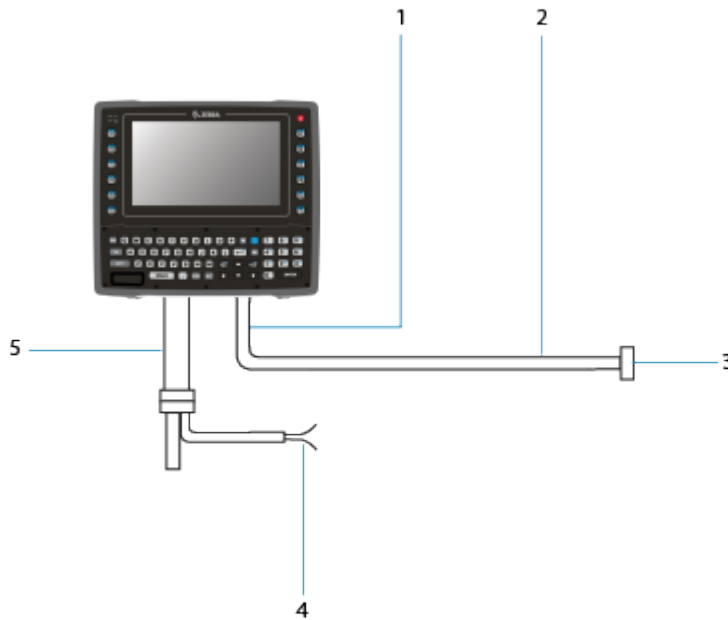

1	DB9 Cable
2	Lines to screen-blanking sensor (optional). Only CTS and RTS signals are used.
3	User-supplied switch/relay that will provide an electrical conductive connection when the vehicle is in motion.
4	Lines to ignition switch (optional)
5	Power Cable



**IMPORTANT:**

For customers migrating to the VC8300 from an Zebra 8515, 8525, 8535 vehicle mount computer, or a 753x hand-held computer cradle:

- If the screen blanking feature was used previously, ensure that you are no longer feeding the screen blanking signals to the VC8300 main DC power cable. Rewire the screen blanking inputs to the VC8300 DB-9 serial port through the DB-9 screen blanking cable. In previous generations of vehicle-mount computers, the screen blanking signals were fed into the terminal through 2 of the 4 wires in the CPC connector of the DC power cable. This no longer applies to the VC8300.
- The screen blanking feature makes use of either one of the DB-9 ports to monitor electrical relay closure. When enabled, the CTS/RTS pins of the DB9 port are continuously monitored by the screen blanking application.
- When the vehicle is in motion, the switch closes the circuit, allowing data packets to be sent or received through the RTS and CTS pins. The computer detects that the circuit is closed and turns off the screen.
- When the vehicle is not in motion, the switch opens the circuit, preventing data packets from being sent or received. The computer detects that the circuit is open and turns on the screen.

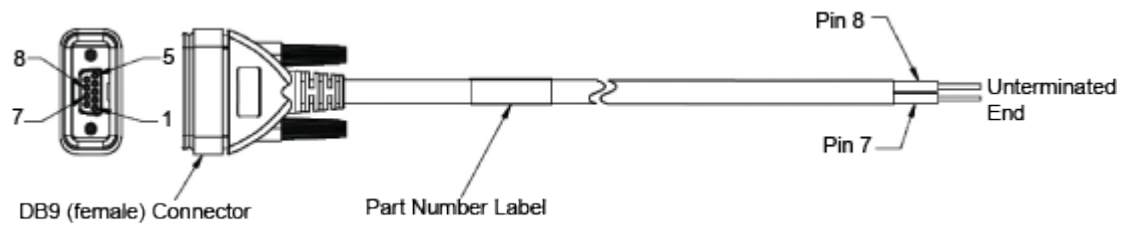
**Figure 12** Screen Blanking DB9 Pin Configuration (p/n CA1300)

## Installing the Speaker and Microphone

Use the optional M1000 Speaker/Microphone to use PTT Express. For more information, see [PTT Express Voice Client](#) on page 58.

1. Remove the dust cover on the back of the device.
2. Plug the Speaker/microphone audio plug into the Speaker/Mic jack.
3. Replace the audio cable into the cable strain relief.
4. Replace the dust cover.



# Using the Device

This section explains how to use the device.

## Home Screen

Turn on the device to display the Home screen. Depending on how your system administrator configured your device, your Home screen may appear differently than the graphics in this section.

**Figure 13** Home Screen

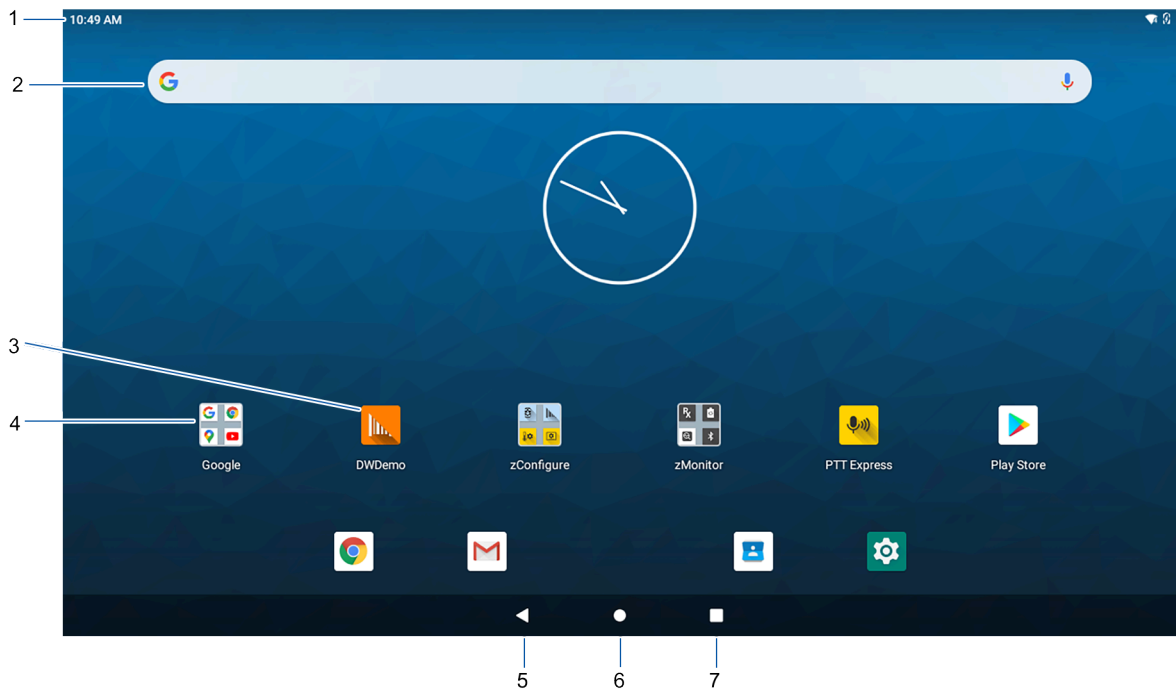

1	Status bar	Displays the time, status icons (right side), and notification icons (left side).
2	Widgets	Launches stand-alone apps that run on the Home screen.
3	Shortcut icons	Opens apps installed on the device.
4	Folder	Contains apps.

5	Back	Displays the previous screen.
6	Home	Displays the home screen.
7	Recent	Displays recently used applications.

## Setting Home Screen Rotation

By default, the Home screen rotation is disabled.

1. Touch and hold anywhere on the Home screen until the options appear.
2. Touch **Home settings**.
3. Touch the **Allow Home screen rotation switch**.
4. Touch **Home**.
5. Rotate the device.

## Status Bar

The Status bar displays the time, notification icons (left side), and status icons (right side).

If there are more notifications than can fit in the Status bar, a dot displays indicating that more notifications exist. Swipe down from the Status bar to open the Notification panel and view all notifications and status.

**Figure 14** Notifications and Status Icons



1	Notification icons
2	Status icons















## Notification Icons

Notification icons indicate app events and messages.

**Table 5** Notification Icons

Icons	Description
	Main battery is low.
	More notifications are available for viewing.
	Data is synching.

















**Table 5** Notification Icons (Continued)

Icons	Description
	Indicates an upcoming event. GMS devices only.
	Open Wi-Fi network is available.
	Audio is playing.
	Problem with sign-in or sync has occurred.
	Device is uploading data.
	Animated: the device is downloading data. Static: the download is complete.
	Device is connected to or disconnected from a virtual private network (VPN).
	Preparing internal storage by checking it for errors.
	USB debugging is enabled on the device.
	Wired headset with a boom module is connected to the device.
	PTT Express Voice client status.
	Indicates the RxLogger app is running.
	Indicates the Bluetooth scanner is connected to the device.
	Indicates the ring scanner is connected to the device in HID mode.

## Status Icons

Status icons display system information for the device.

**Table 6** Status Icons

Icon	Description
	Alarm is active.
	UPS battery is fully charged.
	UPS battery is partially drained.
	UPS battery charge is low.
	UPS battery charge is very low.
	UPS battery is charging.
	Do Not Disturb mode active.
	Airplane Mode is active. All radios are turned off.
	Bluetooth is on.
	The device is connected to a Bluetooth device.
	Connected to a Wi-Fi network. Indicates the Wi-Fi version number.
	Not connected to a Wi-Fi network or no Wi-Fi signal.
	Connected to an Ethernet network.
	Indicates that the Blue key is pressed. (VC8300-8 only)
	Indicates that the Blue key is locked. (VC8300-8 only)
	Indicates that the ALT key is pressed. (VC8300-8 only)
	Indicates that the ALT key is locked. (VC8300-8 only)

**Table 6** Status Icons (Continued)

Icon	Description
<b>C</b>	Indicates that the CTRL key is pressed. (VC8300-8 only)
<b><u>C</u></b>	Indicates that the CTRL key is locked. (VC8300-8 only)
<b>↑</b>	Indicates that the Shift key is pressed. (VC8300-8 only)
<b><u>↑</u></b>	Indicates that the Shift key is locked. (VC8300-8 only)

## Managing Notifications

Notification icons report the arrival of new messages, calendar events, alarms, and ongoing events. When a notification occurs, an icon appears in the Status bar with a brief description.

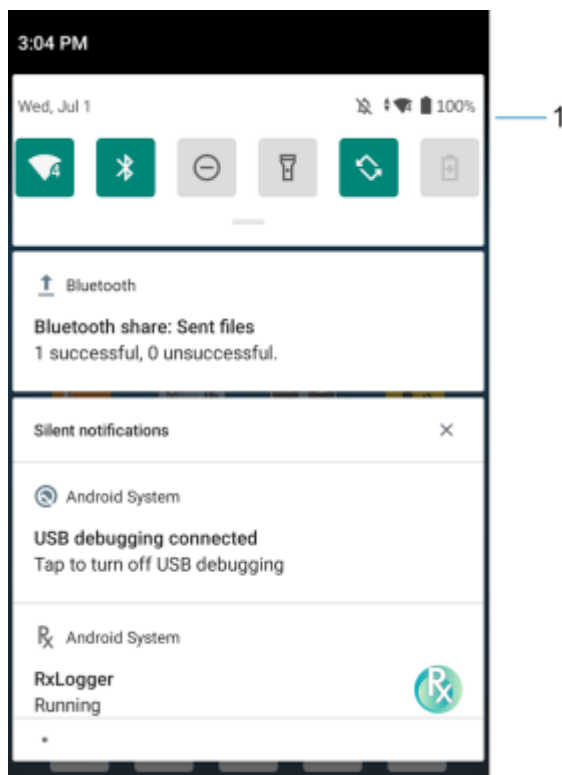

1	Quick settings bar
---	--------------------

- To view a list of all notifications, open the Notification panel by dragging the Status bar down from the top of the screen.
- To respond to a notification, open the Notification panel and then touch a notification. The Notification panel closes and the corresponding app opens.

- To manage recent or frequently used notifications, open the Notification panel and then touch Manage notifications. Touch the toggle switch next to an app to turn off all notifications, or touch an app for more notification options.
- To clear all notifications, open the Notification panel and then touch CLEAR ALL. All event-based notifications are removed. Ongoing notifications remain in the list.
- To close the Notification panel, swipe the Notification panel up.

### Opening the Quick Access Panel

Use the Quick Access panel to access frequently used settings (for example, Airplane mode).

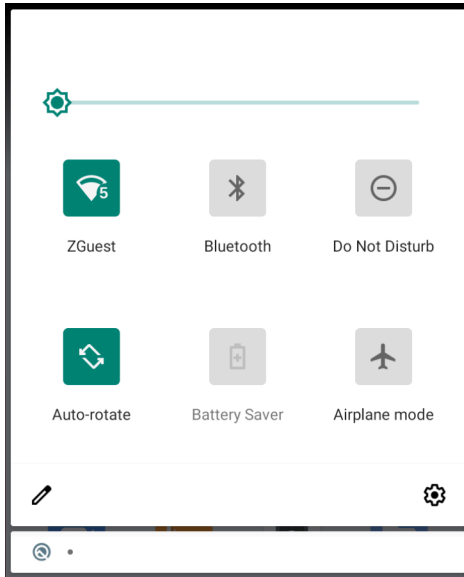



**NOTE:** Not all icons are pictured. Icons may vary.

- If the device is locked, swipe down once.
- If the device is unlocked, swipe down once with two fingers, or twice with one finger.
- If the Notification panel is open, swipe down from the Quick Settings bar.







### Quick Access Panel Icons

Quick Access panel icons indicate frequently used settings (for example, Airplane mode).

**Table 7** Quick Access Panel Icons

Icons	Description
	Display brightness - Use the slider to decrease or increase the brightness of the screen.
	Wi-Fi network - Turn Wi-Fi on or off. To open Wi-Fi settings, touch the Wi-Fi network name.

**Table 7** Quick Access Panel Icons (Continued)

Icons	Description
	Bluetooth settings - Turn Bluetooth on or off. To open Bluetooth settings, touch Bluetooth.
	Do not disturb - Control how and when to receive notifications.
	Airplane mode - Turn Airplane mode on or off. When Airplane mode is on the device does not connect to Wi-Fi or Bluetooth.
	Battery saver - Turn Battery saver mode on or off. When Battery saver mode is on the performance of the device is reduced to preserve battery power (not applicable).
	Auto-rotate - Lock the device's orientation in portrait or landscape mode or set to automatically rotate.
	Screen Cast - Share phone content on Chromecast or a television with Chromecast built-in. Touch cast screen to display a list of devices, then touch a device to begin casting.

## Editing Icons on the Quick Settings Bar

The first several setting tiles from the Quick Access panel become the Quick Settings bar.

- Open the Quick Access panel and touch  to edit, add, or remove settings tiles.

## Battery Management

To check the charge status of the backup battery, open Settings and touch **System > About phone > Battery Information** or touch **About phone > Status**.

**Battery status** indicates that the battery is discharging and **Battery level** lists the battery charge (as a percentage of fully charged).

## Monitoring Battery Usage

The Battery screen provides battery charge details and power management options to extend battery life. Different apps display different information. Some apps include buttons that open screens with settings to adjust power use. Use the **DISABLE** or **FORCE STOP** buttons to turn off apps that consume too much power.

- Go to **Settings**.
- Touch **Battery**.

To display battery information and power management options for a specific app:

- Go to **Settings**.
- Touch **Apps & notifications**.
- Touch an app.

- Touch **Advanced** > **Battery**.

## Low Battery Notification

When the battery charge level drops below the change level in the table below, the device displays a notice to connect the device to power. Charge the battery using one of the charging accessories.

Charge Drops Below	Action
30%	The user should charge the battery soon.
15%	The user must charge the battery.
7%	The device turns off. The user must charge the battery.

## Waking the Device

The device goes into Suspend mode when you press **Power** or after a period of inactivity (set in the Display settings window).

1. To wake the device from Suspend mode, press **Power**.

The Lock screen displays.

2. Swipe the screen up to unlock.

- If the Pattern screen unlock feature is enabled, the Pattern screen appears instead of the Lock screen.
- If the PIN or Password screen unlock feature is enabled, enter the PIN or password after unlocking the screen.



**NOTE:** If you enter the PIN, password, or pattern incorrectly five times, you must wait 30 seconds before trying again.

- If you forget the PIN, password, or pattern, contact your system administrator.

## USB Communication

Connect the device to a host computer to transfer files between the device and the host computer.

When connecting the device to a host computer, follow the host computer's instructions for connecting and disconnecting USB devices, to avoid damaging or corrupting files.

## Transferring Files

Use Transfer files to copy files between the device and the host computer.

1. Connect the device to a host computer using a USB accessory.
2. On the device, pull down the Notification panel and touch **Charging this device via USB**.

By default, **No data transfer** is selected.

3. Touch **File Transfer**.
4. On the host computer, open **File Explorer**.
5. Locate the **device** as a portable device.



6. Open the **Internal storage** folder.
7. Copy files to and from the device or delete files as required.

### Transferring Photos

Use PTP to copy photos from the device to the host computer.

1. Connect the device to a host computer using a USB accessory.
2. On the device, pull down the Notification panel and touch **Charging this device via USB**.
3. Touch **PTP**.
4. On the host computer, open a file explorer application.
5. Open the **Internal storage** folder.
6. Copy or delete photos as required.

### Disconnecting from the Host Computer



**CAUTION:** Carefully follow the host computer's instructions to disconnect USB devices correctly to avoid losing information.



1. On the host computer, unmount the device.
2. Remove the device from the USB accessory.

# Settings

This section describes the settings on the device.

## Accessing Settings

There are multiple ways to access settings on a device.

- Swipe down with two fingers from the top of the Home screen to open the Quick Access panel and touch .
- Double-swipe down from the top of the Home screen to open the Quick Access panel and touch .
- Swipe up from the bottom of the Home screen to open APPS and touch  **Settings**.

## Display Settings

Use Display settings to change the screen brightness, enable night light, change the background image, enable screen rotation, set sleep time, and change font size.

### Setting the Screen Brightness Manually

Manually set the screen brightness using the touchscreen.

1. Swipe down with two fingers from the Status bar to open the Quick Access panel.
2. Slide the icon to adjust the screen brightness level.



### Setting Night Light

The Night Light setting tints the screen amber, making the screen easier to look at in low light.

1. Go to **Settings**.
2. Touch **Display**.
3. Touch **Night Light**.
4. Touch **Schedule**.

5. Select one of the schedule values:
  - None (default)
  - Turns on at custom time
  - Turns on from sunset to sunrise.
6. By default, **Night Light** is disabled. Touch **TURN ON NOW** to enable.
7. Adjust the tint using the **Intensity** slider.

### Setting Screen Timeout

Set the screen sleep time.

1. Go to **Settings**.
2. Touch **Display > Screen timeout**.
3. Select one of the sleep values:
  - **15 seconds**
  - **30 seconds**
  - **1 minute** (default)
  - **2 minutes**
  - **5 minutes**
  - **10 minutes**
  - **30 minutes**
  - **Never**

### Setting Screen Rotation

By default, screen rotation is disabled.

1. Go to **Settings**.
2. Touch **Display > Advanced**.
3. Touch **Auto-rotate screen**.

### Setting Font Size

Set the size of the font in system apps.

1. Go to **Settings**.
2. Touch **Display > Advanced**.
3. Touch **Font size**.

4. Select an option to choose how long the touch key light stays on:
  - **Small**
  - **Default**
  - **Large**
  - **Largest.**

## Setting Lock Screen Notifications

The lock screen display setting wakes the screen when notifications are received.

1. Go to **Settings**.
2. Touch **Display > Advanced**.
3. Touch **Lock screen**.
4. In the **When to show** section, enable or disable an option using the switch.

## Setting Touch Panel Mode

The device display is able to detect touches using a finger, a conductive-tip stylus, or gloved finger.



**NOTE:** A glove can be made of medical latex, leather, cotton, or wool. For optimal performance use a Zebra certified stylus.

1. Go to **Settings**.
2. Touch **Display > Advanced**.
3. Touch **TouchPanelUI**.
4. Select:
  - **Glove and Finger (Screen Protector OFF)** to use a finger or a gloved finger on the screen without a screen protector.
  - **Finger Only** to use a finger on the screen.
  - **Glove and Finger (Screen Protector ON)** to use a finger or a gloved finger on the screen with a screen protector.
  - **Finger and Stylus** to use a finger or a stylus on the screen.
  - **Finger and Glove** to use a finger or a gloved finger on the screen.

## Setting the Date and Time

The date and time are automatically synchronized using a NITZ server when the device is connected to a cellular/wireless network. You are only required to set the time zone or set the date and time if the wireless LAN does not support Network Time Protocol (NTP) or when not connected to a cellular/wireless network.

1. Go to **Settings**.
2. Touch **System > Date & time**.
3. Touch **Use network-provided time** to disable automatic date and time synchronization.
4. Touch **Date** to select the date in the calendar.

5. Touch **OK**.
6. Touch **Time**.
  - a) Touch the green circle, drag to the current hour, and then release.
  - b) Touch the green circle, drag to the current minute, and then release.
  - c) Touch **AM** or **PM**.
7. Touch **OK**.
8. Touch **Time zone** to select the current time zone from the list.
9. In **TIME FORMAT**, choose either **Use local default** or **Use 24-hour format**.

## Setting Keyboard Backlight

The intensity of the keyboard backlight and the conditions under which this backlight is activated can be configured by opening the Keyboard Light settings.

1. Go to **Settings**.
2. Touch **Display** > **Advanced** > **Keyboard backlight**.
3. Touch Keyboard light level. A slider appears.
4. Adjust the light level by sliding the icon. Change level by 10% increments.
5. Touch **Keyboard light timeout**. The Keyboard light timeout dialog appears
6. Select the amount of time that the backlight stays on before turning off:
  - **6 seconds** (default)
  - **10 seconds**
  - **15 seconds**
  - **30 seconds**
  - **1 minute**
  - **2 minutes**
  - **5 minutes**
  - **Always on**
7. Touch **Home**.

## General Sound Setting



Press the volume buttons on the device to display on-screen volume controls.

Use the Sound settings to configure media and alarm volumes.

1. Go to **Settings**.
2. Touch **Sound**.
3. Touch an option to set sounds.

## Sound Options

- **Ring volume** - Controls the ringtone volume.
- **Media volume** - Controls the music, games, and media volume.
- **Alarm volume** - Controls the alarm clock volume.
- **Notifications volume** - Controls the notification volume.
- **In call volume** - Controls the volume during a call.
- **Scanner volume** - Controls the scanner volume.
- **Volume presets**

	Mutes the ring, notifications, and scanner so that the device does not make sounds or vibrate.
	All sounds except media and alarms are silenced and vibrate mode is active.
	Enables all sounds at the user-defined levels.

- **Do Not Disturb** - Mutes some or all sounds and vibrations.
- **Shortcut to prevent ringing** - Select how the shortcut method prevents ringing.
- **Default notification sound** - Select a sound to play for all system notifications.
- **Default alarm sound** - Select a sound to play for alarms.
- **Other sounds and vibrations**
  - **Screen locking sounds** - Play a sound when locking and unlocking the screen (default – enabled).
  - **Charging sounds and vibration** - Plays a sound and vibrates when power is applied to the device (default - enabled).
  - **Touch sounds** - Play a sound when making screen selections (default – enabled).

## Remapping a Button

Buttons on the device can be programmed to perform different functions or as shortcuts to installed apps. For a list of key names and descriptions, refer to: [techdocs.zebra.com](http://techdocs.zebra.com).

1. Go to **Settings**.
2. Touch **Key Programmer**. A list of programmable buttons displays.
3. Select the button to remap.
4. Touch the **BUTTON REMAPPING** tab or the **SHORTCUT** tab that lists the available functions and applications.
5. Touch a function or application shortcut to map to the button.



**NOTE:** If you select an application shortcut, the application icon appears next to the button on the Key Programmer screen.

## Keyboards

The device provides multiple keyboard options.

- Enterprise Keyboard
- Gboard - GMS devices only
- Physical Keyboard

### Keyboard Configuration

This section describes configuring the device's keyboard.

#### Enabling Keyboards

1. Go to **Settings**.
2. Touch **System** > **Languages & input** > **Virtual keyboard** > **Manage keyboards**.
3. Touch a keyboard to enable.

#### Enabling Virtual Keyboards

Enable a virtual keyboard like Gboard or [Enterprise keyboard](#).



1. Go to **Settings**.
2. Touch **System** > **Languages & input**.
3. In the **KEYBOARDS** section, touch **Physical keyboard**.
4. In the **Physical keyboard** section, enable **Use on-screen keyboard**.

#### Switching Between Keyboards

To switch between keyboards, touch in a text box to display the current keyboard.



**NOTE:** By default, the Gboard is enabled. All other virtual keyboards are disabled.

- On the Gboard keyboard, touch and hold  (GMS devices only).
- On the Android keyboard, touch, and hold  (AOSP devices only).
- On the Enterprise keyboard, touch . Only available with Mobility DNA Enterprise License. Not pre-installed on the device. Contact Zebra Support for more information.

### Using the Android and Gboard Keyboards

Use the Android or Gboard keyboards to enter text in a text field.

- To configure the keyboard settings, touch and hold "," (comma) and then select **Android keyboard settings**.

## Edit Text

Edit entered text and use menu commands to cut, copy, and paste text within or across apps. Some apps do not support editing some or all of the text they display; others may offer their own way to select text.

## Entering Numbers, Symbols, and Special Characters

1. Enter numbers and symbols.
  - Touch and hold one of the top-row keys until a menu appears then select a number or special character.
  - Touch the Shift key once for a single capital letter. Touch the Shift key twice to lock in uppercase. Touch the Shift key a third time to unlock Capslock.
  - Touch **?123** to switch to the numbers and symbols keyboard.
  - Touch the **=\<** key on the numbers and symbols keyboard to view additional symbols.
2. Enter special characters.
  - Touch and hold a number or symbol key to open a menu of additional symbols. A larger version of the key displays briefly over the keyboard.

## Enterprise Keyboard

The Enterprise Keyboard contains multiple keyboard types.



**NOTE:** Only available with Mobility DNA Enterprise License.

- Numeric
- Alpha
- Special characters
- Data capture.

### Numeric Tab

The numeric keyboard is labeled **123**. The keys displayed vary on the app being used. For example, an arrow displays in **Contacts**, however **Done** displays in **Email** account setup.

### Alpha Tab

The alpha keyboard is labeled using the language code. For English, the alpha keyboard is labeled **EN**.

### Additional Character Tab

The additional characters keyboard is labeled **#\*/**.

- Touch 😊 to enter emoji icons in a text message.
- Touch **ABC** to return to the Symbols keyboard.



## Scan Tab

The Scan tab provides an easy data capture feature for scanning barcodes.

## Integrated Keyboard

The device is available with an integrated keyboard in either QWERTY or AZERTY alphanumeric keyboard layout. It features 54 keys, 12 direct function keys, and a power button.



**NOTE:** The integrated keyboard applies to VC8300-8 only.

Most of the keys on the keyboard operate much like a desktop computer. Where a key or key function is not consistent with the keyboard, those differences are described in the following sections.

There are a number of modifier keys that provide access to additional keys and system functions.

See [Setting Keyboard Backlight](#) on page 45 for information on adjusting the keyboard backlight.

**Figure 15** Integrated Keyboard VC8300-8



## Key Descriptions

This section describes the keys on the integrated keyboard.



**NOTE:** The integrated keyboard applies to VC8300-8 only.

**Table 8** Key Descriptions

Key	Function
<b>Regular Keys</b>	

**Table 8** Key Descriptions (Continued)

Key	Function
Arrow	The arrow keys are located near the bottom of the keyboard, and are represented on the keyboard as triangles pointing in different directions. The keys move the cursor around the screen in the direction of the arrow: up, down, left, and right. The left arrow key should not be confused with the backspace DEL key which is depicted as a left arrow. The cursor is the flashing box or underline character that indicates where the next character you type will appear.
DEL	The <b>DEL</b> key (represented on the keyboard as an arrow pointing left) is the backspace key that moves the cursor one character to the left, erasing the previous key stroke. The [Blue] + DEL keys erase the character at the current cursor position.
SHIFT	The <b>SHIFT</b> key is used to display uppercase alpha characters. ↑ appears in the status bar. Pressing the <b>SHIFT</b> key a second time locks the keys that all alpha characters are uppercase. ↓ appears in the status bar. Press the <b>SHIFT</b> key again to return to the default keypad functions.
CTRL and ALT	The <b>CTRL</b> and <b>ALT</b> keys modify the function of the next key pressed and are application dependent. C or A appears in the status bar. Pressing the <b>CTRL</b> or <b>ALT</b> key a second time locks the keys. C or A appears in the status bar. Press the key again to return to the default keypad functions.
TAB	Typically, the <b>TAB</b> key moves the cursor to the next field to the right or downward.
ESC	Generally, the <b>ESC</b> key is used as a keyboard shortcut to close the current menu, dialog box, or activity.
SPACE	Pressing this key inserts a blank space between characters. In a dialog box, pressing the <b>SPACE</b> key enables or disables a check box.
INS	The <b>INS</b> key inserts a character at the cursor position.
<b>Function Keys</b>	
F1 - F12	Function keys perform special, custom-defined functions within an application. These keys are accessed by pressing one of the dedicated function keys on the keyboard, or through the appropriate <b>Blue</b> key sequence. To access the blue function keys, first press the <b>Blue</b> key followed by the appropriate function key. Function keys can be used with the operating system or another application.
<b>Special Keys</b>	
Diamond	The <b>Diamond</b> key provides access to commonly used symbolic characters. Pressing the key brings up the soft input panel (SIP) on-screen keyboard, with symbols mapped to each key.
Blue	The <b>Blue</b> key provides access to additional keys. These functions are color-coded in blueprint on the keycaps.

## Soft Input Panel

The soft input panel (SIP) provides additional commonly used symbolic characters that do not appear on the integrated keyboard.

Press **Diamond** to show the SIP. Press **Diamond** a second time to lock the SIP in place. Press **Diamond** a third time to hide the SIP. Press and hold **Up arrow/Down arrow** and slide up and down to re-position the SIP on the screen.

**Figure 16** Soft Input Panel



## Language Usage

Use the **Language & input** settings to change the device's language, including words added to the dictionary.

### Changing the Language Setting

1. Go to **Settings**.
2. Touch **System > Languages & input**.
3. Touch **Languages**. A list of available languages displays.
4. If the desired language is not listed, touch **Add a language** and select a language from the list.
5. Touch and hold **≡** to the right of the desired language, then drag it to the top of the list.
6. The operating system text changes to the selected language.

### Adding Words to the Dictionary

1. Go to **Settings**.
2. Touch **System > Languages & input > Advanced > Personal dictionary**.
3. If prompted, select the language where this word or phrase is stored.
4. Touch **+** to add a new word or phrase to the dictionary.
5. Enter the word or phrase.
6. In the Shortcut text box, enter a shortcut for the word or phrase.

## Notifications

The user can configure notifications for the device and for specific apps. Device notifications settings allow the user to configure how notifications occur on the device. App notification settings allow the user to configure how notifications for a specific app occur.

To view device notification settings, touch **Settings > Apps & notifications > Notifications**. To view app notifications, **Settings > Apps & notifications > App info**, and then select an app.







# Applications

Apart from the standard pre-installed Android applications, the following table lists Zebra-specific applications installed on the device.









## Installed Applications

Aside from the common Google apps, the Zebra-specific apps that are installed on the device are described in this section.

**Table 9** Apps

Icon	Description
	<b>Battery Manager</b> - Displays battery information, including charge level, status, health and wear level.
	<b>Bluetooth Pairing Utility</b> – Use to pair a Zebra Bluetooth scanner with the device by scanning a barcode.
	<b>DataWedge</b> - Enables data capture using the imager.
	<b>DisplayLink Presenter</b> - Use to present the device screen onto a connected monitor.
	<b>DWDemo</b> - Provides a way to demonstrate the data capture features using the imager.
	<b>Heater Control</b> - Use to enable heaters when using the device in cold environments.
	<b>License Manager</b> - Use to manage software licenses on the device.

**Table 9** Apps (Continued)

Icon	Description
	<b>PTT Express</b> - Use to launch PTT Express client for VoIP communication.
	<b>RxLogger</b> - Use to diagnose device and app issues.
	<b>Settings</b> - Use to configure the device.
	<b>StageNow</b> - Allows the device to stage a device for initial use by initiating the deployment of settings, firmware, and software.
	<b>VC Settings</b> - Use to control settings for the device.
	<b>Velocity</b> - Opens the Ivanti (formerly Wavelink) terminal emulation app.
	<b>VoD</b> - The Video on Device basic app provides a how-to video for proper device cleaning. For Video on Device licensing information, go to <a href="http://learning.zebra.com">learning.zebra.com</a> .
	<b>Zebra Bluetooth Settings</b> - Use to configure Bluetooth logging.
	<b>Zebra Data Services</b> - Use to enable or disable Zebra Data Services. Some options are set by the system administrator.

## Accessing Apps

Access all apps installed on the device using the APPS window.

1. On the Home screen, swipe up from the bottom of the screen.
2. Slide the **APPS** window up or down to view more app icons.
3. Touch an icon to open the app.

## Switching Between Recent Apps

1. Touch **Recent**.

A window appears on the screen with icons of recently used apps.

2. Slide the apps displayed up and down to view all recently used apps.
3. Swipe left or right to remove the app from the list and force close the app.
4. Touch an icon to open an app or touch **Back** to return to the current screen.

## Battery Manager

The Battery Manager provides detailed information about the battery.

This section also provides battery swap procedures for supported devices.



### Opening Battery Manager

- To open the Battery Manager app, swipe up from the bottom of the Home screen, and then touch .

### Battery Manager Information

The Battery Manager displays detailed information about battery charging, health, and status.

**Table 10** Battery Icons

Battery Icon	Description
	Battery charge level is between 85% and 100%.
	Battery charge level is between 19% and 84%.
	Battery charge level is between 0% and 18%.

- **Level** - The current battery charge level as a percentage. Displays -% when the level is unknown.
- **Wear** - The health of the battery in graphical form. When the wear level exceeds 80%, the bar color changes to red.
- **Health** - The health of the battery. If a critical error occurs,  appears. Touch to view the error description.
  - **Decommission** - The battery is past its useful life and should be replaced. See system administrator.
  - **Good** - The battery is good.
  - **Charge error** - An error occurred while charging. See system administrator.
  - **Over Current** - An over-current condition occurred. See system administrator.
  - **Dead** - The battery has no charge. Replace the battery.
  - **Over Voltage** - An over-voltage condition occurred. See system administrator.
  - **Below Temperature** - The battery temperature is below the operating temperature. See system administrator.
  - **Failure Detected** - A failure has been detected in the battery. See system administrator.
  - **Unknown** - See system administrator.

- **Time until Full** - The amount of time until the battery is fully charged.
- **Time since charging** - The amount of time since the device began charging.
- **Time until empty** - The amount of time until the battery is empty.
- **Advanced info** - Touch to view additional battery information.
  - **Battery present status** - Indicates that the battery is present.
  - **Battery level** - The battery charge level as a percentage of scale.
  - **Battery scale** - The battery scale level used to determine battery level (100).
  - **Battery voltage** - The current battery voltage in millivolts.
  - **Battery temperature** - The current battery temperature in degrees Centigrade.
  - **Battery technology** - The type of battery.
  - **Battery current** - The average current into or out of the battery over the last second in mAh.
  - **Battery manufacture date** - The date of manufacture.
  - **Battery serial number** - The battery serial number. The number matches the serial number printed on the battery label.
  - **Battery part number** - The battery part number.
  - **Battery decommission status** - Indicates if the battery is past its life span.
    - **Battery Good** - The battery is in good health.
    - **Decommissioned Battery** - The battery is past its useful life and should be replaced.
  - **Base cumulative charge** - Cumulative charge using Zebra charging equipment only.
  - **Battery present capacity** - Maximum amount of charge that could be pulled from the battery under the present discharge conditions if the battery were fully charged.
  - **Battery health percentage** - With a range from 0 to 100, this is the ratio of “present\_capacity” to “design\_capacity” at a discharge rate of “design\_capacity”.
  - **% decommission threshold** - The default % decommission threshold for a gifted battery as 80%.
  - **Battery present charge** - Amount of usable charge remaining in the battery at present under the current discharge conditions.
  - **Battery total cumulative charge** - The total accumulated charge in all chargers.
  - **Battery error status** - The error status of the battery.
  - **App version** - The application version number.

## DataWedge Demonstration









Use DataWedge Demonstration (DWDemo) to demonstrate data capture functionality. To configure DataWedge, refer to [techdocs.zebra.com/datawedge/](http://techdocs.zebra.com/datawedge/).



**NOTE:** DataWedge is enabled on the Home screen. To disable this feature, go to the DataWedge settings and disable the **Launcher** profile.

## DataWedge Demonstration Icons

**Table 11** DataWedge Demonstration Icons

	Icon	Description
Illumination		Imager illumination is on. Touch to turn illumination off.
Illumination		Imager illumination is off. Touch to turn illumination on.
Data Capture		Indicates a USB scanner is connected to the device.
Data Capture		Indicates a USB scanner is not connected to the device.
Data Capture		A Bluetooth scanner is connected.
Data Capture		A Bluetooth scanner is not connected.
Scan Mode		Imager is in picklist mode. Touch to change to normal scan mode.
Scan Mode		Imager is in normal scan mode. Touch to change to picklist mode.
Menu		Opens a menu to view the application information or to set the application DataWedge profile.

## Selecting a Scanner

See the Data Capture section for more information.

1. To select a scanner, touch  > **Settings** > **Scanner Selection**.
2. Press the scanner trigger button or touch the on-screen yellow scan button to capture data. The data appears in the text field below the yellow button.

## Heater Control

The device heater ensures optimum performance in freezers.



**IMPORTANT:** The Heater Control app is only applicable to freezer configurations.

The heater benefits include:

- Touch screen heater clears condensation on the display.
- Port heater prevents condensation on contacts.
- UPS Battery requires a heater to operate below freezing temperatures.



- The user interface displays current temperatures.

### Temperatures

The Status tab displays the current temperature for the following:

- Serial Ports
- USB Ports
- Battery
- Keyboard
- Touch Panel (Freezer configurations only)
- Ambient.

### Serial Port Heater

Use the Serial Ports Heater tab to enable and set the heater for the serial ports.

- **Enable Heater** - Turns on or off the serial port heater. When on, the switch turns red.
- **Heater on threshold** - Set the temperature at which the heater turns on (default - 5°C/41°F).
- **Heater off threshold** - Set the temperature at which the heater turns off (default - 15°C/59°F).

### USB Port Heater

Use the USB Ports Heater tab to enable and set the heater for the USB ports.

- **Enable Heater** - Turns on or off the USB port heater. When on, the switch turns red.
- **Heater on threshold** - Set the temperature at which the heater turns on (default - 5°C/41°F).
- **Heater off threshold** - Set the temperature at which the heater turns off (default - 15°C/59°F).

### Battery Heater

Use the Battery Heater tab to enable and set the heater for the battery.

- **Enable Heater** - Turns on or off the battery heater. When on, the switch turns red.
- **Heater on threshold** - Set the temperature at which the heater turns on (default - 15°C/59°F).
- **Heater off threshold** - Set the temperature at which the heater turns off (default - 20°C/68°F).

### Touch Panel Heater



**NOTE:** Touch Panel Heater tab is available on Freezer configurations only.

Use the Touch Panel Heater tab to enable and set the heater for the touch panel.

- **Enable Heater** - Turns on or off the Touch panel heater. When on, the switch turns red.
- **Heater on threshold** - Set the temperature at which the heater turns on (default - 15°C/59°F).
- **Heater off threshold** - Set the temperature at which the heater turns off (default - 22°C/72°F).

### Keyboard Heater

Use the Keyboard Heater tab to enable and set the heater for the keyboard.

- **Enable Heater** - Turns on or off the keyboard heater. When on, the switch turns red.
- **Heater on threshold** - Set the temperature at which the heater turns on (default - 15°C/59°F).

- **Heater off threshold** - Set the temperature at which the heater turns off (default - 22°C/72°F).

## PTT Express Voice Client

PTT Express Voice Client enables Push-To-Talk (PTT) communication between disparate enterprise devices. Leveraging existing Wireless Local Area Network (WLAN) infrastructure, PTT Express delivers simple PTT communication without requiring a voice communication server.



**NOTE:** Requires a PTT Express License.



**IMPORTANT:** The optional M1000 Speaker/Microphone is required to use PTT Express on the VC8300.

- **Group Call** - Press and hold **PTT (Talk)** to start communicating with other voice client users.
- **Private Response** - Double-press **PTT** to respond to the originator of the last broadcast or to make a Private Response.

Refer to the PTT Express User Guide at [zebra.com/support](http://zebra.com/support) for information on configuring the PTT Express Client application.

## PTT Audible Indicators

The following tones provide helpful cues when using the voice client.

- **Talk Tone:** Double chirp. Plays when the Talk button is depressed. This is a prompt for you to start talking.
- **Access Tone:** Single beep. Plays when another user just finished a broadcast or response. You can now initiate a Group Broadcast or Private Response.
- **Busy Tone:** Continuous tone. Plays when the Talk button is depressed and another user is already communicating on the same talkgroup. Plays after the maximum allowed talk time is reached (60 seconds).
- **Network Tone:**
  - Three increasing pitch beeps. Plays when PTT Express acquires the WLAN connection and the service is enabled.
  - Three decreasing pitch beeps. Plays when PTT Express loses the WLAN connection or the service is disabled.





## PTT Notification Icons

Notification icons indicate the current state of the PTT Express Voice client.

**Table 12** PTT Express Icons

Status Icon	Description
	The PTT Express Voice client is disabled.
	The PTT Express Voice client is enabled but not connected to a WLAN.

**Table 12** PTT Express Icons (Continued)

Status Icon	Description
	The PTT Express Voice client is enabled, connected to a WLAN, and listening on the Talk Group indicated by the number next to the icon.
	The PTT Express Voice client is enabled, connected to a WLAN, and communicating on the Talk Group indicated by the number next to the icon.
	The PTT Express Voice client is enabled, connected to a WLAN, and in a private response.
	The PTT Express Voice client is enabled and muted.
	The PTT Express Voice client is enabled but it is not able to communicate due to a VoIP telephony call in progress.

## Enabling PTT Communication

1. Swipe up from the bottom of the Home screen and touch .
2. Slide the Enable/Disable Switch to the **ON** position. The button changes to **ON**.

## Selecting a Talk Group

There are 32 Talk Groups that can be selected by PTT Express users. However, only one talk group can be enabled at a time on the device.

- Touch one of the 32 Talk Groups. The selected Talk Group is highlighted.

## PTT Communication

This section describes the default PTT Express client configuration. Refer to the PTT Express V1.2 User Guide for detailed information on using the client.

All calls are initiated using the Talk button.

### Creating a Group Call

1. Press and hold **PTT** (1) (or **Talk** on the headset) and listen for the talk tone.  
If you hear a busy tone, release the button and wait a moment before making another attempt. Ensure that PTT Express and the WLAN are enabled.



**NOTE:** Holding the button for more than 60 seconds (default) drops the call, allowing others to make Group calls. Release the button when finished talking to allow others to make calls.

2. Start talking after hearing the talk tone.
3. Release the button when finished talking.

## Responding with a Private Response

The Private Response can only be initiated once a Group Call has been established. The initial Private Response is made to the originator of the Group Call.

1. Wait for an access tone.
2. Within 10 seconds, double-press **PTT**, and listen for the talk tone.
3. If you hear a busy tone, release the button and wait a moment before making another attempt. Ensure that PTT Express and the WLAN are enabled.
4. Start talking after the talk tone plays.
5. Release the button when finished talking.

## Disabling PTT Communication

1. Swipe up from the bottom of the Home screen and touch .
2. Slide the **Enable/Disable Switch** to the **OFF** position. The button changes to **OFF**.

## RxLogger

RxLogger is a comprehensive diagnostic tool that provides application and system metrics, and diagnoses device and application issues.

RxLogger logs the following information: CPU load, memory load, memory snapshots, battery consumption, power states, wireless logging, cellular logging, TCP dumps, Bluetooth logging, GPS logging, logcat, FTP push/pull, ANR dumps, etc. All generated logs and files are saved onto flash storage on the device (internal or external).

## RxLogger Configuration

RxLogger is built with an extensible plug-in architecture and comes packaged with a number of plug-ins already built-in. For information on configuring RxLogger, refer to [techdocs.zebra.com/rxlogger/](http://techdocs.zebra.com/rxlogger/).

To open the configuration screen, from the RxLogger home screen touch **Settings**.

## Configuration File

RxLogger configuration can be set using an XML file.

The config.xml configuration file is located in the RxLogger\config folder. Copy the file from the device to a host computer using a USB connection. Edit the configuration file and then replace the XML file on the device. There is no need to stop and restart the RxLogger service since the file change is automatically detected.

The config.xml configuration file is located on the microSD card in the RxLogger\config folder. Copy the file from the device to a host computer using a USB connection. Edit the configuration file and then replace the XML file on the device. There is no need to stop and restart the RxLogger service since the file change is automatically detected.

## Enabling Logging

1. Swipe the screen up and select .

2. Touch **Start**.

## Disabling Logging

1. Swipe the screen up and select .
2. Touch **Stop**.

## Extracting Log Files

1. Connect the device to a host computer using an USB connection.
2. Using a file explorer, navigate to the RxLogger folder.
3. Copy the file from the device to the host computer.
4. Disconnect the device from the host computer.

## Backing Up Data

RxLogger Utility allows the user to make a zip file of the RxLogger folder in the device, which by default contains all the RxLogger logs stored in the device.

- To save the backup data, touch  > **BackupNow**.

## RxLogger Utility

RxLogger Utility is a data monitoring application for viewing logs in the device while RxLogger is running. Logs and RxLogger Utility features are accessed using Main Chat Head.

### Initiating the Main Chat Head

1. Open **RxLogger**.
2. Touch  > **Toggle Chat Head**.  
The Main Chat Head icon appears on the screen.
3. Touch and drag the Main Chat head icon to move it around the screen.

### Removing the Main Chat Head

1. Touch and drag the icon.  
A circle with an X appears.
2. Move the icon over the circle and then release.

### Viewing Logs

1. Touch the Main Chat Head icon.  
The RxLogger Utility screen appears.
2. Touch a log to open it.  
The user can open many logs with each displaying a new Sub Chat Head.

3. If necessary, scroll left or right to view additional Sub Chat Head icons.
4. Touch a Sub Chat Head to display the log contents.

### Removing a Sub Chat Head Icon

- To remove a Sub Chat Head icon, press and hold the icon until it disappears.

### Backing Up In Overlay View

RxLogger Utility allows the user to make a zip file of the RxLogger folder in the device, which by default contains all the RxLogger logs stored in the device.

The Backup icon is always available in Overlay View.

1. Touch .

The Backup dialog box appears.

2. Touch **Yes** to create the backup.

## VC Settings

Use the VC Settings app with a third-party vehicle cradle and when the device is mounted on a forklift.



**NOTE:** Ignition detect requires a CA1220 power extension cable.

## Display

Enable/disable **Stay awake** to keep the device awake when the external power source is connected.

## Peripheral Power

To provide power to an optional peripheral, turn on power to the appropriate port.

- +12V output on USB Port 2 - Enable/disable additional power for the powered USB port.
- +5V output on Serial Port 1 - Enable/disable power for serial port 1.
- +5V output on Serial Port 2 - Enable/disable power for serial port 2.

## Ignition Detection

Use Ignition Detection settings to control if the device turns on or off when the user turns on the ignition.

- Ignition ON Turns on VC - Enable/disable the device to turn on when the user turns the ignition on.
- Ignition OFF shuts down VC - Enable/disable the device to turn off when the user turns the ignition off.
- Shut down VC after - Select the number of minutes that the device turns off after the user turns off the ignition.

## Switching WIFI Antennas

Use to select which Wi-Fi antenna to use.

- **Choose Antenna** - Select antenna. Options: **Internal Antenna** (default) or **External Antenna**.

## Built-In Speaker

Enable/disable to keep the built-in speaker on when the optional M1000 Speaker/Microphone is connected.

## Screen Blanking

The optional Screen Blanking setting turns the screen off when the vehicle is moving and back on when the vehicle stops.



**NOTE:** To use Screen Blanking, first, connect one of the two DB9 serial ports on the device to a user-supplied switch or relay. See [Wiring for Screen Blanking](#) on page 30.

- **Screen Blanking** - Enable/disable screen blanking feature.
- **Input signal** - Select the port that the screen blank cable is connected to. Options: **Input 1** or **Input 2**.
- **Source polarity** - Select blank screen option. De-select to disconnect the blank screen option.
- **Blank screen delay** - Set the amount of time after the device receives the signal to blank the screen. Options 1 to 30 seconds (default - 1).

## Velocity

Velocity transforms the traditional green screen telnet application into a modern smart device application. It accomplishes all of this without modifying the host application, offering workers a familiar experience optimized for today's touch screen mobile computers.

To open Velocity, swipe up from the Home screen and touch .

- Access the context menu for quick access to function or control keys.
- Access the Velocity menu for starting new sessions or switching between green and reformatted screens.

Refer to the Velocity user guide for more information. Go to <http://download.wavelink.com/Files/Velocity-qsg-28042016.pdf>.

# Data Capture

This section provides information for capturing barcode data using various scanning options.

The VC8300 supports scanners that use the Human Interface Device (HID) and Simple Serial Interface (SSI) protocols. In HID mode, the scanner sends data to the VC8300 like entering characters on a keyboard. In SSI mode, the scanner sends data to the VC8300 in packets which can be ASCII data or as part of a larger message.

The device supports data capture using:

- Tethered serial scanner connected to COM1 or COM2 port:
  - DS3508-ER, HD, SR
  - DS3608-SR, ER, HP, HD
  - LI3608-SR
  - LS3408-ER, FZ
  - Other tethered serial scanners.
- Tethered USB scanner connected to a USB host port:
  - DS3508-ER, HD, SR (HID mode only)
  - DS3608-SR, ER, HP, HD (HID and SSI modes)
  - LI3608-SR (HID mode only)
  - LS3408-ER, FZ (HID mode only)
  - Other USB scanners (HID mode only).
- Wireless scanner connected via Bluetooth:
  - DS3678-SR, ER, HP, HD (HID and SSI modes)
  - LI3678-SR (HID mode only)
  - LS3578-ER, SR, HD, FZ (HID mode only)
  - DS3578-SR, ER, HD (HID mode only)
  - RS507/RS507x (HID and SSI modes)
  - RS5100 (HID and SSI modes)
  - RS6000 (HID and SSI modes)
  - Other Bluetooth scanners (HID mode only).



## Imaging

The device with an integrated 2D imager has the following features:

- Omnidirectional reading of a variety of barcode symbologies, including the most popular linear, postal, PDF417, Digimarc, and 2D matrix code types.
- The ability to capture and download images to a host for a variety of imaging applications.
- Advanced intuitive laser aiming cross-hair and dot aiming for easy point-and-shoot operation.

The imager uses imaging technology to take a picture of a barcode, stores the resulting image in memory, and executes state-of-the-art software decoding algorithms to extract the barcode data from the image.

## Operational Modes

The device with an integrated imager supports three modes of operation.

Activate each mode by pressing **Scan**.

- Decode mode — The device attempts to locate and decode enabled barcodes within its field of view. The imager remains in this mode as long as you hold the scan button, or until it decodes a barcode.



**NOTE:** To enable Pick List Mode, configure in DataWedge or set in an application using a API command.

- Pick List mode — Selectively decode a barcode when more than one barcode is in the device's field of view by moving the aiming crosshair or dot over the required barcode. Use this feature for pick lists containing multiple barcodes and manufacturing or transport labels containing more than one barcode type (either 1D or 2D).



**NOTE:** To enable Basic MultiBarcode Mode, configure in DataWedge or set in an application using a API command.

- Basic MultiBarcode Mode — In this mode, the device attempts to locate and decode a specific number of unique barcodes within its field of view. The device remains in this mode as long as the user holds the scan button, or until it decodes all the barcodes.
  - The device attempts to scan the programmed number of unique barcodes (from 2 through 100).
  - If there are duplicate barcodes (same symbology type and data), only one of the duplicate barcodes is decoded and the remainder are ignored. If the label has two duplicate barcodes plus another two different barcodes, a maximum of three barcodes will be decoded from that label; one will be ignored as a duplicate.
  - Barcodes can be of multiple symbology types and still be acquired together. For example, if the specified quantity for a Basic MultiBarcode scan is four, two barcodes can be symbology type Code 128 and the other two can be symbology type Code 39.
  - If the specified number of unique barcodes is not initially in view of the device, the device will not decode any data until the device is moved to capture the additional barcode(s) or time out occurs. If the device field of view contains a number of barcodes greater than the specified quantity, the device randomly decodes barcode(s) until the specified number of unique barcodes is reached. For example, if the count is set to two and eight barcodes are in the field of view, the device decodes the first two unique barcodes it sees, returning the data in random order.
- Basic MultiBarcode Mode does not support concatenated barcodes.

## Scanning Considerations

Typically, scanning is a simple matter of aim, scan, and decode, with a few quick trial efforts to master it.

However, consider the following to optimize scanning performance:

- **Range** — Scanners decode best over a particular working range — minimum and maximum distances from the barcode. This range varies according to barcode density and scanning device optics. Scan within range for quick and constant decodes; scanning too close or too far away prevents decodes. Move the scanner closer and further away to find the right working range for the barcodes being scanned.
- **Angle** — Scanning angle is important for quick decodes. When the illumination/flash reflects directly back into the imager, the specular reflection can blind/saturate the imager. To avoid this, scan the barcode so that the beam does not bounce directly back. Do not scan at too sharp an angle; the scanner needs to collect scattered reflections from the scan to make a successful decode. Practice quickly shows what tolerances to work within.
- Hold the device farther away for larger symbols.
- Move the device closer for symbols with bars that are close together.





**NOTE:** Scanning procedures depend on the app and device configuration. An app may use different scanning procedures from the one listed above.

## Connecting an RS-232 Scanner

Before using an RS-232 scanner with the device, connect the scanner to the device.

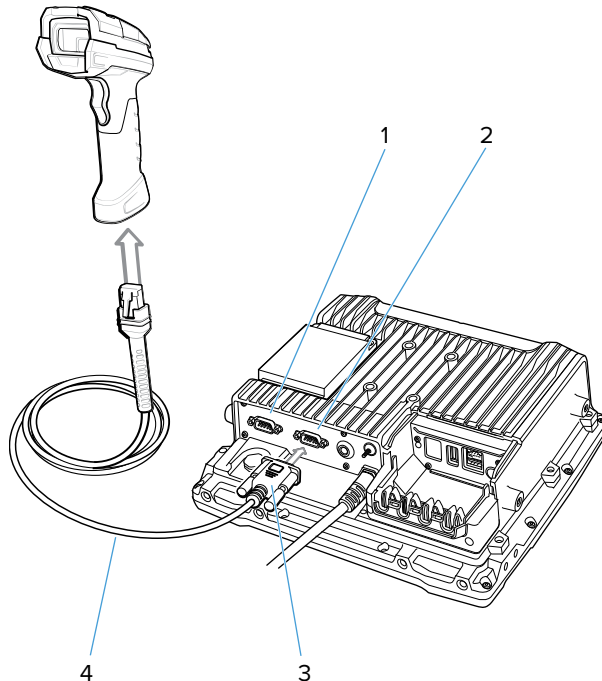
1. On the bottom of the device, remove the connector cover from either the COM1 or COM2 port.
2. Using the thumb screws (3) connect the scanner cable RS-232 connector (4) to either the COM1 (2) or COM2 (1) port and to the scanner.



3. Tighten the RS-232 connect thumb screws.
4. On the VC8300 home screen, swipe up from the bottom of the Home screen and touch .
5. Touch **+5V output on Serial Port 1** if the RS-232 scanner is connected to the COM1 port or **+5V output on Serial Port 2** if the scanner is connected to the COM 2 port. The scanner beeps.
6. Touch **Home**.
7. Swipe up from the bottom of the Home screen and touch .
8. Select a profile.
9. Scroll down to **Serial port input from Serial port 1** or **Serial port input from Serial port 2**.
10. Touch **Enabled**. A check appears in the checkbox to the right.



**CAUTION:** By default, serial settings are set for all Zebra scanners. Other non-Zebra scanner may need configuration. Refer to the scanner user guide for more information.

11. Touch **Serial port configuration**.
12. Touch **Baud rate**.
13. Select one of the available baud rates.
14. Touch **Data bits**.
15. Select **7** or **8**.
16. Touch **Parity**.
17. Select a parity value.
18. Touch **Stop bits**.
19. Select **1** or **2**.
20. Touch **Back**.
21. Touch **Home**.

## Connecting a USB Scanner to a Device

When connecting a USB scanner to a device, connect in either SSI or HID mode.

To connect a USB scanner, use one of the following methods:

- Simple Serial Interface (SSI) mode
- Human Interface Device (HID) mode.

### Connecting Using Simple Serial Interface

Pair the USB scanner to the device using Simple Serial Interface (SSI).



**IMPORTANT:** Make sure that DS3608 scanner has firmware version CAACJS00-004-R00D0.DAT or higher.

To connect a USB scanner using SSI mode:

1. On the back of the VC8300, remove the dust cover.

2. Connect the scanner cable USB connector to either USB port. The scanner beeps.

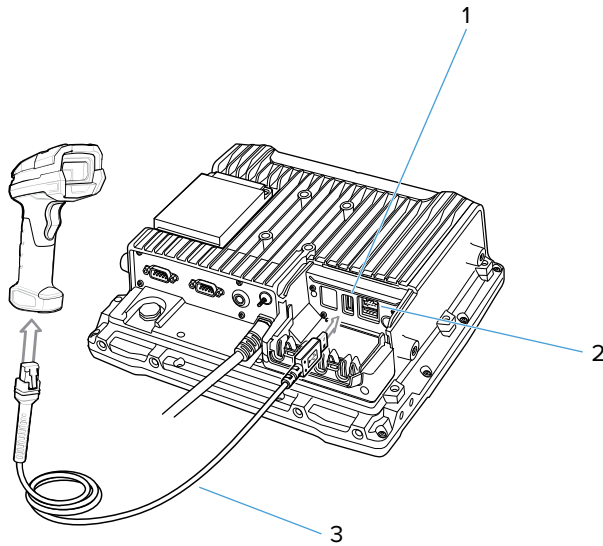

1	USB port
2	Powered USB port
3	USB cable

3. Place cable into strain relief.
4. Replace the dust cover.
5. Ensure that the scanner is in SSI mode. Refer to the scanner Product Reference Guide and scan the SSI Over USB CDC barcode.
6. On the VC8300 home screen, swipe up from the bottom of the Home screen and touch .
7. Select a profile.
8. Configure additional settings.

## Connecting Using HID Mode

Pair the USB scanner to the device using HID.

It is possible to charge the scanner when connected to USB with BC 1.2. This is supported only in HID mode and not for SSI over USB when the scanner is paired with a cradle.

1. On the back of the VC8300, remove the dust cover.

2. Connect the scanner cable USB connector to either USB port. The scanner beeps.

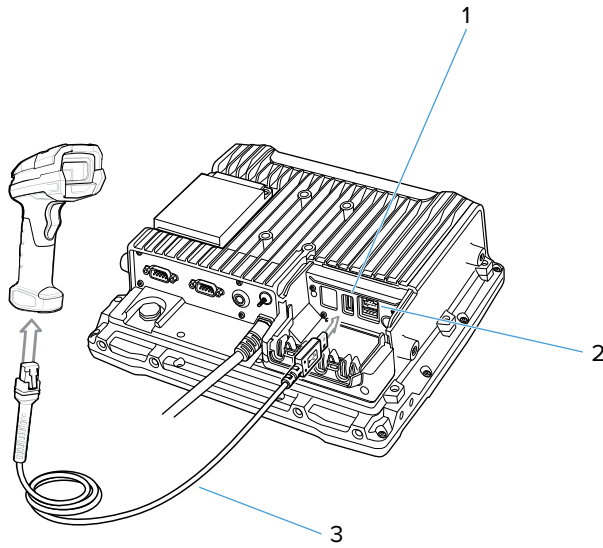

1	USB port
2	Powered USB port
3	USB cable

3. Place the cable into the strain relief.
4. Replace the dust cover.
5. Ensure that the scanner is in HID mode. Refer to the Product Reference Guide and scan the HID Keyboard barcode or perform a factory reset.

## Scanning with the DS3678 Bluetooth Scanner

Use the DS3678 Bluetooth Scanner to capture barcode data.

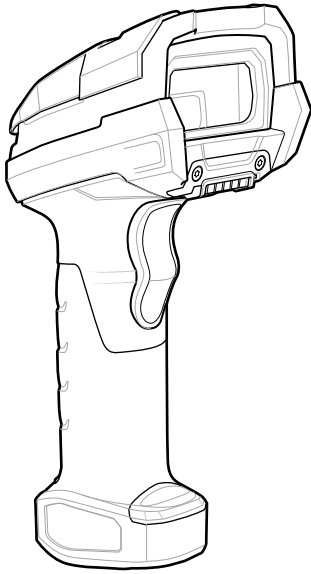
**Figure 17** DS3678 Digital Scanner

Refer to the DS3678 Product Reference Guide for more information.



**NOTE:** To read a barcode, a scan-enabled app is required. The device contains the DataWedge app that allows the user to enable the scanner to decode barcode data and display the barcode content.

To scan with the DS3678 scanner:

1. Pair the scanner with the device. See [Pairing Bluetooth Scanners](#) for more information.
2. Ensure that an app is open on the device and a text field is in focus (text cursor in text field).
3. Point the scanner at a barcode.

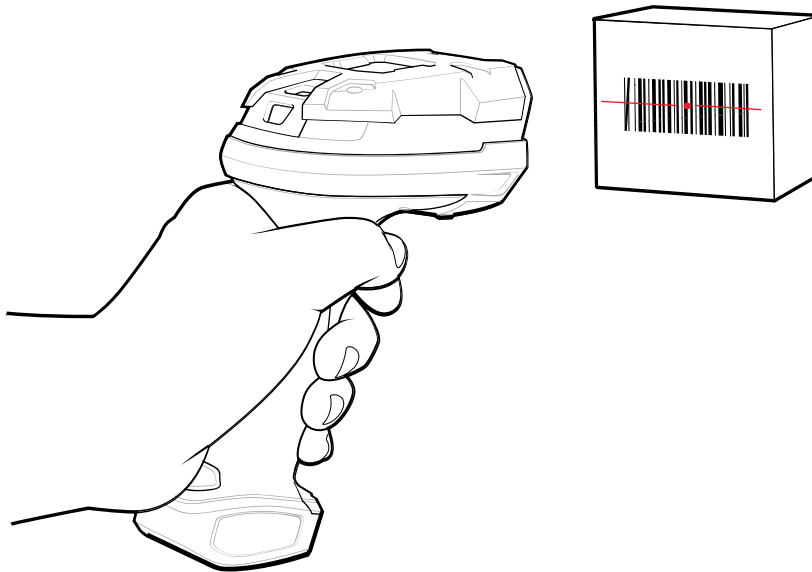

4. Press and hold the trigger.

Ensure the barcode is within the area formed by the aiming pattern. The aiming dot increases visibility in bright lighting conditions.



The captured data appears in the text field.

## Scanning with the LI3678 Linear Imager

Use the LI3678 linear imager to capture barcode data.

**Figure 18** LI3678 Bluetooth Scanner

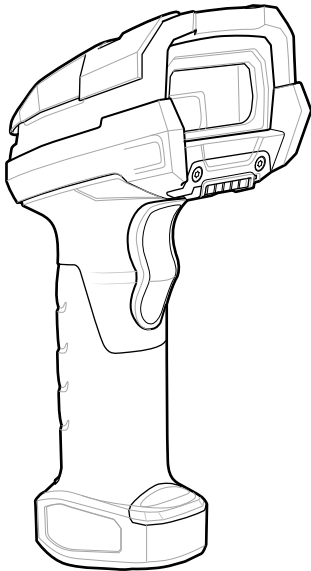

Refer to the LI3678 Product Reference Guide for more information.



**NOTE:** To read a barcode, a scan-enabled app is required. The device contains the DataWedge app that allows the user to enable the scanner to decode barcode data and display the barcode content.

To scan with the LI3678:

1. Pair the LI3678 with the device. See [Pairing a Bluetooth Scanner](#) for more information.
2. Ensure that an app is open on the device and a text field is in focus (text cursor in text field).
3. Point the LI3678 at a barcode.

4. Press and hold the trigger.

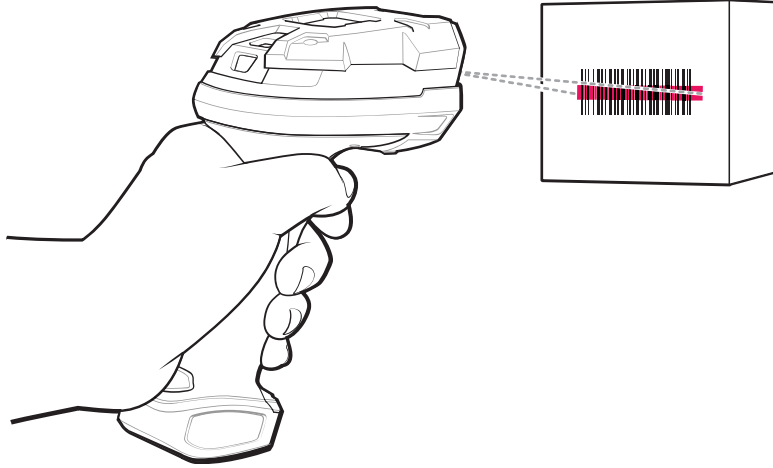

5. Ensure the aiming pattern covers the barcode.

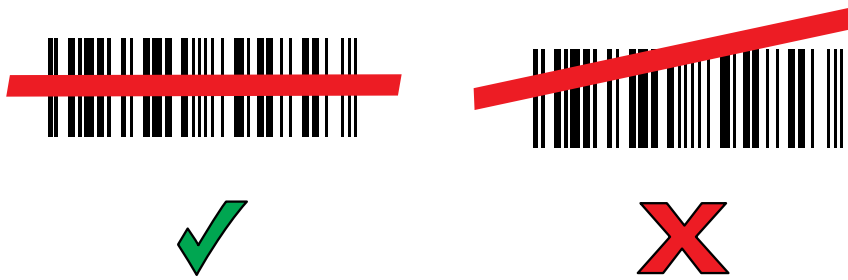

Upon successful decode, the scanner beeps and the LED displays a single green flash.  
The captured data appears in the text field.

## Scanning with the DS3578 Bluetooth Scanner

Use the DS3678 Bluetooth Scanner to capture barcode data.



**Figure 19** DS3678 Digital Scanner



Refer to the DS3678 Product Reference Guide for more information.



**NOTE:** To read a barcode, a scan-enabled app is required. The device contains the DataWedge app that allows the user to enable the scanner to decode barcode data and display the barcode content.

To scan with the DS3578 scanner:

1. Pair the scanner with the device. See [Pairing Bluetooth Scanners](#) for more information.
2. Ensure that an app is open on the device and a text field is in focus (text cursor in text field).
3. Point the scanner at a barcode.

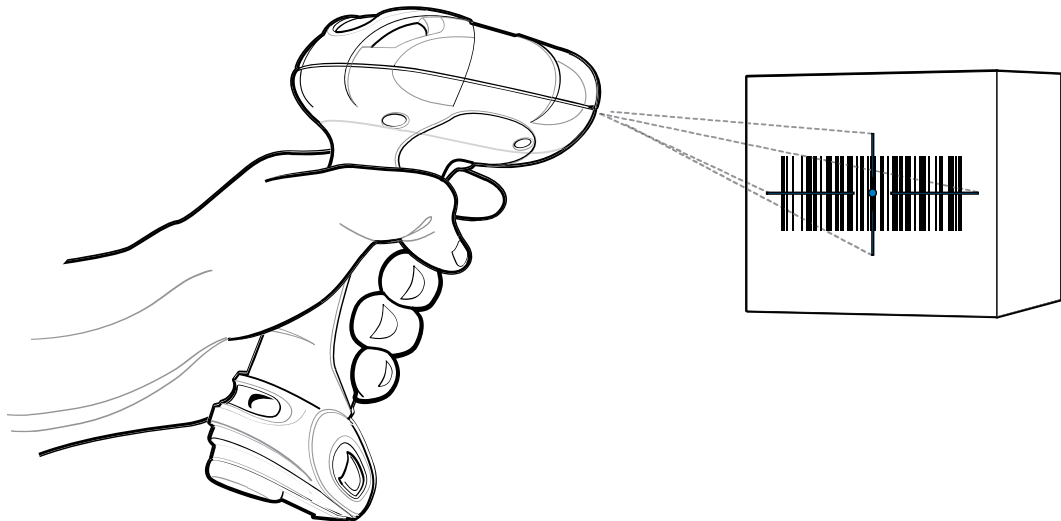

4. Press and hold the trigger.

Ensure the barcode is within the area formed by the aiming pattern. The aiming dot increases visibility in bright lighting conditions.

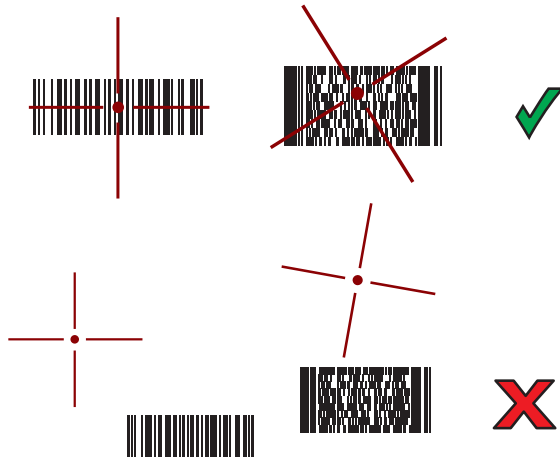

The captured data appears in the text field.

## Scanning with the RS507/RS507X Hands-Free Imager

Use the RS507/RS507X Hands-Free Imager to capture barcode data.

**Figure 20** RS507/RS507X Hands-Free Imager

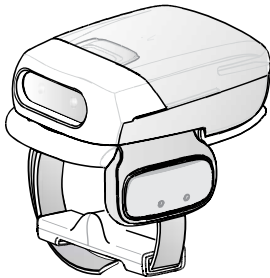

Refer to the RS507/RS507X Hands-free Imager Product Reference Guide for more information.



**NOTE:** To read a barcode, a scan-enabled app is required. The device contains the DataWedge app that allows the user to enable the scanner to decode barcode data and display the barcode content.

To scan with the RS507/RS507x:

1. Pair the RS507/RS507X with the device.
2. Ensure that an app is open on the device and a text field is in focus (text cursor in text field).

3. Point the RS507/RS507X at a barcode.

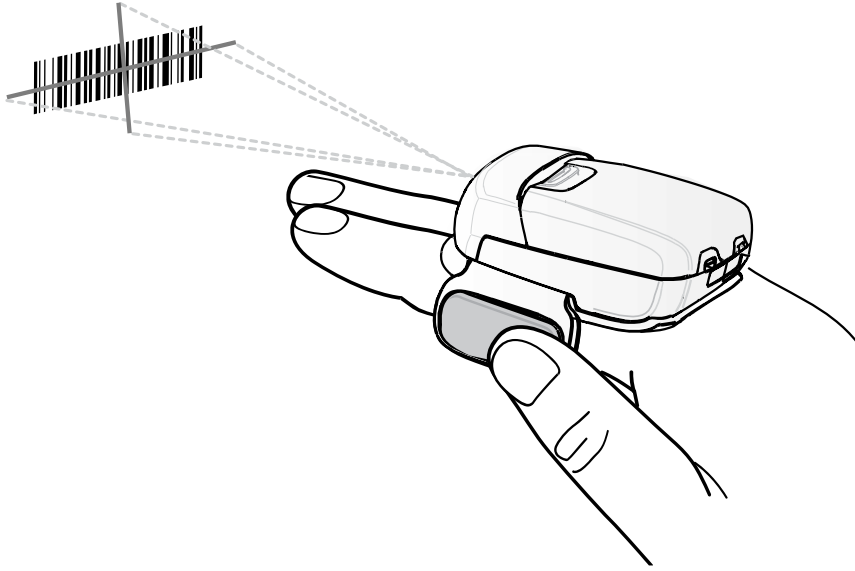

4. Press and hold the trigger.

The red laser aiming pattern turns on to assist in aiming. Ensure the barcode is within the area formed by the cross-hairs in the aiming pattern. The aiming dot increases visibility in bright lighting conditions.

**Figure 21** RS507/RS507X Aiming Pattern

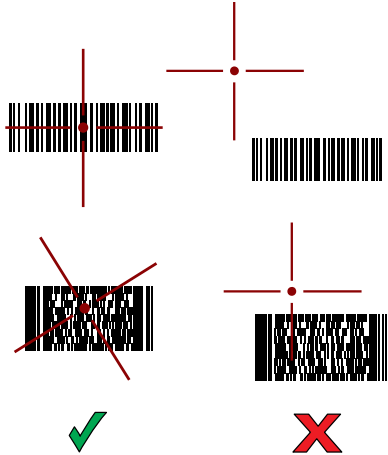

When the RS507/RS507X is in Pick List mode, the RS507/RS507X does not decode the barcode until the center of the crosshair touches the barcode.

**Figure 22** RS507/RS507X Pick List Mode with Multiple Barcodes in Aiming Pattern

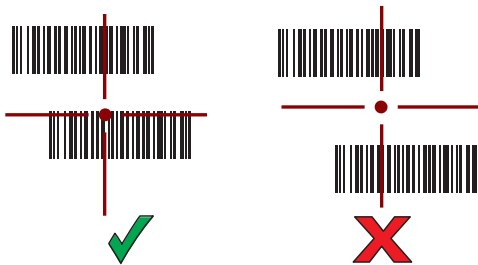

The RS507/RS507X LEDs light green and a beep sounds to indicate the barcode was decoded successfully.

The captured data appears in the text field.

## Scanning with the RS5100 Ring Scanner

Use the RS5100 Ring Scanner to capture barcode data.

**Figure 23** RS5100 Ring Scanner

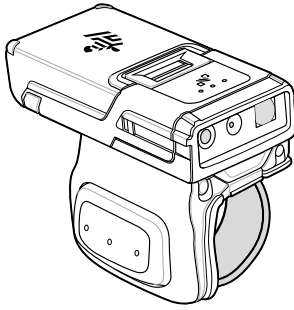

Refer to the RS5100 Ring Scanner Product Reference Guide for more information.



**NOTE:** To read a barcode, a scan-enabled app is required. The device contains the DataWedge app that allows the user to enable the scanner to decode barcode data and display the barcode content.

To scan with the RS5100:

1. Pair the RS5100 with the device.
2. Ensure that an app is open on the device and a text field is in focus (text cursor in text field).
3. Point the RS5100 at a barcode.

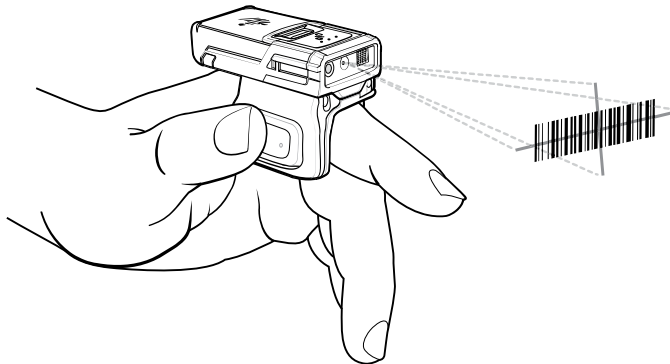

4. Press and hold the trigger.

The red laser aiming pattern turns on to assist in aiming. Ensure the barcode is within the area formed by the cross-hairs in the aiming pattern. The aiming dot increases visibility in bright lighting conditions.

**Figure 24** RS5100 Aiming Pattern

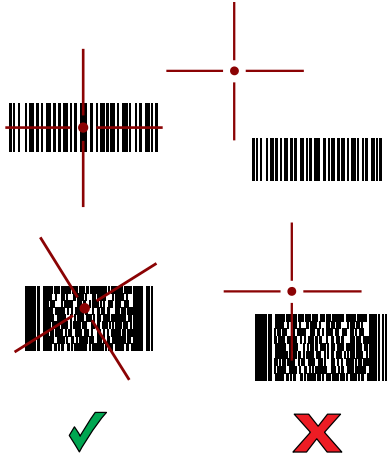

When the RS5100 is in Pick List mode, the RS5100 does not decode the barcode until the center of the crosshair touches the barcode.

**Figure 25** RS5100 Pick List Mode with Multiple Barcodes in Aiming Pattern



The RS5100 LEDs light green and a beep sounds to indicate the barcode was decoded successfully. The captured data appears in the text field.

## Scanning with the RS6000 Bluetooth Ring Scanner

Use the RS6000 Bluetooth Ring Scanner to capture barcode data.

**Figure 26** RS6000 Bluetooth Ring Scanner

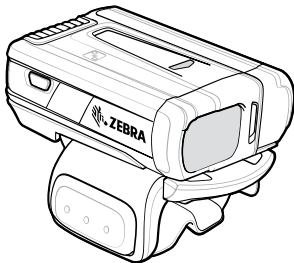

Refer to the RS6000 Bluetooth Ring Scanner Product Reference Guide for more information.



**NOTE:** To read a barcode, a scan-enabled app is required. The device contains the DataWedge app that allows the user to enable the scanner to decode barcode data and display the barcode content.

To scan with the RS6000:

1. Pair the RS6000 with the device.
2. Ensure that an app is open on the device and a text field is in focus (text cursor in text field).
3. Point the RS6000 at a barcode.

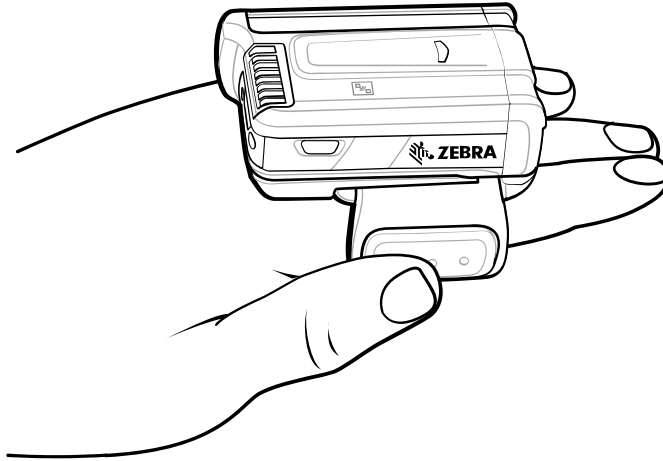

#### 4. Press and hold the trigger.

The red laser aiming pattern turns on to assist in aiming. Ensure the barcode is within the area formed by the cross-hairs in the aiming pattern. The aiming dot increases visibility in bright lighting conditions.

**Figure 27** RS6000 Aiming Pattern

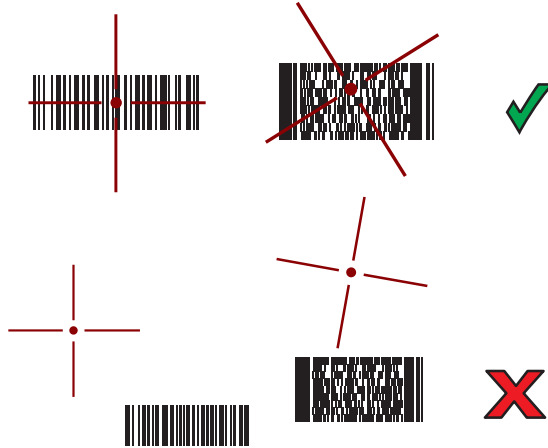

When the RS6000 is in Pick List mode, the RS6000 does not decode the barcode until the center of the crosshair touches the barcode.

**Figure 28** RS6000 Pick List Mode with Multiple Barcodes in Aiming Pattern



The RS6000 LEDs light green and a beep sounds to indicate the barcode was decoded successfully. The captured data appears in the text field.

## Pairing a Bluetooth Ring Scanner

Before using a Bluetooth Ring Scanner with the device, connect the device to the Ring Scanner.

To connect the Ring Scanner to the device, use one of the following methods:

- Near Field Communication (NFC) (RS6000 only)
- Simple Serial Interface (SSI)
- Bluetooth Human Interface Device (HID) Mode.

### Pairing Using Simple Serial Interface (SSI)

Pair the Ring Scanner to the device using Simple Serial Interface.



1. Swipe up from the bottom of the Home screen and touch .
2. Using the Ring Scanner, scan the barcode on the screen.

The Ring Scanner emits a string of high/low/high/low beeps. The Scan LED flashes green indicating that the Ring Scanner is attempting to establish a connection with the device. When a connection is established, the Scan LED turns off and the Ring Scanner emits one string of low/high beeps.

A notification appears on the Notification panel and the  icon appears in the Status bar.

## Pairing Using Bluetooth Human Interface Device

Pair the Ring Scanner to the device using Human Interface Device (HID).

1. Ensure that Bluetooth is enabled on both devices.
2. Ensure that the Bluetooth device to discover is in discoverable mode.
3. Ensure that the two devices are within 10 meters (32.8 feet) of one another.
4. Place the Ring Scanner in HID mode. If the Ring Scanner is already in HID mode, skip to step 5.
  - a) Remove the battery from the Ring Scanner.
  - b) Press and hold **Restore**.
  - c) Install the battery onto the Ring Scanner.
  - d) Keep holding the Restore key for about five seconds until a chirp is heard and the Scan LEDs flash green.
  - e) Scan the barcode below to place the Ring Scanner in HID mode.

**Figure 29** RS507 Bluetooth HID Barcode

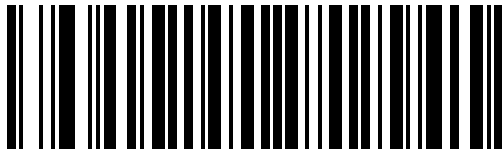

**Figure 30** RS6000 Bluetooth HID Barcode

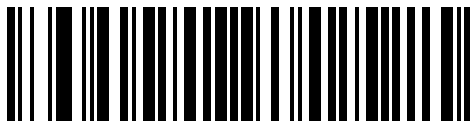

5. Remove the battery from the Ring Scanner.
6. Re-install the battery into the Ring Scanner.
7. Swipe down from the Status bar to open the Quick Access panel and then touch .
8. Touch **Bluetooth**.
9. Touch **Pair new device**. The device begins searching for discoverable Bluetooth devices in the area and displays them under **Available devices**.

10. Scroll through the list and select Ring Scanner.

The device connects to the Ring Scanner and **Connected** appears below the device name. The Bluetooth device is added to the **Paired devices** list and a trusted (“paired”) connection is established.

A notification appears on the Notification panel and the  icon appears in the Status bar.

## Pairing a Bluetooth Scanner

Before using a Bluetooth scanner with the device, connect the device to the Bluetooth scanner.

Connect the scanner to the device using one of the following methods:

- Simple Serial Interface (SSI) mode
- Bluetooth Human Interface Device (HID) mode

### Pairing Using Simple Serial Interface

Pair the Bluetooth scanner to the device using Simple Serial Interface (SSI).

1. Ensure that the two devices are within 10 meters (32.8 feet) of one another.
2. Install the battery into the scanner.
3. Swipe up from the bottom of the Home screen and touch .
4. Using the Bluetooth scanner, scan the barcode on the screen.

The scanner emits a string of high/low/high/low beeps. The Scan LED flashes green indicating that the Ring Scanner is attempting to establish a connection with the device. When a connection is established, the Scan LED turns off and the Ring Scanner emits one string of low/high beeps.

A notification appears on the Notification panel and the  icon appears in the Status bar.

### Pairing Using Bluetooth Human Interface Device

Pair the Bluetooth scanner to the device using HID.

To pair the scanner with the device using HID:

1. Remove the battery from the scanner.
2. Replace the battery.
3. After the scanner reboots, scan the barcode below to place the scanner in HID mode.

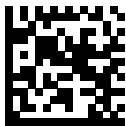

4. On the device, swipe down from the Status bar to open the Quick Access panel and then touch .
5. Touch **Bluetooth**.
6. Touch **Pair new device**. The device begins searching for discoverable Bluetooth devices in the area and displays them under **Available devices**.

7. Scroll through the list and select XXXXX xxxxxx, where XXXXX is the scanner and xxxxxx is the serial number.

The device connects to the scanner, the scanner beeps once and **Connected** appears below the device name. The Bluetooth device is added to the **Paired devices** list and a trusted (“paired”) connection is established.

## Supported Devices

This sections provides the supported decoders for each data capture option.

### LI3678 Supported Decoders

Lists the supported decoders for the LI3678 scanner.

**Table 13** LI3678 Supported Decoders

Decoder	Default State	Decoder	Default State	Decoder	Default State
Australian Postal	—	EAN8	X	MSI	O
Aztec	—	Grid Matrix	O	PDF417	—
Canadian Postal	—	GS1 DataBar	X	QR Code	—
Chinese 2 of 5	O	GS1 DataBar Expanded	X	Decoder Signature	—
Codabar	X	GS1 DataBar Limited	O	TLC 39	O
Code 11	O	GS1 Datamatrix	—	Trioptic 39	O
Code 128	X	GS1 QRCode	—	UK Postal	—
Code 39	X	HAN XIN	O	UPCA	X
Code 93	O	Interleaved 2 of 5	O	UPCE0	X
Composite AB	—	Japanese Postal	—	UPCE1	O
Composite C	—	Korean 3 of 5	O	US4state	—
Discrete 2 of 5	O	MAIL MARK	—	US4state FICS	—
Datamatrix	—	Matrix 2 of 5	O	US Planet	—
Dutch Postal	—	Maxicode	—	US Postnet	—
DotCode	O	MicroPDF	—		
EAN13	X	MicroQR	—		

Key: X = Enabled, O = Disabled, — = Not Supported

### DS3578 Supported Decoders

Lists the supported decoders for the DS3578 Digital Scanner.

**Table 14** DS3578 Digital Scanner Supported Decoders

Decoder	Default State	Decoder	Default State	Decoder	Default State
Australian Postal	O	EAN8	X	MSI	O
Aztec	X	Grid Matrix	O	PDF417	X
Canadian Postal	—	GS1 DataBar	X	QR Code	X
Chinese 2 of 5	O	GS1 DataBar Expanded	X	Decoder Signature	—
Codabar	X	GS1 DataBar Limited	O	TLC 39	O
Code 11	O	GS1 Datamatrix	O	Trioptic 39	O
Code 128	X	GS1 QRCode	O	UK Postal	O
Code 39	X	HAN XIN	—	UPCA	X
Code 93	O	Interleaved 2 of 5	O	UPCE0	X
Composite AB	O	Japanese Postal	O	UPCE1	O
Composite C	O	Korean 3 of 5	O	US4state	O
Discrete 2 of 5	O	MAIL MARK	X	US4state FICS	O
Datamatrix	X	Matrix 2 of 5	O	US Planet	O
Dutch Postal	O	Maxicode	X	US Postnet	O
DotCode	O	MicroPDF	O		
EAN13	X	MicroQR	O		

Key: X = Enabled, O = Disabled, — = Not Supported

## DS3678 Supported Decoders

Lists the supported decoders for the DS3678 scanner.

**Table 15** DS3678 Supported Decoders

Decoder	Default State	Decoder	Default State	Decoder	Default State
Australian Postal	O	EAN8	X	MSI	O
Aztec	X	Grid Matrix	O	PDF417	X
Canadian Postal	—	GS1 DataBar	X	QR Code	X
Chinese 2 of 5	O	GS1 DataBar Expanded	X	Decoder Signature	—
Codabar	X	GS1 DataBar Limited	O	TLC 39	O

**Table 15** DS3678 Supported Decoders (Continued)

Decoder	Default State	Decoder	Default State	Decoder	Default State
Code 11	O	GS1 Datamatrix	O	Trioptic 39	O
Code 128	X	GS1 QRCode	O	UK Postal	O
Code 39	X	HAN XIN	O	UPCA	X
Code 93	O	Interleaved 2 of 5	O	UPCE0	X
Composite AB	O	Japanese Postal	O	UPCE1	O
Composite C	O	Korean 3 of 5	O	US4state	O
Discrete 2 of 5	O	MAIL MARK	X	US4state FICS	O
Datamatrix	X	Matrix 2 of 5	O	US Planet	O
Dutch Postal	O	Maxicode	X	US Postnet	O
DotCode	O	MicroPDF	O		
EAN13	X	MicroQR	O		

Key: X = Enabled, O = Disabled, — = Not Supported

## RS507/RS507x Supported Decoders

Lists the supported decoders for the RS507/RS507x Ring Scanner.

**Table 16** RS507/RS507x Supported Decoders

Decoder	Default State	Decoder	Default State	Decoder	Default State
Australian Postal	O	EAN8	X	MSI	O
Aztec	X	Grid Matrix	O	PDF417	X
Canadian Postal	-	GS1 DataBar	X	QR Code	X
Chinese 2 of 5	O	GS1 DataBar Expanded	X	Decoder Signature	O
Codabar	X	GS1 DataBar Limited	O	TLC 39	O
Code 11	O	GS1 Datamatrix	-	Trioptic 39	O
Code 128	X	GS1 QRCode	-	UK Postal	O
Code 39	O	HAN XIN	-	UPCA	X
Code 93	O	Interleaved 2 of 5	O	UPCE0	X
Composite AB	O	Japanese Postal	O	UPCE1	O
Composite C	O	Korean 3 of 5	O	US4state	O

**Table 16** RS507/RS507x Supported Decoders (Continued)

Decoder	Default State	Decoder	Default State	Decoder	Default State
Discrete 2 of 5	O	MAIL MARK	-	US4state FICS	O
Datamatrix	X	Matrix 2 of 5	O	US Planet	O
Dutch Postal	O	Maxicode	X	US Postnet	O
DotCode	O	MicroPDF	O		
EAN13	X	MicroQR	O		

Key: X = Enabled, O = Disabled, - = Not Supported

## RS5100 Supported Decoders

Lists the supported decoders for the RS5100 Ring Scanner.

**Table 17** RS5100 Supported Decoders

Decoder	Default State	Decoder	Default State	Decoder	Default State
Australian Postal	O	EAN8	X	MSI	O
Aztec	X	Grid Matrix	O	PDF417	X
Canadian Postal	O	GS1 DataBar	X	QR Code	X
Chinese 2 of 5	O	GS1 DataBar Expanded	X	Decoder Signature	O
Codabar	X	GS1 DataBar Limited	O	TLC 39	O
Code 11	O	GS1 Datamatrix	O	Trioptic 39	O
Code 128	X	GS1 QRCode	O	UK Postal	O
Code 39	X	HAN XIN	O	UPCA	X
Code 93	O	Interleaved 2 of 5	O	UPCE0	X
Composite AB	O	Japanese Postal	O	UPCE1	O
Composite C	O	Korean 3 of 5	O	US4state	O
Discrete 2 of 5	O	MAIL MARK	X	US4state FICS	O
Datamatrix	X	Matrix 2 of 5	O	US Planet	O
Dutch Postal	O	Maxicode	X	US Postnet	O
DotCode	O	MicroPDF	O		
EAN13	X	MicroQR	O		

Key: X = Enabled, O = Disabled, - = Not Supported

## RS6000 Supported Decoders

Lists the supported decoders for the RS6000 Ring Scanner.

**Table 18** RS6000 Supported Decoders

Decoder	Default State	Decoder	Default State	Decoder	Default State
Australian Postal	O	EAN8	X	MSI	O
Aztec	X	Grid Matrix	O	PDF417	X
Canadian Postal	O	GS1 DataBar	X	QR Code	X
Chinese 2 of 5	O	GS1 DataBar Expanded	X	Decoder Signature	O
Codabar	X	GS1 DataBar Limited	O	TLC 39	O
Code 11	O	GS1 Datamatrix	O	Trioptic 39	O
Code 128	X	GS1 QRCode	O	UK Postal	O
Code 39	X	HAN XIN	O	UPCA	X
Code 93	O	Interleaved 2 of 5	O	UPCE0	X
Composite AB	O	Japanese Postal	O	UPCE1	O
Composite C	O	Korean 3 of 5	O	US4state	O
Discrete 2 of 5	O	MAIL MARK	X	US4state FICS	O
Datamatrix	X	Matrix 2 of 5	O	US Planet	O
Dutch Postal	O	Maxicode	X	US Postnet	O
DotCode	O	MicroPDF	O		
EAN13	X	MicroQR	O		

Key: X = Enabled, O = Disabled, - = Not Supported

# Wireless

This section provides information on the wireless features of the device.

- Wireless Local Area Network (WLAN)
- Bluetooth
- Cast

## Wireless Local Area Networks

Wireless local area networks (WLANs) allow the device to communicate wirelessly inside a building. Before using the device on a WLAN, the facility must be set up with the required hardware to run the WLAN (sometimes known as infrastructure). The infrastructure and the device must both be properly configured to enable this communication.

Refer to the documentation provided with the infrastructure (access points (APs), access ports, switches, Radius servers, etc.) for instructions on how to set up the infrastructure.

Once the infrastructure is set up to enforce the chosen WLAN security scheme, use the **Wireless & networks** settings to configure the device to match the security scheme.

The device supports the following WLAN security options:

- None
- Enhanced Open
- Wireless Equivalent Privacy (WEP)
- Wi-Fi Protected Access (WPA)/WPA2 Personal (PSK)
- WPA3-Personal
- WPA/WPA2/WPA3 Enterprise (EAP)
  - Protected Extensible Authentication Protocol (PEAP) - with MSCHAPV2 and GTC authentication.
  - Transport Layer Security (TLS)
  - Tunnelled Transport Layer Security (TTLS) - with Password Authentication Protocol (PAP), MSCHAP and MSCHAPv2 authentication.
  - Password (PWD).
  - Lightweight Extensible Authentication Protocol (LEAP).
- WPA3-Enterprise 192-bit

The **Status** bar displays icons that indicate Wi-Fi network availability and Wi-Fi status.





**NOTE:** To extend the life of the battery, turn off Wi-Fi when not in use.

## Connecting to a Wi-Fi Network

1. Go to **Settings**.
2. Touch **Network & internet**.
3. Touch **Wi-Fi** to open the **Wi-Fi** screen. The device searches for WLANs in the area and lists them.
4. Scroll through the list and select the desired WLAN network.
5. For open networks, touch profile once or press and hold and then select **Connect** or for secure networks enter the required password or other credentials then touch **Connect**. See the system administrator for more information.

The device obtains a network address and other required information from the network using the dynamic host configuration protocol (DHCP) protocol. To configure the device with a fixed internet protocol (IP) address, see [Configuring the Device to Use a Static IP Address](#) on page 92.

6. In the Wi-Fi setting field, **Connected** appears indicating that the device is connected to the WLAN.

## Removing a Wi-Fi Network

Remove a remembered or connected Wi-Fi network.

1. Go to **Settings**.
2. Touch **Network & Internet > Wi-Fi**.
3. Scroll down to the bottom of the list and touch **Saved networks**.
4. Touch the name of the network.
5. Touch **FORGET**.

## WLAN Configuration

This section provides information on configuring Wi-Fi settings.

### Configuring a Secure Wi-Fi Network

1. Go to **Settings**.
2. Touch **Network & Internet > Wi-Fi**.
3. Slide the switch to the **ON** position.
4. The device searches for WLANs in the area and lists them on the screen.
5. Scroll through the list and select the desired WLAN network.
6. Touch the desired network. If network security is **Open**, the device automatically connects to the network. For all other network security, a dialog box appears.
7. If network security is **WPA/WPA2-Personal**, **WPA3-Personal**, or **WEP**, enter the required password and then touch **Connect**.

8. If network security is **WPA/WPA2/WPA3 Enterprise**:
    - a) Touch the **EAP method** drop-down list and select one of the following:
      - **PEAP**
      - **TLS**
      - **TTLS**
      - **PWD**
      - **LEAP**
    - b) Fill in the appropriate information. Options vary depending on the **EAP method** chosen.
      - When selecting **CA certificate**, Certification Authority (CA) certificates are installed using the **Security** settings.
      - When using the EAP methods PEAP, TLS, or TTLS, specify a domain.
      - Touch **Advanced options** to display additional network options.
  9. If the network security is **WPA3-Enterprise 192-bit**:
    - Touch **CA certificate** and select a Certification Authority (CA) certificate. Note: Certificates are installed using the Security settings.
    - Touch **User certificate** and select a user certificate. Note: User certificates are installed using the Security settings.
    - In the **Identity** text box, enter the username credentials.
-  **NOTE:** By default, the network Proxy is set to None and the IP settings is set to DHCP. See [Configuring for a Proxy Server](#) on page 92 for setting the connection to a proxy server and see [Configuring the Device to Use a Static IP Address](#) on page 92 for setting the device to use a static IP address.
10. Touch **Connect**.

## Manually Adding a Wi-Fi Network

Manually add a Wi-Fi network if the network does not broadcast its name (SSID) or to add a Wi-Fi network when out of range.

1. Go to **Settings**.
2. Touch **Network & Internet > Wi-Fi**.
3. Slide the Wi-Fi switch to the **On** position.
4. Scroll to the bottom of the list and select **Add network**.
5. In the **Network name** text box, enter the name of the Wi-Fi network.

6. In the **Security** drop-down list, set the type of security to:
  - **None**
  - **Enhanced Open**
  - **WEP**
  - **WPA/WPA2-Personal**
  - **WPA3-Personal**
  - **WPA/WPA2/WPA3-Enterprise**
  - **WPA3-Enterprise 192-bit**
7. If the network security is **None** or **Enhanced Open**, touch **Save**.
8. If the network security is **None**, touch **Save**.
9. If the network security is **WEP**, **WPA3-Personal**, or **WPA/WPA2-Personal**, enter the required password and then touch **Save**.
10. If network security is **WPA/WPA2/WPA3 Enterprise**:
  - a) Touch the **EAP method** drop-down list and select one of the following:
    - **PEAP**
    - **TLS**
    - **TTLS**
    - **PWD**
    - **LEAP**
  - b) Fill in the appropriate information. Options vary depending on the **EAP method** chosen.
    - When selecting **CA certificate**, Certification Authority (CA) certificates are installed using the **Security** settings.
    - When using the EAP methods PEAP, TLS, or TTLS, specify a domain.
    - Touch **Advanced options** to display additional network options.
11. If the network security is **WPA3-Enterprise 192-bit**:
  - Touch **CA certificate** and select a Certification Authority (CA) certificate. Note: Certificates are installed using the Security settings.
  - Touch **User certificate** and select a user certificate. Note: User certificates are installed using the Security settings.
  - In the **Identity** text box, enter the username credentials.



**NOTE:** By default, the network Proxy is set to None and the IP settings is set to DHCP. See [Configuring for a Proxy Server](#) on page 92 for setting the connection to a proxy server and see [Configuring the Device to Use a Static IP Address](#) on page 92 for setting the device to use a static IP address.

12. Touch **Save**. To connect to the saved network, touch and hold on the saved network and select **Connect to network**.

## Configuring for a Proxy Server

A proxy server is a server that acts as an intermediary for requests from clients seeking resources from other servers. A client connects to the proxy server and requests some service, such as a file, connection, web page, or other resource, available from a different server. The proxy server evaluates the request according to its filtering rules. For example, it may filter traffic by IP address or protocol. If the request is validated by the filter, the proxy provides the resource by connecting to the relevant server and requesting the service on behalf of the client.

It is important for enterprise customers to be able to set up secure computing environments within their companies, making proxy configuration essential. Proxy configuration acts as a security barrier ensuring that the proxy server monitors all traffic between the Internet and the intranet. This is normally an integral part of security enforcement in corporate firewalls within intranets.

1. Go to **Settings**.
2. Touch **Network & Internet > Wi-Fi**.
3. Slide the Wi-Fi switch to the **On** position.
4. In the network dialog box, select and touch a network.
5. If configuring the connected network, touch  to edit the network details and then touch the down arrow to hide the keyboard.
6. Touch **Advanced options**.
7. Touch **Proxy** and select **Manual**.
8. In the **Proxy hostname** text box, enter the address of the proxy server.
9. In the **Proxy port** text box, enter the port number for the proxy server.
10. In the **Bypass proxy for** text box, enter addresses for web sites that are not required to go through the proxy server. Use a comma “,” between addresses. Do not use spaces or carriage returns between addresses.
11. If configuring the connected network, touch **Save** otherwise, touch **Connect**.
12. Touch **Connect**.

## Configuring the Device to Use a Static IP Address

By default, the device is configured to use Dynamic Host Configuration Protocol (DHCP) to assign an Internet protocol (IP) address when connecting to a wireless network.

1. Go to **Settings**.
2. Touch **Network & Internet > Wi-Fi**.
3. Slide the Wi-Fi switch to the **On** position.
4. In the network dialog box, select and touch a network.
5. If configuring the connected network, touch  to edit the network details and then touch the down arrow to hide the keyboard.
6. Touch **Advanced options**.
7. Touch **IP settings** and select **Static**.
8. In the **IP address** text box, enter an IP address for the device.
9. If required, in the **Gateway** text box, enter a gateway address for the device.

10. If required, in the **Network prefix length** text box, enter the prefix length.
11. If required, in the **DNS 1** text box, enter a Domain Name System (DNS) address.
12. If required, in the **DNS 2** text box, enter a DNS address.
13. If configuring the connected network, touch **Save** otherwise, touch **Connect**.

## Wi-Fi Preferences

Use the Wi-Fi preferences to configure advanced Wi-Fi settings. From the Wi-Fi screen scroll down to the bottom of the screen and touch Wi-Fi preferences.

- **Turn on Wi-Fi automatically** - When enabled, Wi-Fi automatically turns back on when near high-quality saved networks.
- **Open network notification** - When enabled, notifies the user when an open network is available.
- **Advanced** - Touch to expand options.
  - **Additional settings** - Touch to view additional Wi-Fi settings.
  - **Install Certificates** – Touch to install certificates.
  - **Network rating provider** - Disabled (AOSP devices). To help determine what constitutes a good Wi-Fi network, Android supports external Network rating providers that provide information about the quality of open Wi-Fi networks. Select one of the providers listed or **None**. If none are available or selected, the Connect to open networks feature is disabled.
  - **Wi-Fi Direct** - Displays a list of devices available for a direct Wi-Fi connection.

## Additional Wi-Fi Settings

Use the Additional Settings to configure additional Wi-Fi settings. To view the additional Wi-Fi settings, scroll to the bottom of the Wi-Fi screen and touch **Wi-Fi Preferences > Advanced > Additional settings**.



**NOTE:** Additional Wi-Fi settings are for the device, not for a specific wireless network.

- **Regulatory**
  - **Country Selection** - Displays the acquired country code if 802.11d is enabled, else it displays the currently selected country code.
  - **Region code** - Displays the current region code.
- **Band and Channel Selection**
  - **Wi-Fi frequency band** - Set the frequency band to: **Auto** (default), **5 GHz only** or **2.4 GHz only**.
  - **Available channels (2.4 GHz)** - Touch to display the **Available channels** menu. Select specific channels and touch **OK**.
  - **Available channels (5 GHz)** - Touch to display the **Available channels** menu. Select specific channels and touch **OK**.

- **Logging**
  - **Advanced Logging** – Touch to enable advanced logging or change the log directory.
  - **Wireless logs** - Use to capture Wi-Fi log files.
    - **Fusion Logger** - Touch to open the **Fusion Logger** application. This application maintains a history of high level WLAN events which helps to understand the status of connectivity.
    - **Fusion Status** - Touch to display live status of WLAN state. Also provides information about the device and connected profile.
- **About**
  - **Version** - Displays the current Fusion information.

## Wi-Fi Direct

Wi-Fi Direct devices can connect to each other without having to go through an access point. Wi-Fi Direct devices establish their own ad-hoc network when required, letting you see which devices are available and choose which one you want to connect to.

1. Go to **Settings**.
2. Touch **Wi-Fi > Wi-Fi preferences > Advanced > Wi-Fi Direct**. The device begins searching for another Wi-Fi Direct device.
3. Under **Peer devices**, touch the other device name.
4. On the other device, select **Accept**.

**Connected** appears on the device. On both devices, in their respective Wi-Fi Direct screens, the other device name appears in the list.

## Bluetooth

Bluetooth devices can communicate without wires, using frequency-hopping spread spectrum (FHSS) radio frequency (RF) to transmit and receive data in the 2.4 GHz Industry Scientific and Medical (ISM) band (802.15.1). Bluetooth wireless technology is specifically designed for short-range (10 m (32.8 ft)) communication and low power consumption.

Devices with Bluetooth capabilities can exchange information (for example, files, appointments, and tasks) with other Bluetooth enabled devices such as printers, access points, and other mobile devices.

The device supports Bluetooth Low Energy. Bluetooth Low Energy is targeted at applications in the healthcare, fitness, security, and home entertainment industries. It provides reduced power consumption and cost while maintaining standard Bluetooth range.

## Adaptive Frequency Hopping

Adaptive Frequency Hopping (AFH) is a method of avoiding fixed frequency interferers, and can be used with Bluetooth voice. All devices in the piconet (Bluetooth network) must be AFH-capable in order for AFH to work. There is no AFH when connecting and discovering devices. Avoid making Bluetooth connections and discoveries during critical 802.11b communications.

AFH for Bluetooth consists of four main sections:

- **Channel Classification** - A method of detecting an interference on a channel-by-channel basis, or pre-defined channel mask.

- Link Management - Coordinates and distributes the AFH information to the rest of the Bluetooth network.
- Hop Sequence Modification - Avoids interference by selectively reducing the number of hopping channels.
- Channel Maintenance - A method for periodically re-evaluating the channels.

The Bluetooth radio in this device operates as a Class 1 device power class. The maximum output power is 7.5 mW and the expected range is 30 m (98.4 ft). A definition of ranges based on power class is difficult to obtain due to power and device differences, and whether in open space or closed office space.



**NOTE:** It is not recommended to perform Bluetooth wireless technology inquiry when high rate 802.11b operation is required.

## Security

The current Bluetooth specification defines security at the link level. Application-level security is not specified. This allows application developers to define security mechanisms tailored to their specific need. Link-level security occurs between devices, not users, while application-level security can be implemented on a per-user basis. The Bluetooth specification defines security algorithms and procedures required to authenticate devices, and if needed, encrypt the data flowing on the link between the devices. Device authentication is a mandatory feature of Bluetooth while link encryption is optional.

Pairing of Bluetooth devices is accomplished by creating an initialization key used to authenticate the devices and create a link key for them. Entering a common personal identification number (PIN) in the devices being paired generates the initialization key. The PIN is never sent over the air. By default, the Bluetooth stack responds with no key when a key is requested (it is up to user to respond to the key request event). Authentication of Bluetooth devices is based-upon a challenge-response transaction. Bluetooth allows for a PIN or passkey used to create other 128-bit keys used for security and encryption. The encryption key is derived from the link key used to authenticate the pairing devices. Also worthy of note is the limited range and fast frequency hopping of the Bluetooth radios that makes long-distance eavesdropping difficult.

Recommendations are:

- Perform pairing in a secure environment
- Keep PIN codes private and do not store the PIN codes in the device
- Implement application-level security.

## Bluetooth Profiles

The device supports the Bluetooth services listed.

**Table 19** Bluetooth Profiles

Profile	Description
Service Discovery Protocol (SDP)	Handles the search for known and specific services as well as general services.
Serial Port Profile (SPP)	Allows use of RFCOMM protocol to emulate serial cable connection between two Bluetooth peer devices. For example, connecting the device to a printer.
Object Push Profile (OPP)	Allows the device to push and pull objects to and from a push server.

**Table 19** Bluetooth Profiles (Continued)

Profile	Description
Advanced Audio Distribution Profile (A2DP)	Allows the device to stream stereo-quality audio to a wireless headset or wireless stereo speakers.
Audio/Video Remote Control Profile (AVRCP)	Allows the device to control A/V equipment to which a user has access. It may be used in concert with A2DP.
Personal Area Network (PAN)	Allows the use of Bluetooth Network Encapsulation Protocol to provide L3 networking capabilities over a Bluetooth link. Only PANU role is supported.
Human Interface Device Profile (HID)	Allows Bluetooth keyboards, pointing devices, gaming devices and remote monitoring devices to connect to the device.
Headset Profile (HSP)	Allows a hands-free device, such as a Bluetooth headset, to place and receive calls on the device.
Hands-Free Profile (HFP)	Allows car hands-free kits to communicate with the device in the car.
Phone Book Access Profile (PBAP)	Allows exchange of Phone Book Objects between a car kit and a mobile device to allow the car kit to display the name of the incoming caller; allow the car kit to download the phone book so you can initiate a call from the car display.
Out of Band (OOB)	Allows exchange of information used in the pairing process. Pairing is completed using the Bluetooth radio, but requires information from the OOB mechanism. Using OOB with NFC enables pairing when devices simply get close, rather than requiring a lengthy discovery process.
Symbol Serial Interface (SSI)	Allows for communication with Bluetooth Imager.
Generic Attribute Profile (GATT)	Provides profile discovery and description services for Bluetooth Low Energy protocol. It defines how attributes are grouped together into sets to form services.
Dial Up Networking (DUN)	Provides a standard to access the Internet and other dial-up services over Bluetooth.
Generic Access Profile (GAP)	Use for device discovery and authentication.
OBject EXchange (OBEX)	Facilitates the exchange of binary objects between devices.

## Bluetooth Power States

The Bluetooth radio is off by default.

- **Suspend** - When the device goes into suspend mode, the Bluetooth radio stays on.
- **Airplane Mode** - When the device is placed in Airplane Mode, the Bluetooth radio turns off. When Airplane mode is disabled, the Bluetooth radio returns to the prior state. When in Airplane Mode, the Bluetooth radio can be turned back on if desired.

## Bluetooth Radio Power

Turn off the Bluetooth radio to save power or if entering an area with radio restrictions (for example, an airplane). When the radio is off, other Bluetooth devices cannot see or connect to the device. Turn on the Bluetooth radio to exchange information with other Bluetooth devices (within range). Communicate only with Bluetooth radios in close proximity.





**NOTE:** To achieve the best battery life, turn off radios when not in use.

### Enabling Bluetooth

1. Swipe down from the Status bar to open the Notification panel.
2. Touch  to turn Bluetooth on.

### Disabling Bluetooth

1. Swipe down from the Status bar to open the Notification panel.
2. Touch  to turn Bluetooth off.

## Discovering Bluetooth Device(s)

The device can receive information from discovered devices without pairing. However, once paired, the device and a paired device exchange information automatically when the Bluetooth radio is on.

1. Ensure that Bluetooth is enabled on both devices.
2. Ensure that the Bluetooth device to discover is in discoverable mode.
3. Ensure that the two devices are within 10 meters (32.8 feet) of one another.
4. Swipe down from the Status bar to open the Quick Access panel.
5. Touch and hold **Bluetooth**.
6. Touch **Pair new device**. The device begins searching for discoverable Bluetooth devices in the area and displays them under **Available devices**.
7. Scroll through the list and select a device. The Bluetooth pairing request dialog box appears.
8. Touch **Pair** on both devices.
9. The Bluetooth device is added to the **Paired devices** list and a trusted (“paired”) connection is established.

## Changing the Bluetooth Name

By default, the device has a generic Bluetooth name that is visible to other devices when connected.

1. Go to **Settings**.
2. Touch **Connected devices** > **Connection preferences** > **Bluetooth**.
3. If Bluetooth is not on, move the switch to turn Bluetooth on.
4. Touch **Device name**.
5. Enter a name and touch **RENAME**.

## Connecting to a Bluetooth Device

Once paired, connect to a Bluetooth device.

1. Go to **Settings**.

2. Touch **Connected devices**.
3. In the list, touch the unconnected Bluetooth device.  
When connected, **Connected** appears below the device name.

## Selecting Profiles on the Bluetooth Device

Some Bluetooth devices have multiple profiles.

1. Go to **Settings**.
2. Touch **Connected devices**.
3. In the **Paired Devices** list, touch  next to the device name.
4. Turn on or off a profile to allow the device to use that profile.

## Unpairing a Bluetooth Device

Unpairing a Bluetooth device erases all pairing information.

1. Go to **Settings**.
2. Touch **Connected devices**.
3. In the **Paired Devices** list, touch  next to the device name.
4. Touch **FORGET**.

## Cast

Use **Cast** to mirror the device screen on a Miracast enabled wireless display.

1. Go to **Settings**.
2. Touch **Connected devices** > **Connection preferences** > **Cast**.
3. Touch  > **Enable wireless display**.  
The device searches for nearby Miracast devices and lists them.
4. Touch a device to begin casting.

# Accessories and Mounting

This section provides accessory information, mounting options and instructions.

## Device Accessories

This table lists the accessories available for the device.

**Table 20** VC8300 Accessories

Model Number	Description
<b>Antennas</b>	
AN2010	Antenna, dual band, 802.11 a/b/g/n/ac, 2 dBi, reverse polarity SMA connector, magnetic mount, 2.9 m (9.5 ft) cable.
AN2020	Antenna, 2.4 GHz, 802.11 b/g, 5 dBi, reverse polarity SMA connector, magnetic mount, 2.9 m (9.5 ft) cable.
AN2030	Whip antenna (stubby), dual band, 802.11 a/b/g/n/ac, 2.4 GHz 2 dBi, 5 GHz 3.7 dBi, reverse polarity SMA connector.
AR1000	Right Angle SMA reverse polarity plug-jack adapter.
<b>Mounts</b>	
MT4200	Quick release mount.
MT4205	Mounting plate for the MT4200 quick release mount.
MT4210	Adapter bracket kit for 82XX quick release mount.
MT4510	RAM rectangular base with 2.25" rubber ball.
MT4301	RAM mount, 4" arm.
MT4302	RAM mount, 12" arm.
MT3501	VESA base (for 4" or 12" RAM arm).
MT3502	Circular base (for 4" or 12" RAM arm).
MT3505	Clamp base (for 4" or 12" RAM arm), 2" max. width.
MT3507	Clamp base (for 4" or 12" RAM arm), 3" max. width.
MT3509	Rail base (for 4" or 12" RAM arm), 1-1/4" to 1-7/8".
MT3510	Rail base (for 4" or 12" RAM arm), 2" to 2-1/2"

**Table 20** VC8300 Accessories (Continued)

Model Number	Description
MNT-VC80-ADPA1-1	Adapter for VC50 U-Mount.
MNT-VC80-ADPB1-1	Adapter for Honeywell U-Mount.
KT-U-MOUNT-VC80-R	U-Mount, with VC70 and 8585 / 8595 U-Mount hole pattern. Includes MNT-VC80-ADPA1-1 adapter.
<b>Speaker/Mic</b>	
M1000	Speaker/Mic with push-to-talk function.
<b>Keyboard</b>	
KYBD-QW-VC80-S-1	USB QWERTY keyboard with 22 cm (8.66 in.) cable for VC80.
KYBD-QW-VC80-L-1	USB QWERTY keyboard with 300 cm (9.8 ft) cable for VC80.
KYBD-AZ-VC-01	AZERTY Keyboard.
CBL-VC80-KBUS1-01	Keyboard cable.
CBL-VC80-KBUS2-01	Keyboard cable.
KT-KYBDTRAY-VC80-R	Keyboard tray.
<b>Miscellaneous</b>	
KT-VC80-BTRY1-01	Spare battery
KT-AREFL-VC83-8-1	Anti Reflection Foil, pack of 3. (VC8300-8 only)
KT-SPRTCT-VC70-05R	Screen Protector 10.4" Pack of 5
<b>Power Supplies and Cables</b>	
PS1370	Pre-Regulator, 24 - 90 VDC in, 15 VDC out, 90 W
PS1450	100/240 VAC power supply, 12 VDC, 6 A. (AC power cord sold separately)
CB000417A01	DC power adapter to VC50 extension cable
CB000416A01	DC Power adapter to VC70 extension cable
CA1210	Power extension cable, DC, 6', waterproof
CA1230	Power extension cable for pre-regulator
CA1220	Power extension cable, DC, 180 cm, with ignition sense
CA1300	Screen blanking cable (DB9 to open wires)
A9169798	Adapter CPC to LXE/Honeywell VCX8, VX9, VM1, VM2 and VM3 DC Power Extension Cable.
A9169801	Adapter CPC and Serial to LXE VCX8 and VX9 DC Power Extension and Screen Blanking Cable.

## Related Accessory Documents

The following documents provide information about the VC8300 vehicle-mount computer accessories.

- VC Remote Keyboard Quick Reference Guide p/n MN-002967-xx - provides instructions on installing the VC remote keyboard to the VC8300.

- U-Mount Bracket Installation Guide, p/n MN-002931-xx - provides instructions to install the U-Mount Bracket Kit (KT-U-MOUNT-VC80-R) and dimensions.
- Adapter Bracket Kit for VC50 U-Mount Installation Guide, p/n MN-002932-xx - provides instruction on installing the Adapter Bracket Kit (MNT-VC80-ADPA1-1) to attach the VC8300 to the VC5090 U-Mount.
- Adapter Bracket Kit for Honeywell U-Mount Installation Guide, p/n MN-002934-xx - provides instruction on installing the Adapter Bracket Kit (MNT-VC80-ADPB1-1) to attach the VC8300 to the Honeywell U-Mount Bracket.

For the latest version of all guides, go to: [zebra.com/support](https://zebra.com/support).

### VC8300 Antenna Options

Antenna hardware configurations are located in the [Device Accessories](#) on page 99 table. To determine the best antenna option for your location, contact your Zebra representative.



**CAUTION:** If using a magnetic mount antenna, place it in a location that balances the need for the device to communicate with the access points and local Bluetooth peripherals.

**Figure 31** VC8300 Antenna Options

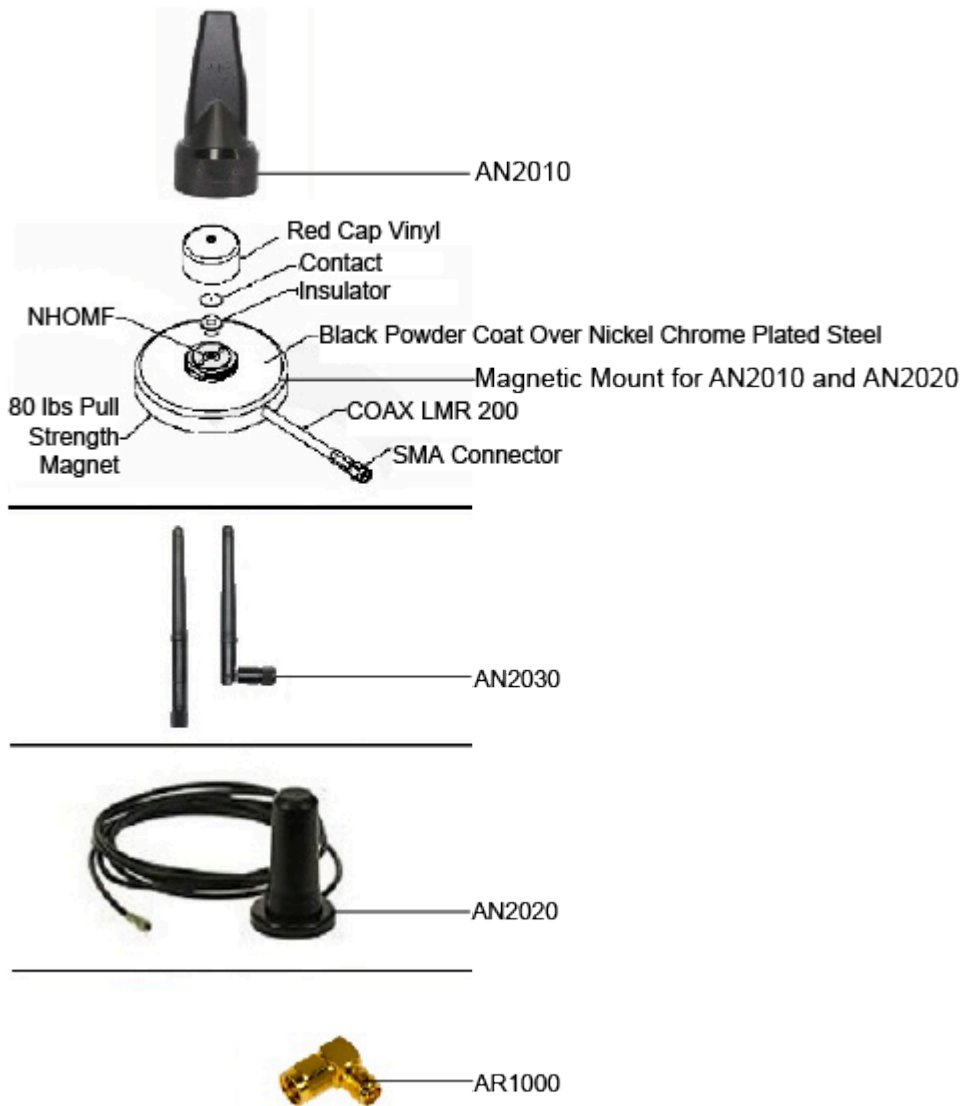

## VC8300 Mounting Accessories

Before mounting a device in a vehicle, there are a number of operator safety issues that require careful attention. When mounting a device, use only approved Zebra mounting hardware and mounting parts that are specific to the device model purchased. An improperly mounted device or use of non-approved parts may result in one or more of the following: operator injury, property damage, operator visibility obstruction, operator distraction, and/or poor ease of egress for the operator. Zebra strongly recommends that you seek professional mounting advice from the vehicle manufacturer.



**WARNING:** Failure to install the mount correctly, or modifications to the mount, may result in serious injury or damage to property. Contact Zebra Technical Support or your Zebra representative if you have problems installing this mount. To ensure operator safety, you must use a calibrated torque wrench and the supplied mounting hardware when fastening

the computer and mount. Use of this mount in vehicles driven on public roads or highways is prohibited. Contact Zebra for further details.

If it is necessary to mount the device overhead, or in any position that could cause injury to the operator should the unit fall, it is critical that a secondary tether or other fail-safe device be installed.

The following restrictions must be strictly enforced:

- Do not use the mount and/or the device as a handheld. Using the mount in this manner may cause the person to fall or dislodge the mounting hardware and/or mounts.
- Do not add weight or attach any other items to the mount or device. Additional elements may fall causing injury, or may increase the chance of failure and/or damage in mounting hardware and/or mounts.
- Mounts used in industrial or vibration generating environments may be subjected to fatigue, stress, and/or part wear. A periodic inspection of the mounting hardware and mounts should be performed to ensure parts are retightened to the correct torque, free of fractures, excessive wear, and/or other environmental damage. Any parts found to be unsafe should be removed and replaced immediately. After inspection or replacement of parts, readjust the mount as outlined in the pertinent sections below.
- Cable routing within a vehicle cab also requires careful consideration, especially for separately connected scanners and other devices with loose cables. If you are unable to obtain suitable advice, contact Zebra for assistance. For better protection, the equipment should be mounted inside the vehicle roll cage.
- When charging the vehicle battery, the device must be either disconnected from the battery or it must be determined that the maximum allowed input voltage of the device is not exceeded.

### MT43XX RAM Mount

Keep this device away from magnetic fields.



**CAUTION:** To avoid injury, this device must be properly secured when in a moving vehicle.

Do not disassemble the vehicle computer as there are no user-serviceable parts inside.



**CAUTION:** The operator can easily adjust the tilt and rotation of the device. Use care to avoid operator injury or equipment damage if the computer slips due to a loosened hand screw.

The device may be installed using an articulating RAM Mount (Model MT43XX – 4 in. or 12 in. arm) secured to either a VESA or circular base.

The RAM articulating mount can be installed in a variety of orientations (see [MT3510 Optional Mount Kit](#)). Select the best orientation for the specific application. Preferred orientations maintain the center of mass of the computer assembly, directly over the center of the base.

For detailed mount installation information, refer to the instructions included with the mount kit.

**Figure 32** Orientation of Vehicle-Mount Assembly

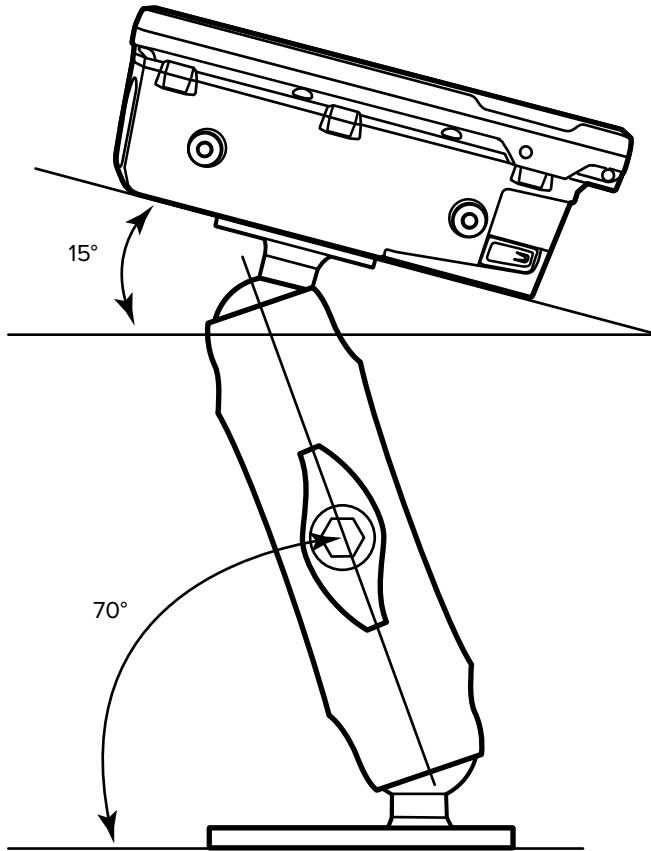

### Assembling the Optional Mounts

One of the following optional mounting kits shown below may be substituted for the Vesa base or the circular base when mounting to a post or forklift roll cage.

1. Mount the clamp base and lower base around the shaft.
2. Place the screws through the clamp and the lower base, and affix with the nuts.
3. Torque to 26 in-lbs.



4. Secure the RAM standard arm by inserting the RAM balls into both ends of the arm sockets.

**Figure 33** MT3505 Optional Mount Kits

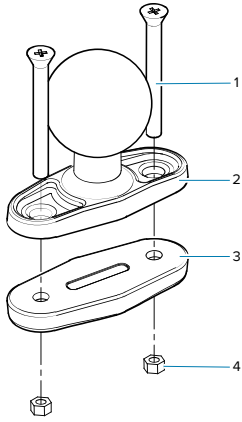

1	Screw
2	Clamp Base
3	Lower Base
4	Nut

**Figure 34** MT3507 Optional Mount Kits

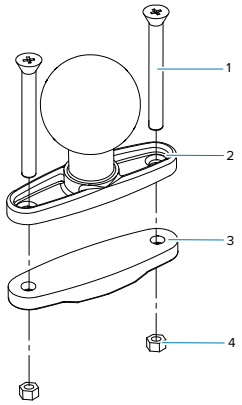

1	Screw
2	Clamp Base
3	Lower Base

4	Nut
---	-----

**Figure 35** MT3509 Optional Mount Kit

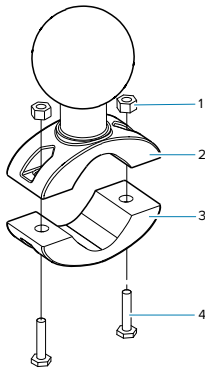

1	Nut
2	Clamp Base
3	Lower Base
4	Screw

**Figure 36** MT3510 Optional Mount Kit

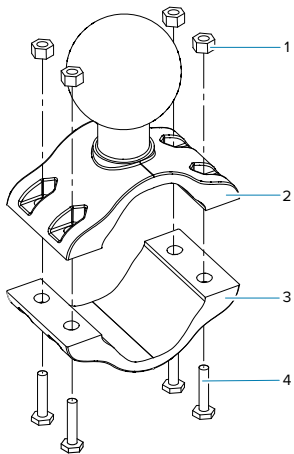

1	Nut
2	Clamp Base
3	Lower Base
4	Screw

**Plate Bases for MT35XX Mounts**

Plate bases are not recommended for forklift mounting solutions. If this requires a plate rather than a clamp base, you must penetrate into the structure of the vehicle. This requires additional hardware.

The following plate bases are available:

- MT3501 - VESA Plate
- MT3502 - Circular Plate

## Assembling the Quick Release MT4200

The MT4200 Quick Release Mount allows for removal without the need for tools.

1. Place the back mounting plate hooks into the base plate slots.
2. Snap spring clips into place.

**Figure 37** MT4200 Quick Release Mount Assembly

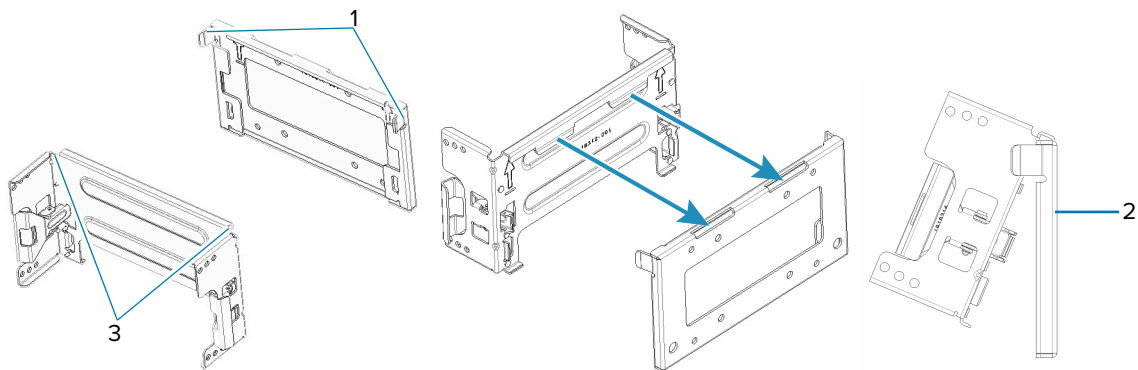

1	MT4200 Back Mounting Plate Hooks
2	Spring Clip
3	MT4205 Base Plate Slots

## Attaching MT4200 to VC8300

1. Line up the MT4200 mounting bracket holes with the holes on the sides of the device (two on each side).
2. Place the spring lock washer onto the hex head screw.
3. Place the flat washer onto the hex head screw (on top of the washer spring lock).

- 4. Screw the bracket onto the device (total of four), and torque to 39.98 kgf-cm or 34.7 lbf-in.

Figure 38 VC8300 and MT4200 Assembly

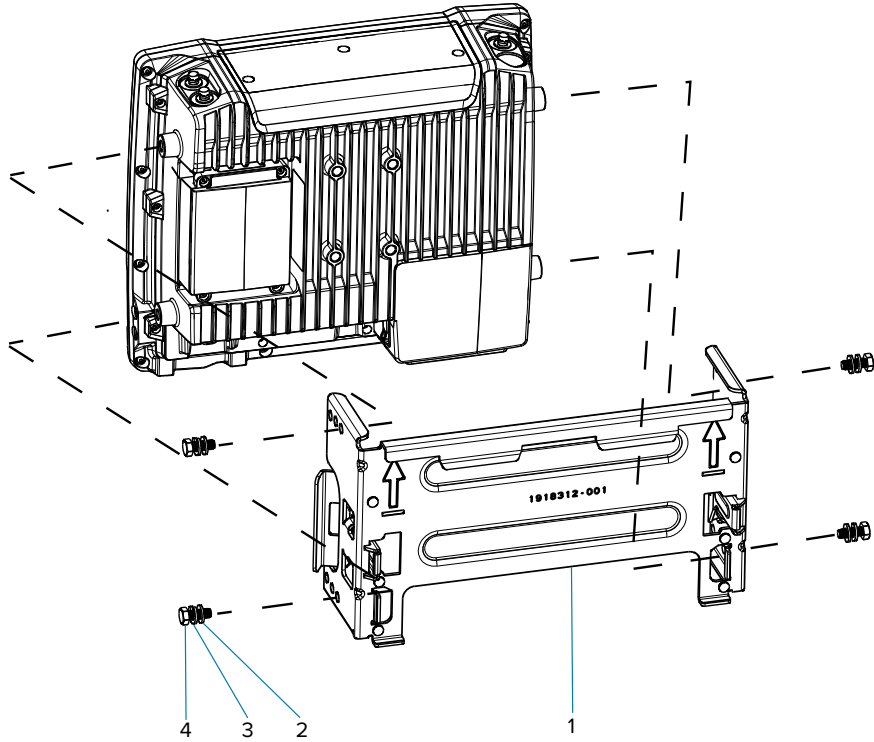

1	MT4200 Mounting Bracket (Back View)
2	Washer Flat
3	Washer Spring Lock
4	Hex Head Screw M6X12

# Application Deployment

This section provides an overview of device security, app development, and app management. It also provides instructions for installing apps and updating the device software.

## Security

The device implements a set of security policies that determine whether an application is allowed to run and, if allowed, with what level of trust. To develop an application, you must know the security configuration of the device, and how to sign an application with the appropriate certificate to allow the application to run (and to run with the needed level of trust).



**NOTE:** Ensure the date is set correctly before installing certificates or when accessing secure web sites.

## Secure Certificates

If the VPN or Wi-Fi networks rely on secure certificates, obtain the certificates and store them in the device's secure credential storage, before configuring access to the VPN or Wi-Fi networks.

If downloading the certificates from a web site, set a password for the credential storage. The device supports X.509 certificates saved in PKCS#12 key store files with a .p12 extension (if key store has a .pfx or other extension, change to .p12).

The device also installs any accompanying private key or certificate authority certificates contained in the key store.

## Installing a Secure Certificate

If required by the VPN or Wi-Fi network, install a secure certificate on the device.

1. Copy the certificate from the host computer to the root of the microSD card or the device's internal memory. See [USB Communication](#) on page 40 for information about connecting the device to a host computer and copying files.
2. Copy the certificate from the host computer to the root of the device's internal memory. See [USB Communication](#) on page 40 for information about connecting the device to a host computer and copying files.
3. Go to **Settings**.
4. Touch **Security > Advanced > Encryption & credentials**.

5. Touch **Security > Encryption & credentials**.
6. Touch **Install a certificate**.
7. Navigate to the location of the certificate file.
8. Touch the filename of the certificate to install.
9. If prompted, enter the password for credential storage. If a password has not been set for the credential storage, enter a password for it twice, and then touch **OK**.
10. If prompted, enter the certificate's password and touch **OK**.
11. Enter a name for the certificate and in the Credential use drop-down, select **VPN and apps** or **Wi-Fi**.
12. Touch **OK**.

The certificate can now be used when connecting to a secure network. For security, the certificate is deleted from the microSD card or internal memory.

The certificate can now be used when connecting to a secure network. For security, the certificate is deleted from the internal memory.

## Configuring Credential Storage Settings

Configure credential storage from the device settings.

1. Go to **Settings**.
2. Touch **Security > Encryption & credentials**.
3. Select an option.
  - Touch **Trusted credentials** to display the trusted system and user credentials.
  - Touch **User credentials** to display user credentials.
  - Touch **Install from storage** to install a secure certificate from the internal storage.
  - Touch **Clear credentials** to delete all secure certificates and related credentials.

## Android Development Tools

Development tools for Android include Android Studio, EMDK for Android, and StageNow.

### Android Development Workstation

Android development tools are available at [developer.android.com](http://developer.android.com).

To start developing applications for the device, download Android Studio. Development can take place on a Microsoft® Windows®, Mac® OS X®, or Linux® operating system.

Applications are written in Java or Kotlin, but compiled and executed in the Dalvik virtual machine. Once the Java code is compiled cleanly, the developer tools make sure the application is packaged properly, including the AndroidManifest.xml file.

Android Studio contains a full featured IDE as well as SDK components required to develop Android applications.

## Enabling Developer Options

The **Developer options** screen sets development-related settings. By default, the Developer Options are hidden.

1. Go to **Settings**.
2. Touch **About phone**.
3. Scroll down to **Build number**.
4. Tap **Build number** seven times.  
The message **You are now a developer!** appears.
5. Touch **Back**.
6. Touch **System > Advanced > Developer options**.
7. Slide the **USB debugging** switch to the **ON** position.

## EMDK for Android

EMDK for Android provides developers with tools to create business applications for enterprise mobile devices. It is designed for use with Google's Android Studio and includes Android class libraries such as Barcode, sample applications with source code, and the associated documentation.

EMDK for Android allows applications to take full advantage of the capabilities that Zebra devices have to offer. It embeds Profile Manager technology within Android Studio IDE, providing a GUI-based development tool designed specifically for Zebra devices. This allows fewer lines of code, resulting in reduced development time, effort, and errors.

### See Also

[For more information go to techdocs.zebra.com.](https://techdocs.zebra.com)

## StageNow for Android

StageNow is Zebra's next-generation Android Staging Solution built on the MX platform. It allows quick and easy creation of device profiles, and can deploy to devices simply by scanning a barcode, reading a tag, or playing an audio file.

The StageNow Staging Solution includes the following components:

- The StageNow Workstation tool installs on the staging workstation (host computer) and lets the administrator easily create staging profiles for configuring device components, and perform other staging actions such as checking the condition of a target device to determine suitability for software upgrades or other activities. The StageNow Workstation stores profiles and other created content for later use.
- The StageNow Client resides on the device and provides a user interface for the staging operator to initiate staging. The operator uses one or more of the desired staging methods (print and scan a barcode, read an NFC tag or play an audio file) to deliver staging material to the device.

### See Also

[For more information go to techdocs.zebra.com.](https://techdocs.zebra.com)

## GMS Restricted

GMS Restricted mode deactivates Google Mobile Services (GMS). All GMS apps are disabled on the device and communication with Google (analytics data collection and location services) is disabled.

Use StageNow to disable or enable GMS Restricted mode. After a device is in GMS Restricted mode, enable and disable individual GMS apps and services using StageNow. To ensure GMS Restricted mode persists after an Enterprise Reset, use the Persist Manager option in StageNow.

### See Also

[For more information on StageNow, refer to techdocs.zebra.com.](https://techdocs.zebra.com)

## ADB USB Setup

To use the ADB, install the development SDK on the host computer then install the ADB and USB drivers.

Before installing the USB driver, make sure that the development SDK is installed on the host computer. Go to [developer.android.com/sdk/index.html](https://developer.android.com/sdk/index.html) for details on setting up the development SDK.

The ADB and USB drivers for Windows and Linux are available on the Zebra Support Central web site at [zebra.com/support](https://zebra.com/support). Download the ADB and USB Driver Setup package. Follow the instructions with the package to install the ADB and USB drivers for Windows and Linux.

## Enabling USB Debugging

By default, USB debugging is disabled.

1. Go to **Settings**.
2. Touch **About phone**.
3. Scroll down to **Build number**.
4. Tap **Build number** seven times.  
The message **You are now a developer!** appears.
5. Touch **Back**.
6. Touch **System > Advanced > Developer options**.
7. Slide the **USB debugging** switch to the **ON** position.
8. Touch **OK**.
9. Connect the device to the host computer using the Rugged Charge/USB Cable.

The **Allow USB debugging?** dialog box appears on the device.

If the device and host computer are connected for the first time, the **Allow USB debugging?** dialog box with the **Always allow from this computer** check box displays. Select the check box, if required.

10. Touch **OK**.
11. Touch **OK** or **Allow**.
12. On the host computer, navigate to the **platform-tools** folder and open a command prompt window.



13. Type `adb devices`.

The following displays:

```
List of devices attached          XXXXXXXXXXXXXXXXXXXX device
```

Where XXXXXXXXXXXXXXXXXXXX is the device number.



**NOTE:** If device number does not appear, ensure that ADB drivers are installed properly.

14. Return to the Home screen.

## Application Installation Methods

After an application is developed, install the application onto the device using one of the supported methods.

- USB drive
- USB connection
- Android Debug Bridge
- Mobile device management (MDM) platforms that have application provisioning. Refer to the MDM software documentation for details.

### Installing Applications Using a USB Drive

Use a USB drive to install applications on the device.



**IMPORTANT:** USB Drive must have FAT32 format.

1. Plug the USB drive into the USB port on the host computer.
2. On the host computer, open a file explorer application.
3. Copy the application APK file from the host computer to the USB drive.



**CAUTION:** Follow the host computer's instructions to eject the USB drive correctly to avoid losing information.

4. Eject the USB drive from the host computer.
5. Remove the dust cover on the back of the device. See [VC8300 Rear View with Dust Cover](#).
6. Plug the USB drive into the USB port on the device. See [VC8300 Rear View without Dust Cover](#).  
A notification appears indicating that the device detected the USB drive.
7. Swipe the screen up and select  to view files on the USB drive.
8. Touch **General USB drive**.
9. Locate the application APK file.
10. Touch the application file.
11. Touch **Continue** to install the app or **Cancel** to stop the installation.
12. To confirm installation and accept what the application affects, touch **Install** otherwise touch **Cancel**.

13. Touch **Open** to open the application or **Done** to exit the installation process.  
The application appears in the App list.
14. Disconnect the USB drive from the host computer.

### Installing Applications Using the USB Connection

Use the USB connection to install applications onto the device.

1. Connect the device to a host computer using the Rugged Charge/USB cable.
2. On the device, pull down the Notification panel and touch **Charging this device via USB**.  
By default, **No data transfer** is selected.
3. On the host computer, open a file explorer application.
4. Disconnect the device from the host computer.
5. Swipe the screen up and select  to view files on the Internal Storage.
6. Locate the application APK file.
7. Touch the application file.
8. Touch **Continue** to install the app or **Cancel** to stop the installation.
9. To confirm installation and accept what the application affects, touch **Install** otherwise touch **Cancel**.
10. Touch **Open** to open the application or **Done** to exit the installation process.  
The application appears in the App list.

### Installing Applications Using the Android Debug Bridge

Use ADB commands to install applications onto the device.



**CAUTION:** When connecting the device to a host computer, follow the host computer's instructions for connecting and disconnecting USB devices, to avoid damaging or corrupting files.

1. Ensure that the ADB drivers are installed on the host computer.
2. Using a T10 Torx screwdriver, remove four screws securing the top cover to the device.

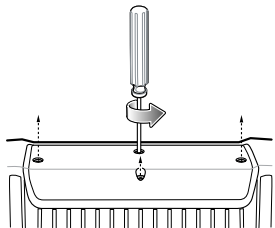

**CAUTION:** When the user connects a USB cable to the USB-C port on top of the device, the USB and RS-232 ports on the bottom are disabled.

3. Connect the device to a host computer using a USB-C cable.
4. Go to **Settings**.
5. Touch **System > Advanced > Developer options** .

- Slide the **USB debugging** switch to the **ON** position.
- Touch **OK**.
- If the device and host computer are connected for the first time, the **Allow USB debugging?** dialog box with the **Always allow from this computer** check box displays. Select the check box, if required.
- Touch **OK** or **Allow**.
- On the host computer, navigate to the **platform-tools** folder and open a command prompt window.
- Type `adb install <application>`.  
where: <application> = the path and filename of the apk file.
- Disconnect the device from the host computer.
- Disconnect the USB-C cable from the device.
- Replace the top cover.
- Secure the top cover to the device using the four screws.

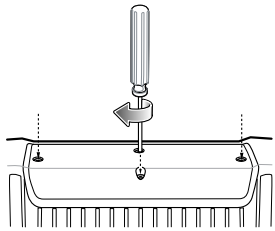

- Torque the screws to 6kg-cm (5.2lbs-in).

## Installing Applications Using the Wireless Android Debug Bridge

Use ADB commands to install an application onto the device.



**IMPORTANT:** Ensure the latest adb files are installed on the host computer.



**IMPORTANT:** The device and host computer must be on the same wireless network.

- Go to **Settings**.
- Touch **System > Advanced > Developer options**.
- Slide the **USB debugging** switch to the **ON** position.
- Slide the **Wireless debugging** switch to the **ON** position.
- If the device and host computer are connected for the first time, the **Allow wireless debugging on this network?** dialog box with the **Always allow from this network** check box displays. Select the check box, if required.
- Touch **ALLOW**.
- Touch **Wireless debugging**.

8. Touch **Pair with pairing code**.

The **Pair with device** dialog box displays.

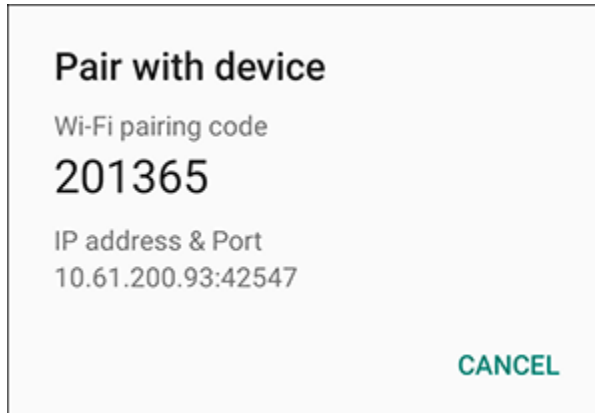

9. On the host computer, navigate to the **platform-tools** folder and open a command prompt window.
10. Type `adb pair XX.XX.XX.XX.XXXXXX`.  
where `XX.XX.XX.XX.XXXXXX` is the IP address and port number from the **Pair with device** dialog box.
11. Type: `adb connect XX.XX.XX.XX.XXXXXX`
12. Press **Enter**.
13. Type the pairing code from the **Pair with device** dialog box.
14. Press **Enter**.
15. Type `adb connect`.  
The device is now connected to the host computer.
16. Type `adb devices`.  
The following displays:

```
List of devices attached      XXXXXXXXXXXXXXXXXXXX device
```

Where XXXXXXXXXXXXXXXXXXXX is the device number.



**NOTE:** If device number does not appear, ensure that ADB drivers are installed properly.

17. On the host computer command prompt window type:

```
adb install <application>
```

where: `<file>` = the path and filename of the apk file.

18. On the host computer, type:

```
adb disconnect.
```

## Uninstalling an Application

Free up device memory by removing unused apps.

1. Go to **Settings**.
2. Touch **Apps & notifications**.
3. Touch **See all apps** to view all apps in the list.
4. Scroll through the list to the app.
5. Touch the app. The **App info** screen appears.
6. Touch **Uninstall**.
7. Touch **OK** to confirm.

## Android System Update

System Update packages can contain either partial or complete updates for the operating system. Zebra distributes the System Update packages on the Zebra Support & Downloads website. Perform a system update using either a microSD card or using ADB.

### Performing a System Update Using USB Drive

Update the operating system on the device using a USB drive.

Go to the Zebra Support & Downloads web site at [zebra.com/support](http://zebra.com/support) and download the appropriate System Update package to a host computer.



**WARNING:** Do not remove the USB drive during system update. Damage to device can occur.



**IMPORTANT:** USB drive must have FAT32 format.

1. Install the USB drive into the host computer USB port.
2. Copy the System Update zip file to the root of a USB drive.
3. Properly eject the USB drive from host computer and remove the USB drive.
4. Remove the dust cover from the back of the device.
5. Insert the USB drive into the USB port.
6. Press and hold **Power** until the menu appears.
7. Touch **Restart**.
8. Press and hold **blue+** until the Zebra logo screen appears.  
The System Recovery screen appears.
9. Press **Volume Up** and **Volume Down** to navigate to **apply upgrade from USB drive**.
10. Press **Power**.
11. Use **Volume Up** and **Volume Down** to navigate to the System Update zip file.
12. Press **Power**.  
The System Update installs and then the device returns to the Recovery screen.
13. Press **Power** to reboot the device.

## Performing a System Update Using ADB

Use ADB to perform a system update.

Go to the Zebra Support & Downloads web site at [zebra.com/support](https://zebra.com/support) and download the appropriate System Update package to a host computer.

- Using a T10 Torx screwdriver, remove four screws securing the top cover to the device.

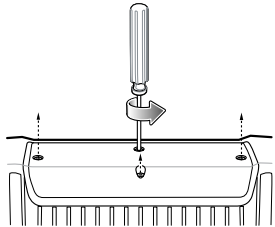

**CAUTION:** When the user connects a USB cable to the USB-C port on top of the device, the USB and RS-232 ports on the bottom are disabled.

- Connect the device to a host computer using a USB-C cable.
- Go to **Settings**.
- Touch **System > Advanced > Developer options**.
- Slide the **USB debugging** switch to the **ON** position.
- Touch **OK**.
- If the device and host computer are connected for the first time, the **Allow USB debugging?** dialog box with the **Always allow from this computer** check box displays. Select the check box, if required.
- Touch **OK** or **Allow**.
- On the host computer, navigate to the **platform-tools** folder and open a command prompt window.
- Type `adb devices`.

The following displays:

```
List of devices attached          XXXXXXXXXXXXXXXXXXXX device
```

Where XXXXXXXXXXXXXXXXXXXX is the device number.



**NOTE:** If device number does not appear, ensure that ADB drivers are installed properly.

- Type:
 

```
adb reboot recovery
```
- Press **Enter**.
 

The System Recovery screen appears on the device.
- Press **Up Arrow** and **Down Arrow** to navigate to **Apply upgrade from ADB**.
- Press **Up Arrow** and **Down Arrow** to navigate to **Full OTA Package** or **Diff OTA Package**.
- Press **Power**.

- On the host computer command prompt window type:

```
adb sideload <file>
```

where: <file> = the path and filename of the zip file.

- Press **Enter**.

The System Update installs (progress appears as percentage in the Command Prompt window) and then the System Recovery screen appears on the device.

- Disconnect the USB-C cable from the device.
- Replace the top cover.
- Secure the top cover to the device using the four screws.

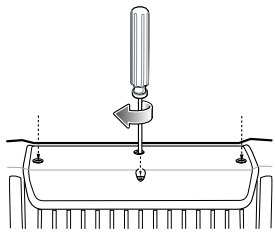

- Torque the screws to 6kg-cm (5.2lbs-in).

## Performing a System Update Using Wireless ADB

Use wireless ADB to perform a system update.

Go to the Zebra Support & Downloads web site at [zebra.com/support](https://zebra.com/support) and download the appropriate System Update package to a host computer.



**IMPORTANT:** Ensure the latest adb files are installed on the host computer.



**IMPORTANT:** The device and the host computer must be on the same wireless network.

- Go to **Settings**.
- Touch **System > Advanced > Developer options**.
- Slide the **USB debugging** switch to the **ON** position.
- Slide the **Wireless debugging** switch to the **ON** position.
- Touch **Wireless debugging**.
- If the device and host computer are connected for the first time, the **Allow wireless debugging on this network?** dialog box with the **Always allow from this network** check box displays. Select the check box, if required.
- Touch **ALLOW**.
- Touch **Pair with pairing code**.  
The **Pair with device** dialog box displays.

9. On the host computer, navigate to the **platform-tools** folder and open a command prompt window.
10. Type `adb pair XX.XX.XX.XX.XXXXX`.  
where `XX.XX.XX.XX.XXXXX` is the IP address and port number from the **Pair with device** dialog box.
11. Press **Enter**.
12. Type the pairing code from the **Pair with device** dialog box.
13. Press **Enter**.
14. Type `adb connect`.  
The device is now connected to the host computer.
15. Type:  
`adb reboot recovery`
16. Press **Enter**.  
The System Recovery screen appears on the device.
17. Press **Up** and **Down** to navigate to **Apply upgrade from ADB**.
18. Press **Power**.
19. Use **Up** and **Down** to navigate to **Full OTA Package**.
20. On the host computer command prompt window type:

```
adb sideload <file>
```

where: `<file>` = the path and filename of the zip file.

21. Press **Enter**.  
The System Update installs (progress appears as percentage in the Command Prompt window) and then the System Recovery screen appears on the device.
22. Navigate to **Reboot system now** and press the Power button to reboot the device.
23. On the host computer, type:  
`adb disconnect`.

## Verifying System Update Installation

Verify that the system update was successful.

1. Go to **Settings**.
2. Touch **About phone**.
3. Scroll down to **Build number**.
4. Ensure that the build number matches the new system update package file number.

## Android Enterprise Reset

An Enterprise Reset erases all user data in the /data partition, including data in the primary storage locations (emulated storage). Zebra distributes the Enterprise Reset packages on the Zebra Support & Downloads website.



Before performing an Enterprise Reset, provision all necessary configuration files and restore after the reset.

## Performing an Enterprise Reset Using ADB

Perform an Enterprise Reset Using ADB.

Go to the Zebra Support & Downloads web site at [zebra.com/support](https://zebra.com/support) and download the appropriate Enterprise Reset file to a host computer.

1. Using a T10 Torx screwdriver, remove four screws securing the top cover to the device.

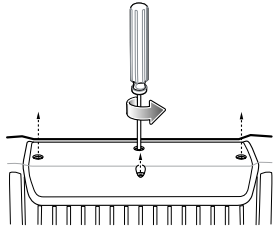

**CAUTION:** When the user connects a USB cable to the USB-C port on top of the device, the USB and RS-232 ports on the bottom are disabled.

2. Connect the device to a host computer using a USB-C cable.
3. Go to **Settings**.
4. Touch **System > Advanced > Developer options**.
5. Slide the **USB debugging** switch to the **ON** position.
6. Touch **OK**.
7. If the device and host computer are connected for the first time, the **Allow USB debugging?** dialog box with the **Always allow from this computer** check box displays. Select the check box, if required.
8. Touch **OK** or **Allow**.
9. On the host computer, navigate to the **platform-tools** folder and open a command prompt window.
10. Type `adb devices`.

The following displays:

```
List of devices attached          XXXXXXXXXXXXXXXXXXXX device
```

Where XXXXXXXXXXXXXXXXXXXX is the device number.



**NOTE:** If device number does not appear, ensure that ADB drivers are installed properly.

11. Type:
 

```
adb reboot recovery
```
12. Press **Enter**.
 

The System Recovery screen appears on the device.
13. Press **Up** and **Down** to navigate to **Apply upgrade from ADB**.

14. Press **Power**.
15. Use **Up** and **Down** to navigate to **Full OTA Package**.
16. Press **Power**.
17. On the host computer command prompt window type:

```
adb sideload <file>
```

where: <file> = the path and filename of the zip file.

18. Press **Enter**.  
The Enterprise Reset package installs and then the System Recovery screen appears on the device.
19. Press **Power** to reboot the device.
20. Disconnect the USB-C cable from the device.
21. Replace the top cover.
22. Secure the top cover to the device using the four screws.

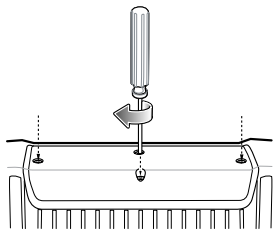

23. Torque the screws to 6kg-cm (5.2lbs-in).

## Performing an Enterprise Reset Using Wireless ADB

Perform an Enterprise Reset using Wireless ADB.

Go to the Zebra Support & Downloads web site at [zebra.com/support](https://zebra.com/support) and download the appropriate Enterprise Reset file to a host computer.



**IMPORTANT:** Ensure the latest adb files are installed on the host computer.



**IMPORTANT:** The device and host computer must be on the same wireless network.

1. Go to **Settings**.
2. Touch **System > Advanced > Developer options**.
3. Slide the **USB debugging** switch to the **ON** position.
4. Slide the **Wireless debugging** switch to the **ON** position.
5. If the device and host computer are connected for the first time, the **Allow wireless debugging on this network?** dialog box with the **Always allow from this network** check box displays. Select the check box, if required.
6. Touch **ALLOW**.

7. Touch **Wireless debugging**.
8. Touch **Pair with pairing code**.

The **Pair with device dialog** box displays.

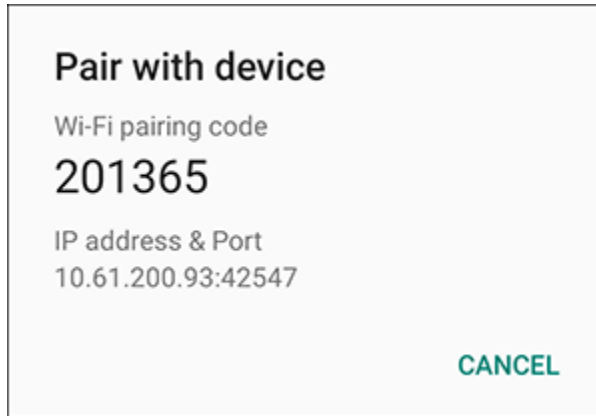

9. On the host computer, navigate to the **platform-tools** folder and open a command prompt window.
10. Type `adb pair XX.XX.XX.XX.XXXXXX`.  
where `XX.XX.XX.XX.XXXXXX` is the IP address and port number from the **Pair with device** dialog box.
11. Type: `adb connect XX.XX.XX.XX.XXXXXX`
12. Press **Enter**.
13. Type the pairing code from the **Pair with device** dialog box
14. Press **Enter**.
15. Type `adb connect`.  
The device is now connected to the host computer.
16. Type `adb devices`.  
The following displays:

```
List of devices attached      XXXXXXXXXXXXXXXXXXXX device
```

Where `XXXXXXXXXXXXXXXXXXXX` is the device number.



**NOTE:** If device number does not appear, ensure that ADB drivers are installed properly.

17. On the host computer command prompt window type:

```
adb sideload <file>
```

where: `<file>` = the path and filename of the zip file.

18. Type:  
`adb reboot recovery`
19. Press **Enter**.  
The Factory Recovery screen appears on the device.

20. Press **Up** and **Down** to navigate to **Apply upgrade from ADB**.
21. Press **Power**.
22. Use **Up** and **Down** to navigate to **Full OTA Package**.
23. On the host computer command prompt window type:

```
adb sideload <file>
```

where: <file> = the path and filename of the zip file.

24. Press **Enter**.  
The Enterprise Reset package installs and then the System Recovery screen appears on the device.
25. Press **Power** to reboot the device.
26. On the host computer, type:  
`adb disconnect.`

### Performing an Enterprise Reset Using USB Drive

Perform an Enterprise Reset using a USB drive.

Go to the Zebra Support & Downloads web site at [zebra.com/support](https://zebra.com/support) and download the appropriate Enterprise Reset file to a host computer.

1. Copy the Enterprise Reset zip file to the root of the USB drive.
  - Copy the zip file to a USB drive using a host computer and then install the microSD card into the device. See [Getting Started](#) for more information.
  - Connect the device with a microSD card already installed to the host computer and copy zip file to the microSD card. See [USB Communication](#) for more information. Disconnect the device from the host computer.
2. Press and hold **Power** until the menu appears.
3. Touch **Restart**.
4. Press and hold **Blue** until the Zebra boot screen appears.  
The Android Recovery screen appears.
5. Press **Up** and **Down** to navigate to the **apply update from USB drive**.
6. Press **Power**.
7. Press **Up** and **Down** to navigate to the Enterprise Reset file.
8. Press **Power**.  
The Enterprise Reset occurs and then the device returns to the Recovery screen.
9. Press **Power**.

#### See Also

[USB Communication](#)

## Android Factory Reset

A Factory Reset erases all data in the /data and /enterprise partitions in internal storage and clears all device settings. A Factory Reset returns the device to the last installed operating system image. To revert to a previous operating system version, re-install that operating system image. Zebra distributes the Factory Reset packages on the Zebra Support & Downloads website.

### Performing a Factory Reset Using ADB

Perform a Factory Reset using ADB.

Go to the Zebra Support & Downloads web site at [zebra.com/support](https://zebra.com/support) and download the appropriate Factory Reset file to a host computer.

- Using a T10 Torx screwdriver, remove four screws securing the top cover to the device.

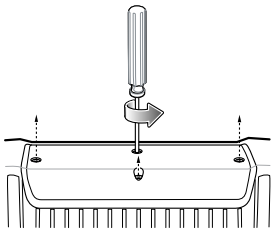

**CAUTION:** When the user connects a USB cable to the USB-C port on top of the device, the USB and RS-232 ports on the bottom are disabled.

- Connect the device to a host computer using a USB-C cable.
- Go to **Settings**.
- Touch **System > Advanced > Developer options**.
- Slide the **USB debugging** switch to the **ON** position.
- Touch **OK**.
- If the device and host computer are connected for the first time, the **Allow USB debugging?** dialog box with the **Always allow from this computer** check box displays. Select the check box, if required.
- Touch **OK** or **ALLOW**.
- On the host computer, navigate to the **platform-tools** folder and open a command prompt window.
- Type `adb devices`.

The following displays:

```
List of devices attached          XXXXXXXXXXXXXXXX device
```

Where XXXXXXXXXXXXXXXX is the device number.



**NOTE:** If device number does not appear, ensure that ADB drivers are installed properly.

- Type:
 

```
adb reboot recovery
```

12. Press **Enter**.  
The System Recovery screen appears on the device.
13. Press **Up Arrow** and **Down Arrow** to navigate to **Apply upgrade from ADB**.
14. Press **Power**.
15. Use **Up** and **Down** to navigate to **Full OTA Package**.
16. Press **Power**.
17. On the host computer command prompt window type:

```
adb sideload <file>
```

where: <file> = the path and filename of the zip file.

18. Press **Enter**.  
The Factory Reset package installs and then the System Recovery screen appears on the device.
19. Press **Power** to reboot the device.
20. Disconnect the USB-C cable from the device.
21. Replace the top cover.
22. Secure the top cover to the device using the four screws.

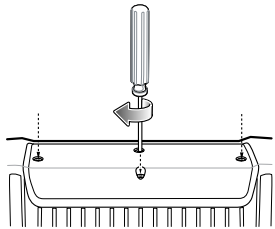

23. Torque the screws to 6kg-cm (5.2lbs-in).

## Performing a Factory Reset Using Wireless ADB

Perform a Factory Reset using Wireless ADB.

Go to the Zebra Support & Downloads web site at [zebra.com/support](https://zebra.com/support) and download the appropriate Factory Reset file to a host computer.



**IMPORTANT:** Ensure the latest adb files are installed on the host computer.



**IMPORTANT:** The device and host computer must be on the same wireless network.

1. Go to **Settings**.
2. Touch **System > Advanced > Developer options**.
3. Slide the **USB debugging** switch to the **ON** position.
4. Slide the **Wireless debugging** switch to the **ON** position.

5. If the device and host computer are connected for the first time, the **Allow wireless debugging on this network?** dialog box with the **Always allow from this network** check box displays. Select the check box, if required.
6. Touch **ALLOW**.
7. Touch **Wireless debugging**.
8. Touch **Pair with pairing code**.

The **Pair with device** dialog box displays.

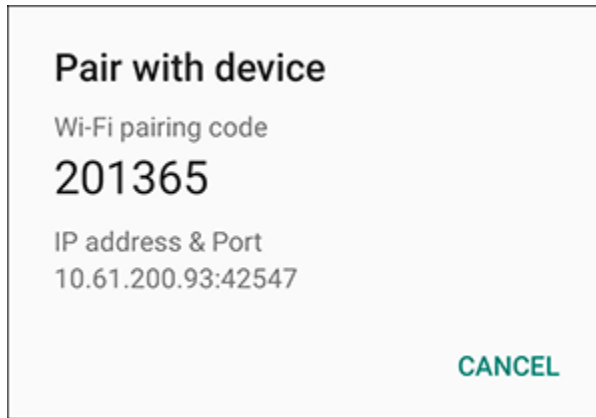

9. On the host computer, navigate to the **platform-tools** folder and open a command prompt window.
10. Type `adb pair XX.XX.XX.XX.XXXXXX`.  
where `XX.XX.XX.XX.XXXXXX` is the IP address and port number from the **Pair with device** dialog box.
11. Type: `adb connect XX.XX.XX.XX.XXXXXX`
12. Press Enter.
13. Type the pairing code from the **Pair with device** dialog box
14. Press Enter.
15. Type `adb connect`.  
The device is now connected to the host computer.
16. Type `adb devices`.  
The following displays:

```
List of devices attached      XXXXXXXXXXXXXXXXXXXX device
```

Where XXXXXXXXXXXXXXXXXXXX is the device number.



**NOTE:** If device number does not appear, ensure that ADB drivers are installed properly.

17. Type:  
`adb reboot recovery`
18. Press **Enter**.  
The Factory Reset package installs and then the System Recovery screen appears on the device.

19. Press **Up** and **Down** to navigate to **Apply upgrade from ADB**.
20. Press **Power**.
21. Use **Up** and **Down** to navigate to **Full OTA Package**.
22. On the host computer command prompt window type:

```
adb sideload <file>
```

where: <file> = the path and filename of the zip file.

23. Press **Enter**.  
The Factory Reset package installs and then the System Recovery screen appears on the device.
24. Press **Power** to reboot the device.
25. On the host computer, type:  
`adb disconnect.`

### Performing a Factory Reset Using a USB Drive

Perform a Factory Reset using a USB drive.

Go to the Zebra Support & Downloads web site at [zebra.com/support](http://zebra.com/support) and download the appropriate Factory Reset file to a host computer.

1. Copy the Factory Reset zip file to the root of the USB drive.
  - Copy the zip file to a USB drive using a host computer and then installing the USB drive into the device.
  - Connect the device with a USB drive already installed to the host computer and copy the zip file to the USB drive. Disconnect the device from the host computer.
2. Press and hold **Power** until the menu appears.
3. Touch **Restart**.  
The device resets.
4. Press and hold **Blue** until the Zebra boot screen.  
The System Recovery screen appears.
5. Press **Up** and **Down** to navigate to the **apply update from USB drive**.
6. Press **Power**.
7. Press **Up** and **Down** to navigate to the Android Reset file.
8. Press **Power**.  
The Factory Reset occurs and then the device returns to the Recovery screen.
9. Press **Power**.

#### See Also

[USB Communication](#)



## Android Storage

The device contains multiple types of file storage.

- Random Access Memory (RAM)
- Internal storage
- External storage (USB)
- Enterprise folder.

## Random Access Memory

Executing programs use RAM to store data. Data stored in RAM is lost upon a reset.

The operating system manages how applications use RAM. It only allows applications and component processes and services to use RAM when required. It may cache recently used processes in RAM, so they restart more quickly when opened again, but it will erase the cache if it needs the RAM for new activities.

The screen displays the amount of used and free RAM.

- **Performance** - Indicates memory performance.
- **Total memory** - Indicates the total amount of RAM available.
- **Average used (%)** - Indicates the average amount of memory (as a percentage) used during the period of time selected (default - 3 hours).
- **Free** - Indicates the total amount of unused RAM.
- **Memory used by apps** - Touch to view RAM usage by individual apps.

## Viewing Memory

View the amount of memory used and free RAM.

1. Go to **Settings**.
2. Touch **System > Advanced > Developer options** .
3. Touch **Memory**.

## Internal Storage

The device has internal storage. The internal storage content can be viewed and files copied to and from when the device is connected to a host computer. Some applications are designed to be stored on the internal storage rather than in internal memory.

## Viewing Internal Storage

View available and used internal storage on the device.

1. Go to **Settings**.
2. Touch **Storage**.

**Internal Storage** displays the total amount of space on internal storage and amount used.

If the device has removable storage installed, touch **Internal shared storage** to display the amount of internal storage used by apps, photos, videos, audio, and other files.

## External Storage

The device can have a removable USB drive. The USB drive content can be viewed and files copied to and from when the device is connected to a host computer.

### Viewing External Storage

Portable storage displays the total amount of space on the USB drive and the amount used.

1. Go to **Settings**.
2. Touch **Storage**.
3. Touch **General USB Drive** to view the total amount of space on the installed USB drive and the amount used.
4. To unmount the USB drive, touch .

### Formatting a USB Drive as Portable Storage

Format a USB drive as portable storage on the device.

1. Touch **USB drive**.
2. Touch  > **Storage settings**.
3. Touch **Format**.
4. Touch **ERASE & FORMAT**.
5. Touch **DONE**.

### Enterprise Folder

The Enterprise folder (within internal flash) is a super-persistent storage that is persistent after a reset and an Enterprise Reset.

The Enterprise folder is erased during a Factory Reset. The Enterprise folder is used for deployment and device-unique data. The Enterprise folder is approximately 128 MB (formatted). Applications can persist data after an Enterprise Reset by saving data to the enterprise/user folder. The folder is ext4 formatted and is only accessible from a host computer using ADB or from an MDM.

## Managing Apps

Apps use two kinds of memory: storage memory and RAM. Apps use storage memory for themselves and any files, settings, and other data they use. They also use RAM when they are running.

1. Go to **Settings**.
2. Touch **Apps & notifications**.
3. Touch **See all XX apps** to view all apps on the device.
4. Touch  > **Show system** to include system processes in the list.
5. Touch an app, process, or service in the list to open a screen with details about it and, depending on the item, to change its settings, permissions, notifications and to force stop or uninstall it.



## App Details

Apps have different kinds of information and controls.

- **Force stop** - Stop an app.
- **Disable** - Disable an app.
- **Uninstall** - Remove the app and all of its data and settings from the device.
- **Notifications** - Set the app notification settings.
- **Permissions** - Lists the areas on the device that the app has access to.
- **Storage & cache** - Lists how much information is stored and includes buttons for clearing it.
- **Mobile data & Wi-Fi** - Provides information about data consumed by an app.
- **Mobile data & Wi-Fi** - Provides information about data consumed by an app. Mobile data not supported.
- **Advanced**
  - **Screen time** - Displays the amount of time the app has displayed on the screen.
  - **Battery** - Lists the amount of computing power used by the app.
  - **Open by default** - If you have configured an app to launch certain file types by default, you can clear that setting here.
  - **Display over other apps** - Allows an app to display on top of other apps.
  - **App details** - Provides a link to additional app details on the Play store.
  - **Additional settings in the app** - Opens settings in the app.
  - **Modify system settings** - Allows an app to modify the system settings.

## Managing Downloads

Files and apps downloaded using the Browser or Email are stored on the USB drive or Internal storage in the Download directory. Use the Downloads app to view, open, or delete downloaded items. Files and apps downloaded using the Browser or Email are stored on the microSD card or Internal storage in the Download directory. Use the Downloads app to view, open, or delete downloaded items.

1. Swipe the screen up and touch .
2. Touch  > **Downloads**.
3. Touch and hold an item, select items to delete and touch . The item is deleted from the device.

# Maintenance and Troubleshooting

This section includes instructions on cleaning the device and provides troubleshooting solutions for potential problems during device operations.



**DANGER:** Danger due to electric shock when cleaning and maintaining the device. To avoid electric shock, turn the device off and disconnect it from the power supply before cleaning or maintaining it.

## Cleaning the Device

Do not use compressed air, a high-pressure cleaner, or a vacuum cleaner, as this can damage the surface. Using a high-pressure cleaner poses the additional risk of water entering the device and damaging the electronics or display.

### Housing

Clean the fully assembled device vehicle mount computer housing using only a mild detergent on a lightly dampened soft cloth.

### Cleaning the Touchscreen

Use neutral detergent or isopropyl alcohol on a clean soft cloth to clean the panel surface. Do not use any kind of chemical solvent, acidic, or alkali solution.

### Housing

Clean the fully assembled device vehicle mount computer housing using only a mild detergent on a lightly dampened soft cloth.

## Touchscreen

The VC8300-8 and VC8300-10 (Standard models) are equipped with a capacitive touchscreen. The VC8300-10 (Freezer model) is equipped with a resistive touch screen.



**NOTE:** Keep the touchscreen clean. See [Cleaning the Touchscreen](#) on page 132.

- Do not apply adhesives to the surface.

- Avoid high voltage and/or static charge.
- Do not use ballpoint pens, writing utensils, tools, or sharp objects.
- Touch the panel only with your finger to ensure normal operation.
- Operate in a stable environment. Abrupt variation of temperature and humidity may cause malfunction.
- Operate in a stable environment. Abrupt variation of temperature and humidity may cause malfunction.

Avoid applying excessive activation force or sudden impact on the touchscreen surface.

Operation of the capacitive touch screen is recommended with:

- Clean, dry fingers.
- Clean, dry, soft gloves.

## Troubleshooting

In rare circumstances, to troubleshoot the device, you may need to reset the device.

### Resetting the Device

This section describes options to reset the device.

There are four reset functions:

- Soft reset
- Hard reset
- Enterprise reset.
- Factory reset.

#### Performing a Soft Reset

Perform a soft reset if applications stop responding.

1. Press and hold **Power** until the menu appears.
2. Touch **Restart**.

The device reboots.

#### Performing a Hard Reset

Perform a hard reset if the device stops responding.



**CAUTION:** Performing a hard reset with a USB drive installed in the device may cause damage or data corruption to the USB drive.

1. Press and hold **Power** for at least 16 seconds.
2. Release **Power** when the Zebra logo appears.

The device reboots.

## Troubleshooting the Device

The following table provides typical problems that might arise and the solution for correcting the problem.

**Table 21** Troubleshooting the VC8300

Symptom	Possible Cause	Solution
The vehicle computer does not power on or shuts off suddenly.	The power cable ignition sense wire (yellow) is not connected properly.	Verify that the power cable is connected properly. See <a href="#">Wiring Vehicle Power to the Device</a> on page 24.
	Power cable not connected properly or unplugged.	Connect power cable to power cable portion underside of vehicle computer. Turn the main power switch on.
	If the vehicle computer is powered by a vehicle battery, the vehicle battery is depleted.	Replace or charge the vehicle battery.
Cannot see characters on display.	Vehicle computer not powered on (Power LED is Off).	Press <b>Power</b> .
	Screen is too dark.	Adjust the brightness.
	The vehicle computer is in suspend mode (Power LED is on).	Press <b>Power</b> to turn on the vehicle computer.
The touchscreen is not working.	Replacement screen protector was damaged.	Replace screen protector.
	Touch screen is damaged.	See system administrator.
The optional serial scanner does not operate.	Scanner is not properly connected to the vehicle computer.	Connect the scanner to the COM1 or COM2 port. Ensure the proper COM port is selected in the <b>VC Settings</b> application, see <a href="#">Connecting an RS-232 Scanner on page 65</a> . If the problem continues, refer to the scanner Product Reference Guide.
	External power is not connected.	Verify external power connection.
	Power is not applied to COM port.	Enable power to COM ports. See <a href="#">VC Settings</a> on page 62.
	Serial COM port in not enabled in DataWedge.	Enable the serial COM port in the DataWedge profile.
	USB cable is connected to USB port on top of device.	Disconnect USB cable from top of device.
The optional USB scanner does not operate.	USB cable is connected to USB port on top of device.	Disconnect USB cable from top of device.
	Scanner not configured for correct protocol (SSI or HID)	Configure scanner to correct protocol. See <a href="#">Data Capture</a> on page 64.

**Table 21** Troubleshooting the VC8300 (Continued)

Symptom	Possible Cause	Solution
	USB connector not connected properly.	Remove USB cable and re-connect.
No sound is heard when you tap the touchscreen or press a key.	Volume is turned down.	Adjust the volume.
	Application currently running disabled the sound.	Configure the application to enable the sound.
	Faulty speaker.	Contact Zebra support at <a href="http://zebra.com/support">zebra.com/support</a> .
	The optional M1000 speakerphone/mic is connected to the device.	Normal operation, sound is through speaker / mic.
Missing pixels on the display.	Faulty LCD.	Contact Zebra support at <a href="http://zebra.com/support">zebra.com/support</a> .
COM1 or COM2 port is not working.	Another application, or DataWedge is using the port.	Stop the application using the port or change the DataWedge COM Port Settings.
	USB cable connected to the USB port on top of the device.	Disconnect USB cable from USB port on top of the device.
No keys are working on the built-in keyboard.	The application does not require keyboard input.	Configure the application to use the keyboard.
	Vehicle computer is not responding.	Warm boot the vehicle computer.
The vehicle computer cannot find any Bluetooth devices nearby.	Too far from other Bluetooth devices.	Move closer to the other Bluetooth device(s).
	The Bluetooth device(s) nearby are not turned on.	Turn on the Bluetooth device(s).
	The Bluetooth device(s) are not in discoverable mode.	Set the Bluetooth device(s) to discoverable mode.
When installed on some electric forklifts, the scanner range is shorter than it is when installed on other forklifts.	Electro-magnetic interference caused by the forklift.	Consult forklift vendor about reducing the interference by adding a capacitor between the forklift chassis and its battery's negative terminal, or another recommended solution.
Wi-Fi Signal strength degraded.	Incorrect antenna selection.	Check antenna selection. See <a href="#">VC Settings</a> on page 62.
	Damaged external antenna.	Either right or left external antenna broken or not connected properly.
	Using wrong antenna.	See accessory list for correct antenna for device.

**Table 21** Troubleshooting the VC8300 (Continued)

Symptom	Possible Cause	Solution
Cannot find Bluetooth devices.	Incorrect antenna selection.	Check antenna selection. See <a href="#">VC Settings</a> on page 62.
	Damaged external antenna.	Right external antenna broken or not connected properly.
	Using wrong antenna.	See accessory list for correct antenna for device.



# Specifications

For device technical specifications, go to [zebra.com/support](http://zebra.com/support).

## Drill Hole Dimensions

The diagram describes what the hole dimensions should be when installing the device.

**Figure 39** Drill Hole Dimensions

