

# Dell Pro Rugged 13

RA13250

Owner's Manual

## Notes, cautions, and warnings

 **NOTE:** A NOTE indicates important information that helps you make better use of your product.

 **CAUTION:** A CAUTION indicates either potential damage to hardware or loss of data and tells you how to avoid the problem.

 **WARNING:** A WARNING indicates a potential for property damage, personal injury, or death.

|  |           |
|--|-----------|
| <b>Chapter 1: Views of Dell Pro Rugged 13 RA13250</b>  | <b>8</b>  |
| Right  | 8         |
| Left   | 9         |
| Top  | 10        |
| Front  | 11        |
| Back   | 12        |
| Bottom   | 13        |
| Locate the Service Tag or Express Service Code label of your computer                            | 14        |
| Battery-charge status light  | 15        |
| <b>Chapter 2: Set up your Dell Pro Rugged 13 RA13250</b>   | <b>16</b> |
| <b>Chapter 3: Specifications of Dell Pro Rugged 13 RA13250</b>                                   | <b>18</b> |
| Dimensions and weight  | 18        |
| Processor  | 18        |
| Chipset  | 19        |
| Operating system   | 19        |
| Memory   | 19        |
| External ports and slots   | 20        |
| Internal slots   | 20        |
| Ethernet   | 21        |
| Wireless module  | 21        |
| WWAN module  | 21        |
| Optional GPS module  | 22        |
| Audio  | 23        |
| Storage  | 23        |
| Media-card reader  | 24        |
| Keyboard   | 24        |
| Keyboard shortcuts of Dell Pro Rugged 13 RA13250   | 25        |
| Camera   | 26        |
| Touchpad   | 27        |
| Battery  | 27        |
| Power requirements   | 28        |
| Power adapter  | 29        |
| Power adapter requirements (for computers shipped with Intel Core Ultra 5/7—U series processors) | 29        |
| Power adapter requirements (for computers shipped with Intel Core Ultra 7—H series processors)   | 30        |
| Display  | 31        |
| Fingerprint reader (optional)  | 32        |
| Sensor   | 32        |
| GPU—Integrated   | 32        |
| Multiple display support matrix  | 32        |
| Hardware security  | 33        |
| Smart-card reader  | 33        |

|  |           |
|--|-----------|
| Contactless smart-card reader.....   | 33        |
| Contacted smart-card reader.....   | 37        |
| Operating and storage environment.....   | 38        |
| Dell low blue light display.....   | 38        |
| <b>Chapter 4: Working inside your computer.....</b>                              | <b>40</b> |
| Safety instructions.....   | 40        |
| Before working inside your computer.....   | 40        |
| Safety precautions.....  | 41        |
| Electrostatic discharge—ESD protection.....                                      | 41        |
| ESD Field Service kit .....  | 42        |
| Transporting sensitive components.....   | 43        |
| After working inside your computer.....  | 43        |
| BitLocker.....   | 43        |
| Recommended tools.....   | 43        |
| Screw list.....  | 44        |
| Major components of Dell Pro Rugged 13 RA13250.....                              | 46        |
| <b>Chapter 5: Removing and installing Customer Replaceable Units (CRUs).....</b> | <b>49</b> |
| Battery.....   | 49        |
| Rechargeable Li-ion battery precautions.....                                     | 49        |
| Removing the batteries.....  | 49        |
| Installing the batteries.....  | 51        |
| Stylus.....  | 52        |
| Removing the stylus.....   | 52        |
| Installing the stylus.....   | 53        |
| <b>Chapter 6: Removing and installing Field Replaceable Units (FRUs).....</b>    | <b>55</b> |
| Handle.....  | 55        |
| Removing the handle.....   | 55        |
| Installing the handle.....   | 56        |
| Keyboard.....  | 57        |
| Removing the keyboard (standard).....  | 57        |
| Installing the keyboard (standard).....  | 60        |
| Removing the keyboard (rubberized).....  | 64        |
| Installing the keyboard (rubberized).....  | 66        |
| Solid state drive carrier.....   | 70        |
| Removing the solid state drive carrier.....                                      | 70        |
| Installing the solid state drive carrier.....                                    | 72        |
| M.2 solid state drive.....   | 74        |
| Removing the M.2 2230 solid state drive from the carrier.....                    | 74        |
| Installing the M.2 2230 solid state drive into the carrier.....                  | 75        |
| Removing the M.2 2280 solid state drive from the carrier.....                    | 77        |
| Installing the M.2 2280 solid state drive into the carrier.....                  | 77        |
| Base cover.....  | 79        |
| Removing the base cover.....   | 79        |
| Installing the base cover.....   | 81        |
| Stylus holder.....   | 84        |
| Removing the stylus holder.....  | 84        |

|  |     |
|--|-----|
| Installing the stylus holder.....                              | 85  |
| Coin-cell battery.....   | 86  |
| Removing the coin-cell battery.....                            | 86  |
| Installing the coin-cell battery.....                          | 87  |
| Fan.....   | 88  |
| Removing the fan.....  | 88  |
| Installing the fan.....  | 89  |
| Global Positioning System (GPS) board .....                    | 91  |
| Removing the GPS board .....                                   | 91  |
| Installing the GPS board .....                                 | 92  |
| Rear I/O-board.....  | 93  |
| Removing the rear I/O-board.....                               | 93  |
| Installing the rear I/O-board.....                             | 94  |
| Fischer USB port (optional).....                               | 96  |
| Removing the rear Fischer USB port.....                        | 96  |
| Installing the rear Fischer USB port.....                      | 96  |
| Rear Fischer USB I/O-board.....                                | 97  |
| Removing the optional rear Fischer USB I/O-board.....          | 97  |
| Installing the optional rear Fischer USB I/O-board.....        | 98  |
| Rear Ethernet I/O-board.....                                   | 100 |
| Removing the optional rear Ethernet I/O-board.....             | 100 |
| Installing the optional rear Ethernet I/O-board.....           | 101 |
| Rear Serial I/O-board.....                                     | 102 |
| Removing the optional rear serial I/O-board.....               | 102 |
| Installing the optional rear serial I/O-board.....             | 103 |
| Rear USB Type-A I/O-board.....                                 | 104 |
| Removing the optional rear USB Type-A I/O-board.....           | 104 |
| Installing the rear USB Type-A I/O-board.....                  | 105 |
| RF switch board.....   | 106 |
| Removing the RF switch board .....                             | 106 |
| Installing the RF switch board.....                            | 107 |
| Wireless Local Area Network (WLAN) card.....                   | 109 |
| Removing the WLAN card.....                                    | 109 |
| Installing the WLAN card.....                                  | 111 |
| Wireless Wide Area Network (WWAN) card.....                    | 112 |
| Removing the WWAN card.....                                    | 112 |
| Installing the WWAN card.....                                  | 116 |
| Express-card reader.....                                       | 121 |
| Removing the express-card reader.....                          | 121 |
| Installing the express-card reader.....                        | 122 |
| Smart-card reader.....   | 123 |
| Removing the smart-card reader.....                            | 123 |
| Installing the smart-card reader.....                          | 124 |
| Smart-card and Express-card reader bracket.....                | 124 |
| Removing the smart-card and express-card reader bracket.....   | 124 |
| Installing the smart-card and express-card reader bracket..... | 125 |
| Dock I/O-module.....   | 126 |
| Removing the dock I/O-module .....                             | 126 |
| Installing the dock I/O-module .....                           | 127 |
| Dock I/O-bracket.....  | 128 |

|   |            |
|---|------------|
| Removing the dock I/O-bracket.....                    | 128        |
| Installing the dock I/O-bracket.....                  | 130        |
| Heat sink.....  | 131        |
| Removing the heat sink .....                          | 131        |
| Installing the heat sink .....                        | 132        |
| System board.....                                     | 134        |
| Removing the system board.....                        | 134        |
| Installing the system board.....                      | 140        |
| Right Type-C board .....                              | 144        |
| Removing the right Type-C board.....                  | 144        |
| Installing the right Type-C board.....                | 146        |
| Left Type-C board.....                                | 147        |
| Removing the left Type-C board.....                   | 147        |
| Installing the left Type-C board.....                 | 149        |
| Latch doors.....                                      | 151        |
| Removing the latch doors.....                         | 151        |
| Installing the latch doors.....                       | 152        |
| Display assembly.....                                 | 153        |
| Removing the display assembly.....                    | 153        |
| Installing the display assembly.....                  | 157        |
| Display-panel assembly.....                           | 161        |
| Removing the display-panel assembly.....              | 161        |
| Installing the display-panel assembly.....            | 162        |
| Display back-cover assembly.....                      | 165        |
| Removing the display back-cover assembly.....         | 165        |
| Installing the display back-cover assembly.....       | 166        |
| Palm-rest assembly.....                               | 168        |
| Removing the palm-rest assembly.....                  | 168        |
| Installing the palm-rest assembly.....                | 169        |
| <b>Chapter 7: Software.....</b>                       | <b>172</b> |
| Operating system.....                                 | 172        |
| Drivers and downloads.....                            | 172        |
| <b>Chapter 8: Technology and components.....</b>      | <b>173</b> |
| Rugged Control Center.....                            | 173        |
| <b>Chapter 9: BIOS Setup.....</b>                     | <b>174</b> |
| Entering BIOS Setup program.....                      | 174        |
| Navigation keys.....                                  | 174        |
| F12 One Time Boot menu.....                           | 174        |
| View Advanced Setup options.....                      | 175        |
| View Service options.....                             | 175        |
| System Setup options.....                             | 175        |
| Updating the BIOS.....                                | 196        |
| Updating the BIOS in Windows.....                     | 196        |
| Updating the BIOS using the USB drive in Windows..... | 197        |
| Updating the BIOS from the One-Time boot menu.....    | 197        |
| System and setup password.....                        | 198        |

|  |            |
|--|------------|
| Assigning a System Setup password.....                                       | 198        |
| Deleting or changing an existing system password or setup password.....      | 199        |
| Clearing CMOS settings.....  | 199        |
| Clearing BIOS (System Setup) and System passwords.....                       | 200        |
| <b>Chapter 10: Troubleshooting.....</b>                                      | <b>201</b> |
| Handling swollen rechargeable Li-ion batteries.....                          | 201        |
| Locating the Service Tag or Express Service Code of your Dell computer ..... | 201        |
| Dell SupportAssist Pre-boot System Performance Check diagnostics.....        | 202        |
| Running the SupportAssist Pre-Boot System Performance Check.....             | 202        |
| Built-in self-test (BIST).....   | 202        |
| M-BIST.....  | 202        |
| LCD Power rail test (L-BIST).....  | 203        |
| LCD Built-in Self-Test (BIST).....   | 203        |
| System-diagnostic lights .....   | 204        |
| Recovering the operating system.....   | 204        |
| Real-Time Clock (RTC Reset).....   | 205        |
| Backup media and recovery options.....                                       | 205        |
| Wi-Fi power cycle.....   | 205        |
| Drain flea power (perform hard reset).....                                   | 205        |
| <b>Chapter 11: Getting help and contacting Dell.....</b>                     | <b>207</b> |

# Views of Dell Pro Rugged 13 RA13250

## Right

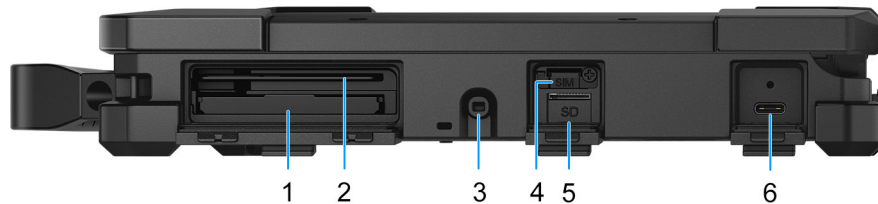

Figure 1. Right view

1. **Express-card reader slot (optional)**

Insert ExpressCard modules to add new features to your laptop, such as extra ports or additional memory.

2. **Smart-card reader slot (optional)**

Reads information from a smart card with an integrated-chip.

**NOTE:** Ensure that the smart card does not exceed the edge of the back cover while inserting in to the smart-card cover.

3. **Stylus slot**

Dock the stylus into the slot after use.

4. **Nano-SIM card slot (optional)**

Insert a SIM card to connect to a mobile broadband network.

5. **microSD-card slot**

Insert a microSD card to expand the computer's storage capacity.

6. **Thunderbolt 4.0 with DisplayPort Alt Mode/USB Type-C/USB4/Power Delivery (optional)**

Supports USB4, DisplayPort 1.4, Thunderbolt 4 and also enables you to connect to an external display using a display adapter. Supports data transfer rates of up to 40 Gbps for USB4 and Thunderbolt 4.

**NOTE:** You can connect a Dell Docking Station to the Thunderbolt 4 ports. For more information, search in the Knowledge Base Resource at [Dell Support Site](#).

**NOTE:** A USB Type-C to DisplayPort adapter (sold separately) is required to connect a DisplayPort device.

**NOTE:** USB4 is backward compatible with USB 3.2, USB 2.0, and Thunderbolt 3.

**NOTE:** Thunderbolt 4 supports two 4K displays or one 8K display.

# Left



Figure 2. Left view

## 1. Thunderbolt 4.0 with DisplayPort Alt Mode/USB Type-C/USB4/Power Delivery

Supports USB4, DisplayPort 1.4, Thunderbolt 4 and also enables you to connect to an external display using a display adapter. Provides data transfer rates of up to 40 Gbps for USB4 and Thunderbolt 4.

**NOTE:** You can connect a Dell Docking Station to the Thunderbolt 4 ports. For more information, search in the Knowledge Base Resource at [Dell Support Site](#).

**NOTE:** A USB Type-C to DisplayPort adapter (sold separately) is required to connect a DisplayPort device.

**NOTE:** USB4 is backward compatible with USB 3.2, USB 2.0, and Thunderbolt 3.

**NOTE:** Thunderbolt 4 supports two 4K displays or one 8K display.

Connect devices such as external storage devices and printers. Supports Power Delivery that enables two-way power supply between devices. Provides up to a 5 V power output that enables faster charging.

Provides data transfer speeds up to 10 Gbps.

## 2. Air vent

Air vents provide ventilation for your computer. Clogged air vents can cause overheating and can affect your computer's performance and potentially cause hardware issues. Keep the air vents clear of obstructions and clean them regularly to prevent the build-up of dust and dirt. For more information about cleaning air vents, search for articles in the Knowledge Base Resource at [Dell Support Site](#).

## 3. USB 3.2 Gen 1 port with PowerShare

Connect devices such as external storage devices and printers.

Supports data transfer speeds up to 5 Gbps. PowerShare enables you to charge your USB devices even when your computer is turned off.

**NOTE:** If your computer is turned off or in a hibernate state, you must connect the power adapter to charge your devices using the PowerShare port. You must enable this feature in the BIOS setup program.

**NOTE:** Certain USB devices may not charge when the computer is turned off or in a sleep state. In such cases, turn on the computer to charge the device.

## 4. USB 3.2 Gen 1 (5 Gbps) port

Connect to external storage devices. Provides data transfer speeds up to 5 Gbps.

## 5. Headset (headphone and microphone combo) port

Connect headphones or a headset (headphone and microphone combo).

# Top

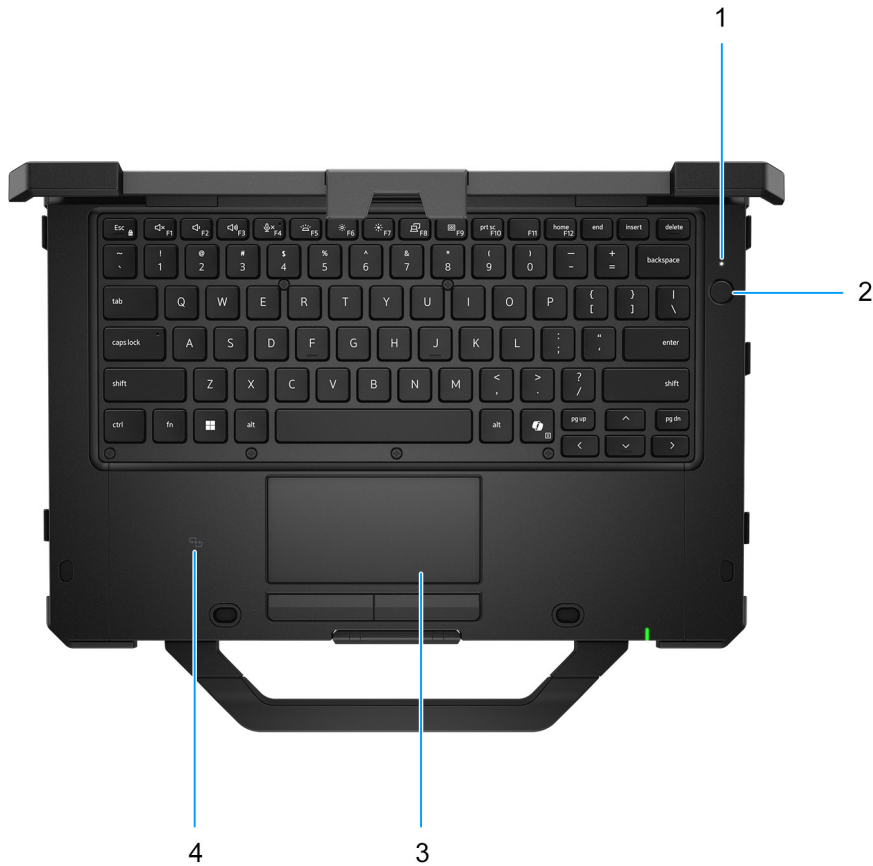

Figure 3. Top view

### 1. Power-status light

Indicates the power state of the computer.

### 2. Power button with optional fingerprint reader

Press to turn on the computer if it is turned off, in sleep state, or in hibernate state.

When the computer is turned on, press the power button to put the computer into a sleep state; press and hold the power button for 10 s to force shut-down the computer.

If the power button has a fingerprint reader, place your finger on the power button steadily to log in.

**NOTE:** You can customize the power-button behavior in Windows.

### 3. Touchpad

Move your finger on the touchpad to move the mouse pointer. Tap on the left button for left-click and the right button for right-click.

### 4. NFC-sensor area

Enables NFC-enabled devices to communicate with your computer.

# Front

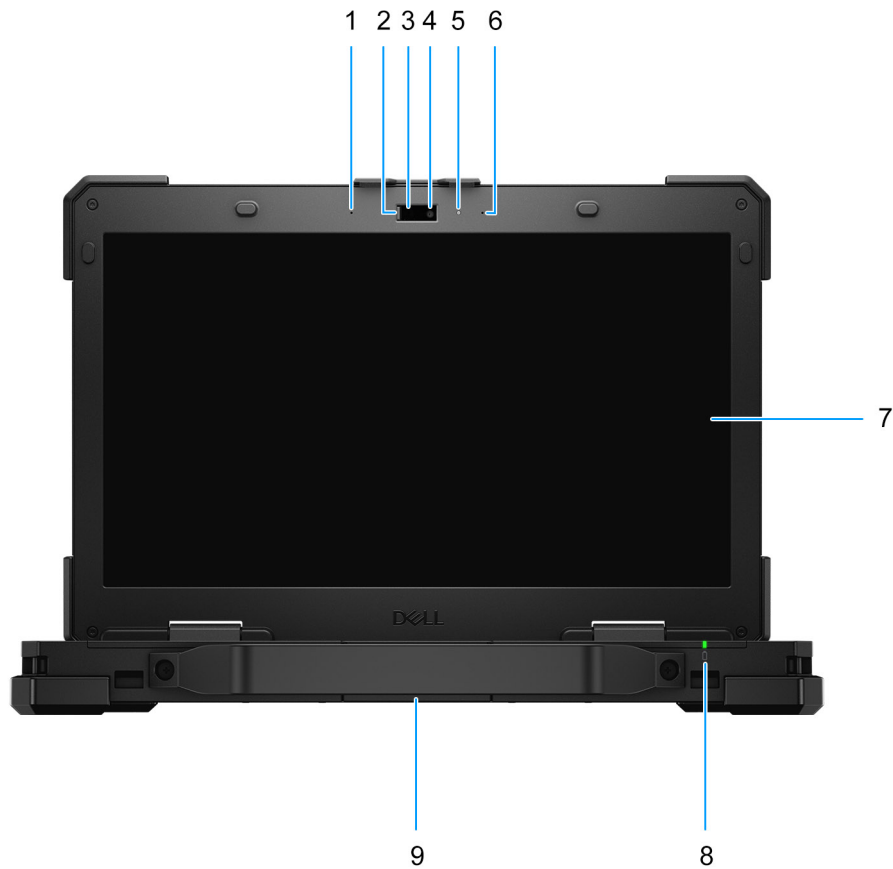

**Figure 4. Front view**

- 1. Left microphone**  
Provides digital sound input for audio recording and voice calls.
- 2. Privacy shutter**  
Slide the privacy shutter to cover the camera lens and protect your privacy when the camera is not in use.
- 3. Infrared emitter**  
Emits infrared light, which enables the infrared camera to sense and track motion.
- 4. Infrared camera**  
Enhances security when paired with Windows Hello face authentication.
- 5. Camera-status light**  
Turns on when the camera is in use.
- 6. Right microphone**  
Provides digital sound input for audio recording and voice calls.
- 7. Display panel**  
Provides visual output to the user.
- 8. Battery-status light or diagnostic-status light**  
Indicates the battery-charge status.

- Solid amber-Battery charge is low.
- Off-Battery is fully charged.

## 9. Display latch

Secures the display panel when closed. Press the latch to open the lid.

# Back

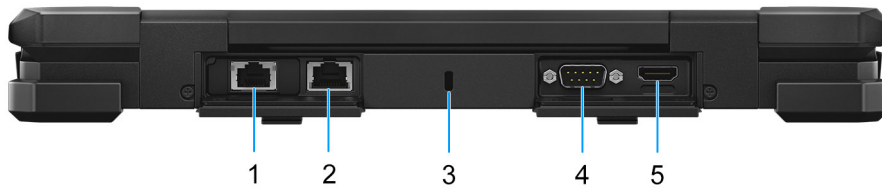

**Figure 5. Back view**

### 1. Optional I/O bay

Choose from: RJ45 (1 Gbps) Ethernet port/USB 3.2 Type-A port/Serial port/Fischer USB port.

- With RJ45 Ethernet port - Connect an Ethernet (RJ45) cable from a router or a broadband modem for network or Internet access, with a transfer rate of 10/100/1000 Mbps.
- With USB 3.2 Type-A port - Connect devices such as external storage devices and printers. Provides data transfer speeds up to 5 Gbps.
- With Serial port - Connects serial devices using the RS-232 standard through an adapter or external interface, enabling communication with legacy hardware and peripherals.
- With Fischer USB port - Provides a secure, high-speed connection for USB 3.0 devices, supporting data transfer rates up to 5 Gbps.

### 2. RJ45 Ethernet port

Connect an Ethernet (RJ45) cable from a router or a broadband modem for network or Internet access, with a transfer rate of 10/100/1000 Mbps.

### 3. Security-cable slot (wedge-shaped)

Connect a security cable to prevent unauthorized movement of your laptop.

### 4. Serial port

Connects serial devices using the RS-232 standard, enabling communication with legacy hardware and peripherals.

### 5. HDMI 2.1 TMDS port

Connect to a TV, external display, or another HDMI-in enabled device. Provides video and audio output.

# Bottom

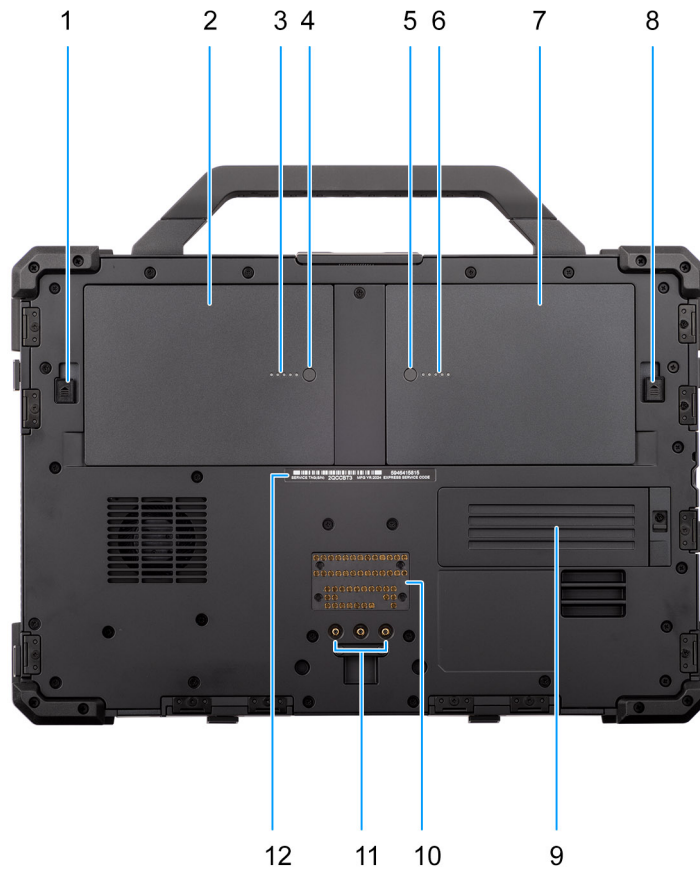

Figure 6. Bottom view

**1. Battery-release latch**

Lock or unlock the battery in the battery bay. Slide the latch to the unlocked position to release the battery.

**2. Battery**

Supplies power to the laptop. It enables the laptop to work without connecting to an electrical outlet for a certain time.

**3. Battery-status light**

Indicates the battery-charge status.

Solid green-Battery is charging.

Off-Battery is fully charged.

**4. Battery-charge status button**

Press to check the charge remaining in the battery.

**5. Battery-charge status button**

Press to check the charge remaining in the battery.

**6. Battery-status light**

Indicates the battery-charge status.

Solid green-Battery is charging.

Off-Battery is fully charged.

**7. Battery**

Supplies power to the laptop. It enables the laptop to work without connecting to an electrical outlet for a certain time.

**8. Battery-release latch**

Lock or unlock the battery in the battery bay. Slide the latch to the unlocked position to release the battery.

**9. Solid state drive door**

Covers and protects the solid state drive, ensuring secure installation and access.

**10. Docking port**

Enables docking to the laptop.

**11. Radio frequency pass-through connectors**

Provides an option to switch the main WWAN, WLAN, and GPS antenna signals from internal to external antennas when the device is docked.

**12. Service tag label**

The Service Tag is a unique alphanumeric identifier that enables Dell service technicians to identify the hardware components in your computer and access warranty information.

## Locate the Service Tag or Express Service Code label of your computer

The service tag is a unique alphanumeric identifier that allows Dell service technicians to identify the hardware components in your computer and access warranty information. The Express Service Code is a numeric version of the Service Tag.

For more information about how to find the Service Tag of your computer, search in the Knowledge Base Resource at the [Dell Support Site](#).



**Figure 7. Service Tag/Express Service Code location**

# Battery-charge status light

The following table lists the battery-charge status light of your Dell Pro Rugged 13 RA13250.

**Table 1. Battery charge and status light behavior**

| Power source | LED behavior             | System power state | Battery charge level |
|--------------|--------------------------|--------------------|----------------------|
| AC adapter   | Off                      | S0 or S5           | Fully charged        |
| AC adapter   | Solid green              | S0 or S5           | < Fully charged      |
| Battery      | Off                      | S0 or S5           | 11-100%              |
| Battery      | Solid amber (590+/-3 nm) | S0 or S5           | < 10%                |

- S0 (ON): Computer is turned on.
- S4 (Hibernate): The computer consumes the least power in the Hibernate state than in the ON or OFF state. The computer is almost in the OFF state. The context data is written to a storage device, allowing you to resume from where you left when the computer is turned on.
- S5 (OFF): The computer is in a shutdown state.

# Set up your Dell Pro Rugged 13 RA13250

## About this task

**NOTE:** The images in this document may differ from your computer depending on the configuration you ordered.

## Steps

1. Connect the power adapter and press the power button.



**Figure 8. Setting up Dell Pro Rugged 13 RA13250 Laptop**

**NOTE:** The battery may go into power-saving mode during shipment to conserve charge on the battery. Ensure that the power adapter is connected to your computer when it is turned on for the first time.

2. Finish the operating system setup.

### For Windows:

Follow the on-screen instructions to complete the setup. When setting up, Dell Technologies recommends that you:





- Connect to a network for Windows updates.

**NOTE:** If connecting to a secured wireless network, enter the password for the wireless network access when prompted.

- If connected to the Internet, sign-in with an existing Microsoft account or create an account. If not connected to the Internet, create an offline account.
- On the **Support and Protection** screen, enter your contact details.

3. Locate and use Dell apps from the Windows Start menu—Recommended.

**Table 2. Locate Dell apps**

| Resources   | Description  |
|---|--|
|    | <p><b>Dell Product Registration</b><br/>Register your computer with Dell.</p>  |
|    | <p><b>Dell Help &amp; Support</b><br/>Access help and support for your computer.</p>   |
|    | <p><b>SupportAssist</b><br/>SupportAssist is the smart technology that keeps your computer running at its best by optimizing settings, detecting issues, removing viruses and notifies when you must make computer updates. SupportAssist proactively checks the health of your computer hardware and software. When an issue is detected, the necessary computer state information is sent to Dell to begin troubleshooting. SupportAssist is preinstalled on most of the Dell devices running the Windows operating system. For more information, see <i>SupportAssist for Business PCs manual</i> at <a href="#">Dell Support Site</a>.</p> <p><b>NOTE:</b> In SupportAssist, click the warranty expiry date to renew or upgrade your warranty.</p> |
|    | <p><b>Dell Update</b><br/>Updates your computer with critical fixes and latest device drivers as they become available. For more information about using Dell Update, see the product guides and third-party license documents at <a href="#">Dell Support Site</a>.</p>   |
|  | <p><b>Dell Digital Delivery</b><br/>Download software applications, which are purchased but not preinstalled on your computer. For more information about using Dell Digital Delivery, search in the Knowledge Base Resource at <a href="#">Dell Support Site</a>.</p>   |

# Specifications of Dell Pro Rugged 13 RA13250

## Dimensions and weight

The following table lists the height, width, depth, and weight of your Dell Pro Rugged 13 RA13250.

**Table 3. Dimensions and weight**

| Description  | Values                      |
|--|-----------------------------|
| Height:  |                             |
| Front height   | 36.50 mm (1.43 in.)         |
| Rear height  | 36.50 mm (1.43 in.)         |
| Width  | 324.00 mm (12.75 in.)       |
| Depth  | 220.00 mm (8.66 in.)        |
| Weight<br> <b>NOTE:</b> The weight of your computer depends on the configuration that is offered. | Minimum - 2.40 kg (5.29 lb) |

## Processor

The following table lists the details of the processors that are supported in your Dell Pro Rugged 13 RA13250.

**Table 4. Processor**

| Description            | Option one              | Option two              | Option three            |
|------------------------|-------------------------|-------------------------|-------------------------|
| Processor type         | Intel Core Ultra 5 135U | Intel Core Ultra 7 165U | Intel Core Ultra 7 165H |
| Processor wattage      | 15W                     | 15W                     | 28W                     |
| Processor core count   | 12                      | 12                      | 16                      |
| Processor thread count | 14                      | 14                      | 22                      |
| Processor speed        | Up to 4.40 GHz          | Up to 4.90 GHz          | Up to 5 GHz             |
| Processor cache        | 12 MB                   | 12 MB                   | 24 MB                   |
| Integrated graphics    | Intel Graphics          | Intel Graphics          | Intel Arc graphics      |

# Chipset

The following table lists the details of the chipset that is supported in your Dell Pro Rugged 13 RA13250.

**Table 5. Chipset**

| Description    | Values                      |
|----------------|-----------------------------|
| Chipset        | Integrated in the processor |
| Processor      | Intel Core Ultra 5/7        |
| DRAM bus width | 64-bit                      |
| Flash EPROM    | 64 MB                       |
| PCIe bus       | Up to Gen4                  |

# Operating system

Your Dell Pro Rugged 13 RA13250 supports the following operating systems:

- Windows 11 Home
- Windows 11 Pro

# Memory

The following table lists the memory specifications of your Dell Pro Rugged 13 RA13250.

**Table 6. Memory specifications**

| Description                     | Values  |
|---------------------------------|---|
| Memory slots                    | Onboard<br> <b>NOTE:</b> The memory is integrated on the system board and is not upgradeable   |
| Memory type                     | Dual-channel LPDDR5x  |
| Memory speed                    | 6400 MT/s   |
| Maximum memory configuration    | 64 GB   |
| Minimum memory configuration    | 16 GB   |
| Memory configurations supported | <ul style="list-style-type: none"><li>• 16 GB, 2 x 8 GB, LPDDR5x, 6400 MT/s, dual-channel</li><li>• 32 GB, 2 x 16 GB, LPDDR5x, 6400 MT/s, dual-channel</li><li>• 64 GB, 2 x 32 GB, LPDDR5x, 6400 MT/s, dual-channel</li></ul> |

## External ports and slots

The following table lists the external ports of your Dell Pro Rugged 13 RA13250.

**Table 7. External ports and slots**

| Description         | Values  |
|---------------------|---|
| Network port        | One RJ45 Ethernet port 1 Gbps   |
| USB ports           | <ul style="list-style-type: none"> <li>One USB 3.2 Gen 1 (5 Gbps) port</li> <li>One USB 3.2 Gen 1 (5 Gbps) port with PowerShare</li> <li>One Thunderbolt 4 (40 Gbps)/USB 3.2 Gen 2 Type-C port with PowerDelivery</li> <li>One Thunderbolt 4 (40 Gbps)/USB 3.2 Gen 2 Type-C port with PowerDelivery (optional)</li> <li>One optional I/O bay (Choose from: RJ45 (1 Gbps) Ethernet port/USB 3.2 Type-A port/Serial port/Fischer USB port)</li> </ul> |
| Audio port          | One headset (headphone and microphone combo) port   |
| Video port(s)       | One HDMI 2.1 TMDS port  |
| Serial port         | One Serial RS-232 port  |
| SIM slot            | One nanoSIM-card slot   |
| Media-card reader   | <ul style="list-style-type: none"> <li>One microSD-card slot</li> <li>One Smart-card reader slot/Express-card reader slot/ Smart-card reader + Express-card reader slot</li> </ul>  |
| Power-adapter port  | 65W/100W adapter, USB Type-C  |
| Security-cable slot | One wedge-shaped lock slot  |

## Internal slots

The following table lists the internal slots of your Dell Pro Rugged 13 RA13250.

**Table 8. Internal slots**

| Description | Values  |
|-------------|---|
| M.2         | <ul style="list-style-type: none"> <li>One M.2 2230/2280 slot for solid-state drive</li> <li>One M.2 2230 slot for Wi-Fi and Bluetooth combo card</li> <li>One M.2 3042 slot for WWAN card</li> </ul> <p><b>NOTE:</b> To learn more about the features of different types of M.2 cards, search in the Knowledge Base Resource at <a href="#">Dell Support Site</a>.</p> |

# Ethernet

The following table lists the wired Ethernet Local Area Network (LAN) specifications of your Dell Pro Rugged 13 RA13250.

**Table 9. Ethernet specifications**

| Description   | Values           |
|---------------|------------------|
| Model         | Intel i219LM     |
| Transfer rate | 10/100/1000 Mbps |

# Wireless module

The following table lists the Wireless Local Area Network (WLAN) modules that are supported on your Dell Pro Rugged 13 RA13250.

**Table 10. Wireless module specifications**

| Description               | Option one  | Option two   |
|---------------------------|---|--|
| Model number              | Intel AX211   | Intel BE200  |
| Transfer rate             | Up to 2400 Mbps   | Up to 5760 Mbps  |
| Frequency bands supported | 2.4 GHz/5 GHz/6 GHz   | 2.4 GHz/5 GHz/6 GHz  |
| Wireless standards        | <ul style="list-style-type: none"> <li>• Wi-Fi 802.11 a/b/g</li> <li>• Wi-Fi 4 (WiFi 802.11n)</li> <li>• Wi-Fi 5 (WiFi 802.11ac)</li> <li>• Wi-Fi 6E (WiFi 802.11ax)</li> </ul> | <ul style="list-style-type: none"> <li>• WiFi 802.11a/b/g</li> <li>• Wi-Fi 4 (WiFi 802.11n)</li> <li>• Wi-Fi 5 (WiFi 802.11ac)</li> <li>• Wi-Fi 6E (WiFi 802.11ax)</li> <li>• Wi-Fi 7 (WiFi 802.11be)</li> </ul> |
| Encryption                | <ul style="list-style-type: none"> <li>• 64-bit/128-bit WEP</li> <li>• AES-CCMP</li> <li>• TKIP</li> </ul>  | <ul style="list-style-type: none"> <li>• 64-bit/128-bit WEP</li> <li>• AES-CCMP</li> <li>• TKIP</li> </ul>   |
| Bluetooth wireless card   | Bluetooth 5.3   | Bluetooth 5.4  |
|                           | <p><b>NOTE:</b> The functionality of the Bluetooth wireless card may vary depending on the operating system that is installed on your computer.</p>                             |  |

# WWAN module

The following table lists the Wireless Wide Area Network (WWAN) module supported on your Dell Pro Rugged 13 RA13250.

**Table 11. WWAN module specifications**

| Description   | Option one  | Option two   |
|---------------|---|--|
| Model number  | Qualcomm Snapdragon X62 Global 5G (DW5932e)   | Qualcomm Snapdragon SDX12 Global LTE-Advanced (DW5826e)  |
| Transfer rate | <ul style="list-style-type: none"> <li>• 5G NR: DL 3.5 Gbps/UL 900 Mbps</li> <li>• LTE: DL 1.6 Gbps (CAT19)/UL 211 Mbps (CAT18)</li> <li>• UMTS: DL DC-HSPA+ Rel8:42 Mbps/UL 5.76 Mbps</li> </ul> | <ul style="list-style-type: none"> <li>• Up to 600 Mbps DL (CAT12)</li> <li>• Up to 150 Mbps UL</li> </ul> |

**Table 11. WWAN module specifications (continued)**

| Description  | Option one  | Option two  |
|--|---|---|
| Frequency bands supported  | <ul style="list-style-type: none"> <li>NR (n1, n2, n3, n5, n7, n8, n12, n13, n14, 18, n20, n25, n26, n28, n30, n38, n40, n41, n48, n53, n66, n70, n71, n75, n76, n77, n78, n79)</li> <li>LTE (B1, B2, B3, B4, B5, B7, B8, B12, B13, B14, B17, B18, B19, B20, B25, B26, B28, B29, B30, B32, B34, B38, B39, B40, B41, B42, B43, B46, B48, B66, B71)</li> <li>WCDMA/HSPA+ (1, 2, 4, 5, 8)</li> </ul> | <ul style="list-style-type: none"> <li>LTE(B1, B2, B3, B4, B5, B7, B8, B12, B13, B14, B18, B19, B20, B25, B26, B28, B29, B32, B38, B39, B40, B41, B42, B43, B48, B66, B71)</li> <li>HSPA+ (1,2,4,5,6,8,9,19)</li> </ul> |
| Wireless standards   | <ul style="list-style-type: none"> <li>NR FR1 (Sub6) FDD/TDD</li> <li>LTE FDD/TDD</li> <li>WCDMA/HSPA+</li> <li>GPS/GLONASS/Beidou/Galileo</li> </ul>   | <ul style="list-style-type: none"> <li>LTE FDD/TDD</li> <li>WCDMA/HSPA+</li> <li>GPS/GLONASS/Beidou/Galileo/QZSS</li> </ul>   |
| Encryption   | Supported   | Not supported   |
| Global Navigation Satellite System (GNSS)  | Supports GPS, and GLONASS Location sensor   | Supports GPS, and GLONASS Location sensor   |
| <p><b>NOTE:</b> For instructions on how to find your computer's International Mobile Station Equipment Identity (IMEI) number, search in the Knowledge Base Resource at <a href="#">Dell Support Site</a>.</p> |   |   |

## Optional GPS module

The following table lists the u-blox NEO-M9N module that is supported on your Dell Pro Rugged 14.

**Table 12. u-blox NEO-M9N module specifications**

| u-blox NEO-M9N module            |  |
|----------------------------------|--|
| Interface                        | USB (default) and UART   |
| <b>Performance</b>               |  |
| Receiver type                    | 92-channel u-blox M9 engine<br>GPS L1 C/A, QZSS L1 C/A/S, GLONASS L10F, BeiDou B1I, Galileo E1 B/C<br>SBAS L1 C/A: WAAS, EGNOS, MSAS, GAGAN  |
| Navigation update rate (maximum) | 25 Hz (four concurrent GNSS modes)   |
| Position accuracy                | 2.0 m CEP (four concurrent GNSS modes)   |
| Supported protocol               | <ul style="list-style-type: none"> <li>UBX</li> <li>NMEA 4.10 (default), 4.0, 2.3, and 2.1</li> <li>RTCM 3.3</li> </ul>  |
| Security features                | <ul style="list-style-type: none"> <li>Anti-jamming</li> <li>Anti-spoofing</li> <li>Configuration lockdown</li> <li>Message integrity</li> <li>Secure boot</li> <li>JTAG debug port (locked by default)</li> </ul> |
| <b>Absolute maximum ratings</b>  |  |
| Power supply voltage             | -0.5 V (minimum)   |

**Table 12. u-blox NEO-M9N module specifications (continued)**

| <b>u-blox NEO-M9N module</b> |                                    |
|------------------------------|------------------------------------|
|                              | 3.6 V (maximum)                    |
| Storage temperature          | -40°C to 85°C (-40°F to 185°F)     |
| <b>Operating conditions</b>  |                                    |
| Power supply voltage         | 2.7 V (minimum)<br>3.6 V (maximum) |
| Operating temperature        | -40°C to 85°C (-40°F to 185°F)     |

## Audio

The following table lists the audio specifications of your Dell Pro Rugged 13 RA13250.

**Table 13. Audio specifications**

| <b>Description</b>         |         | <b>Values</b>                                     |
|----------------------------|---------|---|
| Audio controller           |         | Realtek ALC3254                                   |
| Stereo conversion          |         | Supported   |
| Internal audio interface   |         | High definition audio                             |
| External audio interface   |         | One headset (headphone and microphone combo) port |
| Number of speakers         |         | Two   |
| Internal-speaker amplifier |         | Supported   |
| External volume controls   |         | Keyboard shortcut controls                        |
| Speaker output:            |         |   |
|                            | Average | 2 W x 2 = 4 W                                     |
|                            | Peak    | 2.5 W x 2 = 5 W                                   |
| Microphone                 |         | Dual-array  |

## Storage

This section lists the storage options on your Dell Pro Rugged 13 RA13250.

Your Dell Pro Rugged 13 RA13250 supports one of the following storage configurations:

- One M.2 2230/2280 solid-state drive

**Table 14. Storage specifications**

| <b>Storage type</b>        | <b>Interface type</b>                         | <b>Capacity</b>    |
|----------------------------|---|--------------------|
| M.2 2230 solid state drive | Gen4 PCIe x4, Class 35                        | 256 GB/512 GB/1 TB |
| M.2 2230 solid state drive | Gen4 PCIe x4, Class 35, Self-Encrypting Drive | 256 GB             |

**Table 14. Storage specifications (continued)**

| Storage type               | Interface type                                | Capacity    |
|----------------------------|---|-------------|
| M.2 2280 solid state drive | Gen4 PCIe x4, Class 40, Self-Encrypting Drive | 512 GB/1 TB |
| M.2 2280 solid state drive | Gen4 PCIe x4, Class 40, Self-Encrypting Drive | 2 TB        |

## Media-card reader

The following table provides the specification of media cards supported by your Dell Pro Rugged 13 RA13250.

**Table 15. Media-card reader specifications**

| Description  | Values   |
|--|--|
| Media-card slot type   | One micro-SD card  |
| Media-cards supported  | <ul style="list-style-type: none"> <li>• Micro Secure Digital (mSD)</li> <li>• Micro Secure Digital High Capacity (mSDHC)</li> <li>• Micro Secure Digital Extended Capacity (mSDXC)</li> </ul> |
| <p><b>NOTE:</b> The maximum capacity that is supported by the media-card reader varies depending on the standard of the media card that is installed on your computer.</p> |  |



## Keyboard

The following table lists the keyboard specifications of your Dell Pro Rugged 13 RA13250.

**Table 16. Keyboard specifications**

| Description        | Values   |
|--------------------|--|
| Keyboard type      | <ul style="list-style-type: none"> <li>• Standard, non-backlit keyboard with Copilot key</li> <li>• Standard, RGB backlit keyboard with Copilot key</li> <li>• Rubberized Sealed RGB backlit keyboard with Copilot key</li> </ul>  |
| Keyboard layout    | <ul style="list-style-type: none"> <li>• QWERTY</li> <li>• AZERTY</li> <li>• Kanji</li> </ul>  |
| Number of keys     | <ul style="list-style-type: none"> <li>• United States and Canada: 82 keys</li> <li>• United Kingdom: 83 keys</li> <li>• Brazil: 84 keys</li> <li>• Japan: 86 keys</li> </ul>  |
| Keyboard size      | <p>X = 19.05 mm key pitch</p> <p>Y = 19.05 mm key pitch</p>  |
| Keyboard shortcuts | <p>Some keys on your keyboard have two symbols on them. These keys can be used to type alternate characters or to perform secondary functions. To type the alternate character, press Shift and the desired key. To perform secondary functions, press Fn and the desired key.</p> |

**Table 16. Keyboard specifications (continued)**

| Description | Values   |
|-------------|--|
|             | <p> <b>NOTE:</b> You can define the primary behavior of the function keys (F1–F12) changing <b>Function Key Behavior</b> in the BIOS setup program.</p> <p> <b>NOTE:</b> If Copilot in Windows is not available on your computer, pressing the Copilot key launches Windows search. For more information about Copilot in Windows, search in the Knowledge Base Resource at the <a href="#">Dell Support site</a>.</p> |

## Keyboard shortcuts of Dell Pro Rugged 13 RA13250

 **NOTE:** Keyboard characters may differ depending on the keyboard language configuration. Keys that are used for shortcuts remain the same across all language configurations.

Some keys on your keyboard have two symbols on them. These keys can be used to type alternate characters or to perform secondary functions. The symbol that is shown on the lower part of the key refers to the character that is typed out when the key is pressed. If you press shift and the key, the symbol that is shown on the upper part of the key is typed out. For example, if you press **2**, 2 is typed out; if you press **Shift + 2**, @ is typed out.

The keys F1-F12 at the top row of the keyboard are function keys for multimedia control, as indicated by the icon on the key. Press the function key to invoke the task represented by the icon. For example, pressing F1 mutes the audio (see the table below).

However, if the function keys F1-F12 are needed for specific software applications, multimedia functionality can be disabled by pressing **Fn + Esc**. Later, multimedia control can be invoked by pressing **Fn** and the respective function key. For example, mute audio by pressing **Fn + F1**.

 **NOTE:** You can also define the primary behavior of the function keys (F1–F12) by changing **Function Key Behavior** in BIOS setup program.

**Table 17. Function key primary behavior**

| Function key | Primary behavior           |
|--------------|----------------------------|
| F1           | Mute or unmute audio       |
| F2           | Decrease volume            |
| F3           | Increase volume            |
| F4           | Microphone Mute            |
| F5           | KB Illumination/Backlight  |
| F6           | Decrease brightness        |
| F7           | Increase brightness        |
| F8           | Switch to external display |
| F9           | Stealth mode               |
| F10          | Print screen               |
| F11          | Full-screen mode           |
| F12          | Home                       |

The **Fn** key is also used with selected keys on the keyboard to invoke other secondary functions.

**Table 18. Secondary behavior**

| Function key | Secondary behavior  |
|--------------|---|
| Fn + F1      | Operating system and application-specific F1 behavior   |
| Fn + F2      | Operating system and application-specific F2 behavior   |
| Fn + F3      | Operating system and application-specific F3 behavior   |
| Fn + F4      | Operating system and application-specific F4 behavior   |
| Fn + F5      | Operating system and application-specific F5 behavior   |
| Fn + F6      | Operating system and application-specific F6 behavior   |
| Fn + F7      | Operating system and application-specific F7 behavior   |
| Fn + F8      | Operating system and application-specific F8 behavior   |
| Fn + F9      | Operating system and application-specific F9 behavior   |
| Fn + F10     | Operating system and application-specific F10 behavior  |
| Fn + F11     | Operating system and application-specific F11 behavior  |
| Fn + F12     | Operating system and application-specific F12 behavior  |
| Fn + Ctrl    | Open the application menu   |
| Fn + Esc     | Toggle between multimedia and function key behavior   |
| Copilot      | <p>Launch Copilot in Windows</p> <p><b>NOTE:</b> If Copilot in Windows is not available on your computer, the Copilot key launches Recall. If both Recall and Copilot in Windows are not available on your computer, the Copilot key launches Windows Search. For more information about Copilot in Windows and Recall, search in the Knowledge Base Resource at the <a href="#">Dell Support Site</a>.</p> |

## Camera

The following table lists the camera specifications of your Dell Pro Rugged 13 RA13250.

**Table 19. Camera specifications**

| Description                 | Values  |
|-----------------------------|---|
| Number of cameras           | Two   |
| Camera type                 | <ul style="list-style-type: none"> <li>FHD-IR</li> </ul>                      |
| Camera location             | Front camera  |
| Camera sensor type          | CMOS sensor technology  |
| Camera resolution:          |   |
| Still image                 | <ul style="list-style-type: none"> <li>2.0 megapixel (FHD)</li> </ul>         |
| Video                       | <ul style="list-style-type: none"> <li>1920 x 1080 (FHD) at 30 fps</li> </ul> |
| Infrared camera resolution: |   |
| Still image                 | <ul style="list-style-type: none"> <li>0.23</li> </ul>                        |

**Table 19. Camera specifications (continued)**

| Description             |                 | Values  |
|-------------------------|-----------------|---|
|                         | Video           | <ul style="list-style-type: none"> <li>640 x 360</li> </ul>           |
| Diagonal viewing angle: |                 |   |
|                         | Camera          | <ul style="list-style-type: none"> <li>87 degrees (HD)</li> </ul>     |
|                         | Infrared camera | <ul style="list-style-type: none"> <li>87.60 degrees (FHD)</li> </ul> |

## Touchpad

The following table lists the touchpad specifications of your Dell Pro Rugged 13 RA13250.

**Table 20. Touchpad specifications**

| Description          |            | Values  |
|----------------------|------------|---|
| Touchpad resolution: |            |   |
|                      | Horizontal | >= 300 dpi  |
|                      | Vertical   | >= 300 dpi  |
| Touchpad dimensions: |            |   |
|                      | Horizontal | 99.70 mm (3.92 in.)   |
|                      | Vertical   | 50.00 mm (1.96 in.)   |
| Touchpad gestures    |            | For more information about the touchpad gestures available on Windows, see the Microsoft Knowledge Base article at <a href="#">Microsoft Support Site</a> . |

## Battery

The following table lists the battery specifications of your Dell Pro Rugged 13 RA13250.

**Table 21. Battery specifications**

| Description              | Option one  | Option two                                      |
|--------------------------|---|---|
| Battery type             | 3-cell, 53.5 Wh, ExpressCharge, ExpressCharge Boost | 3-cell, 53.5 Wh, Long Cycle Life, ExpressCharge |
| Battery voltage          | 11.4 VDC  | 11.4 VDC  |
| Battery weight (maximum) | 0.265 kg (0.584 lb)                                 | 0.265 kg (0.584 lb)                             |
| Battery dimensions:      |   |   |
|                          | Height  | 15.30 mm (0.60 in.)                             |
|                          | Width   | 86.29 mm (3.39 in.)                             |
|                          | Depth   | 128.44 mm (5.05 in.)                            |
| Temperature range:       |   |   |

**Table 21. Battery specifications (continued)**

| Description   |           | Option one  | Option two  |
|---|-----------|---|---|
|   | Operating | <ul style="list-style-type: none"> <li>Charge: 0°C to 50°C (32°F to 122°F)</li> <li>Discharge: -20°C to 70°C (-4°F to 158°F)</li> </ul> | <ul style="list-style-type: none"> <li>Charge: 0°C to 50°C (32°F to 122°F)</li> <li>Discharge: -20°C to 70°C (-4°F to 158°F)</li> </ul> |
|   | Storage   | -20°C to 60°C (-4°F to 140°F)   | -20°C to 60°C (-4°F to 140°F)   |
| Battery operating time  |           | Varies depending on operating conditions and can significantly reduce under certain power-intensive conditions.                         | Varies depending on operating conditions and can significantly reduce under certain power-intensive conditions.                         |
| Express charging time (approximate)<br><i>i</i> <b>NOTE:</b> You can control the charging time, duration, start and end time, and so on, using the settings on the MyDell application (Power option). For more information about MyDell application, search in the Knowledge Base Resource at <a href="#">Dell Support Site</a> . |           | Two hours   | Two hours   |
| Coin-cell battery   |           | CR2032  | CR2032  |
| <p><b>CAUTION:</b> Operating and storage temperature ranges may differ among components, so operating or storing the device outside these ranges may impact the performance of specific components.</p> <p><b>CAUTION:</b> Dell Technologies recommends that you charge the battery regularly for optimal power consumption.</p>  |           |   |   |

## Power requirements

*i* **NOTE:** The information in this section is applicable to the European Union (EU) countries.

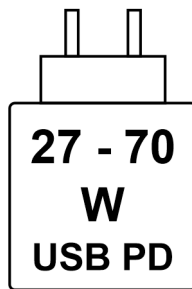

**Figure 9. Pictogram for power charging requirements**

The power that is delivered by the charger must be between a minimum of 27 Watts that is required by the radio equipment, and a maximum of 70 Watts in order to achieve the maximum charging speed.

This computer supports USB Power Delivery (PD) fast charging.

# Power adapter

The following table lists the power adapter specifications of your Dell Pro Rugged 13 RA13250.

**Table 22. Power-adapter specifications**

| Description  | Option one  | Option two   |
|--|---|--|
| Type   | 65W AC adapter, USB Type-C  | 100W AC adapter, USB Type-C  |
| Power-adapter dimensions:  |   |  |
| Height   | 28 mm (1.10 in.)  | 22 mm (0.87 in.)   |
| Width  | 51 mm (2.01 in.)  | 66 mm (2.60 in.)   |
| Depth  | 112 mm (4.41 in.)   | 130 mm (5.12 in.)  |
| Input voltage  | 100 VAC - 240 VAC   | 100 VAC - 240 VAC  |
| Input frequency  | 50 Hz - 60 Hz   | 50 Hz - 60 Hz  |
| Input current (maximum)  | 1.50 A  | 1.8 A  |
| Output current (continuous)  | <ul style="list-style-type: none"> <li>● 20 V/3.25 A</li> <li>● 15 V/3 A</li> <li>● 9 V/3 A</li> <li>● 5 V/3 A</li> </ul> | <ul style="list-style-type: none"> <li>● 20 V/5 A</li> <li>● 15 V/3 A</li> <li>● 9 V/3 A</li> <li>● 5 V/3 A</li> </ul> |
| Rated output voltage   | <ul style="list-style-type: none"> <li>● 20 VDC</li> <li>● 15 VDC</li> <li>● 9 VDC</li> <li>● 5 VDC</li> </ul>            | <ul style="list-style-type: none"> <li>● 20 VDC</li> <li>● 15 VDC</li> <li>● 9 VDC</li> <li>● 5 VDC</li> </ul>         |
| Temperature range:   |   |  |
| Operating  | 0°C to 40°C (32°F to 104°F)   | 0°C to 40°C (32°F to 104°F)  |
| Storage  | -40°C to 70°C (-40°F to 158°F)  | -40°C to 70°C (-40°F to 158°F)   |
|  <b>CAUTION: Operating and storage temperature ranges may differ among components, so operating or storing the device outside these ranges may impact the performance of specific components.</b> |   |  |

## Power adapter requirements (for computers shipped with Intel Core Ultra 5/7—U series processors)





 **NOTE:** The information in this section is applicable only to computers shipped with Intel Core Ultra 5/7—U series processors.

If you did not purchase the Dell-branded power adapter that is recommended for your computer, ensure that the power adapter you use meets the following requirements:

**Table 23. Power adapter requirements**

| Description   | Value          |
|---|----------------|
| Power that is required from a power adapter to achieve optimal performance. | 65 W           |
| Power that charges the computer at a slower speed.                          | Less than 60 W |

**Table 23. Power adapter requirements (continued)**





| Description  | Value  |
|--|--|
| <p> <b>NOTE:</b> A warning message may appear informing you about the use of a lower-powered adapter and slower charging speed.</p>   |  |
| <p>Minimum power that is required from a power adapter to operate the computer and charge the battery.</p> <p> <b>NOTE:</b> A warning message appears informing you about the use of a lower-powered adapter and slower charging speed.</p> | 27 W   |
| <p>USB Power Delivery (PD) fast charging</p>   | <p>Supported</p> <p> <b>NOTE:</b> Ensure that the computer is connected to a 65 W power adapter for this feature to be supported.</p>   |
| <p>ExpressCharge mode</p>  | <p>Supported</p> <p> <b>NOTE:</b> ExpressCharge mode must also be enabled in the BIOS Setup screen by selecting <b>Power &gt; Battery Configuration &gt; ExpressCharge</b>, then pressing Enter.</p> <p> <b>NOTE:</b> Ensure that the computer is connected to a 65 W power adapter to achieve ExpressCharge .</p> |

## Power adapter requirements (for computers shipped with Intel Core Ultra 7—H series processors)

 **NOTE:** The information in this section is applicable only to computers shipped with Intel Core Ultra 7—H series processors.

If you did not purchase the Dell-branded power adapter that is recommended for your computer, ensure that the power adapter you use meets the following requirements:

**Table 24. Power adapter requirements**

| Description  | Value   |
|--|---|
| <p>Power that is required from a power adapter to achieve optimal performance.</p>   | 100 W   |
| <p>Power that charges the computer at a slower speed.</p> <p> <b>NOTE:</b> A warning message may appear informing you about the use of a lower-powered adapter and slower charging speed.</p>   | Less than 75 W  |
| <p>Minimum power that is required from a power adapter to operate the computer and charge the battery.</p> <p> <b>NOTE:</b> A warning message appears informing you about the use of a lower-powered adapter and slower charging speed.</p> | 27 W  |
| <p>USB Power Delivery (PD) fast charging</p>   | <p>Supported</p> <p> <b>NOTE:</b> Ensure that the computer is connected to a 100 W power adapter for this feature to be supported.</p>   |
| <p>ExpressCharge mode</p>  | <p>Supported</p> <p> <b>NOTE:</b> ExpressCharge mode must also be enabled in the BIOS Setup screen by selecting <b>Power &gt; Battery Configuration &gt; ExpressCharge</b>, then pressing Enter.</p> |

**Table 24. Power adapter requirements (continued)**

| Description | Value  |
|-------------|--|
|             |  <b>NOTE:</b> Ensure that the computer is connected to a 100 W power adapter to achieve ExpressCharge . |

## Display

The following table lists the display specifications of your Dell Pro Rugged 13 RA13250.

**Table 25. Display specifications**

| Description                             | Values   |                       |
|---|--|-----------------------|
| Display type                            | 13.3-inch, Full High Definition (FHD)  |                       |
| Touch options                           | Yes  |                       |
| Display-panel technology                | Wide View Angle (WVA), Color Active Matrix TFT LCD, LED backlight  |                       |
| Display-panel dimensions (active area): |  |                       |
|   | Height   | 165.24 mm (6.5 in.)   |
|   | Width  | 293.76 mm (11.56 in.) |
|   | Diagonal   | 337.04 mm (13.26 in.) |
| Display-panel native resolution         | 1920 x 1080  |                       |
| Luminance (typical)                     | 1400 nit   |                       |
| Megapixels                              | 16.7   |                       |
| Color gamut                             | sRGB 100% typical  |                       |
| Pixels Per Inch (PPI)                   | 166  |                       |
| Contrast ratio (minimum)                | 1500:1   |                       |
| Response time (maximum)                 | 35 ms  |                       |
| Refresh rate                            | 60 Hz  |                       |
| Horizontal view angle                   | <ul style="list-style-type: none"> <li>• Minimum: 80 +/- degrees</li> <li>• Typical: 89 degrees</li> </ul> |                       |
| Vertical view angle                     | <ul style="list-style-type: none"> <li>• Minimum: 80 +/- degrees</li> <li>• Typical: 89 degrees</li> </ul> |                       |
| Pixel pitch                             | 0.153 x 0.153 mm   |                       |
| Power consumption (maximum)             | 7.5 W  |                       |
| Anti-glare vs glossy finish             | Anti-glare   |                       |

## Fingerprint reader (optional)

The following table lists the specifications of the optional fingerprint-reader of your Dell Pro Rugged 13 RA13250.

**Table 26. Fingerprint reader specifications**

| Description       | Values     |
|-------------------|------------|
| Sensor technology | Capacitive |
| Sensor resolution | 363 dpi    |
| Sensor pixel size | 0.07 mm    |

## Sensor

The following table lists the sensor of your Dell Pro Rugged 13 RA13250.

**Table 27. Sensor**

| Sensor support     |
|--------------------|
| Hall Effect sensor |

## GPU—Integrated

The following table lists the specifications of the integrated Graphics Processing Unit (GPU) supported by your Dell Pro Rugged 13 RA13250.

**Table 28. GPU—Integrated (for computers shipped with Intel Core Ultra 5 135U and Intel Core Ultra 7 165U processors)**

| Controller     | Memory size          | Processor                                       |
|----------------|----------------------|---|
| Intel Graphics | Shared system memory | Intel Core Ultra 5 135U/Intel Core Ultra 7 165U |

**Table 29. GPU—Integrated (for computers shipped with Intel Core Ultra 7 165H processor)**

| Controller         | Memory size          | Processor               |
|--------------------|----------------------|-------------------------|
| Intel Arc graphics | Shared system memory | Intel Core Ultra 7 165H |

## Multiple display support matrix

The following table lists the multiple display support matrix for your Dell Pro Rugged 13 RA13250.

**Table 30. Multiple display support matrix (for computers shipped with Intel Core Ultra 5 135U and Intel Core Ultra 7 165U processors)**

| Graphics Card  | Direct Graphics Controller Direct Output Mode | Supported external displays with computer internal display on |
|----------------|---|---|
| Intel Graphics | Integrated                                    | 3   |

**Table 31. Multiple display support matrix (for computers shipped with Intel Core Ultra 7 165H processor)**

| Graphics Card      | Direct Graphics Controller Direct Output Mode | Supported external displays with computer internal display on |
|--------------------|---|---|
| Intel Arc graphics | Integrated                                    | 4   |

## Hardware security

The following table lists the hardware security of your Dell Pro Rugged 13 RA13250.

**Table 32. Hardware security**

| Hardware security   |
|---|
| Wedge-shaped lock slot  |
| Mechanical camera privacy shutter   |
| Trusted Platform Module (TPM) 2.0 discrete  |
| FIPS (Federal Information Processing Standards) 140-2 certification for Trusted Platform Module (TPM) |
| Trusted Computing Group (TCG) Certification for TPM   |
| Self-Encrypting Drive (SED), Opal 2.0 only - PCIe Interface   |
| ControlVault 3 Advanced Authentication with FIPS 140-3 Level 3 Certification                          |
| Optional Fingerprint Reader with Control Vault 3 Plus (optional)                                      |
| Optional Contacted Smart-Card and Control Vault 3 Plus (optional)                                     |
| Optional Contactless Smart-Card, NFC, and Control Vault 3 Plus (optional)                             |
| Statement of Non-Volatility   |
| Chassis Intrusion Detection   |
| Dell Trusted Device Agent Validation  |
| Battery Removal Detection   |

## Smart-card reader

### Contactless smart-card reader

This section lists the contactless smart-card reader specifications of your Dell Pro Rugged 13 RA13250. This module is only available in computers shipped with Smart-card readers.

**Table 33. Contactless smart-card reader specifications**

| Title                                   | Description  | Dell ControlVault 3 Plus Contactless Smart-card reader with NFC |
|---|--|---|
| Felica Card Support                     | Reader and software capable of supporting Felica contactless cards                 | Yes   |
| Prox (Proximity) (125 kHz) Card support | Reader and software capable of supporting Prox/Proximity/125 kHz contactless cards | No  |
| ISO 14443 Type A Card Support           | Reader and software capable of supporting ISO 14443 Type A contactless cards       | Yes   |

**Table 33. Contactless smart-card reader specifications (continued)**

| <b>Title</b>                  | <b>Description</b>   | <b>Dell ControlVault 3 Plus Contactless Smart-card reader with NFC</b> |
|-------------------------------|--|--|
| ISO 14443 Type B Card Support | Reader and software capable of supporting ISO 14443 Type B contactless cards                                       | Yes  |
| ISO/IEC 21481                 | Reader and software capable of supporting ISO/IEC 21481 compliant contactless cards and tokens                     | Yes  |
| ISO/IEC 18092                 | Reader and software capable of supporting ISO/IEC 21481 compliant contactless cards and tokens                     | Yes  |
| ISO 15693 Card Support        | Reader and software capable of supporting ISO15693 contactless cards   | Yes  |
| NFC Tag Support               | Supports reading and processing of NFC compliant tag information   | Yes  |
| NFC Reader Mode               | Support for NFC Forum Defined Reader mode  | Yes  |
| NFC Writer Mode               | Support for NFC Forum Defined Writer mode  | Yes  |
| NFC Peer-to-Peer Mode         | Support for NFC Forum Defined Peer to Peer mode  | Yes  |
| NFC Proximity OS Interface    | Enumerates NFP (Near Field Proximity) device for OS to utilize   | Yes  |
| PC/SC OS interface            | Personal Computer/Smart-Card specification for integration of hardware readers into personal computer environments | Yes  |
| CCID driver compliance        | Common driver support for Integrated Circuit Card Interface Device for OS level drivers                            | Yes  |
| Dell ControlVault support     | Device connects to Dell ControlVault for usage and processing  | Yes  |

 **NOTE:** 125 Khz proximity cards are not supported.

**Table 34. Supported contactless card types**

| <b>Interface</b>                       | <b>Card Type</b> | <b>Supported Functionality</b>         |
|--|------------------|--|
| NFC Forum (Microsoft Proximity Device) | Type 1 tag       | Read/Write NDEF                        |
|  | Type 2 tag       | Read/Write NDEF                        |
|  | Type 3 tag       | Read/Write NDEF                        |
|  | Type 4 tag       | Read/Write NDEF                        |
|  | Type 5 tag       | Read/Write NDEF                        |
|  | P2P              | Exchange NDEF                          |
| RFID (Microsoft Smartcard Device)      | ISO14443A        | Read UUID and APDU Exchange (ISO7816 ) |
|  | ISO14443B        | Read UUID and APDU Exchange (ISO7816 ) |
|  | Sony FeliCa      | Read UUID only                         |

**Table 34. Supported contactless card types (continued)**

| Interface | Card Type                | Supported Functionality |
|-----------|--------------------------|-------------------------|
|           | Legacy iClass (ISO15693) | Read UUID only          |
|           | Mifare Classic           | Read UUID only          |
|           | Low Frequency (125 KHz ) | Not Supported           |

**Table 35. Qualified cards -1**

| Manufacturer             | Card                                 | Supported |
|--------------------------|--------------------------------------|-----------|
| HID                      | jCOP readertest3 A card (14443a)     | Yes       |
|                          | 1430 1L                              | Yes       |
|                          | DESFire D8H                          | Yes       |
|                          | DESFIRE 4K Standard - 1450NGGNN      | Yes       |
|                          | iClass 16K/16 - 2002PGGMN            | Yes       |
|                          | iClass SR 16K/16 - 2002HPGGMN        | Yes       |
|                          | iCLASS 2K tag                        | Yes       |
|                          | iCLASS GP - 2003 PGGMN               | Yes       |
|                          | iClass Clamshell - 2080PMSMV         | Yes       |
|                          | iClass Prox 16K/16 - 2022BGGMNN      | Yes       |
|                          | Mifare M1P 1430 NGGNN                | Yes       |
|                          | iclass Prox 2020BGGMNM               | Yes       |
|                          | DesFire D8P 1456CSGMN                | Yes       |
|                          | iCLASS MIFARE Px GM49Y 2623BNPGGBNAB | Yes       |
|                          | iCLASS MIFARE Px 8M1L                | Yes       |
|                          | iClass SEOS JW 5006PGGMN             | Yes       |
|                          | Crescendo iCLASS Px G8H              | Yes       |
|                          | iCLASS Seos IY                       | Yes       |
|                          | SEOS JMC4 J1Y 5806VNG1NNN4           | Yes       |
|                          | SEOS Key FOB 5266PNNA                | Yes       |
| SEOS Clamshell 5656PMSAV | Yes                                  |           |
| SEOS + Prox 5106RGGMNN   | Yes                                  |           |

**Table 36. Qualified cards -2**

| Manufacturer | Card                             | Supported |
|--------------|----------------------------------|-----------|
| HID          | SEOS + DESFire 5906PNG1ANN7      | Yes       |
|              | SEOS iClass 5006PGGMN7           | Yes       |
|              | Seos Essential + Prox 551PPGGANN | Yes       |
|              | iCLASS 2K 2000PGGMN              | Yes       |
|              | iCLASS 2K 3000PGGMN              | Yes       |
|              | MIFARE DESFire 3700CPGGAN        | Yes       |
|              | iCLASS DP                        | Yes       |

**Table 36. Qualified cards -2 (continued)**

| Manufacturer | Card                                  | Supported |
|--------------|---------------------------------------|-----------|
|              | DESFire 1Y                            | Yes       |
| NXP/Mifare   | Mifare DESFire 8K White PVC Cards     | Yes       |
|              | Mifare Classic 1K White PVC Cards     | Yes       |
|              | Mifare Mifare S50 ISO Cards           | Yes       |
|              | Mifare DESFire 2K                     | Yes       |
|              | Mifare Plus S 2K/4K                   | Yes       |
|              | Mifare Plus X 4K                      | Yes       |
| G&D          | idOnDemand - SCE3.2 144K              | Yes       |
|              | SCE6.0 FIPS 80K Dual+ 1 K Mifare      | Yes       |
|              | SCE6.0 nonFIPS 80K Dual+ 1 K Mifare   | Yes       |
|              | SCE6.0 FIPS 144K Dual + 1K Mifare     | Yes       |
|              | SCE6.0 nonFIPS 144K Dual + 1 K Mifare | Yes       |
|              | SCE7.0 FIPS 144K                      | Yes       |

**Table 37. Qualified cards -2**

| Manufacturer    | Card                                | Supported |
|-----------------|-------------------------------------|-----------|
| Oberthur        | idOnDemand - OCS5.2 80K             | Yes       |
|                 | ID-One Cosmo 64 RSA D V5.4 T=0 card | Yes       |
|                 | ID-One Cosmo 128K V5.5 card         | Yes       |
| Gemalto         | TOP DL GX4 144K card                | Yes       |
| Sony            | Felica RC-S962                      | Yes       |
|                 | Felica RC-S965                      | Yes       |
|                 | Felica RC-S966                      | Yes       |
| PIVKey          | C910 PKI                            | Yes       |
| NIST            | PIV1                                | Yes       |
| IDENTIV         | PIV programmed cards                | Yes       |
|                 | uTrust                              | Yes       |
| Transport cards | Oyster (London) MIFARE DESFire      | Yes       |
|                 | T-Money (Korea)                     | Yes       |
|                 | Octopus Card (Hong Kong)            | Yes       |
|                 | SUICA (Japan)                       | Yes       |

**Table 38. Qualified NFC tags**

| NFC tag  | Supported |
|--|-----------|
| Tap and do - NFC Forum Type 1 Tag - Topaz 512 (BCM920203)    | Yes       |
| Tap and do - NFC Forum Type 1 Tag - Topaz 512 (BCM20203T512) | Yes       |
| Tap and do - NFC Forum Type 1 Tag - Topaz (BCM20203T96)      | Yes       |

**Table 38. Qualified NFC tags (continued)**

| <b>NFC tag</b>  | <b>Supported</b> |
|---|------------------|
| Tap and do - NFC Forum Type 2 Tag - Mifare UltraLight         | Yes              |
| Tap and do - NFC Forum Type 2 Tag - Mifare UltraLight C       | Yes              |
| Tap and do - NFC Forum Type 2 Tag - NTAG203                   | Yes              |
| Tap and do - NFC Forum Type 3 Tag - FeliCa Lite RC-S965       | Yes              |
| Tap and do - NFC Forum Type 3 Tag - FeliCa RC-S962            | Yes              |
| Tap and do - NFC Forum Type 4 Tag - Mifare DESFire EV1Card 2K | Yes              |
| Tap and do - NFC Forum Type 4 Tag - Mifare DESFire EV1Card 4K | Yes              |
| Tap and do - NFC Forum Type 4 Tag - Mifare DESFire EV1Card 8K | Yes              |
| Tap and do - ISO 15693 - Tag-it Plus                          | Yes              |
| HID I-code ISO card   | Yes              |

## Contacted smart-card reader

The following table lists the contacted smart-card reader specifications of your Dell Pro Rugged 13 RA13250.

**Table 39. Contacted smart-card reader specifications**

| <b>Title</b>                     | <b>Description</b>   | <b>Dell ControlVault 3 Plus Smart-card reader</b> |
|----------------------------------|--|---|
| ISO 7816 -3 Class A Card Support | Reader capable of reading 5 V powered smart-card   | Yes   |
| ISO 7816 -3 Class B Card Support | Reader capable of reading 3 V powered smart-card   | Yes   |
| ISO 7816 -3 Class C Card support | Reader capable of reading 1.8 V powered smart-card   | Yes   |
| T=0 support                      | Cards support character level transmission   | Yes   |
| T=1 support                      | Cards support block level transmission   | Yes   |
| EMVCo Certified                  | Formally certified based on EMVCO smart-card standards   | Yes   |
| PC/SC OS interface               | Personal Computer/Smart-Card specification for integration of hardware readers into personal computer environments | Yes   |
| CCID driver compliance           | Common driver support for Integrated Circuit Card Interface Device for OS level drivers.                           | Yes   |
| Windows Certified                | Certified by the Windows Hardware Certification program  | Yes   |
| FIPS 201 (PIV/HSPD-12) Compliant | Device compliant with FIPS 201/PIV/HSPD-12 requirements  | Yes   |
| ISO 7816-1 Compliant             | Specification for the physical characteristics of integrated circuit cards with contacts                           | Yes   |

**Table 39. Contacted smart-card reader specifications (continued)**

| Title                     | Description   | Dell ControlVault 3 Plus Smart-card reader |
|---------------------------|---|--|
| ISO 7816 -2 Compliant     | Specification for the dimensions and location of the contacts         | Yes  |
| ISO 7816-3 Compliant      | Specification for electrical interface and transmission protocols     | Yes  |
| ISO 7816-4 Compliant      | Specification for organization, security and commands for interchange | Yes  |
| Dell ControlVault support | Device connects to Dell ControlVault for usage and processing         | Yes  |

## Operating and storage environment

This table lists the operating and storage specifications of your Dell Pro Rugged 13 RA13250.

**Airborne contaminant level:** G1 as defined by ISA-S71.04-1985

**Table 40. Computer environment**

| Description  | Operating  | Storage  |
|--|--|--|
| Temperature range  | -29°C to 63°C (-20.2°F to 145.4°F)   | -51°C to 71°C (-59.8°F to 159.8°F)   |
| Relative humidity (maximum)  | <ul style="list-style-type: none"> <li>10% to 95% (Maximum dew point temperature = 26°C)</li> <li>Maximum 90% (non-condensing)</li> </ul>                          | <ul style="list-style-type: none"> <li>Maximum 95% (non-condensing)</li> </ul> |
| Vibration (maximum)*   | Random at 5 Hz to 5000 Hz <ul style="list-style-type: none"> <li>Vertical - 1.08 GRMS</li> <li>Transverse - 0.21 GRMS</li> <li>Longitudinal - 0.76 GRMS</li> </ul> | 7.7 GRMS random at 5 Hz to 2000 Hz   |
| Shock (maximum)  | 160 G†   | 185 G†   |
| Altitude range   | 12192 m (40,000 ft)  | 12192 m (40,000 ft)  |
|  <b>CAUTION: Operating and storage temperature ranges may differ among components, so operating or storing the device outside these ranges may impact the performance of specific components.</b> |  |  |

\* Measured using a random vibration spectrum that simulates the user environment.

† Measured using a 2 ms half-sine pulse.

## Dell low blue light display

 **WARNING: Prolonged exposure to blue light from the display may lead to long-term effects such as eye strain, eye fatigue, or damage to the eyes.**

Blue light is a color in the light spectrum which has a short wavelength and high energy. Chronic exposure to blue light, particularly from digital sources may disrupt sleep patterns and cause long-term effects such as eye strain, eye fatigue, or damage to the eyes.

 **NOTE:** The display on this computer is designed to minimize blue light and complies with TÜV Rheinland's requirement for low blue light (hardware solution) displays.

Low blue light (hardware solution) mode is enabled at the factory, so no further configuration is necessary.









To reduce the risk of eye strain, it is also recommended that you:

- Position the display at a comfortable viewing distance between 20 and 28 inches (50 cm and 70 cm) from your eyes.
- Blink frequently to moisten your eyes, wet your eyes with water, or apply eye drops.
- Look away from your display, and gaze at a distant object at 20 ft (609.60 cm) away for at least 20 seconds during each break.
- Take an extended break for 20 minutes every two hours.

# Working inside your computer



## Safety instructions

Use the following safety guidelines to protect your computer from potential damage and to ensure your personal safety. Unless otherwise noted, each procedure in this document assumes that you have read the safety information that shipped with your computer.

-  **WARNING:** Before working inside your computer, read the safety information that is shipped with your computer. For more safety best practices, see [Dell Regulatory Compliance Home Page](#).
-  **WARNING:** Disconnect your computer from all power sources before opening the computer cover or panels. After you finish working inside the computer, replace all covers, panels, and screws before connecting your computer to an electrical outlet.
-  **CAUTION:** To avoid damaging the computer, ensure that the work surface is flat, dry, and clean.
-  **CAUTION:** You should only perform troubleshooting and repairs as authorized or directed by the Dell technical support team. Damage due to servicing that is not authorized by Dell is not covered by your warranty. See the safety instructions that is shipped with the product or at [Dell Regulatory Compliance Home Page](#).
-  **CAUTION:** Before touching anything inside your computer, ground yourself by touching an unpainted metal surface, such as the metal at the back of the computer. While you work, periodically touch an unpainted metal surface to dissipate static electricity which could harm internal components.
-  **CAUTION:** To avoid damaging the components and cards, handle them by their edges, and avoid touching the pins and the contacts.
-  **CAUTION:** When you disconnect a cable, pull it by its connector or its pull tab, not the cable itself. Some cables have connectors with locking tabs or thumbscrews that you must disengage before disconnecting the cable. When disconnecting cables, keep them evenly aligned to avoid bending the connector pins. When connecting cables, ensure that the connector on the cable is correctly oriented and aligned with the port.
-  **CAUTION:** Press and eject any installed card from the media-card reader.
-  **CAUTION:** Exercise caution when handling rechargeable Li-ion batteries in laptops. Swollen batteries should not be used and should be replaced and disposed properly.

## Before working inside your computer

### Steps

1. Save and close all open files and exit all open applications.
2. Shut down your computer. For Windows operating system, click **Start** >  **Power** > **Shut down**.
  -  **NOTE:** If you are using a different operating system, see the documentation of your operating system for instructions.
3. Turn off all the attached peripherals.
4. Disconnect your computer from the electrical outlets.
5. Disconnect all attached network devices and peripherals, such as keyboard, mouse, and monitor from your computer.
6. Remove any media card and optical drive from your computer, if applicable.
7. Enter the Service Mode.

## Service Mode

Service Mode is used to cut off power without disconnecting the battery cable from the system board before conducting repairs in the computer.

 **CAUTION:** If you are unable to turn on the computer to put it into Service Mode, proceed to disconnect the battery cable. To disconnect the battery cable, follow the steps in [Removing the battery](#).

 **NOTE:** Ensure that your computer is shut down and the power adapter is disconnected.

- a. Press and hold the B key and the power button for 3 seconds or until the Dell logo appears on the screen.
- b. Press any key to continue.
- c. If the power adapter is not disconnected, a message prompting you to disconnect the power adapter appears on the screen. Disconnect the power adapter and then press any key to enter into the Service Mode. The Service Mode process automatically skips the following step if the **Owner Tag** of the computer is not set up in advance by the user.
- d. When the **ready-to-proceed** message appears on the screen, press any key to proceed. The computer emits three short beeps and shuts down immediately.  
The computer shuts down and enters the Service Mode.

## Safety precautions

This section details the primary steps to be followed before performing any disassembly instructions.

Observe the following safety precautions before you perform any installation or break-fix procedures involving disassembly or reassembly:

- Turn off the computer and all attached peripherals.
- Disconnect the computer from AC power.
- Disconnect all network cables and peripherals from the computer.
- Use an ESD field service kit when working inside any to avoid electrostatic discharge (ESD) damage.
- Place the removed component on an anti-static mat after removing it from the computer.
- Wear shoes with nonconductive rubber soles to reduce the chance of getting electrocuted.
- Unplugging, pressing, and holding the power button for 15 seconds should discharge residual power in the system board.

## Standby power

Dell products with standby power must be unplugged before you open the back cover. Systems that are equipped with standby power are powered while turned off. The internal power enables the computer to be remotely turned on (Wake-on-LAN) and suspended into a sleep mode and has other advanced power management features.

## Bonding

Bonding is a method for connecting two or more grounding conductors to the same electrical potential. This is done by using a field service electrostatic discharge (ESD) kit. When connecting a bonding wire, ensure that it is connected to bare metal and never to a painted or nonmetal surface. Ensure that the wrist strap is secure and in full contact with your skin. Remove all jewelry, watches, bracelets, or rings before grounding yourself and the equipment.

## Electrostatic discharge—ESD protection

ESD is a major concern when you handle electronic components, especially sensitive components such as expansion cards, processors, memory modules, and system boards. A slight charge can damage circuits in ways that may not be obvious, such as intermittent problems or a shortened product life span. As the industry pushes for lower power requirements and increased density, ESD protection is an increasing concern.

Due to the increased density of semiconductors used in recent Dell products, the sensitivity to static damage is now higher than in previous Dell products. For this reason, some previously approved methods of handling parts are no longer applicable.

Two recognized types of ESD damage are catastrophic and intermittent failures.

- **Catastrophic** – Catastrophic failures represent approximately 20 percent of ESD-related failures. The damage causes an immediate and complete loss of device functionality. An example of catastrophic failure is a memory module that has

received a static shock and immediately generates a "No POST/No Video" symptom with a beep code that is emitted for missing or nonfunctional memory.

- **Intermittent** – Intermittent failures represent approximately 80 percent of ESD-related failures. The high rate of intermittent failures means that most of the time when damage occurs, it is not immediately recognizable. The memory module receives a static shock, but the tracing is merely weakened and does not immediately produce outward symptoms that are related to the damage. The weakened trace may take weeks or months to melt, and in the meantime may cause degradation of memory integrity, intermittent memory errors, and so on.

Intermittent failures that are also called latent or "walking wounded" are difficult to detect and troubleshoot.

Perform the following steps to prevent ESD damage:

- Use a wired ESD wrist strap that is properly grounded. Wireless anti-static straps do not provide adequate protection. Touching the chassis before handling parts does not ensure adequate ESD protection on parts with increased sensitivity to ESD damage.
- Handle all static-sensitive components in a static-safe area. If possible, use anti-static floor pads and workbench pads.
- When unpacking a static-sensitive component from its shipping carton, do not remove the component from the anti-static packing material until you are ready to install the component. Before unwrapping the anti-static packaging, use the anti-static wrist strap to discharge the static electricity from your body. For more information about the wrist strap and ESD wrist strap tester, see [Components of an ESD Field Service Kit](#).
- Before transporting a static-sensitive component, place it in an anti-static container or packaging.

## ESD Field Service kit

The unmonitored field service kit is the most commonly used service kit. Each Field Service kit includes three main components: anti-static mat, wrist strap, and bonding wire.

 **CAUTION: It is critical to keep ESD-sensitive devices away from internal parts that are insulated and often highly charged, such as plastic heat sink casings.**

## Working Environment

Before deploying the ESD Field Service kit, assess the situation at the customer location. For example, deploying the kit for a server environment is different than for a desktop or laptop environment. Servers are typically installed in a rack within a data center; desktops or laptops are typically placed on office desks or cubicles. Always look for a large open flat work area that is free of clutter and large enough to deploy the ESD kit with additional space to accommodate the type of computer that is being repaired. The workspace should also be free of insulators that can cause an ESD event. On the work area, insulators such as styrofoam and other plastics should always be moved at least 12 inches or 30 centimeters away from sensitive parts before physically handling any hardware components.

## ESD Packaging

All ESD-sensitive devices must be shipped and received in static-safe packaging. Metal, static-shielded bags are preferred. However, you should always return the damaged component using the same ESD bag and packaging that the new part arrived in. The ESD bag should be folded over and taped shut and all the same foam packing material should be used in the original box that the new part arrived in. ESD-sensitive devices should be removed from packaging only at an ESD-protected work surface, and parts should never be placed on top of the ESD bag because only the inside of the bag is shielded. Always place parts in your hand, on the anti-static mat, in the computer, or inside an ESD bag.

## Components of an ESD Field Service kit

The components of an ESD Field Service kit are:

- **Anti-Static Mat** – The anti-static mat is dissipative and parts can be placed on it during service procedures. When using an anti-static mat, your wrist strap should be snug and the bonding wire should be connected to the anti-static mat and to any bare metal on the computer being worked on. Once deployed properly, service parts can be removed from the ESD bag and placed directly on the anti-static mat. ESD-sensitive items are safe in your hand, on the anti-static mat, in the computer, or inside an ESD bag.
- **Wrist Strap and Bonding Wire** – The wrist strap and bonding wire can be either directly connected between your wrist and bare metal on the hardware if the anti-static mat is not required, or connect to the anti-static mat to protect hardware that is temporarily placed on the mat. The physical connection of the wrist strap and bonding wire between your skin, the anti-static mat, and the hardware is known as bonding. Use only Field Service kits with a wrist strap, anti-static mat, and

bonding wire. Never use wireless wrist straps. Always be cautious that the internal wires of a wrist strap are prone to damage from normal wear and tear, and must be checked regularly with a wrist strap tester in order to avoid accidental ESD hardware damage. It is recommended to test the wrist strap and bonding wire at least once per week.

- **ESD Wrist Strap Tester** – The wires inside an ESD strap are prone to damage over time. When using an unmonitored kit, it is a best practice to regularly test the strap prior to each service, and at a minimum, test once per week. A wrist strap tester is the best method for doing this test. To perform the test, plug the bonding-wire of the wrist-strap into the tester while it is strapped to your wrist and push the button to test. A green LED is lit if the test is successful; a red LED is lit and an alarm sounds if the test fails.

**NOTE:** It is recommended to always use the traditional wired ESD grounding wrist strap and protective anti-static mat when servicing Dell products. In addition, it is critical to keep sensitive parts separate from all insulator parts while servicing the computer.

## Transporting sensitive components

When transporting ESD sensitive components such as replacement parts or parts to be returned to Dell, it is critical to place these parts in anti-static bags for safe transport.

## After working inside your computer

### About this task

**CAUTION:** Leaving stray or loose screws inside your computer may severely damage your computer.

### Steps

1. Replace all screws and ensure that no stray screws remain inside your computer.
2. Connect any external devices, peripherals, or cables you removed before working on your computer.
3. Replace any media cards, disks, or any other parts that you removed before working on your computer.
4. Connect your computer to their electrical outlets.

**NOTE:** To exit service mode, ensure to connect the AC adapter to the power-adapter port on your computer.

5. Press the power button to turn on the computer.

## BitLocker

**CAUTION:** If BitLocker is not suspended before updating the BIOS, the BitLocker key is not recognized the next time you reboot the computer. You will then be prompted to enter the recovery key to progress, and the system displays a prompt for the recovery key on each reboot. If the recovery key is not known, this can result in data loss or an operating system reinstall. For more information, see Knowledge Article: [updating the BIOS on Dell systems with BitLocker enabled](#).

The installation of the following components triggers BitLocker:

- Hard disk drive or solid-state drive
- System board

## Recommended tools

The procedures in this document may require the following tools:

- Phillips screwdriver #0
- Phillips screwdriver #1
- Torx T8 screwdriver



**Figure 10. Torx T8 screw**

- 5.5 mm socket wrench







**Figure 11. 5.5 mm Socket screw**

- Plastic scribe















## Screw list

- NOTE:** When removing screws from a component, it is recommended to note the screw type and the quantity of screws, and then place them in a screw storage box. This is to ensure that the correct number of screws and correct screw type is restored when the component is replaced.
- NOTE:** Some computers have magnetic surfaces. Ensure that the screws are not left attached to such surfaces when replacing a component.
- NOTE:** Screw color may vary depending on the configuration ordered.







**Table 41. Screw list**

| Component                  | Screw type | Quantity | Screw image  |
|----------------------------|------------|----------|--|
| Solid state drive carrier  | M2x3       | 1        |   |
| M.2 2230 solid state drive | M2x2       | 1        | <br> |
|                            | M2x5       | 1        |  |
| M.2 2280 solid state drive | M2x5       | 1        |   |

**Table 41. Screw list (continued)**

| Component                                  | Screw type          | Quantity | Screw image   |
|--|---------------------|----------|---|
| Handle                                     | M3.5x8              | 2        |    |
| Keyboard                                   | M2.5x5 (Rubberized) | 4        |    |
|  | M2.5x5 (Standard)   | 6        |   |
|  | M2x3                | 4        |   |
| Base cover                                 | M2.5x5              | 27       |    |
|  | M2x3                | 4        |   |
| Stylus holder                              | M2x3                | 4        |    |
| Express-card reader                        | M2x3                | 4        |    |
| Smart-card reader                          | M2x3                | 4        |  |
| Smart-card and Express-card reader bracket | M2x3                | 2        |  |
| Fan  | M2.5x5              | 3        |  |
| RF switch board                            | M2.5x5              | 2        |  |
| WLAN card                                  | M2x3                | 1        |  |
| WWAN card                                  | M2x3                | 1        |  |
| GPS board                                  | M2x5.5              | 2        |  |
| Fischer USB port (optional)                | M2.5x3              | 2        |  |
| Dock I/O-bracket                           | M2x5                | 4        |  |

**Table 41. Screw list (continued)**

| Component   | Screw type            | Quantity | Screw image   |
|---|-----------------------|----------|---|
| Heat sink   | M2x6 (captive screws) | 4        |    |
| Rear I/O-board/ Fischer USB I/O-board/ Ethernet I/O-board/ Serial I/O-board/ USB Type-A I/O-board | M2.5x5<br>#4-40x6.5   | 2<br>2   |    |
| System board  | M2.5x5                | 7<br>1   |    |
| Right Type-C board  | M2x3.5<br>M2.5x5      | 4<br>3   |    |
| Left Type-C board   | M2.3x3.5<br>M2x3      | 4<br>1   |   |
| Display assembly  | M3x6, T8<br>M2.5x5    | 8<br>2   |  |
| Display-panel assembly  | M2.5x6, T8            | 15       |  |

## Major components of Dell Pro Rugged 13 RA13250

The following image shows the major components of Dell Pro Rugged 13 RA13250.

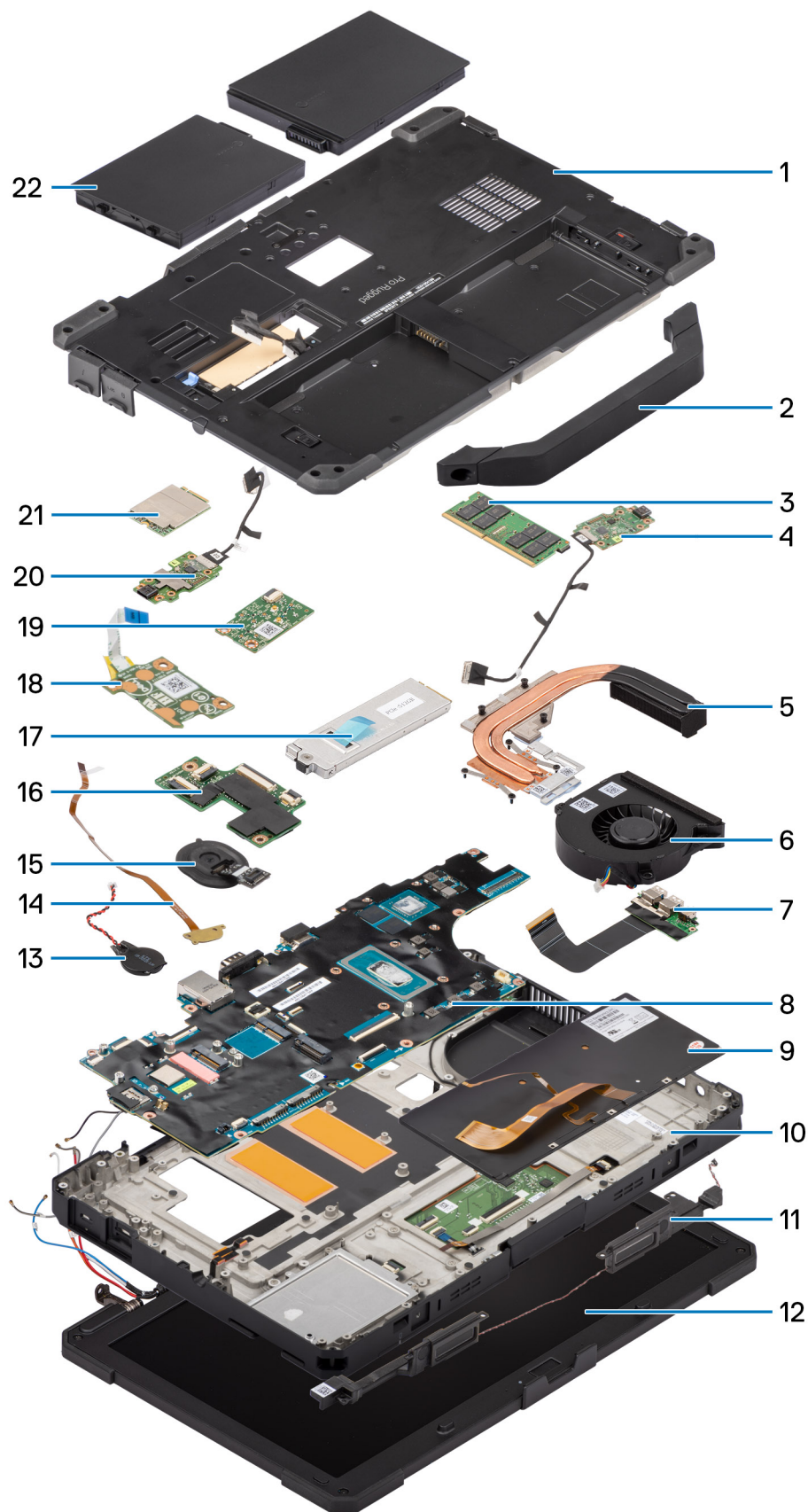



Figure 12. Exploded view

1. Base cover
2. Rigid handle
3. Memory module
4. Left USB Type-C board
5. Heat sink
6. Fan
7. Left I/O-board
8. System board
9. Keyboard
10. Palm-rest assembly
11. Speakers
12. Display assembly
13. Coin-cell battery
14. Keyboard LED board
15. Power button with fingerprint reader
16. USH board
17. Solid state drive
18. Power-button board
19. RF switch board
20. Right USB Type-C board
21. WWAN module
22. Battery

 **NOTE:** Dell provides a list of components and their part numbers for the original computer configuration purchased. These parts are available according to warranty coverage purchased by the customer. Contact your Dell sales representative for purchase options.

# Removing and installing Customer Replaceable Units (CRUs)

The replaceable components in this chapter are Customer Replaceable Units (CRUs).

**CAUTION:** Customers can replace only the Customer Replaceable Units (CRUs) following the safety precautions and replacement procedures.

**NOTE:** The images in this document may differ from your computer depending on the configuration you ordered.

## Battery

### Rechargeable Li-ion battery precautions

**CAUTION:**

- Exercise caution when handling rechargeable Li-ion batteries.
- Discharge the battery completely before removing it. Disconnect the AC power adapter from the computer and operate the computer solely on battery power—the battery is fully discharged when the computer no longer turns on when the power button is pressed.
- Do not crush, drop, mutilate, or penetrate the battery with foreign objects.
- Do not expose the battery to high temperatures, or disassemble battery packs and cells.
- Do not apply pressure to the surface of the battery.
- Do not bend the battery.
- Do not use tools of any kind to pry on or against the battery.
- Ensure any screws during the servicing of this product are not lost or misplaced, to prevent accidental puncture or damage to the battery and other computer components.
- If the battery gets stuck inside your computer as a result of swelling, do not try to release it as puncturing, bending, or crushing a rechargeable Li-ion battery can be dangerous. In such an instance, contact Dell technical support for assistance. See [Contact Support at Dell Support Site](#).
- Always purchase genuine batteries from [Dell Site](#) or authorized Dell partners and resellers.
- Swollen batteries should not be used and should be replaced and disposed properly. For guidelines on how to handle and replace swollen rechargeable Li-ion batteries, see [Handling swollen rechargeable Li-ion batteries](#).

## Removing the batteries

### Prerequisites

1. Follow the procedure in [before working inside your computer](#).

**NOTE:** Dell Pro Rugged 13 RA13250 can accommodate two swappable batteries (primary and optional). The removal procedure of the primary and optional batteries are identical.

### About this task

The following images indicate the location of the right and left batteries and provide a visual representation of the removal procedure.

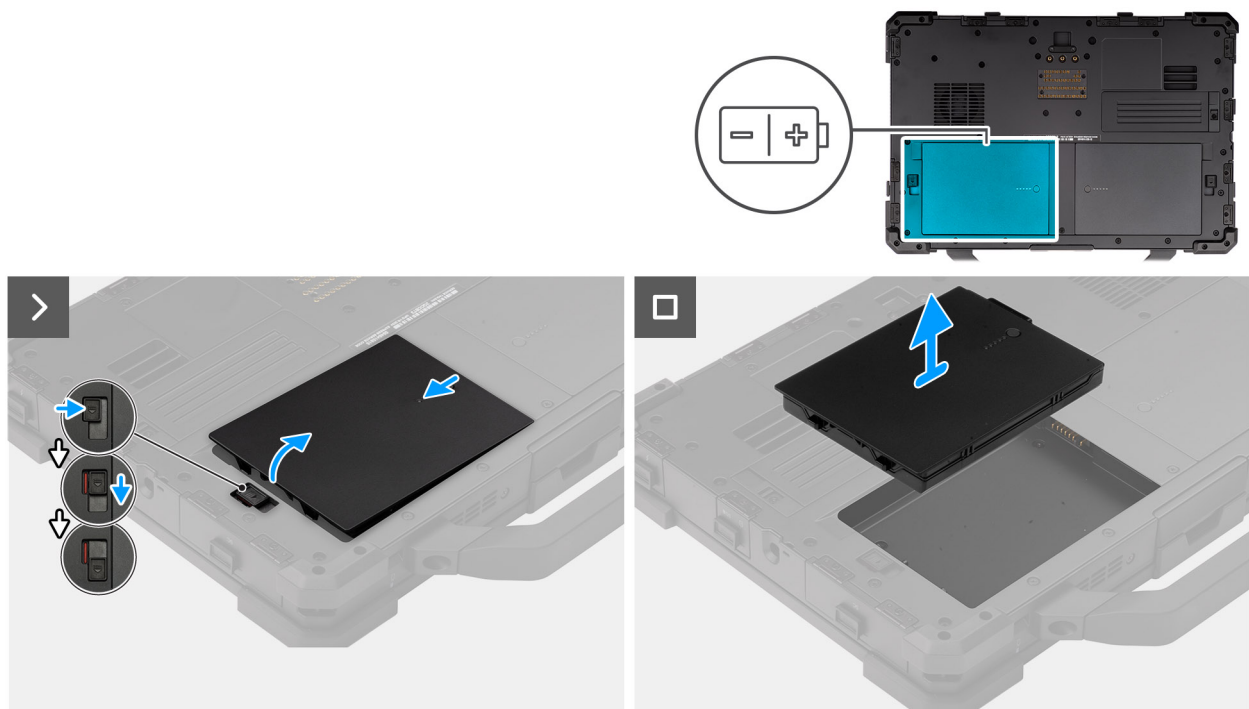

Figure 13. Removing the right-side battery

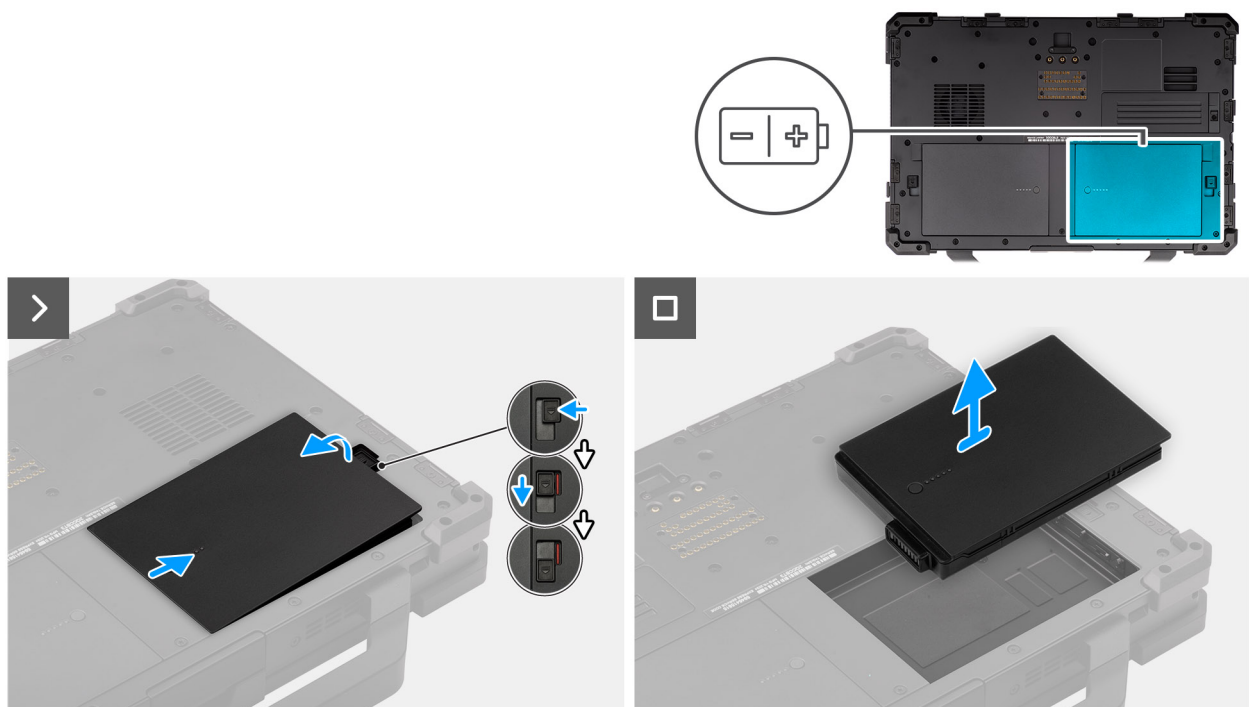

Figure 14. Removing the left-side battery

#### Steps

1. Slide the battery release latch to the unlocked position.
2. Slide the latch down to unlock the battery.
3. Lift the battery from the battery bay and remove it from the computer.

# Installing the batteries

## Prerequisites

If you are replacing a component, remove the existing component before performing the installation procedure.

## About this task

**NOTE:** Dell Pro Rugged 13 RA13250 can accommodate two swappable batteries (primary and optional). The removal procedure of the primary and optional batteries are identical.

**NOTE:** BIOS displays a battery error when non-Dell Pro Rugged 13 RA13250 batteries are used.

The following images indicate the location of the right and left batteries and provide a visual representation of the installation procedure.

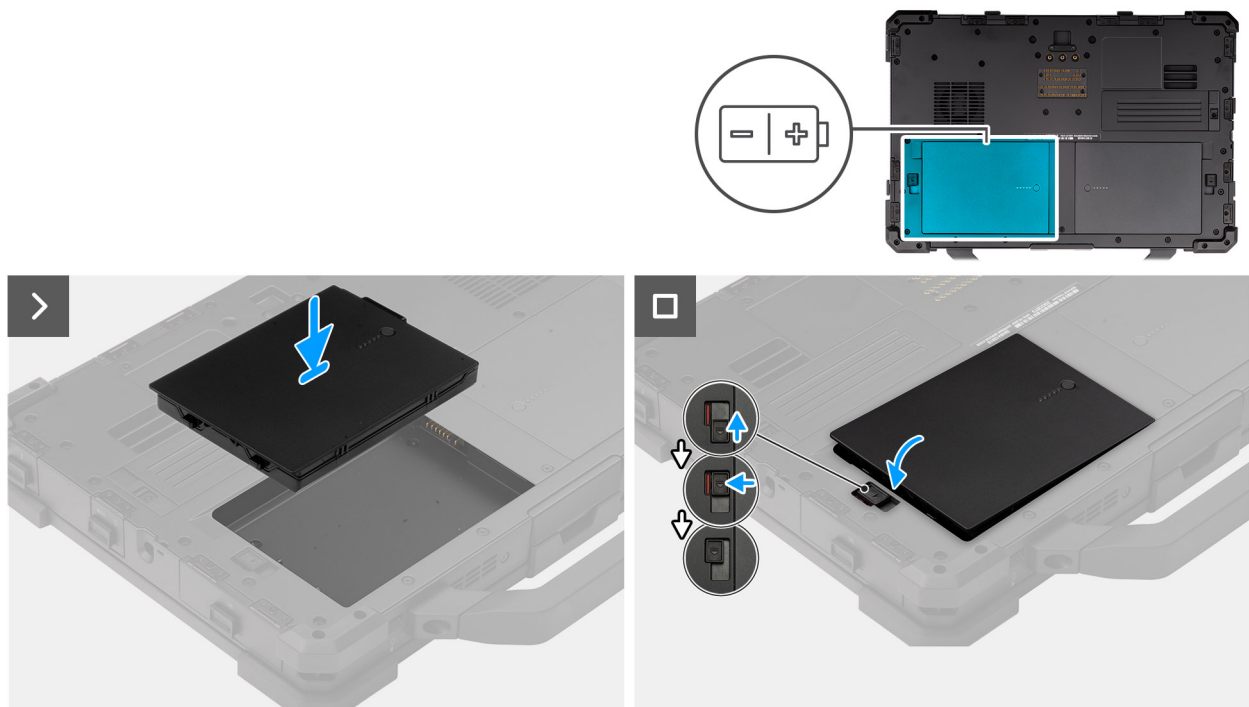
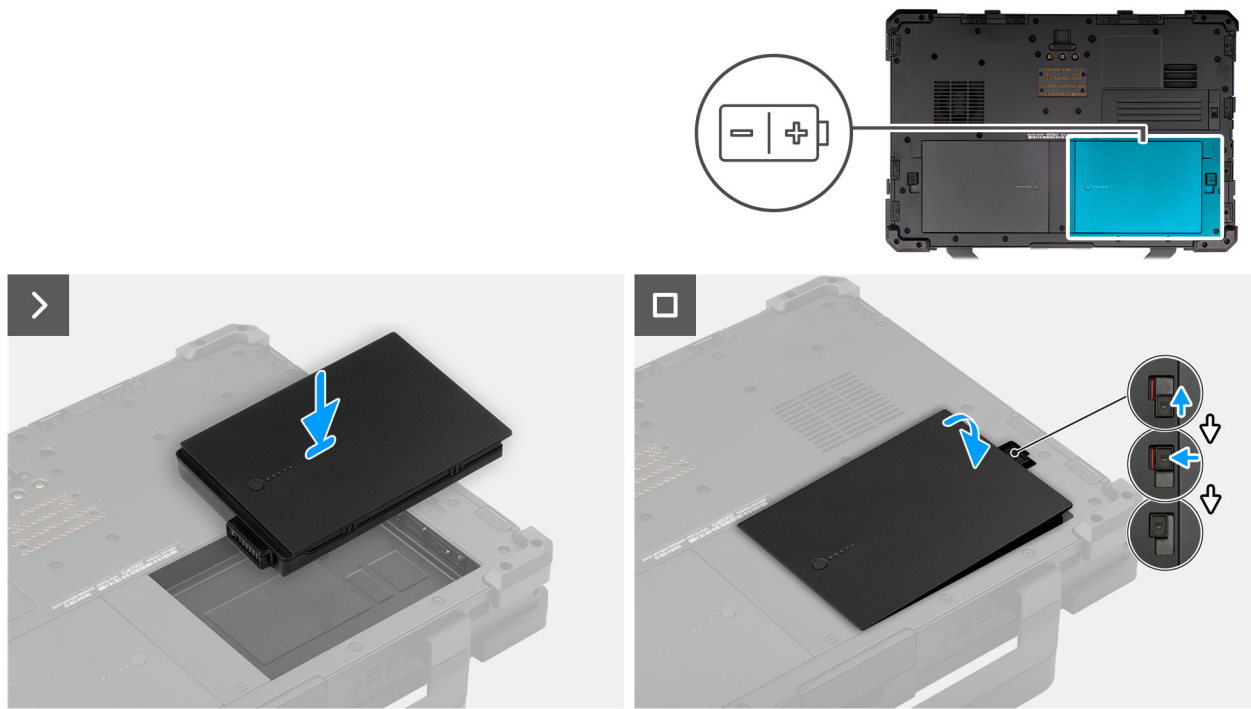

Figure 15. Installing the left-side battery



**Figure 16. Installing the right-side battery**

**Steps**

1. Align the pins on the battery with the connector on the computer.
  - (i) NOTE:** Ensure that the metal pin of the battery is aligned in place.
2. Place the battery into the battery bay until it clicks into place.
3. Slide the battery latch to the locked state.
  - (i) NOTE:** Ensure that the battery release latch is in the locked state.

**Next steps**

1. Follow the procedure in [after working inside your computer](#).

## Stylus

### Removing the stylus

**Prerequisites**

1. Follow the procedure in [before working inside your computer](#).

**About this task**

The following image indicates the location of the stylus and provides a visual representation of the removal procedure.

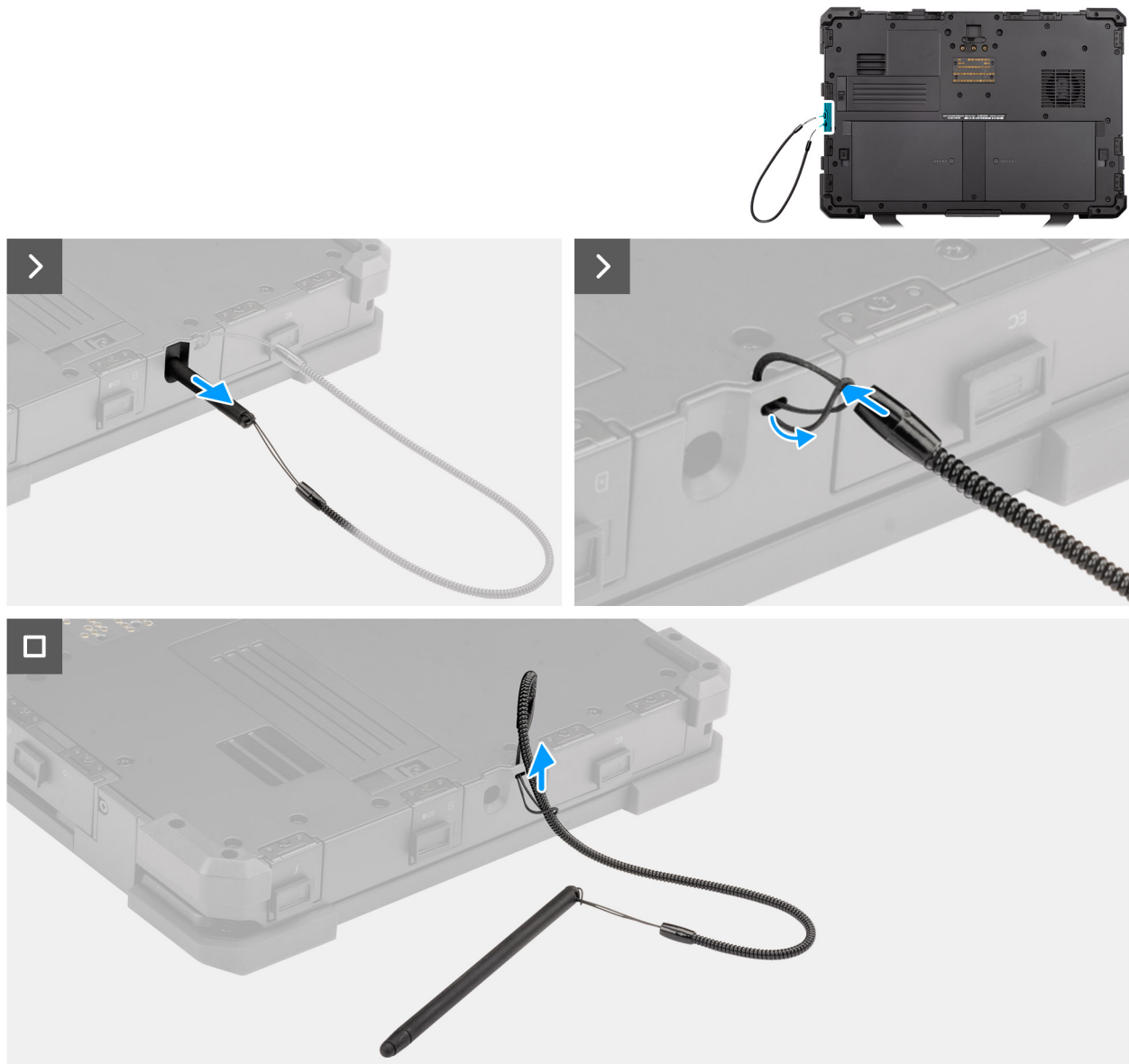

**Figure 17. Removing the stylus**

### Steps

1. Slide the stylus out using the groove on the stylus pen.  
 ⓘ **NOTE:** Avoid pulling the stylus with the stretchable thread.
2. Loosen the knot and slip the stylus through the hole to remove the tether from the computer chassis.

## Installing the stylus

### Prerequisites

If you are replacing a component, remove the existing component before performing the installation procedure.

### About this task

The following image indicates the location of the stylus and provides a visual representation of the installation procedure.

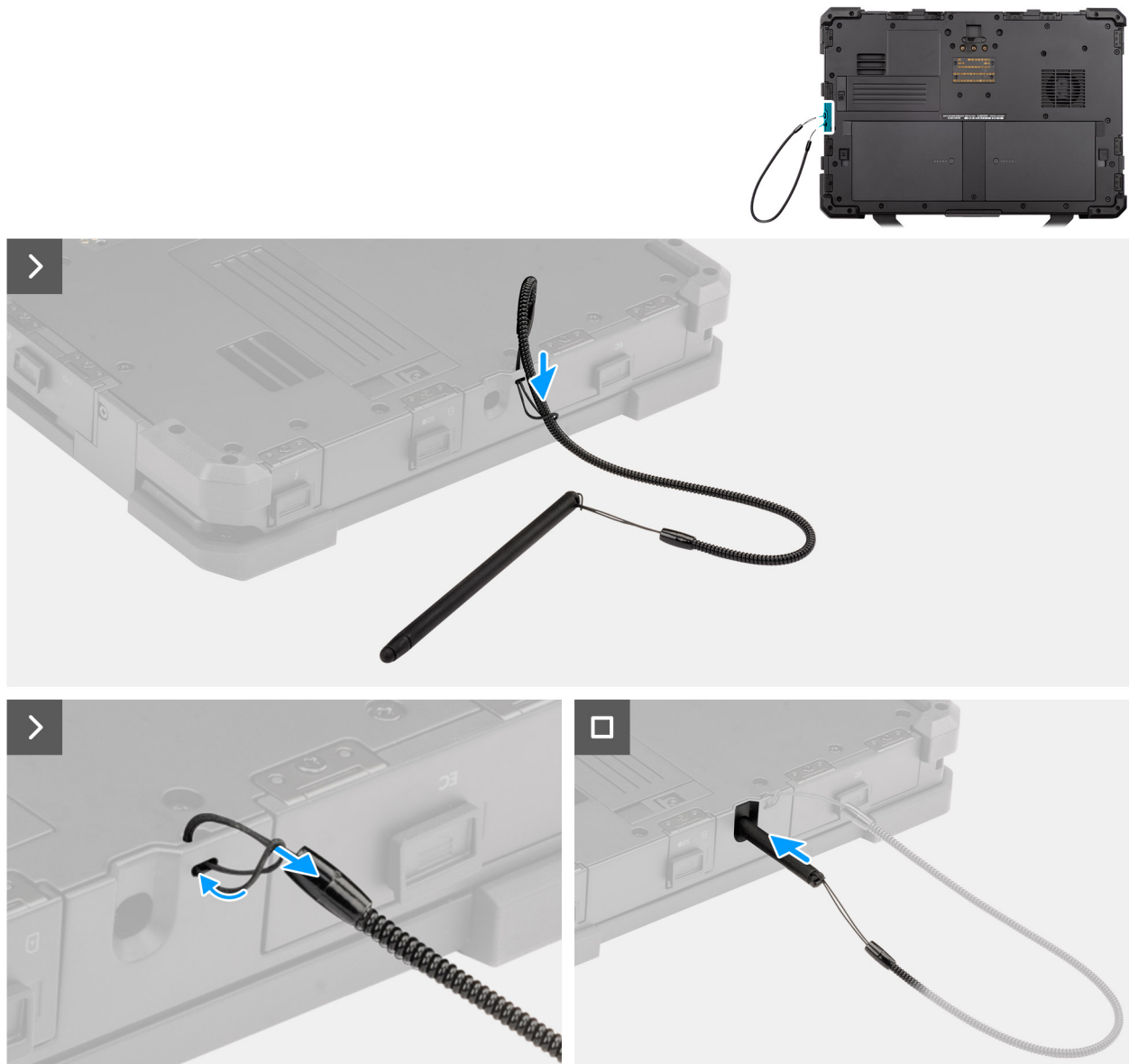

**Figure 18. Installing the stylus**

**Steps**

1. Slip the stylus through the hole to create a knot that holds the tether to the computer chassis.
2. Insert the stylus into the slot on the computer.

**i** **NOTE:** When not in use, avoid suspending the stylus that is detached from its groove.

**Next steps**

1. Follow the procedure in [after working inside your computer](#).

# Removing and installing Field Replaceable Units (FRUs)

The replaceable components in this chapter are Field Replaceable Units (FRUs).

**CAUTION:** The information in this section is intended for authorized service technicians only.

**CAUTION:** To avoid any potential damage to the component or loss of data, ensure that an authorized service technician replaces the Field Replaceable Units (FRUs).

**CAUTION:** Dell Technologies recommends that these procedures be performed by trained technical repair specialists.

**CAUTION:** Your warranty does not cover damages that may occur during FRU repairs that are not authorized by Dell Technologies.

**NOTE:** The images in this document may differ from your computer depending on the configuration you ordered.

## Handle

### Removing the handle

**CAUTION:** The information in this removal section is intended for authorized service technicians only.

#### Prerequisites

**NOTE:** The handle screw is part of the handle assembly and cannot be ordered separately.

1. Follow the procedure in [before working inside your computer](#).

#### About this task

The following image indicates the location of the handle and provides a visual representation of the removal procedure.



2x  
M3.5x8

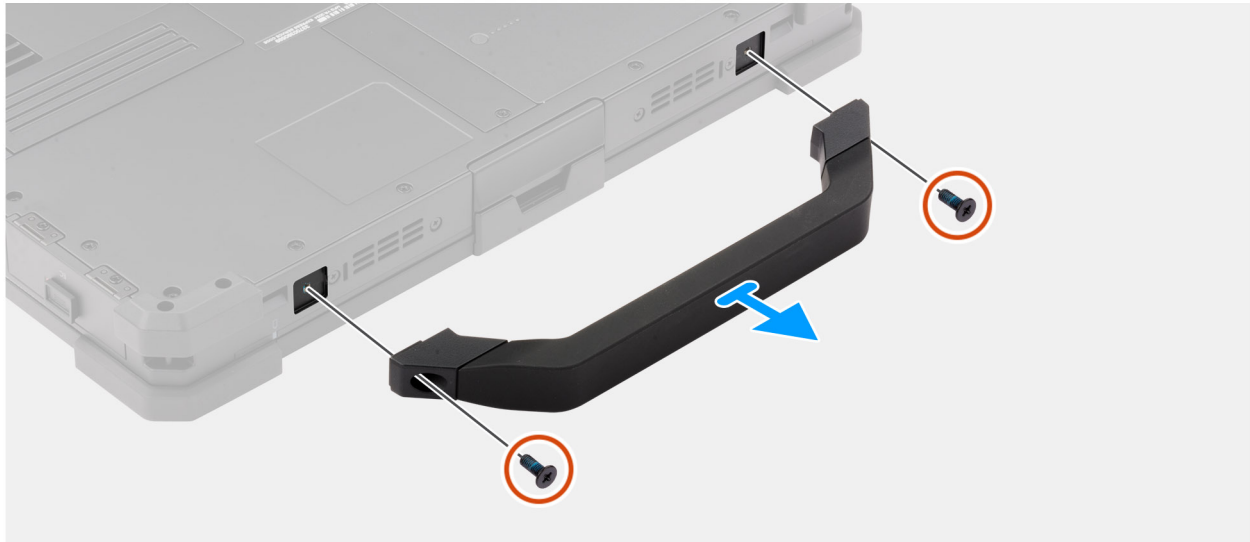

Figure 19. Removing the handle

#### Steps

1. Remove the two (M3.5x8) screws that secure the handle to the computer.
2. Remove the handle from the computer.

## Installing the handle

**CAUTION:** The information in this installation section is intended for authorized service technicians only.

#### Prerequisites

**NOTE:** The handle screw is part of the handle assembly and cannot be ordered separately.

If you are replacing a component, remove the existing component before performing the installation procedure.

#### About this task

The following image indicates the location of the handle and provides a visual representation of the installation procedure.



2x  
M3.5x8

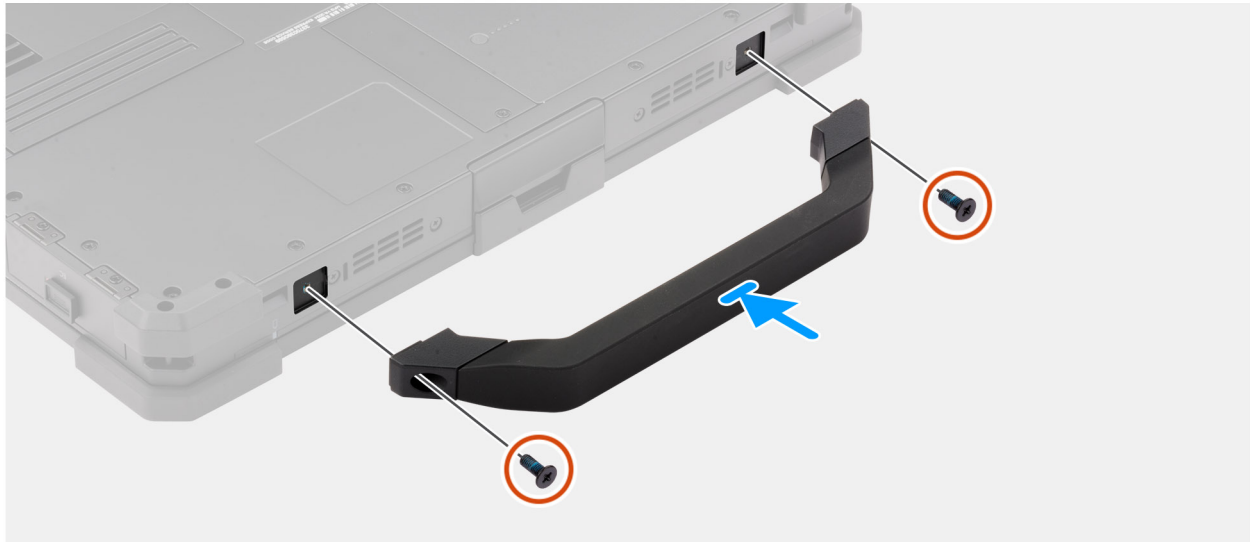

Figure 20. Installing the handle

#### Steps

1. Align the screw holes on the handle with the screw holes on the computer.
2. Replace the two (M3.5x8) screws to secure the handle to the computer.

#### Next steps

1. Follow the procedure in [after working inside your computer](#).

## Keyboard

### Removing the keyboard (standard)

**CAUTION:** The information in this removal section is intended for authorized service technicians only.

#### Prerequisites

1. Follow the procedure in [before working inside your computer](#).
2. Remove the [batteries](#).

#### About this task

The following images indicate the location of the keyboard and provide a visual representation of the removal procedure.

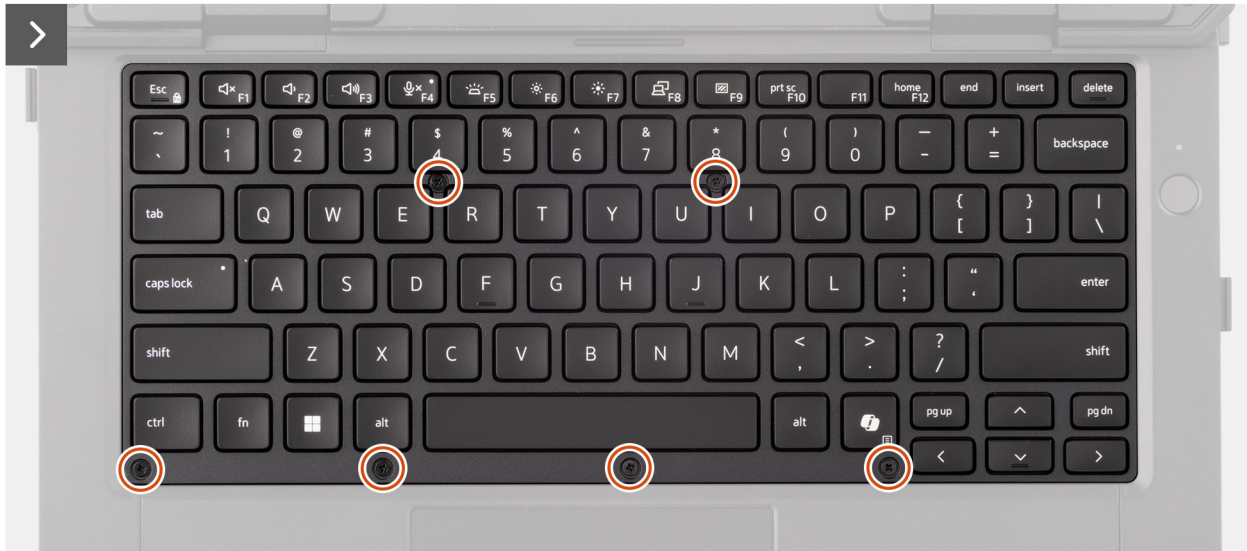

Figure 21. Removing the keyboard (standard)



Figure 22. Removing the keyboard (standard)



**Figure 23. Removing the keyboard (standard)**

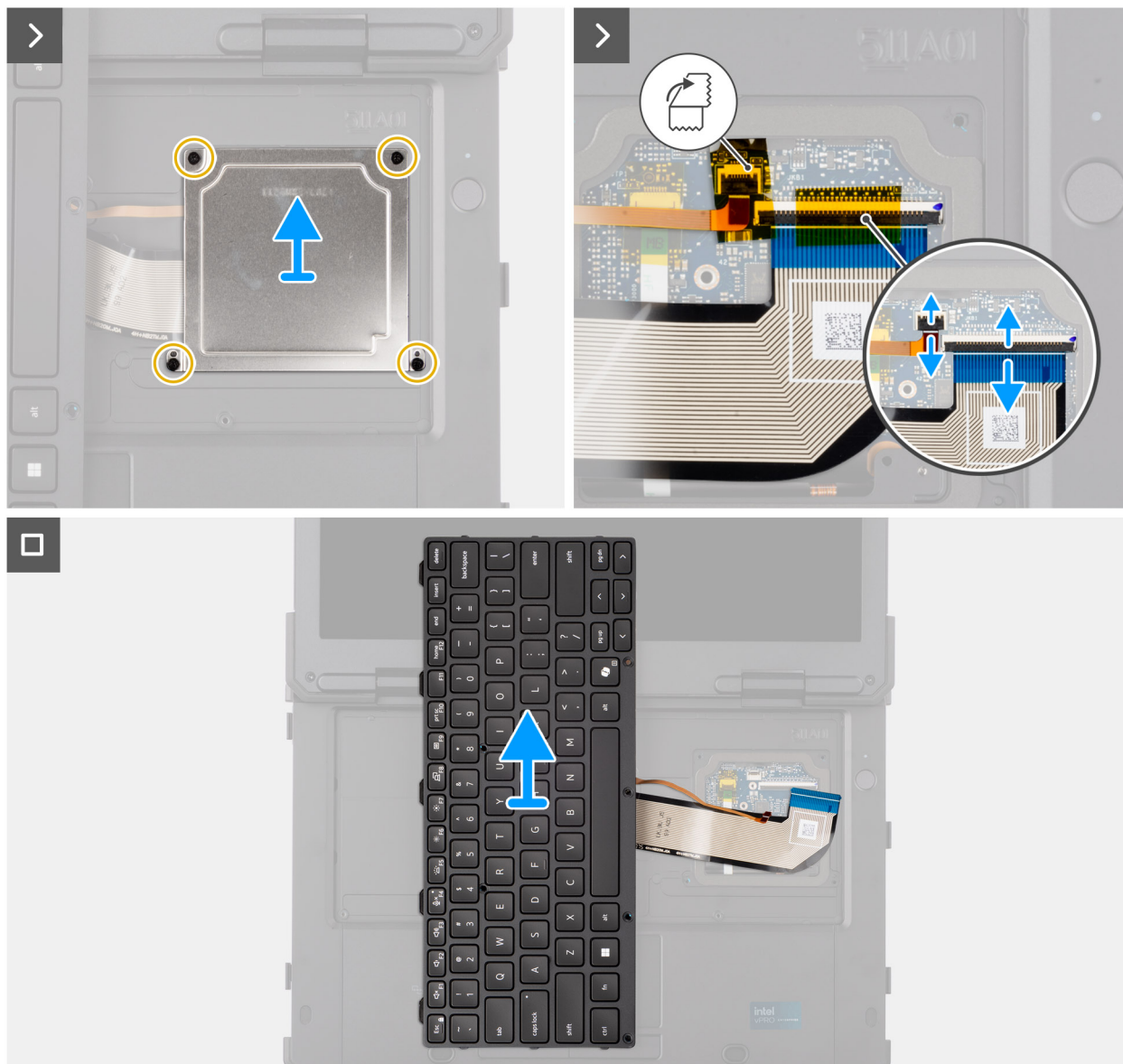

**Figure 24. Removing the keyboard (standard)**

### Steps

1. Remove the six (M2.5x5) screws that secure the keyboard to the computer chassis.
2. Pry the keyboard from the front and then rotate it counterclockwise until the keyboard-cable cover is visible, and then place it on the touchpad.
3. Remove the four (M2x3) screws that secure the keyboard-cable cover to the computer chassis.
4. Disconnect the keyboard and backlight flexible printed cables from the connectors on the system board.
5. Lift the keyboard from the computer.

## Installing the keyboard (standard)

**CAUTION:** The information in this installation section is intended for authorized service technicians only.

### Prerequisites

If you are replacing a component, remove the existing component before performing the installation procedure.

### About this task

The following images indicate the location of the keyboard and provide a visual representation of the installation procedure.



**6x**  
M2.5x5



**4x**  
M2x3



Figure 25. Installing the keyboard (standard)

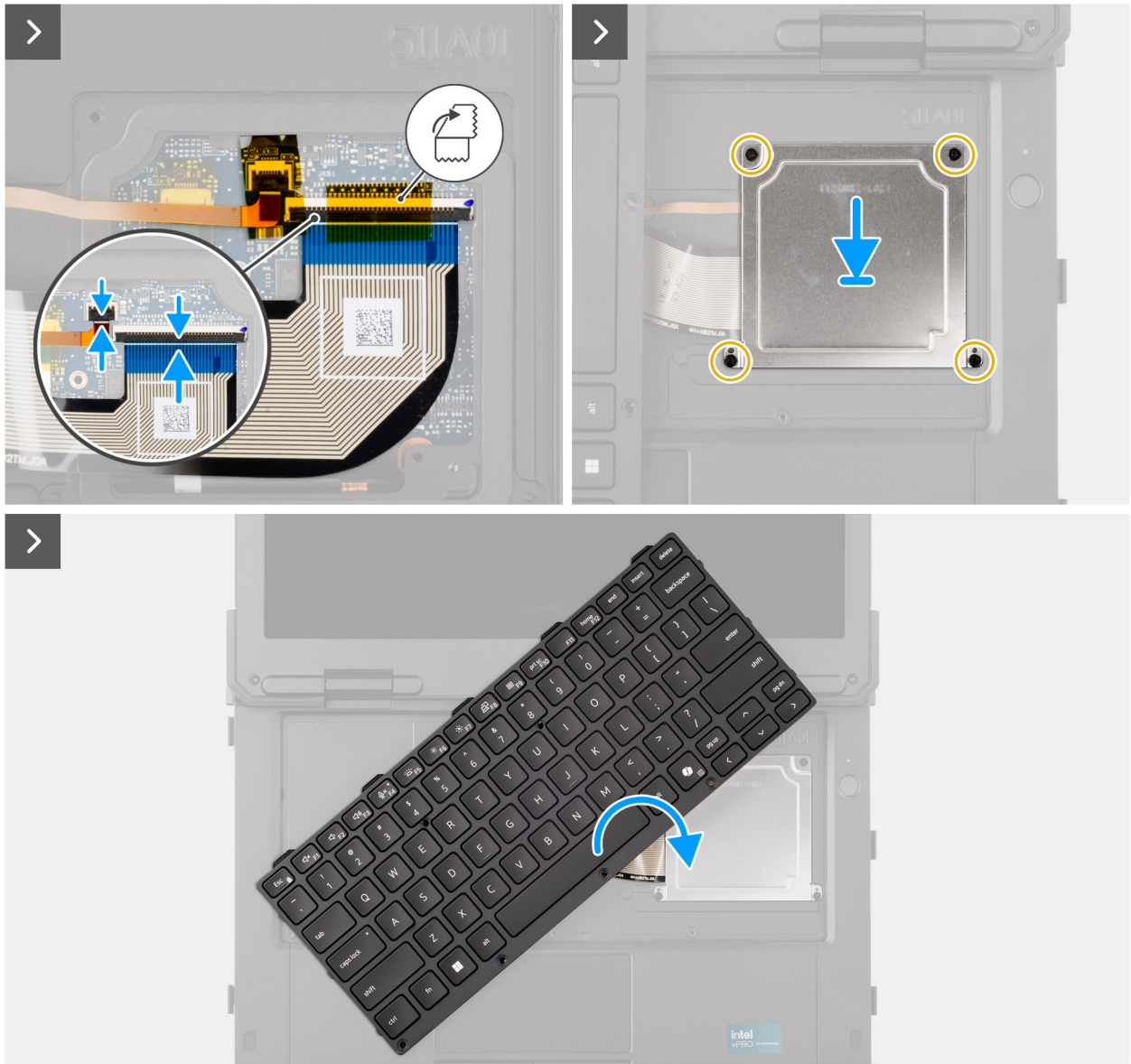

Figure 26. Installing the keyboard (standard)



Figure 27. Installing the keyboard (standard)

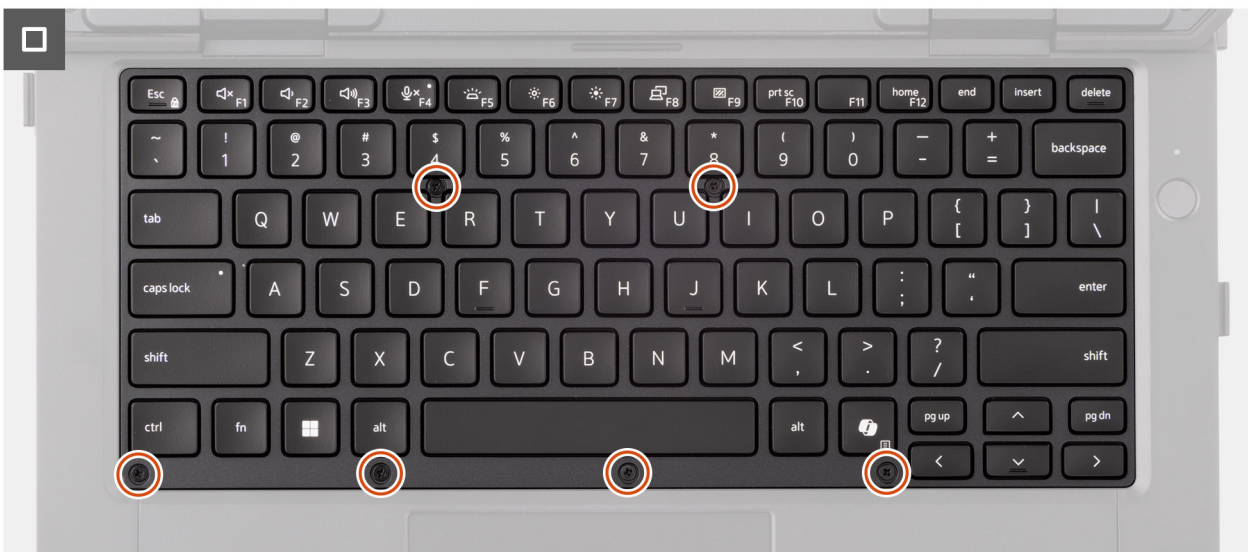

Figure 28. Installing the keyboard (standard)

**Steps**

1. Place the keyboard on the computer chassis.
2. Connect the keyboard and backlight flexible printed cables to the connectors on the system board.
  - i NOTE:** Adhere the keyboard and backlight flexible printed cable with kapton tapes to the connectors.
3. Replace the four (M2x3) screws that secure the keyboard-cable cover to the computer chassis.
4. Rotate the keyboard on the chassis and slide it towards the display to align with the screw holes.
5. Replace the six (M2.5x5) screws to secure the keyboard.

### Next steps

1. Install the [batteries](#).
2. Follow the procedure in [after working inside your computer](#).

## Removing the keyboard (rubberized)

**CAUTION:** The information in this removal section is intended for authorized service technicians only.

### Prerequisites

1. Follow the procedure in [before working inside your computer](#).
2. Remove the [batteries](#).

### About this task

The following images indicate the location of the keyboard and provide a visual representation of the removal procedure.



Figure 29. Removing the keyboard (rubberized)



Figure 30. Removing the keyboard (rubberized)



Figure 31. Removing the keyboard (rubberized)

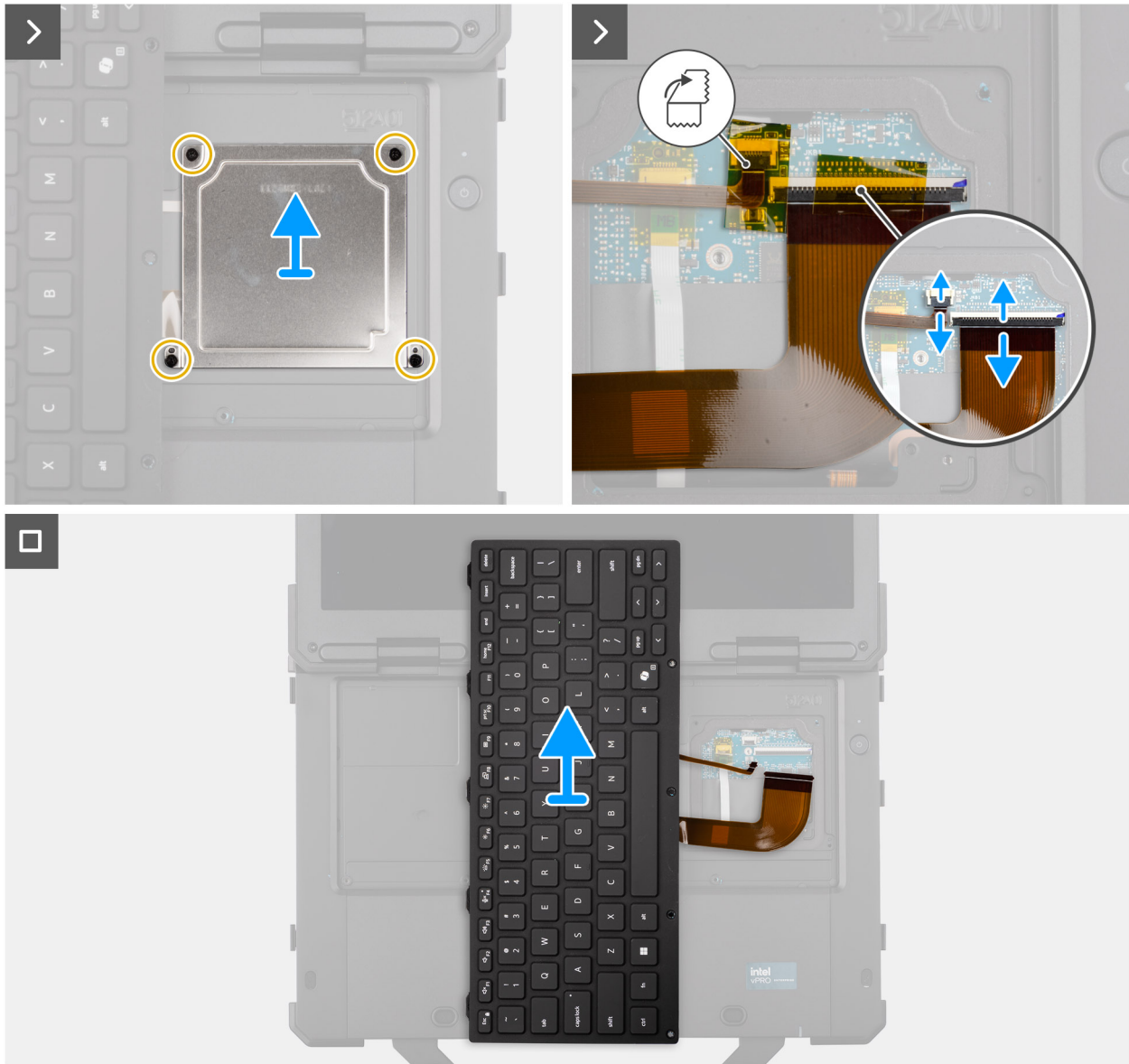

**Figure 32. Removing the keyboard (rubberized)**

### Steps

1. Remove the six (M2.5x5) screws that secure the keyboard to the computer chassis.
2. Pry the keyboard from the front and then rotate it counterclockwise until the keyboard-cable cover is visible, and then place it on the touchpad.
3. Remove the four (M2x3) screws that secure the keyboard cable cover to the computer chassis.
4. Disconnect the keyboard and backlight flexible printed cables from the connectors on the system board.
5. Lift the keyboard from the computer.

## Installing the keyboard (rubberized)

**CAUTION:** The information in this installation section is intended for authorized service technicians only.

### Prerequisites

If you are replacing a component, remove the existing component before performing the installation procedure.

### About this task

The following images indicate the location of the keyboard and provide a visual representation of the installation procedure.



4x  
M2.5x5



4x  
M2x3



Figure 33. Installing the keyboard (rubberized)

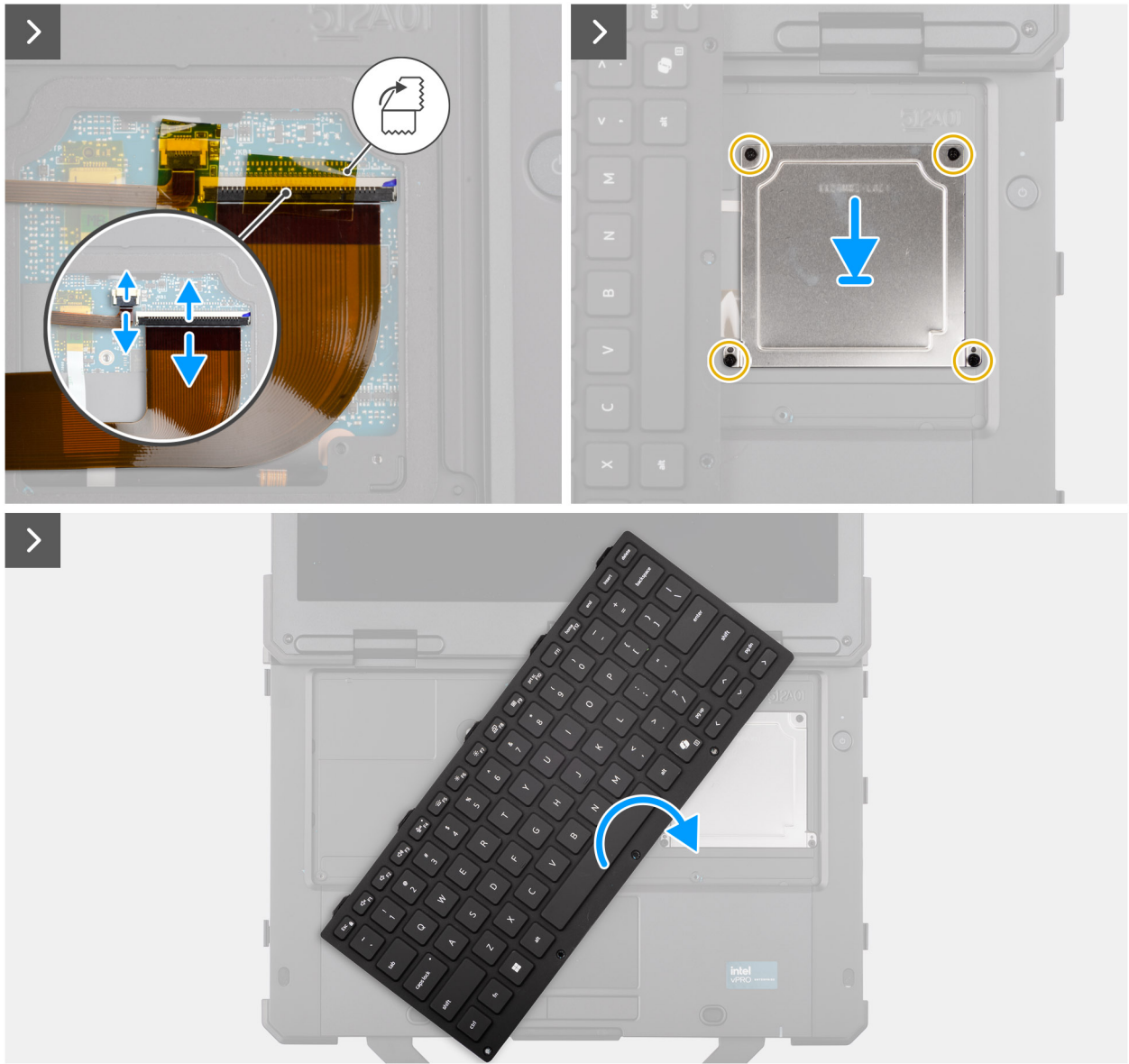

Figure 34. Installing the keyboard (rubberized)



**Figure 35. Installing the keyboard (rubberized)**



**Figure 36. Installing the keyboard (rubberized)**

**Steps**

1. Place the keyboard on the computer chassis.
2. Connect the keyboard and backlight flexible printed cables to the connectors on the system board.
  - i NOTE:** Adhere the keyboard and backlight flexible printed cable with kapton tapes to the connectors.
3. Replace the four (M2x3) screws that secure the keyboard-cable cover to the computer chassis.
4. Rotate the keyboard on the chassis and slide it towards the display to align with the screw holes.
5. Replace the six (M2.5x5) screws to secure the keyboard.

### Next steps

1. Install the [batteries](#).
2. Follow the procedure in [after working inside your computer](#).

## Solid state drive carrier

### Removing the solid state drive carrier

 **CAUTION:** The information in this removal section is intended for authorized service technicians only.

#### Prerequisites

1. Follow the procedure in [before working inside your computer](#).
2. Remove the [batteries](#).

#### About this task

The following images indicate the location of the solid state drive carrier and provide a visual representation of the removal procedure.



1x  
M2x3

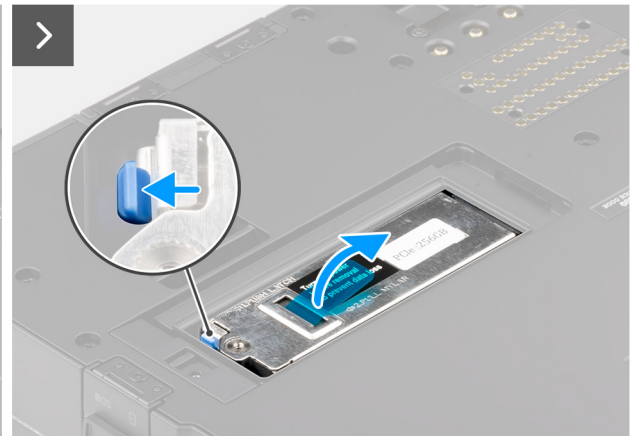
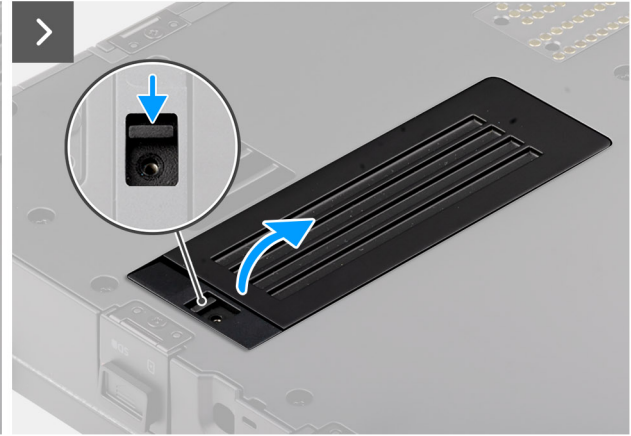
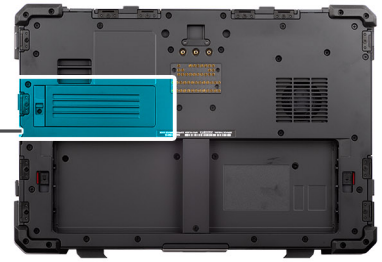
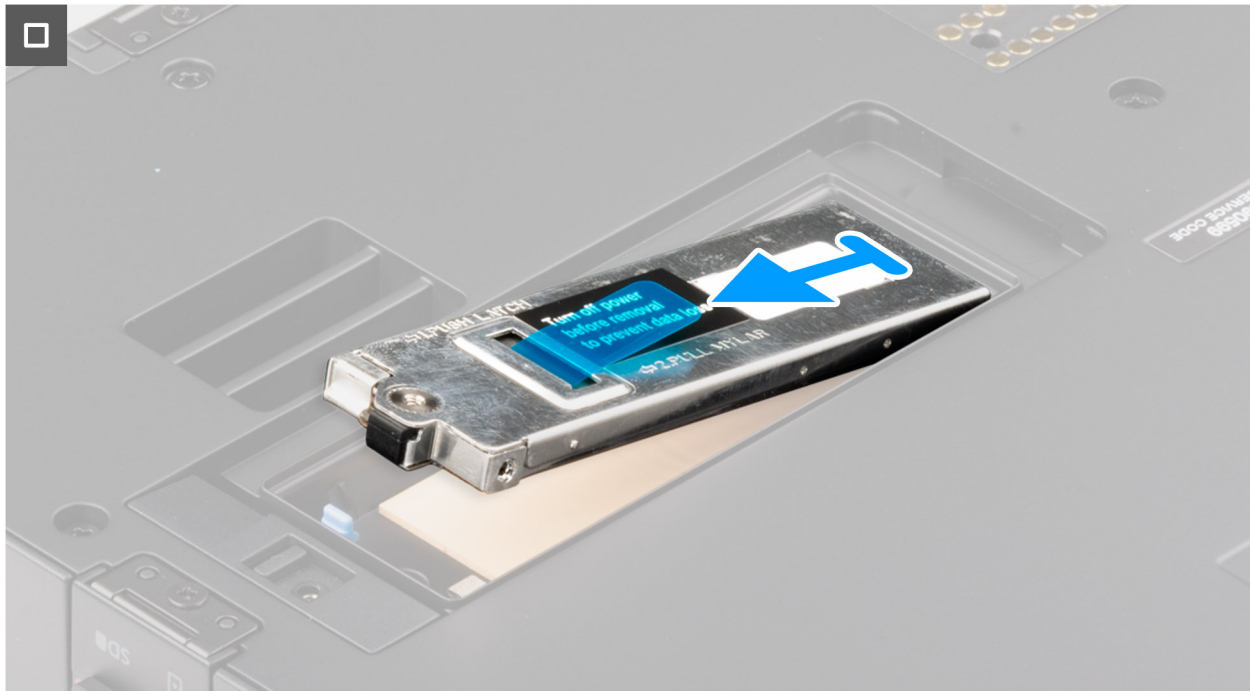

Figure 37. Removing the solid state drive carrier



**Figure 38. Removing the solid state drive carrier**

#### **Steps**

1. Remove the (M2x3) screw on the SSD door-latch cover.
2. Push the SSD latch and lift the SSD door.
3. Push the carrier latch to release the SSD carrier.
4. Pull the mylar tape to lift the SSD carrier off the computer.

## **Installing the solid state drive carrier**

**CAUTION:** The information in this installation section is intended for authorized service technicians only.

#### **Prerequisites**

If you are replacing a component, remove the existing component before performing the installation procedure.

#### **About this task**

The following image indicates the location of the solid state drive carrier and provides a visual representation of the installation procedure.



1x  
M2x3

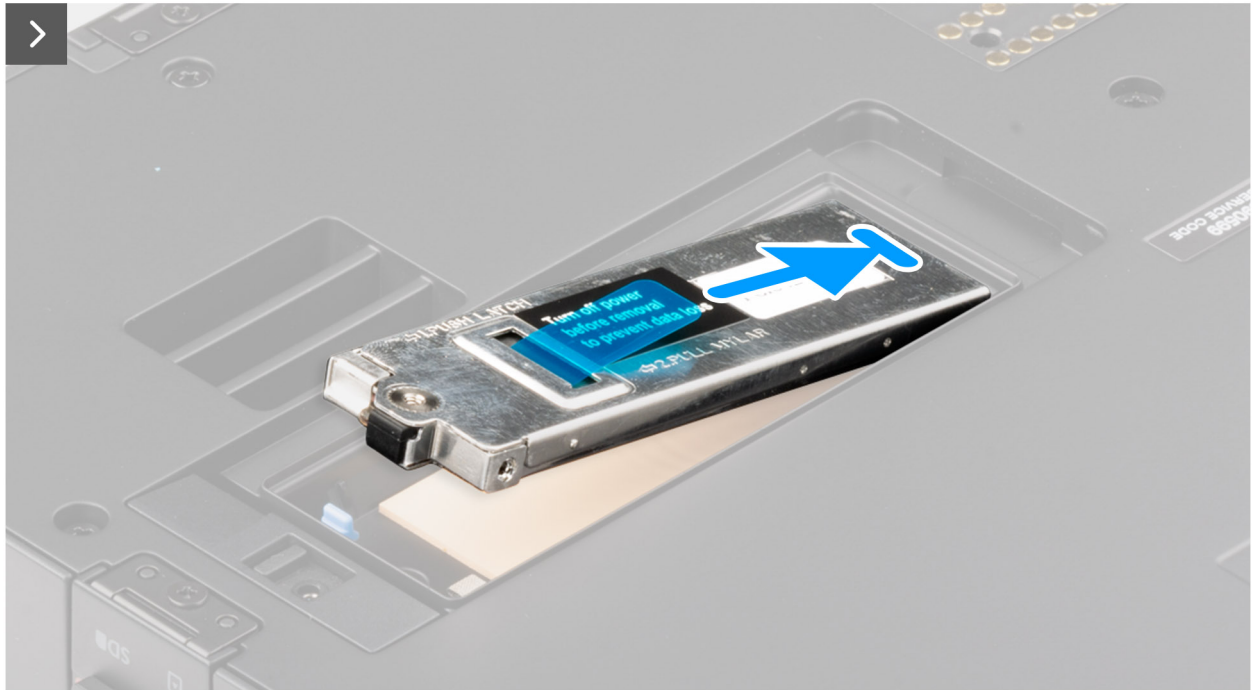
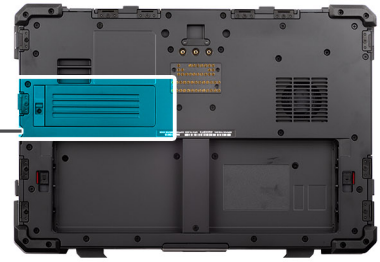
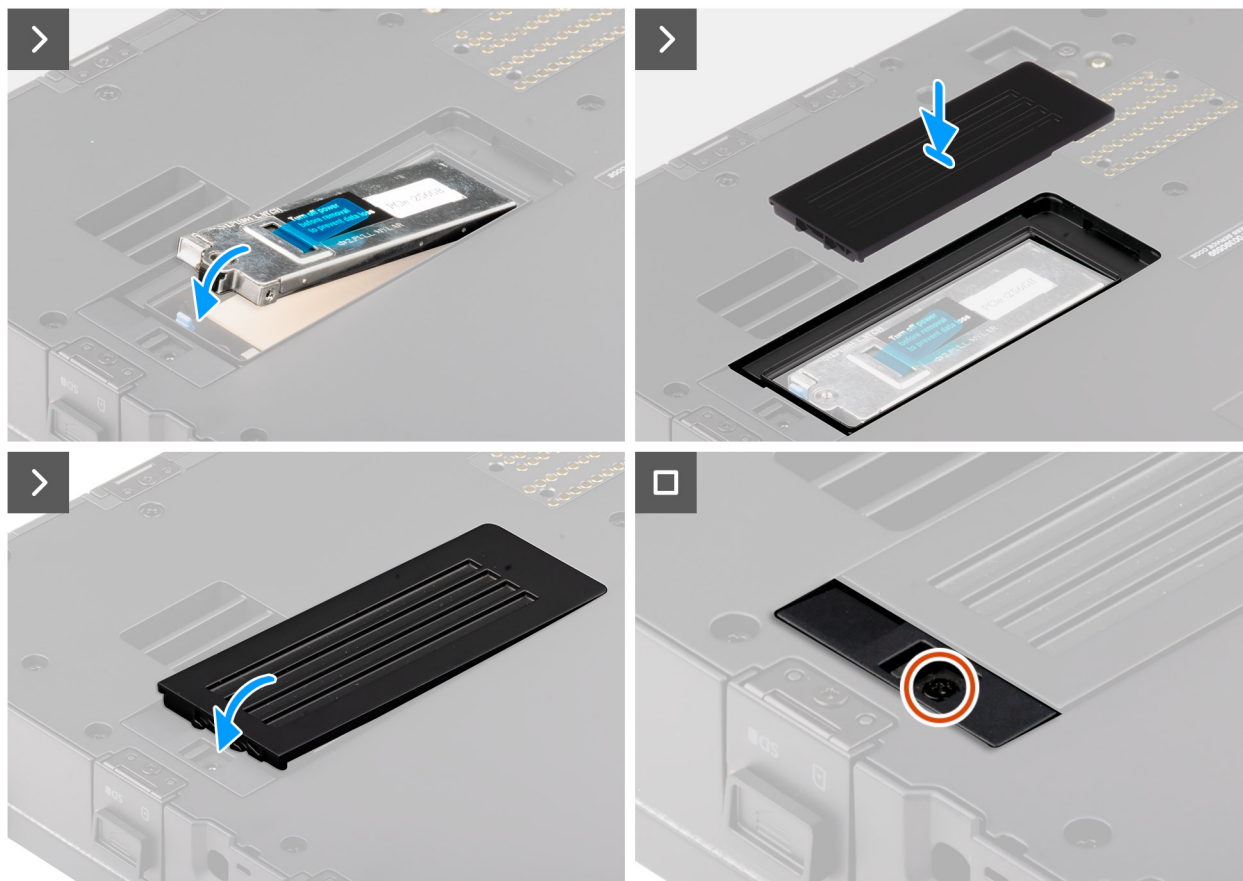

Figure 39. Installing the solid state drive carrier



**Figure 40. Installing the solid state drive carrier**

#### Steps

1. Align the notch on the SSD carrier with the tab on the M.2 slot and slide the SSD carrier into the slot on the chassis.
2. Pull the carrier latch to lock the SSD carrier.
3. Place the SSD door on the SSD carrier.
4. Replace the (M2x3) screw on the SSD door latch cover.

#### Next steps

1. Install the [batteries](#).
2. Follow the procedure in [after working inside your computer](#).

## M.2 solid state drive

### Removing the M.2 2230 solid state drive from the carrier

**CAUTION:** The information in this removal section is intended for authorized service technicians only.

#### Prerequisites

1. Follow the procedure in [before working inside your computer](#).
2. Remove the [solid state drive carrier](#).

#### About this task

The following image indicates the location of the solid state drive and provides a visual representation of the removal procedure.

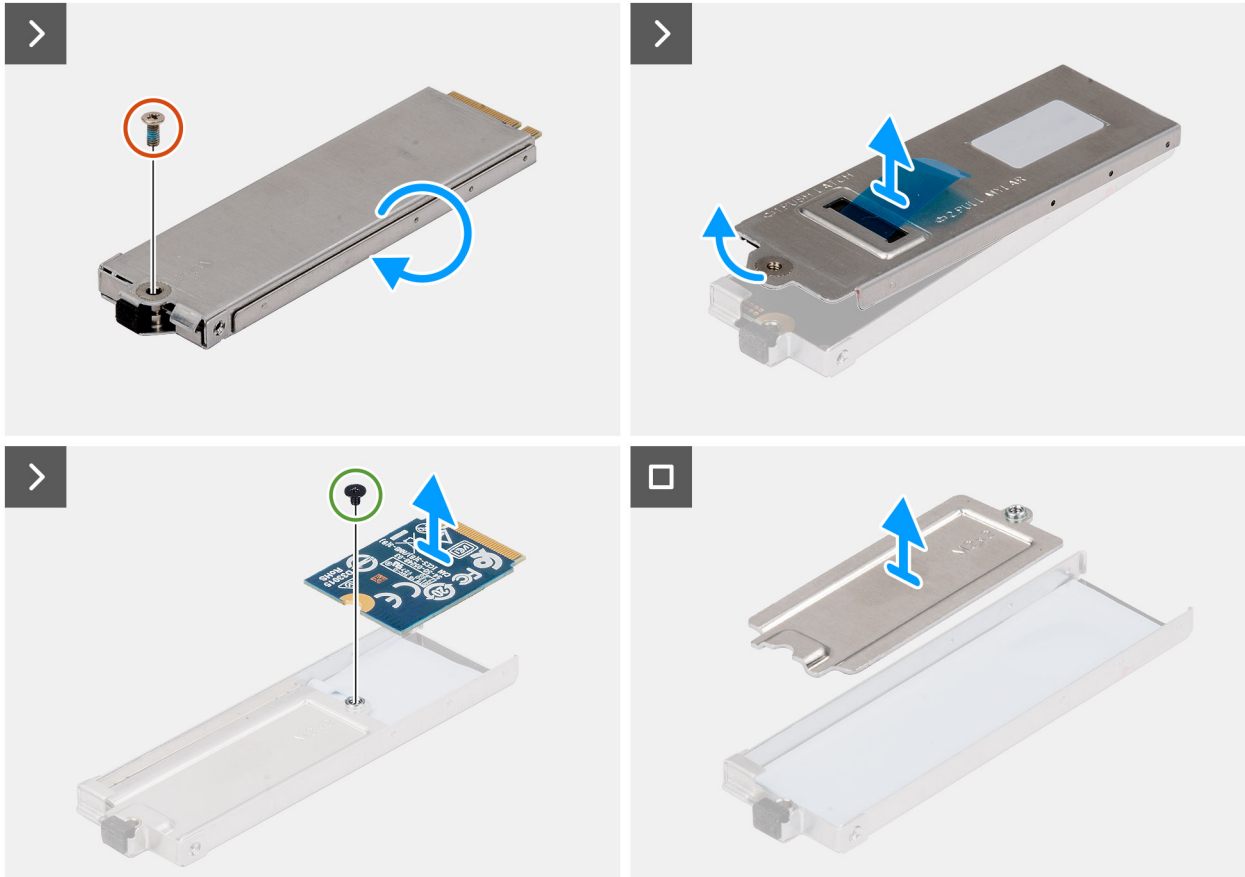
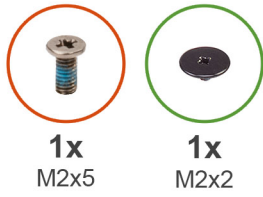

**Figure 41. Removing the M.2 2230 solid state drive from the carrier**

**Steps**

1. Flip the SSD carrier and remove the (M2x5) screw that secures the SSD carrier cover to the SSD carrier.
2. Flip the SSD carrier and pull the mylar tape to lift the SSD carrier cover.
3. Remove the (M2x2) screw that secures the M.2 2230 solid state drive to the SSD carrier.
4. Lift and remove the M.2 2230 solid state drive.
5. Lift and remove the SSD extender off the SSD carrier.

## Installing the M.2 2230 solid state drive into the carrier

**⚠ CAUTION:** The information in this installation section is intended for authorized service technicians only.

**Prerequisites**

If you are replacing a component, remove the existing component before performing the installation procedure.

### About this task

The following image indicates the location of the solid state drive and provides a visual representation of the installation procedure.

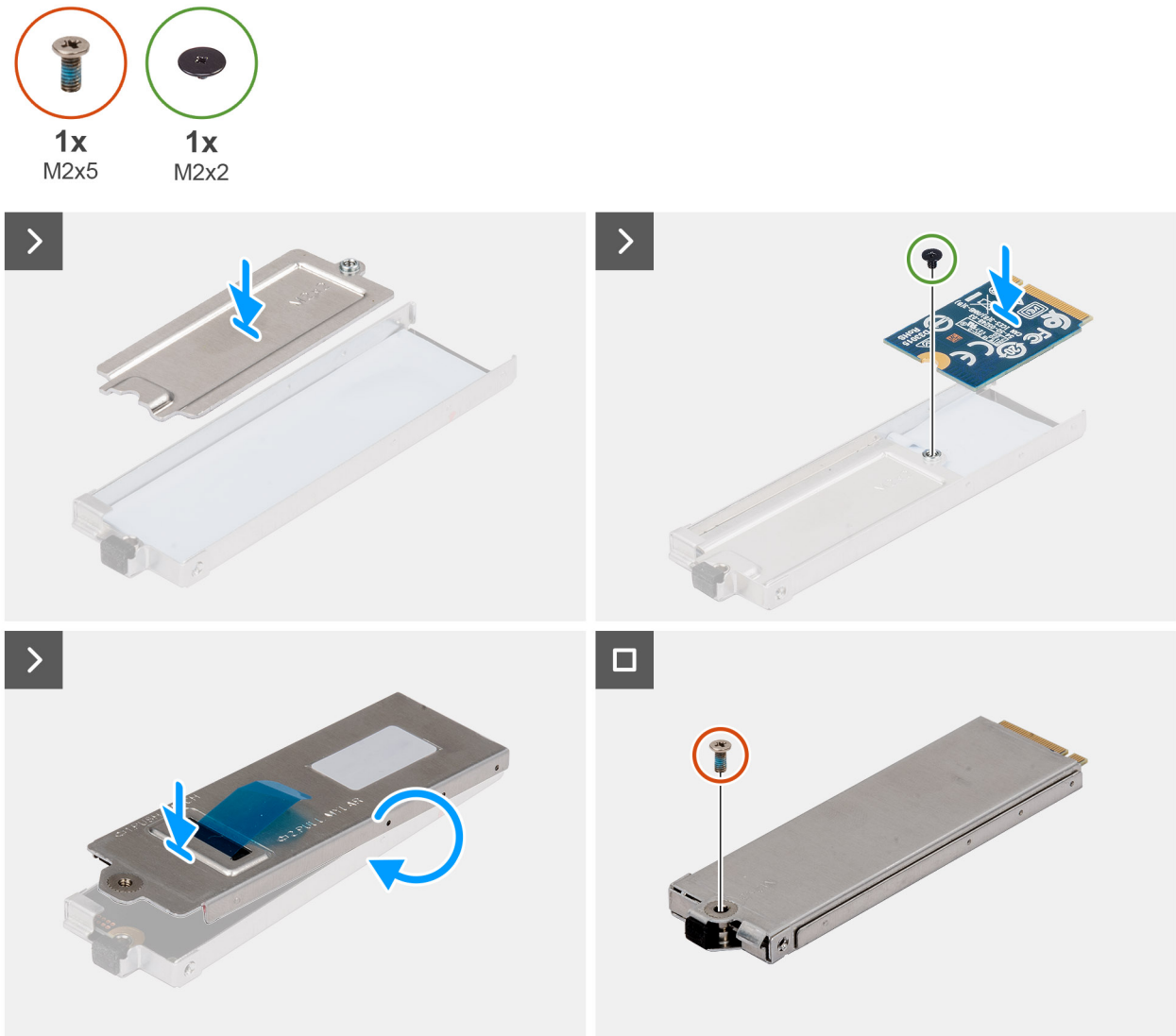

**Figure 42. Installing the M.2 2230 solid state drive into the carrier**

### Steps

1. Place the SSD extender on the SSD carrier.
2. Replace the (M2x2) screw to secure the M.2 2230 solid state drive into the SSD carrier.
3. Place the SSD carrier cover and flip the SSD carrier.
4. Replace the (M2x5) screw to secure the SSD carrier cover to the SSD carrier.

### Next steps

1. Install the [solid state drive carrier](#).
2. Follow the procedure in [after working inside your computer](#).

# Removing the M.2 2280 solid state drive from the carrier

## Prerequisites

1. Follow the procedure in [before working inside your computer](#).
2. Remove the [solid state drive carrier](#).

## About this task

The following image indicates the location of the solid state drive and provides a visual representation of the removal procedure.

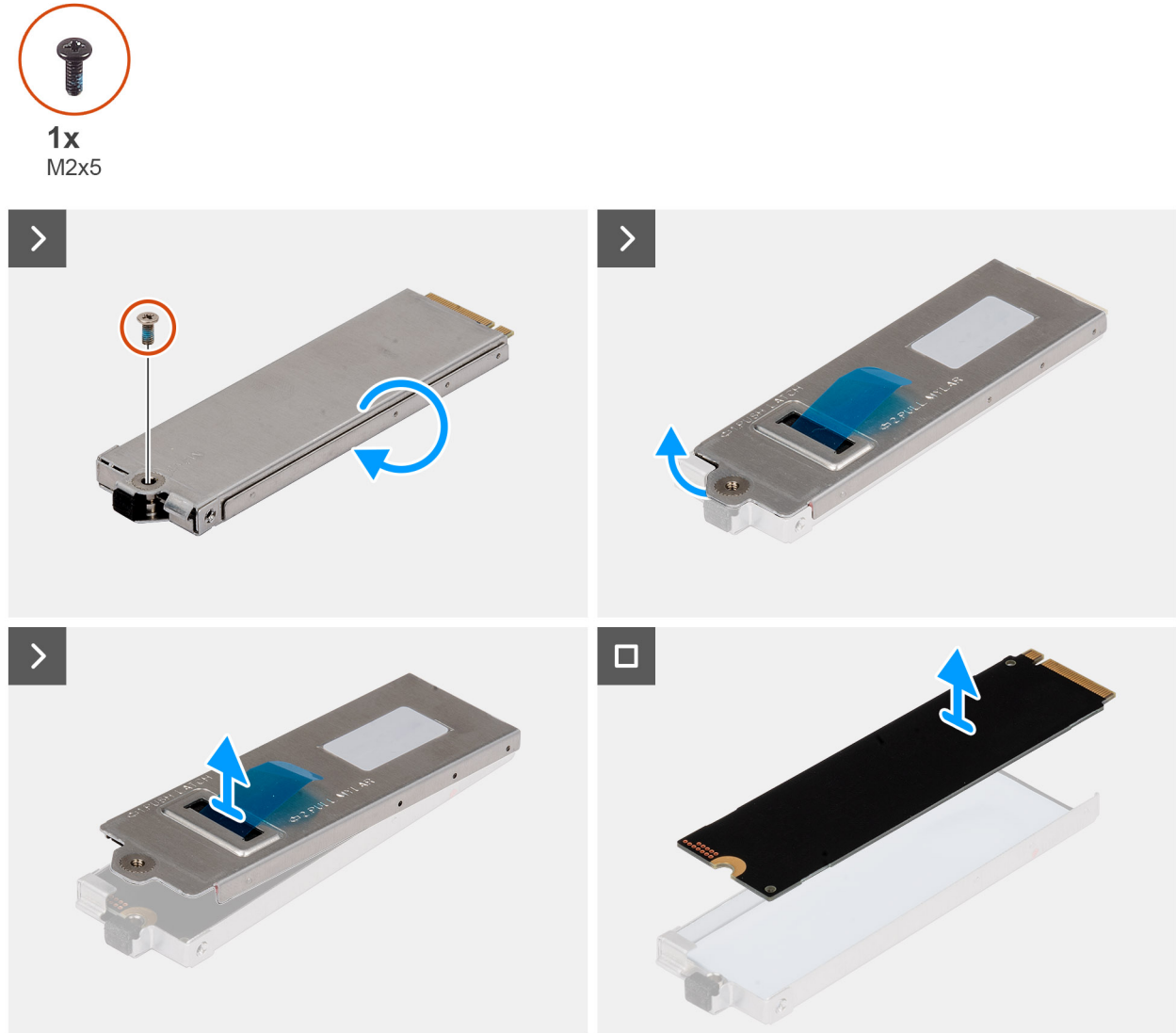

Figure 43. Removing the M.2 2280 solid state drive from the carrier

## Steps

1. Flip the SSD carrier and remove the (M2x5) screw that secures the SSD carrier cover to the SSD carrier.
2. Flip the SSD carrier and pull the mylar tape to lift the SSD carrier cover.
3. Lift and remove the M.2 2280 solid state drive from the SSD carrier.

# Installing the M.2 2280 solid state drive into the carrier

**CAUTION:** The information in this installation section is intended for authorized service technicians only.

## Prerequisites

If you are replacing a component, remove the existing component before performing the installation procedure.

## About this task

The following image indicates the location of the solid state drive and provides a visual representation of the installation procedure.

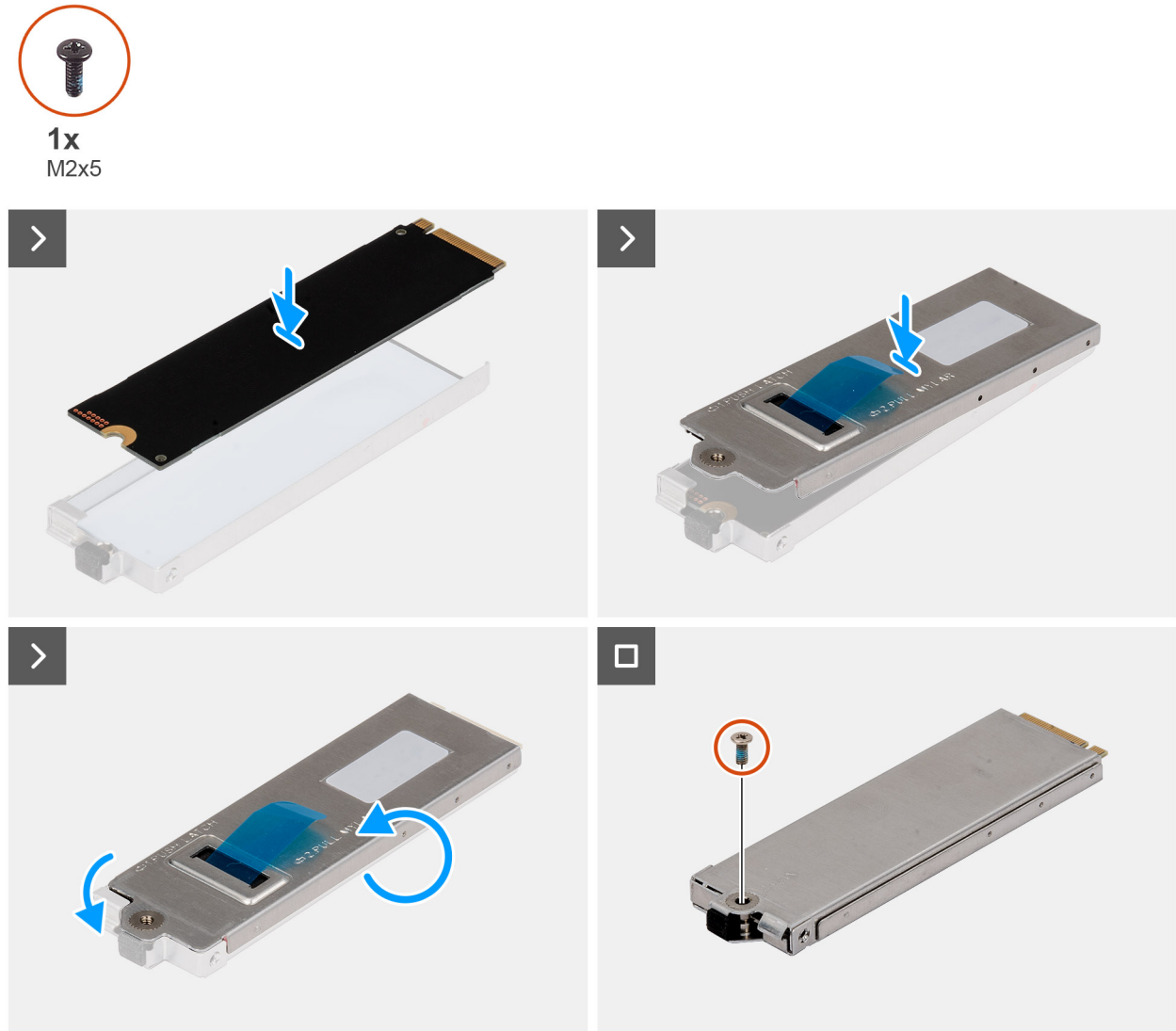

**Figure 44. Installing the M.2 2280 solid state drive into the carrier**

## Steps

1. Place the M.2 2280 solid state drive into the SSD carrier.
2. Place the SSD carrier cover.
3. Flip the SSD carrier.
4. Replace the (M2x5) screw to secure the SSD carrier cover to the SSD carrier.

## Next steps

1. Install the [solid state drive carrier](#).
2. Follow the procedure in [after working inside your computer](#).

# Base cover

## Removing the base cover

**CAUTION:** The information in this removal section is intended for authorized service technicians only.

### Prerequisites

1. Follow the procedure in [before working inside your computer](#).
2. Remove the [batteries](#).
3. Remove the [solid state drive carrier](#).

### About this task

The following images indicate the location of the base cover and provide a visual representation of the removal procedure.

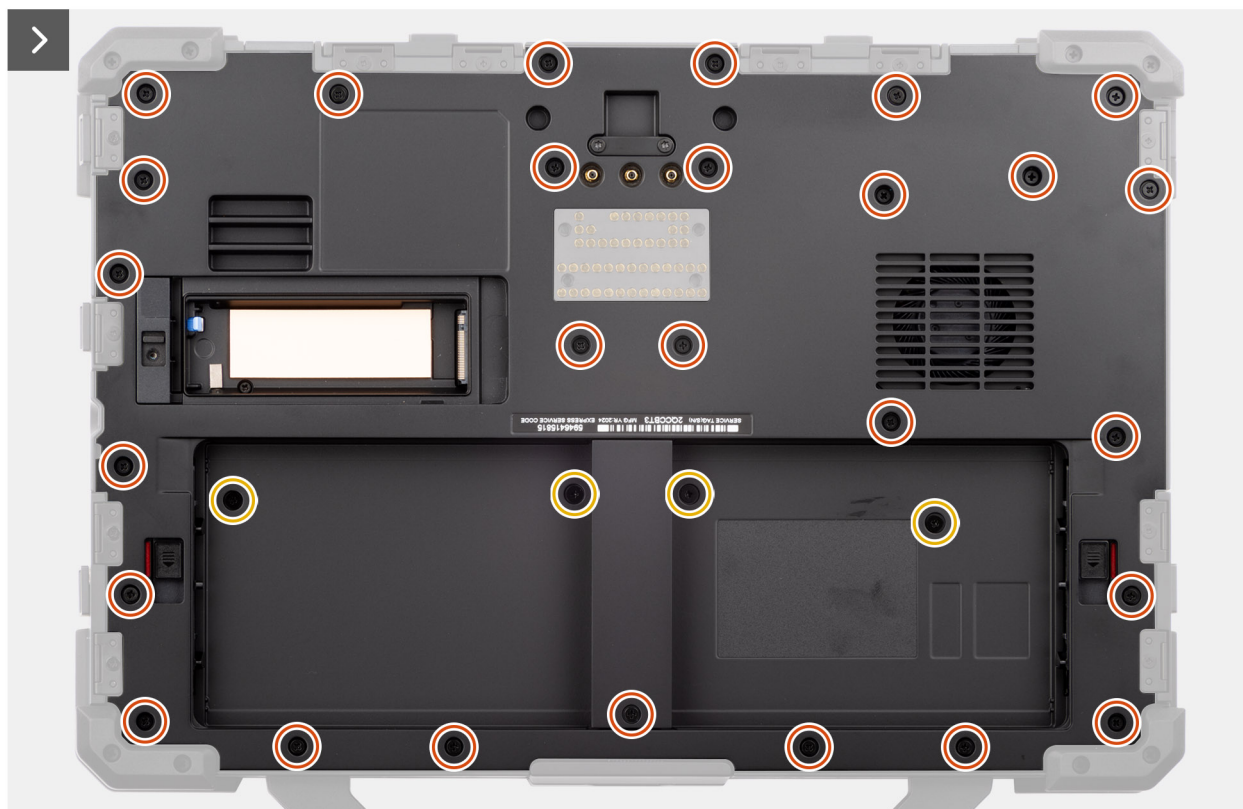

Figure 45. Removing the base cover

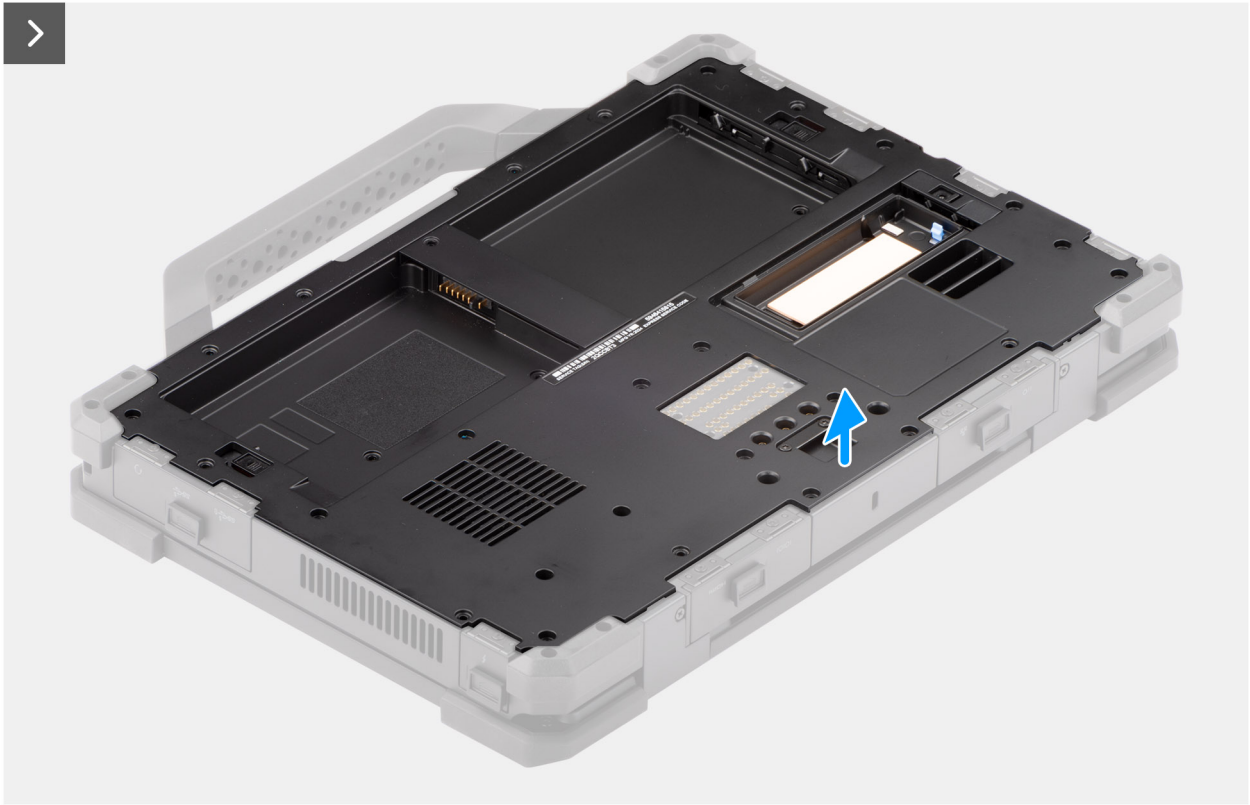

Figure 46. Removing the base cover

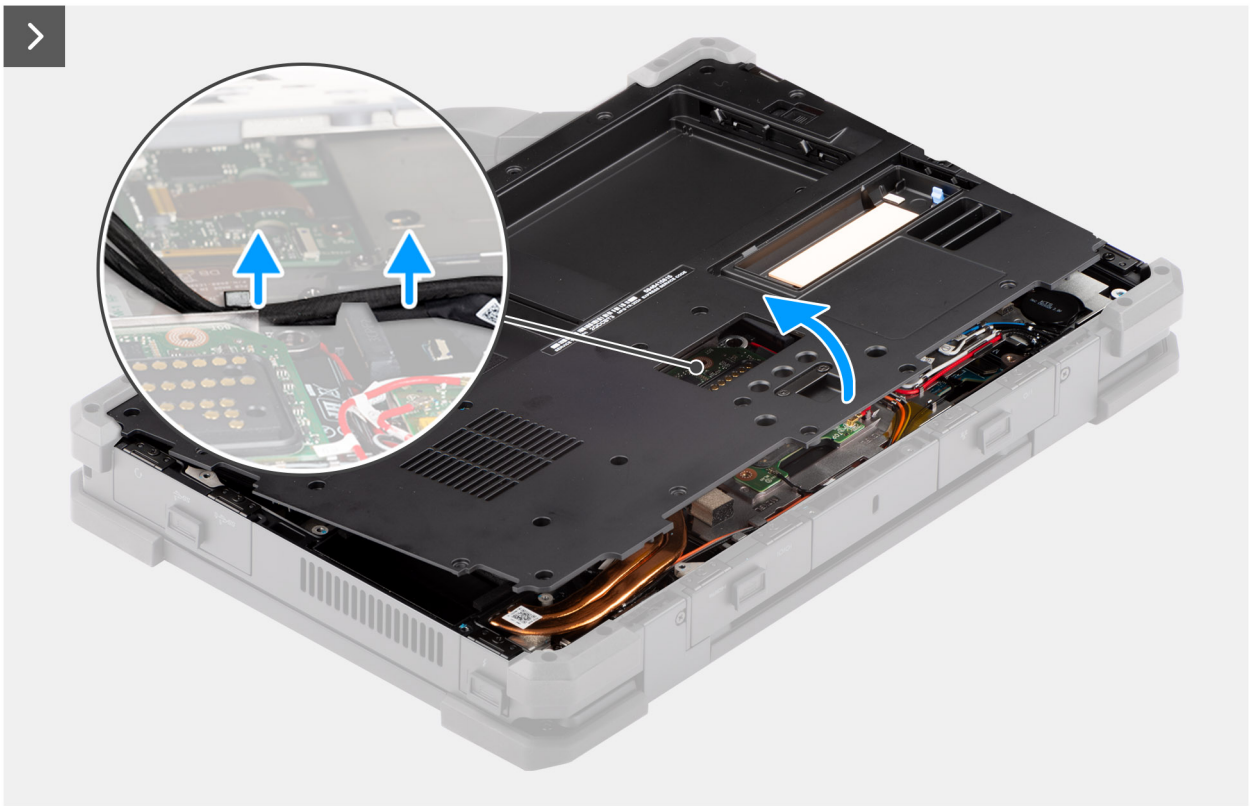
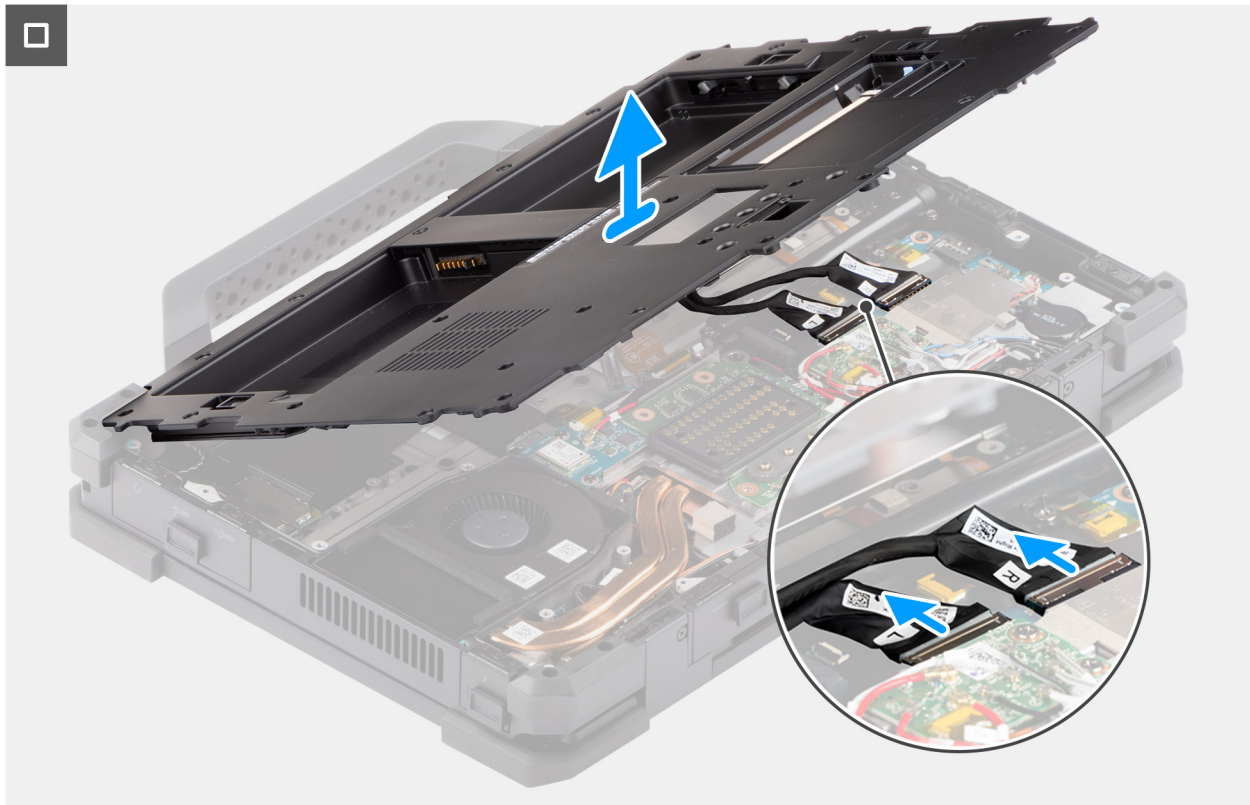

Figure 47. Removing the base cover



**Figure 48. Removing the base cover**

#### Steps

1. Remove the 27 (M2.5x5) and four (M2x3) screws that secure the base cover to the computer chassis.
2. Lift the base cover slightly to unrout the left and right battery cables from the computer chassis.
3. Disconnect the left and right battery cables from the connectors on the system board.
4. Lift the base cover from the computer chassis.

## Installing the base cover

**CAUTION:** The information in this installation section is intended for authorized service technicians only.

#### Prerequisites

If you are replacing a component, remove the existing component before performing the installation procedure.

#### About this task

The following image indicates the location of the base cover and provides a visual representation of the installation procedure.



27x  
M2.5x5



4x  
M2x3

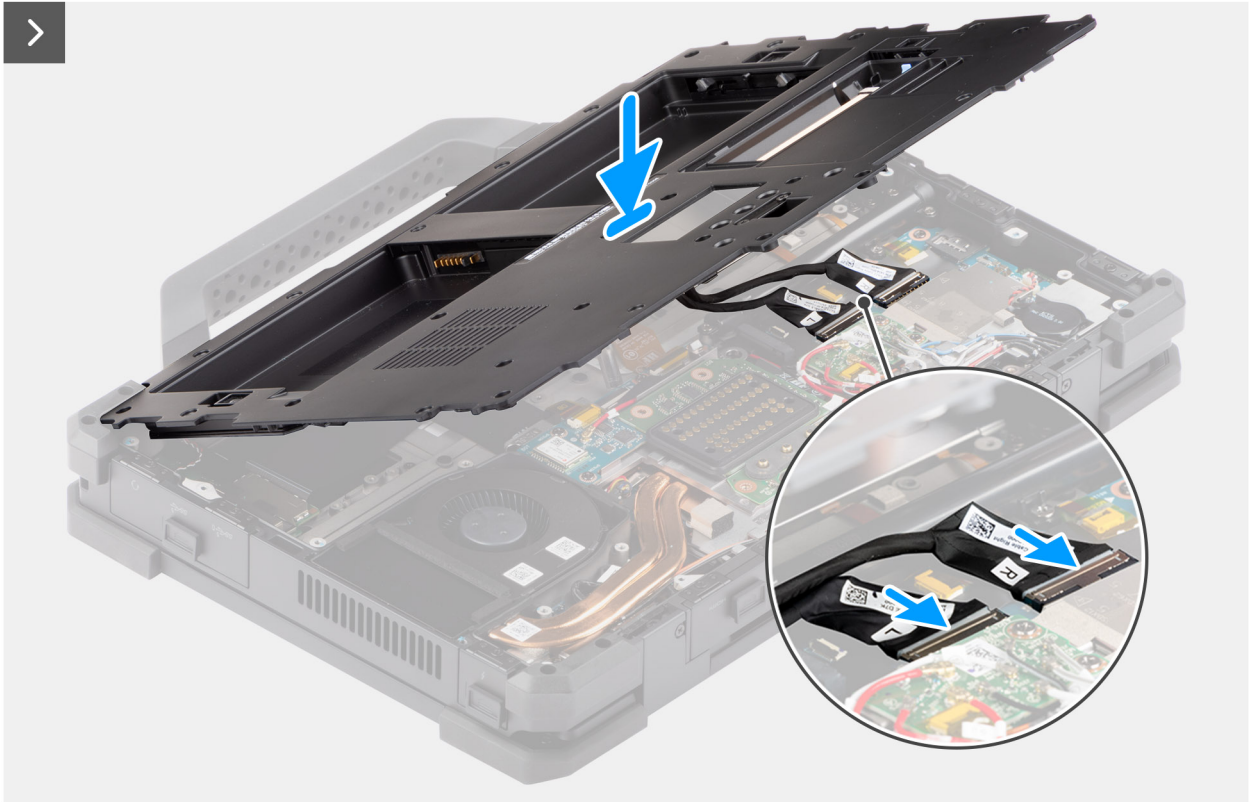

Figure 49. Installing the base cover

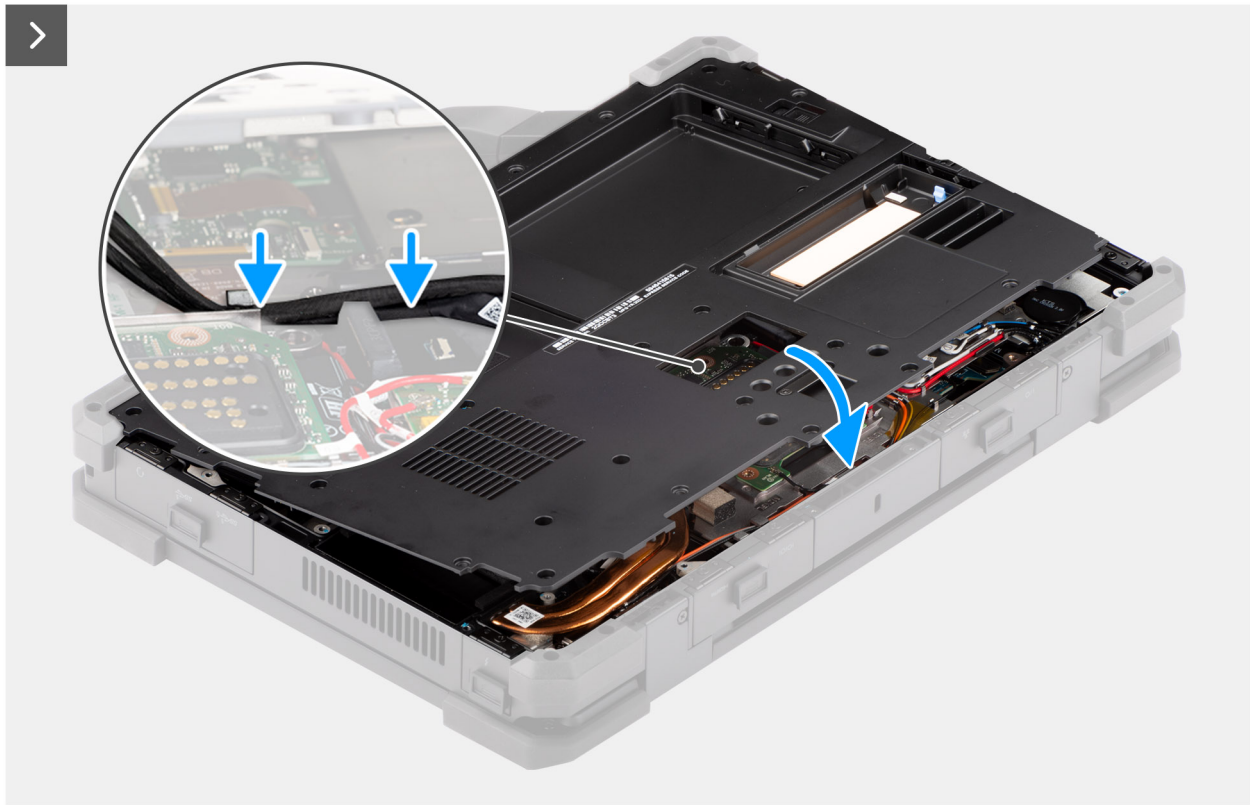

Figure 50. Installing the base cover

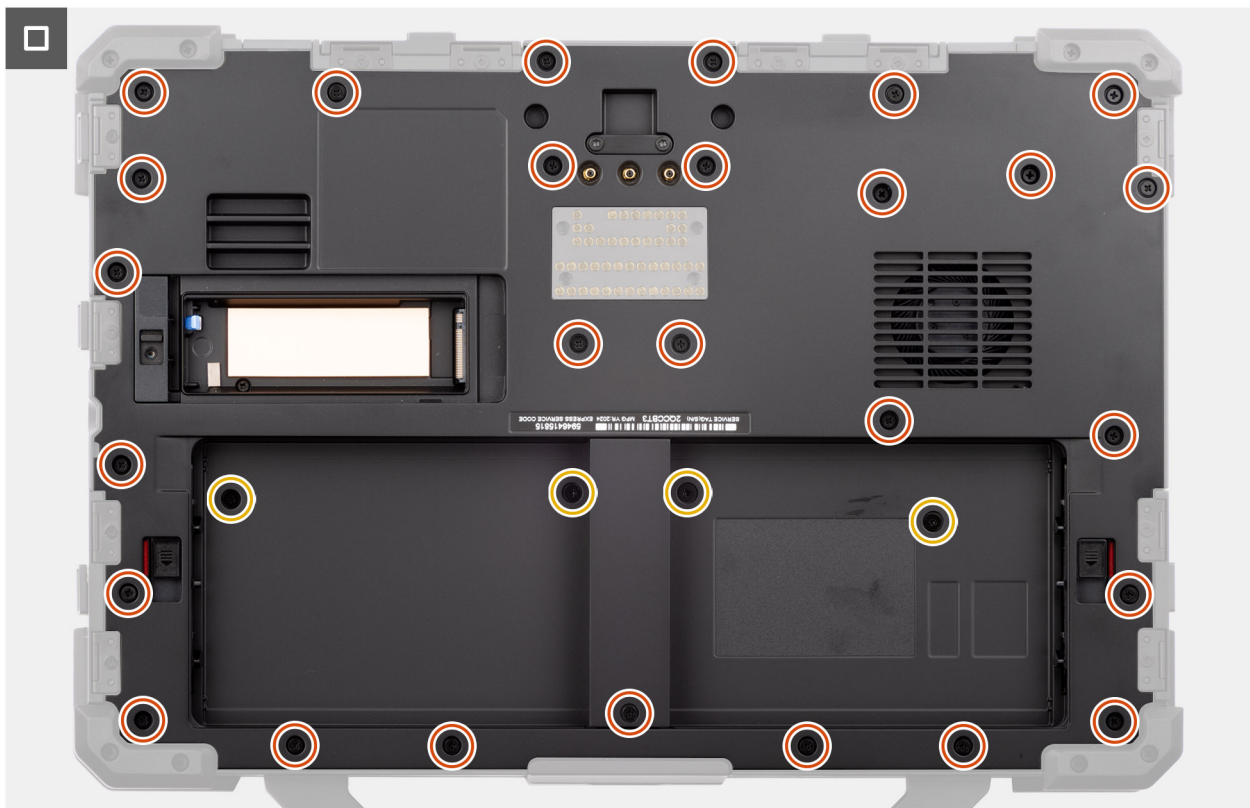

Figure 51. Installing the base cover

### Steps

1. Place the base cover at an angle on the computer chassis, then route the battery cables along the designated chassis slot.
2. Connect the left and right battery cables to the connectors on the system board.
3. Replace the 27 (M2.5x5) and four (M2.5x3) screws that secure the base cover to the computer chassis.

### Next steps

1. Install the [solid state drive carrier](#).
2. Install the [batteries](#).
3. Follow the procedure in [after working inside your computer](#).

## Stylus holder

### Removing the stylus holder

 **CAUTION:** The information in this removal section is intended for authorized service technicians only.

#### Prerequisites

1. Follow the procedure in [before working inside your computer](#).
2. Remove the [stylus](#).
3. Remove the [batteries](#).
4. Remove the [solid state drive carrier](#).
5. Remove the [base cover](#).

#### About this task

The following image indicates the location of the stylus holder and provides a visual representation of the removal procedure.



4x  
M2x3

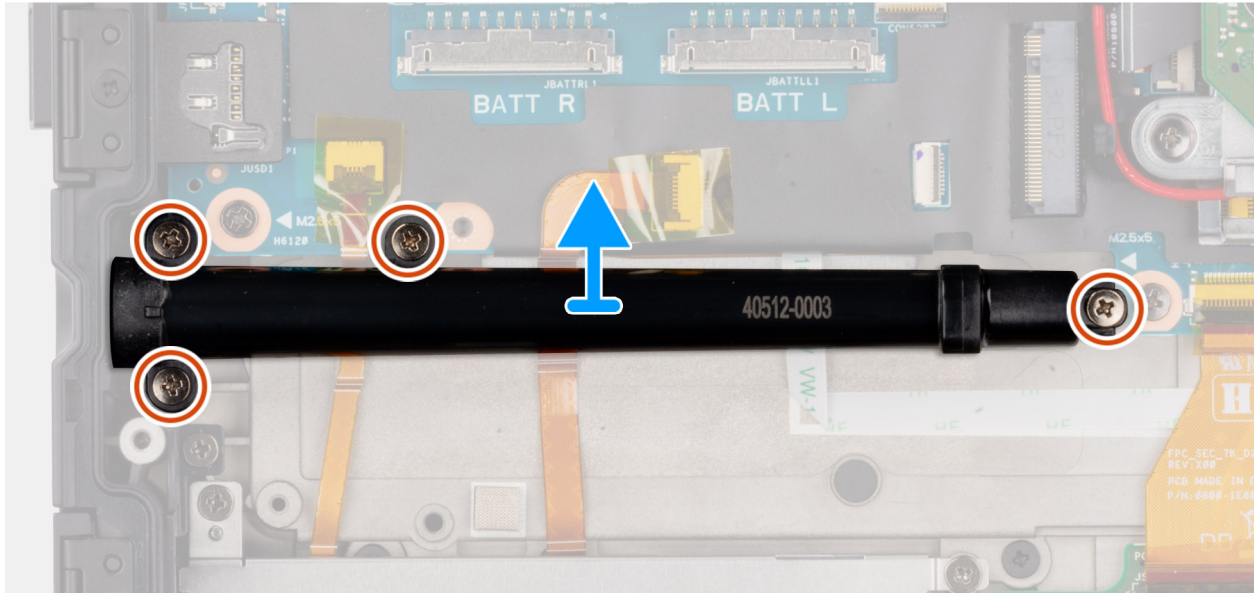
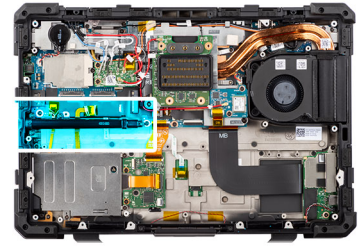

Figure 52. Removing the stylus holder

### Steps

1. Remove the four (M2x3) screws that secure the stylus holder to the computer chassis.
2. Lift the stylus holder from the computer chassis.

## Installing the stylus holder

**CAUTION:** The information in this installation section is intended for authorized service technicians only.

### Prerequisites

If you are replacing a component, remove the existing component before performing the installation procedure.

### About this task

The following image indicates the location of the stylus holder and provides a visual representation of the installation procedure.



4x  
M2x3

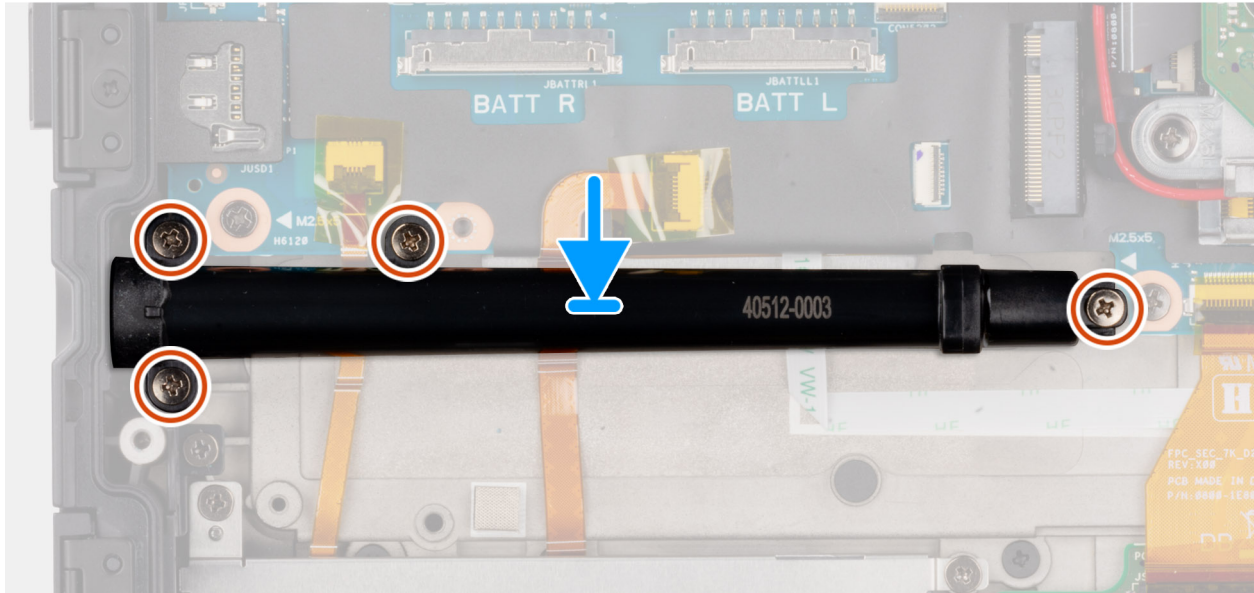
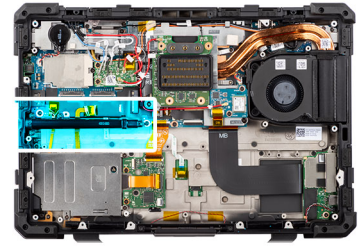

Figure 53. Installing the stylus holder

#### Steps

1. Align the screw holes on the stylus holder with the screw holes on the computer chassis.
2. Replace the four (M2x3) screws to secure the stylus holder to the computer chassis.

#### Next steps

1. Install the [base cover](#).
2. Install the [solid state drive carrier](#).
3. Install the [batteries](#).
4. Install the [stylus](#).
5. Follow the procedure in [after working inside your computer](#).

## Coin-cell battery

### Removing the coin-cell battery

**CAUTION:** The information in this removal section is intended for authorized service technicians only.

#### Prerequisites

1. Follow the procedure in [before working inside your computer](#).

**CAUTION:** Removing the coin-cell battery resets the BIOS setup program settings to default. It is recommended that you note the BIOS setup program settings before removing the coin-cell battery.

2. Remove the [batteries](#).

3. Remove the [solid state drive carrier](#).
4. Remove the [base cover](#).

**About this task**

The following images indicate the location of the coin-cell battery and provide a visual representation of the removal procedure.

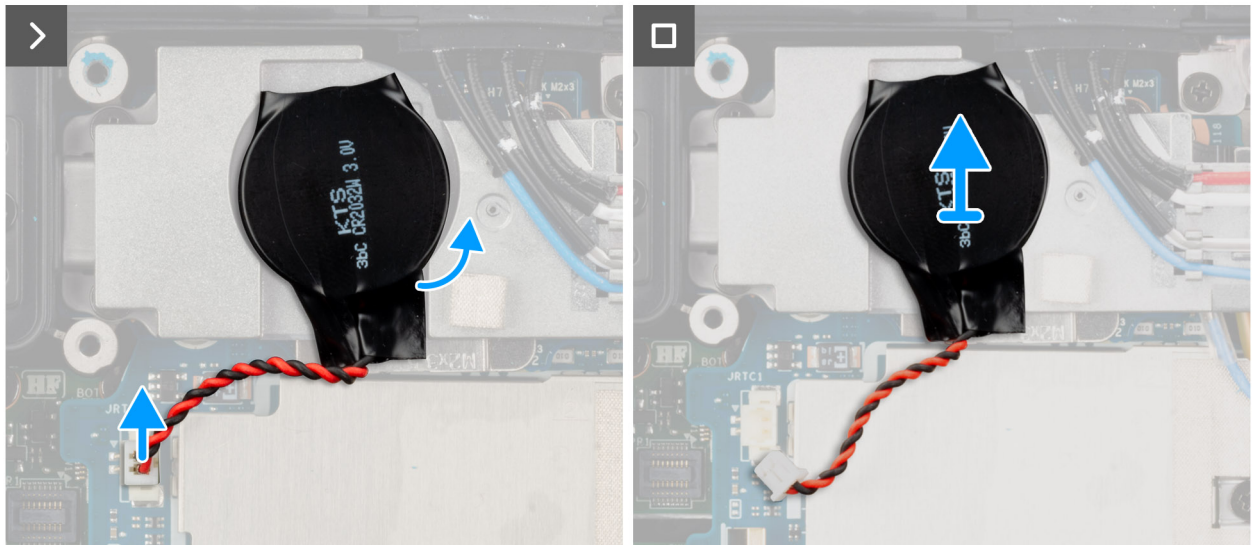
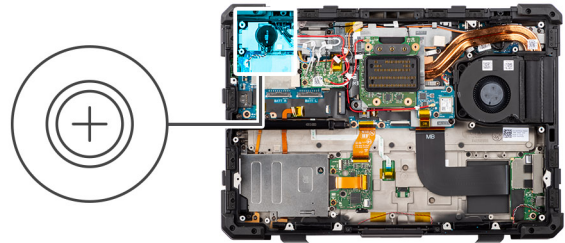

**Figure 54. Removing the coin-cell battery**

**Steps**

1. Disconnect the coin-cell battery cable from the system board.
2. Peel the coin-cell battery off the computer chassis.

## Installing the coin-cell battery

**⚠ CAUTION:** The information in this installation section is intended for authorized service technicians only.

**Prerequisites**

If you are replacing a component, remove the existing component before performing the installation procedure.

**About this task**

The following image indicates the location of the coin-cell battery and provides a visual representation of the installation procedure.

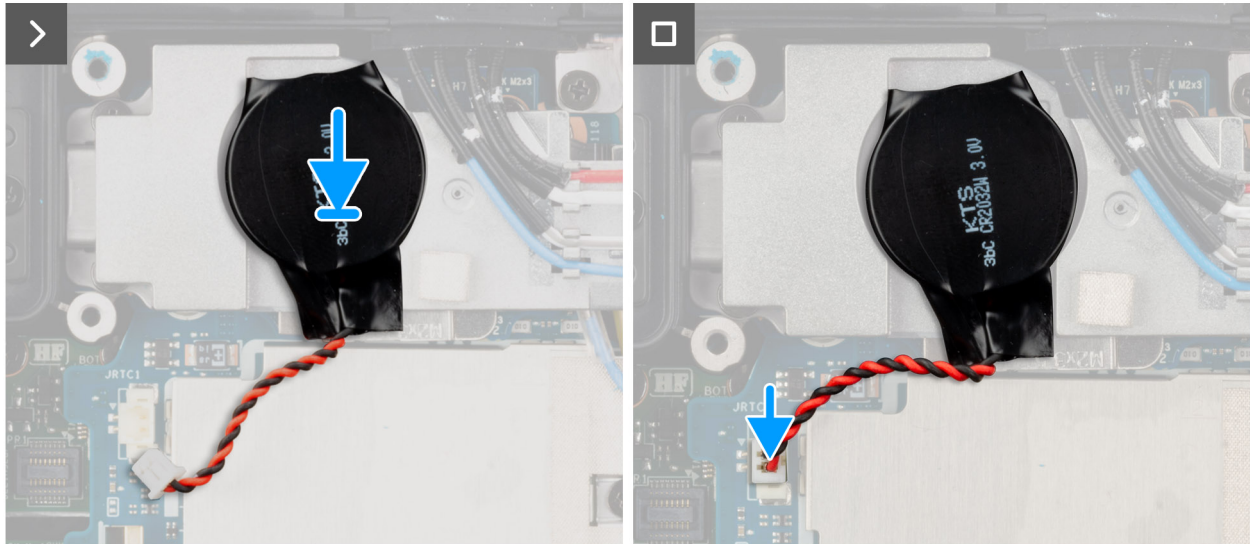
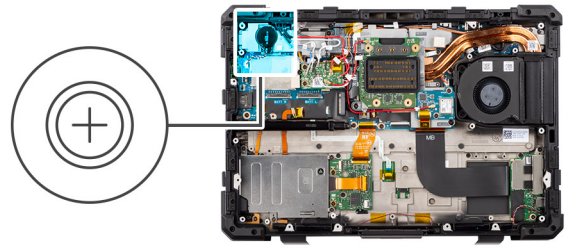

**Figure 55. Installing the coin-cell battery**

**Steps**

1. Adhere the coin-cell battery to the slot on the computer chassis.
2. Connect the coin-cell battery cable to the connector on the system board.

**Next steps**

1. Install the [base cover](#).
2. Install the [solid state drive carrier](#).
3. Install the [batteries](#).
4. Follow the procedure in [after working inside your computer](#).

## Fan

### Removing the fan

**CAUTION:** The information in this removal section is intended for authorized service technicians only.

**Prerequisites**

1. Follow the procedure in [before working inside your computer](#).
2. Remove the [batteries](#).
3. Remove the [solid state drive carrier](#).
4. Remove the [base cover](#).

**About this task**

The following image indicates the location of the fan and provides a visual representation of the removal procedure.



3x  
M2.5x5

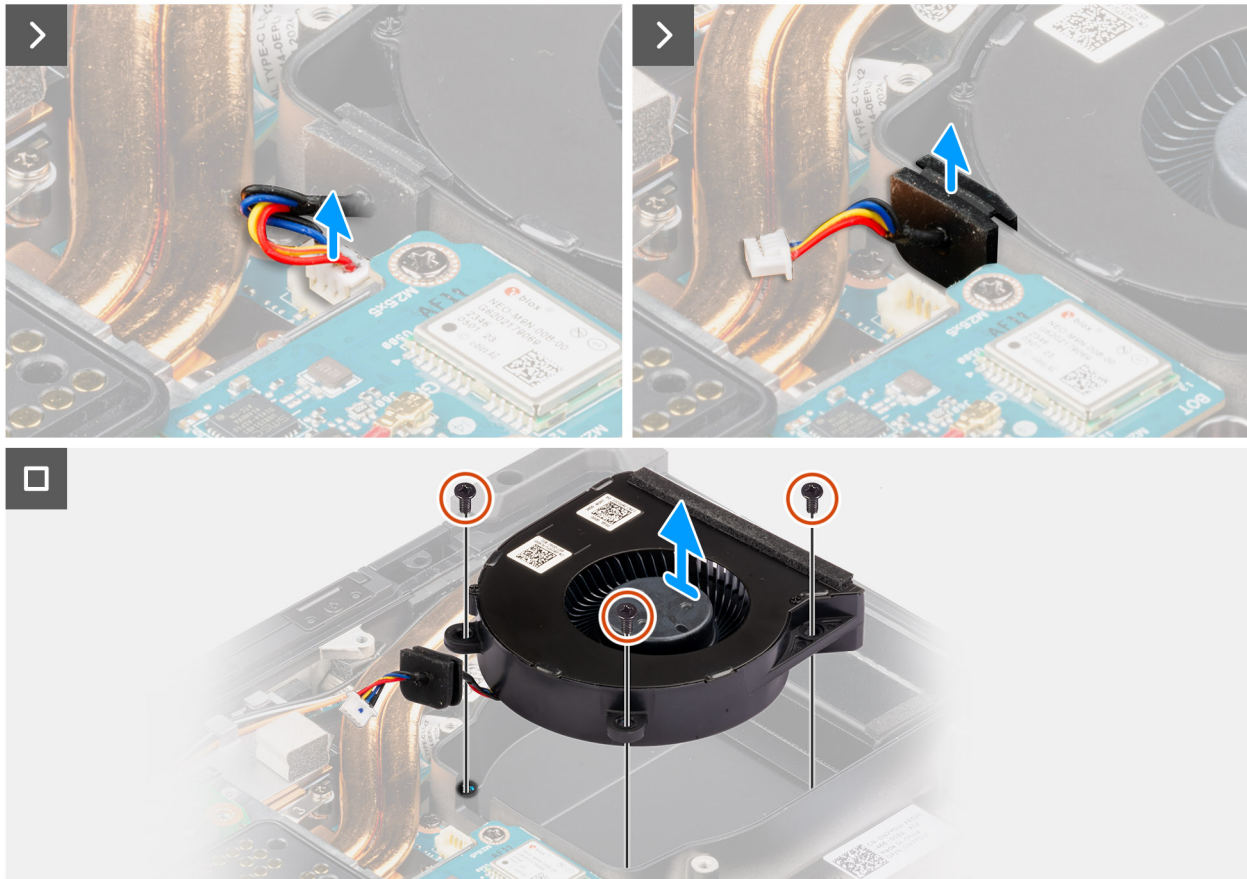
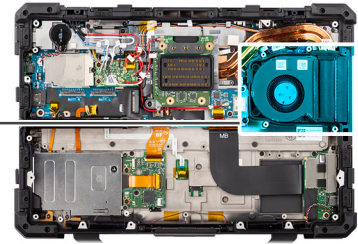
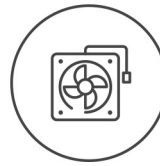

Figure 56. Removing the fan

### Steps

1. Disconnect the fan cable from its connector on the system board.
2. Remove the fan cable connector clip from the chassis.
3. Remove the three (M2.5x5) screws that secure the fan to the computer chassis.
4. Lift the fan from the computer chassis.

## Installing the fan

**CAUTION:** The information in this installation section is intended for authorized service technicians only.

### Prerequisites

If you are replacing a component, remove the existing component before performing the installation procedure.

### About this task

The following image indicates the location of the fan and provides a visual representation of the installation procedure.



**3x**  
M2.5x5

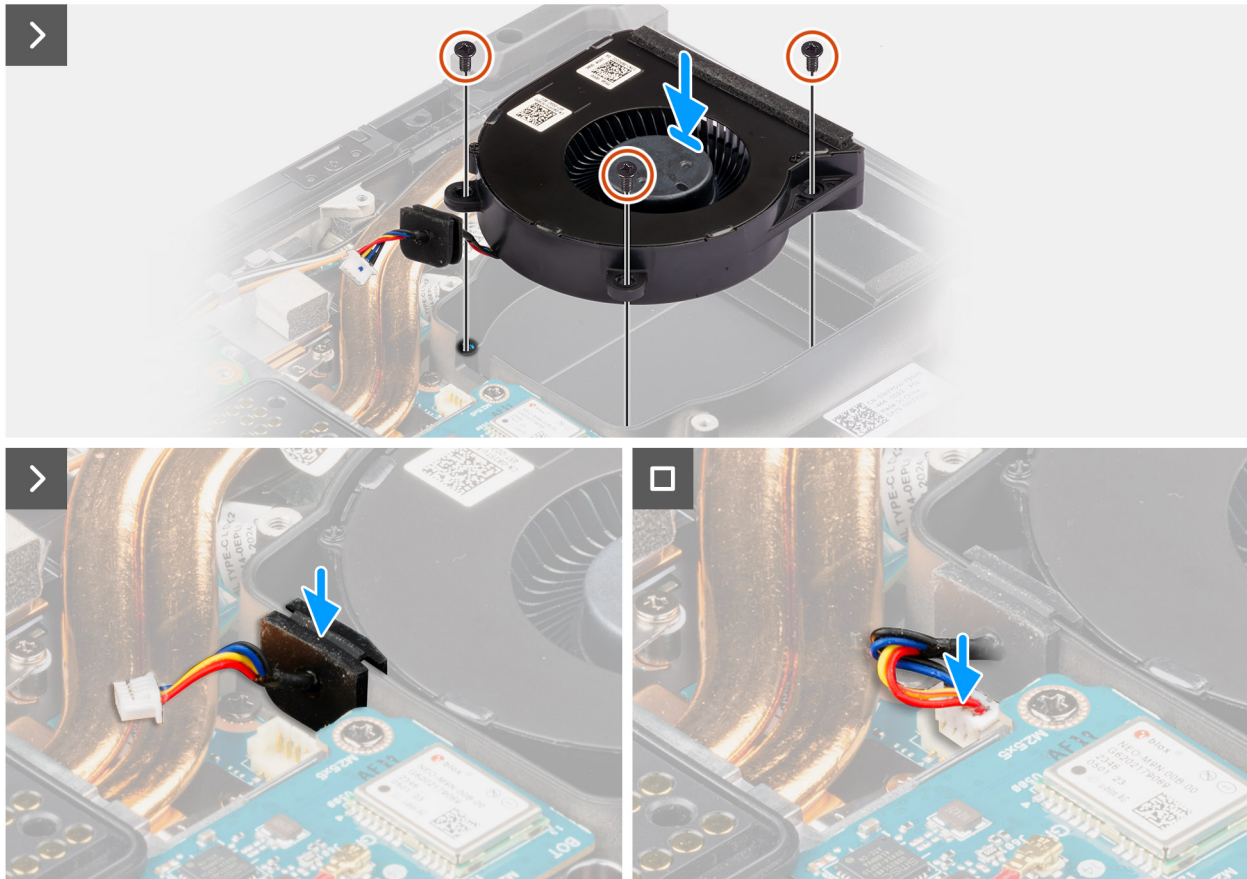
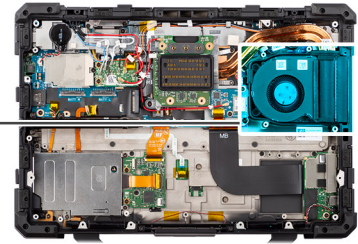
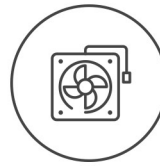

**Figure 57. Installing the fan**

### Steps

1. Place the fan on the computer chassis.
2. Connect the fan cable connector clip to the chassis.
3. Connect the fan cable to its connector on the system board.
4. Replace the three (M2.5x5) screws that secure the fan to the computer chassis.

### Next steps

1. Install the [base cover](#).
2. Install the [solid state drive carrier](#).
3. Install the [batteries](#).
4. Follow the procedure in [after working inside your computer](#).

# Global Positioning System (GPS) board

## Removing the GPS board

**CAUTION:** The information in this removal section is intended for authorized service technicians only.

### Prerequisites

1. Follow the procedure in [before working inside your computer](#).
2. Remove the [batteries](#).
3. Remove the [solid state drive carrier](#).
4. Remove the [base cover](#).

### About this task

The following image indicates the location of the GPS board and provides a visual representation of the removal procedure.

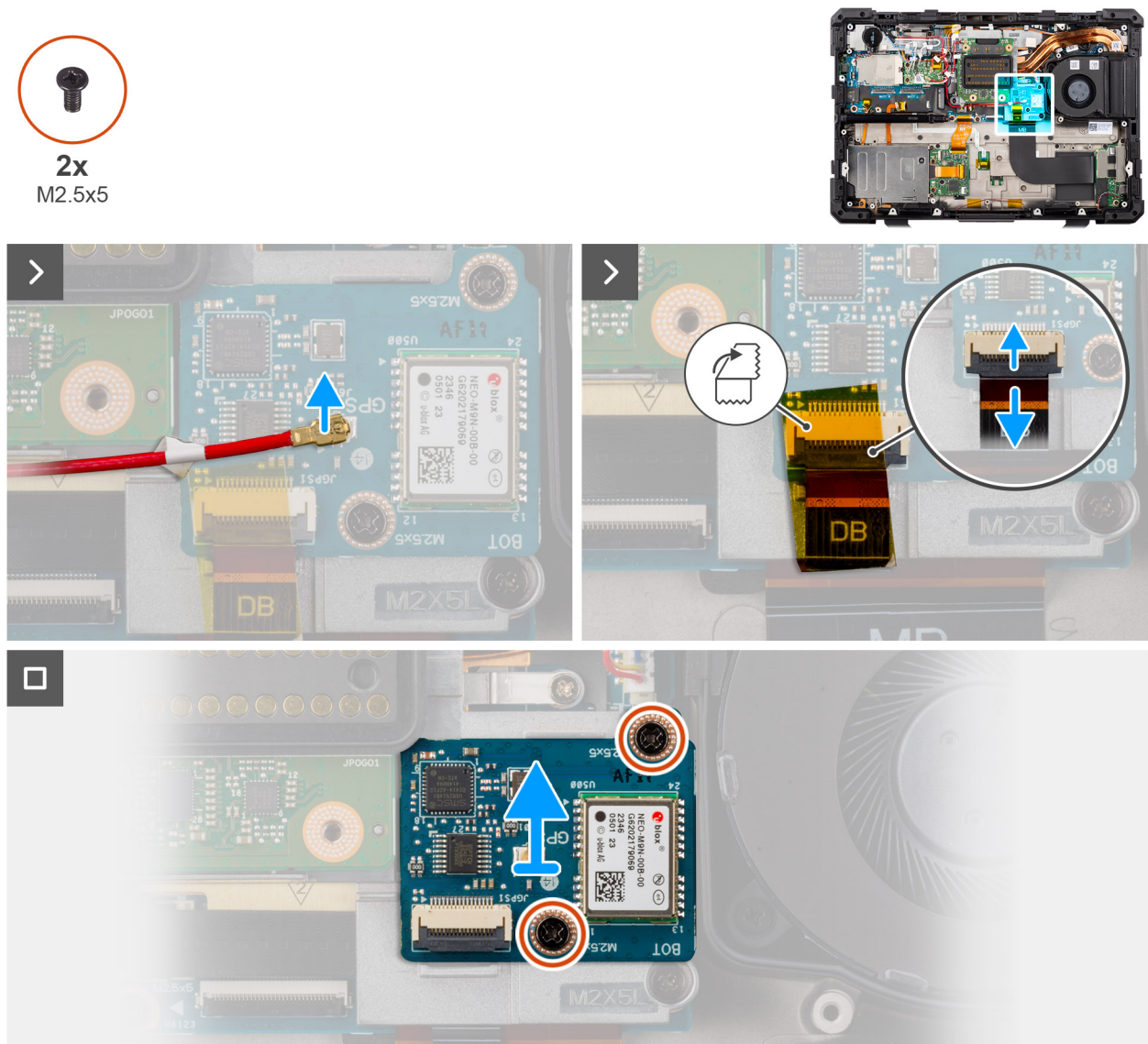

Figure 58. Removing the GPS board

## Steps

1. Disconnect the GPS antenna cable on the GPS board.
2. Disconnect the GPS flat-printed cable from the connector on the GPS board.
3. Remove the two (M2.5x5) screws that secure the GPS board to the computer chassis.
4. Lift the GPS board from the computer chassis.

## Installing the GPS board

**⚠ CAUTION:** The information in this installation section is intended for authorized service technicians only.

### Prerequisites

If you are replacing a component, remove the existing component before performing the installation procedure.

### About this task

The following image indicates the location of the GPS board and provides a visual representation of the installation procedure.

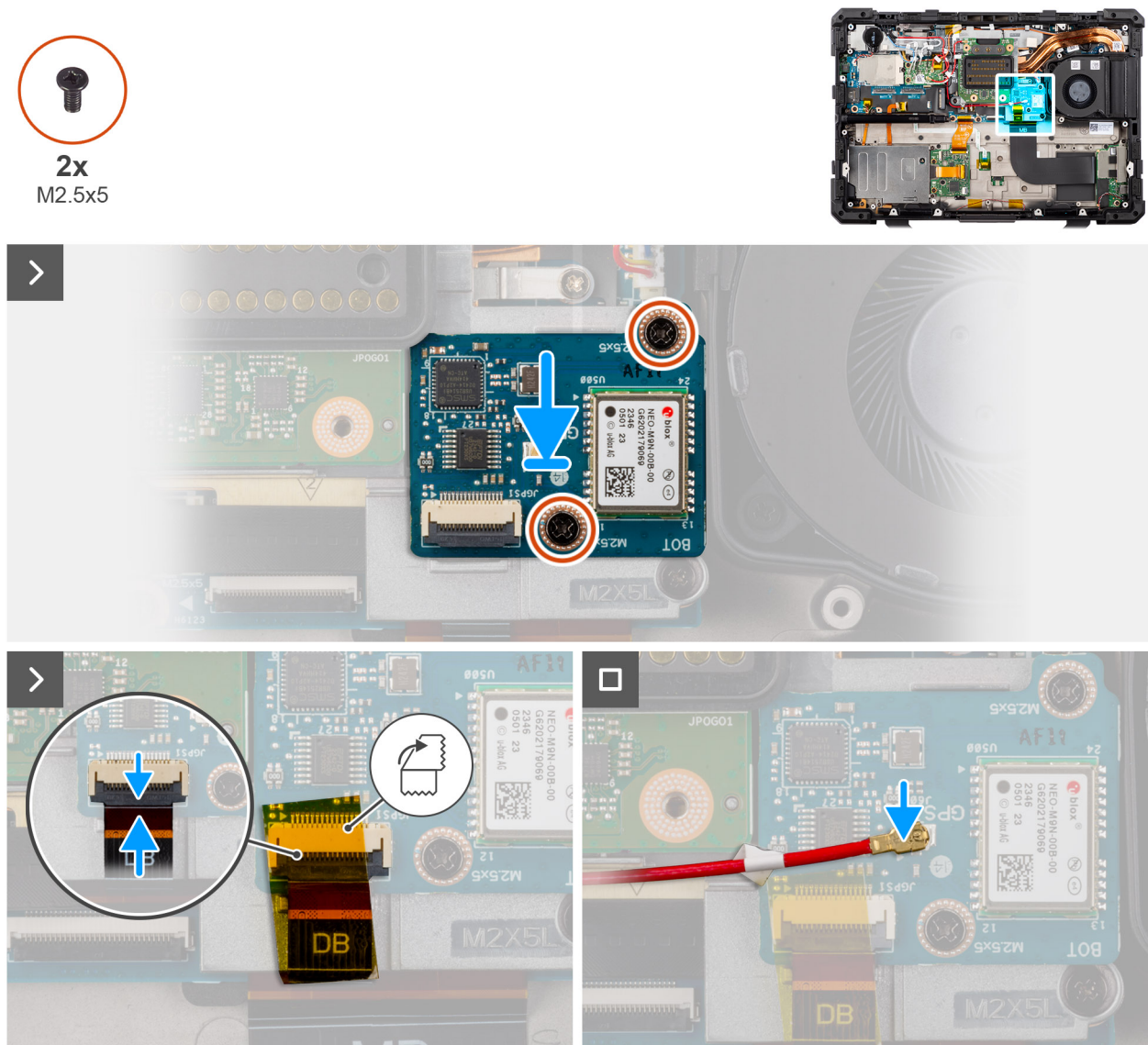



Figure 59. Installing the GPS board

### Steps

1. Align the screw holes on the GPS board with the screw holes on the system board.
2. Replace the two (M2.5x5) screws that secure the GPS board with the computer chassis.
3. Connect the GPS flat-printed cable to the connector on the GPS board.
4. Connect the GPS antenna cable on the GPS board.

 **NOTE:** Adhere the GPS flat printed cable with kapton tapes to the connector.

### Next steps

1. Install the [base cover](#).
2. Install the [solid state drive carrier](#).
3. Install the [batteries](#).
4. Follow the procedure in [after working inside your computer](#).

## Rear I/O-board

### Removing the rear I/O-board

 **CAUTION:** The information in this removal section is intended for authorized service technicians only.

#### Prerequisites

1. Follow the procedure in [before working inside your computer](#).
2. Remove the [batteries](#).
3. Remove the [solid state drive carrier](#).
4. Remove the [base cover](#).

#### About this task

The following image indicates the location of the rear I/O-board and provides a visual representation of the removal procedure.



2x  
M2.5x5

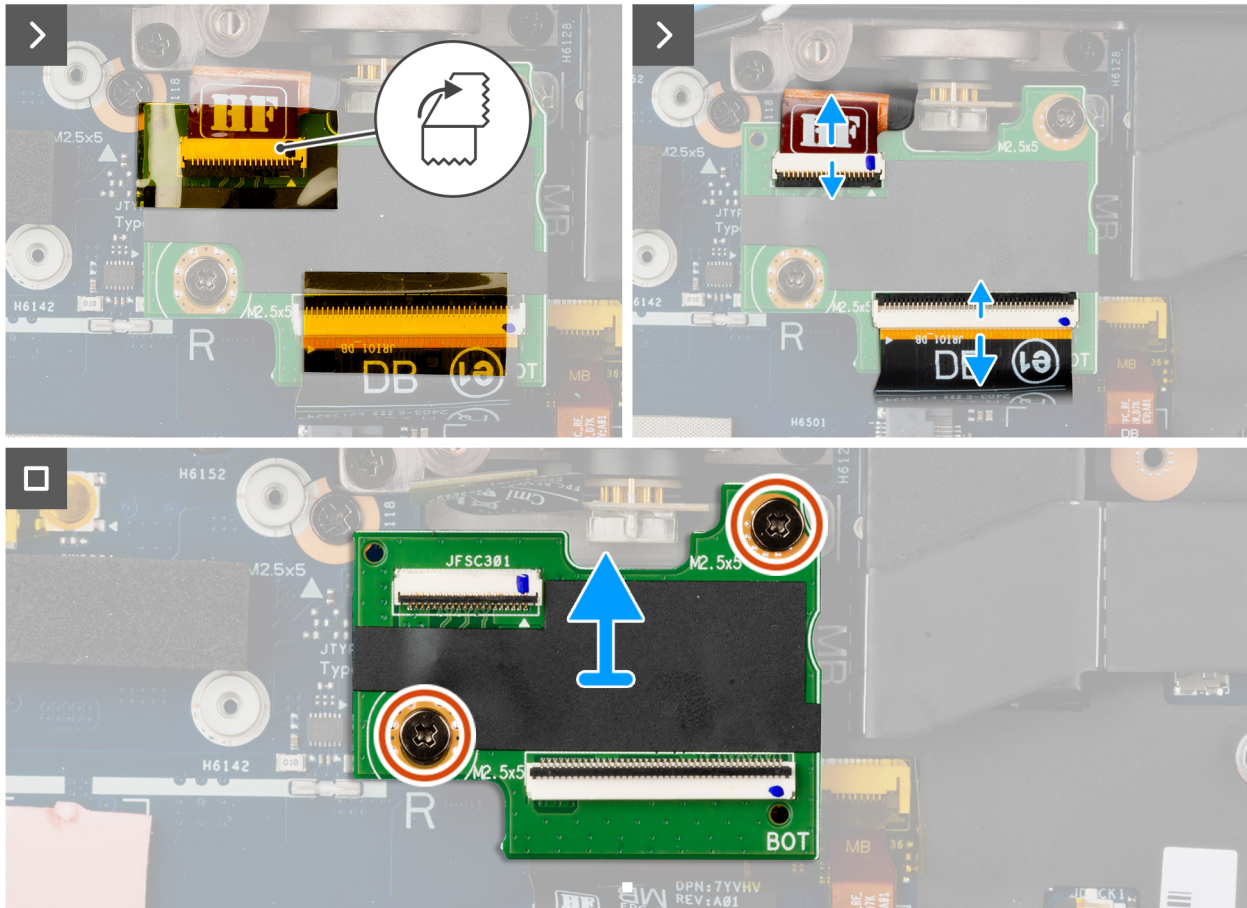
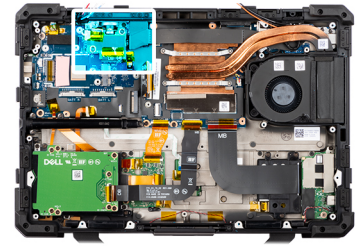

Figure 60. Removing the rear I/O-board

### Steps

1. Peel the adhesive tape and disconnect the rear I/O flat printed cables.
2. Remove the two (M2.5x5) screws that secure the rear I/O-board to the system board and remove it from the computer chassis.

## Installing the rear I/O-board

**CAUTION:** The information in this installation section is intended for authorized service technicians only.

### Prerequisites

If you are replacing a component, remove the existing component before performing the installation procedure.

### About this task

The following image indicates the location of the rear I/O-board and provides a visual representation of the installation procedure.



**2x**  
M2.5x5

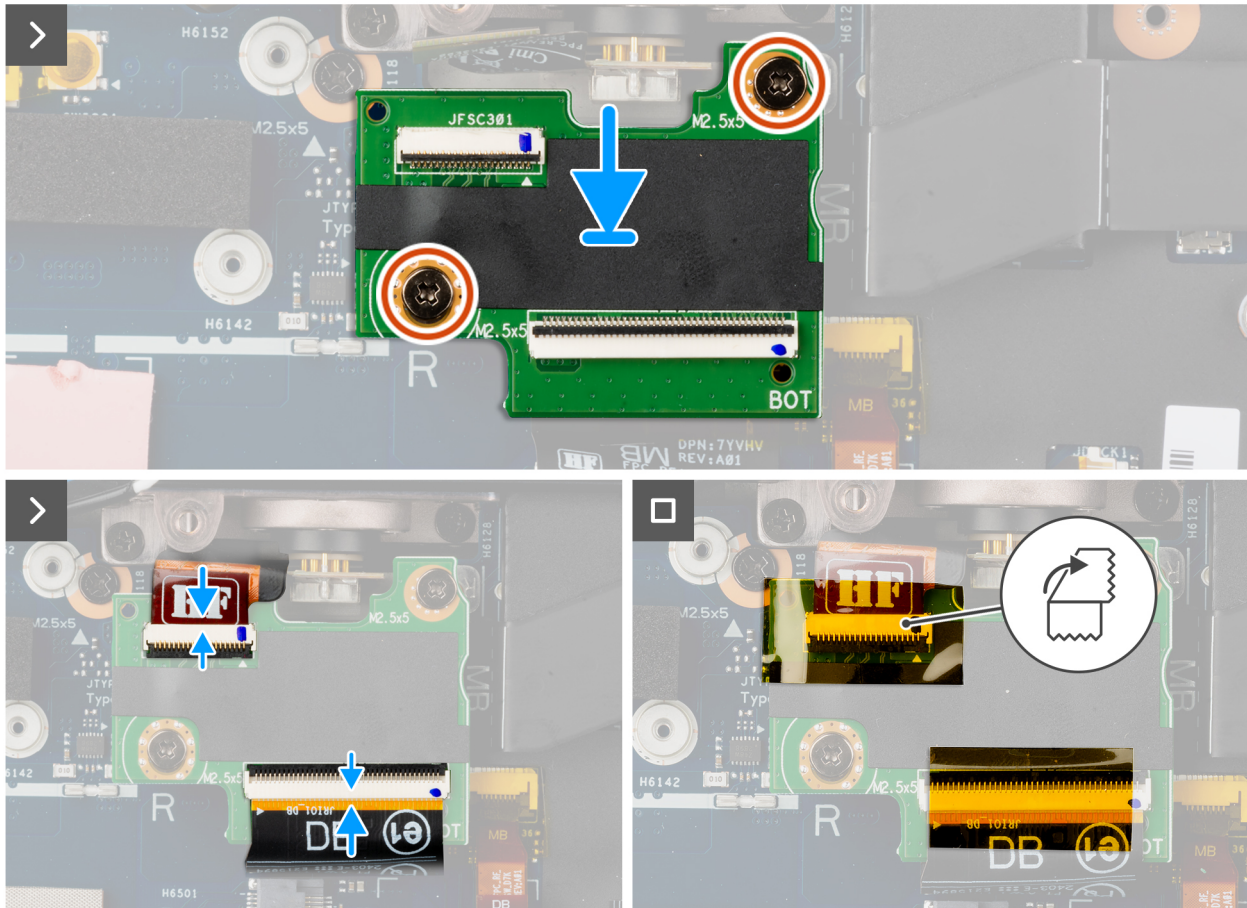
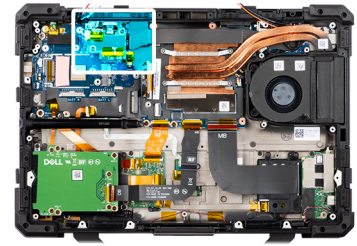

**Figure 61. Installing the rear I/O-board**

**Steps**

1. Align the screw holes on the rear I/O-board with the screw holes on the system board.
2. Replace the two (M2.5x5) screws to secure the rear I/O-board to the system board.
3. Connect the rear I/O flat printed cables on the rear I/O-board.

**(i) NOTE:** Adhere the rear I/O flat printed cable with kapton tapes to the connector.

**Next steps**

1. Install the [base cover](#).
2. Install the [solid state drive carrier](#).
3. Install the [batteries](#).
4. Follow the procedure in [after working inside your computer](#).

# Fischer USB port (optional)

## Removing the rear Fischer USB port

**CAUTION:** The information in this removal section is intended for authorized service technicians only.

### Prerequisites

1. Follow the procedure in [before working inside your computer](#).
2. Remove the [batteries](#).
3. Remove the [solid state drive carrier](#).
4. Remove the [base cover](#).
5. Remove the [rear I/O-board](#).

### About this task

The following image indicates the location of the rear Fischer USB port and provides a visual representation of the removal procedure.

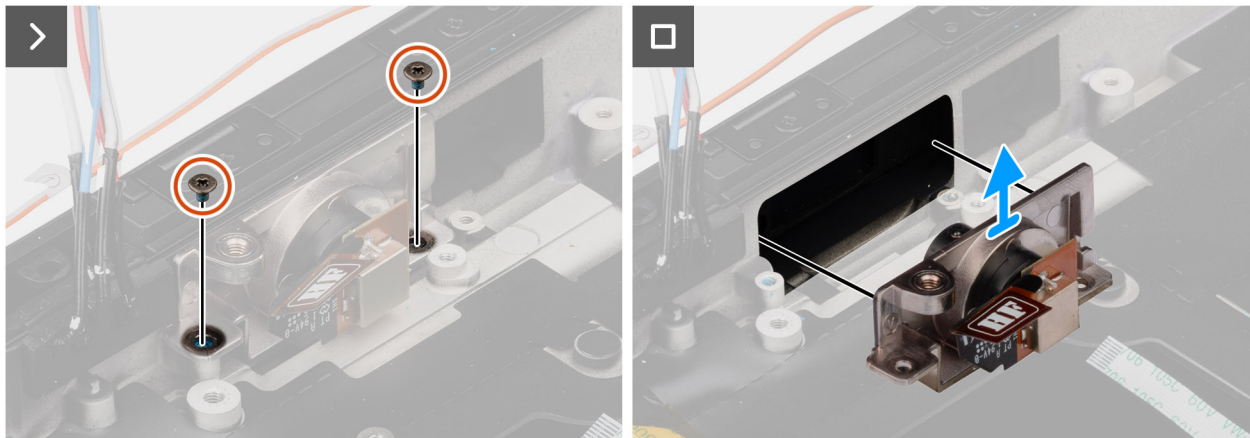
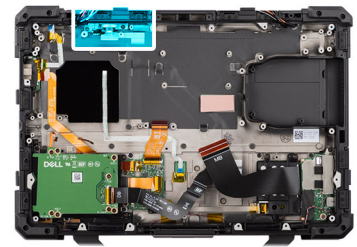

Figure 62. Removing the rear Fischer USB port

### Steps

1. Remove the two (M2.5x3) screws that secure the rear Fischer USB port to the computer chassis.
2. Lift the Fischer USB port from the computer chassis.

## Installing the rear Fischer USB port

**CAUTION:** The information in this installation section is intended for authorized service technicians only.

### Prerequisites

If you are replacing a component, remove the existing component before performing the installation procedure.

### About this task

The following image indicates the location of the rear Fischer USB port and provides a visual representation of the installation procedure.

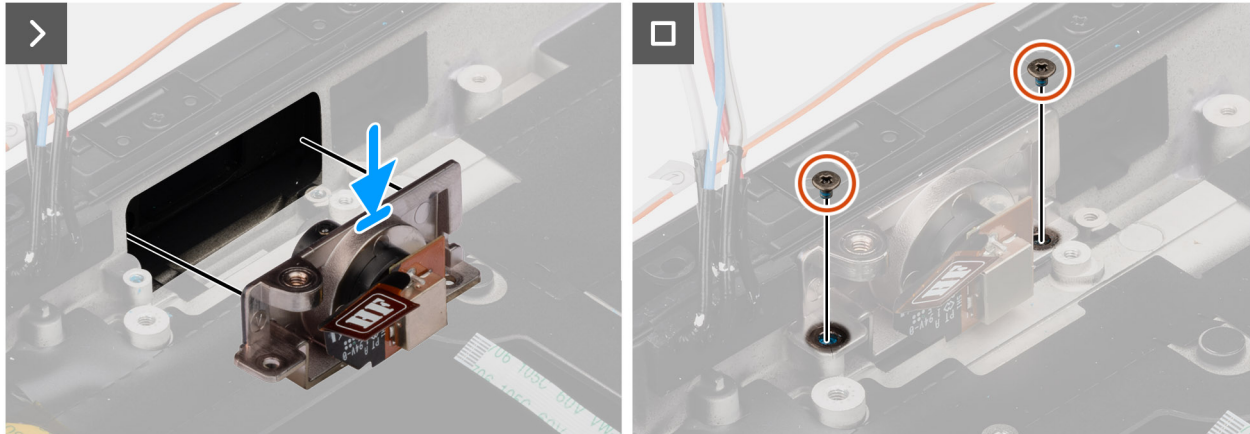
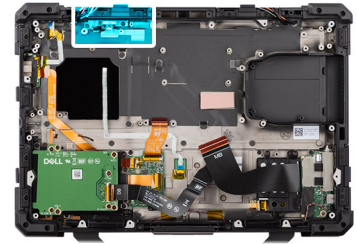

**Figure 63. Installing the rear Fischer USB port**

### Steps

1. Align the screw holes on the Fischer USB port with the screw holes on the computer chassis.
2. Replace the two (M2.5x3) screws to secure the rear Fischer USB port to the system board.

### Next steps

1. Install the [rear I/O-board](#).
2. Install the [base cover](#).
3. Install the [solid state drive carrier](#).
4. Install the [batteries](#).
5. Follow the procedure in [after working inside your computer](#).

## Rear Fischer USB I/O-board

### Removing the optional rear Fischer USB I/O-board

**CAUTION:** The information in this removal section is intended for authorized service technicians only.

**NOTE:** The removal of the optional rear I/O board is applicable only for computers that are shipped with the optional rear I/O port.

### Prerequisites

1. Follow the procedure in [before working inside your computer](#).
2. Remove the [batteries](#).
3. Remove the [solid state drive carrier](#).
4. Remove the [base cover](#).

### About this task

The following image indicates the location of the optional rear Fischer USB I/O-board and provides a visual representation of the removal procedure.

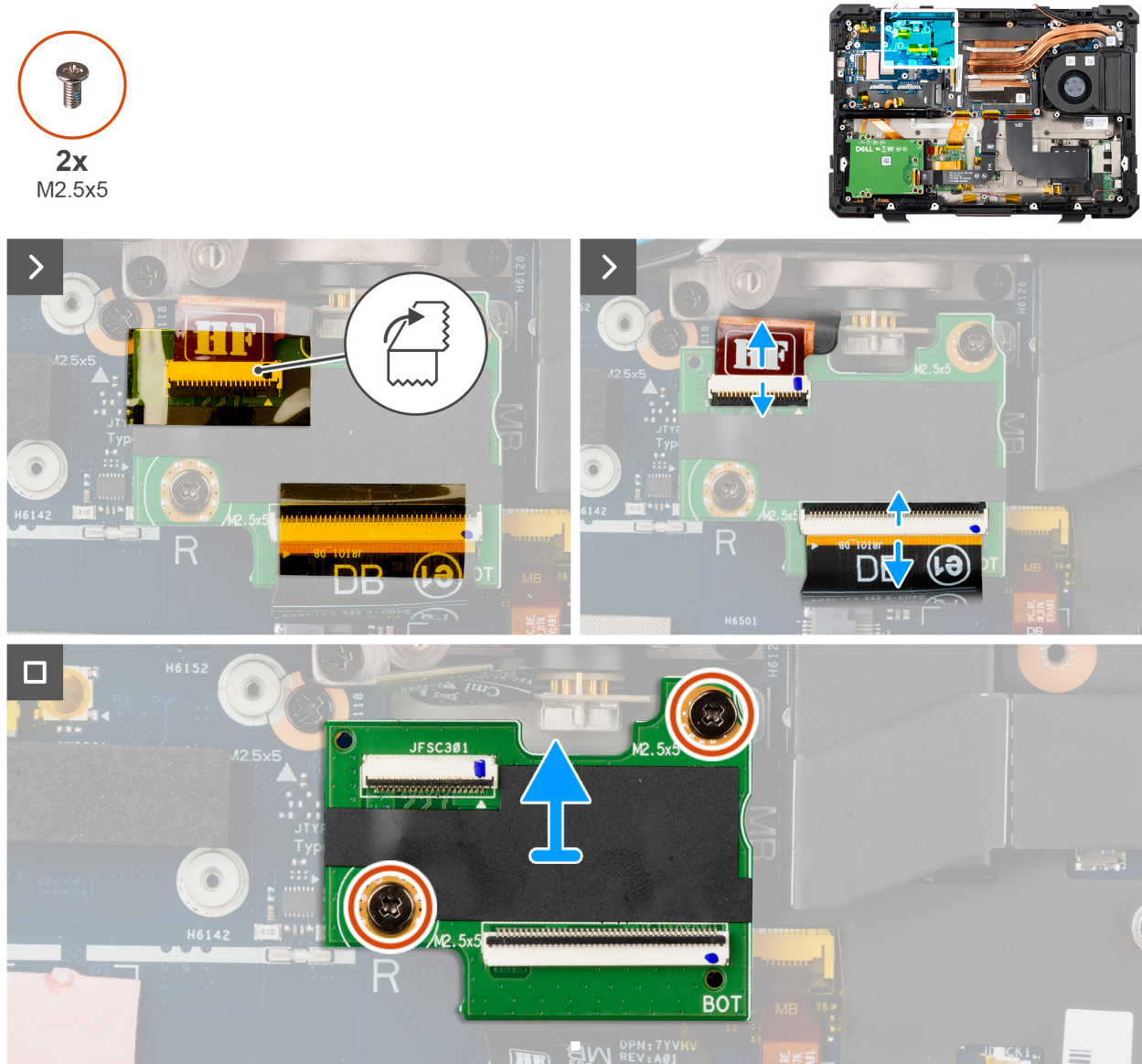

Figure 64. Removing the optional rear Fischer USB I/O-board

### Steps

1. Peel the adhesive tape and disconnect the rear I/O flat-printed cables.
2. Remove the two (M2.5x5) screws that secure the optional rear Fischer USB I/O-board to the system board.
3. Lift the optional rear Fischer USB I/O-board from the computer chassis.

## Installing the optional rear Fischer USB I/O-board

**CAUTION:** The information in this installation section is intended for authorized service technicians only.

**NOTE:** The installation of the optional rear I/O board is applicable only for computers that are shipped with the optional rear I/O port.

## Prerequisites

If you are replacing a component, remove the existing component before performing the installation procedure.

## About this task

The following image indicates the location of the optional rear Fischer USB I/O-board and provides a visual representation of the installation procedure.

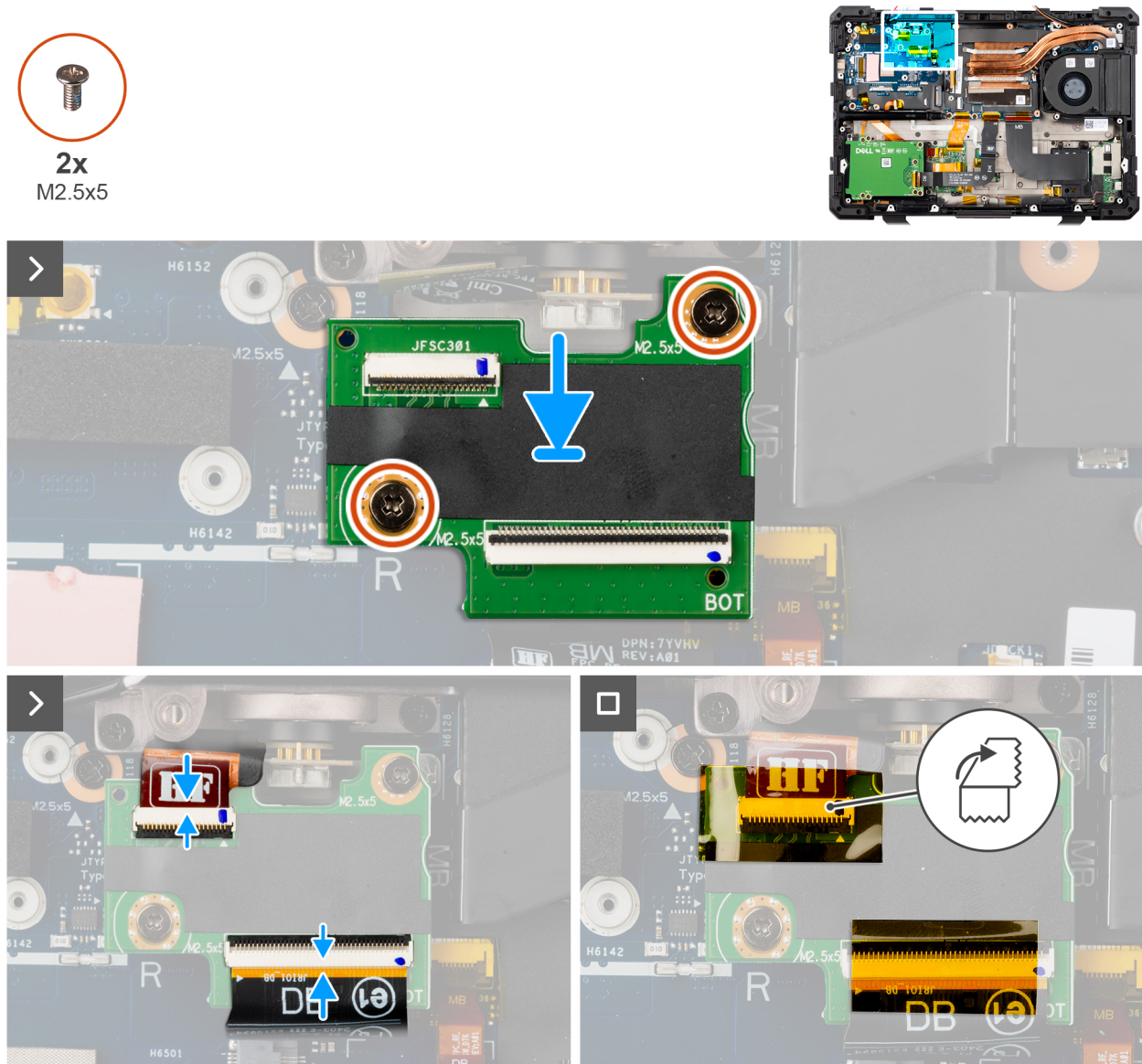

**Figure 65. Installing the optional rear Fischer USB I/O-board**

## Steps

1. Align the screw holes on the optional rear Fischer USB I/O-board with the screw holes on the chassis.
2. Replace the two (M2.5x5) screws to secure the optional rear Fischer USB I/O-board to the chassis.
3. Lift the flap and connect the rear I/O flat-printed cables to the connectors on the board.
4. Adhere the I/O flat-printed cable with kapton tapes to the connector.

## Next steps

1. Install the [base cover](#).
2. Install the [solid state drive carrier](#).
3. Install the [batteries](#).

4. Follow the procedure in [after working inside your computer](#).

## Rear Ethernet I/O-board

### Removing the optional rear Ethernet I/O-board

**CAUTION:** The information in this removal section is intended for authorized service technicians only.

**NOTE:** The removal of the optional rear I/O board is applicable only for computers that are shipped with the optional rear I/O port.

#### Prerequisites

1. Follow the procedure in [before working inside your computer](#).
2. Remove the [batteries](#).
3. Remove the [solid state drive carrier](#).
4. Remove the [base cover](#).

#### About this task

The following image indicates the location of the optional rear Ethernet I/O-board and provides a visual representation of the removal procedure.

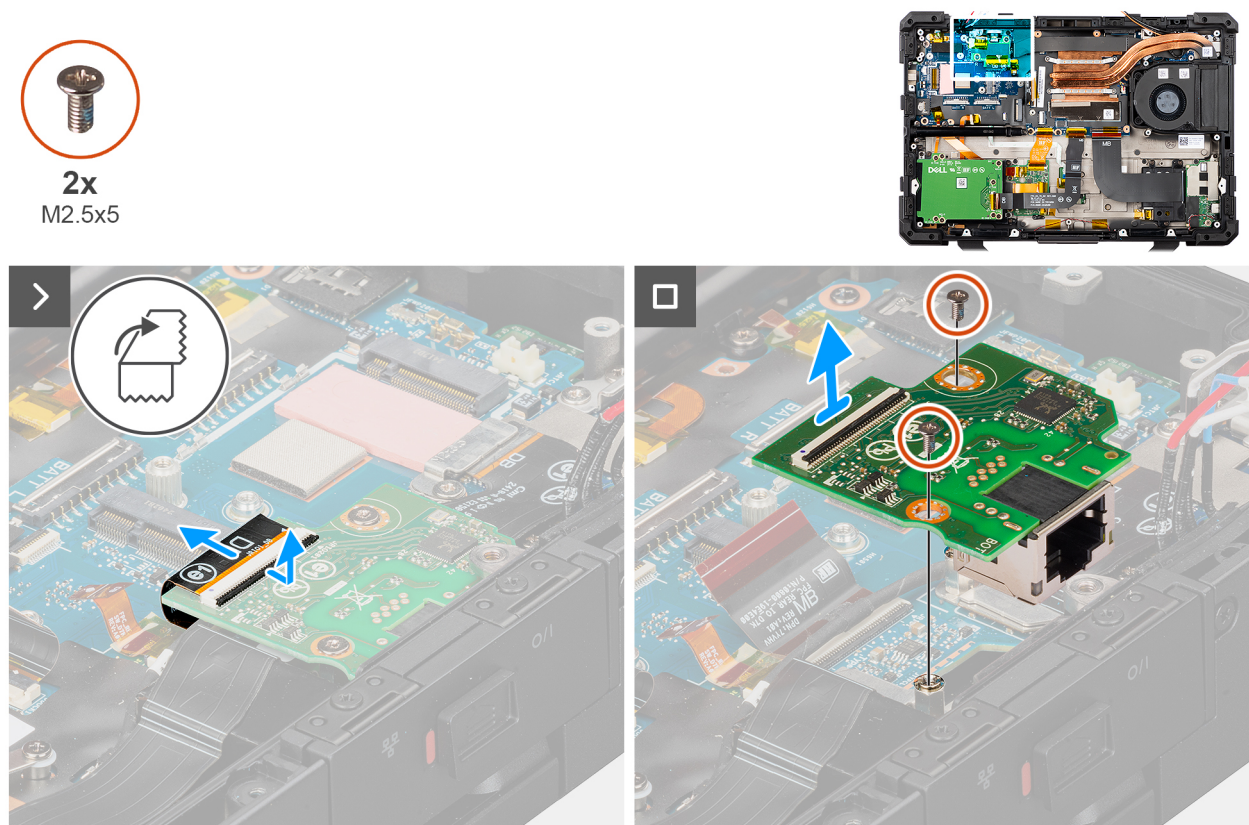

**Figure 66. Removing the optional rear Ethernet I/O-board**

#### Steps

1. Lift the flap and disconnect the rear I/O flat-printed cable from the connector on the board.
2. Remove the two (M2.5x5) screws that secure the optional rear Ethernet I/O-board to the chassis.
3. Lift the optional rear Ethernet I/O-board from the computer chassis.

# Installing the optional rear Ethernet I/O-board

**CAUTION:** The information in this installation section is intended for authorized service technicians only.

**NOTE:** The installation of the optional rear I/O board is applicable only for computers that are shipped with the optional rear I/O port.

## Prerequisites

If you are replacing a component, remove the existing component before performing the installation procedure.

## About this task

The following image indicates the location of the optional rear Ethernet I/O-board and provides a visual representation of the installation procedure.

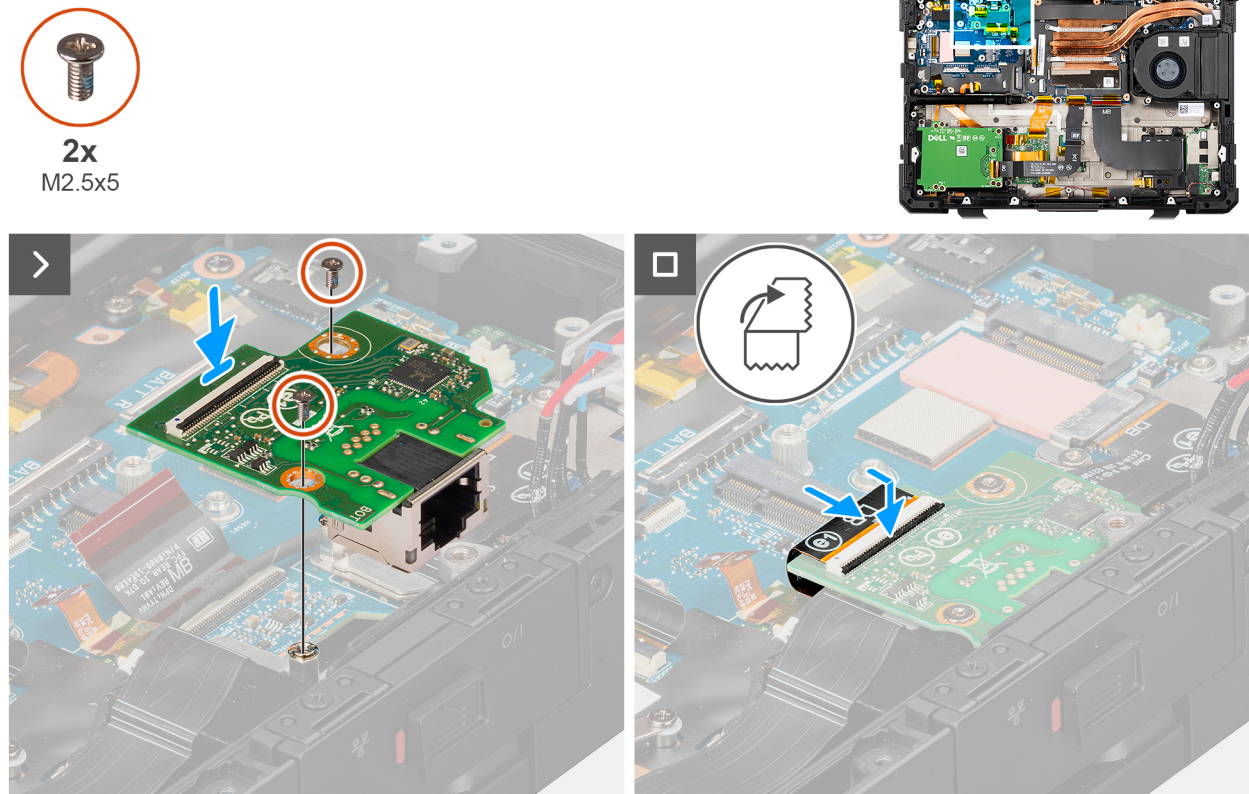

Figure 67. Installing the rear optional Ethernet I/O-board

## Steps

1. Align the screw holes on the optional rear Ethernet I/O-board with the screw holes on the chassis.
2. Replace the two (M2.5x5) screws to secure the optional rear Ethernet I/O-board to the chassis.
3. Lift the flap and connect the rear I/O flat-printed cable to the connector on the board.

## Next steps

1. Install the [base cover](#).
2. Install the [solid state drive carrier](#).
3. Install the [batteries](#).
4. Follow the procedure in [after working inside your computer](#).

# Rear Serial I/O-board

## Removing the optional rear serial I/O-board

**CAUTION:** The information in this removal section is intended for authorized service technicians only.

**NOTE:** The removal of the optional rear I/O board is applicable only for computers that are shipped with the optional rear I/O port.

### Prerequisites

1. Follow the procedure in [before working inside your computer](#).
2. Remove the [batteries](#).
3. Remove the [solid state drive carrier](#).
4. Remove the [base cover](#).

### About this task

The following image indicates the location of the optional rear serial I/O-board and provides a visual representation of the removal procedure.

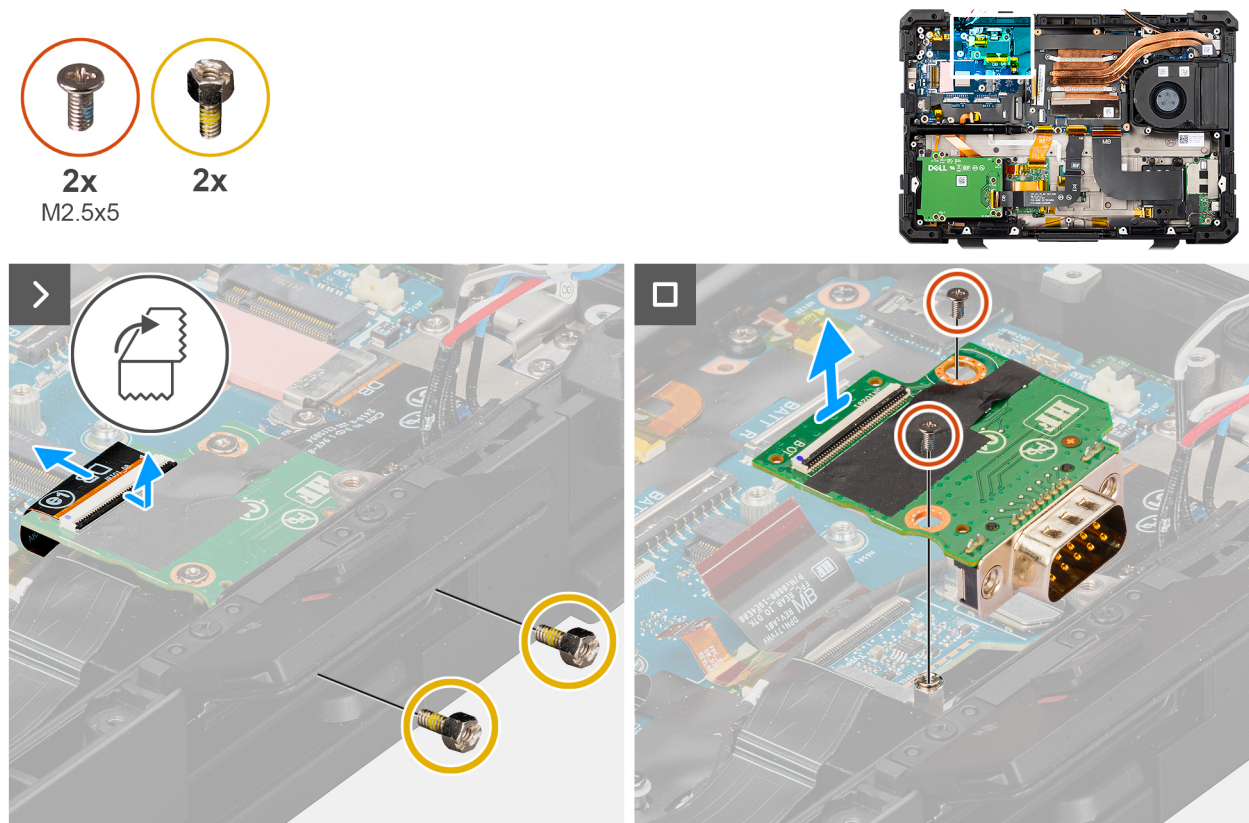

**Figure 68. Removing the optional rear serial I/O-board**

### Steps

1. Lift the flap and disconnect the rear I/O flat-printed cable from the connector on the board.
2. Remove the two epoxy screws (#4-40x6.5) that secure the rear serial port to the chassis.
3. Remove the two (M2.5x5) screws that secure the optional rear serial I/O-board to the system board.
4. Lift the optional rear serial I/O-board from the computer chassis.

## Installing the optional rear serial I/O-board

**CAUTION:** The information in this installation section is intended for authorized service technicians only.

**NOTE:** The installation of the optional rear I/O board is applicable only for computers that are shipped with the optional rear I/O port.

### Prerequisites

If you are replacing a component, remove the existing component before performing the installation procedure.

### About this task

The following image indicates the location of the optional rear serial I/O-board and provides a visual representation of the installation procedure.

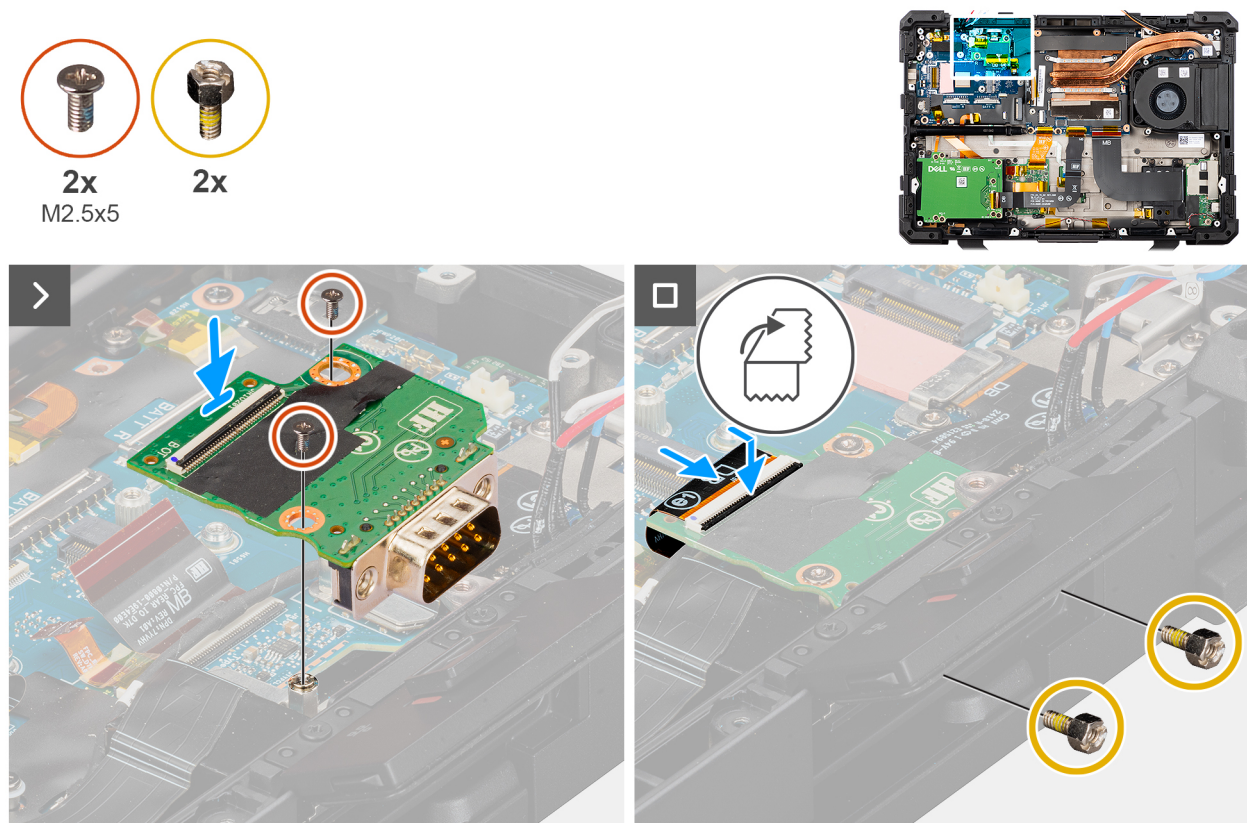

**Figure 69. Installing the optional rear serial I/O-board**

### Steps

1. Align the screw holes on the optional rear serial I/O-board with the screw holes on the chassis.
2. Replace the two (M2.5x3) screws to secure the optional rear serial I/O-board to the chassis.
3. Lift the flap and connect the rear I/O flat-printed cable to the connector on the board.
4. Replace the two epoxy screws (#4-40x6.5) to secure the rear serial I/O-board to the chassis.

### Next steps

1. Install the [base cover](#).
2. Install the [solid state drive carrier](#).
3. Install the [batteries](#).
4. Follow the procedure in [after working inside your computer](#).

# Rear USB Type-A I/O-board

## Removing the optional rear USB Type-A I/O-board

**CAUTION:** The information in this removal section is intended for authorized service technicians only.

**NOTE:** The removal of the optional rear I/O board is applicable only for computers that are shipped with the optional rear I/O port.

### Prerequisites

1. Follow the procedure in [before working inside your computer](#).
2. Remove the [batteries](#).
3. Remove the [solid state drive carrier](#).
4. Remove the [base cover](#).

### About this task

The following image indicates the location of the optional rear USB Type-A I/O-board and provides a visual representation of the removal procedure.

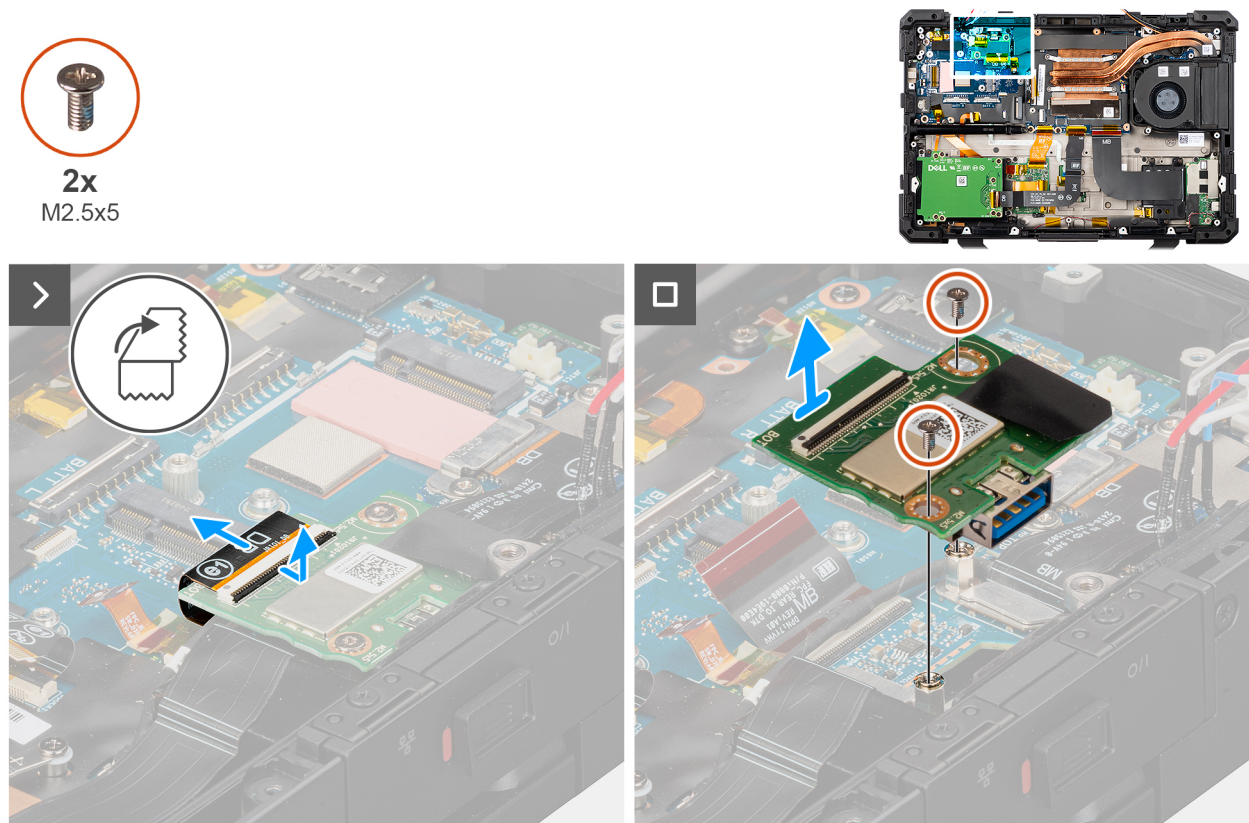

**Figure 70. Removing the optional rear USB Type-A I/O-board**

### Steps

1. Lift the flap and disconnect the rear I/O flat-printed cable from the connector on the board.
2. Remove the two (M2.5x3) screws that secure the optional rear USB Type-A I/O-board to the system board.
3. Lift the optional rear USB Type-A I/O-board from the computer chassis.

## Installing the rear USB Type-A I/O-board

**CAUTION:** The information in this installation section is intended for authorized service technicians only.

**NOTE:** The installation of the optional rear I/O board is applicable only for computers that are shipped with the optional rear I/O port.

### Prerequisites

If you are replacing a component, remove the existing component before performing the installation procedure.

### About this task

The following image indicates the location of the optional rear USB Type-A I/O-board and provides a visual representation of the installation procedure.

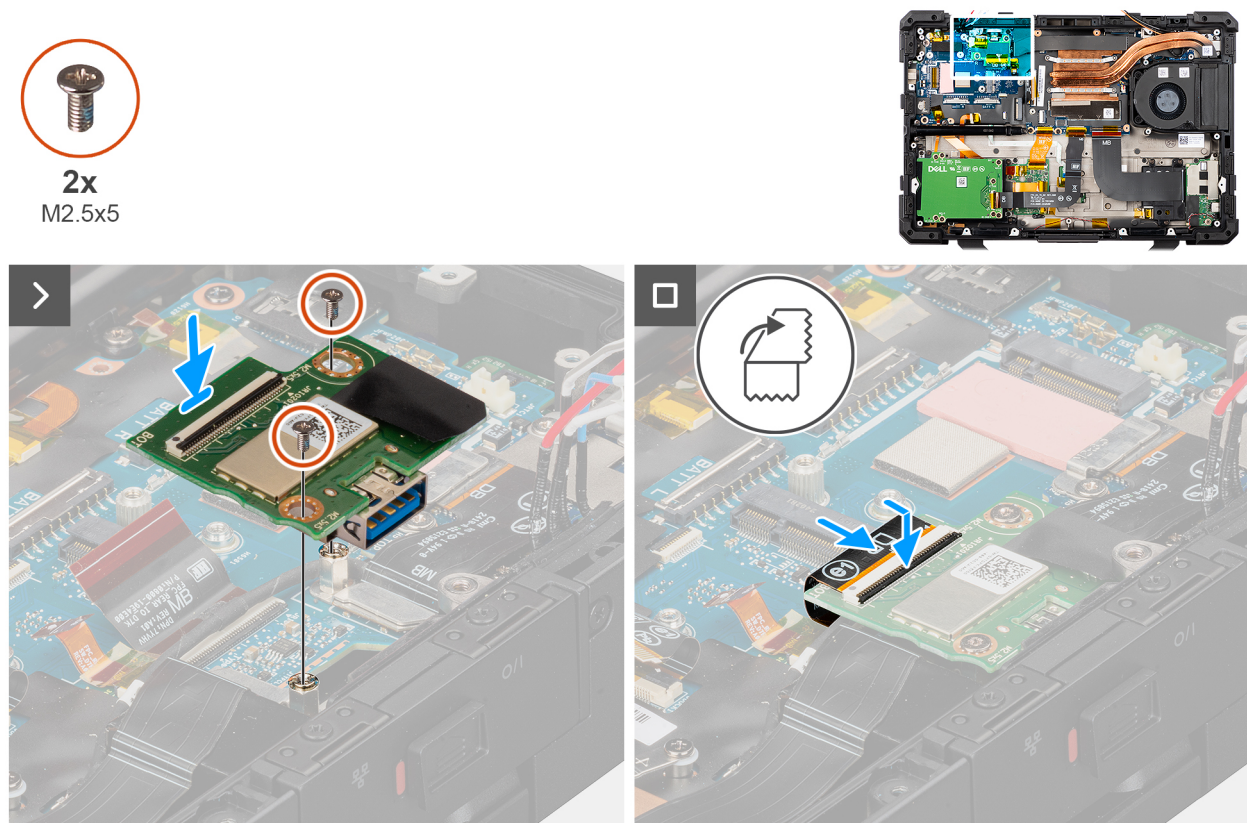

**Figure 71. Installing the optional rear USB Type-A I/O-board**

### Steps

1. Align the screw holes on the optional rear USB Type-A I/O-board with the screw holes on the system board.
2. Replace the two (M2.5x3) screws to secure the optional rear USB Type-A I/O-board to the system board.
3. Lift the flap and connect the rear I/O flat-printed cable to the connector on the board.

### Next steps

1. Install the [base cover](#).
2. Install the [solid state drive carrier](#).
3. Install the [batteries](#).
4. Follow the procedure in [after working inside your computer](#).

# RF switch board

## Removing the RF switch board

**CAUTION:** The information in this removal section is intended for authorized service technicians only.

### Prerequisites

1. Follow the procedure in [before working inside your computer](#).
2. Remove the [batteries](#).
3. Remove the [solid state drive carrier](#).
4. Remove the [base cover](#).

### About this task

The following image indicates the location of the RF switch board and provides a visual representation of the removal procedure.

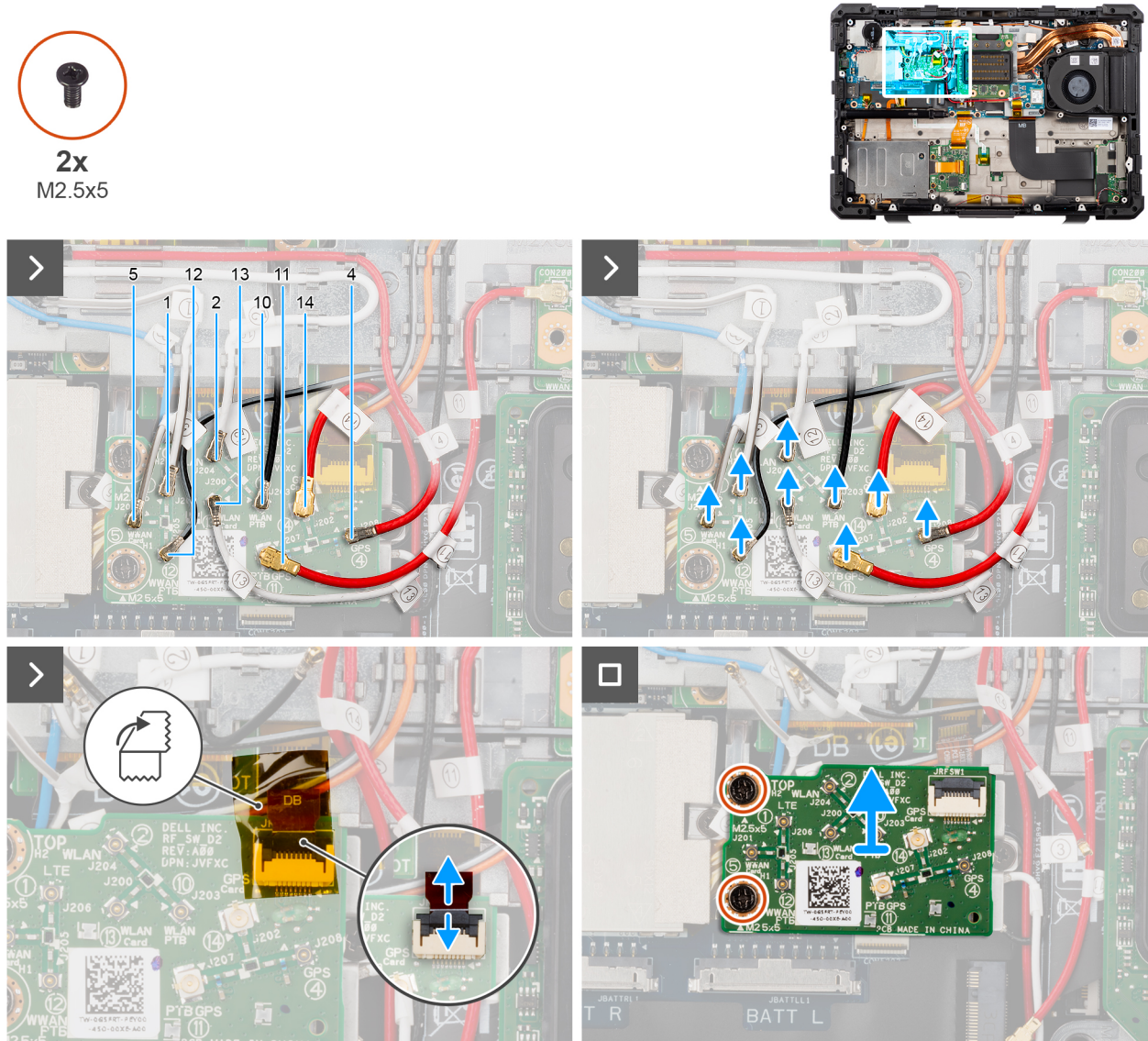

Figure 72. Removing the RF switch board

### Steps

1. Disconnect the WLAN, WWAN, and GPS antennas from the RF switch board.

**Table 42. Cable connectors on Dell Pro Rugged 13 RA13250**

| Cable number | Antenna      |
|--------------|--------------|
| 5            | WWAN antenna |
| 1            | WWAN antenna |
| 12           | WWAN antenna |
| 2            | WLAN antenna |
| 13           | WLAN antenna |
| 10           | WLAN antenna |
| 11           | GPS antenna  |
| 14           | GPS antenna  |
| 4            | GPS antenna  |

2. Peel the adhesive tape and disconnect the flexible printed cable from the RF switch board.
3. Remove the two (M2.5x5) screws that secure the RF switch board to the system board.
4. Lift the RF switch board from the system board.

## Installing the RF switch board

 **CAUTION:** The information in this installation section is intended for authorized service technicians only.

### Prerequisites

If you are replacing a component, remove the existing component before performing the installation procedure.

### About this task

The following image indicates the location of the RF switch board and provides a visual representation of the installation procedure.



2x  
M2.5x5

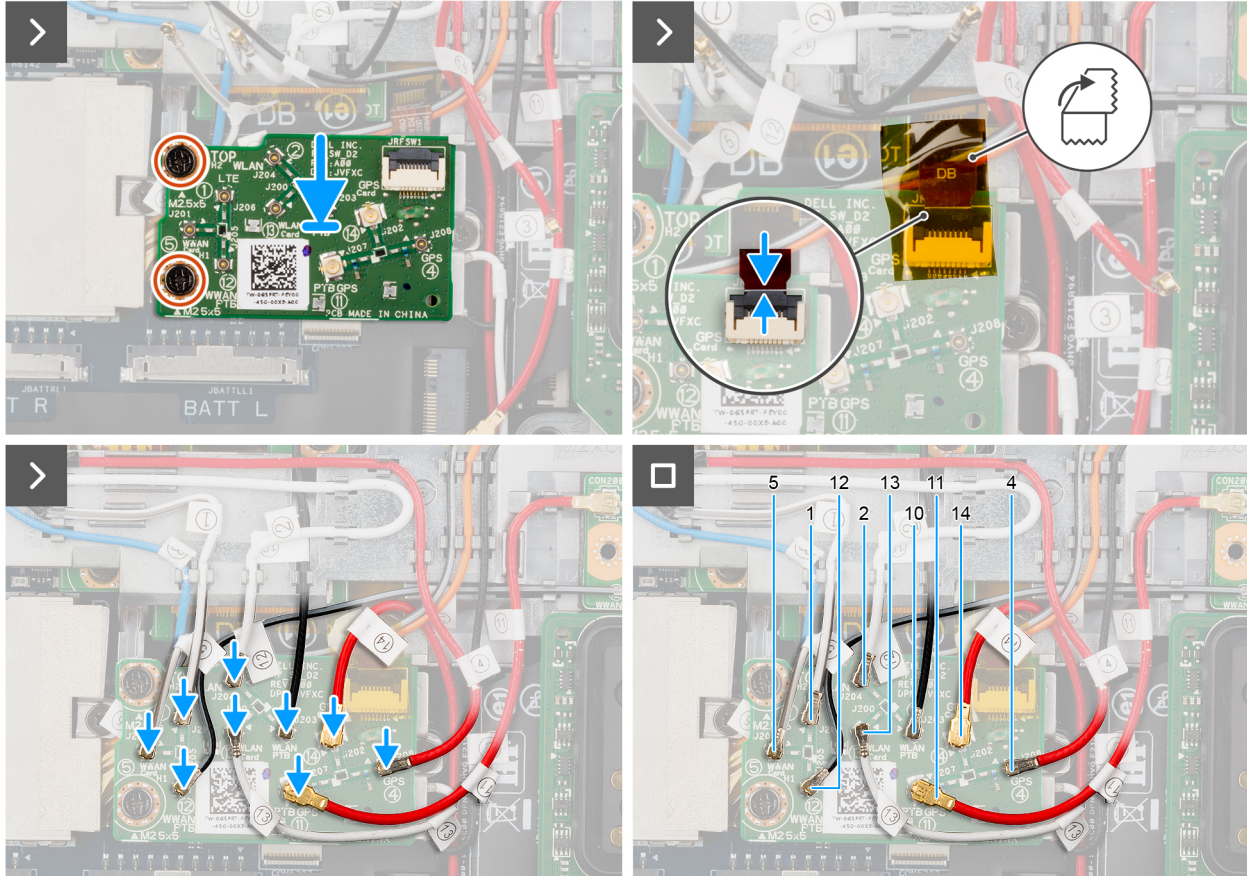
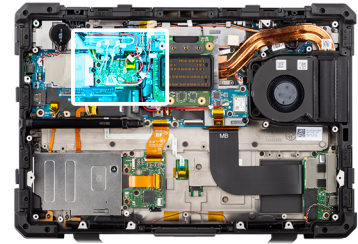

**Figure 73. Installing the RF switch board**

**Steps**

1. Place and align the RF switch board with the screw holes on the system board.
2. Replace the two (M2.5x5) screws that secure the RF switch board to the system board.
3. Connect the flexible printed cable to the RF switch board.

**(i) NOTE:** Adhere the flexible printed cable with kapton tape to the connector.

4. Connect the WLAN, WWAN, and GPS antennas to the RF switch board.

**Table 43. Cable connectors on Dell Pro Rugged 13 RA13250**

| Cable number | Antenna      |
|--------------|--------------|
| 5            | WWAN antenna |
| 1            | WWAN antenna |
| 12           | WWAN antenna |
| 2            | WLAN antenna |
| 13           | WLAN antenna |

**Table 43. Cable connectors on Dell Pro Rugged 13 RA13250 (continued)**

| Cable number | Antenna      |
|--------------|--------------|
| 10           | WLAN antenna |
| 11           | GPS antenna  |
| 14           | GPS antenna  |
| 4            | GPS antenna  |

**Next steps**

1. Install the [base cover](#).
2. Install the [solid state drive carrier](#).
3. Install the [batteries](#).
4. Follow the procedure in [after working inside your computer](#).

## Wireless Local Area Network (WLAN) card

### Removing the WLAN card

 **CAUTION:** The information in this removal section is intended for authorized service technicians only.

**Prerequisites**

1. Follow the procedure in [before working inside your computer](#).
2. Remove the [batteries](#).
3. Remove the [solid state drive carrier](#).
4. Remove the [base cover](#).
5. Remove the [RF switch board](#).

**About this task**

The following image indicates the location of the WLAN card and provides a visual representation of the removal procedure.



1x  
M2x3

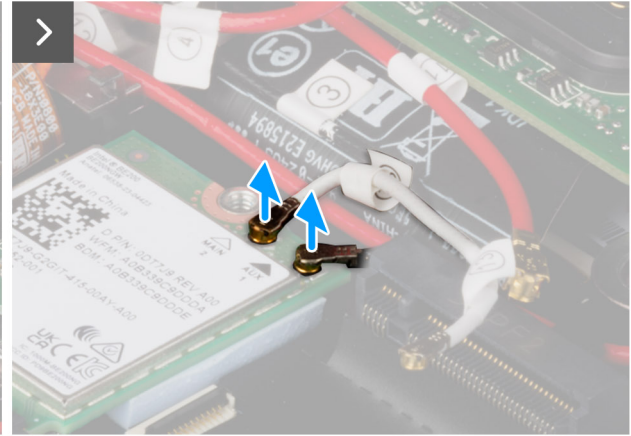
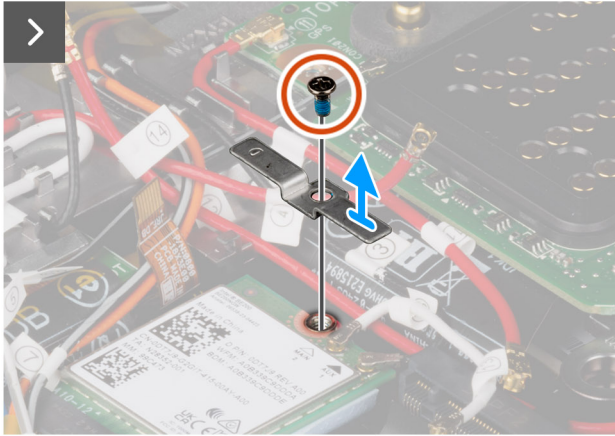
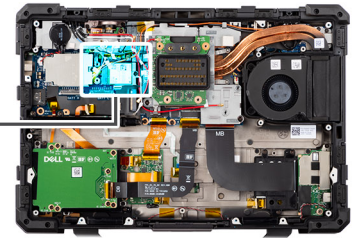

Figure 74. Removing the WLAN card

**Steps**

1. Remove the (M2x3) screw that secures the WLAN card holder to the system board.
2. Remove the WLAN card holder.
3. Disconnect the antenna cables from the WLAN card.

Table 44. Connectors on the wireless card

| Antenna                    | Cable Color |
|----------------------------|-------------|
| Main (white triangle)      | White       |
| Auxiliary (black triangle) | Black       |

4. Slide and remove the WLAN card from the WLAN card slot.

# Installing the WLAN card

**CAUTION:** The information in this installation section is intended for authorized service technicians only.

## Prerequisites

If you are replacing a component, remove the existing component before performing the installation procedure.

## About this task

The following image indicates the location of the WLAN card and provides a visual representation of the installation procedure.

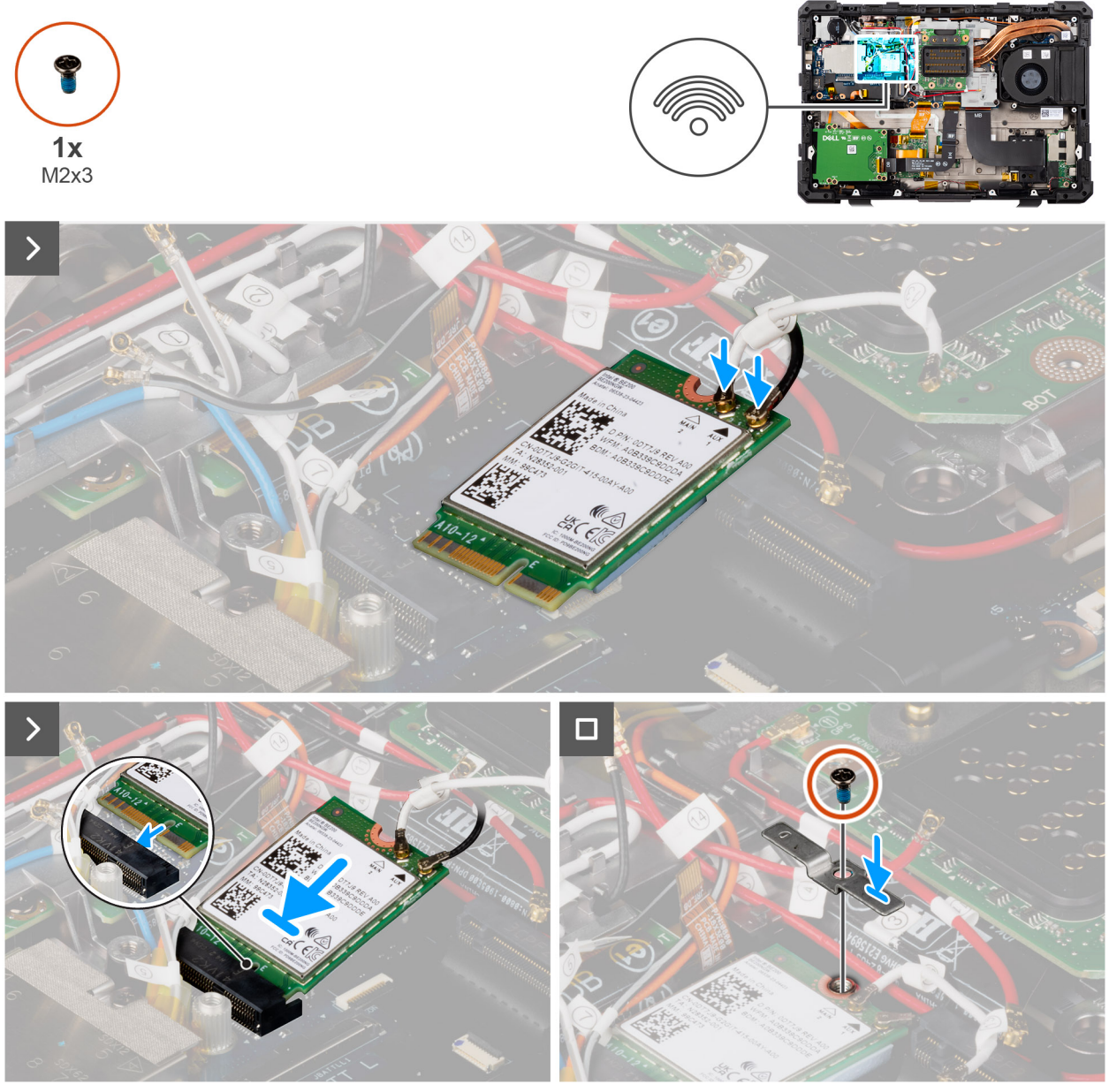

Figure 75. Installing the WLAN card

## Steps

1. Connect the antenna cables to the WLAN card.

**Table 45. Connectors on the wireless card**

| Antenna                    | Cable Color |
|----------------------------|-------------|
| Main (white triangle)      | White       |
| Auxiliary (black triangle) | Black       |

2. Slide the WLAN card at an angle into the WLAN card slot.
3. Place the WLAN card holder on the WLAN card.
4. Replace the (M2x3) screw to secure the WLAN card holder to the WLAN card.

**Next steps**

1. Install the [RF switch board](#).
2. Install the [base cover](#).
3. Install the [solid state drive carrier](#).
4. Install the [batteries](#).
5. Follow the procedure in [after working inside your computer](#).

## Wireless Wide Area Network (WWAN) card

### Removing the WWAN card

 **CAUTION:** The information in this removal section is intended for authorized service technicians only.

**Prerequisites**

1. Follow the procedure in [before working inside your computer](#).
2. Remove the [batteries](#).
3. Remove the [solid state drive carrier](#).
4. Remove the [base cover](#).
5. Remove the [RF switch board](#).

**About this task**

The following images indicate the location of the WWAN card and provide a visual representation of the removal procedure.



1x  
M2x3

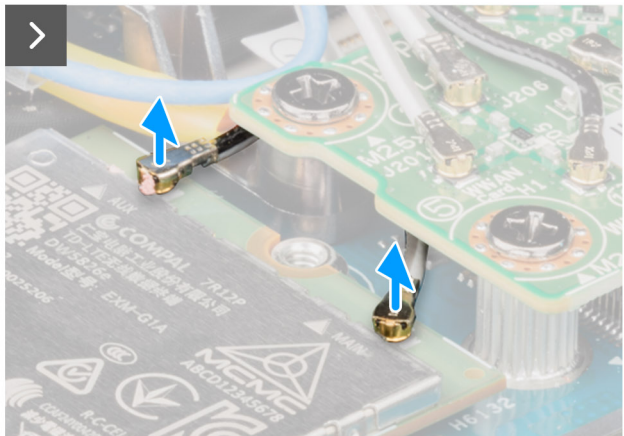
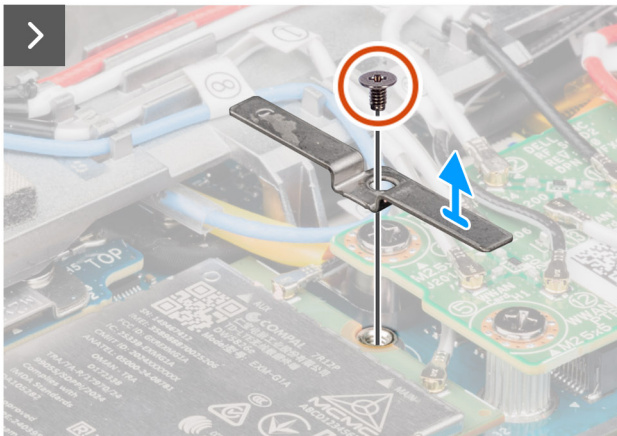
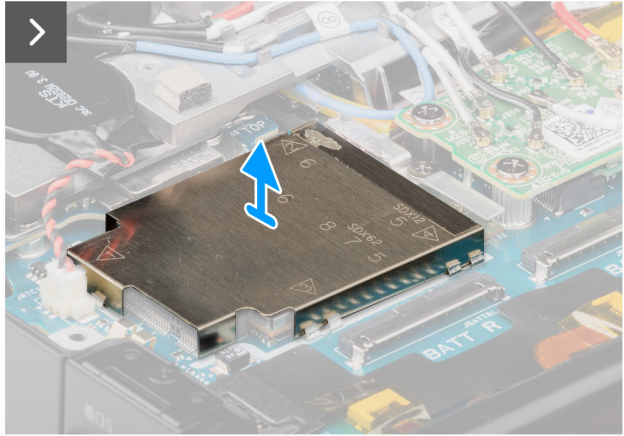
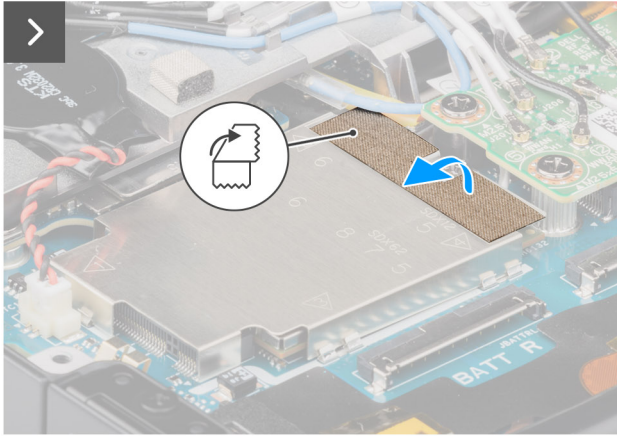
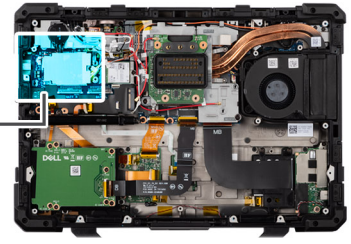

Figure 76. Removing the WWAN card (4G configuration)

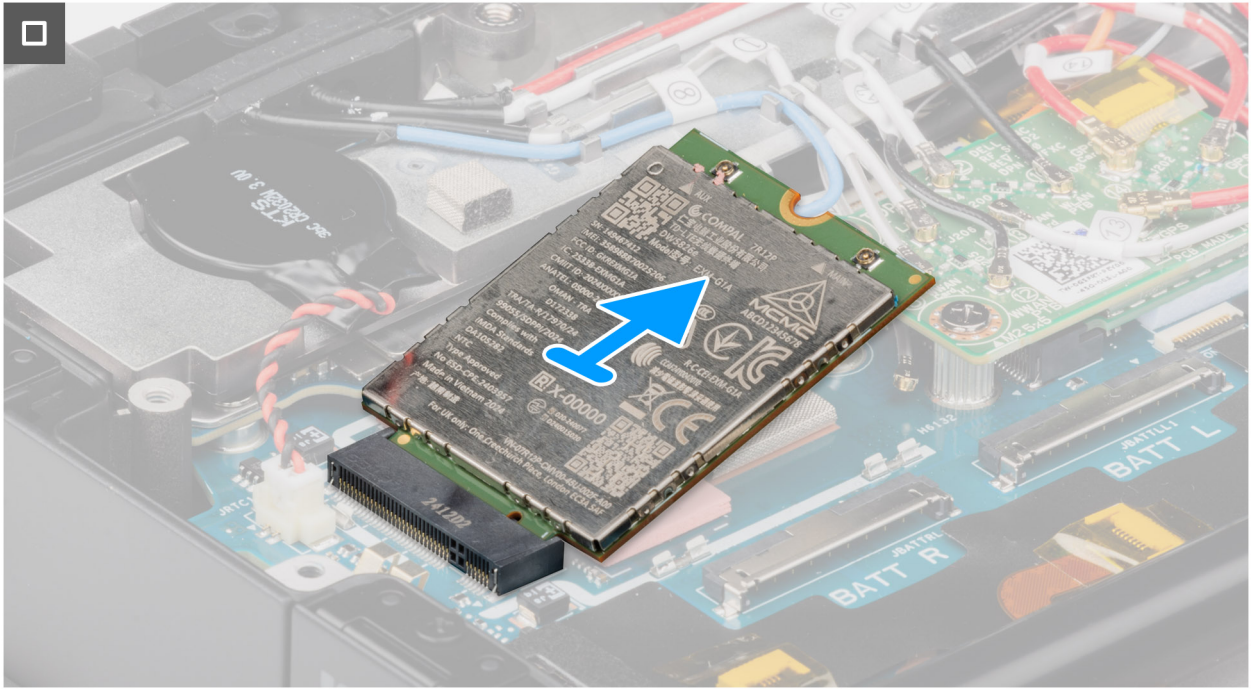

Figure 77. Removing the WWAN card (4G configuration)



1x  
M2x3

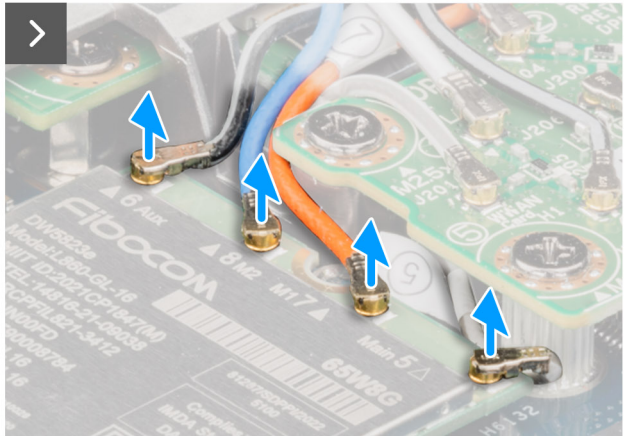
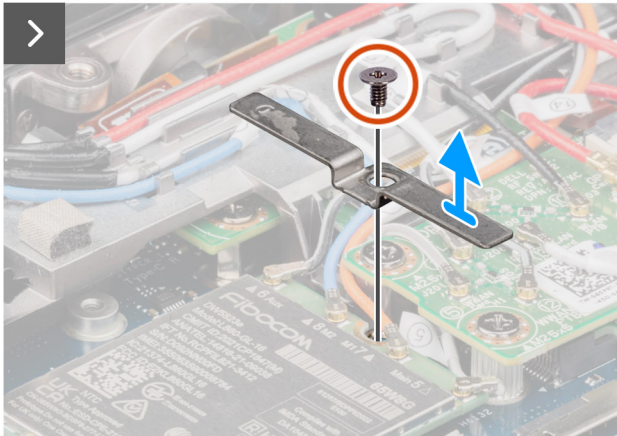
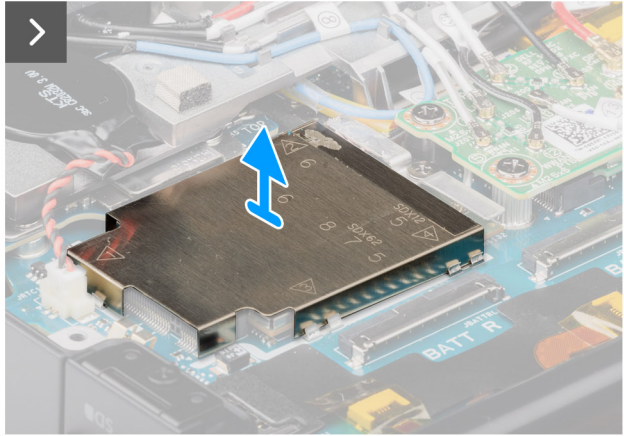
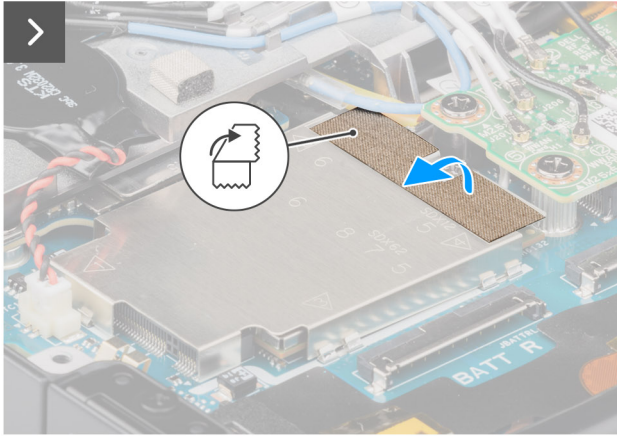
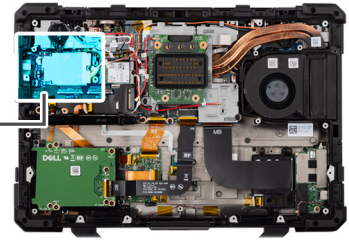
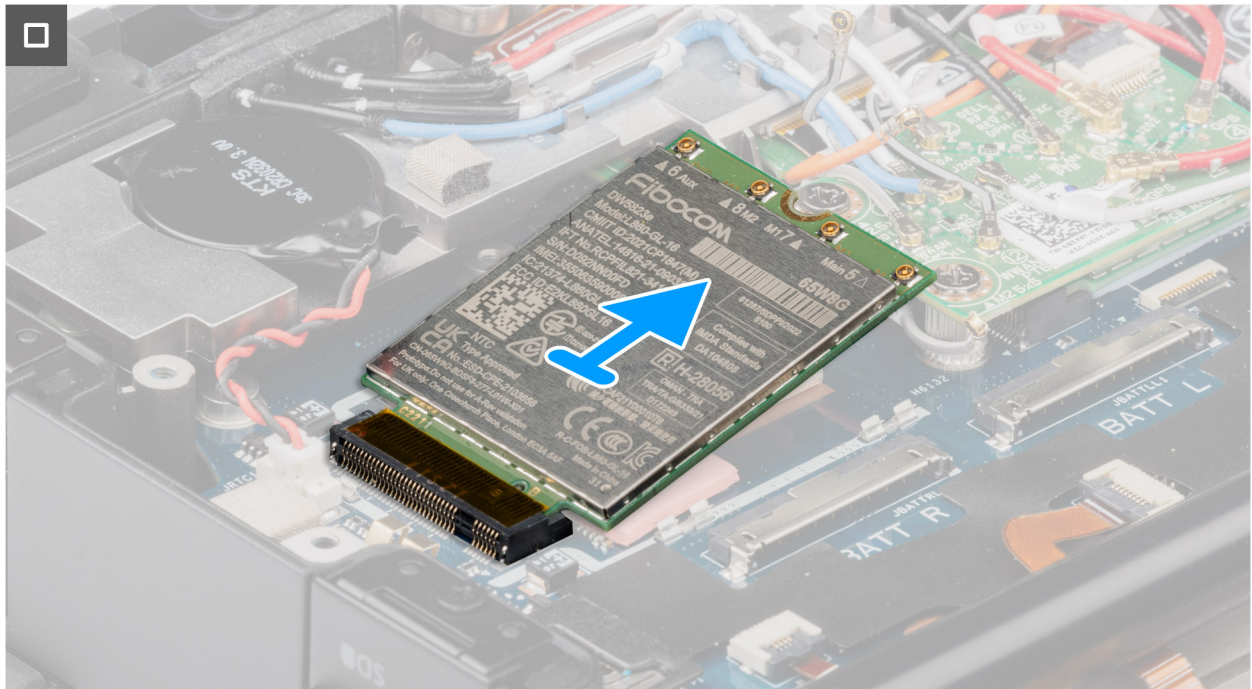

Figure 78. Removing the WWAN card (5G configuration)



**Figure 79. Removing the WWAN card (5G configuration)**

**Steps**

1. Peel back the anti-static fabric tape slightly and remove the WWAN shield.
2. Remove the (M2x3) screw that secures the WWAN card holder to the system board.
3. Remove the WWAN card holder.
4. Disconnect all the antenna cables from the WWAN card.

**Table 46. Connectors on the WWAN card**

| Antenna                           | Cable Color                      |
|-----------------------------------|----------------------------------|
| Main (white triangle) - ANT1      | Orange (cable number 7)          |
| Main (white triangle) - ANT3      | White and Black (cable number 6) |
| Auxiliary (black triangle) - ANT0 | White and Grey (cable number 5)  |
| Auxiliary (black triangle) - ANT2 | Blue (cable number 8)            |

5. Slide and remove the WWAN card from the WWAN card slot.

## Installing the WWAN card

**CAUTION:** The information in this installation section is intended for authorized service technicians only.

**Prerequisites**

If you are replacing a component, remove the existing component before performing the installation procedure.

**About this task**

The following image indicates the location of the WWAN card and provides a visual representation of the installation procedure.



1x  
M2x3

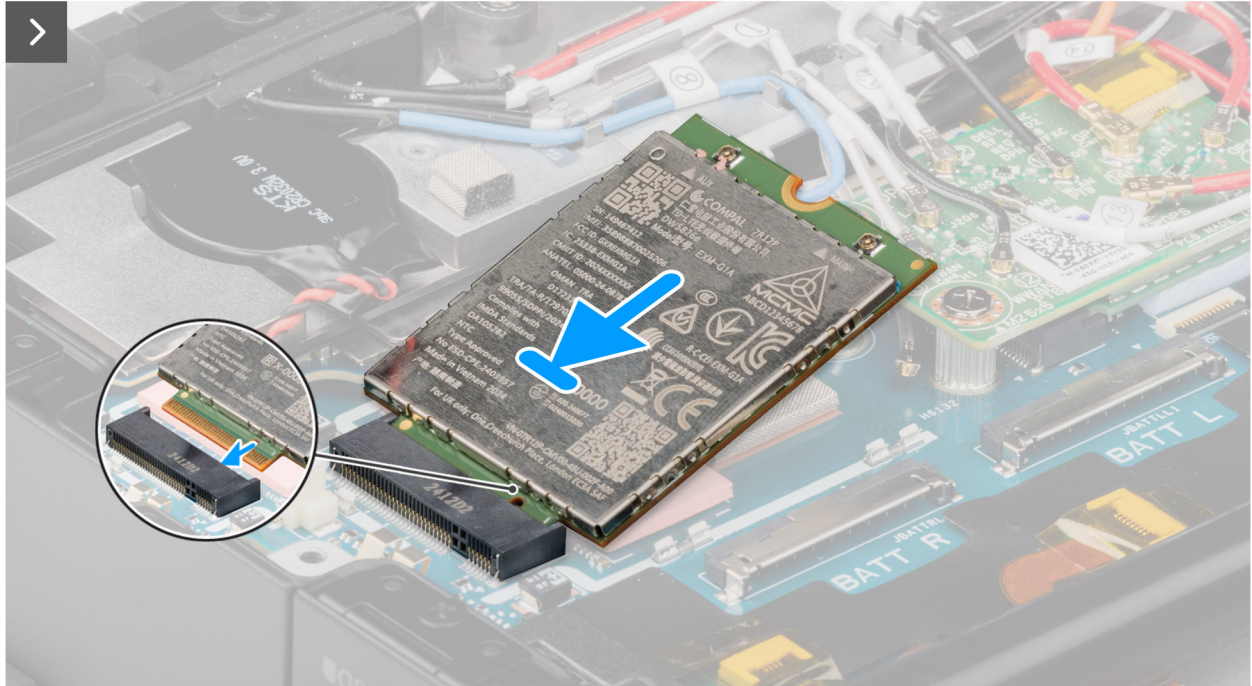
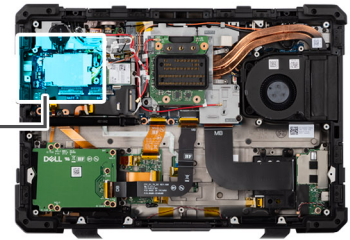

Figure 80. Installing the WWAN card (4G configuration)

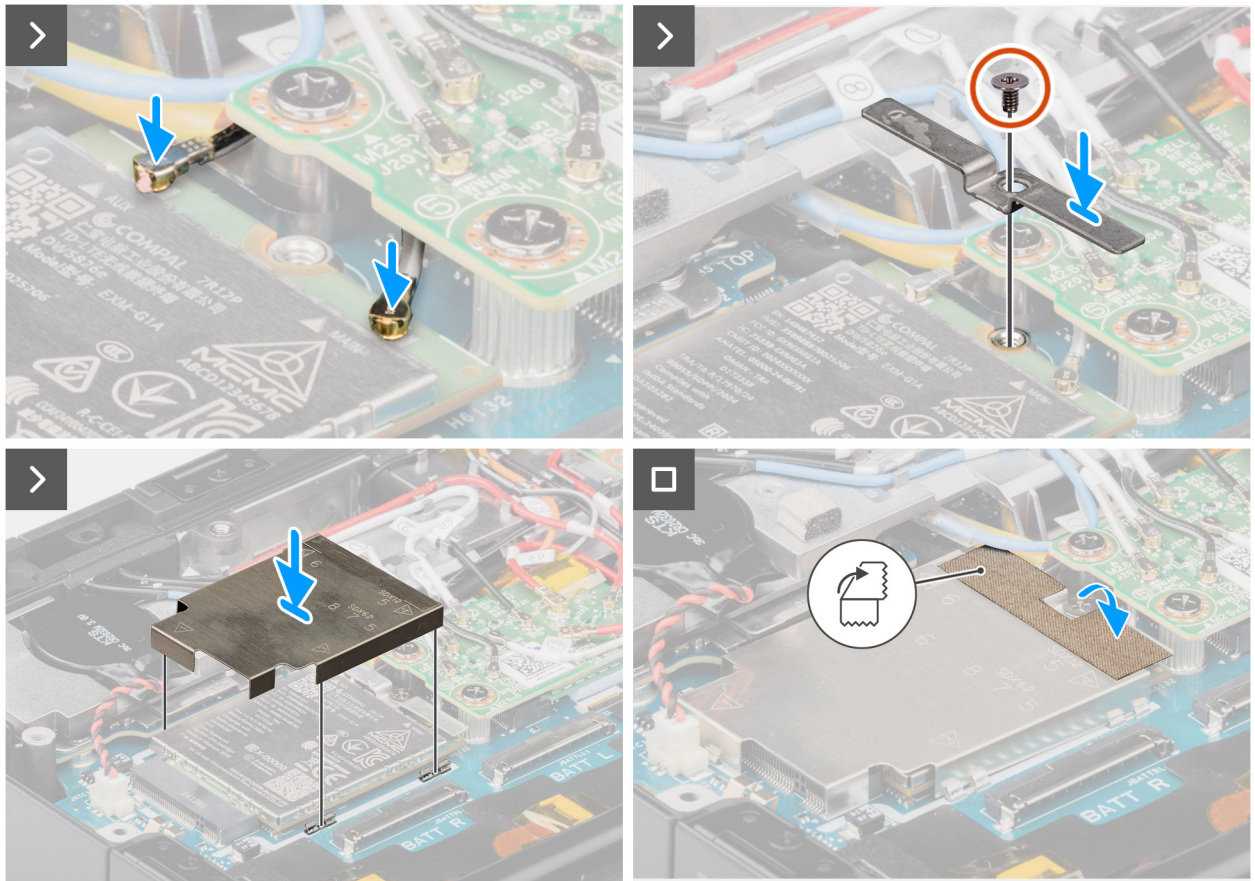

Figure 81. Installing the WWAN card (4G configuration)



1x  
M2x3

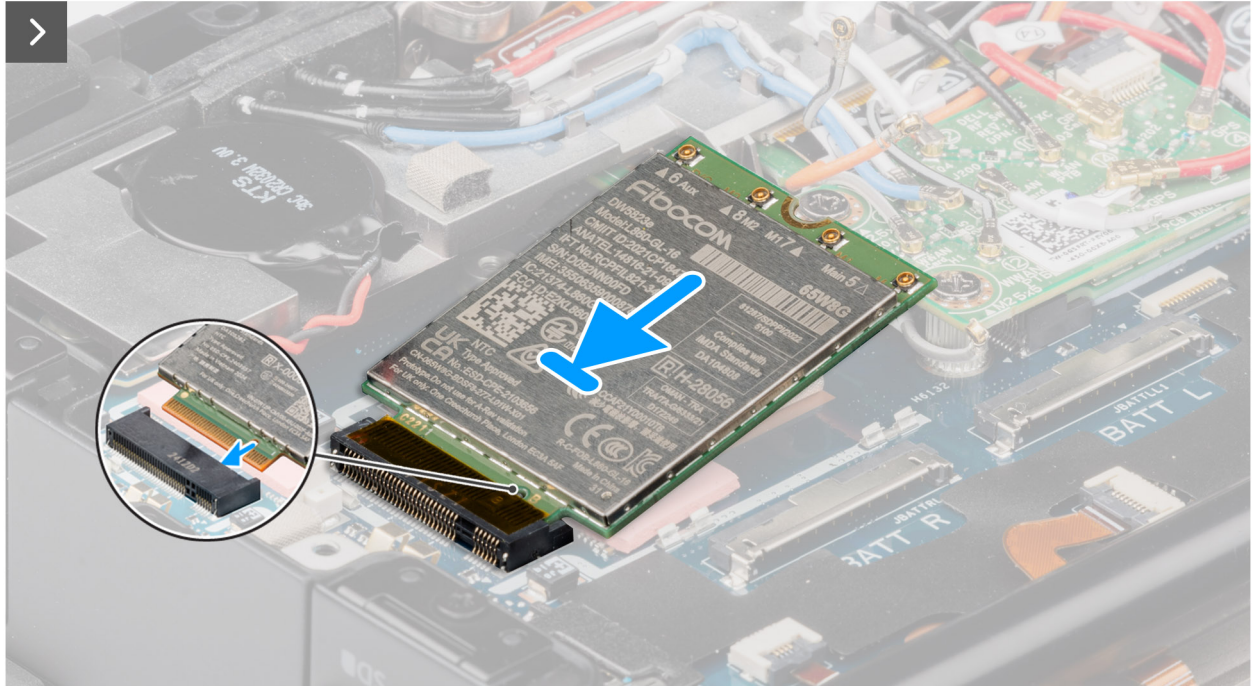
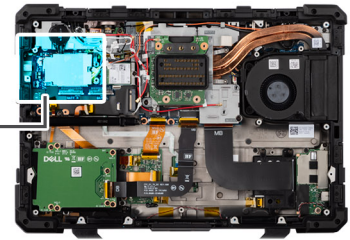
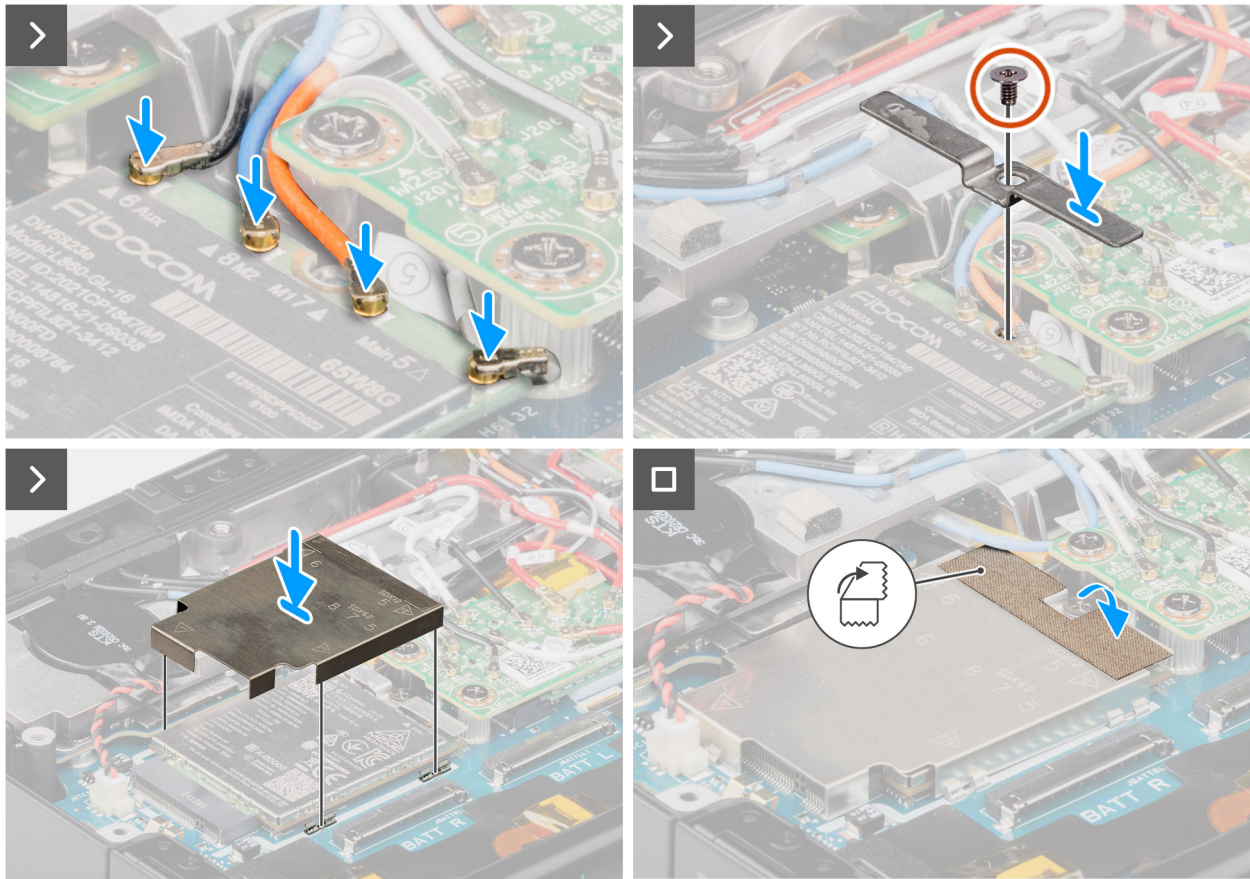

Figure 82. Installing the WWAN card (5G configuration)



**Figure 83. Installing the WWAN card (5G configuration)**

**Steps**

1. Slide the WWAN card at an angle into the WWAN card slot.
2. Connect the antenna cables to the WWAN card.

**Table 47. Connectors on the WWAN card**

| Antenna                           | Cable Color                      |
|-----------------------------------|----------------------------------|
| Main (white triangle) - ANT1      | Orange (cable number 7)          |
| Main (white triangle) - ANT3      | White and Black (cable number 6) |
| Auxiliary (black triangle) - ANT0 | White and Grey (cable number 5)  |
| Auxiliary (black triangle) - ANT2 | Blue (cable number 8)            |

3. Place the WWAN card holder on the WWAN card and replace the (M2x3) screw that secures the WWAN card holder to the system board.
4. Place the WWAN shield and press the anti-static fabric tape back into place.

**NOTE:** For instructions on how to find your computer's IMEI (International Mobile Station Equipment Identity) number, see the knowledge base article [000143678](#) at [Dell Support Site](#).

**Next steps**

1. Install the [RF switch board](#).
2. Install the [base cover](#).
3. Install the [solid state drive carrier](#).
4. Install the [batteries](#).
5. Follow the procedure in [after working inside your computer](#).

# Express-card reader

## Removing the express-card reader

**CAUTION:** The information in this removal section is intended for authorized service technicians only.

### Prerequisites

1. Follow the procedure in [before working inside your computer](#).
2. Remove the [batteries](#).
3. Remove the [solid state drive carrier](#).
4. Remove the [base cover](#).

### About this task

The following image indicates the location of the express-card reader and provides a visual representation of the removal procedure.



4x  
M2x3

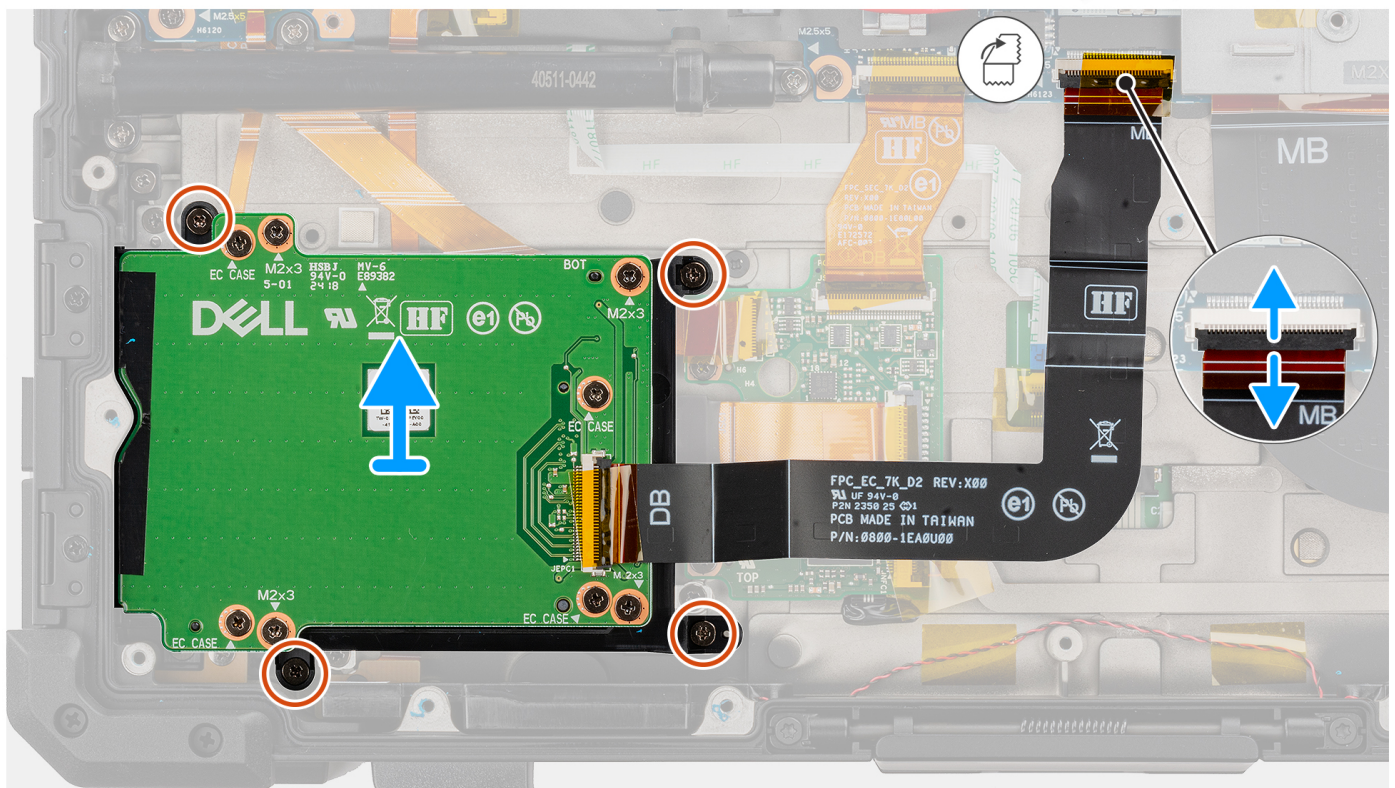
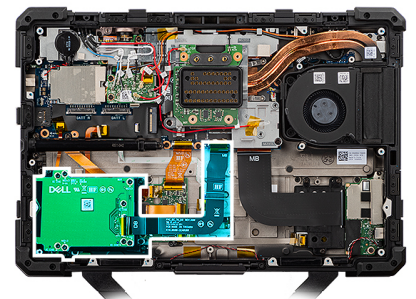

Figure 84. Removing the express-card reader

### Steps

1. Disconnect the express-card reader flat-printed cable from its connectors on the system board.

2. Remove the four (M2x3) screws that secure the express-card reader board to the express-card reader bracket.
3. Lift and remove the express-card reader bracket from the computer chassis.

## Installing the express-card reader

**CAUTION:** The information in this installation section is intended for authorized service technicians only.

### Prerequisites

If you are replacing a component, remove the existing component before performing the installation procedure.

### About this task

The following image indicates the location of the express-card reader and provides a visual representation of the installation procedure.



4x  
M2x3

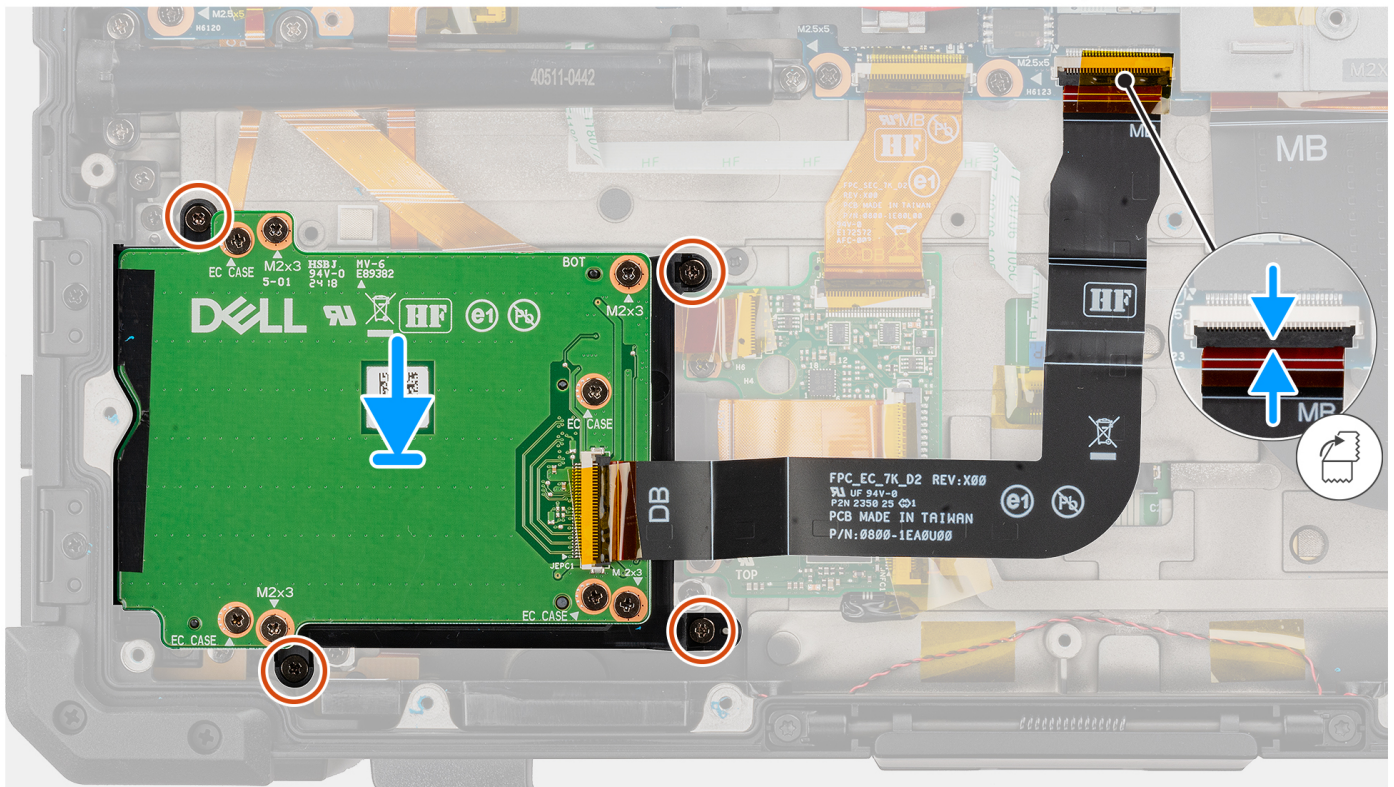
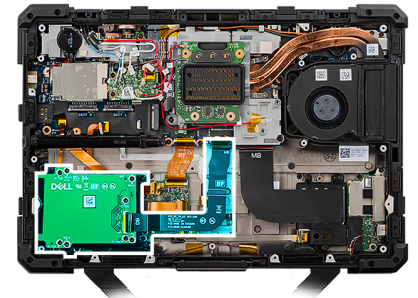

Figure 85. Installing the express-card reader

### Steps

1. Align the express-card reader bracket with the screw holes on the computer chassis.
2. Replace the four (M2x3) screws that secure the express-card reader bracket to the computer chassis.
3. Connect the express-card reader flat-printed cable to its connectors on the system board.

### Next steps

1. Install the [base cover](#).
2. Install the [solid state drive carrier](#).
3. Install the [batteries](#).
4. Follow the procedure in [after working inside your computer](#).

## Smart-card reader

### Removing the smart-card reader

 **CAUTION:** The information in this removal section is intended for authorized service technicians only.

#### Prerequisites

1. Follow the procedure in [before working inside your computer](#).
2. Remove the [solid state drive carrier](#).
3. Remove the [batteries](#).
4. Remove the [base cover](#).
5. Remove the [express-card reader](#).

#### About this task

The following image indicates the location of the smart-card reader and provides a visual representation of the removal procedure.

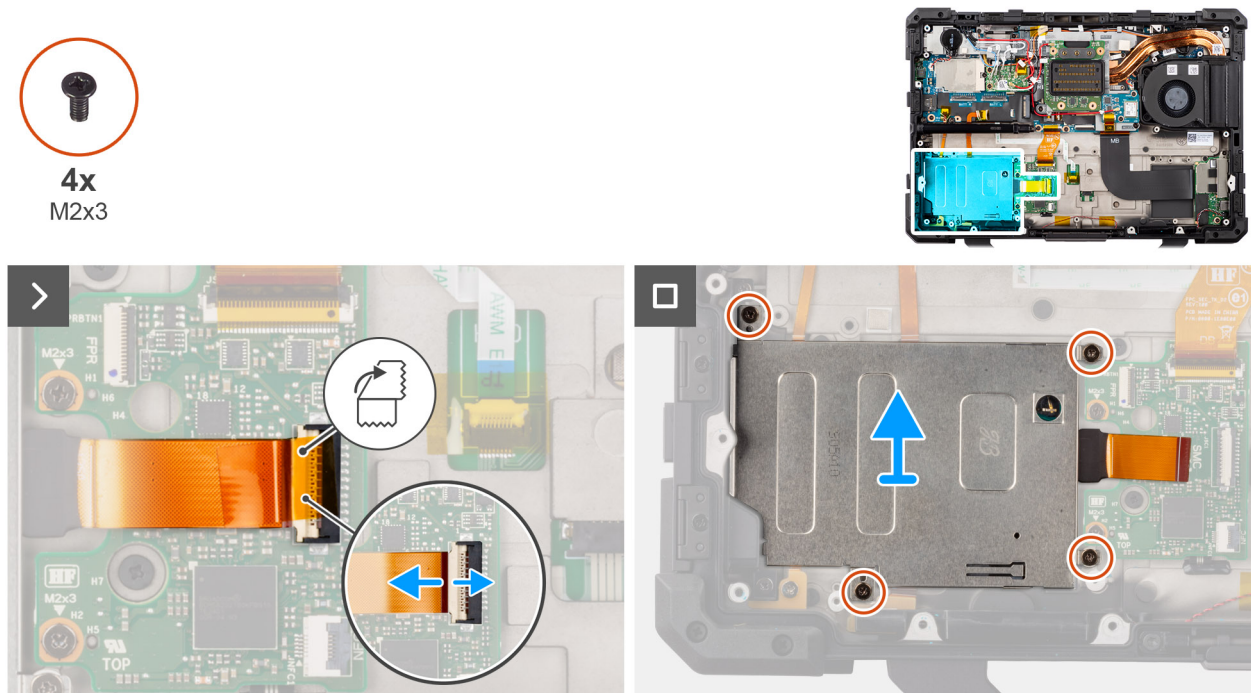

**Figure 86. Removing the smart-card reader**

#### Steps

1. Peel the adhesive tape and disconnect the smart-card reader flat-printed cable from the connector on the USH board.
2. Remove the four (M2x3) screws that secure the smart-card reader to the computer chassis.
3. Lift and remove the smart-card reader from the computer chassis.

## Installing the smart-card reader

**CAUTION:** The information in this installation section is intended for authorized service technicians only.

### Prerequisites

If you are replacing a component, remove the existing component before performing the installation procedure.

### About this task

The following image indicates the location of the smart-card reader and provides a visual representation of the installation procedure.

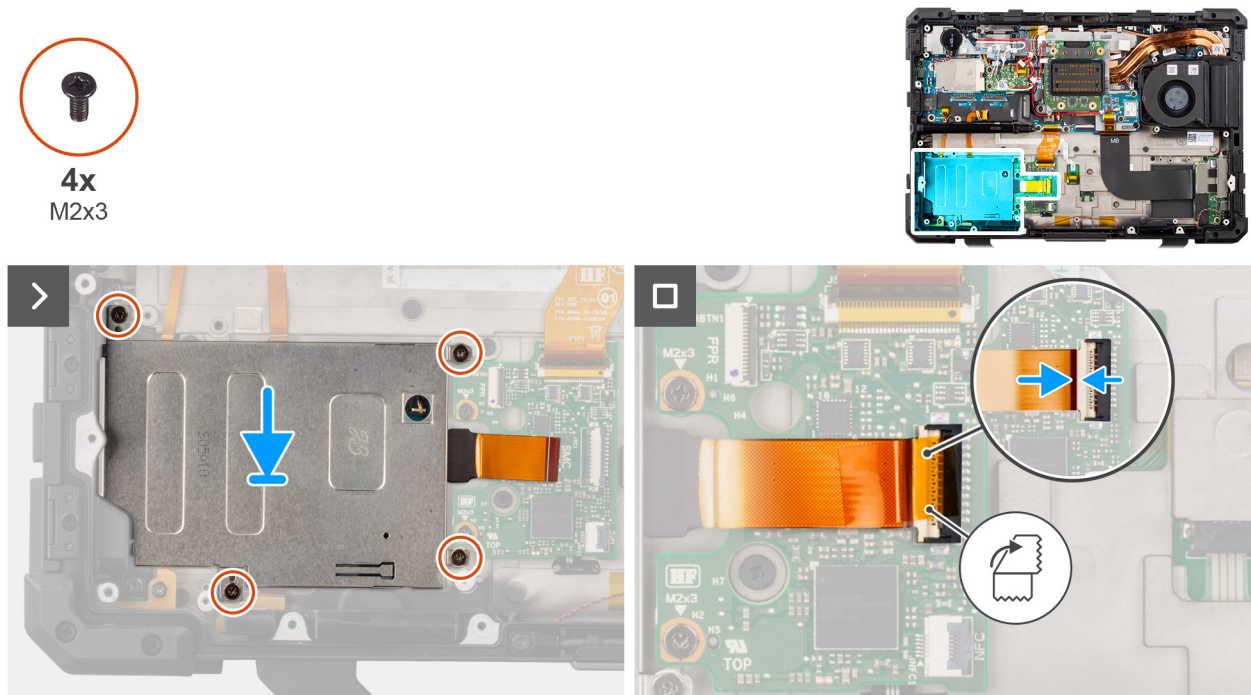

Figure 87. Installing the smart-card reader

### Steps

1. Place the smart-card reader into the slot on the computer chassis.
2. Replace the four (M2x3) screws that secure the smart-card reader to the computer chassis.
3. Connect the smart-card reader flat-printed cable to the connector on the USH board.

### Next steps

1. Install the [express-card reader](#).
2. Install the [base cover](#).
3. Install the [solid state drive carrier](#).
4. Install the [batteries](#).
5. Follow the procedure in [after working inside your computer](#).

## Smart-card and Express-card reader bracket

### Removing the smart-card and express-card reader bracket

**CAUTION:** The information in this removal section is intended for authorized service technicians only.

### Prerequisites

1. Follow the procedure in [before working inside your computer](#).
2. Remove the [solid state drive carrier](#).
3. Remove the [batteries](#).
4. Remove the [base cover](#).
5. Remove the [express-card reader](#).
6. Remove the [smart-card reader](#).

### About this task

The following image indicates the location of the smart-card and express-card reader bracket, and provides a visual representation of the removal procedure.

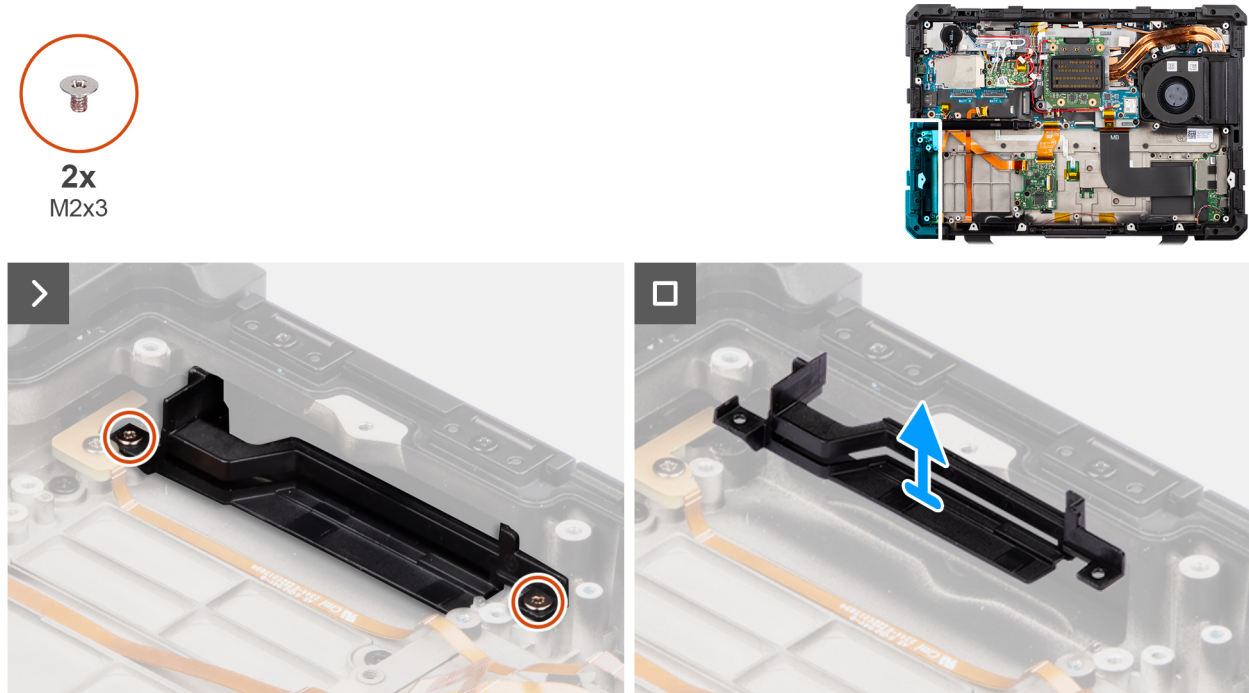

**Figure 88. Removing the smart-card and express-card reader bracket**

### Steps

1. Remove the two (M2x3) screws that secure the smart-card and express-card reader bracket to the computer chassis.
2. Lift and remove the smart-card and express-card reader bracket from the computer chassis.

## Installing the smart-card and express-card reader bracket

**CAUTION:** The information in this installation section is intended for authorized service technicians only.

### Prerequisites

If you are replacing a component, remove the existing component before performing the installation procedure.

### About this task

The following image indicates the location of the smart-card and express-card reader bracket, and provides a visual representation of the installation procedure.



2x  
M2x3

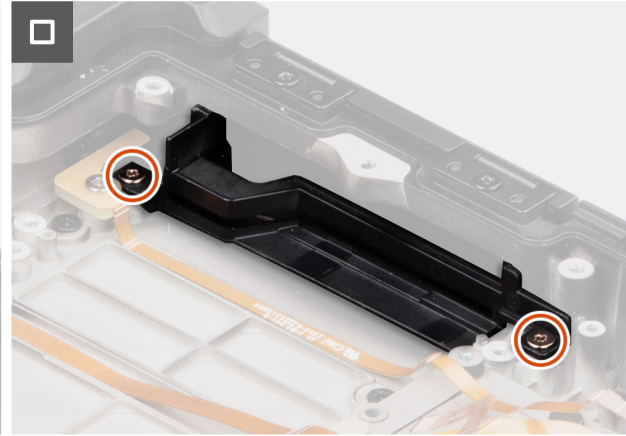
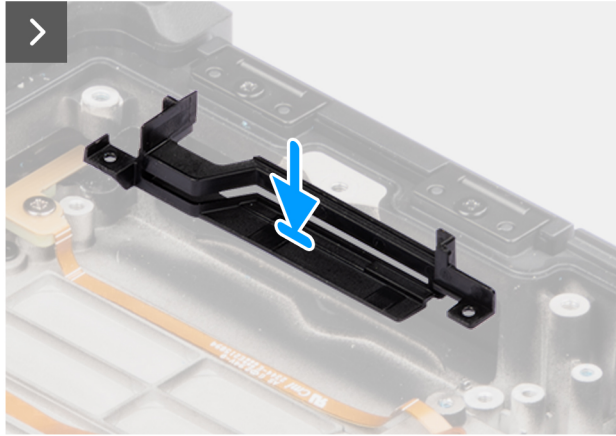
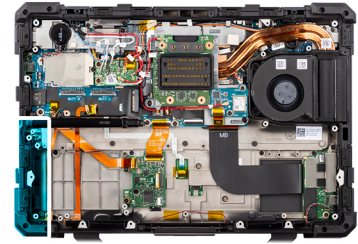

**Figure 89. Installing the smart-card and express-card reader bracket**

#### Steps

1. Align the screw holes on the smart-card and express-card reader bracket with the screw holes on the computer chassis.
2. Replace the two (M2x3) screws that secure the smart-card and express-card reader bracket to the computer chassis.

#### Next steps

1. Install the [smart-card reader](#).
2. Install the [express-card](#).
3. Install the [base cover](#).
4. Install the [solid state drive carrier](#).
5. Install the [batteries](#).
6. Follow the procedure in [after working inside your computer](#).

## Dock I/O-module

### Removing the dock I/O-module

**⚠ CAUTION:** The information in this removal section is intended for authorized service technicians only.

#### Prerequisites

1. Follow the procedure in [before working inside your computer](#).
2. Remove the [batteries](#).
3. Remove the [solid state drive carrier](#).
4. Remove the [base cover](#).

#### About this task

The following image indicates the location of the dock I/O-module and provides a visual representation of the removal procedure.

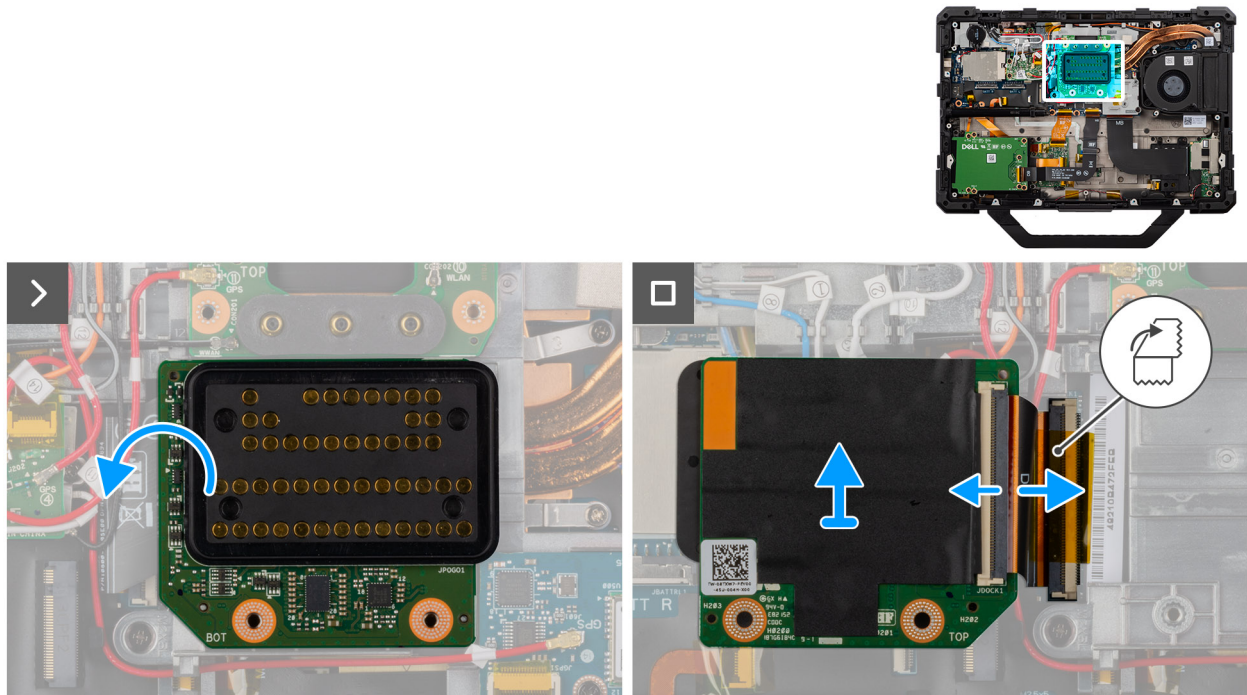

**Figure 90. Removing the dock I/O-module**

### Steps

1. Flip the dock I/O-module and disconnect the dock I/O flexible printed cable from the system board.
2. Lift the dock I/O-module from the system board.

## Installing the dock I/O-module

**CAUTION:** The information in this installation section is intended for authorized service technicians only.

### Prerequisites

If you are replacing a component, remove the existing component before performing the installation procedure.

### About this task

The following image indicates the location of the dock I/O-module and provides a visual representation of the installation procedure.

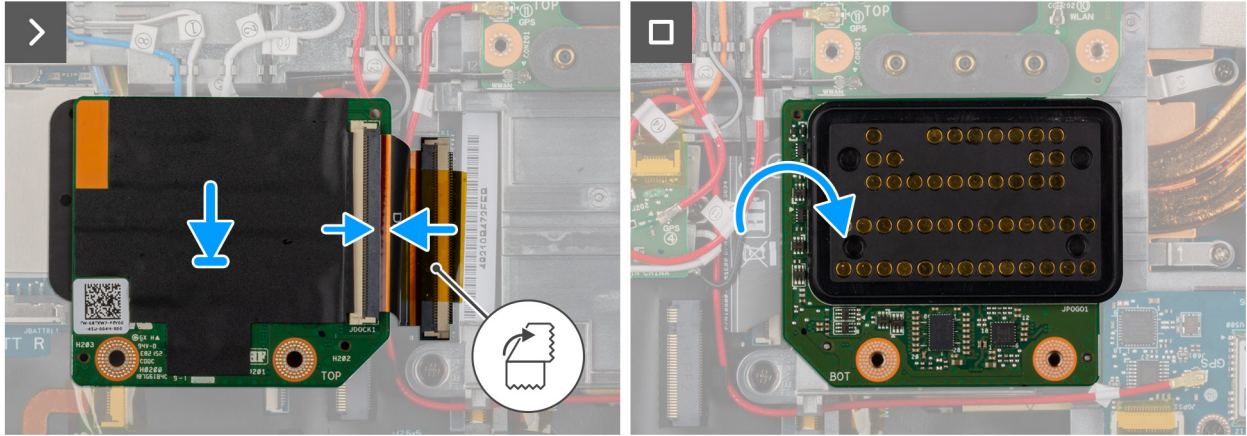
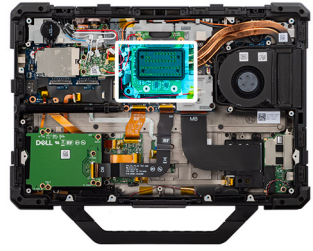

**Figure 91. Installing the dock I/O-module**

### Steps

1. Place the dock I/O-module and connect the dock I/O flexible printed cable to the system board.

**i** **NOTE:** Adhere the dock I/O flexible printed cable with kapton tapes to the connector.

2. Flip the dock I/O-module.

### Next steps

1. Install the [base cover](#).
2. Install the [solid state drive carrier](#).
3. Install the [batteries](#).
4. Follow the procedure in [after working inside your computer](#).

## Dock I/O-bracket

### Removing the dock I/O-bracket

**⚠ CAUTION:** The information in this removal section is intended for authorized service technicians only.

### Prerequisites

1. Follow the procedure in [before working inside your computer](#).
2. Remove the [batteries](#).
3. Remove the [keyboard \(rubberized\)](#) or [keyboard \(standard\)](#).
4. Remove the [solid state drive carrier](#).
5. Remove the [base cover](#).
6. Remove the [GPS board](#).
7. Remove the [rear I/O-board](#).
8. Remove the [RF switch board](#).
9. Remove the [WLAN card](#).

10. Remove the [WWAN card](#).
11. Remove the [dock I/O-module](#).

**About this task**

The following image indicates the location of the dock I/O-bracket and provides a visual representation of the removal procedure.



**4x**  
M2x5

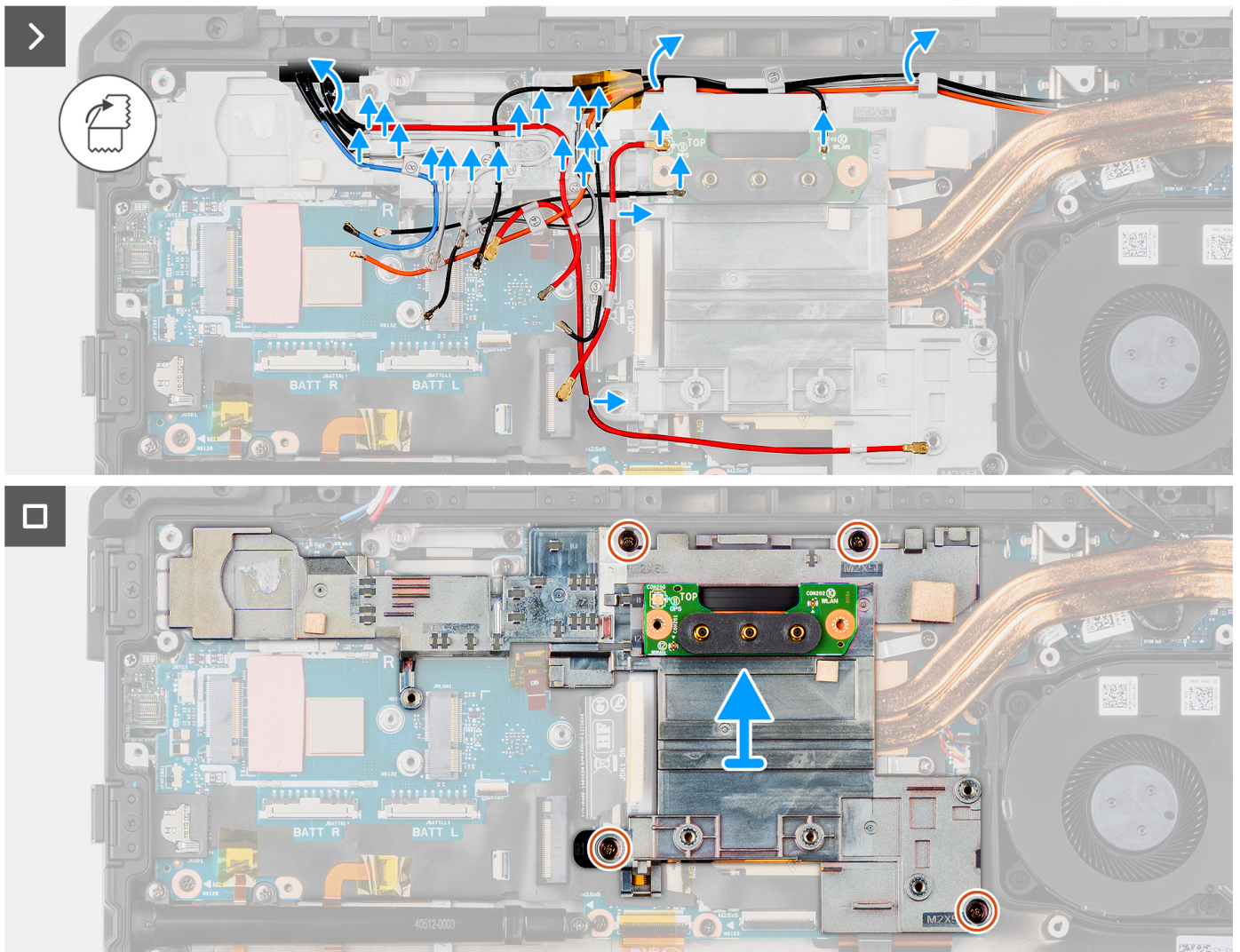
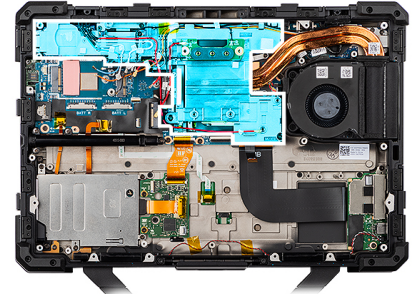

**Figure 92. Removing the dock I/O-bracket**

**Steps**

1. Unroute the WLAN, WWAN, and GPS antennas from their routing guides on the computer chassis.
2. Remove the four (M2x5) screws that secure the dock I/O-bracket to the system board.
3. Lift and remove the dock I/O-bracket from the system board.

## Installing the dock I/O-bracket

**CAUTION:** The information in this installation section is intended for authorized service technicians only.

### Prerequisites

If you are replacing a component, remove the existing component before performing the installation procedure.

### About this task

The following image indicates the location of the dock I/O-bracket and provides a visual representation of the installation procedure.



4x  
M2x5

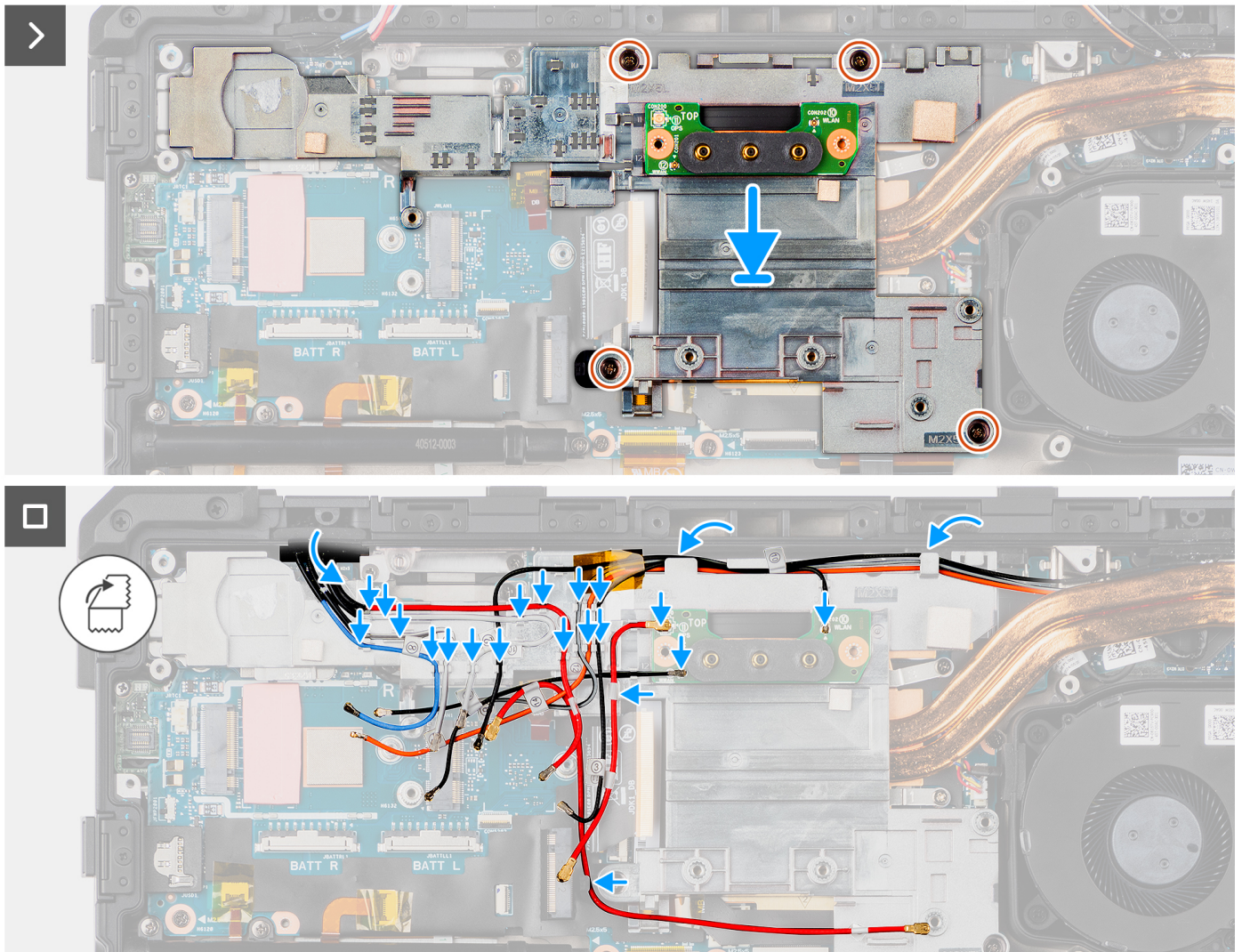
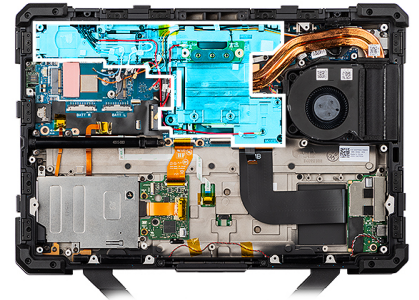

Figure 93. Installing the dock I/O-bracket

## Steps

1. Align the dock I/O-bracket with the screw holes on the system board.
2. Replace the four (M2x5) screws that secure the dock I/O-bracket to the system board.
3. Route the WLAN, WWAN, and GPS antennas through their routing guides on the computer chassis.

## Next steps

1. Install the [dock I/O-module](#).
2. Install the [WWAN card](#).
3. Install the [WLAN card](#).
4. Install the [RF switch board](#).
5. Install the [rear I/O-board](#).
6. Install the [GPS board](#).
7. Install the [base cover](#).
8. Install the [solid state drive carrier](#).
9. Install the [keyboard \(rubberized\)](#) or [keyboard \(standard\)](#).
10. Install the [batteries](#).
11. Follow the procedure in [after working inside your computer](#).

# Heat sink

## Removing the heat sink

 **CAUTION:** The information in this removal section is intended for authorized service technicians only.

### Prerequisites

1. Follow the procedure in [before working inside your computer](#).
2. Remove the [batteries](#).
3. Remove the [solid state drive carrier](#).
4. Remove the [base cover](#).
5. Remove the [RF switch board](#).
6. Remove the [WLAN card](#).
7. Remove the [rear I/O-board](#).
8. Remove the [dock I/O-module](#).
9. Remove the [dock I/O-bracket](#).

### About this task

The following image indicates the location of the heat sink and provides a visual representation of the removal procedure.

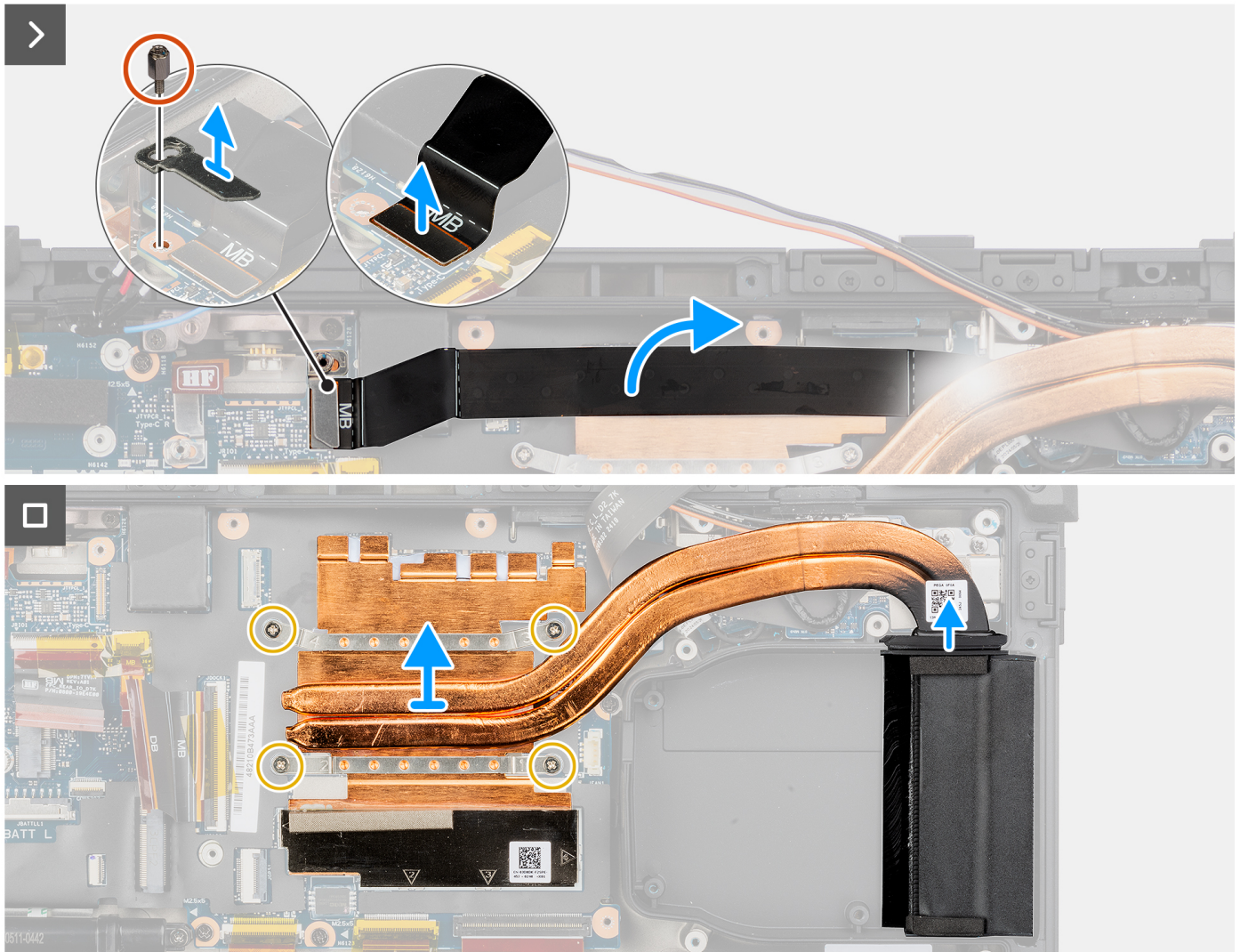
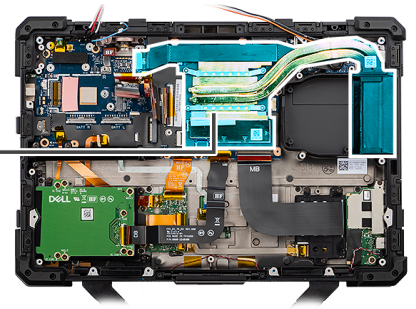
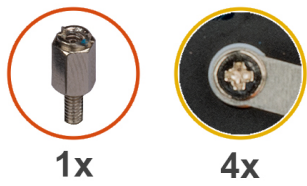

**Figure 94. Removing the heat sink**

### Steps

1. Remove the standoff nut and remove the flat printed cable connector bracket from the system board.
2. Disconnect the left Type-C flat-printed cable connector from the system board.
3. Remove the four (captive) screws that secure the heat sink to the system board.
4. Lift the heat sink from the computer chassis.

## Installing the heat sink

**CAUTION:** The information in this installation section is intended for authorized service technicians only.



### Next steps

1. Install the [dock I/O-bracket](#).
2. Install the [dock I/O-module](#).
3. Install the [rear I/O-board](#).
4. Install the [WLAN card](#).
5. Install the [RF switch board](#).
6. Install the [base cover](#).
7. Install the [solid state drive carrier](#).
8. Install the [batteries](#).
9. Follow the procedure in [after working inside your computer](#).

## System board

### Removing the system board

 **CAUTION:** The information in this removal section is intended for authorized service technicians only.

#### Prerequisites

1. Follow the procedure in [before working inside your computer](#).
2. Remove the [batteries](#).
3. Remove the [keyboard \(rubberized\)](#) or [keyboard \(standard\)](#).
4. Remove the [solid state drive carrier](#).
5. Remove the [base cover](#).
6. Remove the [stylus holder](#).
7. Remove the [GPS board](#).
8. Remove the [rear I/O-board](#).
9. Remove the [RF switch board](#).
10. Remove the [WLAN card](#).
11. Remove the [WWAN card](#).
12. Remove the [dock I/O-module](#).
13. Remove the [dock I/O-bracket](#).
14. Remove the [fan](#).
15. Remove the [heat sink](#).
16. Remove the [left Type-C board](#).
17. Remove the [right Type-C board](#).

#### About this task

The following images indicate the connectors on your system board.

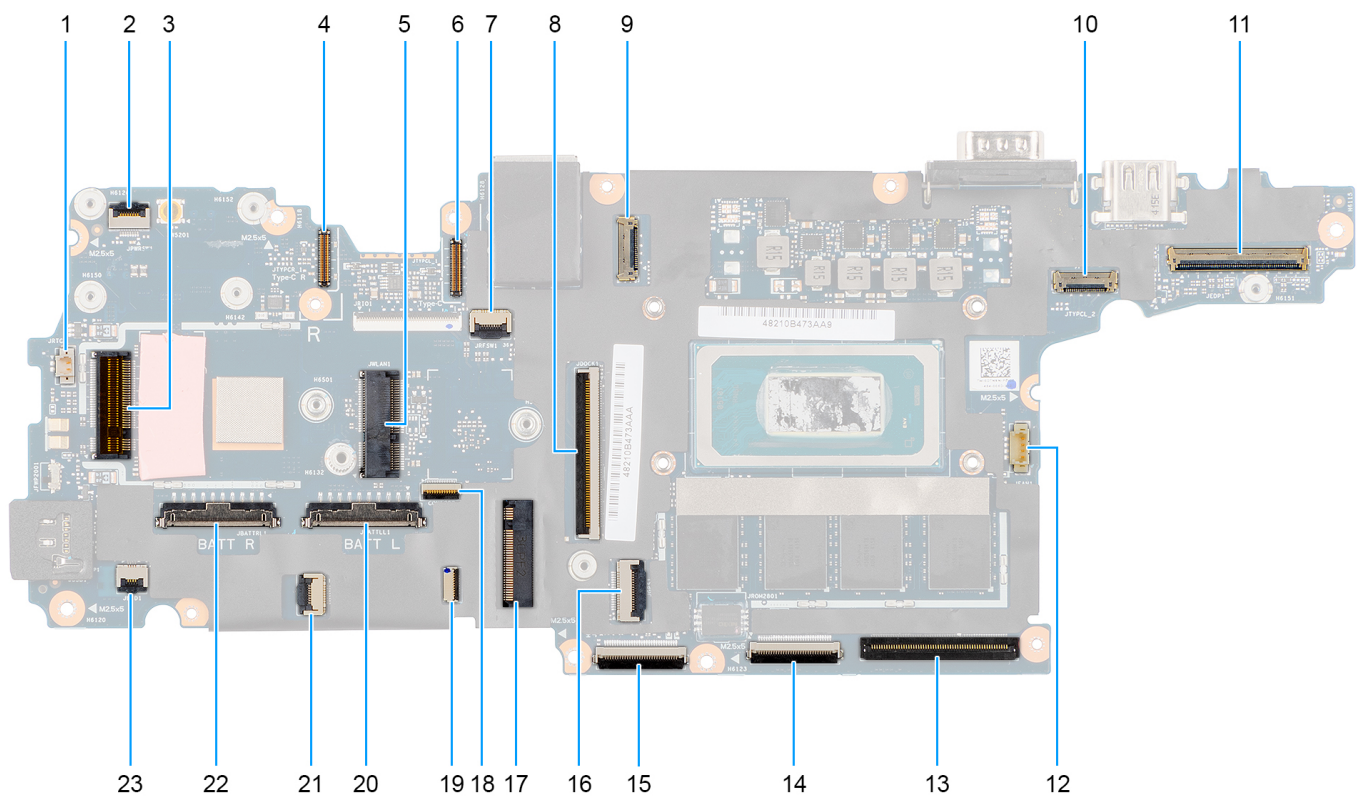

**Figure 96. System board connectors**

1. Coin-cell battery connector
2. Power button board cable connector
3. WWAN card connector
4. Right Type-C cable connector
5. WLAN card connector
6. Left Type-C cable connector
7. RF switch board connector
8. Dock I/O flat printed cable connector
9. Right Type-C flat printed cable connector
10. Left Type-C flat printed cable connector
11. eDP cable connector
12. Fan cable connector
13. Left I/O-board flat printed cable connector
14. Express card reader board connector
15. USH board connector
16. GPS connector
17. M.2 2230/2280 solid state drive connector
18. Smart card reader connector
19. NFC connector
20. Left battery cable connector
21. LED board connector
22. Right battery cable connector
23. Hall sensor

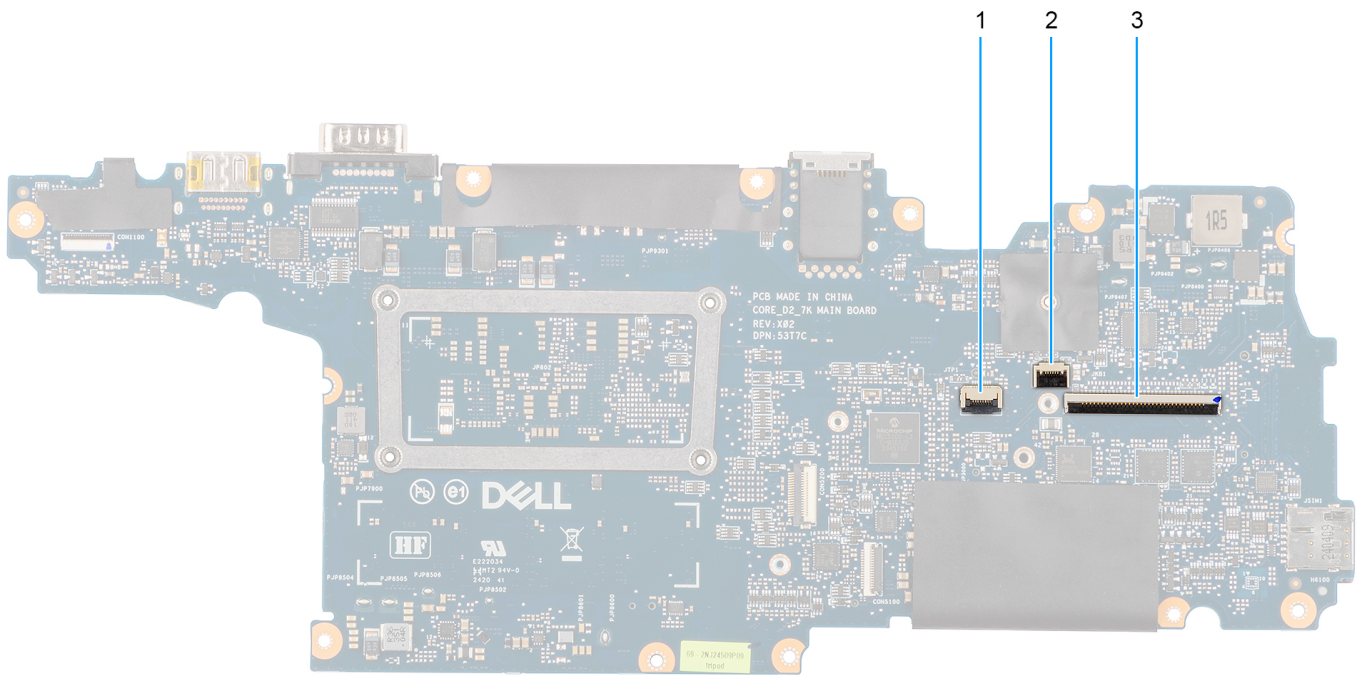

**Figure 97. System board connectors**

1. Touchpad cable connector
2. Backlight flat printed cable connector
3. Keyboard cable connector

The following images indicate the location of the system board and provide a visual representation of the removal procedure.

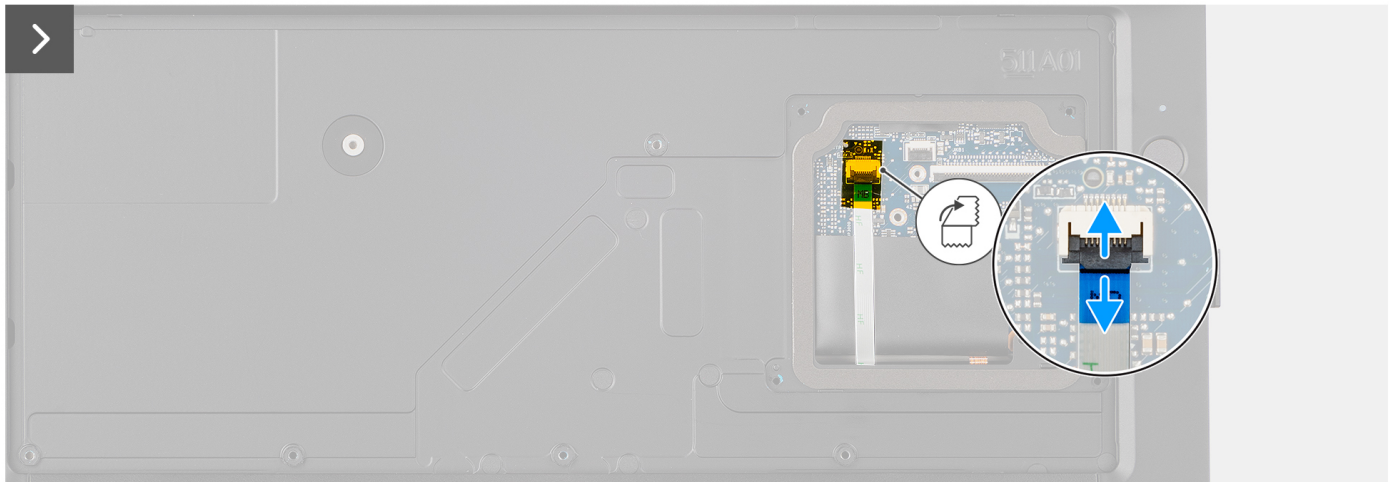
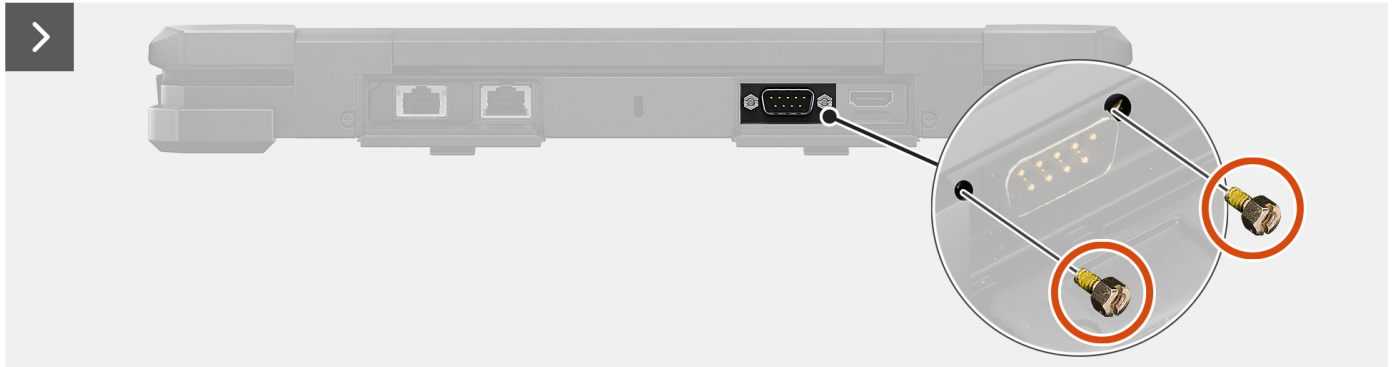
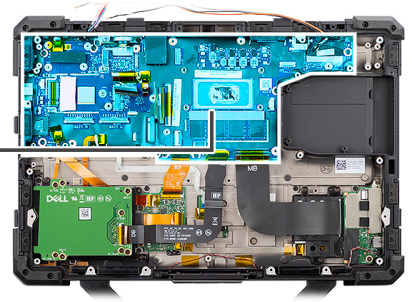

Figure 98. Removing the system board

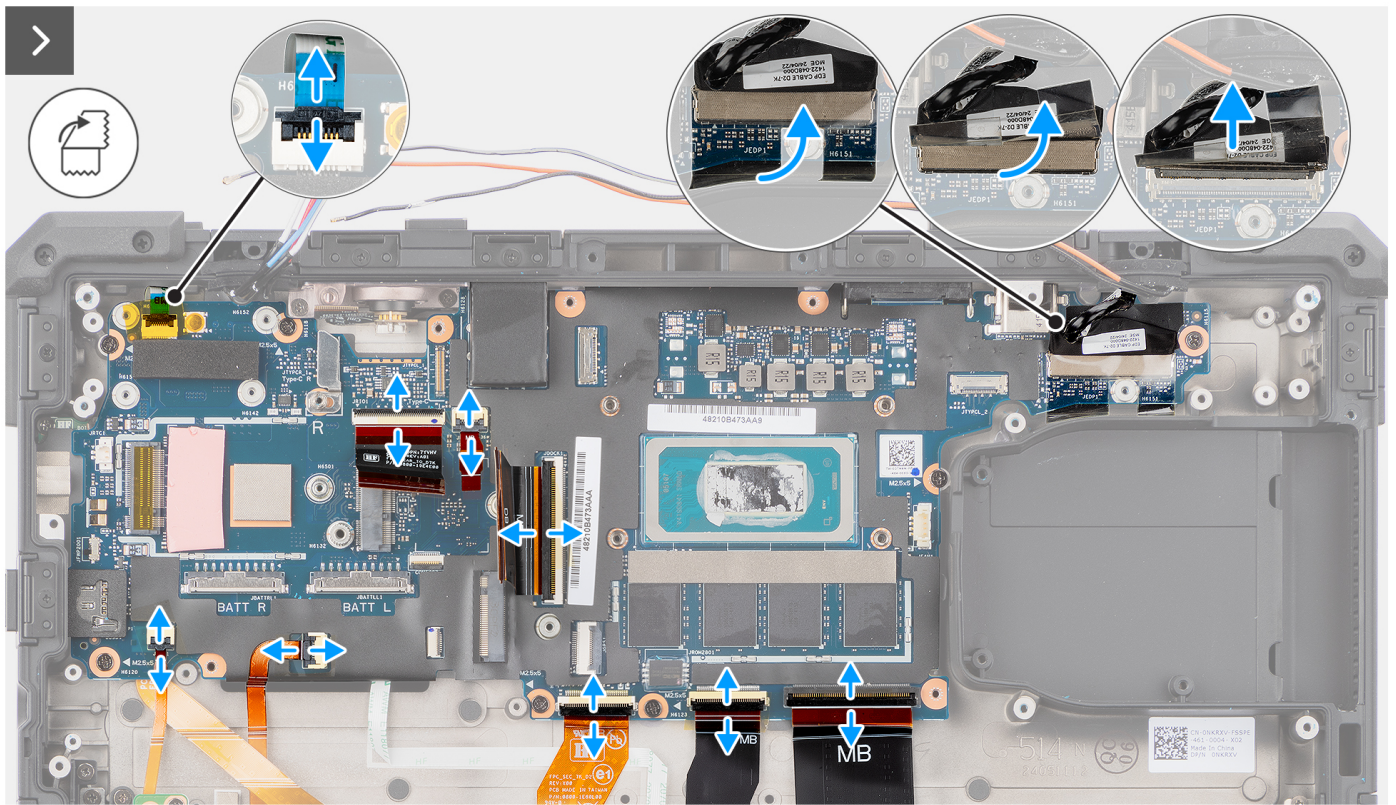
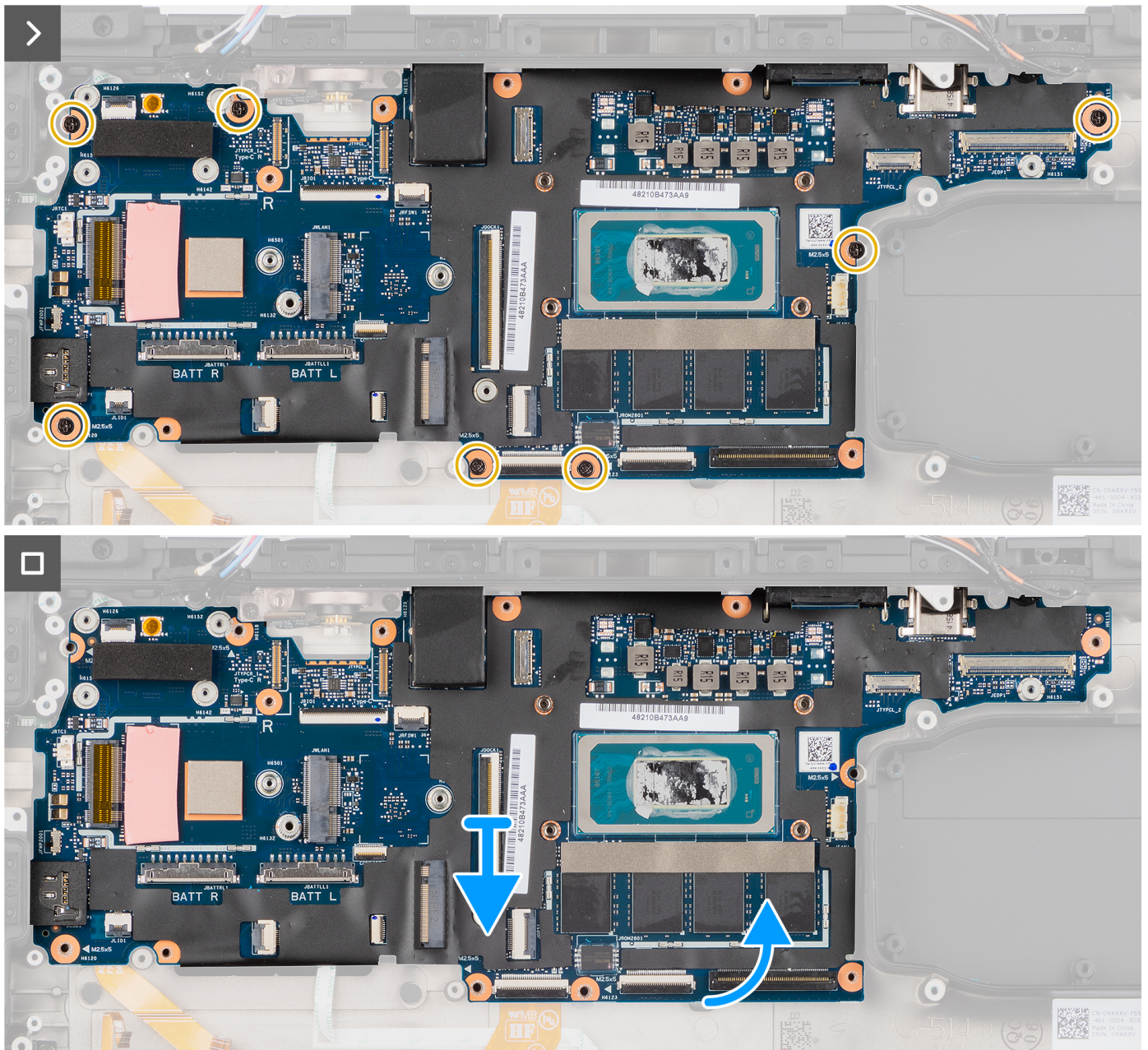

Figure 99. Removing the system board



**Figure 100. Removing the system board**

**Steps**

1. Remove the two epoxy cap screws that secure the serial RS-232 port to the computer chassis and then remove the serial RS-232 port from the computer chassis.

**i NOTE:** The epoxy screw locations require additional focus. These screws are difficult to remove, and damage might occur during the removal process. To prevent damage to the screws and surrounding plastics, please use the correct screwdriver for each screw type.

**i NOTE:** To remove the epoxy cap screws, use a 5.5 mm hex socket wrench.

2. Disconnect the touchpad flat printed cable from its connector on the system board.
3. Disconnect the following cables from their connector on the system board : power button board, RF switch board, Dock I/O flat printed cable, EDP cable, Left I/O board flat printed cable connector, express card reader board connector, USH board connector, smart card reader connector, and LED board connector.
4. Remove the seven (M2.5x5) screws that secure the system board to the computer chassis and lift the system board.

# Installing the system board

**CAUTION:** The information in this installation section is intended for authorized service technicians only.

## Prerequisites

If you are replacing a component, remove the existing component before performing the installation procedure.

## About this task

The following image indicates the connectors on your system board.

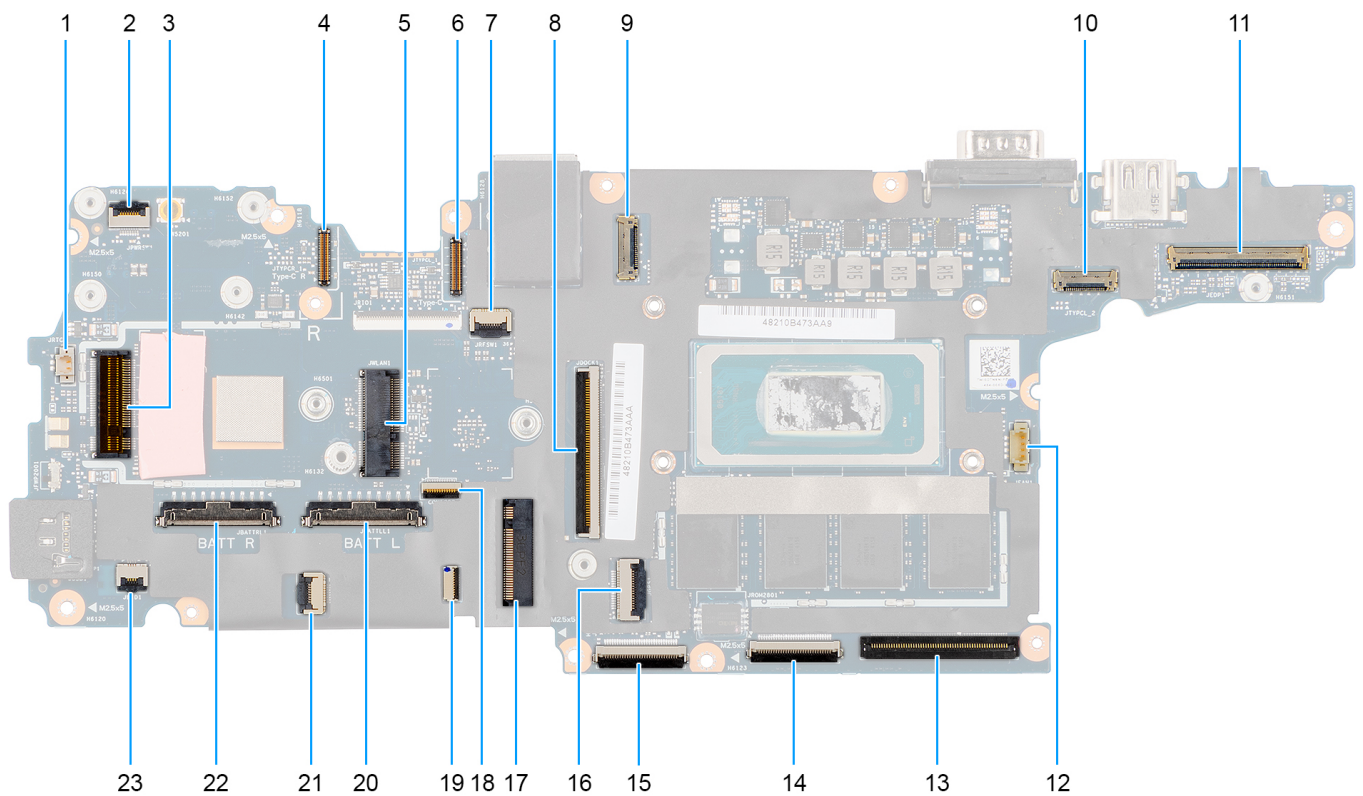

**Figure 101. System board connectors**

1. Coin-cell battery connector
2. Power-button board cable connector
3. WWAN card connector
4. Right Type-C cable connector
5. WLAN card connector
6. Left Type-C cable connector
7. RF switch board connector
8. Dock I/O flat printed cable connector
9. Right Type-C flat printed cable connector
10. Left Type-C flat printed cable connector
11. eDP cable connector
12. Fan cable connector
13. Left I/O-board flat printed cable connector

- 14. Express card reader board connector
- 15. USH board connector
- 16. GPS connector
- 17. M.2 2230/2280 solid state drive connector
- 18. Smart card reader connector
- 19. NFC connector
- 20. Left battery cable connector
- 21. LED board connector
- 22. Right battery cable connector
- 23. Hall sensor

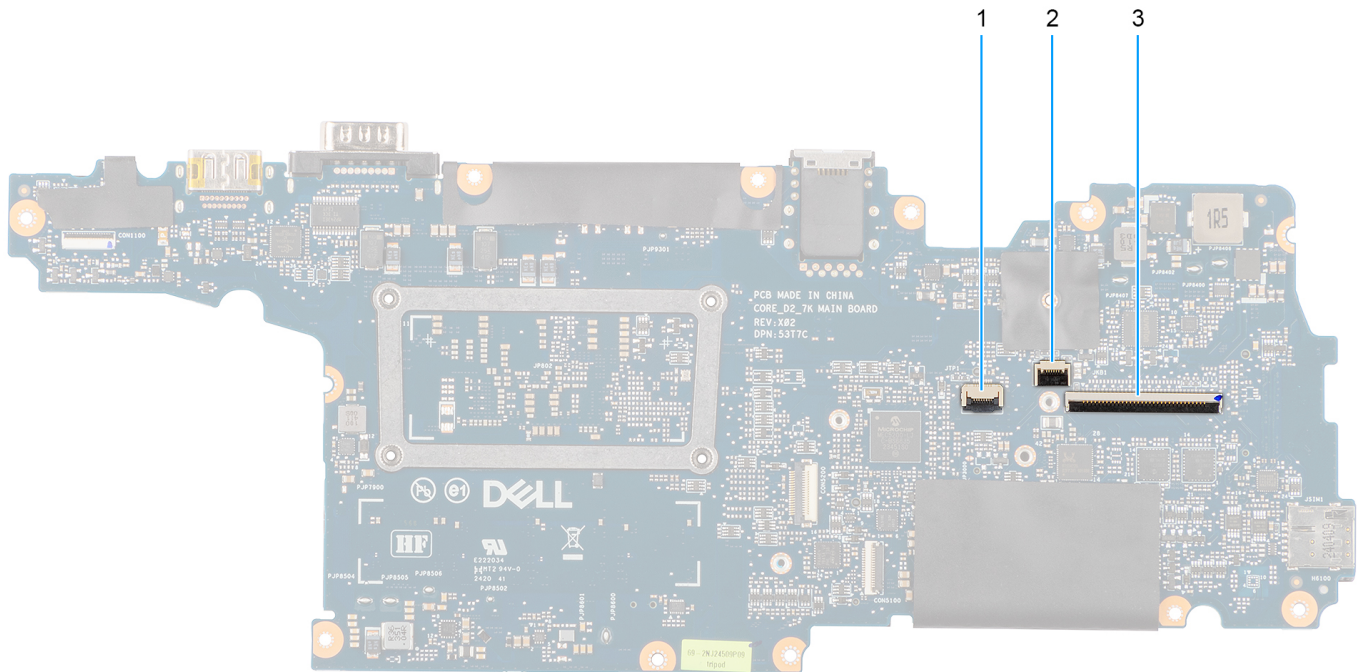

**Figure 102. System board connectors**

- 1. Touchpad cable connector
- 2. Backlight flat printed cable connector
- 3. Keyboard cable connector

The following images indicate the location of the system board and provide a visual representation of the removal procedure.

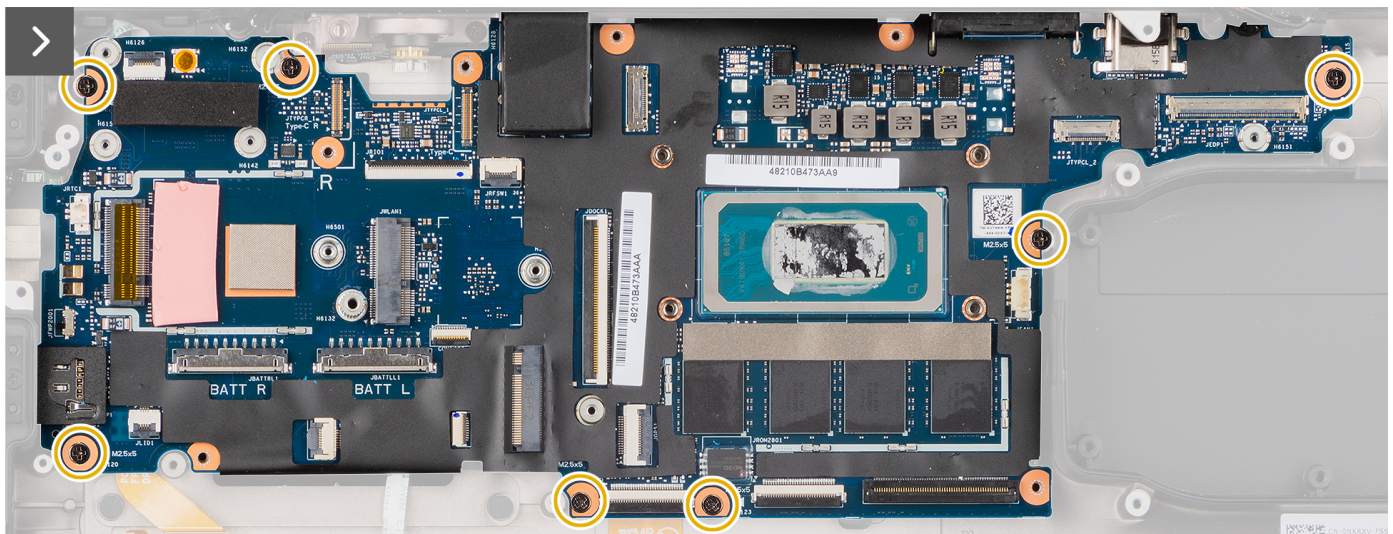
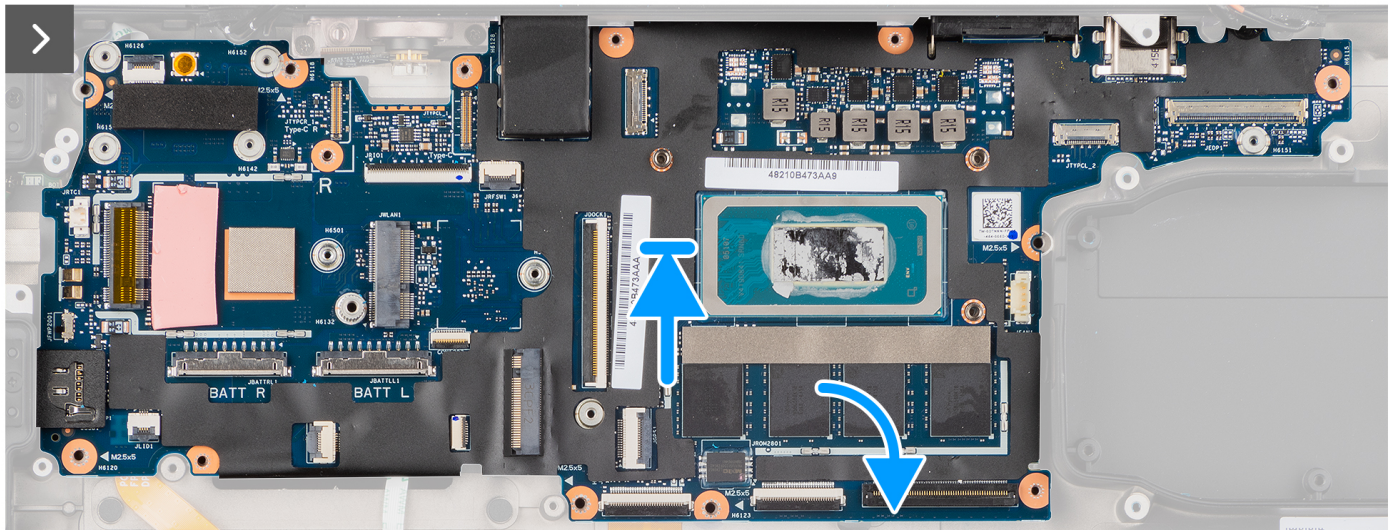
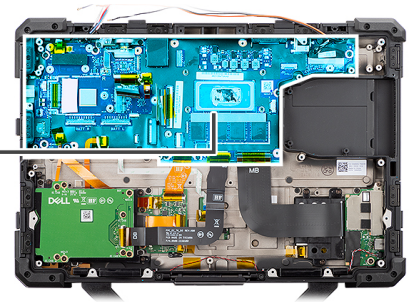

Figure 103. Installing the system board



## Steps

1. Place the system board and replace the seven (M2.5x5) screws that secure the system board to the computer chassis.
2. Connect the following cables to their connector on the system board : power button board, RF switch board, Dock I/O flat printed cable, EDP cable, Left I/O board flat printed cable connector, express card reader board connector, USH board connector, smart card reader connector, and LED board connector.
3. Replace the four (M2x3.5) screws that secure the cable cover to the system board.
4. Connect the touchpad flat printed cable to its connector on the system board.

## Next steps

1. Install the [right Type-C board](#).
2. Install the [left Type-C board](#).
3. Install the [heat sink](#).
4. Install the [fan](#).
5. Install the [dock I/O-bracket](#).
6. Install the [dock I/O-module](#).
7. Install the [WWAN card](#).
8. Install the [WLAN card](#).
9. Install the [RF switch board](#).
10. Install the [rear I/O-board](#).
11. Install the [GPS board](#).
12. Install the [stylus holder](#).
13. Install the [base cover](#).
14. Install the [solid state drive carrier](#).
15. Install the [keyboard \(rubberized\)](#) or [keyboard \(standard\)](#).
16. Install the [batteries](#).
17. Follow the procedure in [after working inside your computer](#).

# Right Type-C board

## Removing the right Type-C board

 **CAUTION:** The information in this removal section is intended for authorized service technicians only.

### Prerequisites

1. Follow the procedure in [before working inside your computer](#).
2. Remove the [batteries](#).
3. Remove the [solid state drive carrier](#).
4. Remove the [keyboard \(rubberized\)](#) or [keyboard \(standard\)](#).
5. Remove the [base cover](#).
6. Remove the [GPS board](#).
7. Remove the [rear I/O-board](#).
8. Remove the [RF switch board](#).
9. Remove the [WLAN card](#).
10. Remove the [WWAN card](#).
11. Remove the [dock I/O-module](#).
12. Remove the [dock I/O bracket](#).
13. Remove the [fan](#).
14. Remove the [heat sink](#).

### About this task

The following image indicates the location of the right Type-C board and provides a visual representation of the removal procedure.

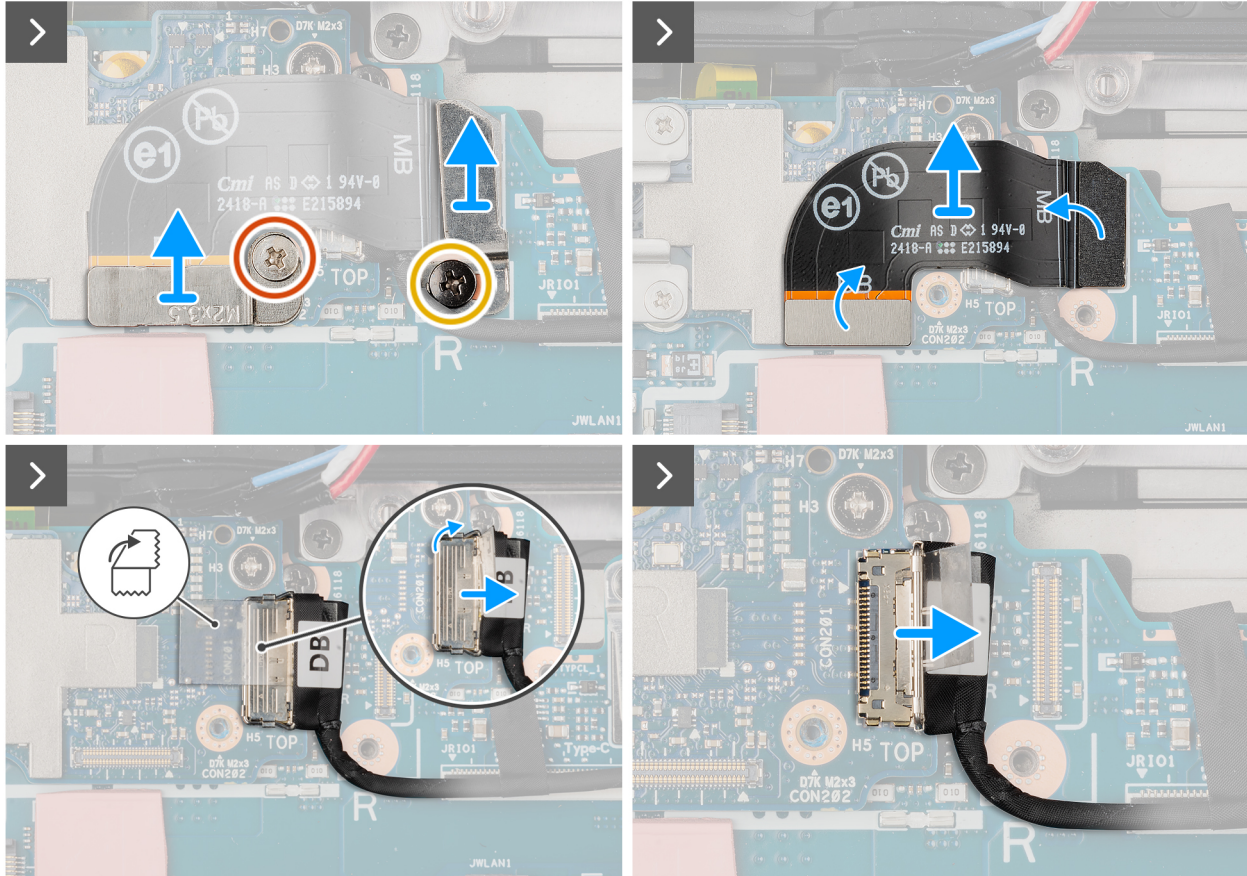
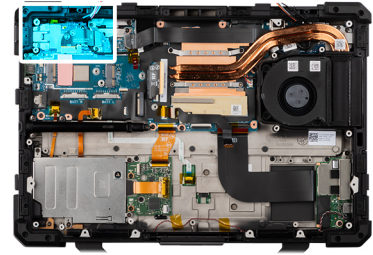

Figure 106. Removing the right Type-C board

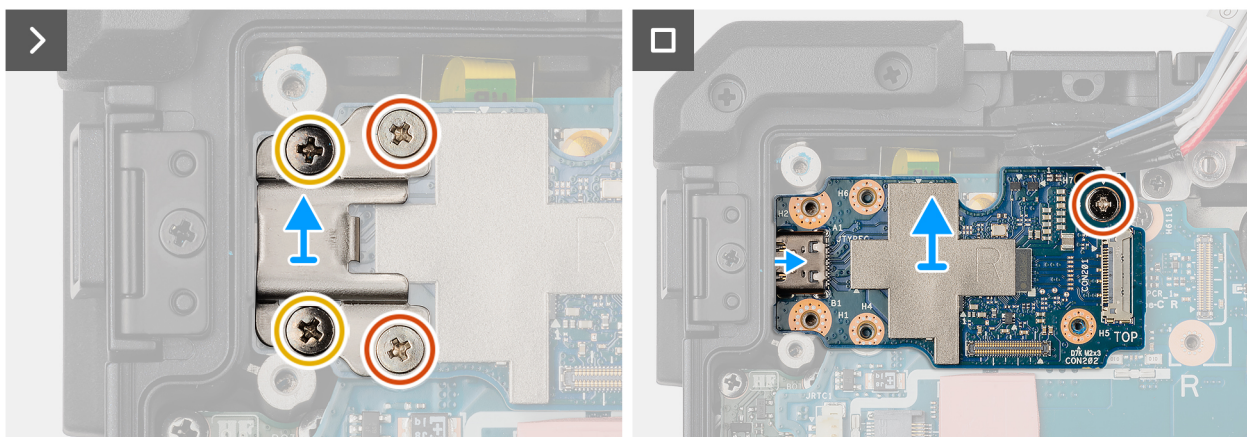

Figure 107. Removing the right Type-C board

**Steps**

1. Remove the (M2x3.5) and (M2.5x5) screw that secures the flat printed cable holder to the right Type-C board.

2. Disconnect the flat printed cable from its connector on the right Type-C board.
3. Disconnect the right Type-C cable from its connector on the right Type-C board.
4. Remove the two (M2x3.5) and (M2.5x5) screws that secure the right Type-C port holder on the right Type-C board.
5. Remove the (M2x3.5) screw that secures the right Type-C board and lift the board from the computer chassis.

## Installing the right Type-C board

**CAUTION:** The information in this installation section is intended for authorized service technicians only.

### Prerequisites

If you are replacing a component, remove the existing component before performing the installation procedure.

### About this task

The following image indicates the location of the right Type-C board and provides a visual representation of the installation procedure.

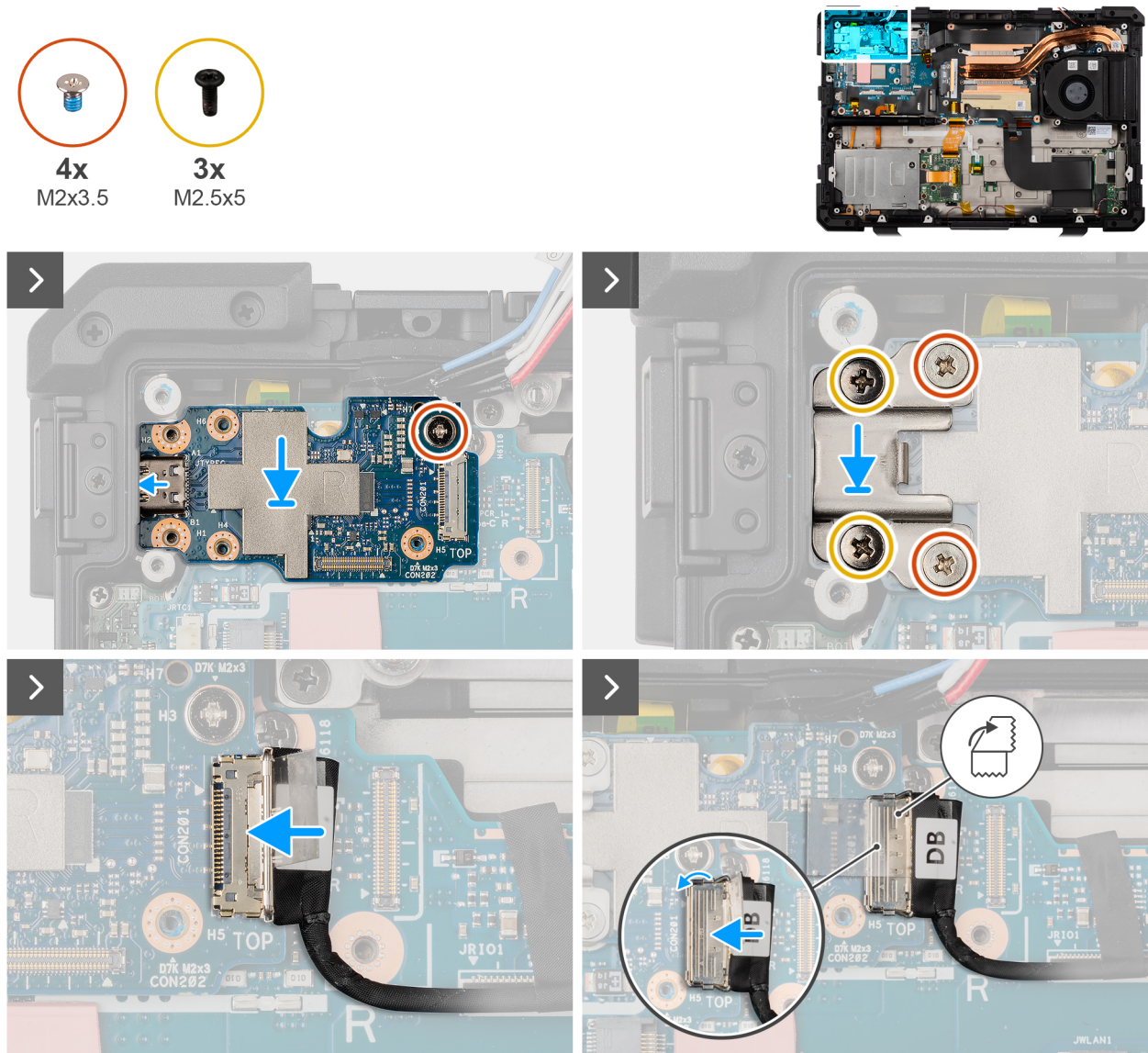
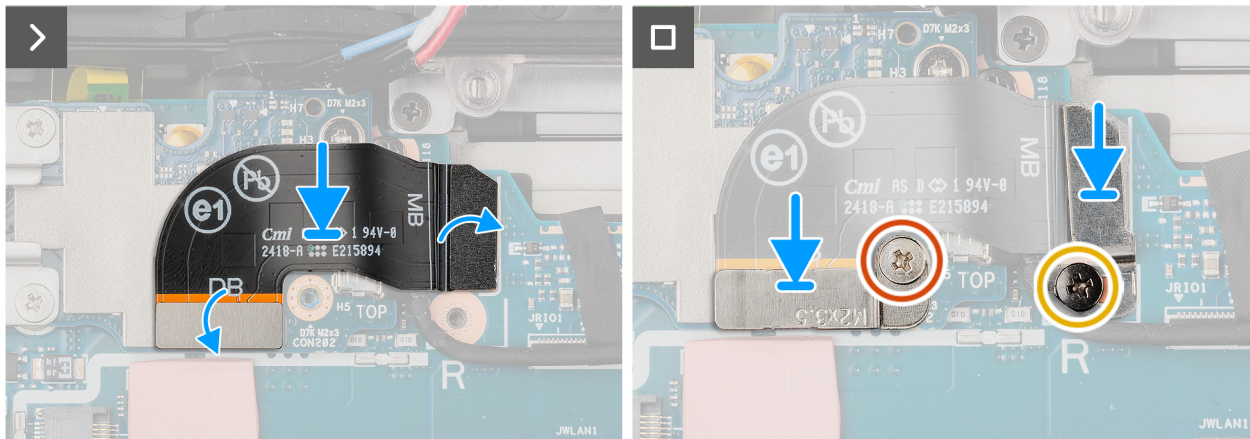

Figure 108. Installing the right Type-C board



**Figure 109. Installing the right Type-C board**

### Steps

1. Place the right Type-C board on the computer chassis and replace the (M2x3.5) screw to secure the right Type-C board to the computer chassis.
2. Place the right Type-C port holder on the right Type-C board and replace the two (M2.5x5) and (M2x3.5) screws to secure it.
3. Connect the right Type-C cable connector to its connector on the right Type-C board.
4. Connect the flat printed cable to its connector on the right Type-C board.
5. Place the flat printed cable holder and replace the (M2.5x5) and (M2x3.5) screw to secure it.

### Next steps

1. Install the [heat sink](#) .
2. Install the [fan](#).
3. Install the [dock I/O-bracket](#).
4. Install the [dock I/O-module](#).
5. Install the [WWAN card](#).
6. Install the [WLAN card](#).
7. Install the [RF switch board](#).
8. Install the [rear I/O-board](#).
9. Install the [GPS board](#).
10. Install the [base cover](#).
11. Install the [keyboard \(rubberized\)](#) or [keyboard \(standard\)](#).
12. Install the [solid state drive carrier](#).
13. Install the [batteries](#).
14. Follow the procedure in [after working inside your computer](#).

## Left Type-C board

### Removing the left Type-C board

**⚠ CAUTION:** The information in this removal section is intended for authorized service technicians only.

#### Prerequisites

1. Follow the procedure in [before working inside your computer](#).
2. Remove the [batteries](#).
3. Remove the [solid state drive carrier](#).
4. Remove the [keyboard \(rubberized\)](#) or [keyboard \(standard\)](#).
5. Remove the [base cover](#).

6. Remove the [GPS board](#).
7. Remove the [rear I/O-board](#).
8. Remove the [RF switch board](#).
9. Remove the [WLAN card](#).
10. Remove the [WWAN card](#).
11. Remove the [dock I/O-module](#).
12. Remove the [dock I/O bracket](#).
13. Remove the [fan](#).
14. Remove the [heat sink](#).

**About this task**

The following image indicates the location of the left Type-C board and provides a visual representation of the removal procedure.

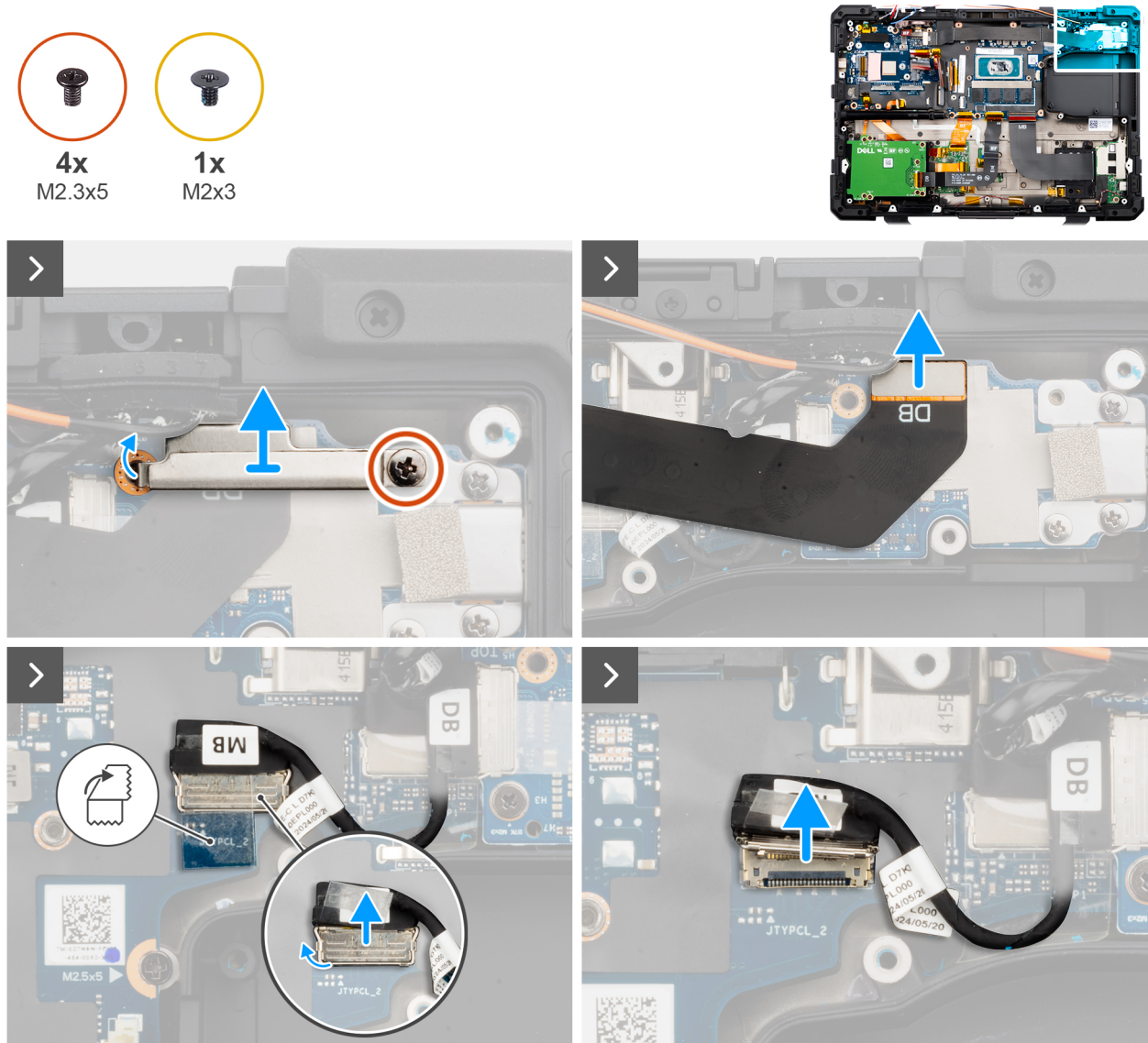

**Figure 110. Removing the left Type-C board**

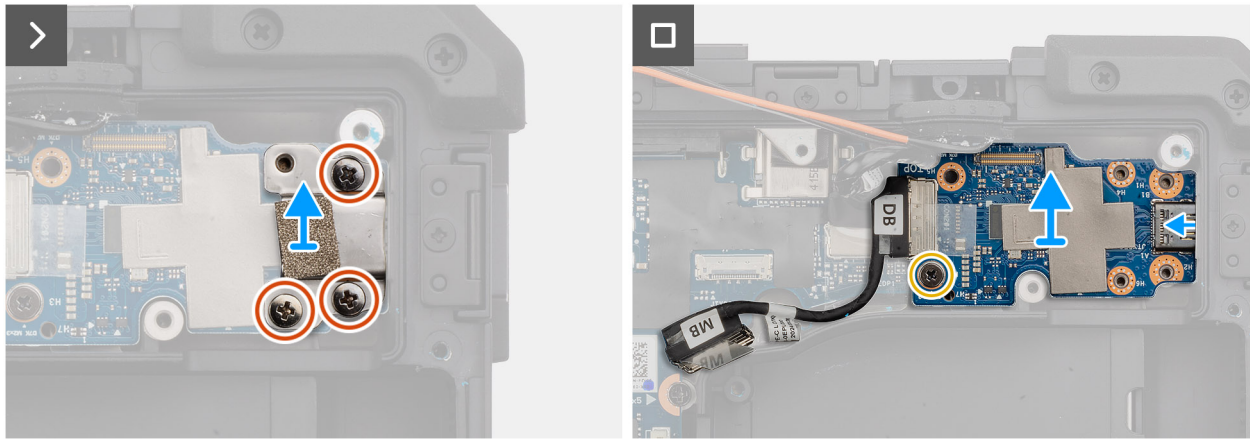

**Figure 111. Removing the left Type-C board**

### Steps

1. Remove the (M2.3x5) screw that secures the flat printed cable holder to the left Type-C board.
2. Disconnect the flat printed cable from its connector on the left Type-C board.
3. Disconnect the left Type-C cable from its connector on the left Type-C board.
4. Remove the three (M2.3x5) screws that secure the left Type-C board holder to the computer chassis.
5. Remove the (M2x3) screw that secures the left Type-C board to the computer chassis.
6. Slide and remove the left Type-C board from the computer chassis.

## Installing the left Type-C board

**CAUTION:** The information in this installation section is intended for authorized service technicians only.

### Prerequisites

If you are replacing a component, remove the existing component before performing the installation procedure.

### About this task

The following image indicates the location of the left Type-C board and provides a visual representation of the installation procedure.

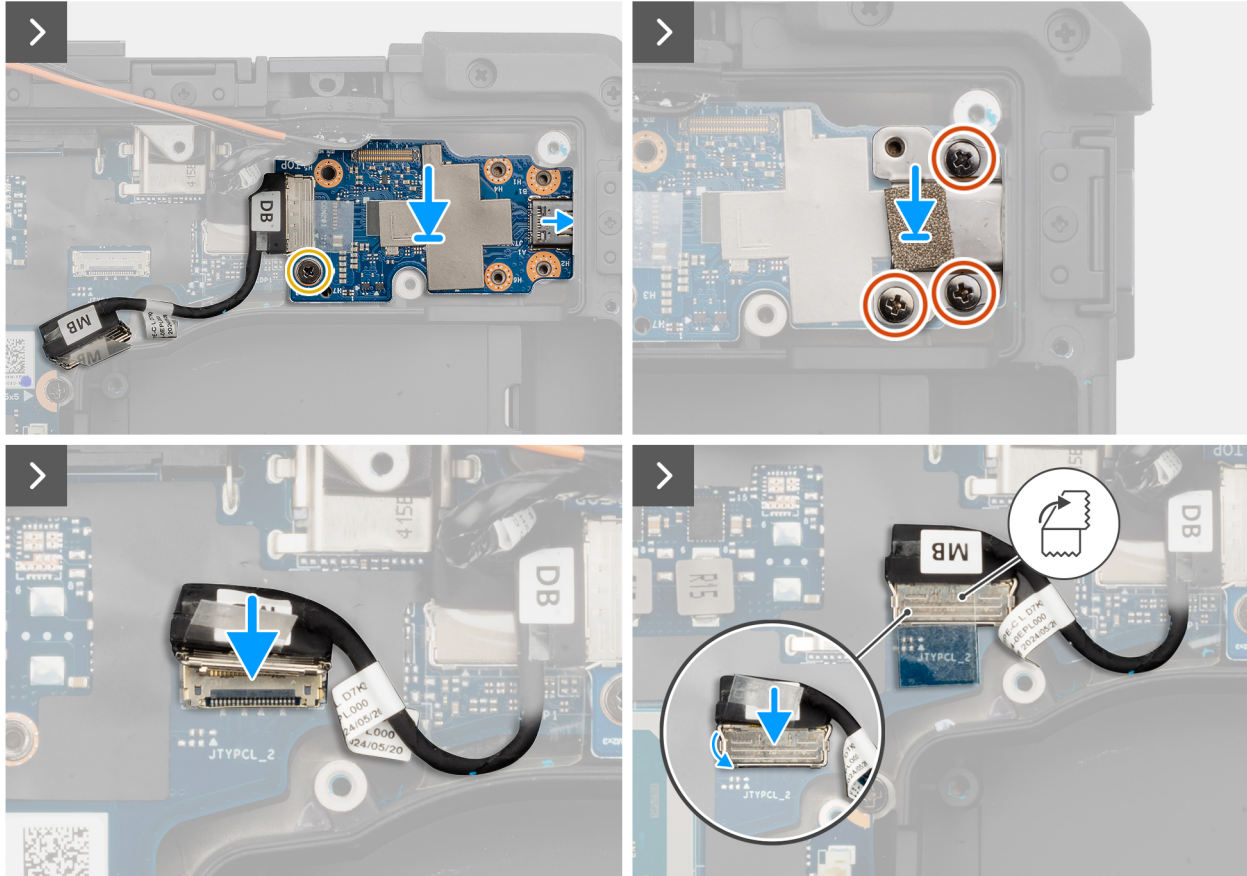
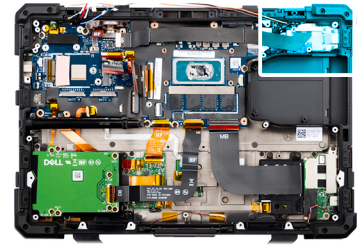
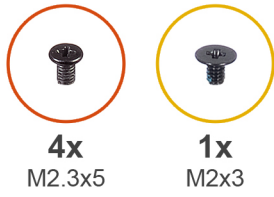

**Figure 112. Installing the left Type-C board**

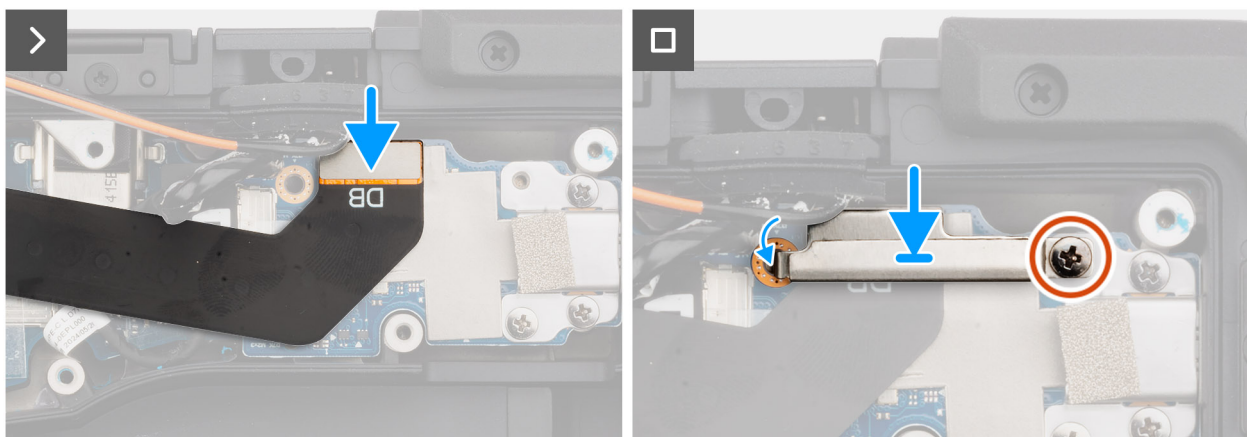

**Figure 113. Installing the left Type-C board**

**Steps**

1. Place the left Type-C board on the computer chassis.

2. Replace the (M2x3) screw to secure the left Type-C board to the computer chassis.
3. Replace the three (M2.3x5) screws to secure the left Type-C board holder to the computer chassis.
4. Connect the flat printed cable to its connector on the left Type-C board.
5. Connect the left Type-C cable to its connector on the left Type-C board.
6. Replace the (M2.3x5) screw that secures the flat printed cable holder to the left Type-C board.

### Next steps

1. Install the [heat sink](#) .
2. Install the [fan](#).
3. Install the [dock I/O-bracket](#).
4. Install the [dock I/O-module](#).
5. Install the [WWAN card](#).
6. Install the [WLAN card](#).
7. Install the [RF switch board](#).
8. Install the [rear I/O-board](#).
9. Install the [GPS board](#).
10. Install the [base cover](#).
11. Install the [keyboard \(rubberized\)](#) or [keyboard \(standard\)](#).
12. Install the [solid state drive carrier](#).
13. Install the [batteries](#).
14. Follow the procedure in [after working inside your computer](#).

## Latch doors

### Removing the latch doors

 **CAUTION:** The information in this removal section is intended for authorized service technicians only.

#### Prerequisites

1. Follow the procedure in [before working inside your computer](#).

#### About this task

The following image indicates the location of the latch doors and provides a visual representation of the removal procedure.



11x  
M2x3

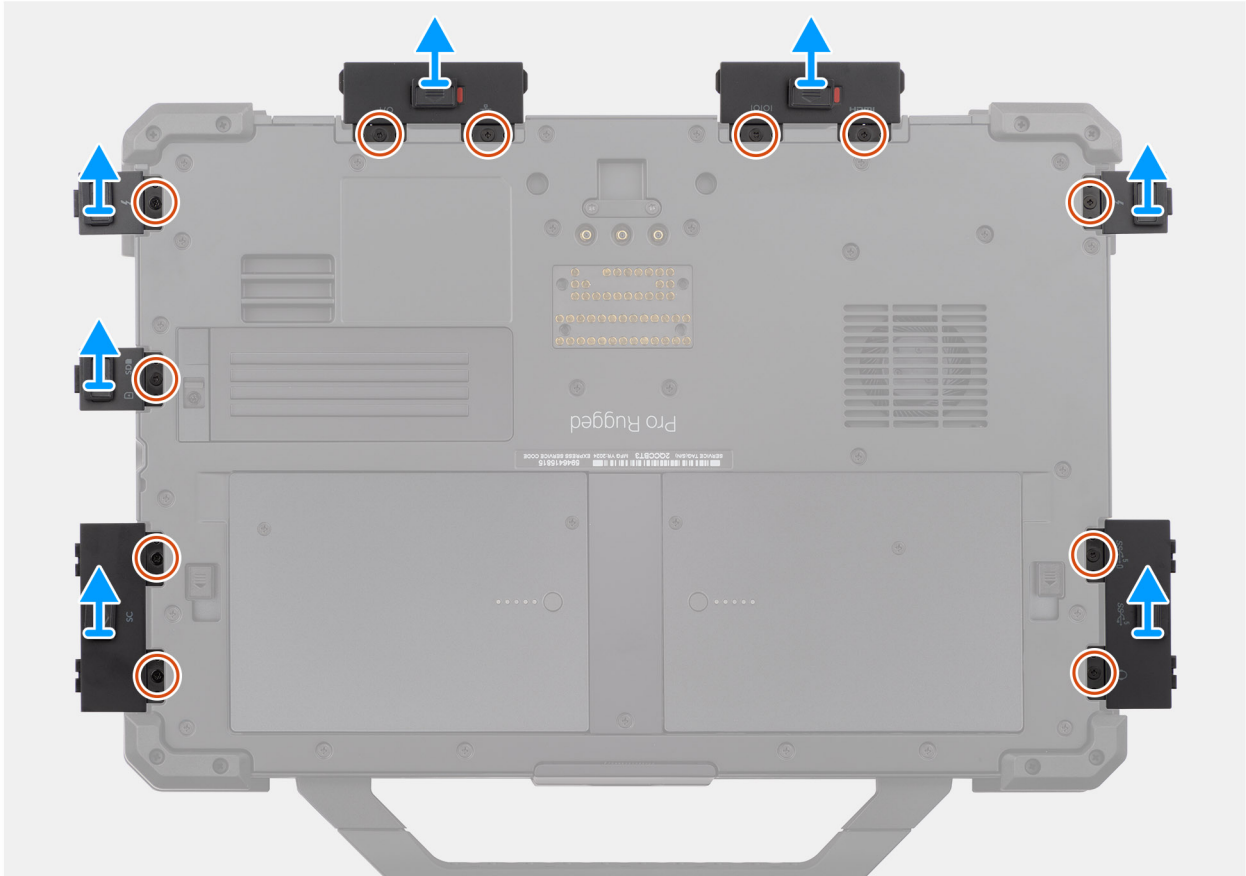

Figure 114. Removing the latch doors

### Steps

1. Remove the 11 (M2x3) screws that secure the latch doors to the computer chassis.
2. Lift and remove the latch doors from the computer chassis.

## Installing the latch doors

**CAUTION:** The information in this installation section is intended for authorized service technicians only.

### Prerequisites

If you are replacing a component, remove the existing component before performing the installation procedure.

### About this task

The following image indicates the location of the latch doors and provides a visual representation of the installation procedure.



11x  
M2x3

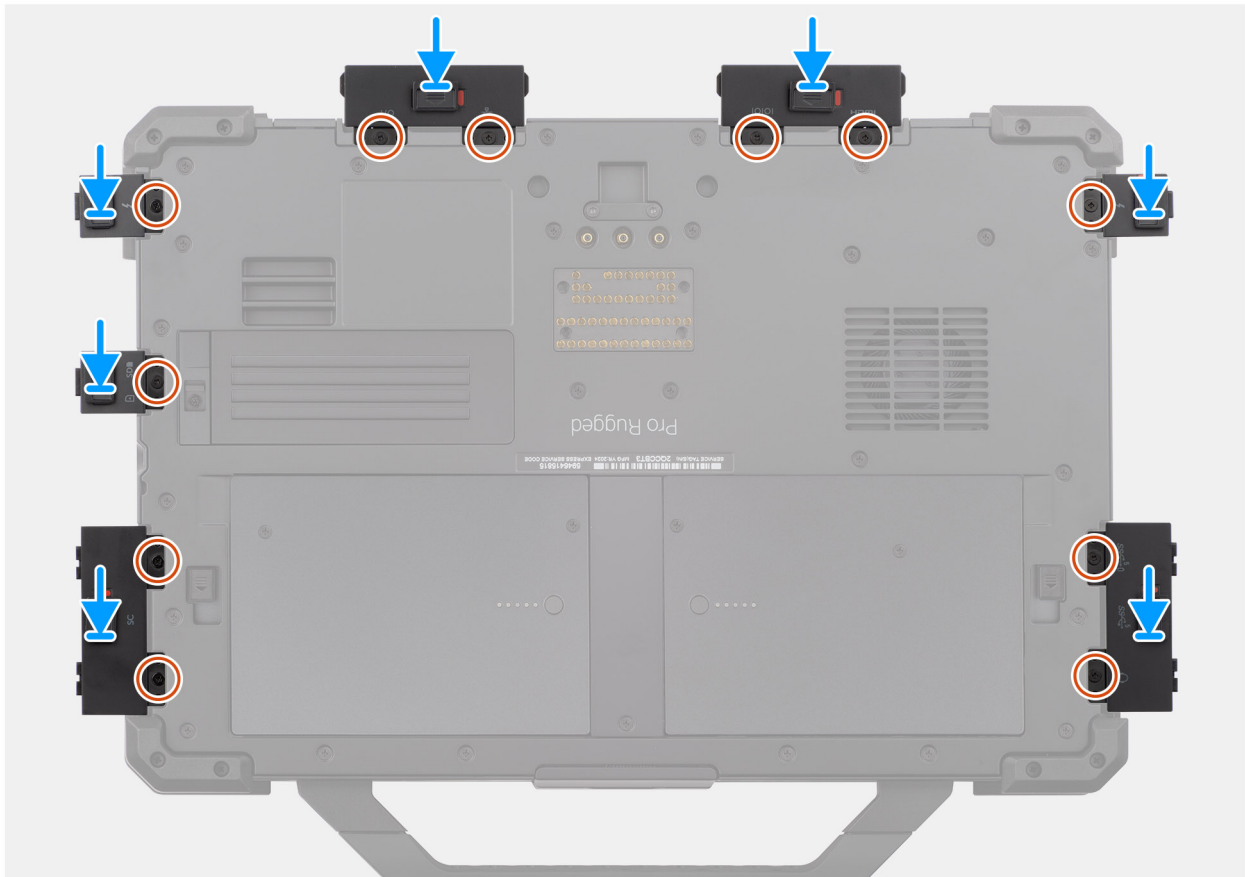

Figure 115. Installing the latch doors

#### Steps

1. Align the latch doors to the screw holes on the computer chassis.
2. Replace the 11 (M2x3) screws that secure the latch doors to the computer chassis.

#### Next steps

1. Follow the procedure in [after working inside your computer](#).

## Display assembly

### Removing the display assembly

 **CAUTION:** The information in this removal section is intended for authorized service technicians only.

#### Prerequisites

1. Follow the procedure in [before working inside your computer](#).

2. Remove the [batteries](#).
3. Remove the [solid state drive carrier](#).
4. Remove the [keyboard \(rubberized\)](#) or [keyboard \(standard\)](#).
5. Remove the [base cover](#).
6. Remove the [RF swicth board](#).
7. Remove the [WLAN card](#).
8. Remove the [WWAN card](#).
9. Remove the [dock I/O-module](#).
10. Remove the [dock I/O-bracket](#).
11. Remove the [rear I/O-board](#).
12. Remove the [express-card reader](#).
13. Remove the [smart-card reader](#).
14. Remove the [fan](#).
15. Remove the [heat sink](#) .
16. Remove the [system board](#).

### **About this task**

The following images indicate the location of the display assembly and provide a visual representation of the removal procedure.

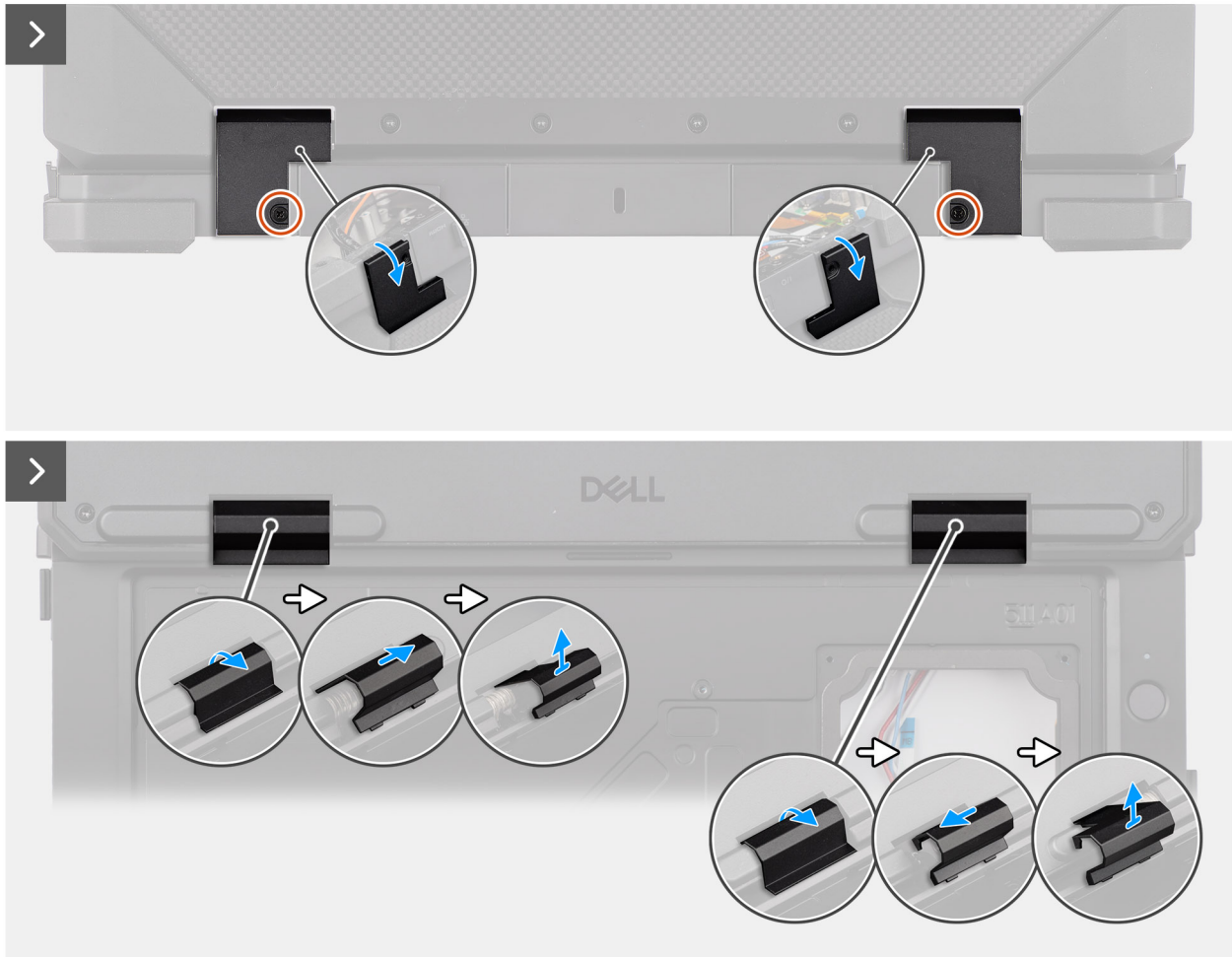

Figure 116. Removing the display assembly

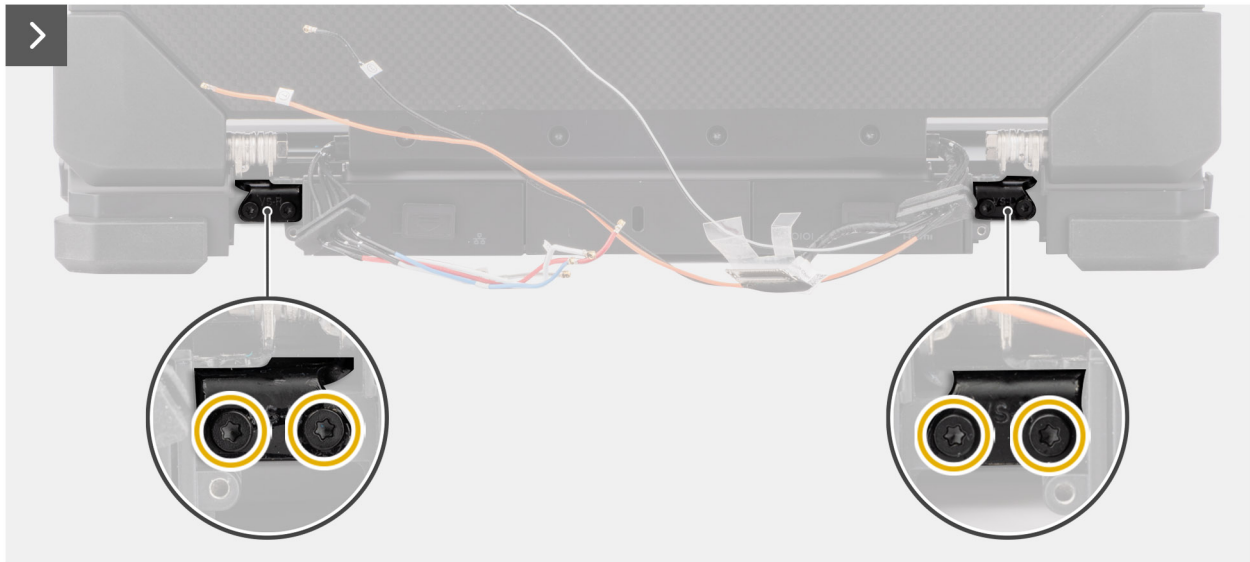

Figure 117. Removing the display assembly

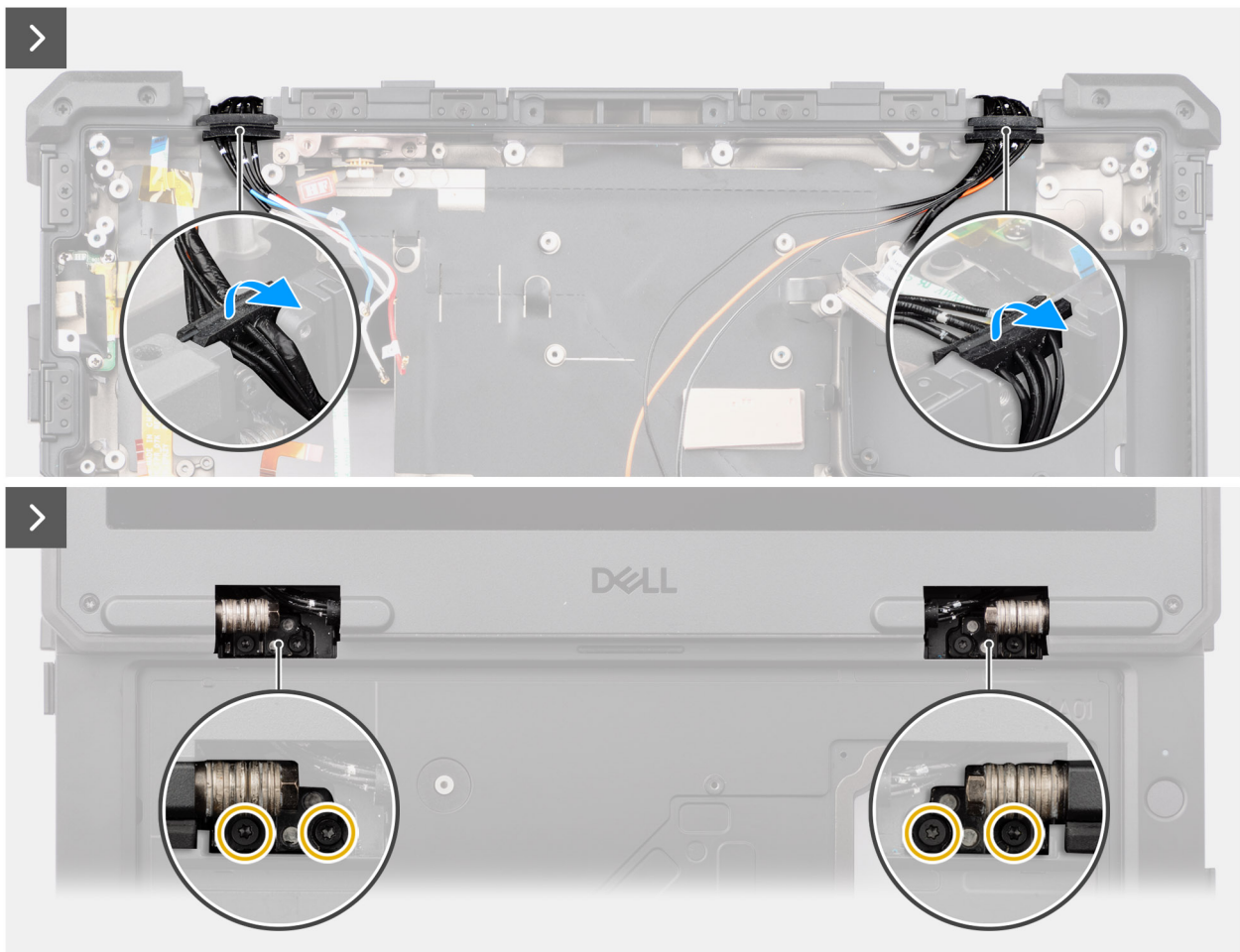
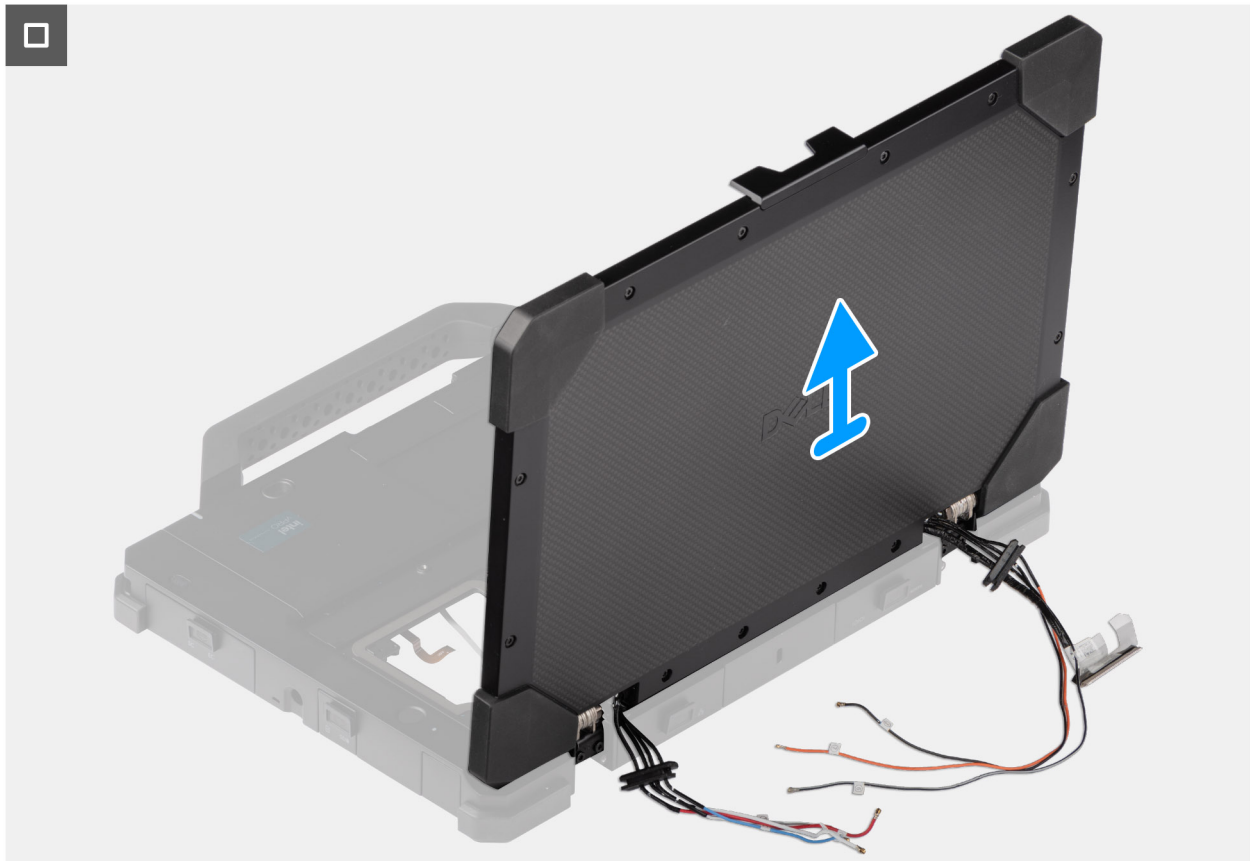

Figure 118. Removing the display assembly



**Figure 119. Removing the display assembly**

### Steps

1. Remove the two (M2.5x5) screws that secure the left/right hinge covers to the computer chassis.
2. Remove the left/right hinge covers from the computer chassis.
3. Remove the four (M3x6, T8) epoxy screws that secure the display assembly hinges to the computer chassis.
4. Pull the cable connections and remove the four (M3x6) epoxy screws that secure the display assembly to the computer chassis.
5. Lift and remove the display assembly from the computer chassis.

## Installing the display assembly

**CAUTION:** The information in this installation section is intended for authorized service technicians only.

### Prerequisites

If you are replacing a component, remove the existing component before performing the installation procedure.

### About this task

The following images indicate the location of the display assembly and provide a visual representation of the installation procedure.



2x  
M2.5x5



8x  
M3x6, T8

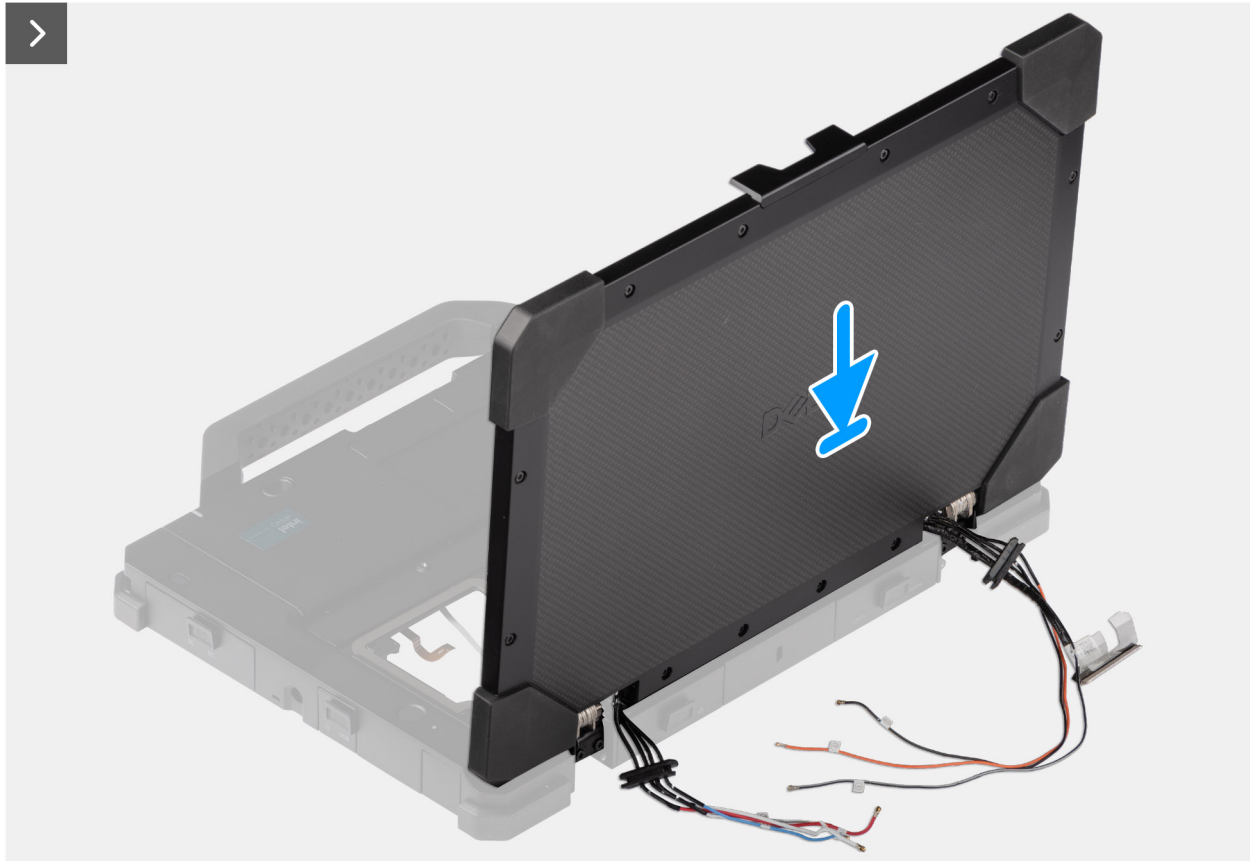
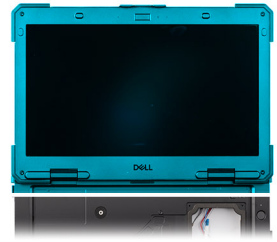

Figure 120. Installing the display assembly

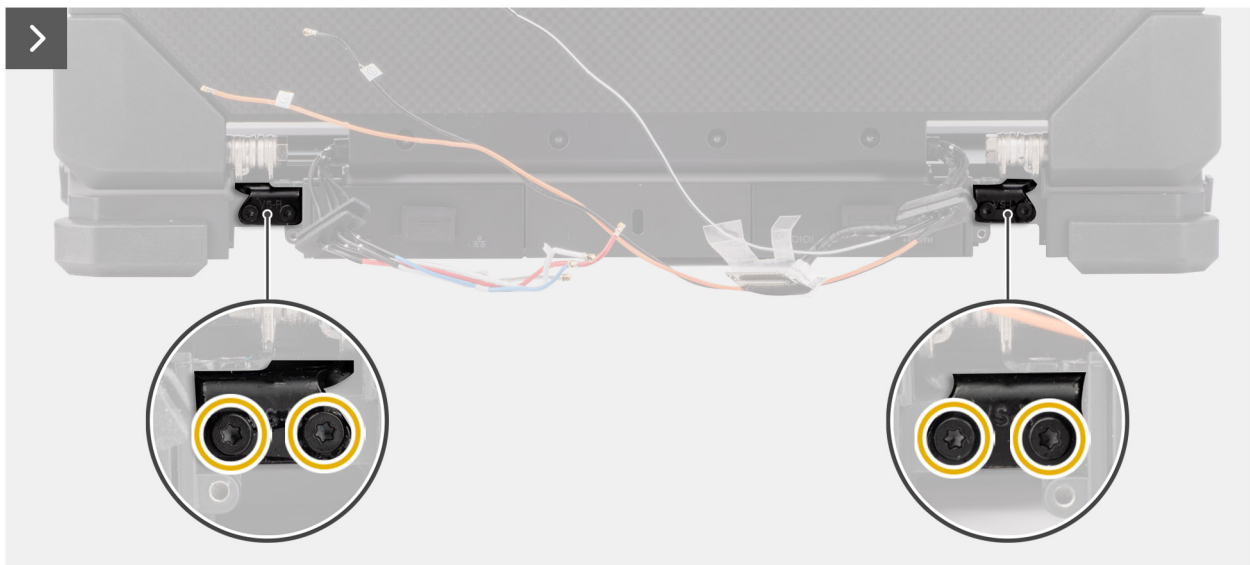
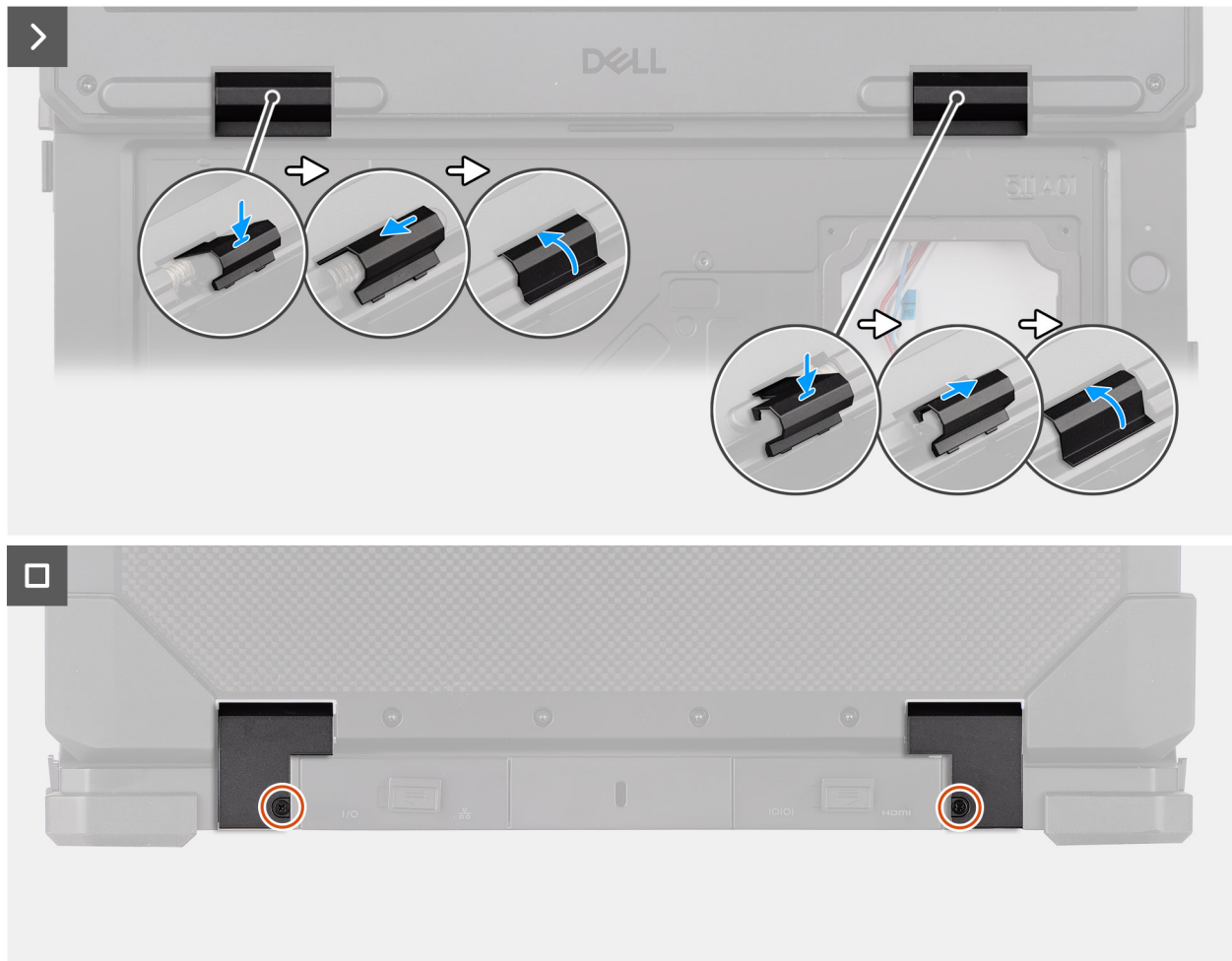

Figure 121. Installing the display assembly



Figure 122. Installing the display assembly



**Figure 123. Installing the display assembly**

### Steps

1. Align and place the display assembly on the computer chassis.
2. Replace the eight (M3x6, T8) epoxy screws that secure the display assembly to the computer chassis.
  - NOTE:** The epoxy screws are designed for single use. When replacing the display assembly, ensure to use the epoxy screws shipped with the replacement package.
3. Replace the left/right hinge covers to the computer chassis and close the lid.
4. Replace the two (M2.5x5) screws that secure the left/right hinge covers to the computer chassis.

### Next steps

1. Install the [system board](#).
2. Install the [heat sink](#).
3. Install the [fan](#).
4. Install the [smart-card reader](#).
5. Install the [express-card reader](#).
6. Install the [rear I/O-board](#).
7. Install the [dock I/O-bracket](#).
8. Install the [dock I/O-module](#).
9. Install the [WWAN card](#).
10. Install the [WLAN card](#).
11. Install the [RF switch board](#).
12. Install the [base cover](#).
13. Install the [keyboard \(rubberized\)](#) or [keyboard \(standard\)](#).

- 14. Install the [solid state drive carrier](#).
- 15. Install the [batteries](#).
- 16. Follow the procedure in [after working inside your computer](#).

## Display-panel assembly

### Removing the display-panel assembly

#### Prerequisites

- 1. Follow the procedure in [before working inside your computer](#).
- 2. Remove the [display assembly](#).

#### About this task

The following image indicates the location of the display bezel and provides a visual representation of the removal procedure.

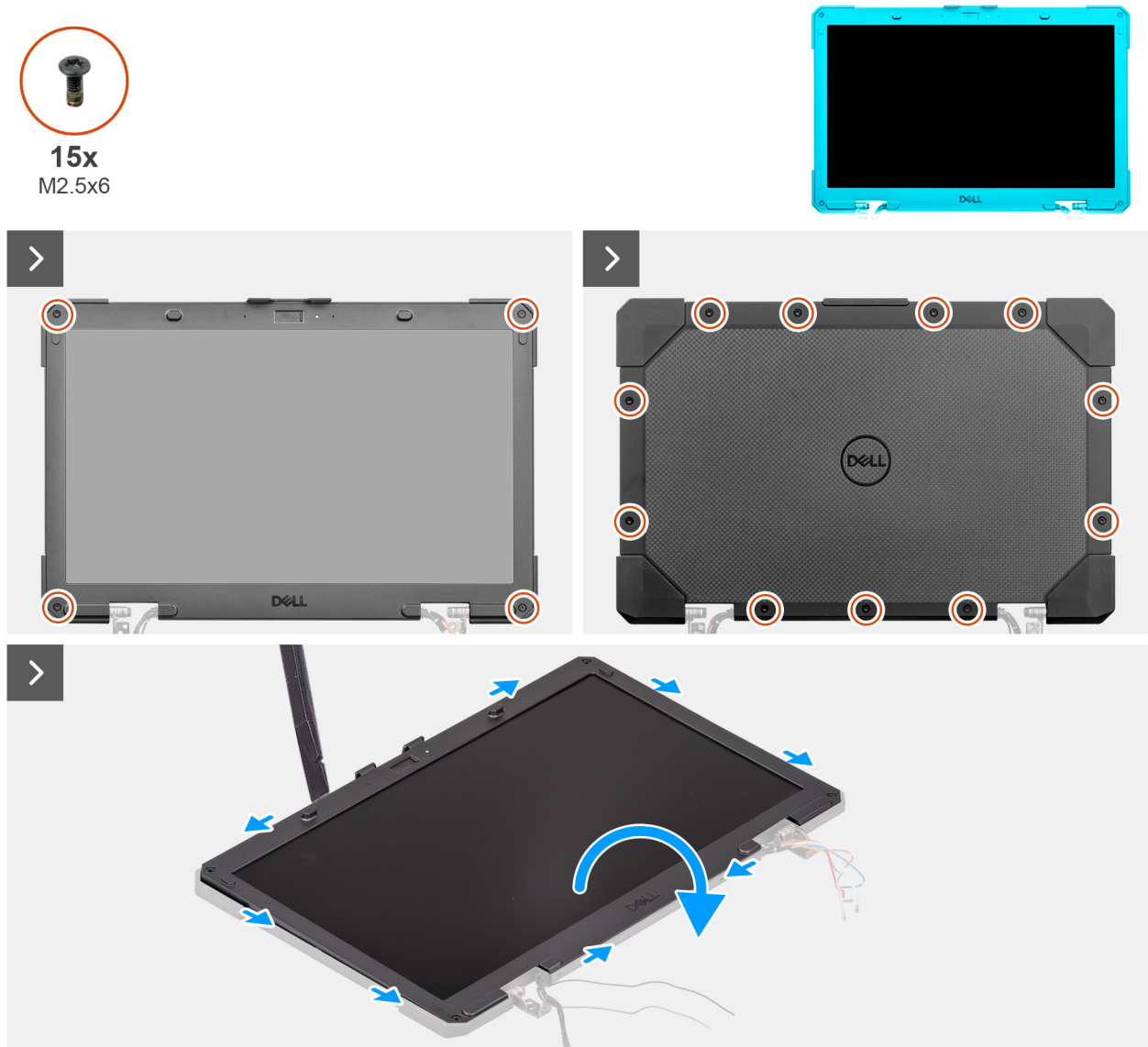

Figure 124. Removing the display-panel assembly



**Figure 125. Removing the display-panel assembly**

### Steps

1. Remove the four (M2.5x6, T8) screws that secure the display-panel assembly to the display back-cover assembly.
  - i NOTE:** These screws are coated with epoxy and are secured firmly, requiring more torque to remove them. To prevent damage to the screws and surrounding plastics, use the correct screwdriver for each screw type.
2. Close the lid and remove the 11 (M2.5x6, T8) screws that secure the display-panel assembly to the display back-cover assembly.
3. Use a plastic scribe to carefully pry open the top, left, and right sides of the display-panel assembly.
  - i NOTE:** When prying open the display-panel assembly, ensure to pry along the outside edge of the display bezel using your hand or a plastic scribe. Using a screw driver or any sharp object may damage the display cover.
4. Flip the display-panel assembly and disconnect the eDP cable from its connector on the display-panel.
5. Disconnect the touch cable from its connector on the touch screen board.

## Installing the display-panel assembly

**⚠ CAUTION:** The information in this installation section is intended for authorized service technicians only.

### Prerequisites

If you are replacing a component, remove the existing component before performing the installation procedure.

### About this task

The following images indicate the location of the display-panel assembly and provide a visual representation of the installation procedure.



**15x**  
M2.5x6



**Figure 126. Installing the display-panel assembly**

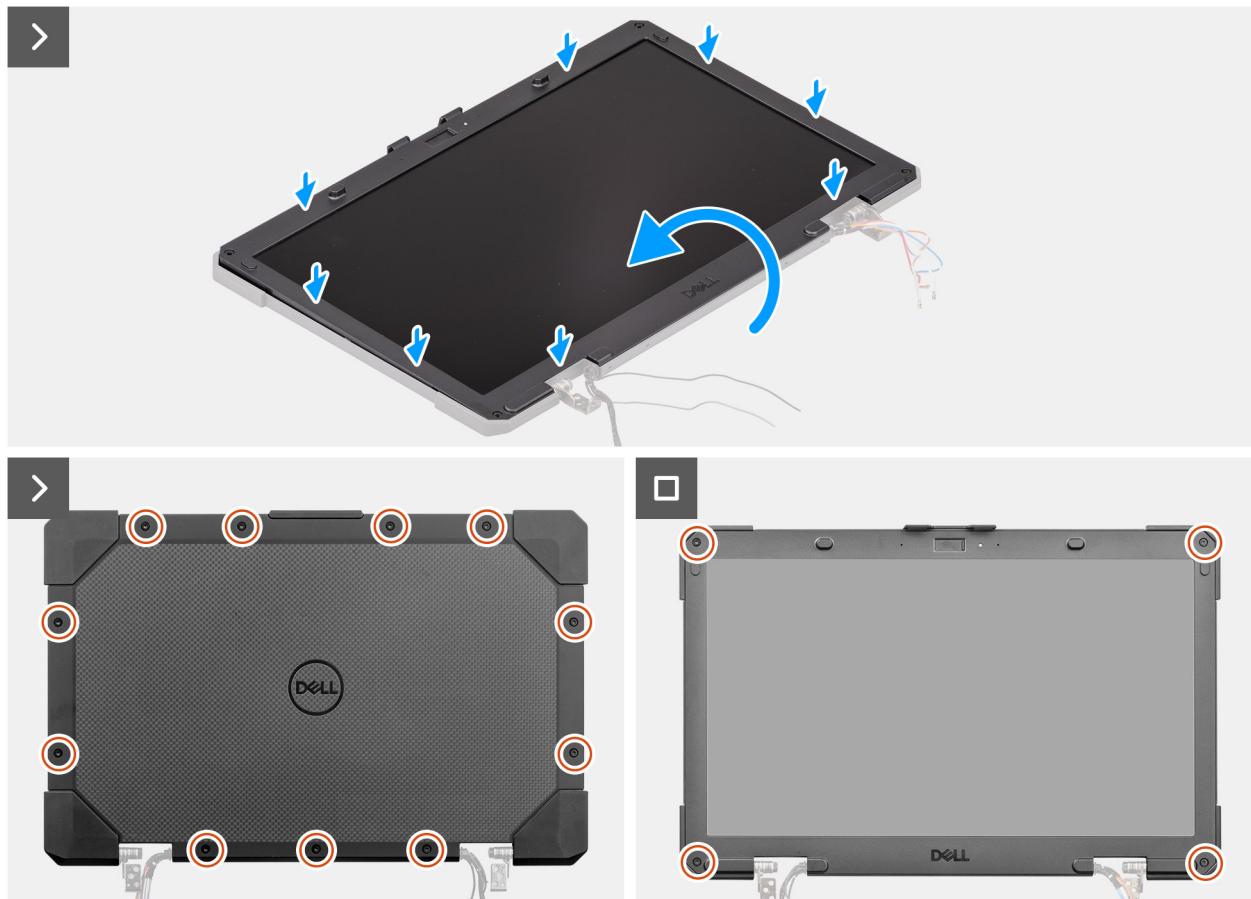

**Figure 127. Installing the display-panel assembly**

**Steps**

1. Connect the touch cable to its connector on the touch screen board.
2. Connect the eDP cable to its connector on the display-panel assembly and flip the display-panel assembly on the display back-cover assembly.
3. Align the display-panel assembly with the display back-cover assembly. Gently snap the display-panel assembly into place.
4. Replace the 11 (M2.5x6, T8) epoxy screws that secure the display-panel assembly to the display assembly.
  - NOTE:** Ensure that the display-panel assembly is placed on a flat surface when replacing the screws to avoid light leakage from the LCD.
  - NOTE:** The epoxy screws are designed for single use. When replacing the display-panel assembly, ensure to use the epoxy screws shipped with the replacement package.
5. Replace the four (M2.5x6, T8) epoxy screws to secure the display-panel assembly to the display back-cover assembly.
  - NOTE:** The epoxy screws are designed for single use. When replacing the display-panel assembly, ensure to use the epoxy screws shipped with the replacement package.

**Next steps**

1. Install the [display assembly](#).
2. Follow the procedure in [after working inside your computer](#).

# Display back-cover assembly

## Removing the display back-cover assembly

 **CAUTION:** The information in this removal section is intended for authorized service technicians only.

### Prerequisites

1. Follow the procedure in [before working inside your computer](#).
2. Remove the [batteries](#).
3. Remove the [solid state drive carrier](#).
4. Remove the [keyboard \(rubberized\)](#) or [keyboard \(standard\)](#).
5. Remove the [base cover](#).
6. Remove the [GPS board](#).
7. Remove the [rear I/O-board](#).
8. Remove the [RF switch board](#).
9. Remove the [WLAN card](#).
10. Remove the [WWAN card](#).
11. Remove the [dock I/O-module](#).
12. Remove the [dock I/O-bracket](#).
13. Remove the [fan](#).
14. Remove the [heat sink](#) .
15. Remove the [left Type-C board](#).
16. Remove the [system board](#).
17. Remove the [display assembly](#).
18. Remove the [display-panel assembly](#).

### About this task

The following image indicates the location of the display back-cover assembly and provides a visual representation of the removal procedure.

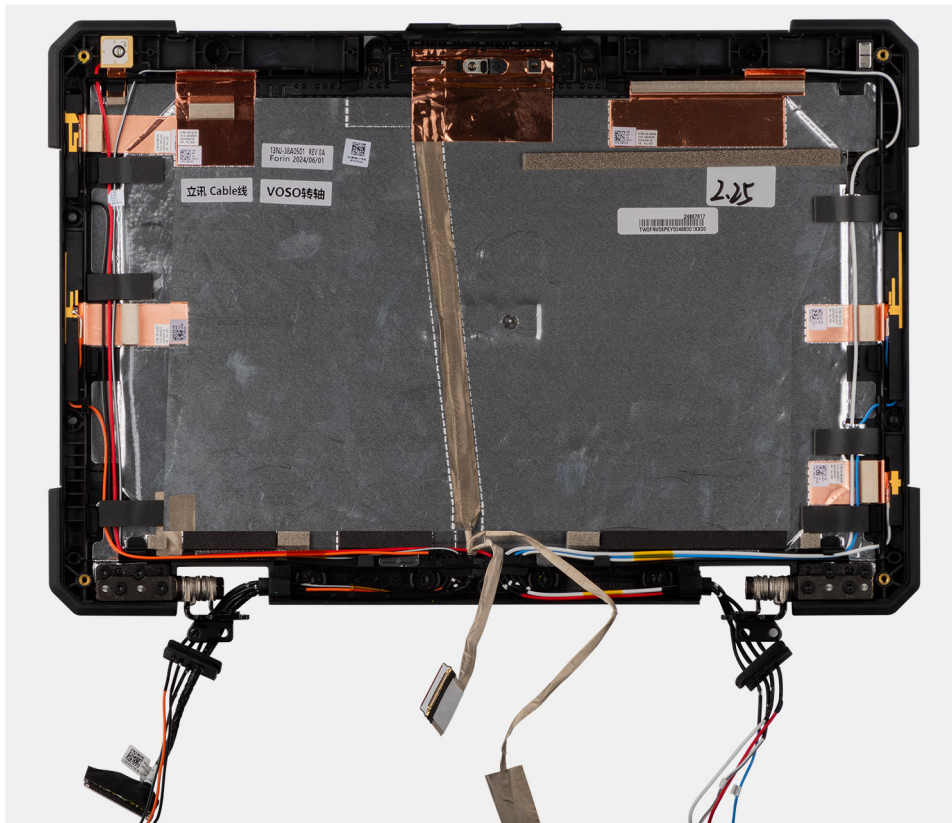

**Figure 128. Removing the display back-cover assembly**

### Steps

After performing the preceding steps, you are left with the display back-cover assembly.

## Installing the display back-cover assembly

**CAUTION:** The information in this installation section is intended for authorized service technicians only.

### Prerequisites

If you are replacing a component, remove the existing component before performing the installation procedure.

### About this task

The following image indicates the location of the display back-cover assembly and provides a visual representation of the installation procedure.

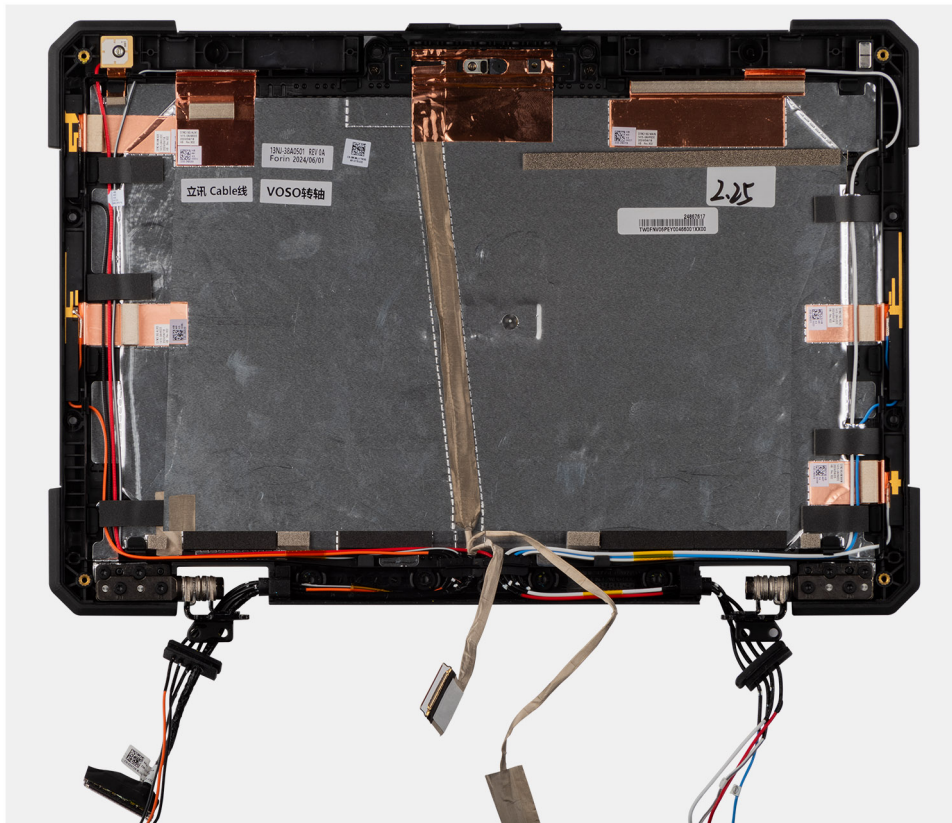

**Figure 129. Installing the display back-cover assembly**

### Steps

After performing the succeeding steps, you are left with the display back-cover assembly.

### Next steps

1. Install the [display-panel assembly](#).
2. Install the [display assembly](#).
3. Install the [system board](#).
4. Install the [left Type-C board](#).
5. Install the [heat sink](#) .
6. Install the [fan](#).
7. Install the [dock I/O-bracket](#).
8. Install the [dock I/O-module](#).
9. Install the [WWAN card](#).
10. Install the [WLAN card](#).
11. Install the [RF switch board](#).
12. Install the [rear I/O-board](#).
13. Install the [GPS board](#).
14. Install the [base cover](#).
15. Install the [keyboard \(rubberized\)](#) or [keyboard \(standard\)](#).
16. Install the [solid state drive carrier](#).
17. Install the [batteries](#).
18. Follow the procedure in [after working inside your computer](#).

# Palm-rest assembly

## Removing the palm-rest assembly

 **CAUTION:** The information in this removal section is intended for authorized service technicians only.

### Prerequisites

1. Follow the procedure in [before working inside your computer](#).
2. Remove the [batteries](#).
3. Remove the [solid state drive carrier](#).
4. Remove the [keyboard \(rubberized\)](#) or [keyboard \(standard\)](#).
5. Remove the [base cover](#).
6. Remove the [stylus holder](#).
7. Remove the [RF swithc board](#).
8. Remove the [WLAN card](#).
9. Remove the [WWAN card](#).
10. Remove the [dock I/O-module](#).
11. Remove the [dock I/O-bracket](#).
12. Remove the [rear I/O-board](#).
13. Remove the [express-card reader](#).
14. Remove the [smart-card reader](#).
15. Remove the [smart-card and express-card reader bracket](#).
16. Remove the [fan](#).
17. Remove the [heat sink](#) .
18. Remove the [system board](#).
19. Remove the [display assembly](#).

### About this task

The following image indicates the location of the palm-rest assembly and provides a visual representation of the removal procedure.

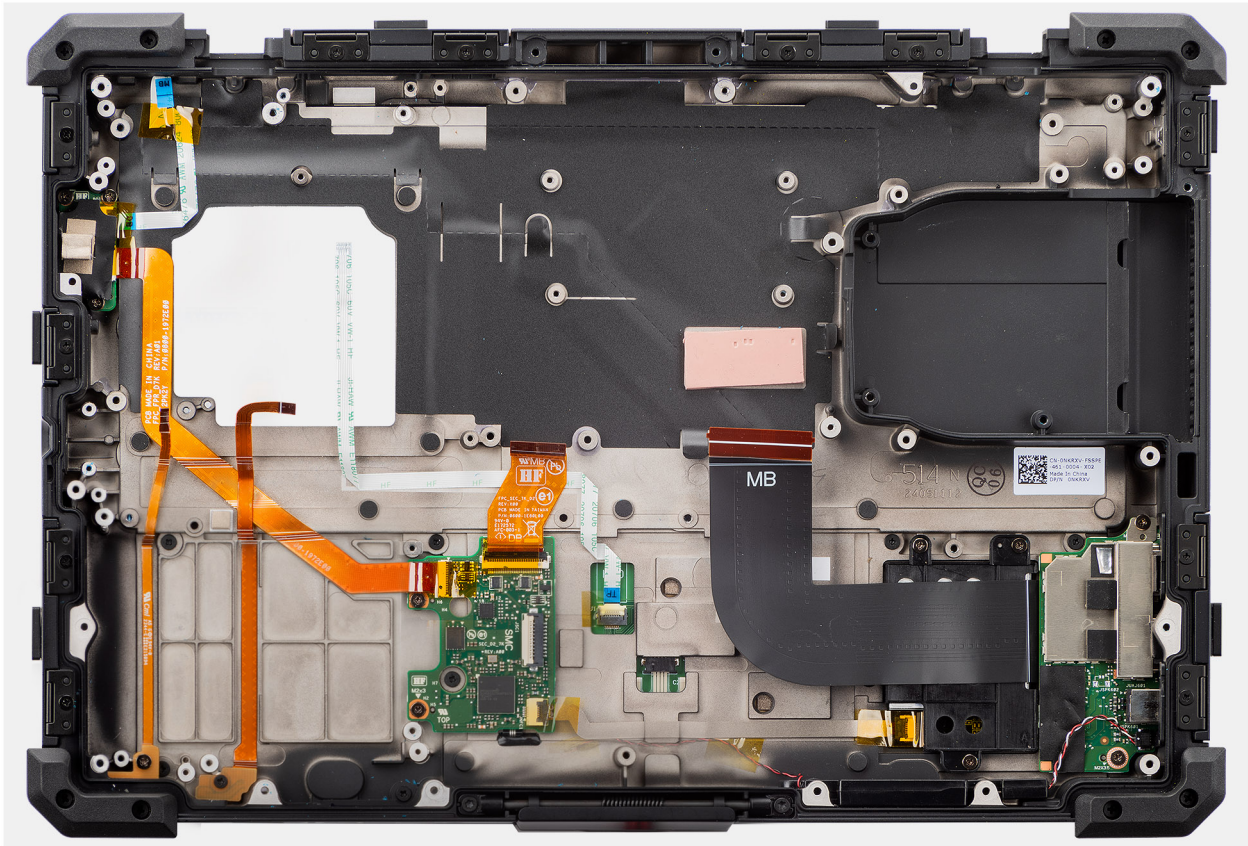

**Figure 130. Removing the palm-rest assembly**

### Steps

After performing the preceding steps, you are left with the palm-rest assembly.

- i** **NOTE:** The palm-rest assembly is preassembled with the touchpad, power button board, power button with fingerprint reader, LED board, USH board, left I/O-board, speakers, NFC module.
- i** **NOTE:** Depending on the configuration of the computer, the rear I/O-board (including cover) and optional Fischer port must be transferred over to the new replacement palm-rest assembly.

## Installing the palm-rest assembly

**⚠ CAUTION:** The information in this installation section is intended for authorized service technicians only.

### Prerequisites

If you are replacing a component, remove the existing component before performing the installation procedure.

### About this task

The following image indicates the location of the palm-rest assembly and provides a visual representation of the installation procedure.

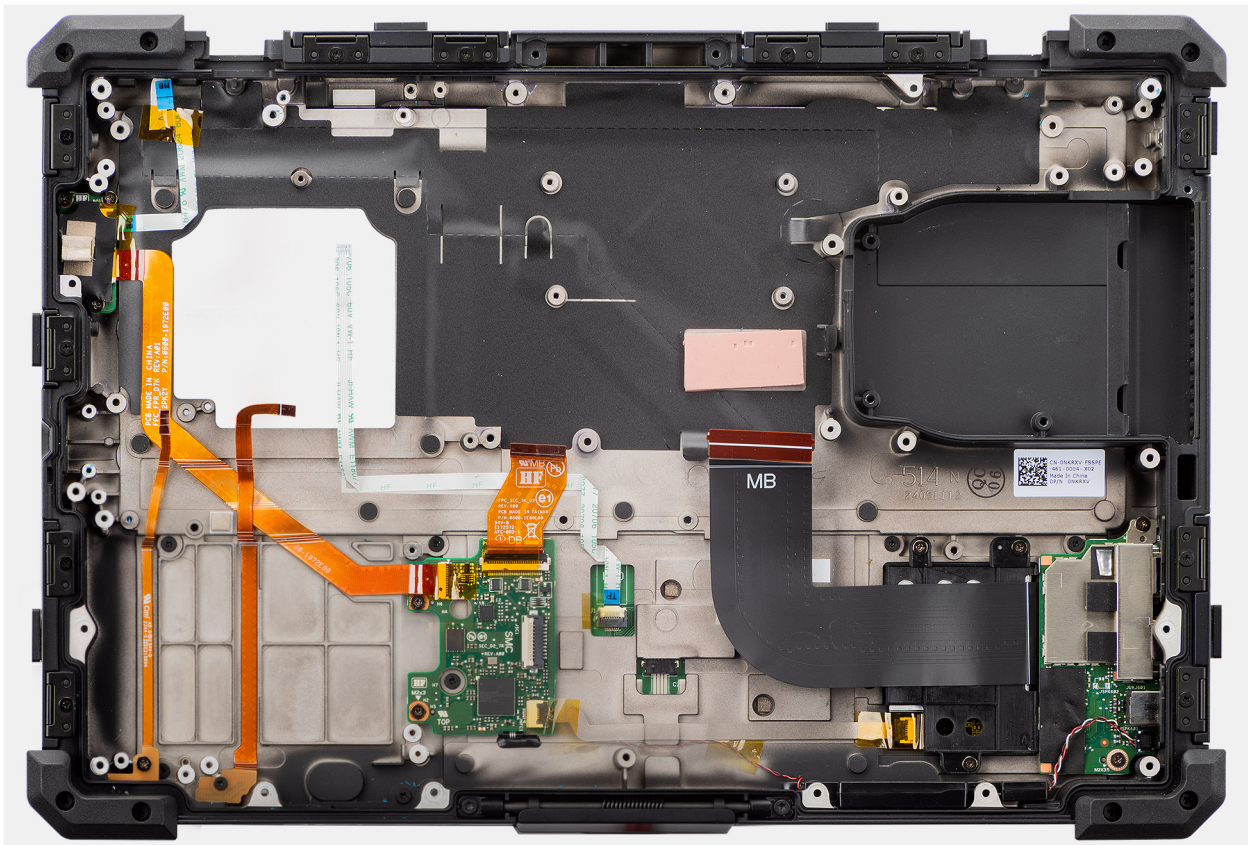

**Figure 131. Installing the palm-rest assembly**

### Steps

After performing the succeeding steps, you are left with the palm-rest assembly.

- i NOTE:** The palm-rest assembly is preassembled with the touchpad, power button board, power button with fingerprint reader, LED board, USH board, left I/O-board, speakers, NFC module.
- i NOTE:** Depending on the configuration of the computer, the rear I/O-board (including cover) and optional Fischer port must be transferred over to the new replacement palm-rest assembly.

### Next steps

1. Install the [display assembly](#).
2. Install the [system board](#).
3. Install the [heat sink](#).
4. Install the [fan](#).
5. Install the [smart-card and express-card reader bracket](#).
6. Install the [smart-card reader](#).
7. Install the [express-card reader](#).
8. Install the [rear I/O-board](#).
9. Install the [dock I/O-bracket](#).
10. Install the [dock I/O-module](#).
11. Install the [WWAN card](#).
12. Install the [WLAN card](#).
13. Install the [RF switch board](#).
14. Install the [stylus holder](#).
15. Install the [base cover](#).
16. Install the [keyboard \(rubberized\)](#) or [keyboard \(standard\)](#).
17. Install the [solid state drive carrier](#).
18. Install the [batteries](#).

19. Follow the procedure in [after working inside your computer](#).

# Software

This chapter details the supported operating systems along with instructions on how to install the drivers.

## Operating system

Your Dell Pro Rugged 13 RA13250 supports the following operating systems:

- Windows 11 Home
- Windows 11 Pro

## Drivers and downloads

When troubleshooting, downloading, or installing drivers, it is recommended that you read the Dell Knowledge Base article [Drivers and Downloads FAQs 000123347](#).

# Technology and components

 **NOTE:** Instructions that are provided in the following section are applicable on computers that are shipped with the Windows operating system. Windows is factory-installed with this computer.

## Rugged Control Center

Dell Rugged Control Center brings mission-critical tasks to the forefront of your rugged device, making them accessible. Some of the tasks include configuring programmable buttons and edge menus, operating the barcode scanner, enabling and disabling your WiFi and Bluetooth services, and so on.

Using Dell Rugged Control Center, you can also configure a range of settings on your rugged device such as application settings, keyboard backlight, night mode, stealth mode, GPS configuration, and antenna switch.

Dell Rugged Control Center is preinstalled on Latitude Rugged, and Latitude Rugged Extreme Notebooks and Tablets. To launch the application, open the Windows Start menu, and search for Dell Rugged Control Center.

Dell Rugged Control Center consists of five main parts-Dashboard, Program, Feature List, Settings, and Policy.

For more information about Rugged Control Center, refer *Rugged Control Center User's Guide and Quick Start Guide* at [Rugged Control Center](#).

# BIOS Setup

**CAUTION:** Unless you are an expert computer user, do not change the settings in the BIOS Setup. Certain changes can make your computer work incorrectly.

**NOTE:** Depending on the computer and the installed devices, the options that are listed in this section may or may not be displayed.

**NOTE:** Before you change the settings in BIOS Setup, it is recommended that you note down the original settings for future reference.

Use BIOS Setup for the following purposes:

- Get information about the hardware installed in your computer, such as the amount of RAM and the size of the storage device.
- Change the system configuration information.
- Set or change a user-selectable option, such as the user password, type of hard drive installed, and enable or disable base devices.

## Entering BIOS Setup program

### About this task

Turn on (or restart) your computer and press F2 immediately.

## Navigation keys

**NOTE:** For most of the BIOS Setup options, changes that you make are recorded but do not take effect until you restart the computer.

**Table 48. Navigation keys**

| Keys       | Navigation   |
|------------|--|
| Up arrow   | Moves to the previous field.   |
| Down arrow | Moves to the next field.   |
| Enter      | Selects a value in the selected field (if applicable) or follows the link in the field.  |
| Spacebar   | Expands or collapses a drop-down list, if applicable.  |
| Tab        | Moves to the next focus area.  |
| Esc        | Moves to the previous page until you view the main screen. Pressing Esc in the main screen displays a message that prompts you to save any unsaved changes and restart the computer. |

## F12 One Time Boot menu

To enter the One Time Boot menu, turn on your computer, and then press F12 immediately.

**NOTE:** If you are unable to enter the One Time Boot menu, repeat the above action.

The One Time Boot menu displays the devices that you can boot from and also display the options to start diagnostics. The boot menu options are:

- Removable Drive (if available)
- STXXXX Drive (if available)

**NOTE:** XXX denotes the SATA drive number.

- Optical Drive (if available)
- SATA Hard Drive (if available)
- Diagnostics

The One Time Boot menu screen also displays the option to access BIOS Setup.

## View Advanced Setup options

### About this task

Some BIOS Setup options are only visible by enabling **Advanced Setup** mode, which is disabled by default.

**NOTE:** BIOS Setup options, including **Advanced Setup** options, are described in [BIOS setup options](#).

### To enable Advanced Setup:

#### Steps

1. Enter BIOS Setup.  
The Overview menu appears.
2. Click the **Advanced Setup** option to move it to the **ON** mode.  
Advanced BIOS Setup options are displayed.

## View Service options

### About this task

Service options are hidden by default and only visible by entering a hotkey command.

**NOTE:** Service options are described in [BIOS Setup options](#).

### To view Service options:

#### Steps

1. Enter BIOS Setup.  
The Overview menu appears.
2. Enter the hotkey combination **Ctrl + Alt + s** to view the **Service** options.  
**Service** options are displayed.

## System Setup options



**NOTE:** For most of the System Setup options, changes that you make are recorded but do not take effect until you restart the computer.

**NOTE:** Depending on your computer and its installed devices, the items that are listed in this section may differ.





**Table 49. System Setup options—Overview menu**

| Overview                   |
|----------------------------|
| Dell Pro Rugged 13 RA13250 |

**Table 49. System Setup options—Overview menu (continued)**

| <b>Overview</b>               |   |
|-------------------------------|---|
| BIOS Version                  | Displays the BIOS version number.   |
| Service Tag                   | Displays the Service Tag of the computer.   |
| Asset Tag                     | Displays the Asset Tag of the computer.   |
| Manufacture Date              | Displays the manufacture date of the computer.  |
| Ownership Date                | Displays the ownership date of the computer.  |
| Express Service Code          | Displays the Express Service Code of the computer.  |
| Ownership Tag                 | Displays the Ownership Tag of the computer.   |
| Signed Firmware Update        | <p>Displays whether the Signed Firmware Update is enabled on your computer. By default, the <b>Signed Firmware Update</b> option is enabled.</p> <p> <b>NOTE:</b> To view this option, enable <b>Service</b> options as described in <a href="#">View Service options</a>.</p> |
| <b>BATTERY</b> Information    |   |
| Battery 1 Type                | Displays the battery health of the computer.  |
| Battery 1 Level               | Displays the battery level of the computer.   |
| Battery 1 State               | Displays the battery state of the computer.   |
| Battery 1 Health              | Displays the battery health of the computer.  |
| Battery 2 Type                | Displays the battery health of the computer.  |
| Battery 2 Level               | Displays the battery level of the computer.   |
| Battery 2 State               | Displays the battery state of the computer.   |
| Battery 2 Health              | Displays the battery health of the computer.  |
| AC Adapter                    | Displays whether an AC adapter is connected. If connected, displays the type of AC adapter that is connected.   |
| <b>PROCESSOR</b> Information  |   |
| Processor Type                | Displays the processor type.  |
| Maximum Clock Speed           | <p>Displays the maximum processor clock speed.</p> <p> <b>NOTE:</b> To view this option, enable <b>Advanced Setup</b> mode as described in <a href="#">View Advanced Setup options</a>.</p>  |
| Minimum Clock Speed           | <p>Displays the minimum processor clock speed.</p> <p> <b>NOTE:</b> To view this option, enable <b>Advanced Setup</b> mode as described in <a href="#">View Advanced Setup options</a>.</p>  |
| Current Clock Speed           | <p>Displays the current processor clock speed.</p> <p> <b>NOTE:</b> To view this option, enable <b>Advanced Setup</b> mode as described in <a href="#">View Advanced Setup options</a>.</p>  |
| Core Count                    | Displays the number of cores on the processor.  |
| Processor ID                  | Displays the processor identification code.   |
| Microcode Version             | <p>Displays the microcode version.</p> <p> <b>NOTE:</b> To view this option, enable <b>Advanced Setup</b> mode as described in <a href="#">View Advanced Setup options</a>.</p>  |
| Intel Hyper-Threading Capable | Displays whether the processor is Hyper-Threading (HT) capable.   |







**Table 49. System Setup options—Overview menu (continued)**

| <b>Overview</b>            |   |
|----------------------------|---|
|                            |  <b>NOTE:</b> To view this option, enable <b>Advanced Setup</b> mode as described in <a href="#">View Advanced Setup options</a> .   |
| <b>MEMORY</b> Information  |   |
| Memory Installed           | Displays the total memory installed on the computer.  |
| Memory Available           | Displays the total memory available on the computer.  |
| Memory Speed               | Displays the memory speed.<br> <b>NOTE:</b> To view this option, enable <b>Advanced Setup</b> mode as described in <a href="#">View Advanced Setup options</a> .                         |
| Memory Channel Mode        | Displays single or dual channel mode.<br> <b>NOTE:</b> To view this option, enable <b>Advanced Setup</b> mode as described in <a href="#">View Advanced Setup options</a> .              |
| Memory Technology          | Displays the technology that is used for the memory.  |
| <b>DEVICES</b> Information |   |
| Panel Type                 | Displays the type of display panel available on the computer.   |
| Panel Revision             | Displays the Panel Revision of the computer.  |
| Video Controller           | Displays the type of video controller available on the computer.  |
| Video Memory               | Displays the video memory information of the computer.  |
| Wi-Fi Device               | Displays the wireless device information of the computer.   |
| Native Resolution          | Displays the native resolution of the computer.   |
| Video BIOS Version         | Displays the video BIOS version of the computer.<br> <b>NOTE:</b> To view this option, enable <b>Advanced Setup</b> mode as described in <a href="#">View Advanced Setup options</a> . |
| Audio Controller           | Displays the audio controller information of the computer.  |
| Bluetooth Device           | Displays the Bluetooth device information of the computer.  |
| LOM MAC Address            | Displays the LAN On Motherboard (LOM) MAC address of the system.  |
| Pass Through MAC Address   | Displays the MAC address of the video pass-through.   |
| Cellular Device            | Displays the cellular device of the computer.   |

**Table 50. System Setup options—Boot Configuration menu**

| <b>Boot Configuration</b>     |   |
|-------------------------------|---|
| <b>Boot Sequence</b>          |   |
| Boot Mode: UEFI only          | Displays the boot mode of the computer.<br> <b>NOTE:</b> To view this option, enable <b>Service</b> options as described in <a href="#">View Service options</a> . |
| Boot Sequence                 | Displays the boot sequence.   |
| Enable PXE Boot Priority      | Enables or disables the new PXE boot option. Allows loading an operating system over a network connection. By default, the <b>Enable PXE Boot Priority</b> option is disabled.  |
| Secure Digital (SD) Card Boot | Enables or disables read-only boot from Secure Digital (SD) card.<br>By default, the <b>Secure Digital (SD) Card Boot</b> option is disabled.   |





**Table 50. System Setup options—Boot Configuration menu (continued)**

| <b>Boot Configuration</b>    |   |
|------------------------------|---|
|                              | <p> <b>NOTE:</b> To view this option, enable <b>Advanced Setup</b> mode as described in <a href="#">View Advanced Setup options</a>.</p>   |
| <b>Secure Boot</b>           | <p>Secure Boot is a method of guaranteeing the integrity of the boot path by performing additional validation of the operating system and PCI add-in cards. The computer stops booting to the operating system when a component is not authenticated during the boot process. Secure Boot can be enabled in BIOS setup or using management interfaces like Dell Command Configure, but can only be disabled from BIOS setup.</p>  |
| Enable Secure Boot           | <p>Enables the computer to boot using only validated boot software.</p> <p>By default, this <b>Enable Secure Boot</b> option is disabled. For additional security, Dell Technologies recommends keeping the <b>Secure Boot</b> option enabled to ensure that the UEFI firmware validates the operating system during the boot process.</p> <p> <b>NOTE:</b> To view this option, enable <b>Advanced Setup</b> mode as described in <a href="#">View Advanced Setup options</a>.</p> <p> <b>NOTE:</b> To enable Secure Boot, the computer must be in UEFI boot mode and the Enable Legacy Option ROMs option must be turned off.</p> |
| Enable Microsoft UEFI CA     | <p>When disabled, the UEFI CA is removed from the BIOS UEFI Secure Boot database.</p> <p> <b>CAUTION:</b> If you disable Microsoft UEFI CA, the computer may not boot, computer graphics may not function, some devices may not function properly, and the computer could become unrecoverable.</p> <p>By default, the <b>Enable Microsoft UEFI CA</b> option is enabled.</p> <p>For additional security, Dell Technologies recommends keeping the <b>Enable Microsoft UEFI CA</b> option enabled to ensure the broadest compatibility with devices and operating systems.</p>   |
| Secure Boot Mode             | <p>Enables or disables the Secure Boot operation mode.</p> <p>By default, the <b>Deployed Mode</b> is selected. <b>Deployed Mode</b> should be selected for normal operation of Secure Boot.</p> <p> <b>NOTE:</b> To view this option, enable <b>Advanced Setup</b> mode as described in <a href="#">View Advanced Setup options</a>.</p>  |
| <b>Expert Key Management</b> |   |
| Enable Custom Mode           | <p>Enables or disables the keys in the PK, KEK, db, and dbx security key databases to be modified.</p> <p>By default, the <b>Enable Custom Mode</b> option is disabled.</p> <p> <b>NOTE:</b> To view this option, enable <b>Advanced Setup</b> mode as described in <a href="#">View Advanced Setup options</a>.</p>   |
| Custom Mode Key Management   | <p>Selects the custom values for expert key management.</p> <p>By default, the <b>PK</b> option is selected.</p> <p> <b>NOTE:</b> To view this option, enable <b>Advanced Setup</b> mode as described in <a href="#">View Advanced Setup options</a>.</p>  |









**Table 51. System Setup options—Integrated Devices menu**

| <b>Integrated Devices</b> |  |
|---------------------------|--|
| <b>Date/Time</b>          |  |

**Table 51. System Setup options—Integrated Devices menu (continued)**

| <b>Integrated Devices</b>                    |   |
|--|---|
| Date   | Sets the computer date in MM/DD/YYYY format. Changes to the date format take effect immediately.  |
| Time   | Sets the computer time in HH/MM/SS 24-hour format. You can select between a 12-hour or 24-hour clock. Changes to the time format take effect immediately.   |
| <b>Camera</b>                                |   |
| Enable Camera                                | Enables the camera.<br>By default, the <b>Enable Camera</b> option is enabled.<br> <b>NOTE:</b> Depending on the configuration ordered, the camera setup option may not be available.  |
| <b>Audio</b>                                 |   |
| Enable Audio                                 | Enables all integrated audio controller.<br>By default, all the options are enabled.  |
| Enable Microphone                            | Enables the microphone.<br>By default, the <b>Enable Microphone</b> option is enabled.<br> <b>NOTE:</b> Depending on the configuration ordered, the microphone setup option may not be available.  |
| Enable Internal Speaker                      | Enables the internal speaker.<br>By default, the <b>Enable Internal Speaker</b> option is enabled.  |
| <b>Serial port</b>                           |   |
| Serial Port 1 Configuration                  | By default, the <b>COM1: Port is configured at 3F8h with IRQ 4</b> option is selected   |
| <b>USB/Thunderbolt Configuration</b>         |   |
| Enable USB Boot Support                      | Enables booting from USB mass storage devices that are connected to external USB ports.<br>By default, the <b>Enable USB Boot Support</b> option is enabled.<br> <b>NOTE:</b> To view this option, enable <b>Advanced Setup</b> mode as described in <a href="#">View Advanced Setup options</a> .     |
| Enable External USB Ports                    | Enables the external USB ports.<br>By default, the <b>Enable External USB Ports</b> option is enabled.<br> <b>NOTE:</b> To view this option, enable <b>Advanced Setup</b> mode as described in <a href="#">View Advanced Setup options</a> .   |
| <b>Enable Thunderbolt Technology Support</b> |   |
| Enable Thunderbolt Technology Support        | Enables the associated ports and adapters for Thunderbolt Technology support.<br>By default, the <b>Enable Thunderbolt Technology Support</b> option is enabled.<br> <b>NOTE:</b> To view this option, enable <b>Advanced Setup</b> mode as described in <a href="#">View Advanced Setup options</a> . |
| <b>Enable Thunderbolt Boot Support</b>       |   |
| Enable Thunderbolt Boot Support              | Enables the Thunderbolt adapter-peripheral device and USB devices that are connected to the Thunderbolt adapter to be used during BIOS Preboot.<br>By default, the <b>Enable Thunderbolt Boot Support</b> option is disabled.   |

**Table 51. System Setup options—Integrated Devices menu (continued)**

| <b>Integrated Devices</b>  |   |
|--|---|
|  | <p> <b>NOTE:</b> To view this option, enable <b>Advanced Setup</b> mode as described in <a href="#">View Advanced Setup options</a>.</p>   |
| <b>Enable Thunderbolt (and PCIe behind TBT) pre-boot modules</b> | <p>Enables the PCIe devices that are connected through a Thunderbolt adapter to run the PCIe devices UEFI Option ROM (if present) during preboot.</p> <p>By default, the <b>Enable Thunderbolt (and PCIe behind TBT) pre-boot modules</b> option is disabled.</p> <p> <b>NOTE:</b> To view this option, enable <b>Advanced Setup</b> mode as described in <a href="#">View Advanced Setup options</a>.</p>             |
| <b>Disable USB4 PCIe Tunneling</b>                               | <p>Disables the USB4 PCIe Tunneling option.</p> <p>By default, the <b>Disable USB4 PCIe Tunneling</b> option is disabled.</p> <p> <b>NOTE:</b> To view this option, enable <b>Advanced Setup</b> mode as described in <a href="#">Entering BIOS Setup program</a>.</p>   |
| <b>Video/Power only on Type-C Ports</b>                          | <p>Enables or disables the Type-C port functionality to video or only power.</p> <p>By default, the <b>Video/Power only on Type-C Ports</b> option is disabled.</p> <p> <b>NOTE:</b> To view this option, enable <b>Advanced Setup</b> mode as described in <a href="#">View Advanced Setup options</a>.</p>   |
| <b>Type-C Dock</b>   |   |
| Type-C Dock Override   | <p>Enables or disables to use connected Type-C Dell Dock to provide data stream with external USB ports disabled. When Type-C Dock override is enabled, the Video/Audio/LAN submenu is activated.</p> <p>By default, the <b>Type-C Dock Override</b> option is enabled.</p> <p> <b>NOTE:</b> To view this option, enable <b>Advanced Setup</b> mode as described in <a href="#">Entering BIOS Setup program</a>.</p> |
| Type-C Dock Audio  | <p>Enables or disables the usage of audio inputs and outputs from the connected Type-C Dell docking station.</p> <p>By default, the <b>Type-C Dock Audio</b> option is enabled.</p> <p> <b>NOTE:</b> To view this option, enable <b>Advanced Setup</b> mode as described in <a href="#">View Advanced Setup options</a>.</p>   |
| Type-C Dock LAN  | <p>Enables or disables the usage of LAN on the external ports of the connected Type-C Dell docking station.</p> <p>By default, the <b>Type-C Dock LAN</b> option is enabled.</p> <p> <b>NOTE:</b> To view this option, enable <b>Advanced Setup</b> mode as described in <a href="#">View Advanced Setup options</a>.</p>  |
| <b>Miscellaneous Devices</b>                                     |   |
| Enable Dedicated GPS Radio                                       | <p>Enables or disables the Dedicated GPS Radio option.</p> <p>By default, the <b>Dedicated GPS Radio</b> option is enabled.</p> <p> <b>NOTE:</b> To view this option, enable <b>Advanced Setup</b> mode as described in <a href="#">View Advanced Setup options</a>.</p>   |
| Unobtrusive Mode   | <p>Enables or disables the unobtrusive mode. When enabled, all system LEDs, LCD panel backlight and audio devices of the computer are turned off.</p> <p>By default, the <b>Unobtrusive Mode</b> option is disabled.</p>  |

**Table 51. System Setup options—Integrated Devices menu (continued)**

| <b>Integrated Devices</b>  |   |
|----------------------------|---|
|                            | <p><b>i</b> <b>NOTE:</b> On computers with collaboration touchpad, the Collaboration Touchpad is disabled when the <b>Unobtrusive Mode</b> option is enabled.</p> <p><b>i</b> <b>NOTE:</b> To view this option, enable <b>Advanced Setup</b> mode as described in <a href="#">View Advanced Setup options</a>.</p>  |
| <b>Stealth Mode</b>        |   |
| Enable Stealth Mode        | <p>Enables or disables the stealth mode. When enabled, all system light and sound are turned off. Toggling &lt;Fn&gt;+Shift+&lt;B&gt; enters and exits unobtrusive mode. If this option is grayed out and needs to be enabled, please ensure Collaboration Touchpad (Go to Pre-Boot Behavior) is disabled first. Then turn on the stealth mode.</p> <p>By default, the <b>Enable Stealth Mode</b> option is enabled.</p> <p><b>i</b> <b>NOTE:</b> On computers with collaboration touchpad, the Collaboration Touchpad is disabled when the <b>Stealth Mode</b> option is enabled.</p> <p><b>i</b> <b>NOTE:</b> To view this option, enable <b>Advanced Setup</b> mode as described in <a href="#">View Advanced Setup options</a>.</p> |
| Disable onboard LEDs       | Configures the Dell Stealth Mode feature. Checking <b>Enable Stealth Mode</b> enables this feature. All other controls on this page may only be configured when stealth mode is enabled.  |
| Disable onboard LCD Screen | Enables or disables the onboard LCD Screen.   |
| Disable onboard speakers   | Enables or disables the onboard speakers.   |
| Disable onboard fans       | Enables or disables the onboard fans.   |
| Disable Bluetooth radio    | Enables or disables the Bluetooth radio.  |
| Disable GPS Receiver       | Enables or disables the GPS Receiver.   |
| Disable WLAN radio         | Enables or disables the WLAN radio.   |
| Disable WWAN radio         | Enables or disables the WAN radio.  |

**Table 52. System Setup options—Storage menu**

| <b>Storage</b>             |   |
|----------------------------|---|
| <b>SATA/NVMe Operation</b> |   |
| SATA/NVMe Operation        | <p>Sets the operating mode of the integrated SATA hard drive controller.</p> <p>By default, the <b>Raid On</b> option is selected.</p>  |
| <b>Storage Interface</b>   |   |
| Port Enablement            | <p>Enables or disables the M.2 PCIe SSD option.</p> <p>By default, the <b>M.2 PCIe SSD</b> option is enabled.</p>   |
| Smart Reporting            | <p>Enables or disables the Smart reporting option.</p> <p>By default, the <b>Smart Reporting</b> option is disabled.</p> <p><b>i</b> <b>NOTE:</b> To view this option, enable <b>Advanced Setup</b> mode as described in <a href="#">View Advanced Setup options</a>.</p> |
| <b>Drive Information</b>   |   |
| <b>Enable MediaCard</b>    |   |
| Secure Digital (SD) Card   | Enables or disables the SD card.  |

**Table 52. System Setup options—Storage menu (continued)**

| Storage                                 |   |
|---|---|
|   | <p>By default, the <b>Secure Digital (SD) Card</b> option is enabled.</p> <p><b>i</b> <b>NOTE:</b> To view this option, enable <b>Advanced Setup</b> mode as described in <a href="#">View Advanced Setup options</a>.</p>  |
| Secure Digital (SD) Card Read-Only Mode | <p>Enables or disables the SD card read-only mode.</p> <p><b>i</b> <b>NOTE:</b> To view this option, enable <b>Advanced Setup</b> mode as described in <a href="#">View Advanced Setup options</a>.</p> <p>By default, the <b>Secure Digital (SD) Card Read-Only Mode</b> option is disabled.</p> |

**Table 53. System Setup options—Display menu**

| Display                       |  |
|-------------------------------|--|
| Display Brightness            |  |
| Brightness on battery power   | <p>By default, the screen brightness is set to 50 when the computer is running on battery power. Set the screen brightness when the computer is running on battery power.</p> <p><b>i</b> <b>NOTE:</b> To view this option, enable <b>Advanced Setup</b> mode as described in <a href="#">View Advanced Setup options</a>.</p>                         |
| Brightness on AC power        | <p>By default, the screen brightness is set to 100 when the computer is running on AC power. Set the screen brightness when the computer is running on AC power.</p> <p><b>i</b> <b>NOTE:</b> To view this option, enable <b>Advanced Setup</b> mode as described in <a href="#">View Advanced Setup options</a>.</p>                                  |
| Touchscreen                   | <p>Enables or disables the touch screen option.</p> <p>By default, the <b>Touchscreen</b> option is enabled.</p> <p><b>i</b> <b>NOTE:</b> Only available on computers with touch screen displays.</p> <p><b>i</b> <b>NOTE:</b> To view this option, enable <b>Advanced Setup</b> mode as described in <a href="#">View Advanced Setup options</a>.</p> |
| Full Screen Logo              | <p>Enables or disables the computer to display full screen logo, if the image matches screen resolution.</p> <p>By default, the <b>Full Screen Logo</b> option is disabled.</p> <p><b>i</b> <b>NOTE:</b> To view this option, enable <b>Advanced Setup</b> mode as described in <a href="#">View Advanced Setup options</a>.</p>                       |
| Limit Panel Brightness to 50% | <p>Allows you to limit the panel brightness to 50%.</p> <p>By default, the <b>Limit Panel Brightness to 50%</b> option is turned is off.</p> <p><b>i</b> <b>NOTE:</b> To view this option, enable <b>Advanced Setup</b> mode as described in <a href="#">View Advanced Setup options</a>.</p>  |



**Table 54. System Setup options—Connection menu**

| Connection             |  |
|------------------------|--|
| Wireless Device Enable |  |
| WWAN/GPS               | <p>Enables or disables the internal WWAN device.</p> <p>By default, the <b>WWAN/GPS</b> option is enabled.</p> |
| WLAN                   | <p>Enables or disables the internal WLAN device.</p> <p>By default, the <b>WLAN</b> option is enabled.</p>     |

**Table 54. System Setup options—Connection menu (continued)**

| <b>Connection</b>                  |  |
|------------------------------------|--|
| Bluetooth                          | <p>Enables or disables the internal Bluetooth device.</p> <p>By default, the <b>Bluetooth</b> option is enabled.</p>   |
| Contactless Smartcard/NFC          | <p>Enables or disables the smartcard device.</p> <p>By default, the <b>Contactless Smartcard/NFC</b> option is enabled.</p> <p><b>NOTE:</b> To view this option, enable <b>Advanced Setup</b> mode as described in <a href="#">View Advanced Setup options</a>.</p>  |
| <b>Enable UEFI Network Stack</b>   | <p>Enables or disables the UEFI Network Stack and controls the onboard LAN Controller.</p> <p>By default, the <b>Enable UEFI Network Stack</b> option is enabled.</p> <p><b>NOTE:</b> To view this option, enable <b>Advanced Setup</b> mode as described in <a href="#">View Advanced Setup options</a>.</p>  |
| <b>Wireless Radio Control</b>      |  |
| Control WLAN Radio                 | <p>Enable to sense the connection of the computer to a wired network and then disables the selected WLAN radio. Upon disconnection from the wired network, the selected wireless radios are reenabled.</p> <p>By default, the <b>Control WLAN Radio</b> option is disabled.</p> <p><b>NOTE:</b> To view this option, enable <b>Advanced Setup</b> mode as described in <a href="#">View Advanced Setup options</a>.</p>  |
| Control WWAN Radio                 | <p>Enables to sense the connection of the computer to a wired network and then disables the selected WWAN radios.</p> <p>By default, the <b>Control WWAN Radio</b> option is disabled.</p> <p><b>NOTE:</b> To view this option, enable <b>Advanced Setup</b> mode as described in <a href="#">View Advanced Setup options</a>.</p>   |
| <b>Enable UEFI Bluetooth Stack</b> | <p>Enables or disables the UEFI Bluetooth Stack.</p> <p>By default, the <b>Enable UEFI Bluetooth Stack</b> option is enabled.</p> <p><b>NOTE:</b> To view this option, enable <b>Advanced Setup</b> mode as described in <a href="#">View Advanced Setup options</a>.</p>  |
| Dynamic Wireless Transmit Power    | <p>When enabled, the computer increases the transmit power of the WLAN device to improve performance in certain computer configurations.</p> <p><b>NOTE:</b> To view this option, enable <b>Advanced Setup</b> mode as described in <a href="#">View Advanced Setup options</a>.</p>   |
| <b>HTTP(s) Boot Feature</b>        |  |
| HTTP(s) Boot                       | <p>When enabled, supports HTTP(s) boot on the client BIOS, which offers wired or wireless and HTTP/HTTPS connection options.</p> <p><b>NOTE:</b> To view this option, enable <b>Advanced Setup</b> mode as described in <a href="#">View Advanced Setup options</a>.</p>   |
| HTTP(s) Boot Modes                 | <p>In Auto Mode, the boot URL is obtained from the DHCP response; the boot URL specifies the HTTP Boot Server and location of the Network Boot Program (NBP) file. In Manual mode, the user enters the URL in the text box, which must start with <code>http://</code> or <code>https://</code> and end with the NBP file name.</p> <p>By default, <b>Auto Mode</b> is selected.</p> <p><b>NOTE:</b> To view this option, enable <b>Advanced Setup</b> mode as described in <a href="#">View Advanced Setup options</a>.</p> |
| CA Certificate                     | <p>Upload or delete the CA certificate.</p>  |

**Table 54. System Setup options—Connection menu (continued)**

| Connection            |  |
|-----------------------|--|
|                       | <p> <b>NOTE:</b> To view this option, enable <b>Advanced Setup</b> mode as described in <a href="#">View Advanced Setup options</a>.</p>  |
| <b>Antenna Switch</b> | <p>This setting configures, on a radio-by-radio basis, which antenna to use when docked: docking station or system. If set to Dock antenna, the default, then the radio will be switched to use the external docking station antenna when docked. If set to System, the radio will continue using the internal system antenna, even when docked. When the system is undocked, the system antennas are used and this option has no effect.</p> <p> <b>NOTE:</b> This setting applies to Rugged docking stations and does not apply to USB Type-C docking stations.</p> <p> <b>NOTE:</b> For radios having more than one antenna, the setting will apply to both antennas.</p> |
| WLAN Antenna          | <p>Enable or disable the Dock Antenna or System Antenna option</p> <p>By default, the <b>Dock Antenna</b> option is enabled.</p>   |
| WWAN Antenna          | <p>Enable or disable the Dock Antenna or System Antenna option</p> <p>By default, the <b>Dock Antenna</b> option is enabled.</p>   |
| GPS Antenna           | <p>Enable or disable the Dock Antenna or System Antenna option</p> <p>By default, the <b>Dock Antenna</b> option is enabled.</p>   |

**Table 55. System Setup options—Power menu**

| Power  |   |
|--|---|
| <b>Battery Configuration</b>                 |   |
| Battery 1 Configuration                      | <p>Enables or disables the computer to run on battery during peak power usage hours. Use the table <b>Custom Charge Start</b> and <b>Custom Charge Stop</b>, to prevent AC power usage between certain times of each day.</p> <p>By default, the <b>Adaptive</b> option is selected. Battery settings are adaptively optimized based on your typical battery usage pattern.</p>   |
| Battery 2 Configuration                      | <p>Enables or disables the computer to run on battery during peak power usage hours. Use the table <b>Custom Charge Start</b> and <b>Custom Charge Stop</b>, to prevent AC power usage between certain times of each day.</p> <p>By default, the <b>Adaptive</b> option is selected. Battery settings are adaptively optimized based on your typical battery usage pattern.</p>   |
| <b>Advanced Configuration</b>                |   |
| Enable Advanced Battery Charge Configuration | <p>Enables Advanced Battery Charge Configuration from the beginning of the day to a specified work period. When enabled, Advanced Battery Charged maximizes battery health while still supporting heavy use during the work day.</p> <p>By default, the <b>Enable Advanced Battery Charge Configuration</b> option is disabled.</p> <p> <b>NOTE:</b> To view this option, enable <b>Advanced Setup</b> mode as described in <a href="#">View Advanced Setup options</a>.</p> |
| <b>Peak Shift</b>                            |   |
| Enable Peak Shift                            | <p>Enables or disables the computer to run on battery during peak power usage hours.</p> <p>By default, the <b>Enable Peak Shift</b> option is disabled.</p>  |

**Table 55. System Setup options—Power menu (continued)**

| <b>Power</b>                        |   |
|-------------------------------------|---|
|                                     | <p> <b>NOTE:</b> To view this option, enable <b>Advanced Setup</b> mode as described in <a href="#">View Advanced Setup options</a>.</p>   |
| Type-C Connector Power              | <p>This option allows to select the maximum power that can be drawn from the Type-C connector.</p> <p>By default, the <b>7.5 watts</b> option is enabled.</p>   |
| USB PowerShare                      | <p>Enables or disables the USB PowerShare on the computer.</p> <p>By default, the <b>USB Powershare</b> option is disabled.</p>   |
| <b>Thermal Management</b>           | <p>This setting allows for cooling of fan and processor heat management to adjust system performance, noise and temperature.</p> <p>By default, the <b>Optimized</b> option is selected.</p>  |
| <b>USB Wake Support</b>             |   |
| Wake on Dell USB-C Dock             | <p>When enabled, connecting a Dell USB-C Dock wakes the computer from Standby, Hibernate, and Power Off.</p> <p>By default, the <b>Wake on Dell USB-C Dock</b> option is enabled.</p> <p> <b>NOTE:</b> To view this option, enable <b>Advanced Setup</b> mode as described in <a href="#">View Advanced Setup options</a>.</p>   |
| <b>Block Sleep</b>                  | <p>Enables or disables the computer from entering Sleep (S3) mode in the operating system.</p> <p>By default, the <b>Block Sleep</b> option is disabled.</p> <p> <b>NOTE:</b> When enabled, the computer does not go to Sleep, Intel Rapid Start is disabled automatically, and the operating system power option is blank if it was set to Sleep.</p> <p> <b>NOTE:</b> To view this option, enable <b>Advanced Setup</b> mode as described in <a href="#">View Advanced Setup options</a>.</p> |
| <b>Lid Switch</b>                   |   |
| Enable Lid Switch                   | <p>Enables or disables the Lid Switch.</p> <p>By default, the <b>Enable Lid Switch</b> option is enabled.</p>   |
| Power On Lid Open                   | <p>When enabled, allows the computer to turn on from the off state whenever the lid is opened.</p> <p>By default, the <b>Power On Lid Open</b> option is enabled.</p>   |
| <b>Intel Speed Shift Technology</b> | <p>Enables or disables the Intel Speed Shift Technology support. When enabled, the operating system selects the appropriate processor performance automatically.</p> <p>By default, the <b>Intel Speed Shift Technology</b> option is enabled.</p> <p> <b>NOTE:</b> To view this option, enable <b>Service</b> options as described in <a href="#">View Service options</a>.</p>   |







**Table 56. System Setup options—Security menu**

| <b>Security</b>         |   |
|-------------------------|---|
| <b>TPM 2.0 Security</b> | <p>Trusted Platform Module (TPM) is a security device that stores computer-generated keys for encryption and features such as BitLocker, Virtual Secure Mode, remote Attestation.</p> <p>By default, the <b>TPM 2.0 Security</b> option is enabled.</p> |







**Table 56. System Setup options—Security menu (continued)**

| Security  |   |
|---|---|
|   | <p>For additional security, Dell Technologies recommends keeping the Trusted Platform Module (TPM) enabled to allow these security technologies to fully function.</p>  |
| TPM 2.0 Security On   | <p>Enables or disables the TPM.</p> <p>By default, the <b>TPM 2.0 Security On</b> option is enabled.</p> <p>For additional security, Dell Technologies recommends keeping TPM enabled to allow these security technologies to fully function.</p> <p><b>NOTE:</b> To view this option, enable <b>Advanced Setup</b> mode as described in <a href="#">View Advanced Setup options</a>.</p>   |
| Attestation Enable  | <p>The <b>Attestation Enable</b> option controls the endorsement hierarchy of TPM. Disabling the <b>Attestation Enable</b> option prevents TPM from being used to digitally sign certificates.</p> <p>By default, the <b>Attestation Enable</b> option is enabled.</p> <p>For additional security, Dell Technologies recommends keeping the <b>Attestation Enable</b> option enabled.</p> <p><b>NOTE:</b> When disabled, this feature may cause compatibility issues or loss of functionality in some operating systems.</p> <p><b>NOTE:</b> To view this option, enable <b>Advanced Setup</b> mode as described in <a href="#">View Advanced Setup options</a>.</p>              |
| Key Storage Enable  | <p>The <b>Key Storage Enable</b> option controls the storage hierarchy of TPM, which is used to store digital keys. Disabling the <b>Key Storage Enable</b> option restricts the ability of TPM to store owner's data.</p> <p>By default, the <b>Key Storage Enable</b> option is enabled.</p> <p>For additional security, Dell Technologies recommends keeping the <b>Key Storage Enable</b> option enabled.</p> <p><b>NOTE:</b> When disabled, this feature may cause compatibility issues or loss of functionality in some operating systems.</p> <p><b>NOTE:</b> To view this option, enable <b>Service</b> options as described in <a href="#">View Service options</a>.</p> |
| Clear   | <p>When enabled, the <b>Clear</b> option clears information that is stored in the TPM after exiting the system's BIOS. This option returns to the disabled state when the computer restarts.</p> <p>By default, the <b>Clear</b> option is disabled.</p> <p>Dell Technologies recommends enabling the <b>Clear</b> option only when TPM data is required to be cleared.</p> <p><b>NOTE:</b> To view this option, enable <b>Advanced Setup</b> mode as described in <a href="#">View Advanced Setup options</a>.</p>   |
| Physical Presence Interface (PPI) Bypass for Clear Commands | <p>The PPI Bypass for Clear Commands option allows the operating system to manage certain aspects of PTT. When enabled, you are not prompted to confirm changes to the PTT configuration.</p> <p>By default, the <b>PPI Bypass for Clear Commands</b> option is disabled.</p> <p>For additional security, Dell Technologies recommends keeping the <b>PPI Bypass for Clear Commands</b> option disabled.</p>  |
| Intel Total Memory Encryption                               | <p>Enables or disables the processor's memory encryption feature.</p> <p>By default, the <b>Intel Total Memory Encryption</b> option is disabled.</p>   |

**Table 56. System Setup options—Security menu (continued)**

| <b>Security</b>                |   |
|--------------------------------|---|
|                                | <p> <b>NOTE:</b> To view this option, enable <b>Advanced Setup</b> mode as described in <a href="#">View Advanced Setup options</a>.</p>   |
| <b>Chassis Intrusion</b>       |   |
| Chassis Intrusion              | <p>Enables or disables the detection of chassis intrusion events. This feature notifies the user when the base cover has been removed from the computer.</p> <p>When set to <b>Enabled</b>, a notification is displayed on the next boot and the event is logged in the BIOS Events log.</p> <p>When set to <b>Disabled</b>, no notification is displayed and no event is logged in the BIOS Events log.</p> <p>When set to <b>On-Silent</b>, the event is logged in the BIOS Events log, but no notification is displayed.</p> <p>By default, the <b>Chassis Intrusion Detection</b> option is disabled.</p> <p>For additional security, Dell Technologies recommends keeping the <b>Chassis Intrusion</b> option enabled.</p> <p> <b>NOTE:</b> To view this option, enable <b>Advanced Setup</b> mode as described in <a href="#">View Advanced Setup options</a>.</p>   |
| Block Boot Until Cleared       | <p>The <b>Block Boot Until Clear</b> option is enabled when <b>Chassis Intrusion</b> is enabled. When enabled, the computer does not boot until the chassis intrusion is cleared.</p> <p> <b>NOTE:</b> To view this option, enable <b>Advanced Setup</b> mode as described in <a href="#">View Advanced Setup options</a>.</p>  |
| <b>SMM Security Mitigation</b> |   |
|                                | <p>Enables or disables additional UEFI SMM Security Mitigation protections. This option uses the Windows SMM Security Mitigations Table (WSMT) to confirm to the operating system that security best practices have been implemented by the UEFI firmware.</p> <p>By default, the <b>SMM Security Mitigation</b> option is enabled.</p> <p>For additional security, Dell Technologies recommends keeping the <b>SMM Security Mitigation</b> option enabled unless you have a specific application which is not compatible.</p> <p> <b>NOTE:</b> This feature may cause compatibility issues or loss of functionality with some legacy tools and applications.</p> <p> <b>NOTE:</b> To view this option, enable <b>Service</b> options as described in <a href="#">View Service options</a>.</p>   |
| <b>Data Wipe on Next Boot</b>  |   |
| Start Data Wipe                | <p>Data Wipe is a secure wipe operation that deletes information from a storage device.</p> <p> <b>CAUTION: The secure Data Wipe operation deletes information in a way that it cannot be reconstructed.</b></p> <p>Commands such as delete and format in the operating system may remove files from showing up in the file system. However, they can be reconstructed through forensic means as they are still represented on the physical media. Data Wipe prevents this reconstruction and the data can no longer be recovered.</p> <p>When enabled, the data wipe option provides prompts to wipe any storage devices that are connected to the computer on the next boot.</p> <p>By default, the <b>Start Data Wipe</b> option is disabled.</p> <p> <b>NOTE:</b> To view this option, enable <b>Advanced Setup</b> mode as described in <a href="#">View Advanced Setup options</a>.</p> |

**Table 56. System Setup options—Security menu (continued)**

| Security                                |   |
|---|---|
| <b>Absolute</b>                         | <p>Absolute Software provides various cyber security solutions, some requiring software preloaded on Dell computers and integrated into the BIOS. To use these features, you must enable the Absolute BIOS setting and contact Absolute for configuration and activation.</p> <p>By default, the <b>Absolute</b> option is enabled.</p> <p>For additional security, Dell Technologies recommends keeping the <b>Absolute</b> option enabled.</p> <p> <b>WARNING:</b> The Permanently Disabled option can only be selected once. When Permanently Disabled is selected, Absolute Persistence cannot be reenabled. No further changes to the Enable/Disable states are allowed.</p> <p> <b>NOTE:</b> The Enable/Disable options are unavailable while the computer is in the activated state.</p> <p> <b>NOTE:</b> When the Absolute features are activated, the Absolute integration cannot be disabled from the BIOS Setup screen.</p> |
| <b>UEFI Boot Path Security</b>          | <p>Enables or disables the computer to prompt the user to enter the Administrator password (if set) when booting to a UEFI boot path device from the F12 boot menu.</p> <p>By default, the <b>Always Except Internal HDD</b> option is enabled.</p> <p> <b>NOTE:</b> To view this option, enable <b>Advanced Setup</b> mode as described in <a href="#">View Advanced Setup options</a>.</p>  |
| <b>Firmware Device Tamper Detection</b> | <p>Allows you to control the firmware device tamper detection feature. This feature notifies the user when the firmware device is tampered. When enabled, a screen warning message is displayed on the computer and a tamper detection event is logged in the BIOS Events log. The computer fails to reboot until the event is cleared.</p> <p>By default, the <b>Firmware Device Tamper Detection</b> option is enabled.</p> <p>For additional security, Dell Technologies recommends keeping the <b>Firmware Device Tamper Detection</b> option enabled.</p> <p> <b>NOTE:</b> To view this option, enable <b>Advanced Setup</b> mode as described in <a href="#">View Advanced Setup options</a>.</p>  |
| Clear Firmware Device Tamper Detection  | <p>Allows you to clear the events that are logged when tampering of firmware device is detected.</p> <p>By default, the <b>Clear Firmware Device Tamper Detection</b> option is disabled.</p> <p> <b>NOTE:</b> To view this option, enable <b>Advanced Setup</b> mode as described in <a href="#">View Advanced Setup options</a>.</p>   |

**Table 57. System Setup options—Passwords menu**

| Passwords                     |  |
|-------------------------------|--|
| <b>Administrator Password</b> | <p>The Administrator Password prevents unauthorized access to the BIOS Setup options. Once the administrator password is set, the BIOS Setup options can only be modified after providing the correct password.</p> <p>The following rules and dependencies apply to the Administrator Password -</p> <ul style="list-style-type: none"> <li>• The administrator password cannot be set if system and/or internal storage passwords are previously set.</li> <li>• The administrator password can be used in place of the system and/or internal storage passwords.</li> </ul> |

**Table 57. System Setup options—Passwords menu (continued)**

|                                       |  |
|---------------------------------------|--|
| <p><b>Passwords</b></p>               | <ul style="list-style-type: none"> <li>• When set, the administrator password must be provided during a firmware update.</li> <li>• Clearing the administrator password also clears the system password (if set).</li> </ul> <p>Dell Technologies recommends using an administrator password to prevent unauthorized changes to BIOS Setup options.</p>  |
| <p><b>System Password</b></p>         | <p>The System Password prevents the computer from booting to an operating system without entering the correct password.</p> <p>The following rules and dependencies apply when the System Password is used -</p> <ul style="list-style-type: none"> <li>• The computer shuts down when idle for approximately 10 minutes at the system password prompt.</li> <li>• The computer shuts down after three incorrect attempts to enter the system password.</li> <li>• The computer shuts down when the <b>Esc</b> key is pressed at the <b>System Password</b> prompt.</li> <li>• The system password is not prompted when the computer resumes from standby mode.</li> </ul> <p>Dell Technologies recommends using the system password in situations where it is likely that a computer may be lost or stolen.</p>   |
| <p><b>M.2 PCIe SSD-0 Password</b></p> | <p>The hard drive password can be set to prevent unauthorized access of the data stored on the solid-state drive. The computer prompts for the hard drive password during boot in order to unlock the drive. A password-secured hard drive stays locked even when removed from the computer or placed into another computer. It prevents an attacker from accessing data on the drive without authorization.</p> <p>The following rules and dependencies apply when the <b>M.2 PCIe SSD-0 Password</b> option is used.</p> <ul style="list-style-type: none"> <li>• The hard drive password option cannot be accessed when the hard drive is disabled in the BIOS Setup.</li> <li>• The computer shuts down when idle for approximately 10 minutes at the hard drive password prompt.</li> <li>• The computer shuts down after three incorrect attempts to enter the hard drive password and treats the hard drive as not available.</li> <li>• The hard drive does not accept password unlock attempts after five incorrect attempts to enter the hard drive password from the BIOS Setup. The hard drive password must be reset for the new password unlock attempts.</li> <li>• The computer treats the hard drive as not available when the <b>Esc</b> key is pressed at the hard drive password prompt.</li> <li>• The hard drive password is not prompted when the computer resumes from standby mode. When the hard drive is unlocked by the user before the computer goes into standby mode, it remains unlocked after the computer resumes from standby mode.</li> <li>• If the system and hard drive passwords are set to the same value, the hard drive unlocks after the correct system password is entered.</li> </ul> <p>Dell Technologies recommends using a hard drive password to protect unauthorized data access.</p> |
| <p><b>Password Configuration</b></p>  | <p>The Password configuration page includes several options for changing the requirements of BIOS passwords. You can modify the minimum and maximum length of the passwords as well as require passwords to contain certain character classes (upper case, lower case, digit, special character).</p> <p>When the <b>Lower Case Letter</b> option is enabled, the password requires at least one lower case letter.</p> <p>When the <b>Upper Case Letter</b> option is enabled, the password requires at least one upper case letter.</p>  |

**Table 57. System Setup options—Passwords menu (continued)**

| <b>Passwords</b>                      |   |
|---------------------------------------|---|
|                                       | <p>When the <b>Digit</b> option is enabled, the password requires at least one numeric digit.</p> <p>When the <b>Special Character</b> option is enabled, the password requires at least one special character from the set: !"#%&amp;'()*+,-./:;&lt;=&gt;?@\]^_`{ }~.</p> <p>When setting <b>Minimum Characters</b> for password length, Dell Technologies recommends setting the minimum password length to at least eight characters.</p> <p><b>NOTE:</b> To view this option, enable <b>Advanced Setup</b> mode as described in <a href="#">View Advanced Setup options</a>.</p>  |
| <b>Password Bypass</b>                | <p>The <b>Password Bypass</b> option allows the computer to reboot from the operating system without entering the system or hard drive password. If the computer has already booted to the operating system, it is presumed that the user has already entered the correct system or hard drive password.</p> <p><b>NOTE:</b> This option does not remove the requirement to enter the password after shutting down.</p> <p>By default, the <b>Password Bypass</b> option is disabled.</p> <p>For additional security, Dell Technologies recommends keeping the <b>Password Bypass</b> option enabled.</p> <p><b>NOTE:</b> To view this option, enable <b>Advanced Setup</b> mode as described in <a href="#">View Advanced Setup options</a>.</p> |
| <b>Password Changes</b>               |   |
| Allow Non-Admin Password Changes      | <p>The <b>Allow Non-Admin Password Changes</b> option in BIOS Setup allows an end user to set or change the system or hard drive passwords without entering the administrator password. This gives an administrator control over the BIOS settings but enables an end user to provide their own password.</p> <p>By default, the <b>Allow Non-Admin Password Changes</b> option is enabled.</p> <p>For additional security, Dell Technologies recommends keeping the <b>Allow Non-Admin Password Changes</b> option disabled.</p> <p><b>NOTE:</b> To view this option, enable <b>Advanced Setup</b> mode as described in <a href="#">View Advanced Setup options</a>.</p>   |
| Non-Admin Setup Changes               | <p>The <b>Non-Admin Setup Changes</b> option allows an end user to configure the wireless devices without requiring the administrator password.</p> <p>By default, the <b>Non-Admin Setup Changes</b> option is disabled.</p> <p>For additional security, Dell Technologies recommends keeping the <b>Non-Admin Setup Changes</b> option disabled.</p> <p><b>NOTE:</b> To view this option, enable <b>Advanced Setup</b> mode as described in <a href="#">View Advanced Setup options</a>.</p>  |
| <b>Enable Admin Setup Lockout</b>     | <p>The <b>Admin Setup Lockout</b> option prevents an end user from even viewing the BIOS Setup configuration without first entering the administrator password (if set).</p> <p>By default, the <b>Enable Admin Setup Lockout</b> option is disabled.</p> <p>For additional security, Dell Technologies recommends keeping the <b>Admin Setup Lockout</b> option disabled.</p> <p><b>NOTE:</b> To view this option, enable <b>Advanced Setup</b> mode as described in <a href="#">View Advanced Setup options</a>.</p>  |
| <b>Enable Master Password Lockout</b> | <p>The <b>Master Password Lockout</b> option allows you to disable the Recovery Password feature. If the system, administrator, or hard drive password is forgotten, the computer becomes unusable.</p>   |

**Table 57. System Setup options—Passwords menu (continued)**

| Passwords                                 |  |
|---|--|
|   | <p><b>i</b> <b>NOTE:</b> When the owner password is set, the Master Password Lockout option is not available.</p> <p><b>i</b> <b>NOTE:</b> When an internal hard drive password is set, it must first be cleared before Master Password Lockout can be changed.</p> <p>By default, the <b>Enable Master Password Lockout</b> option is disabled.</p> <p>Dell Technologies does not recommend enabling the <b>Master Password Lockout</b> unless you have implemented your own password recovery system.</p> <p><b>i</b> <b>NOTE:</b> To view this option, enable <b>Advanced Setup</b> mode as described in <a href="#">View Advanced Setup options</a>.</p> |
| <b>Enable Allow Non-Admin PSID Revert</b> | <p>The <b>Allow Non-Admin PSID Revert</b> option allows a user to clear the hard drive password without entering the BIOS Admin Password. When an Admin Password is set, the ability to enter the PSID is protected by requiring authentication with the Admin Password. If this option is enabled, any user can clear the drive without entering the Admin Password.</p> <p>By default, the <b>Enable Allow Non-Admin PSID Revert</b> option is disabled.</p> <p><b>i</b> <b>NOTE:</b> To view this option, enable <b>Advanced Setup</b> mode as described in <a href="#">View Advanced Setup options</a>.</p>  |

**Table 58. System Setup options—Update, Recovery menu**

| Update, Recovery                     |  |
|--------------------------------------|--|
| <b>UEFI Capsule Firmware Updates</b> |  |
| Enable UEFI Capsule Firmware Updates | <p>Enables or disables BIOS updates through UEFI capsule update packages.</p> <p><b>i</b> <b>NOTE:</b> Disabling this option blocks the BIOS updates from services such as Microsoft Windows Update and Linux Vendor Firmware Service (LVFS).</p> <p>By default, the <b>Enable UEFI Capsule Firmware Updates</b> option is enabled.</p> <p><b>i</b> <b>NOTE:</b> To view this option, enable <b>Advanced Setup</b> mode as described in <a href="#">View Advanced Setup options</a>.</p>   |
| <b>BIOS Recovery from Hard Drive</b> | <p>Enables or disables the user to recover from certain corrupted BIOS conditions from a recovery file on the user primary hard drive or an external USB drive.</p> <p>By default, the <b>BIOS Recovery from Hard Drive</b> option is enabled.</p> <p><b>i</b> <b>NOTE:</b> BIOS Recovery from Hard Drive is not available for self-encrypting drives (SED).</p> <p><b>i</b> <b>NOTE:</b> BIOS recovery is designed to fix the main BIOS block and cannot work if the Boot Block is damaged. In addition, this feature cannot work in the event of EC corruption, ME corruption, or a hardware issue. The recovery image must exist on an unencrypted partition on the drive.</p> <p><b>i</b> <b>NOTE:</b> To view this option, enable <b>Advanced Setup</b> mode as described in <a href="#">View Advanced Setup options</a>.</p> |
| <b>BIOS Downgrade</b>                |  |
| Allow BIOS Downgrade                 | <p>Allows downgrading of the system firmware to previous revisions.</p> <p>By default, the <b>Allow BIOS Downgrade</b> option is enabled.</p>  |
| <b>SupportAssist OS Recovery</b>     | <p>Enables or disables the boot flow for SupportAssist OS Recovery tool if certain system errors occur.</p> <p>By default, the <b>SupportAssist OS Recovery</b> option is enabled.</p>   |

**Table 58. System Setup options—Update, Recovery menu (continued)**

| Update, Recovery                       |  |
|--|--|
| <b>BIOSConnect</b>                     | <p>Enables or disables cloud service operating system recovery if the main operating system fails to boot with the number of failures equal to or greater than the value specified by the Auto OS Recovery Threshold setup option and local service operating system does not boot or is not installed.</p> <p>By default, the <b>BIOSConnect</b> option is enabled.</p> |
| <b>Dell Auto OS Recovery Threshold</b> | <p>Allows the control of the automatic boot flow for the SupportAssist System Resolution Console and the Dell OS Recovery Tool.</p> <p>By default, the <b>Dell Auto OS Recovery Threshold</b> value is set to <b>2</b>.</p> <p><b>NOTE:</b> To view this option, enable <b>Advanced Setup</b> mode as described in <a href="#">View Advanced Setup options</a>.</p>      |

**Table 59. System Setup options—System Management menu**

| System Management           |   |
|-----------------------------|---|
| <b>Service Tag</b>          | <p>Displays the Service Tag of the computer.</p>  |
| <b>Asset Tag</b>            | <p>Creates a computer Asset Tag that an IT administrator can use to uniquely identify a particular computer.</p> <p><b>NOTE:</b> Once set in the BIOS, the Asset Tag cannot be changed.</p>   |
| <b>AC Behavior</b>          |   |
| <b>Wake on AC</b>           | <p>Enables or disables the computer to turn on and go to boot when AC power is supplied to the computer.</p> <p>By default, the <b>Wake on AC</b> option is disabled.</p> <p><b>NOTE:</b> To view this option, enable <b>Advanced Setup</b> mode as described in <a href="#">View Advanced Setup options</a>.</p>   |
| <b>Wake on LAN</b>          | <p>Enables or disables the computer to turn on by a special LAN signal.</p> <p>By default, the <b>Wake on LAN</b> option is disabled.</p> <p><b>NOTE:</b> To view this option, enable <b>Advanced Setup</b> mode as described in <a href="#">View Advanced Setup options</a>.</p>   |
| <b>Auto On Time</b>         | <p>Enable to set the computer to turn on automatically every day or on a preselected date and time. This option can be configured only if the Auto On Time is set to Everyday, Weekdays, or Selected Days.</p> <p>By default, the <b>Auto On Time</b> option is disabled.</p> <p><b>NOTE:</b> To view this option, enable <b>Advanced Setup</b> mode as described in <a href="#">View Advanced Setup options</a>.</p> |
| <b>Intel AMT capability</b> | <p>Configure Intel Active Management Technology (AMT) options, which can be enabled, disabled, or restricted.</p> <p><b>NOTE:</b> To view this option, enable <b>Advanced Setup</b> mode as described in <a href="#">View Advanced Setup options</a>.</p>   |
| <b>First Power On Date</b>  |   |
| <b>Set Ownership Date</b>   | <p>This options allows to set the Ownership date.</p> <p>By default, the <b>Set Ownership Date</b> option is OFF.</p> <p><b>NOTE:</b> To view this option, enable <b>Advanced Setup</b> mode as described in <a href="#">View Advanced Setup options</a>.</p>   |
| <b>Diagnostics</b>          |   |

**Table 59. System Setup options—System Management menu (continued)**

| System Management                            |  |
|--|--|
| <b>OS agent requests</b>                     | <p>Enable or disable the option for applications running in the operating system to run with preboot diagnostics on subsequent boots.</p> <p><b>i</b> <b>NOTE:</b> To view this option, enable <b>Advanced Setup</b> mode as described in <a href="#">View Advanced Setup options</a>.</p>   |
| <b>Power-On-Self-Test Automatic Recovery</b> | <p>Enable or disable the automatic recovery of the computer from no power or no-POST failure by applying mitigation steps.</p> <p>By default, the <b>Power-On-Self-Test Automatic Recovery</b> option is enabled.</p> <p><b>i</b> <b>NOTE:</b> To view this option, enable <b>Advanced Setup</b> mode as described in <a href="#">View Advanced Setup options</a>.</p> |

**Table 60. System Setup options—Keyboard menu**

| Keyboard                                  |  |
|---|--|
| <b>Fn Lock Options</b>                    | <p>Enables or disables the Fn Lock option.</p> <p>By default, the <b>Fn Lock</b> option is enabled.</p>  |
| <b>Lock Mode</b>                          | <p>By default, the <b>Lock Mode Secondary</b> option is enabled. With this option, the F1-F12 keys scan the code for their secondary functions.</p>  |
| <b>Device Configuration HotKey Access</b> | <p>Allows you to control whether you can access device configuration screens through hotkeys during system startup.</p> <p>By default, the <b>Device Configuration HotKey Access</b> option is enabled.</p> <p><b>i</b> <b>NOTE:</b> This setting controls only the Intel RAID (CTRL+I), MEBX (CTRL+P), and LSI RAID (CTRL+C) Option ROMs. Other preboot Option ROMs, which support entry using a key sequence, are not affected by this setting.</p> <p><b>i</b> <b>NOTE:</b> To view this option, enable <b>Advanced Setup</b> mode as described in <a href="#">View Advanced Setup options</a>.</p> |

**Table 61. System Setup options—Pre-boot Behavior menu**

| Pre-boot Behavior            |  |
|------------------------------|--|
| <b>Adapter Warnings</b>      |  |
| Enable Dock Warning Messages | <p>Enables the warning messages during boot when the adapters with less power capacity are detected.</p> <p>By default, the <b>Enable Dock Warning Messages</b> option is enabled.</p> <p><b>i</b> <b>NOTE:</b> To view this option, enable <b>Advanced Setup</b> mode as described in <a href="#">View Advanced Setup options</a>.</p>  |
| <b>Warnings and Errors</b>   | <p>Enables or disables the action to be taken when a warning or error is encountered.</p> <p>By default, the <b>Prompt on Warnings and Errors</b> option is selected.</p> <p><b>i</b> <b>NOTE:</b> Errors deemed critical to the operation of the computer hardware stop the functioning of the computer.</p> <p><b>i</b> <b>NOTE:</b> To view this option, enable <b>Advanced Setup</b> mode as described in <a href="#">View Advanced Setup options</a>.</p> |
| <b>USB-C Warnings</b>        |  |
| Enable Dock Warning Messages | <p>Enables the warning messages during boot when the USB-C adapters with less power capacity are detected.</p> <p>By default, the <b>Enable Dock Warning Messages</b> option is enabled.</p>   |

**Table 61. System Setup options—Pre-boot Behavior menu (continued)**

| Pre-boot Behavior               |   |
|---------------------------------|---|
|                                 | <p><b>i</b> <b>NOTE:</b> To view this option, enable <b>Advanced Setup</b> mode as described in <a href="#">View Advanced Setup options</a>.</p>  |
| <b>Fastboot</b>                 | <p>Configure the speed of the UEFI boot process.</p> <p>By default, the <b>Thorough</b> option is selected. Performs complete hardware and configuration initialization during boot.</p> <p><b>i</b> <b>NOTE:</b> To view this option, enable <b>Advanced Setup</b> mode as described in <a href="#">View Advanced Setup options</a>.</p> |
| <b>Extend BIOS POST Time</b>    | <p>Sets the BIOS POST (Power-On Self-Test) load time.</p> <p>By default, the <b>0 seconds</b> option is selected.</p> <p><b>i</b> <b>NOTE:</b> To view this option, enable <b>Advanced Setup</b> mode as described in <a href="#">View Advanced Setup options</a>.</p>  |
| <b>MAC Address Pass-Through</b> | <p>Replaces the external NIC MAC address (in a supported dock or dongle) with the selected MAC address from the computer.</p> <p>By default, the <b>System Unique MAC Address</b> option is selected.</p>   |

**Table 62. System Setup options—Virtualization menu**

| Virtualization Support                          |   |
|---|---|
| <b>Intel Virtualization Technology</b>          |   |
| Enable Intel Virtualization Technology (VT)     | <p>When enabled, the computer can run a Virtual Machine Monitor (VMM).</p> <p>By default, the <b>Enable Intel Virtualization Technology (VT)</b> option is enabled.</p> <p><b>i</b> <b>NOTE:</b> To view this option, enable <b>Advanced Setup</b> mode as described in <a href="#">View Advanced Setup options</a>.</p>  |
| <b>VT for Direct I/O</b>                        |   |
| Enable Intel VT for Direct I/O                  | <p>When enabled, the computer can perform Virtualization Technology for Direct I/O (VT-d). VT-d is an Intel method that provides virtualization for memory map I/O.</p> <p>By default, the <b>Enable Intel VT for Direct I/O</b> option is enabled.</p> <p><b>i</b> <b>NOTE:</b> To view this option, enable <b>Advanced Setup</b> mode as described in <a href="#">View Advanced Setup options</a>.</p>  |
| <b>Intel Trusted Execution Technology (TXT)</b> | <p>Specifies whether a measured Virtual Machine Monitor (MVMM) can use the additional hardware capabilities provided by Intel Trusted Execution Technology. The following must be enabled in order to enable Intel TXT -</p> <ul style="list-style-type: none"> <li>● Trusted Platform Module (TPM)</li> <li>● Intel Hyper-Threading</li> <li>● All CPU cores (Multi-Core Support)</li> <li>● Intel Virtualization Technology</li> <li>● Intel VT for Direct I/O</li> </ul> <p>By default, the <b>Intel Trusted Execution Technology (TXT)</b> option is disabled.</p> <p><b>i</b> <b>NOTE:</b> To view this option, enable <b>Advanced Setup</b> mode as described in <a href="#">View Advanced Setup options</a>.</p> |
| <b>DMA Protection</b>                           |   |
| Enable Pre-Boot DMA Support                     | <p>Allows you to control the Pre-Boot DMA protection for both internal and external ports. This option does not directly enable DMA protection in the operating system.</p>   |

**Table 62. System Setup options—Virtualization menu (continued)**

| Virtualization Support       |   |
|------------------------------|---|
|                              | <p><b>i</b> <b>NOTE:</b> This option is not available when the virtualization setting for IOMMU is disabled (VT-d/AMD Vi).</p> <p>By default, the <b>Enable Pre-Boot DMA Support</b> option is enabled.</p> <p>For additional security, Dell Technologies recommends keeping the <b>Enable Pre-Boot DMA Support</b> option enabled.</p> <p><b>i</b> <b>NOTE:</b> This option is provided only for compatibility purposes, since some older hardware is not DMA capable.</p> <p><b>i</b> <b>NOTE:</b> To view this option, enable <b>Advanced Setup</b> mode as described in <a href="#">View Advanced Setup options</a>.</p>  |
| Enable OS Kernel DMA Support | <p>Allows you to control the Kernel DMA protection for both internal and external ports. This option does not directly enable DMA protection in the operating system. For operating systems that support DMA protection, this setting indicates to the operating system that the BIOS supports the feature.</p> <p><b>i</b> <b>NOTE:</b> This option is not available when the virtualization setting for IOMMU is disabled (VT-d/AMD Vi).</p> <p>By default, the <b>Enable OS Kernel DMA Support</b> option is enabled.</p> <p><b>i</b> <b>NOTE:</b> This option is provided only for compatibility purposes, since some older hardware is not DMA capable.</p> <p><b>i</b> <b>NOTE:</b> To view this option, enable <b>Advanced Setup</b> mode as described in <a href="#">View Advanced Setup options</a>.</p> |

**Table 63. System Setup options—Performance menu**

| Performance                       |   |
|-----------------------------------|---|
| Multi-Core Support                |   |
| Multiple Atom Cores               | <p>Allows to change the number of Atom cores available to the operating system. The default value is set to the maximum number of cores.</p> <p>By default, the <b>All Cores</b> option is selected.</p> <p><b>i</b> <b>NOTE:</b> To view this option, enable <b>Advanced Setup</b> mode as described in <a href="#">View Advanced Setup options</a>.</p>   |
| Intel SpeedStep                   |   |
| Enable Intel SpeedStep Technology | <p>Enables the computer to dynamically adjust processor voltage and core frequency, decreasing average power consumption and heat production.</p> <p>By default, the <b>Enable Intel SpeedStep Technology</b> option is enabled.</p> <p><b>i</b> <b>NOTE:</b> To view this option, enable <b>Service</b> options as described in <a href="#">View Service options</a>.</p>  |
| C-State Control                   |   |
| Enable C-State Control            | <p>Enables or disables the ability of the CPU to enter and exit low-power state. When disabled, it disables all C-states. When enabled, it enables all C-states that the chipset or platform allows.</p> <p>By default, the <b>Enable C-State Control</b> option is enabled.</p> <p><b>i</b> <b>NOTE:</b> To view this option, enable <b>Advanced Setup</b> mode as described in <a href="#">View Advanced Setup options</a>.</p> |
| Intel Turbo Boost Technology      |   |

**Table 63. System Setup options—Performance menu (continued)**

| Performance                             |   |
|---|---|
| Enable Intel Turbo Boost Technology     | <p>Enables or disables the Intel TurboBoost mode of the processor. When enabled, the Intel TurboBoost driver increases the performance of the CPU or graphics processor.</p> <p>By default, the <b>Enable Intel Turbo Boost Technology</b> option is enabled.</p> <p><b>NOTE:</b> To view this option, enable <b>Advanced Setup</b> mode as described in <a href="#">View Advanced Setup options</a>.</p>                                 |
| Intel Hyper-Threading Technology        |   |
| Enable Intel Hyper-Threading Technology | <p>Enables or disables the Intel Hyper-Threading mode of the processor. When enabled, the Intel Hyper-Threading increases the efficiency of the processor resources when multiple threads run on each core.</p> <p>By default, the <b>Intel Hyper-Threading Technology</b> option is enabled.</p> <p><b>NOTE:</b> To view this option, enable <b>Advanced Setup</b> mode as described in <a href="#">View Advanced Setup options</a>.</p> |

**Table 64. System Setup options—System Logs menu**

| System Logs             |   |
|-------------------------|---|
| BIOS Event Log          |   |
| Clear BIOS Event Log    | <p>Select the option to keep or clear BIOS events logs.</p> <p>By default, the <b>Keep Log</b> option is selected.</p> <p><b>NOTE:</b> To view this option, enable <b>Advanced Setup</b> mode as described in <a href="#">View Advanced Setup options</a>.</p>    |
| Thermal Event Log       |   |
| Clear Thermal Event Log | <p>Select the option to keep or clear thermal events logs.</p> <p>By default, the <b>Keep Log</b> option is selected.</p> <p><b>NOTE:</b> To view this option, enable <b>Advanced Setup</b> mode as described in <a href="#">View Advanced Setup options</a>.</p> |
| Power Event Log         |   |
| Clear Power Event Log   | <p>Select the option to keep or clear power events logs.</p> <p>By default, the <b>Keep Log</b> option is selected.</p> <p><b>NOTE:</b> To view this option, enable <b>Advanced Setup</b> mode as described in <a href="#">View Advanced Setup options</a>.</p>   |

## Updating the BIOS

### Updating the BIOS in Windows

#### About this task

**CAUTION:** If BitLocker is not suspended before updating the BIOS, the next time you reboot the computer it will not recognize the BitLocker key. You will then be prompted to enter the recovery key to progress, and the computer will ask for this on each reboot. If the recovery key is not known this can result in data loss or an unnecessary operating system reinstall. For more information about this subject, search in the Knowledge Base Resource at [Dell Support Site](#).

## Steps

1. Go to [Dell Support Site](#).
2. Click **Product support**. In the **Search support** box, enter the Service Tag of your computer, and then click **Search**.  
 **NOTE:** If you do not have the Service Tag, use the SupportAssist to automatically identify your computer. You can also use the product ID or manually browse for your computer model.
3. Click **Drivers & Downloads**. Expand **Find drivers**.
4. Select the operating system installed on your computer.
5. In the **Category** drop-down list, select **BIOS**.
6. Select the latest version of BIOS, and click **Download** to download the BIOS file for your computer.
7. After the download is complete, browse the folder where you saved the BIOS update file.
8. Double-click the BIOS update file icon and follow the on-screen instructions.  
For more information, search in the Knowledge Base Resource at [Dell Support Site](#).

## Updating the BIOS using the USB drive in Windows

### About this task

 **CAUTION:** If BitLocker is not suspended before updating the BIOS, the next time you reboot the computer it will not recognize the BitLocker key. You will then be prompted to enter the recovery key to progress, and the computer will ask for this on each reboot. If the recovery key is not known this can result in data loss or an unnecessary operating system reinstall. For more information about this subject, search in the Knowledge Base Resource at [Dell Support Site](#).

## Steps

1. Follow the procedure from step 1 to step 6 in [Updating the BIOS in Windows](#) to download the latest BIOS setup program file.
2. Create a bootable USB drive. For more information, search in the Knowledge Base Resource at [Dell Support Site](#).
3. Copy the BIOS setup program file to the bootable USB drive.
4. Connect the bootable USB drive to the computer that needs the BIOS update.
5. Restart the computer and press **F12**.
6. Select the USB drive from the **One Time Boot Menu**.
7. Type the BIOS setup program filename and press **Enter**.  
The **BIOS Update Utility** appears.
8. Follow the on-screen instructions to complete the BIOS update.

## Updating the BIOS from the One-Time boot menu

Update your computer BIOS using the BIOS XXXX.exe file that is copied to a FAT32 USB drive and booting from the One-Time boot menu.

### About this task

 **CAUTION:** If BitLocker is not suspended before updating the BIOS, the next time you reboot the computer it will not recognize the BitLocker key. You will then be prompted to enter the recovery key to progress, and the computer will ask for this on each reboot. If the recovery key is not known this can result in data loss or an unnecessary operating system reinstall. For more information about this subject, search in the Knowledge Base Resource at [Dell Support Site](#).

### BIOS Update

You can run the BIOS flash update file from Windows using a bootable USB drive or you can also update the BIOS from the One-Time boot menu on the computer.

You can confirm by booting your computer to the **One Time Boot** Menu to see if BIOS FLASH UPDATE is listed as a boot option. If the option is listed, then the BIOS can be updated using this method.

## Updating from the One-Time boot menu

To update your BIOS from the One-Time boot menu, you need the following:

- USB drive formatted to the FAT32 file system (the drive does not have to be bootable)
- BIOS executable file that you downloaded from the Dell Support website and copied to the root of the USB drive
- AC power adapter must be connected to the computer
- Functional computer battery to flash the BIOS

Perform the following steps to perform the BIOS flash update process from the One-Time boot menu:

 **CAUTION: Do not turn off the computer during the BIOS flash update process. The computer may not boot if you turn off your computer.**

### Steps

1. Turn off your computer, insert the USB drive where you copied the BIOS flash update file into a USB port of the computer.
2. Turn on the computer and press to access the **One Time Boot** Menu. Select BIOS Update using the mouse or arrow keys then press Enter.  
The flash BIOS menu is displayed.
3. Click **Flash from file**.
4. Select the external USB device.
5. Select the file and double-click the flash target file, and then click **Submit**.
6. Click **Update BIOS**. The computer restarts to flash the BIOS.
7. The computer will restart after the BIOS flash update is completed.

## System and setup password

Table 65. System and setup password

| Password type   | Description  |
|-----------------|--|
| System password | Password that you must enter to log in to your system.   |
| Setup password  | Password that you must enter to access and make changes to the BIOS settings of your computer. |

You can create a system password and a setup password to secure your computer.

 **CAUTION: The password features provide a basic level of security for the data on your computer.**

 **CAUTION: Anyone can access the data that is stored on your computer, when left unattended.**

 **NOTE:** System and setup password feature is disabled.

## Assigning a System Setup password

### Prerequisites

You can assign a new System or Admin Password only when the status is in **Not Set**.

### About this task

To enter BIOS System Setup, press F2 immediately after a power-on or reboot.

### Steps

1. In the **System BIOS** or **System Setup** screen, select **Security** and press Enter.  
The **Security** screen is displayed.
2. Select **System/Admin Password** and create a password in the **Enter the new password** field.  
Use the following guidelines to assign the system password:

- A password can have up to 32 characters.
  - At least one special character: "( ! " # \$ % & ' \* + , - . / : ; < = > ? @ [ \ ] ^ \_ ` { | } )"
  - Numbers 0 to 9.
  - Upper case letters from A to Z.
  - Lower case letters from a to z.
3. **Confirm new password** type the system password that you entered earlier in the field and click **OK**.
  4. Press Esc and save the changes as prompted by the message.
  5. Press Y to save the changes.  
The computer restarts.

## Deleting or changing an existing system password or setup password

### Prerequisites

Ensure that the **Password Status** is Unlocked (in the System Setup) before attempting to delete or change the existing system password and/or setup password. You cannot delete or change an existing system password or setup password if the **Password Status** is Locked.

### About this task

To enter the System Setup, press F2 immediately after a power-on or reboot.

### Steps

1. In the **System BIOS** or **System Setup** screen, select **System Security** and press Enter.  
The **System Security** screen is displayed.
2. In the **System Security** screen, verify that the **Password Status** is Unlocked.
3. Select **System Password**. Update or delete the existing system password, and press Enter or Tab.
4. Select **Setup Password**. Update or delete the existing setup password, and press Enter or Tab.
  -  **NOTE:** If you change the system password and/or setup password, reenter the new password when prompted. If you delete the system password and/or setup password, confirm the deletion when prompted.
5. Press Esc. A message prompts you to save the changes.
6. Press Y to save the changes and exit from **System Setup**.  
The computer restarts.

## Clearing CMOS settings

### About this task

 **CAUTION:** Clearing CMOS settings resets the BIOS settings on your computer.

### Steps

1. Remove the [base cover](#).
2. Disconnect the battery cable from the system board.
3. Remove the [coin-cell battery](#).
4. Wait for one minute.
5. Replace the [coin-cell battery](#).
6. Connect the battery cable to the system board.
7. Replace the [base cover](#).

# Clearing BIOS (System Setup) and System passwords

## About this task

To clear the computer or BIOS passwords, contact Dell technical support as described at [Contact Support](#). For more information, go to [Dell Support Site](#).

 **NOTE:** For information about how to reset Windows or application passwords, see the documentation accompanying Windows or your application.

# Troubleshooting

## Handling swollen rechargeable Li-ion batteries

Like most laptops, Dell laptops use Lithium-ion batteries. One type of Lithium-ion battery is the rechargeable Li-ion battery. Rechargeable Li-ion batteries have increased in popularity in recent years and have become a standard in the electronics industry due to customer preferences for a slim form factor (especially with newer ultra-thin laptops) and long battery life. Inherent to rechargeable Li-ion battery technology is the potential for swelling of the battery cells.

A swollen battery may impact the performance of the laptop. To prevent possible further damage to the device enclosure or internal components leading to malfunction, discontinue the use of the laptop and discharge it by disconnecting the AC adapter and letting the battery drain.

Swollen batteries should not be used and must be replaced and disposed of properly. We recommend contacting Dell Support for options to replace a swollen battery under the terms of the applicable warranty or service contract, including options for replacement by a Dell authorized service technician.

The guidelines for handling and replacing rechargeable Li-ion batteries are as follows:

- Exercise caution when handling rechargeable Li-ion batteries.
- Discharge the battery before removing it from the computer. To discharge the battery, unplug the AC adapter from the computer and operate the computer only on battery power. The battery is fully discharged when the computer no longer turns on when the power button is pressed.
- Do not crush, drop, mutilate, or penetrate the battery with foreign objects.
- Do not expose the battery to high temperatures, or disassemble battery packs and cells.
- Do not apply pressure to the surface of the battery.
- Do not bend the battery.
- Do not use tools of any type to pry on or against the battery.
- If a battery gets stuck in a device as a result of swelling, do not try to free it as puncturing, bending, or crushing a battery can be dangerous.
- Do not attempt to reassemble a damaged or swollen battery into a laptop.
- Swollen batteries that are covered under warranty should be returned to Dell in an approved shipping container (provided by Dell)—this is to comply with transportation regulations. Swollen batteries that are not covered under warranty should be disposed of at an approved recycling center. Contact Dell Support at [Dell Support Site](#) for assistance and further instructions.
- Using a non-Dell or incompatible battery may increase the risk of fire or explosion. Replace the battery only with a compatible battery purchased from Dell that is designed to work with your Dell computer. Do not use a battery from other computers with your computer. Always purchase genuine batteries from [Dell Site](#) or otherwise directly from Dell.

Rechargeable Li-ion batteries can swell for various reasons such as age, number of charge cycles, or exposure to high heat. For more information about how to improve the performance and lifespan of the laptop battery and to minimize the possibility of occurrence of the issue, search Dell laptop battery in the Knowledge Base Resource at [Dell Support Site](#).

## Locating the Service Tag or Express Service Code of your Dell computer

Your Dell computer is uniquely identified with a Service Tag or Express Service Code. To view relevant support resources for your Dell computer, we recommend entering the Service Tag or Express Service Code at [Dell Support Site](#).

For more information about how to find the Service Tag for your computer, see [Instructions on how to find your Service Tag or Serial Number](#).

# Dell SupportAssist Pre-boot System Performance Check diagnostics

## About this task

SupportAssist diagnostics (also known as system diagnostics) performs a complete check of your hardware. The Dell SupportAssist Pre-boot System Performance Check diagnostics is embedded with the BIOS and launched by the BIOS internally. The embedded system diagnostics provides options for particular devices or device groups allowing you to:

- Run tests automatically or in an interactive mode.
- Repeat the tests.
- Display or save test results.
- Run thorough tests to introduce additional test options to provide extra information about one or more failed devices.
- View status messages that inform you the tests are completed successfully.
- View error messages that inform you of problems encountered during testing.

 **NOTE:** Some tests for specific devices require user interaction. Always ensure that you are present at the computer when the diagnostic tests are performed.

For more information, see the knowledge base article [000180971](#).

## Running the SupportAssist Pre-Boot System Performance Check

### Steps

1. Turn on your computer.
2. As the computer boots, press the F12 key as the Dell logo appears.
3. On the boot menu screen, select the **Diagnostics** option.
4. Click the arrow at the bottom left corner.  
Diagnostics page is displayed.
5. Click the arrow in the lower-right corner to go to the page listing.  
The items that are detected are listed.
6. To run a diagnostic test on a specific device, press Esc and click **Yes** to stop the diagnostic test.
7. Select the device from the left pane and click **Run Tests**.
8. If there are any issues, error codes are displayed.  
Note the error code and validation number and contact Dell.

## Built-in self-test (BIST)

### M-BIST

M-BIST (Built In Self-Test) is the system board built-in self-test diagnostics tool that improves the diagnostics accuracy of system board Embedded Controller (EC) failures.

 **NOTE:** M-BIST can be manually initiated before Power On Self-Test (POST).

### How to run M-BIST

 **NOTE:** Before initiating M-BIST, ensure that the computer is in a power-off state.

1. Press and hold both the **M** key on the keyboard and the power button to initiate M-BIST.
2. The battery indicator LED may exhibit two states:
  - a. OFF: No fault was detected with the system board.
  - b. AMBER: Amber indicates a problem with the system board.
3. If there is a failure with the system board, the battery status LED flashes one of the following error codes for 30 seconds:

**Table 66. LED error codes**

| Blinking Pattern |       | Possible Problem       |
|------------------|-------|------------------------|
| Amber            | Green |                        |
| 2                | 1     | CPU Failure            |
| 2                | 8     | LCD Power Rail Failure |
| 1                | 1     | TPM Detection Failure  |
| 2                | 4     | Memory/RAM failure     |

4. If there is no failure with the system board, the LCD cycles through the solid color screens that are described in the LCD-BIST section for 30 seconds and then turn off.

## LCD Power rail test (L-BIST)

L-BIST is an enhancement to the single LED error code diagnostics and is automatically initiated during POST. L-BIST will check the LCD power rail. If there is no power being supplied to the LCD (that is if the L-BIST circuit fails), the battery status LED flashes either an error code [2,8] or an error code [2,7].

 **NOTE:** If L-BIST fails, LCD-BIST cannot function as no power will be supplied to the LCD.

### How to invoke the L-BIST

1. Turn on your computer computer.
2. If the computer does not start up normally, look at the battery status LED:
  - If the battery status LED flashes an error code [2,7], the display cable may not be connected properly.
  - If the battery status LED flashes an error code [2,8], there is a failure on the LCD power rail of the system board, hence there is no power that is supplied to the LCD.
3. For cases, when a [2,7] error code is shown, check to see if the display cable is properly connected.
4. For cases when a [2,8] error code is shown, replace the system board.

## LCD Built-in Self-Test (BIST)

Dell laptops have a built-in diagnostic tool that helps you determine if the screen abnormality you are experiencing is an inherent problem with the LCD (screen) of the Dell laptop or with the video card (GPU) and computer settings.

When you notice screen abnormalities like flickering, distortion, clarity issues, fuzzy or blurry image, horizontal or vertical lines, color fade and so on, it is always a good practice to isolate the LCD (screen) by running the Built-In Self-Test (BIST).

### How to invoke the LCD BIST

1. Turn off your computer.
2. Disconnect any peripherals that are connected to the computer. Connect only the AC adapter (charger) to the computer.
3. Ensure that the LCD (screen) is clean (no dust particles on the surface of the screen).
4. Press and hold the **D** key and press the power button to enter LCD built-in self-test (BIST) mode. Continue to hold the **D** key until the computer boots up.
5. The screen displays solid colors and change colors on the entire screen to white, black, red, green, and blue twice.
6. Then it displays the colors white, black, and red.
7. Carefully inspect the screen for abnormalities (any lines, fuzzy color, or distortion on the screen).
8. At the end of the last solid color (red), the computer shuts down.

 **NOTE:** Dell SupportAssist Preboot diagnostics upon launch initiates an LCD BIST first, expecting a user intervention to confirm functionality of the LCD.

# System-diagnostic lights

This section lists the system-diagnostic lights of your Dell Pro Rugged 13 RA13250.

The Service LED is used for system diagnostics, and it emits amber or green light. A Dell service representative uses the LED light patterns to troubleshoot your device.

The following table shows different Service LED light patterns and associated problems.

**Table 67. System-diagnostic lights**

| Blinking pattern |       | Problem description                                  |
|------------------|-------|--|
| Amber            | Green |  |
| 1                | 1     | TPM detection failure                                |
| 1                | 2     | Unrecoverable SPI flash failure                      |
| 1                | 3     | Short in hinge cable tripped OCP1                    |
| 1                | 4     | Short in hinge cable tripped OCP2                    |
| 1                | 5     | EC unable to program i-Fuse                          |
| 1                | 6     | EC internal failure                                  |
| 2                | 1     | Processor failure                                    |
| 2                | 2     | System board: BIOS or ROM (Read-Only Memory) failure |
| 2                | 3     | No memory or RAM (Random-Access Memory) detected     |
| 2                | 4     | Memory or RAM (Random-Access Memory) failure         |
| 2                | 5     | Invalid memory module installed                      |
| 2                | 6     | System-board or chipset error                        |
| 2                | 7     | Display failure - SBIOS message                      |
| 2                | 8     | Display failure - EC detection of power rail failure |
| 3                | 1     | CMOS battery failure                                 |
| 3                | 2     | PCI of video card/chip failure                       |
| 3                | 3     | BIOS recovery image not found                        |
| 3                | 4     | BIOS recovery image found but invalid                |
| 3                | 5     | Power-rail failure                                   |
| 3                | 6     | System BIOS Flash corruption.                        |
| 3                | 7     | Management Engine (ME) error                         |

**NOTE:** Blinking 3-3-3 LEDs on Lock LED (Caps-Lock or Num Lock), Power button LED (without Fingerprint reader), and Diagnostic LED indicates failure to provide input during LCD panel test on Dell SupportAssist Preboot System Performance Check diagnostics.

## Recovering the operating system

When your computer is unable to boot to the operating system even after repeated attempts, it automatically starts Dell SupportAssist OS Recovery.

Dell SupportAssist OS Recovery is a stand-alone tool that is preinstalled in Dell computers running Windows operating system. It consists of tools to diagnose and troubleshoot issues that may occur before your computer boots to the operating system. It enables you to diagnose hardware issues, repair your computer, back up your files, or restore your computer to its factory state.

You can also download it from the Dell Support website to troubleshoot and fix your computer when it fails to boot into the primary operating system due to software or hardware failures.

For more information about the Dell SupportAssist OS Recovery, see *Dell SupportAssist OS Recovery User's Guide* at [Serviceability Tools at the Dell Support Site](#). Click **SupportAssist** and then, click **SupportAssist OS Recovery**.

## Real-Time Clock (RTC Reset)

The Real-Time Clock (RTC) reset function enables you or the service technician to recover Dell computers from No POST/No Power/No Boot situations. The legacy jumper enabled RTC reset has been retired on these models.

Start the RTC reset with the computer powered off and connected to AC power. Press and hold the power button for twenty seconds . The computer RTC Reset occurs after you release the power button.

## Backup media and recovery options

It is recommended to create a recovery drive to troubleshoot and fix problems that may occur with Windows. Dell provides multiple options for recovering the Windows operating system on your Dell computer. For more information, see [Dell Windows Backup Media and Recovery Options](#).

## Wi-Fi power cycle

### About this task

If your computer is unable to access the Internet due to Wi-Fi connectivity issues, reset your Wi-Fi device by performing the following steps:

### Steps

1. Turn off the computer.
2. Turn off the modem.

 **NOTE:** Some Internet service providers (ISPs) provide a modem and router combo device.

3. Turn off the wireless router.
4. Wait for 30 seconds.
5. Turn on the wireless router.
6. Turn on the modem.
7. Turn on the computer.

## Drain flea power (perform hard reset)

### About this task

Flea power is the residual static electricity that remains in the computer even after it has been powered off and the battery is removed.

For your safety, and to protect the sensitive electronic components in your computer, you must drain residual flea power before removing or replacing any components in your computer.

Draining flea power, also known as a performing a "hard reset," is also a common troubleshooting step if your computer does not turn on or boot into the operating system.

Perform the following steps to drain the flea power:

## Steps

1. Turn off the computer.
2. Disconnect the power adapter from the computer.
3. Remove the base cover.
4. Remove the battery.
5. Press and hold the power button for 20 seconds to drain the flea power.
6. Install the battery.
7. Install the base cover.
8. Connect the power adapter to the computer.
9. Turn on the computer.

 **NOTE:** For more information about performing a hard reset, go to [Dell Support Site](#). On the menu bar at the top of the Support page, select Support > Support Library. In the Search field on the Support Library page, type the keyword, topic, or model number, and then click or tap the search icon to view the related articles.

# Getting help and contacting Dell

## Self-help resources

You can get information and help on Dell products and services using these self-help resources:

**Table 68. Self-help resources**

| Self-help resources  | Resource location  |
|--|--|
| Information about Dell products and services   | <a href="#">Dell Site</a>  |
| Tips   |   |
| Contact Support  | In Windows search, type <code>Contact Support</code> , and press Enter.  |
| Online help for operating system   | <a href="#">Windows Support Site</a>   |
| Access top solutions, diagnostics, drivers and downloads, and learn more about your computer through videos, manuals, and documents. | Your Dell computer is uniquely identified by a Service Tag or Express Service Code. To view relevant support resources for your Dell computer, enter the Service Tag or Express Service Code at <a href="#">Dell Support Site</a> .<br><br>For more information about how to find the Service Tag for your computer, see <a href="#">Instructions on how to find your Service Tag or Serial Number</a> . |
| Dell knowledge base articles   | <ol style="list-style-type: none"> <li>1. Go to <a href="#">Dell Support Site</a>.</li> <li>2. On the menu bar at the top of the Support page, select <b>Support &gt; Support Library</b>.</li> <li>3. In the Search field on the Support Library page, type the keyword, topic, or model number, and then click or tap the search icon to view the related articles.</li> </ol>                         |

## Contacting Dell

To contact Dell for sales, technical support, or customer service issues, see [Contact Support at Dell Support Site](#).

 **NOTE:** Availability of the services may vary depending on the country or region, and product.

 **NOTE:** If you do not have an active Internet connection, you can find contact information about your purchase invoice, packing slip, bill, or Dell product catalog.