



Interactive Flat Panel

User Manual

RE6504/RE7504/RE8604/RE6504F/RE7504F/RE8604F/
RE6504FV/RE7504FV/RE8604FV/RE9804FV

V 1.02

Copyright and disclaimer

Disclaimer

BenQ Corporation makes no representations or warranties, either expressed or implied, with respect to the contents of this document. BenQ Corporation reserves the right to revise this publication and to make changes from time to time in the contents thereof without obligation to notify any person of such revision or changes.

HDMI trademark disclaimer

The terms HDMI, HDMI High-Definition Multimedia Interface, HDMI Trade Dress and the HDMI Logos are trademarks or registered trademarks of HDMI Licensing Administrator, Inc.



Copyright

Copyright 2024 BenQ Corporation. All rights reserved. No part of this publication may be reproduced, transmitted, transcribed, stored in a retrieval system or translated into any language or computer language, in any form or by any means, electronic, mechanical, magnetic, optical, chemical, manual or otherwise, without the prior written permission of BenQ Corporation.

Product Support

This document aims to provide the most updated and accurate information to customers, and thus all contents may be modified from time to time without prior notice. Please visit the website for the latest version of this document and other product information. Available files vary by model.



- Make sure your computer is connected to the Internet.
- Visit the local website from www.BenQ.com. The website layout and content may vary by region/country.
- User manual and related document: www.BenQ.com > Business > SUPPORT > Downloads > model name > User Manual
- (EU only) Dismantled information: Available on the user manual download page. This document is provided based on Regulation (EU) 2019/2021 to repair or recycle your product. Always contact the local customer service for servicing within the warranty period. If you wish to repair an out-of-warranty product, you are recommended to go to a qualified service personnel and obtain repair parts from BenQ to ensure compatibility. Do not disassemble the product unless you are aware of the consequences. If you cannot find the dismantled information on your product, contact the local customer service for assistance.

Table of contents

| | |
|--|----|
| Copyright and disclaimer | i |
| Product Support..... | ii |
| Safety warnings and precautions | 1 |
| Important safety instructions | 2 |
| Notes on this display..... | 2 |
| Notes on the LCD panel of this display..... | 2 |
| Notes on cleaning the display..... | 3 |
| Safety notice for remote control..... | 3 |
| Battery safety notice..... | 3 |
| BenQ ecoFACTS | 3 |
| Package contents..... | 5 |
| Set up the display | 6 |
| Install the display on a wall..... | 6 |
| Install external PC..... | 7 |
| Parts of the display and their functions | 8 |
| Front panel..... | 8 |
| Rear panel | 10 |
| Remote control | 12 |
| Connections | 15 |
| Connect power | 15 |
| Turn the display on or off | 15 |
| Connect the touch module..... | 16 |
| Connect the VGA input..... | 17 |
| Connect the digital inputs | 17 |
| Connect the video output..... | 18 |
| Connect to serial port | 18 |
| Initial setup | 19 |
| Enable AMS service | 19 |
| Log in to BenQ Board..... | 20 |
| BenQ service interface | 20 |
| Set up the Internet connection..... | 22 |
| System update..... | 26 |
| Google system interface..... | 27 |
| Menu operations | 28 |
| Connection settings..... | 28 |
| Display settings | 30 |

| | |
|--|-----------|
| Audio settings..... | 32 |
| Advanced settings | 33 |
| Floating tool..... | 35 |
| Apps..... | 36 |
| Supported media formats | 37 |
| Product information..... | 39 |
| Specifications..... | 39 |
| Dimensions (RE6504) | 43 |
| Dimensions (RE7504)..... | 44 |
| Dimensions (RE8604) | 45 |
| Dimensions (RE6504F)..... | 46 |
| Dimensions (RE7504F) | 47 |
| Dimensions (RE8604F)..... | 48 |
| Dimensions (RE6504FV)..... | 49 |
| Dimensions (RE7504FV) | 50 |
| Dimensions (RE8604FV)..... | 51 |
| Dimensions (RE9804FV)..... | 52 |
| Supported input signal resolution..... | 53 |
| Troubleshooting | 54 |

Safety warnings and precautions

| | |
|---|---|
|  <p>CAUTION RISK OF ELECTRIC SHOCK DO NOT OPEN</p> <p>CAUTION: TO REDUCE THE RISK OF ELECTRIC SHOCK, DO NOT REMOVE COVER (OR BACK). NO USER-SERVICEABLE PARTS INSIDE. REFER SERVICING TO QUALIFIED SERVICE PERSONNEL.</p> | <p>THIS EQUIPMENT MUST BE GROUNDED</p> <p>To ensure safe operation, the three-pin plug must be inserted only into a standard three-pin power outlet which is effectively grounded through normal household wiring. Extension cords used with the equipment must have three cores and be correctly wired to provide connection to the ground. Wrongly wired extension cords are a major cause of fatalities.</p> <p>The fact that the equipment operates satisfactorily does not imply that the power outlet is grounded or that the installation is completely safe. For your safety, if you are in any doubt about the effective grounding of the power outlet, please consult a qualified electrician.</p> |
|  | <p>The lightning flash with arrowhead symbol, within an equilateral triangle, is intended to alert the user to the presence of uninsulated "dangerous voltage" within the product's enclosure that may be of sufficient magnitude to constitute a risk of electric shock to persons.</p> |
|  | <p>The exclamation point within an equilateral triangle is intended to alert the user to the presence of important operating and maintenance (servicing) instructions in the literature accompanying the appliance.</p> |

The mains plug of the power supply cord shall remain readily operable. The AC receptacle (mains socket outlet) shall be installed near the equipment and shall be easily accessible. To completely disconnect this equipment from the AC mains, disconnect the power cord plug from the AC receptacle.

- Do not place this display on an uneven, sloping or unstable surface (such as a trolley) where it may fall and cause damage to itself or others.
- Do not place this display near water, like a spa or pool, or in a position which will allow the splashing or spraying of water onto the display, like in front of an open window where rain water may enter.
- Do not install this display in a confined space without proper ventilation and air circulation, such as in a closed cabinet. Allow proper space around the display for dissipating heat inside. Do not block any openings and vents on the display. Overheating may result in hazards and electric shock.
- Installation of this display should only be performed by a qualified technician. Failure to install this display properly may cause injuries and damages to the personnels and the display itself. Check the installation regularly and maintain the display periodically to ensure the best working condition.
- Use only the accessories approved or recommended by the manufacturer to mount this display. Using wrong or unsuitable accessories may cause the display to fall and result in serious personal injuries. Make sure that the surface and fixing points are strong enough to sustain the weight of the display.
- To reduce the risk of electric shock, do not remove covers. No user serviceable parts inside. Refer servicing to qualified service personnel.
- To prevent personal injuries, mounting the display or installing desktop stands is required before use.

Important safety instructions

1. Do not use this apparatus near water.
2. Do not block any ventilation openings. Install in accordance with the manufacturer's instructions.
3. Do not install near any heat sources such as radiators, heat registers, stoves, or other apparatus (including amplifiers) that produce heat.
4. Do not defeat the safety purpose of the polarized or grounding-type plug. A polarized plug has two blades with one wider than the other. A grounding-type plug has two blades and a third grounding prong. The wide blade or the third prong are provided for your safety. If the provided plug does not fit into your outlet, consult an electrician for replacement of the obsolete outlet.
5. Protect the power cord from being walked on or pinched particularly at plugs, convenience receptacles, and the point where they exit from the apparatus.
6. Only use attachments/accessories specified by the manufacturer.
7. Use only with the cart, stand, tripod, bracket, or table specified by the manufacturer, or sold with the apparatus. When a cart is used, use caution when moving the cart/apparatus combination to avoid injury from tip-over. Unplug this apparatus during lightning storms or when unused for long periods of time.
8. Refer all servicing to qualified service personnel. Servicing is required when the apparatus has been damaged in any way, such as power-supply cord or plug is damaged, liquid has been spilled or objects have fallen into the apparatus, the apparatus has been exposed to rain or moisture, does not operate normally, or has been dropped.



Notes on this display

- To prevent the risk of physical injuries, do not attempt to lift the display alone.
- Make sure you have four or more people available to help lift or a flat cart to transport the display to its final location.
- Keep the display horizontal as much as possible.
- Clear a floor space before unpacking.

Notes on the LCD panel of this display

- The Liquid Crystal Display (LCD) panel of this display has a very thin protective layer of glass which is liable to marking or scratching, and cracking if struck or pressured. The liquid crystal substrate is also liable to damage under excessive force or extreme temperatures. Please handle with care.
- The response time and brightness of the LCD panel may vary with the ambient temperature.
- Avoid placing the display in direct sun or where direct sun or spot lighting will shine onto the LCD panel, as the heat may damage the panel and the external casing of the display, and the bright light will make viewing the display more difficult than necessary.
- The LCD panel consists of individual pixels to display images and is manufactured according to the design specifications. While 99.9% of these pixels work normally, 0.01% of the pixels may remain constantly lit (in red, blue or green) or unlit. This is a technical limitation of the LCD technology and is not a defect.
- LCD screens, like plasma (PDP) and conventional CRT (Cathode Ray Tube) screens, are also susceptible to 'screen burn-in' or 'image retention' which can be found on the screen as visible fixed lines and shades. To avoid such damage to the screen, avoid displaying still images (like On-Screen Display menus, TV station logos, fixed/inactive text or icons) for more than 30 minutes. Change the aspect ratio from time to time. Fill the entire screen with the image and eliminate the black bars whenever possible. Avoid displaying images in 16:9 aspect ratio over a long period of time, otherwise there may be visible burn marks on the screen as two vertical lines.

- Note: Under certain circumstances, condensation may occur on the inner side of the cover glass, it's a natural phenomenon and will not affect the operation of the display. This condensation will usually disappear after around 2 hours of normal operation.
- This product does not offer image retention function. For more information, please refer to installation guide. If a still image is required for a display, it is recommended to enable Pixel shift.
- This product does not support portrait use; portrait use may cause display damage. BenQ warranty will not cover faulty usage.

Notes on cleaning the display

Please clean the frame when there is sign of malfunction on the touch screen.

1. Before you clean the screen, make sure the display is turned off, and unplug the power cord.
2. Remove dust or dirt from the screen with a dry cleaning cloth. Make sure to use minimal force, and don't press hard on the screen.
 - Never use paper towels or anything that could leave streaks or lint on the screen.
3. Moisten a clean soft, lint-free cloth with some cleaning alcohol such as 70% isopropyl. Gently go over the entire screen and wipe it down.
 - Never use hazardous chemicals or ammonia-based cleaners
 - Never fully soak the microfiber cloths in liquid.
 - Never spray liquids directly onto the screen.

Safety notice for remote control

- Do not put the remote control in the direct heat, humidity, and avoid fire.
- Do not drop the remote control.
- Do not expose the remote control to water or moisture. Failure to do so could result in malfunction.
- Confirm there is no object between the remote control and the remote sensor of the product.
- When the remote control will not be used for an extended period, remove the batteries.

Battery safety notice

The use of the wrong type of batteries may cause chemical leaks or explosion. Please note the following:

- Always ensure that the batteries are inserted with the positive and negative terminals in the correct direction as shown in the battery compartment.
- Different types of batteries have different characteristics. Do not mix different types.
- Do not mix old and new batteries. Mixing old and new batteries will shorten battery life or cause chemical leaks from the old batteries.
- When batteries fail to function, replace them immediately.
- Chemicals which leak from batteries may cause skin irritation. If any chemical matter seeps out of the batteries, wipe it up immediately using a dry cloth, and replace the batteries as soon as possible.
- Due to varying storage conditions, the battery life for the batteries included with your product may be shortened. Replace them within 3 months or as soon as you can after initial use.
- There may be local restrictions on the disposal or recycling of batteries. Consult your local regulations or waste disposal provider.

BenQ ecoFACTS

BenQ has been dedicated to the design and development of greener product as part of its aspiration to realize the ideal of the "Bringing Enjoyment 'N Quality to Life" corporate vision with the ultimate goal to achieve a low-carbon society. Besides meeting international regulatory requirement and standards pertaining to environmental management, BenQ has spared no

efforts in pushing our initiatives further to incorporate life cycle design in the aspects of material selection, manufacturing, packaging, transportation, using and disposal of the products. BenQ ecoFACTS label lists key eco-friendly design highlights of each product, hoping to ensure that consumers make informed green choices at purchase. Check out BenQ's CSR Website at <http://csr.BenQ.com/> for more details on BenQ's environmental commitments and achievements.



Package contents

Open the sales package and check the contents. If any item is missing or damaged, please contact your dealer immediately.



LCD display

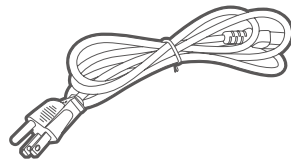

Power cord (by region)

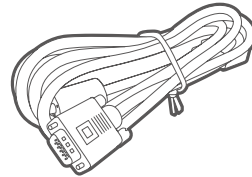

VGA cable x1



Remote control

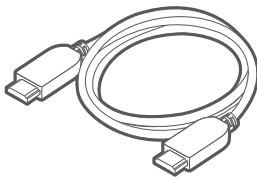

HDMI cable x1

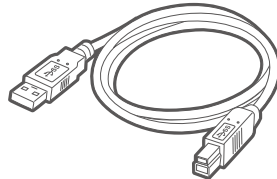

Touch USB cable x1

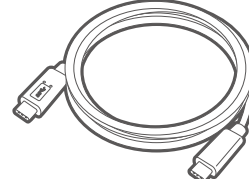

USB Type-C cable x1

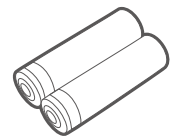

AAA battery x2 *



Touch pen x2

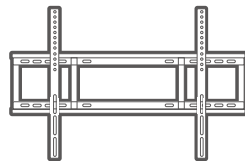

Wall mount (with installation screws)

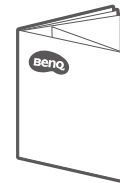

User documents
(Quick start guide, regulation sheets)



- *: Availability may vary. Purchase separately if the accessories are not included in the package.
- The type of power cord supplied may differ from that illustrated depending on your region of purchase.
- Before discarding the package, check that you haven't left any accessories inside the box.
- Dispose of packaging materials wisely. You can recycle the cardboard carton. Consider storing the package (if possible) for future transport of the display.
- Do not leave plastic bags within reach of young children or babies.

Set up the display



Please pay attention to the following notes during installation:

- This display should be installed by at least two adult persons. Attempting to install this display by only one person may result in danger and injuries.
- Refer the installation to qualified technicians. Improper installation may cause the display to fall or malfunction.
- Stability Hazard: The flat panel may fall, causing serious personal injury or death. To prevent injury, this flat panel must be securely attached to the wall in accordance with the installation instructions.

Install the display on a wall

1. Place a clean, dry and lint-free cloth on a flat, horizontal and object-free surface. Make sure that the size of the cloth is larger than the display.
2. Gently lay the display on the cloth with the LCD screen facing down.
3. Identify the wall mounting screw holes on the back of the display as shown in the illustration.

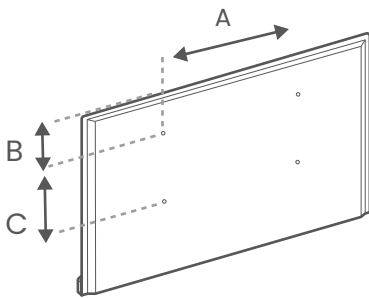

- Screw type: M8 x 25L
- Quantity: 4

| Dimension | 65" | 75" | 86" | 98" |
|-----------|----------|----------|----------|----------|
| A | 600 mm | 800 mm | 800 mm | 800 mm |
| B | 244.5 mm | 313.2 mm | 282.2 mm | 361.1 mm |
| C | 400 mm | 400 mm | 600 mm | 600 mm |

4. Install the wall mounting bracket on the display and attach the display to the wall according to the mounting bracket's instructions. The length of the screw should exceed the thickness of the wall mounting bracket by at least 25 mm. Make sure that all screws are tightened and secured properly. (Recommended torque: 470 - 635N•cm).

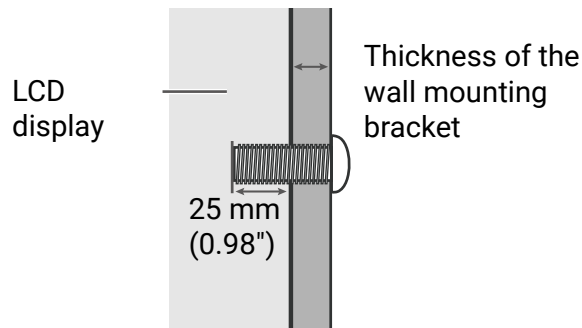

- To maintain proper ventilation, keep at least 10 mm of clear space from the back cover of the display to the wall.
- Please consult a professional technician for wall mount installations. The manufacturer accepts no liability for installations not performed by a professional technician.

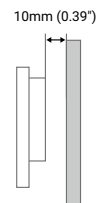

Install external PC

 The rear panel illustrations are for your reference only.

The back of the display has four screw holes at its bottom-left side with a dimension of VESA mount 75x75 mm. You can secure the PC onto the display with four screws (maximum torque: 4-5 kgf-cm).

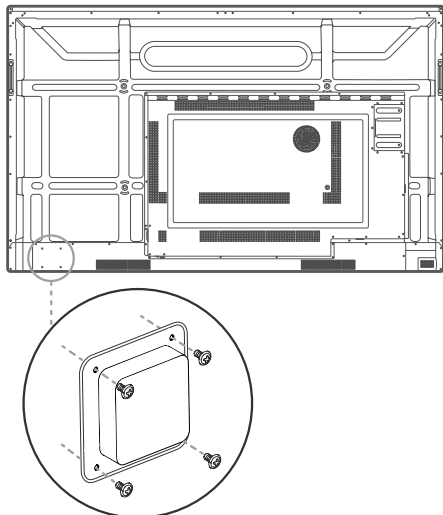

Parts of the display and their functions

Front panel

RE6504/RE7504/RE8604

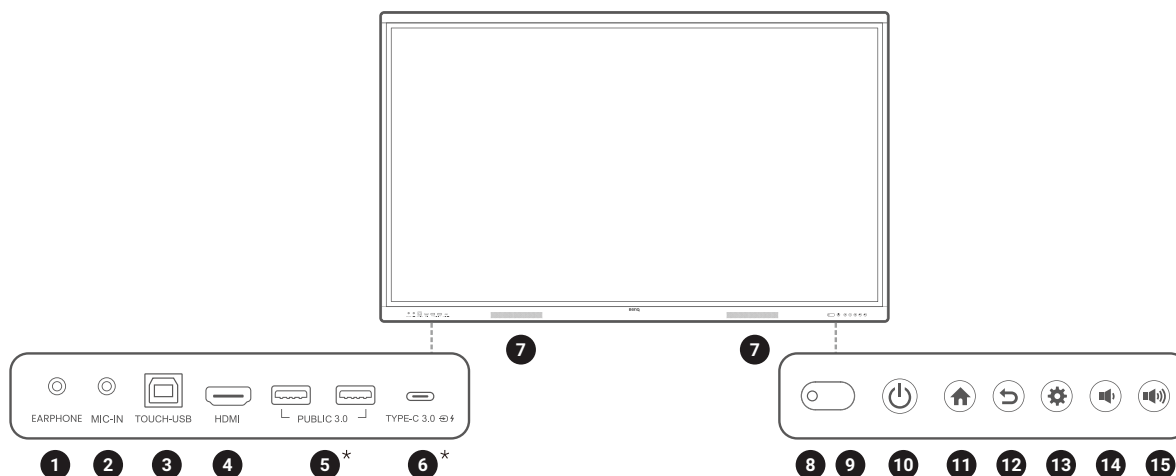

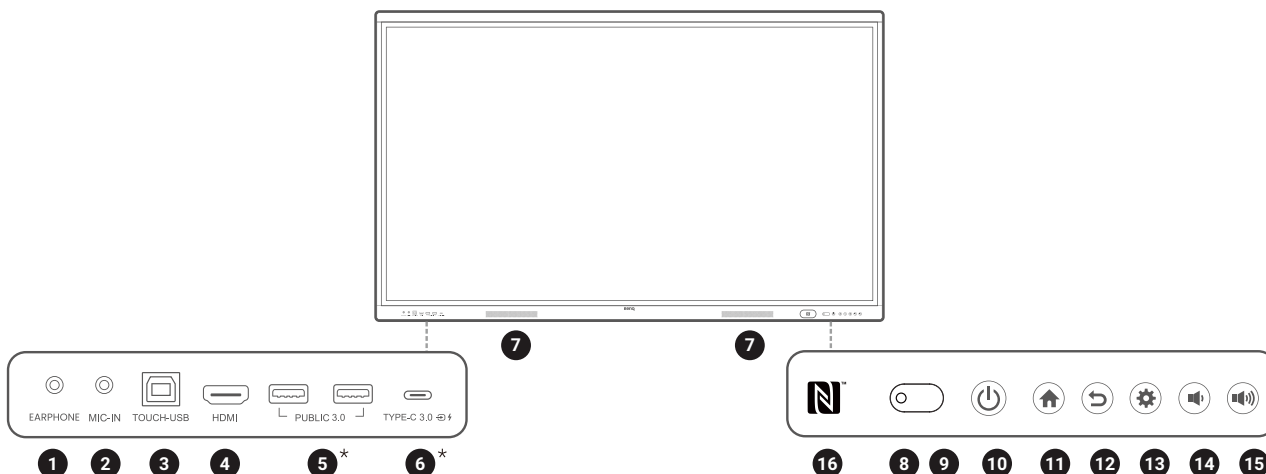

RE6504F/RE7504F/RE8604F

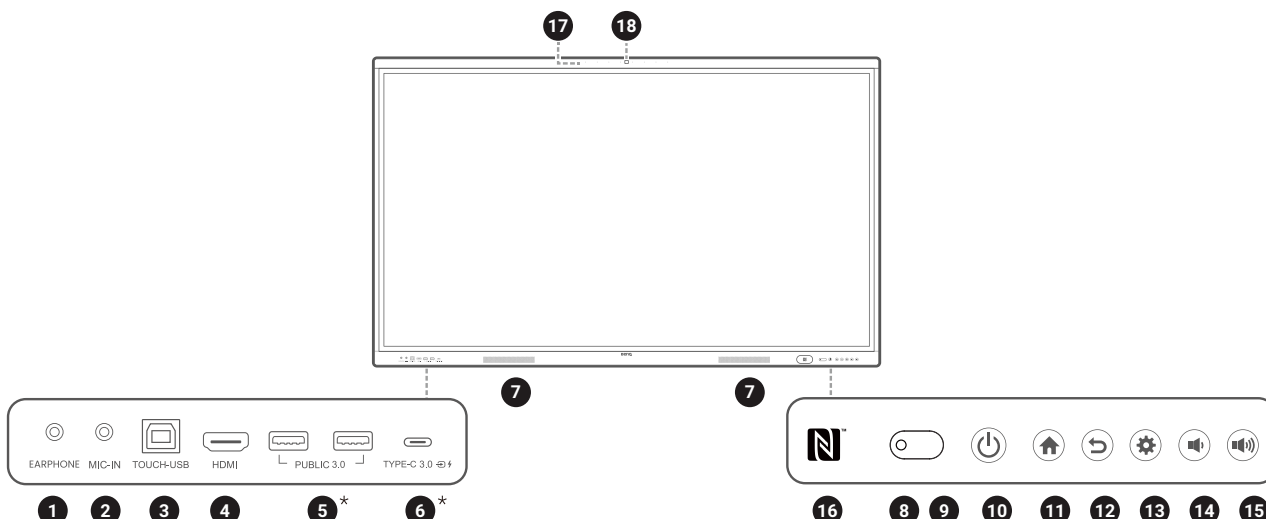

RE6504FV/RE7504FV/RE8604FV/RE9804FV



| No. | Name | Description |
|-----|-----------------------------|---|
| 1 | EARPHONE | Connects to external speakers or earphones.  This port does not support microphone function. |
| 2 | MIC-IN | Connects a microphone to send out amplified audio from the display speaker.  This port only supports 3.5 mm TRS connector (1 ring). |
| 3 | TOUCH-USB | Supports touch signal input from an external computer. |
| 4 | HDMI | Connects to video sources that support the HDMI interface. |
| 5 | PUBLIC 3.0* | Connects USB-A devices such as keyboards, mouse, and USB flash drives. |
| 6 | TYPE-C* | Connects to USB-C devices for power delivery and data transfer. Supports the transmission of video, audio, and touch function. |
| 7 | Speakers | Allows you to play audio directly from the display. |
| 8 | Ambient light sensor | Detects the ambient light around the display. |
| 9 | IR signal receiver | Receives infrared signals from remote control. |
| 10 | Power | <ul style="list-style-type: none"> • Tap to enter energy saving mode. • Press and hold for 4 seconds or more to power off. |
| 11 | Home | Returns to the main screen. |
| 12 | Return | Returns to the previous menu. |
| 13 | Menu | Enters the function menu. |
| 14 | Volume down | Decreases the volume. |
| 15 | Volume up | Increases the volume. |
| 16 | NFC sensor | Tap NFC card for AMS login. |
| 17 | Array microphones | Receives and transmits sound from near the display. |
| 18 | Camera** | Built-in camera for video conferences. |



* With these smart ports, a laptop (connected to BenQ Board via USB Type-C or HDMI + Touch USB) can use the USB devices, speakers, and external cameras from BenQ Board to enhance the conference experience. Please note that the built-in array microphone can only be accessed by an OPS source.

** The board typically supports effective use at a distance ranging from 1 to 6 meters. This distance can vary depending on the size of the room and specific usage scenarios.

Rear panel

See [Connections on page 15](#) for details.

 The rear panel illustrations are for your reference only.

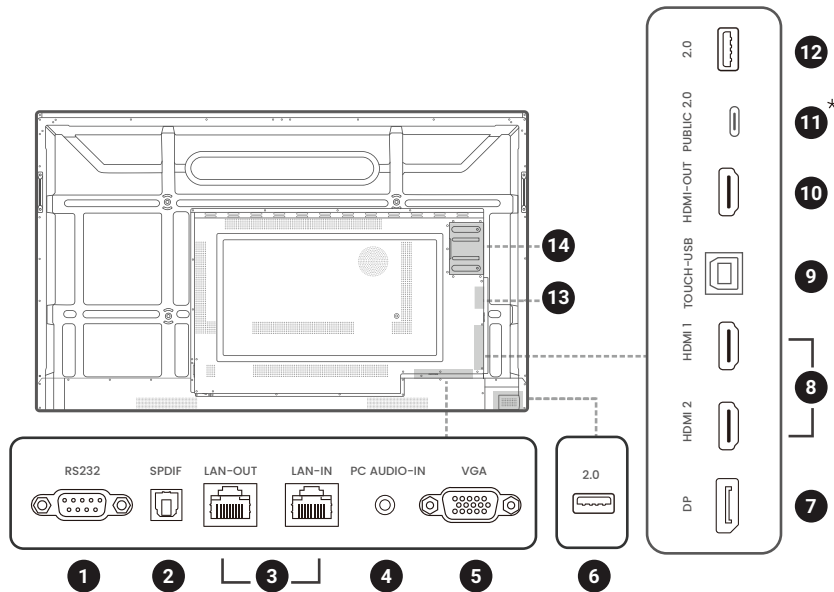

| No. | Name | Description |
|-----|------------------------|--|
| 1 | RS232 | Serial interface, used for mutual transfer of data between devices. |
| 2 | SPDIF | Connects the SPDIF cable from external audio devices to the display for audio out. |
| 3 | LAN | Supports LAN In & Out, 10/100/1000 Mbps for Android system and OPS. |
| 4 | PC AUDIO-IN | Receives audio input from an external device. |
| 5 | VGA | Receives video input from an external device (such as a computer). |
| 6 | USB 2.0 | Unscrew the USB cover to access the USB slot for the wireless USB adapter. |
| 7 | DP | Connects a video source to a display device. |
| 8 | HDMI 1 / HDMI 2 | Connects to video sources that support the HDMI interface. |
| 9 | TOUCH-USB | Supports touch signal input from an external computer. |
| 10 | HDMI-OUT | Connects to display devices with an HDMI input. |
| 11 | PUBLIC 2.0* | Connects to USB-C devices for data transfer. |
| 12 | USB 2.0 | Connects USB-A devices such as keyboards, mice, and USB flash drives. |
| 13 | SD card slot | Supports installation of an SD card. |
| 14 | OPS slot | Supports installation of a slot-in PC. |



* With these smart ports, a laptop (connected to BenQ Board via USB Type-C or HDMI + Touch USB) can use the USB devices, speakers, and external cameras from BenQ Board to enhance the conference experience. Please note that the built-in array microphone can only be accessed by an OPS source.

- USB 2.0= 5V --- 500mA / USB3.0= 5V --- 900mA
 - Rear Type-C (data transfer only) = 5V --- 0.5A
 - Front Type-C = 5V --- 3A; 9V --- 3A; 12V --- 3A; 15V --- 3A; 20V --- 3.25A
 - OPS= 18V --- 5A; 90W
 - --- : Direct Current (DC)
 - \sim : Alternating Current (AC)
 - The maximum length for the cables to be used with the USB slots are 5m (USB 2.0) and 3m (USB 3.0).
-

Remote control

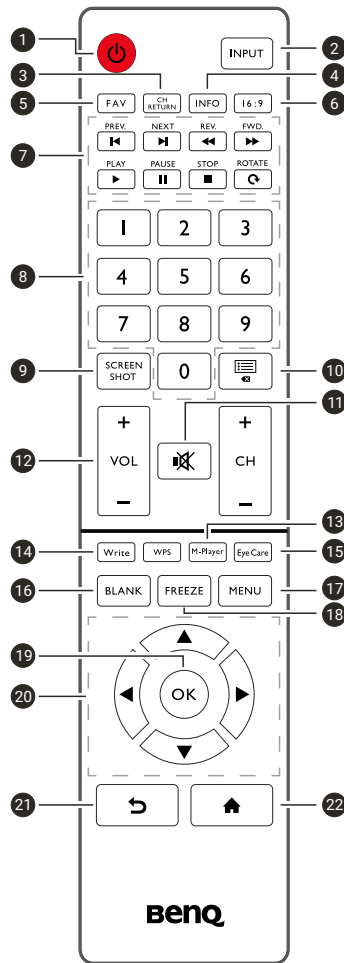

| No. | Icon | Description |
|-----|---|---|
| 1 | POWER | Turns the display on or off. |
| 2 | INPUT | Select the input source. |
| 3 | CH RETURN | Channel return Note: It is only working on some specific regions. |
| 4 | INFO | Show the information of the current input source. |
| 5 | FAV | Favorite program Note: It is only working on some specific regions. |
| 6 | Meeting mode | Change the display image to the different mode under non-Android system Mode: Full, 4:3, Film, Subtitle, PC mode. |
| 7 | MULTI-MEDIA buttons | The buttons are used to operate the media functions under Multi-Media APP. |
| 8 | Numeric buttons (0-9) | Press to enter numbers. |
| 9 | SCREEN SHOT | Capture the printed screen and save to the USB drive. |
| 10 | CHLIST () | Delete a character / view program list. Note: It is only working on some specific regions. |
| 11 | MUTE | Mute/unmute |
| 12 | VOL- / VOL+ | Increases or decreases the volume. |
| 13 | M-Player | Open the Media Player app in Android. |
| 14 | Write | Open the EZWrite app in Android. |

| No. | Icon | Description |
|-----|------------------------------------|---|
| 15 | Eye Care | Open the Eye Care function in Android. |
| 16 | BLANK | Blank and mute the screen (the screen will turn black) when the OSD menu is off. Press again to resume. |
| 17 | MENU | Activate the OSD menu. |
| 18 | FREEZE | Freeze the screen. |
| 19 | OK | Confirm the selected options or save changes. |
| 20 | Cursor keys (◀ / ▶ / ▲ / ▼) | Scroll through settings and options in the OSD menu. |
| 21 | BACK | Press this key to return to previous page. |
| 22 | HOME | Show the main screen of Android system. |

Install remote control batteries

1. Open the remote control battery cover.
2. Insert the supplied batteries, ensuring the positive and negative ends are facing in the correct direction.



The supplied batteries are provided for your convenience so that you can operate the display straight away. You should replace them as soon as possible.

3. Put the cover back on.

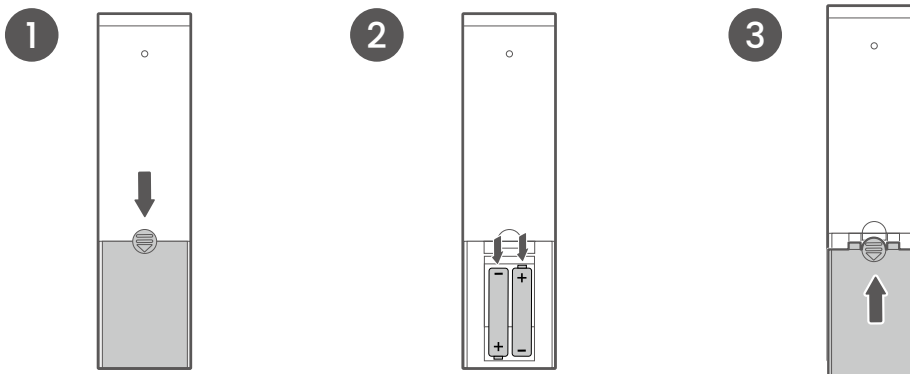

Use BenQ Board by remote control

Aim the remote control at the sensor at the display's bottom-right side within a distance of less than 8m, and a horizontal and vertical angle of less than 60 degrees.

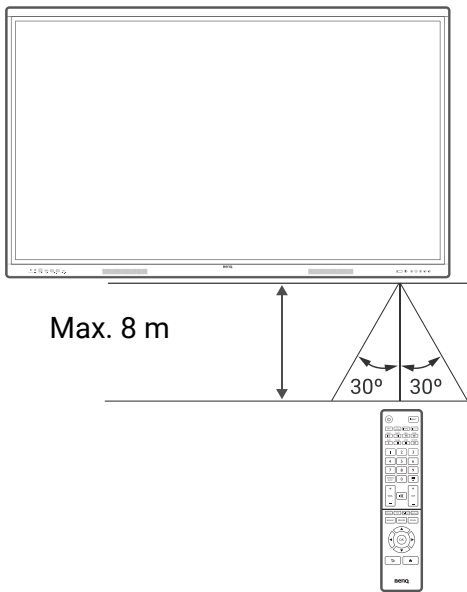

This remote control applies only to a specific model and operating systems. Contact your reseller if you have any question.

Remote control usage tips

- Avoid getting the remote control wet or store it in humid environments (like bathrooms).
- If the display's remote control sensor window is exposed to direct sunlight or strong light, the remote control may not operate properly. In this situation, change the light source, readjust the angle of the display, or operate the remote control from a location closer to display's remote control sensor window.

Connections

 The following illustrations are for your reference only.

Connect power

1. Plug one end of the power cord into the power jack on the display and the other end into an appropriate power outlet.
2. Set the power switch to ON (I). The system will enter standby mode.

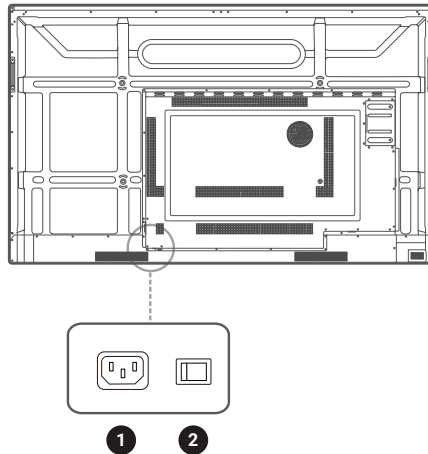

- The supplied power cord is suitable for use with 100-240V AC power only.
- The power cord and outlet illustrated may differ from the ones used in your region.
- Only use an appropriate power cord for your region. Never use a power cord which appears damaged or frayed, or change the plug type on the power cord.
- Be aware of the power loading when you use extension cords or multiple outlet power boards.
- There are no user serviceable parts in this display. Never unscrew or remove any covers. There are dangerous voltages inside the display. Turn off the power and unplug the power cord if you intend to move the display.

Turn the display on or off

- To turn on the display, press the power button on the control panel or on the remote control.
- To turn off the display, press the power button on the control panel. The system will automatically enter standby mode.

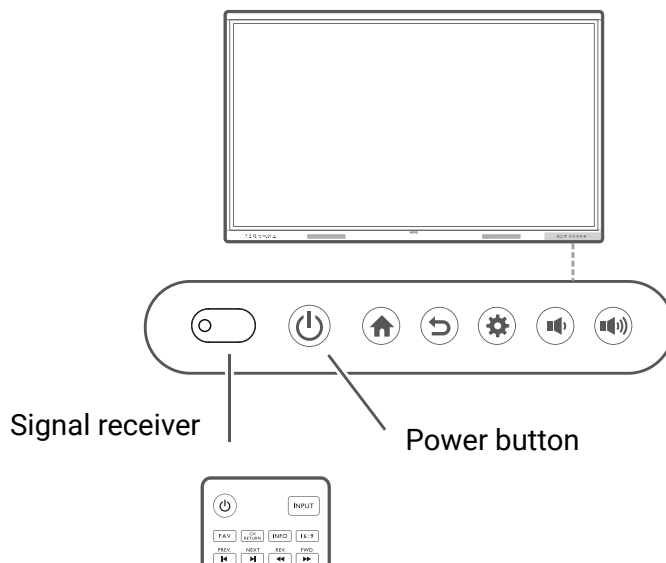

- The display's standby mode still consumes power. To completely cut off power supply, set the power switch to OFF (O) and then disconnect the power cord from the power outlet.

Connect the touch module

The touch module of the display supports easy plug-and-play operation. There is no need to install additional drivers on the computer.

Try either method below to set up the video and touch input:

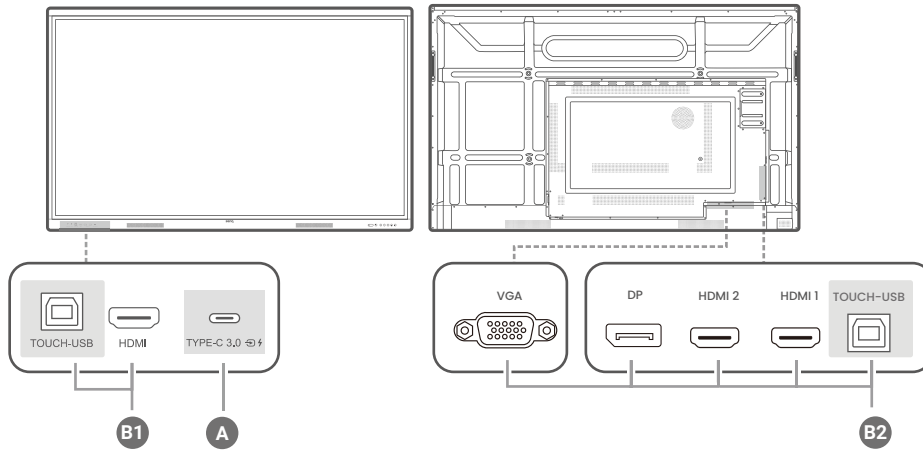

A. Connect the **TYPE-C** port on the display to a USB Type-C port on the computer using the supplied USB Type-C cable.

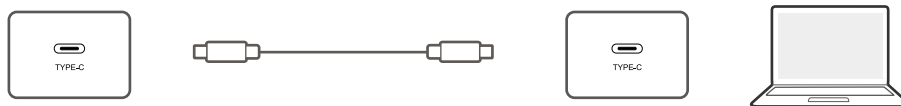

B. Connect a video cable (**HDMI/DP/VGA**) and the supplied touch USB cable from a computer to the corresponding ports of the display.



- **HDMI** must be used with the **TOUCH-USB** at the front panel.
- **HDMI 1 or HDMI 2, VGA or DP** must be used with **TOUCH-USB** at the rear panel.

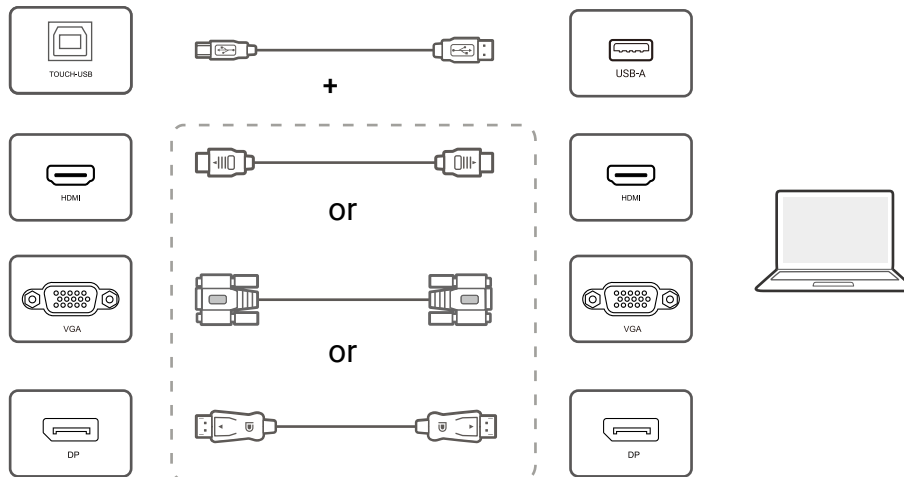

- Avoid blocking the touch screen frame (where sensors are located) when initiating the touch module.
- If any ghost image occurs, please try to un-plug and then re-plug all USB cables. If the failure image still exists, use another USB Type-B to Type-A cable.
- It is highly recommended that you connect the display to the PC or laptop directly. Please be noted that using a faceplate device or an extender may cause failures in touch operations since the display quality can be affected by many uncertainties such as cable grade, cable quality, source and destination equipment, RF and electrical interference, and cable patches.

Connect the VGA input

1. Connect the **VGA** port on the display to the VGA output port on a computer using a D-Sub (15-pin) cable.
2. Connect the computer's audio output port to the **PC AUDIO-IN** jack on the display using a suitable audio cable.

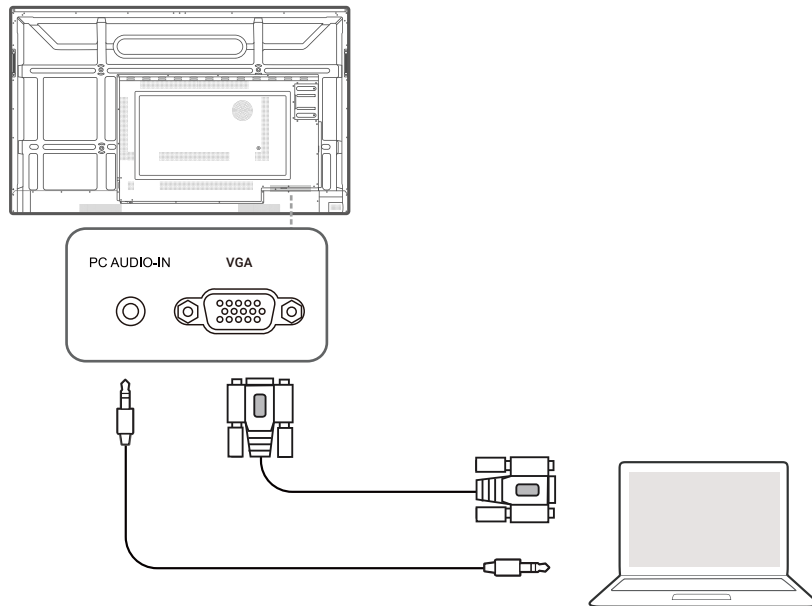

Connect the digital inputs

1. Connect the HDMI or DisplayPort output port of a computer or A/V device (such as a settop box or DVD player) to the **HDMI/HDMI 1/HDMI 2//DP** input port on the display using an HDMI or DisplayPort cable.
2. To view video from this input, press  on the remote control to switch to the respective input source.

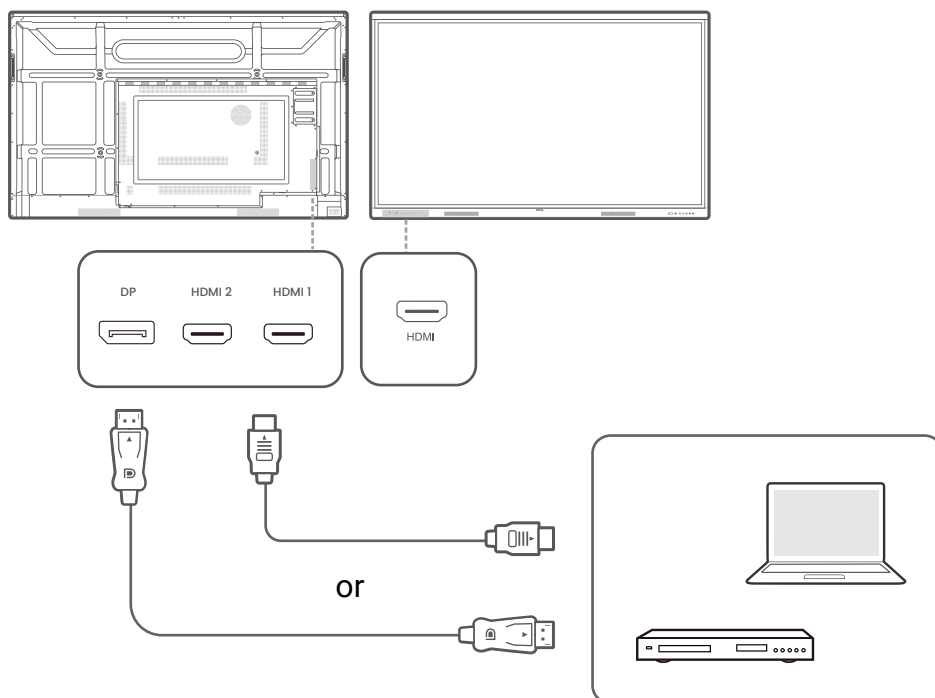

Connect the video output

Use an HDMI cable to connect the **HDMI-OUT** port to the respective input port on the device.

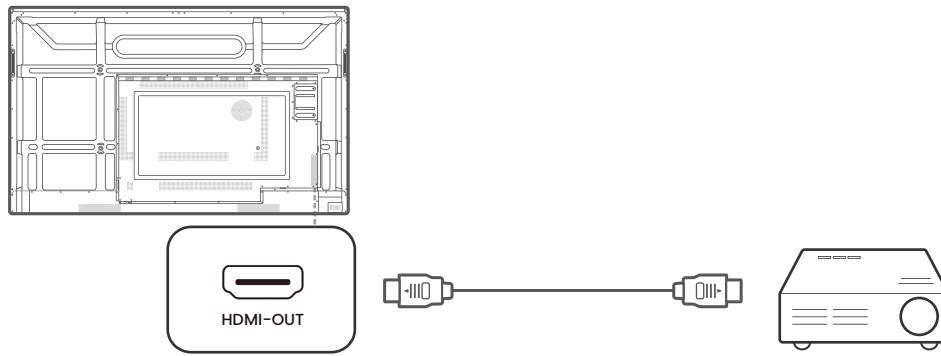

Connect to serial port

Directly connect a computer to the **RS232** port on the input/output terminals.

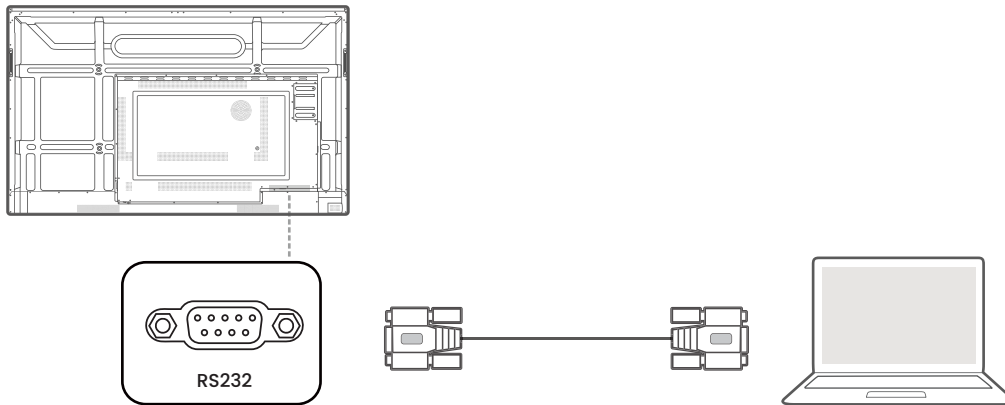

- The applicable cable is not supplied and should be purchased separately.
- This connection is applicable to straight-through RS-232C cable only.
- After using serial port line to connect central control equipment and machine, certain function of the machine can be controlled via central control equipment, such as: machine on/off, and adjustment of sound volume, etc.

Initial setup

1. Turn on the display. Wait for the display to boot up with the BenQ screen.
2. Follow the on-screen instructions to set up the language, date and time, and network. You can skip some of these steps and complete the setup later.
3. For copy data and set pin code section, select **Skip** to continue.
4. In BenQ service selection screen, set the toggle to **On**.

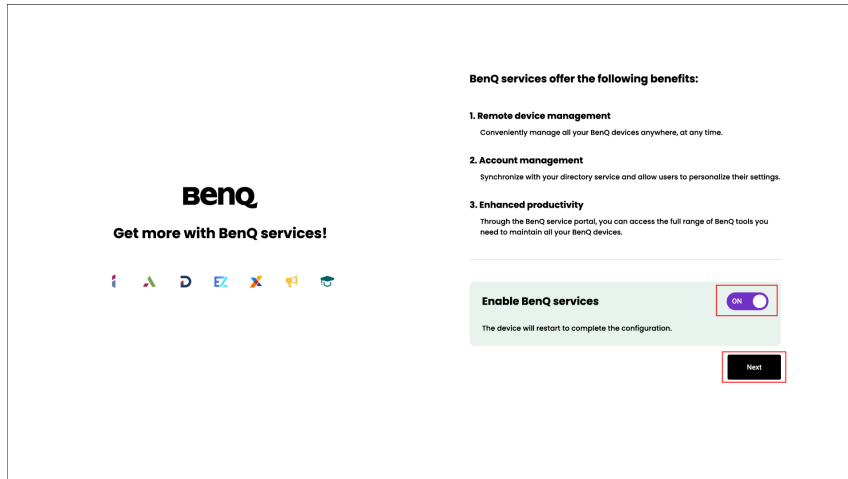

5. Select **Next** to continue. Your BenQ Board will restart.



Google has a default screen lock feature that locks the screen when the board is idle. To disable this function, tap  **All apps** > **Settings** app. Go to **Security** > **Screen lock** and select **None**.

Enable AMS service

You may enable AMS service if account management is required. Select **AMS service** at the bottom left corner to activate BenQ AMS service.

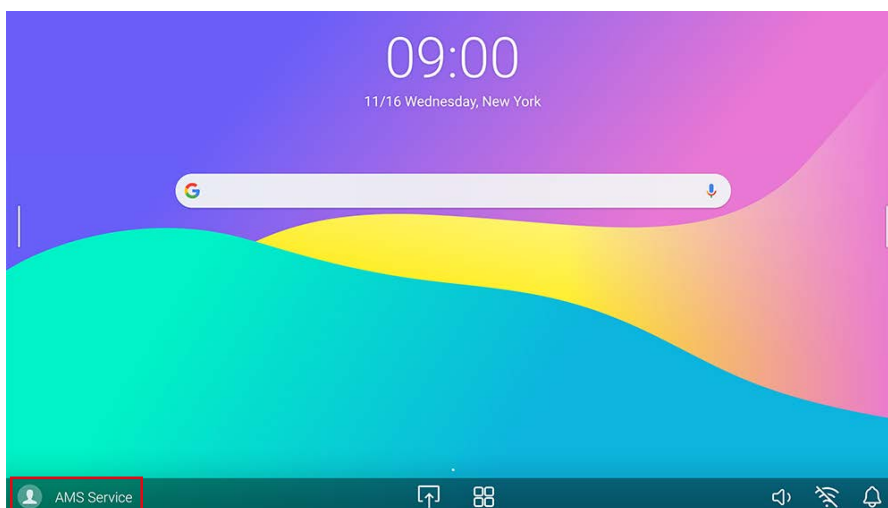

Log in to BenQ Board

BenQ provides different login options for easier account management. Log in options are as below.

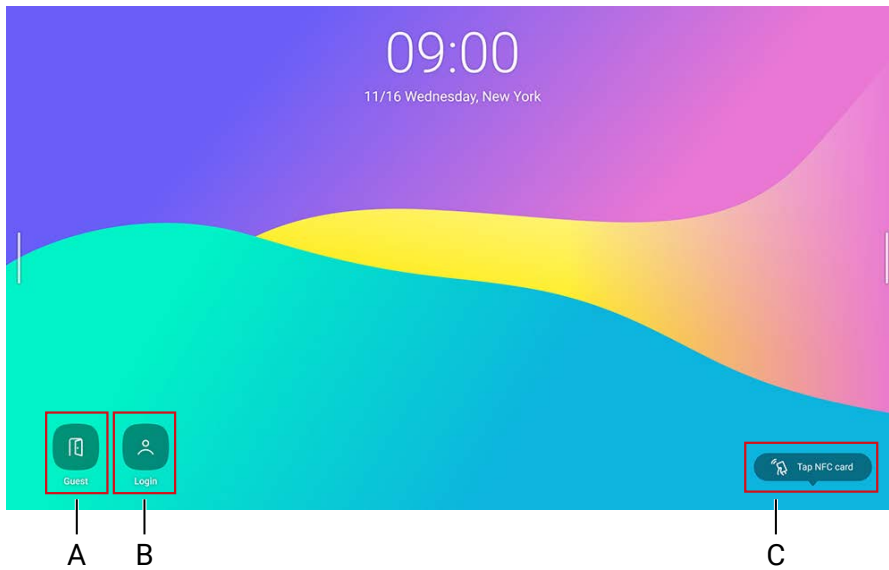

A. Guest

As a guest, you can access most of the basic functions. All data will be erased after logging out.

B. User login

- As AMS admin, you have full access to the board.
- As AMS user, you can customize your working space and keep personal bookmarks, app shortcuts and wallpapers. All app data will be saved individually.
- * Each board stores up to 8 user information.

C. NFC login (RE04F&RE04FV only)

Tap a registered NFC card on the NFC sensor to log in.



For more information and tutorial videos about the AMS service please visit [BenQ website](#).

BenQ service interface

After signing in, users may access functions as below.

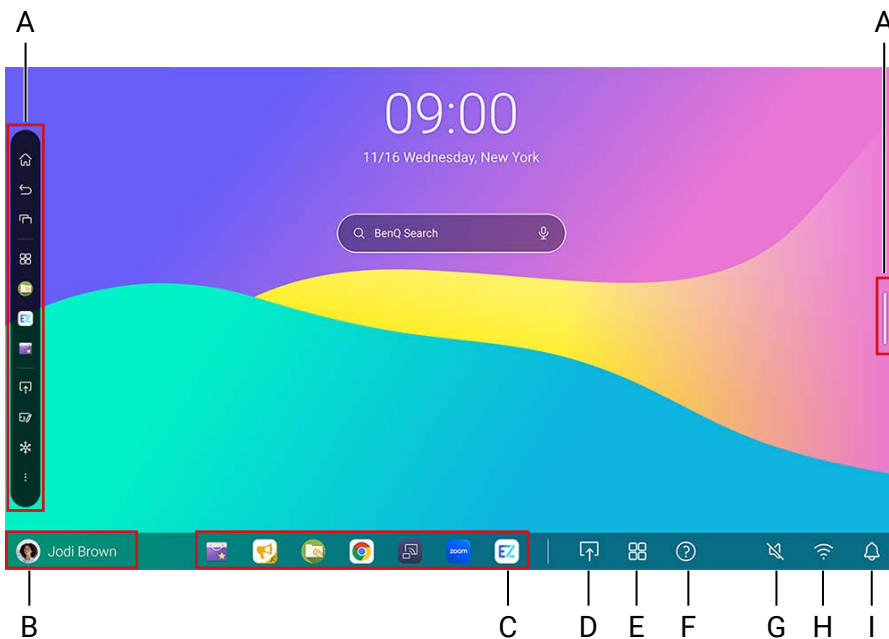

A. Side tool bar (see page 21)

B. User information

C. App shortcuts

Add up to 7 shortcuts (sync with AMS web).

D. Connection

E. All apps

Tap to find all apps, widgets and bookmarks.

F. Help

G. Volume

H. Wi-Fi

I. Notifications

Side tool bar

Tap the side bars at the left or right of the main interface to access the side tool bar.



You may drag the tool to the top or bottom of the screen to suit your preference.

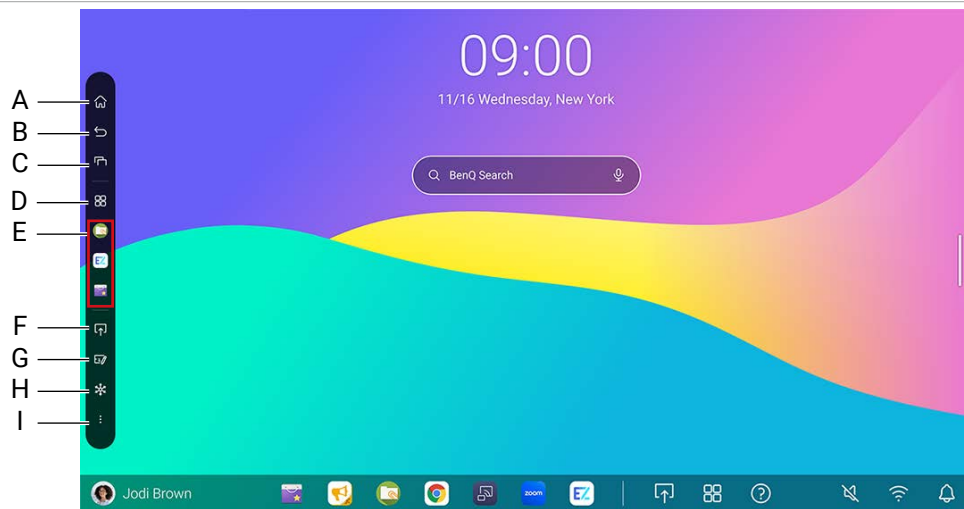

A. Home

B. Back

C. Recent

Switch between recent apps and input sources.

D. Quick launch

Tap to find all apps and bookmarks.

E. Recently opened apps

F. Connection

G. EZWrite

H. Freeze

I. Floating tool (see [page 35](#))

Set up the Internet connection

Your display must be connected to a network to conduct OTA updates or surf the Internet.

Wireless connection

You must use a wireless adapter in order to connect the display to the Internet wirelessly. Please contact your local dealer for more information on configuring the wireless connection.

1. Swipe up from the bottom of your screen to the top to bring up the OSD menu.

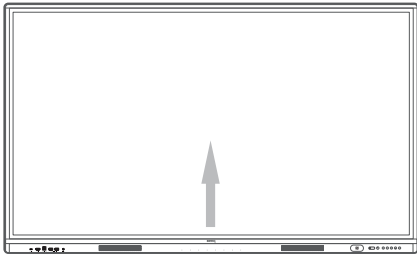

2. Tap the  icon to open the **Settings** app.

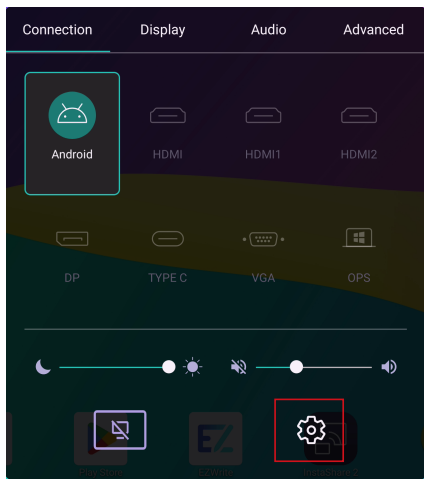

3. In the **Settings** app, go to **Network & Internet > Internet**.

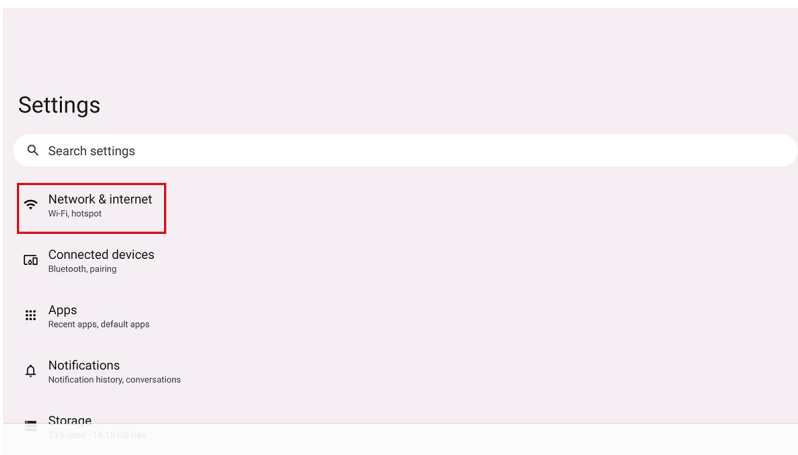

4. Tap the switch to turn on Wi-Fi.
5. Tap a listed network.



Wi-Fi or LAN can't be on at the same time. Check if LAN is turned off before you start using Wi-Fi.

Proxy settings for Wi-Fi

1. Tap the  icon to open the **Settings** app.

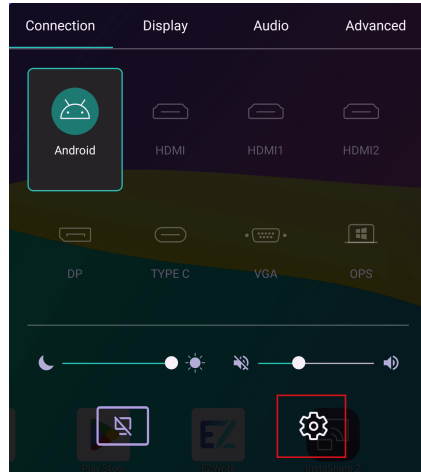

2. In the **Settings** app, go to **Network & Internet > Ethernet**.

3. Select your Wi-Fi network from the list.

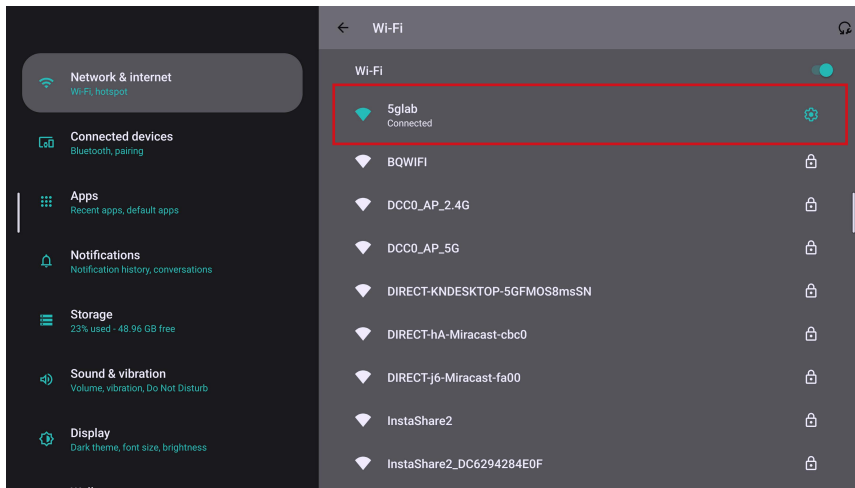

4. Select the pencil icon on the top right corner. A dialog box will pop up.

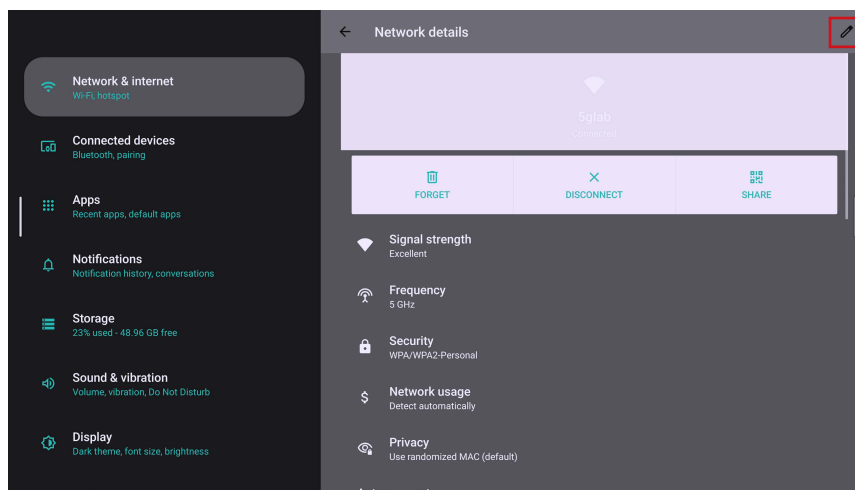

5. In the popup, tap **Apps** to extend the menu.

6. In the **Proxy** dropdown, select **Manual**.

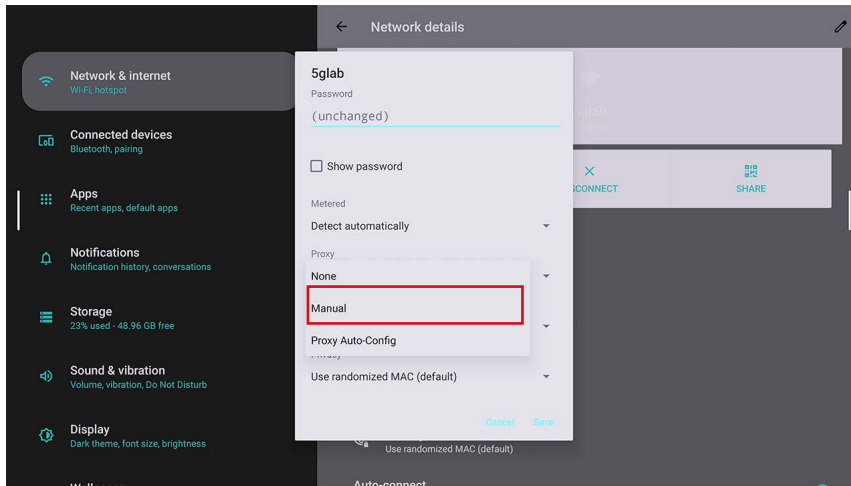

7. Enter your proxy server's information.

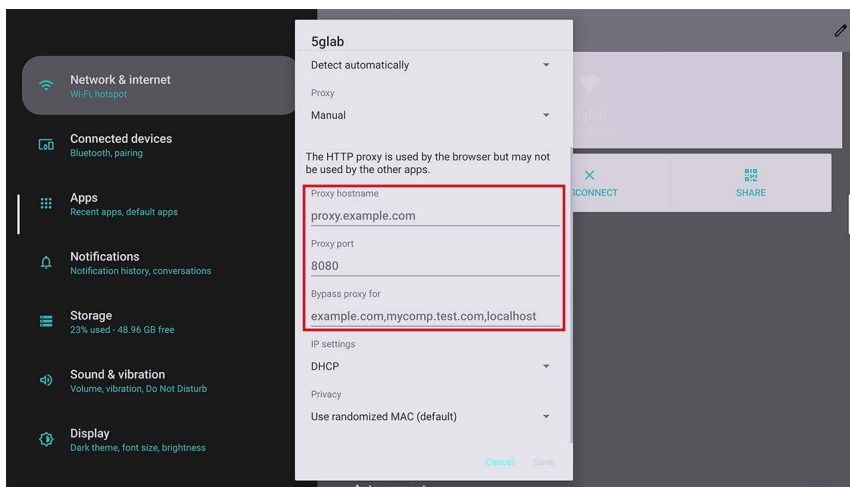

8. Save your settings.

Proxy settings for Ethernet

1. Tap the  icon to open the **Settings** app.

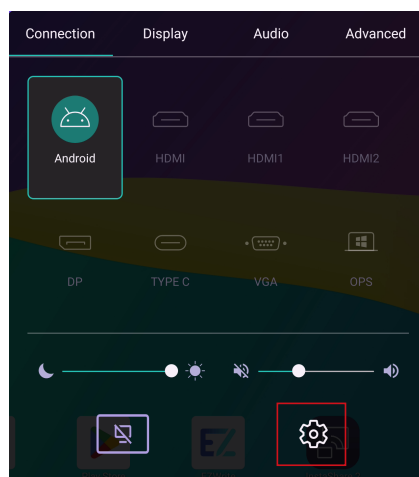

2. In the **Settings** app, go to **Network & Internet** > **Ethernet**.

3. Select **Proxy** to extend the menu.

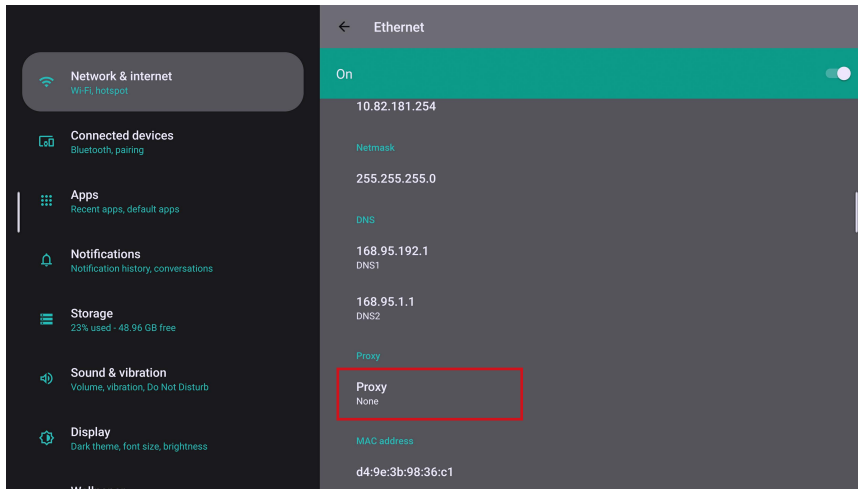

4. In the **Proxy** dropdown, select **Manual**.
5. Enter your proxy server's information.
6. Save your settings.

System update

The system will automatically detect and prompt for software updates on every startup. To manually update the software

1. Swipe up from the bottom of your screen to the top to bring up the OSD menu.

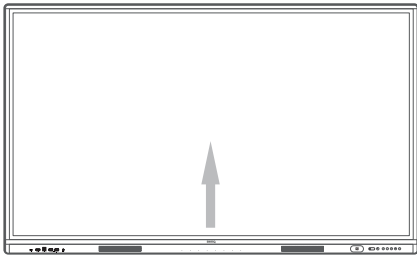

2. Tap **Advanced** > **System update**.

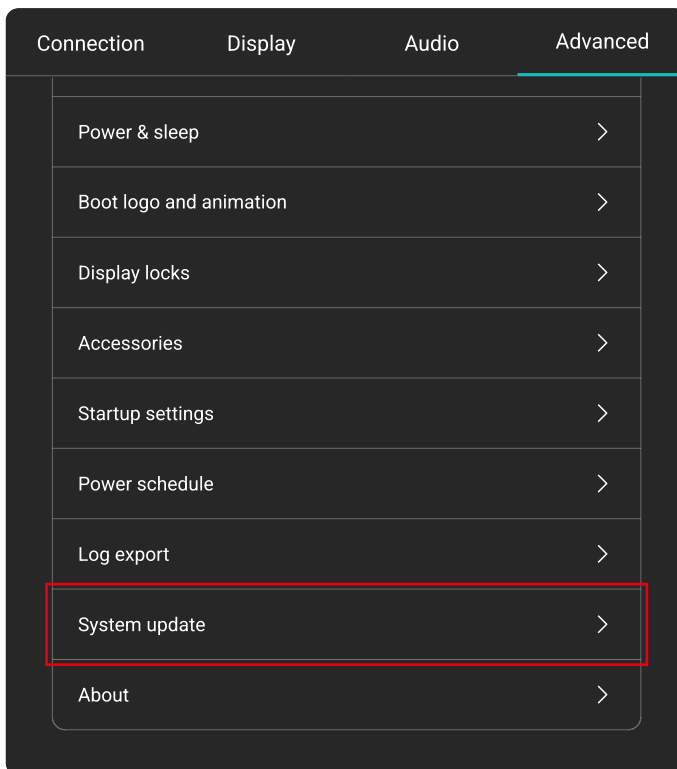

3. Select **Update system**. The system will begin updating.

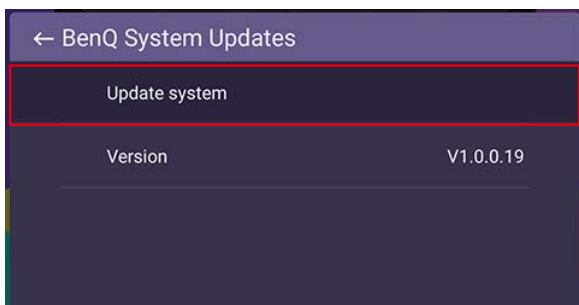

- Software update process may take some time to complete.
- During the update process, do not turn off the device or disconnect the Internet connection. Any interruptions during the software update process may permanently damage your display.

Google system interface

If you did not enable BenQ services, you'll see the Google interface as below.

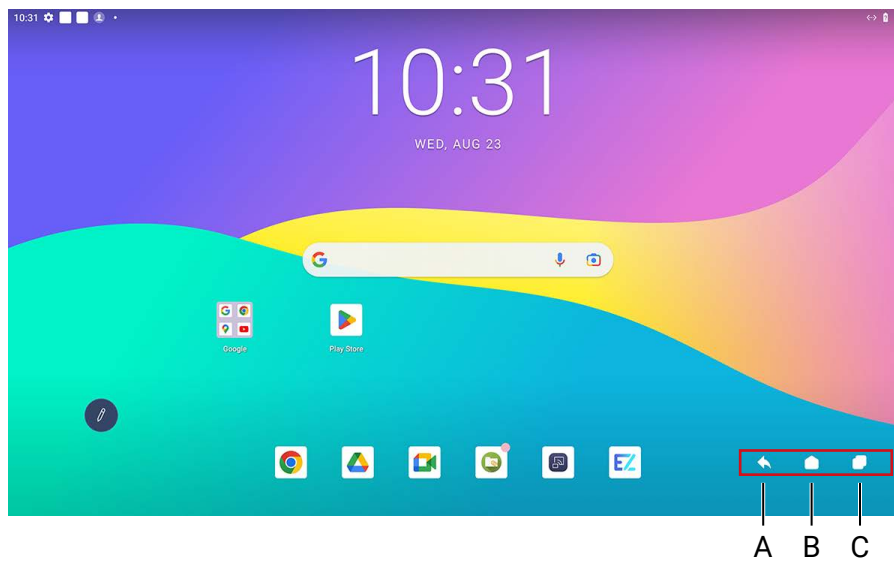

- A. Back
- B. Home
- C. Recent apps

Menu operations

Through BenQ Board

- To enter the OSD menu, press  on the control panel or swipe up from the bottom of your screen to the top.

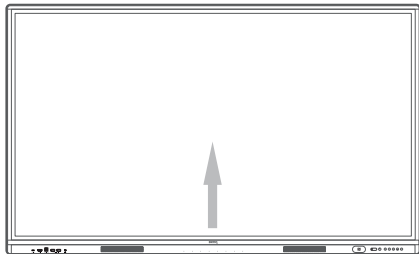

- To make selections, directly tap an item.
- Tap a blank area outside the menu to exit.

Through remote control

- To enter the OSD menu, press  on the remote control.
- To make selections, press  /  /  /  and press **OK** to confirm.
- Press  to exit the menu.

Connection settings

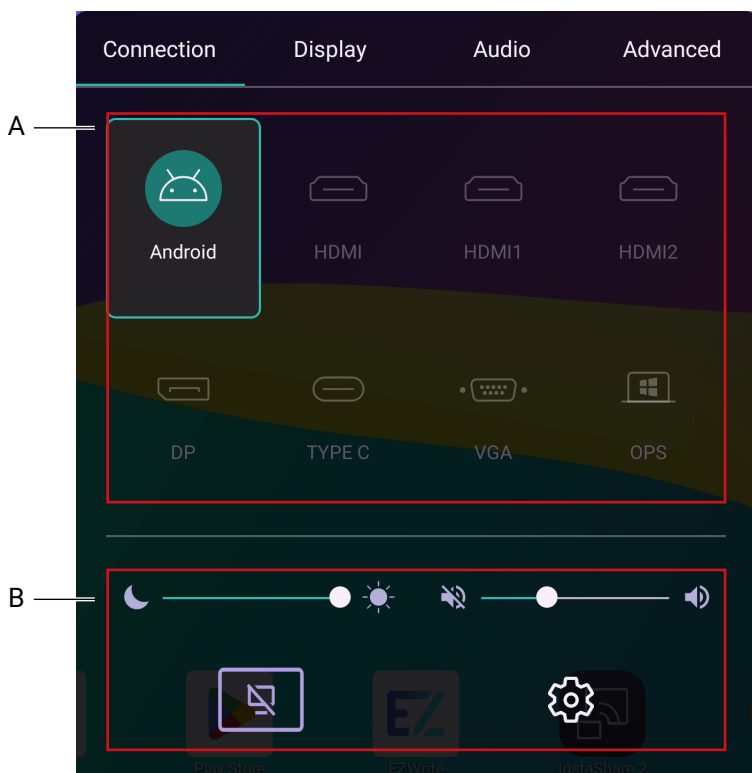

- A. Select an input source to connect.
- B. See [General settings](#).

General settings

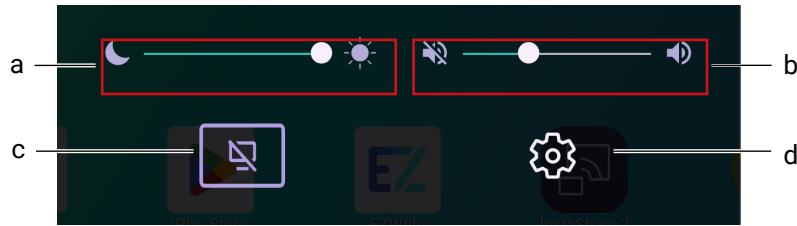

a. Brightness

- Use the brightness bar to adjust the brightness for the display.
- To adjust picture details, go to **⚙️ > Display > Picture mode**.

b. Audio

- Use the volume bar to adjust the volume for the display.
- To adjust audio details, go to **⚙️ > Audio**.

c. Blank

- Select to temporarily blank the screen.
- Tap anywhere on the screen to exit blank mode.
- Choose to keep the sound in background or not in **⚙️ > Display > Advanced settings > Blank button on remote**.

d. Settings

- Tap to open the **Settings** app.

Display settings

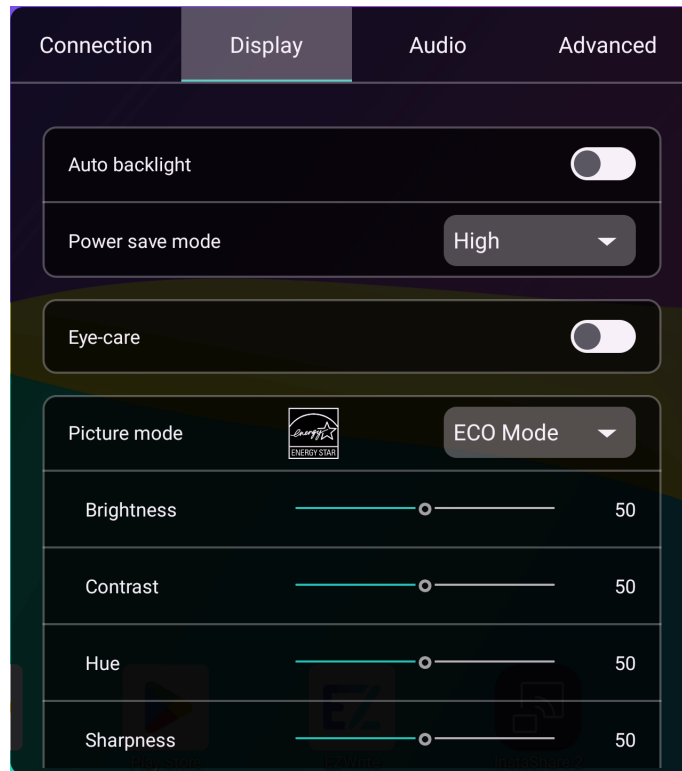

| Menu | Descriptions |
|----------------------------|--|
| Auto backlight | Switch on/off auto backlight. |
| Power save mode | When no input source such as HDMI, DP, VGA, Type-C is detected, power save options are as below. <ul style="list-style-type: none"> • Off: Always keep backlight on. • Low: Turn off backlight when no input source is detected after 5 minutes. • High: Turn off the display when no input source is detected after 5 minutes. |
| Eye care | Switch on the function to enable low blue light. |
| Picture mode | Switch between preset picture modes that best suit the type of images shown on the screen. Options are ECO, Standard, Bright, Soft, Custom1, Custom2, Custom3 .  Under Android OS, all picture parameters (e.g., Brightness, Contrast) are locked. Users may only adjust the parameters while connecting to other input sources such as HDMI, DP, VGA and Type-C. |
| Color temperature | Adjust the color temperature of the display. Options are Normal, Cool, Warm . |
| Custom source names | Set unique names for each input source. |

Advanced settings

Adjust functions below:

- **Aspect ratio**
- **EDID**
- **HDMI CEC & ARC**
- **Pixel shift**
- **Dynamic contrast (DCR)**
- **Auto switch source**
- **HDMI out**
- **Blank button on remote**
- **VGA calibration including H-position, V-position, Clock, Phase.**

Eye-Care solutions

Blue light with wavelengths under 455 nm could affect vision. Eye-Care solution is designed for eyesight protection: the display provides proprietary eye-care technology with ultra-low blue light emission and no visible or invisible flicker within the range of 0-3000Hz, preventing eyestrain caused by extended sessions in front of a display. In addition, advanced anti-glare screen treatment minimizes distracting reflections and glare for optimal productivity and comfort.



Suggestions for long-term use of the display:

- Rest your eyes for 10 minutes after 30 minutes of continuous use.
- For every 20 minutes of display viewing, look into the distance for 20 seconds.
- When your eyes get sore and strained, close your eyes for a minute and then roll your eyes in all directions.

Low blue light & Flicker free

- To meet the Low Blue Light TÜV certification, the display settings should be:
 - **Picture mode: Standard**
 - **Color temperature: Normal**
- The default settings of the display meets the Flicker-Free & Flicker-Reduced TÜV certification.

What is Flicker-Free and Flicker-Reduced?

Flicker-Free and Flicker-Reduced is improved from the power circuit. Flicker-Free uses DC power technology for linear dimming or adjusts the PWM frequency to meet safer specifications. Flicker-Reduced only uses PWM and adjusts the PWM frequency to meet the criterion. With this technology, the light source of the LED backlight module either avoid or reduce screen flicker to reduce eye fatigue. BenQ's non-flicker technology has also been certified by TÜV Rheinland, which shows BenQ's commitment in safeguarding vision health of consumers.



- Models following TÜV Rheinland Flicker-Free criterion: RE6504/RE7504/RE8604/RE6504F/RE7504F/RE8604F/RE6504FV/RE7504FV/RE8604FV
- Models following TÜV Rheinland Flicker-Reduced criterion: RE9804FV

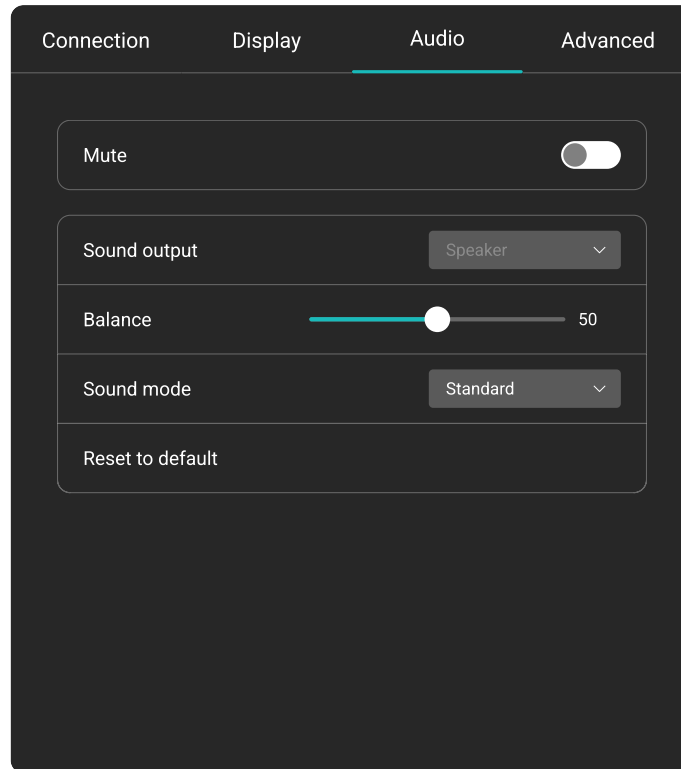

Audio settings

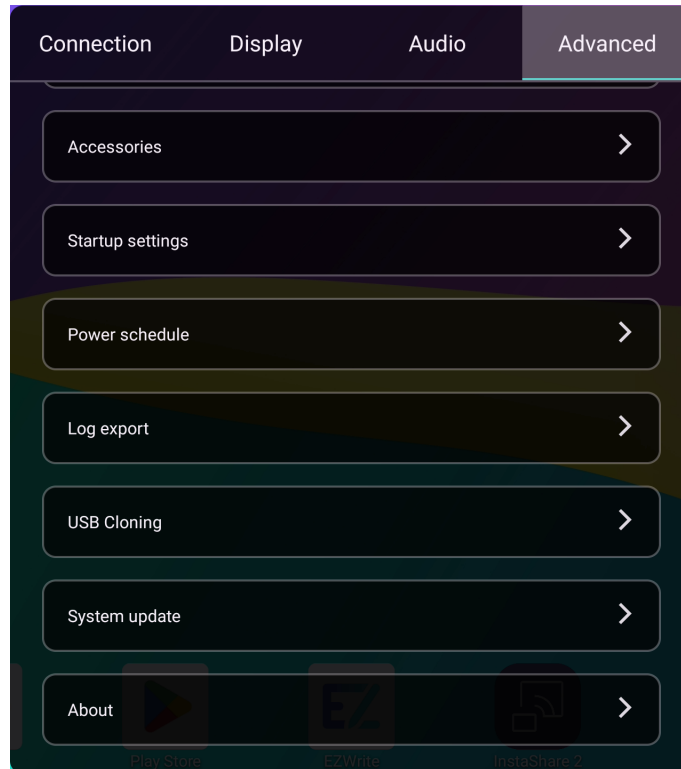

| Menu | Descriptions |
|---------------------|---|
| Mute | Tap the switch to mute or unmute. |
| Sound output | Select your audio output source. <ul style="list-style-type: none">• Speaker: Output from BenQ Board• Line out: Output from external speaker• Both: Output from both BenQ Board and external speaker |
| Balance | Adjust the sound balance of the audio output. |
| Sound mode | Switch between preset sound modes that best suit your environment. <ul style="list-style-type: none">• Standard• News• Cinema• Sports• Music |

Advanced settings



| Menu | Descriptions |
|--------------------------------|---|
| Network & Internet | |
| Apps | Shortcuts to open the respective menu of the Settings app. |
| System | |
| System toolbar | Show/hide the toolbar. |
| Floating tool gesture | Enable/Disable activating Floating tool with two fingers. |
| Power & sleep | Set the time you want the display to automatically enter Sleep/Power off mode. |
| Boot logo and animation | Customize your boot logo and animation.  Available in 2025 Q1 |
| Display locks | Choose to turn the lock on/off. <ul style="list-style-type: none"> • Keypad lock: Lock the buttons on the control panel. • Remote control lock: Lock the remote control IR sensor on the control panel. • Touch lock: Lock the display screen.  If all locks are locked all at once, press  on the control panel for 5 seconds to unlock. |
| Accessories | Select your microphone and webcam source. |

| Menu | Descriptions |
|-------------------------|--|
| Startup settings | Set the Startup source and multiple wakeup settings. For Slot-in PC startup , options are as below: <ul style="list-style-type: none"> • Source selected: Starts up OPS by selecting OPS in Connection. • Board startup: Starts up OPS when BenQ Board starts up. |
| Power schedule | Start up and shut down the display at a designated time, and set a startup source. You can set up to 7 schedules. |
| Log export | Tap to select a location to save your log file. |
| System update | Manually update system software. See System update on page 26 for details. |
| USB cloning | Import device settings from your USB storage or export device settings to your USB storage. |
| About | View system information. |

Floating tool

The EZWrite floating tool allows you to quickly write or create annotations on any screen that the display is showing.

To access the floating tool use either one of the following methods:

- In the Android interface, tap in the side tool bar.
- Under any input source or in the Android interface, touch and hold two fingers spaced about 20 – 50 mm apart on the screen for more than two seconds to launch the floating tool menu as shown below.











| Icon | Function | Descriptions |
|------|------------------|---|
| | Minimize/Restore | Minimize or restore the floating tool. |
| | Close | Close the floating tool. |
| | Pen | Enable the Pen tool. |
| | Highlighter | Enable the highlighter tool. |
| | Laser pointer | Enable the laser point on the screen. |
| | Eraser | Erase annotations on the screen. You may use a finger eraser or choose to clear all annotations |
| | Toolbox | Open the toolbox which includes the Calculator, Timer, Stopwatch, Scoreboard, and Draw tools. |
| | Recording | Record the screen. |
| | Screenshot | Take a screenshot of the screen. |
| | Operation mode | Hide all the annotations and operate the main interface. |

Apps

You can access all google services and some BenQ Apps by default.

BenQ apps

| Icon | Application name | Description |
|---|--|---|
|  | AMS files | Access your personalized workspace environment and settings, and manage your files and accounts on any BenQ display that you have logged in to. |
|  | EZWrite 6 | An interactive whiteboard software that turns your display into a digital canvas. |
|  | InstaShare 2 | Allows screen mirroring and touch control for collaborative meetings. |
|  | BenQ App Store | Allows you to download recommended apps. |
|  | Notification | Allows you to receive upgrade notifications of existing apps and information of new apps available for download. |
|  | X-Sign Broadcast | Lets you deliver scheduled messages and instant alerts to all your BenQ devices for any occasion. |
|  | DMS Client | Allows remote management, configuration, and monitoring of the display. |
|  | Visit BenQ website to find the user manual for each BenQ software. | |

Supported media formats

| Extension | Codec detail | Resolution |
|-----------|------------------|------------|
| .3gp | MPEG-4 Visual | 640x480 |
| | MPEG-4 | 320x240 |
| | H264 | 1920x1080 |
| .avi | AVC | 1920x1080 |
| | M-JPEG | 1024x576 |
| | RealMagic MPEG-4 | 720x480 |
| | | 720x576 |
| | h264 | 1920x1080 |
| .f4v | FF mpeg MPEG4 | 640x480 |
| | AVC(H264) | 1280x720 |
| .flv | Sorenson Spark | 1920x1080 |
| | VP6 | 800x342 |
| .mp4 | AVC(H264) | 1920x1080 |
| | HEVC(H26 5) | 1920x1080 |
| | 4K HEVC(4K H265) | 4096x2304 |
| | 8K HEVC(8K H265) | 8192x4320 |
| .m2ts | AVC | 1920x1080 |
| | VC-1 | 1920x1080 |
| .m2v | MPEG-2 | 480x576 |
| .m4v | AVC | 1280x720 |
| .mkv | WMV3 | 1280x720 |
| | MPEG-4 Visual | 1920x1080 |
| | AVC | 1920x1080 |
| | 4K HEVC(4K H265) | 3840x2160 |
| | 8K HEVC(8K H265) | 8192x4320 |
| | VP8 | 1920x1080 |
| | VP9 | 1920x1080 |
| .mov | MPEG-4 Visual | 1280x720 |
| | mjpa | 640x480 |
| | M-JPEG | 640x480 |
| | AVC(H264) | 1920x1080 |
| | 4K H264 | 3840x2160 |
| .mpeg | MPEG-2 | 1920x1080 |
| | VC-1 | 1920x1080 |
| | MPEG-1 | 720x576 |

| Extension | Codec detail | Resolution |
|-----------|------------------|------------|
| .mts | AVC | 1440x1080 |
| .ogm | XVID | 640x480 |
| .PMP | H264 | 480x272 |
| .rmvb | RealVideo1 | 1280x720 |
| | RealVideo2 | 1280x720 |
| | RealVideo3 | 1280x720 |
| | RealVideo4 | 1920x1080 |
| .tp | MPEG-2 | 1920x1088 |
| | HEVC(H26 5) | 1920x1080 |
| | 4K HEVC(4K H265) | 4096x2304 |
| | 8K HEVC(8K H265) | 8192x4320 |
| | MPEG-1 | 1920x1080 |
| .ts | avs | 720x576 |
| | avs+ | 1920x1080 |
| | avs2 | 3840x2160 |
| | AVC | 1920x1080 |
| | MPEG-2 | 1920x1080 |
| .vob | MPEG-2 | 720x576 |
| .wmv | WMV1 | 640x480 |
| | WMV2 | 768x432 |
| | WMV3 | 1920x1080 |
| .webm | VP8 | 1920x1080 |
| | VP9 | 1920x1080 |
| | 4K VP9 | 4096x2160 |
| | 8K VP9 | 8192x4608 |
| 4K | AVC(H264) | 4096x2304 |
| | HEVC(H26 5) | 4096x2304 |
| | VP9 | 4096x2160 |
| 8K | HEVC(H26 5) | 8192x4320 |
| | VP9 | 8192x4608 |

Product information

Specifications

| | | Specifications |
|-------|--|---|
| Item | | RE6504 / RE7504 / RE8604 / RE6504F / RE7504F / RE8604F / RE6504FV / RE7504FV / RE8604FV / RE9804FV |
| Panel | Size | <ul style="list-style-type: none"> • RE6504/RE6504F/RE6504FV: 65" • RE7504/RE7504F/RE7504FV: 75" • RE8604/RE8604F/RE8604FV: 86" • RE9804FV: 98" |
| | Light Source | DLED |
| | Aspect Ratio | 16:9 |
| | Resolution | 3840 x 2160 |
| | Pixel Pitch(mm) | <ul style="list-style-type: none"> • RE6504/RE6504F/RE6504FV: 0.37(H) x 0.37(V) • RE7504/RE7504F/RE7504FV: 0.43(H) x 0.43(V) • RE8604/RE8604F/RE8604FV: 0.49(H) x 0.49(V) • RE9804FV: 0.56(H) x 0.56(V) |
| | Brightness with Glass (Typical) | <ul style="list-style-type: none"> • RE6504/RE6504F/RE6504FV/RE7504/RE7504F/RE7504FV/RE8604/RE8604F/RE8604FV: 400 nits • RE9804FV: 450 nits |
| | Brightness without Glass (Typical) | <ul style="list-style-type: none"> • RE6504/RE6504F/RE6504FV/RE7504/RE7504F/RE7504FV/RE8604/RE8604F/RE8604FV: 450 nits • RE9804FV: 500 nits |
| | Contrast Ratio (Typical) | 1200:1 |
| | Viewing Angle | 178° |
| Touch | Technology | IR |
| | Touch Method | Finger & Stylus |
| | System | Windows 11/10/8/7/Windows XP/Linux/Mac OS X/Android/Chrome |
| | Touch Point | Up to 40pts touch for Windows; up to 32 pts touch for Android |
| | Minimum Object Size | <ul style="list-style-type: none"> • RE6504/RE6504F/RE6504FV/RE7504/RE7504F/RE7504FV/RE8604/RE8604F/RE8604FV: 3.5 mm, pen tip is 3.5 mm/8 mm, supports 2 pens writing with 2 colors simultaneously • RE9804FV: 2.8 mm, pen tip is 2.8 mm/8 mm, supports 2 pens writing with 2 colors simultaneously |
| | Response Time | < 8 ms |
| | Accuracy | ±1 mm, 90% area |
| Glass | 3.2 mm thickness, AG, 9H panel, germ-resistant | |

| | | Specifications |
|----------------|--|--|
| Item | RE6504 / RE7504 / RE8604 / RE6504F / RE7504F / RE8604F / RE6504FV / RE7504FV / RE8604FV / RE9804FV | |
| Connectors | HDMI IN | Rear: x 2, Front: x 1 (2.0) |
| | HDMI Output | x 1 (4K@60Hz with audio) |
| | DP IN | x 1 |
| | VGA IN | x 1 |
| | PC-Audio IN (3.5 mm audio-in) | x 1 |
| | Mic IN | x 1 |
| | SPDIF (Optical) | x 1 |
| | Audio Output (3.5mm Earphone) | x 1 |
| Connectors | USB 2.0 (Type A) | Wi-Fi dongle: x1 |
| | USB 3.0 (Type A) | Front: x2 |
| | USB Touch Output (OPS/ External pass through MIC/Camera/USB) | Rear: x 1, Front: x 1 (USB 2.0) |
| | RS232 | x1 |
| | LAN (RJ45) | <ul style="list-style-type: none"> • OPS: 10M/100M/1000M • Android: 10M/100M/1000M • LAN IN x1 / LAN Out x1 |
| | USB Type-C | <ul style="list-style-type: none"> • Rear: Data x1 (2.0) • Front: Data/Power(up to 65W)/Touch/DP x1 (3.0) |
| Android System | System Version | Android 13 |
| | CPU | A73 x 4 + A53 x 4 |
| | GPU | MaliG52 MP8 |
| | RAM | 8GB |
| | ROM | <ul style="list-style-type: none"> • RE6504/RE6504F/RE6504FV/RE7504/RE7504F/RE7504FV/RE8604/RE8604F/RE8604FV: 32GB 64GB • RE9804FV: 64GB |
| Video / Audio | Speaker Type | Built in speaker |
| | Output Power | 20W x 2 |

| | | Specifications |
|--------|--|---|
| Item | RE6504 / RE7504 / RE8604 / RE6504F / RE7504F / RE8604F / RE6504FV / RE7504FV / RE8604FV / RE9804FV | |
| Power | Power Requirements | AC 100V-240V, 50/60 Hz |
| | Standby Power | <ul style="list-style-type: none"> • RE6504/RE6504F/RE6504FV: <0.5W • RE7504/RE7504F/RE7504FV: <0.5W • RE8604/RE8604F/RE8604FV: <0.5W • RE9804FV: <0.5W |
| | Typical Power Consumption (W) | <ul style="list-style-type: none"> • RE6504/RE6504F/RE6504FV: 66.7 W • RE7504/RE7504F/RE7504FV: 73.9 W • RE8604/RE8604F/RE8604FV: 106.8 W • RE9804FV: 122.7 W |
| | Max Power Consumption (W) | <ul style="list-style-type: none"> • RE6504/RE6504F/RE6504FV: 375.5 W • RE7504/RE7504F/RE7504FV: 416.6 W • RE8604/RE8604F/RE8604FV: 518.0 W • RE9804FV: 577.0 W |
| | Wake Up | LAN/HDMI/VGA/DP |
| Others | NFC sensor | <ul style="list-style-type: none"> • RE6504/RE7504/RE8604: N/A • RE6504F/RE7504F/RE8604F/RE6504FV/RE7504FV/RE8604FV/RE9804FV: YES |
| | Built-in camera | <ul style="list-style-type: none"> • RE6504/RE7504/RE8604/RE6504F/RE7504F/RE8604F: N/A • RE6504FV/RE7504FV/RE8604FV/RE9804FV: YES |
| | Array mic | <ul style="list-style-type: none"> • RE6504/RE7504/RE8604/RE6504F/RE7504F/RE8604F: N/A • RE6504FV/RE7504FV/RE8604FV/RE9804FV: x8 |

| | | Specifications |
|-------------|-----------------------------|--|
| Item | | RE6504 / RE7504 / RE8604 / RE6504F / RE7504F / RE8604F / RE6504FV / RE7504FV / RE8604FV / RE9804FV |
| Mechanical | Dimension (WxHxD) | <ul style="list-style-type: none"> RE6504/RE6504F/RE6504FV:1482.1 × 907 × 87.7 mm (58.4 × 35.7 × 3.5 inch) RE7504/RE7504F/RE7504FV:1716.5 × 1041.6 × 87.7mm (67.6 × 41.0 × 3.5 inch) RE8604/RE8604F/RE8604FV:1961.8 × 1179.7 × 87.7mm (77.2 × 46.4 × 3.5 inch) RE9804FV:2230.8mm x 1335.9mm x 103.1mm (87.8 × 52.6 × 4.1 inch) |
| | Dimension (Package) (WxHxD) | <ul style="list-style-type: none"> RE6504/RE6504F/RE6504FV:1640.0 × 1010.0 × 185.0 mm (64.6 × 39.8 × 7.3 inch) RE7504/RE7504F/RE7504FV:1860.0 × 1125.0 × 185.0 mm (73.2 × 44.3 × 7.3 inch) RE8604/RE8604F/RE8604FV:2095 × 185 × 1265 mm (82.5 × 7.3 × 49.8 inch) RE9804FV:2455 × 310 × 1485mm (96.7 × 12.2 × 58.5 inch) |
| | Net Weight Gross Weight | <ul style="list-style-type: none"> RE6504/RE6504F:36.4 kg 49.4 kg (80.2 lbs 108.9 lbs) RE6504FV:36.7 kg 49.7 kg (80.9 lbs 109.6 lbs) RE7504/RE7504F:50.2 kg 64.9 kg (110.7 lbs 143.1 lbs) RE7504FV:50.5 kg 65.2 kg (111.3 lbs 143.7 lbs) RE8504/RE8604F:63.4 kg 80.2 kg (139.8 lbs 176.8 lbs) RE8604FV: 63.7 kg 80.5 kg (140.4 lbs 177.5 lbs) RE9804FV: 104.75 kg 134.65 kg (230.9 lbs 296.9 lbs) |
| Environment | Operating Temperature | 0°C ~ 40°C 32°F ~ 104°F |
| | Operating Humidity | 20% ~ 80% RH non-condensing |
| | Storage Temperature | -10°C ~ 60°C 14°F ~ 140°F |
| | Storage Humidity | 10% ~ 90% RH Non-Condensing |
| | Display Orientation | Landscape Only |



- Specifications and functions are subject to change without notice.
- The OPS should be equipped with fire-resistant enclosures.

Dimensions (RE6504)

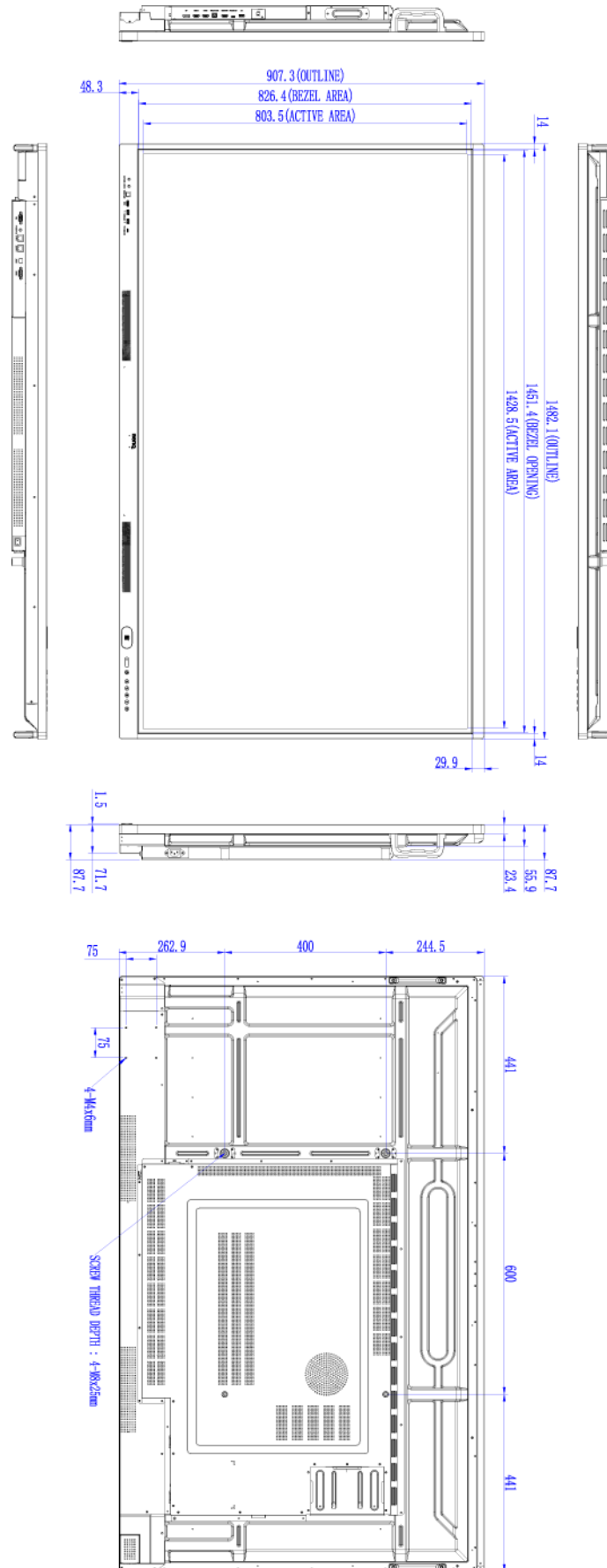

Unit: mm

Dimensions (RE7504)

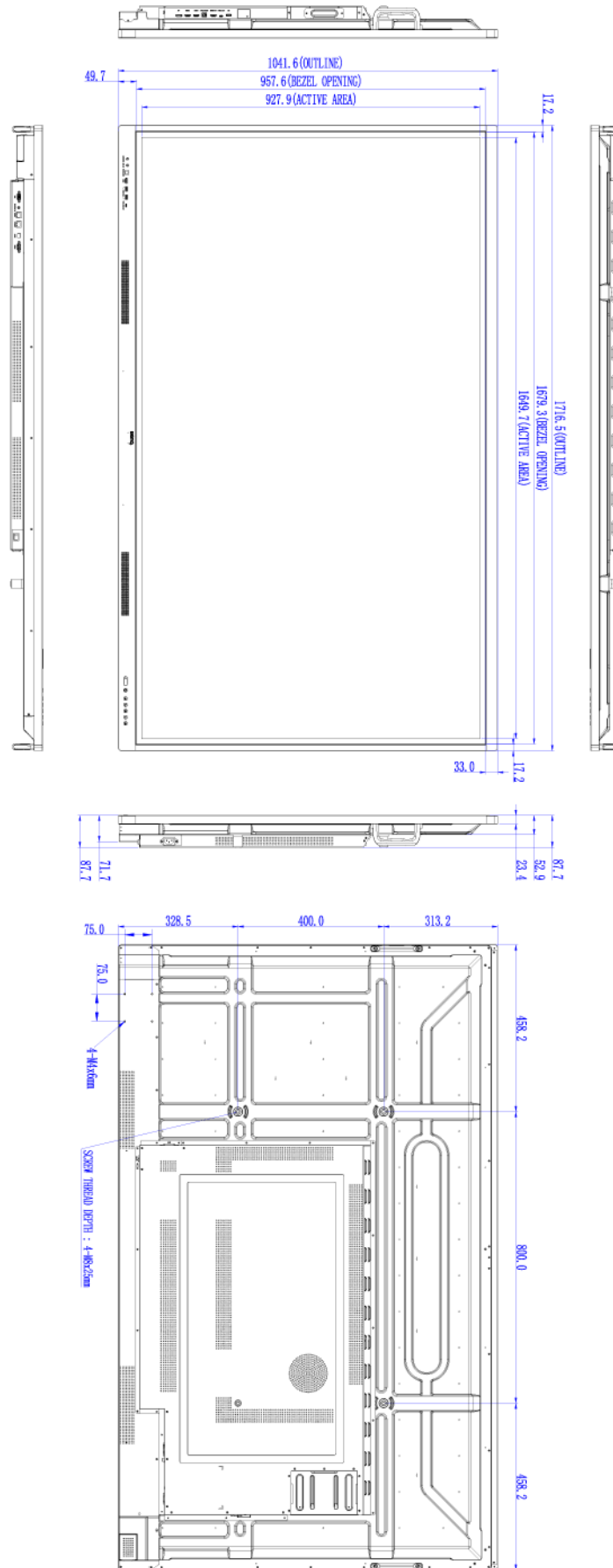

Unit: mm

Dimensions (RE8604)

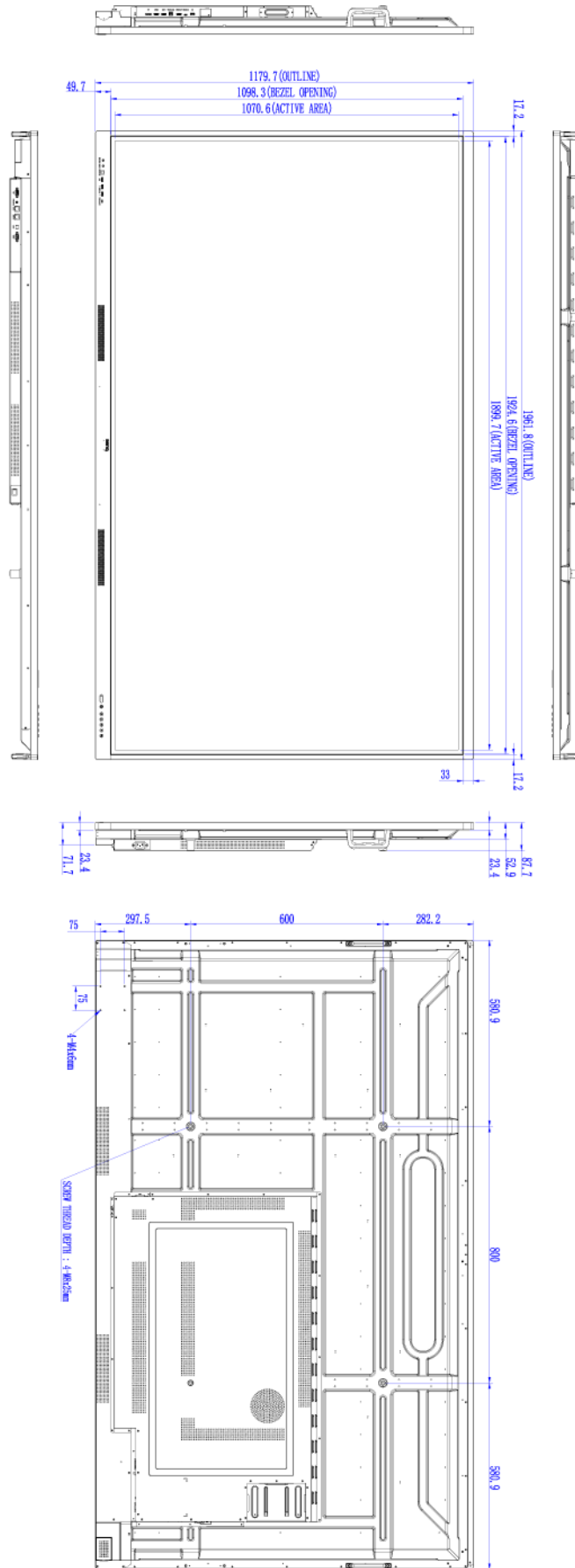

Unit: mm

Dimensions (RE6504F)

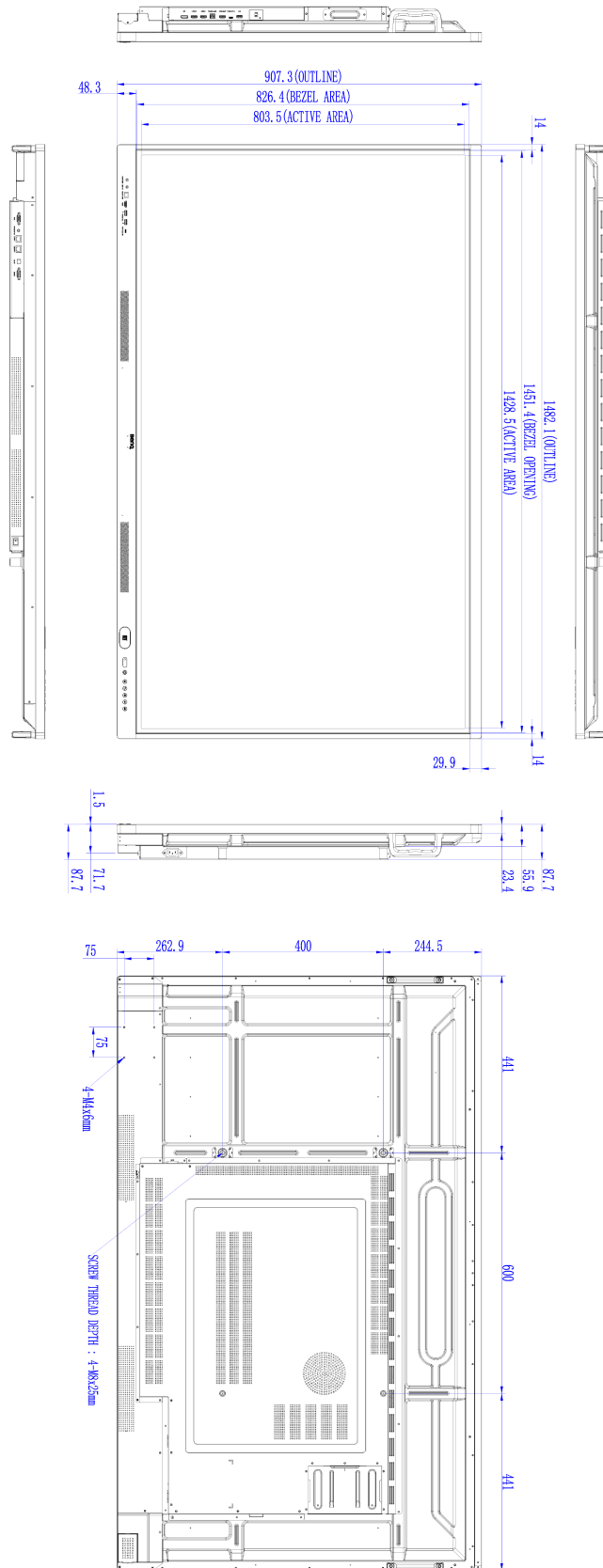

Unit: mm

Dimensions (RE7504F)

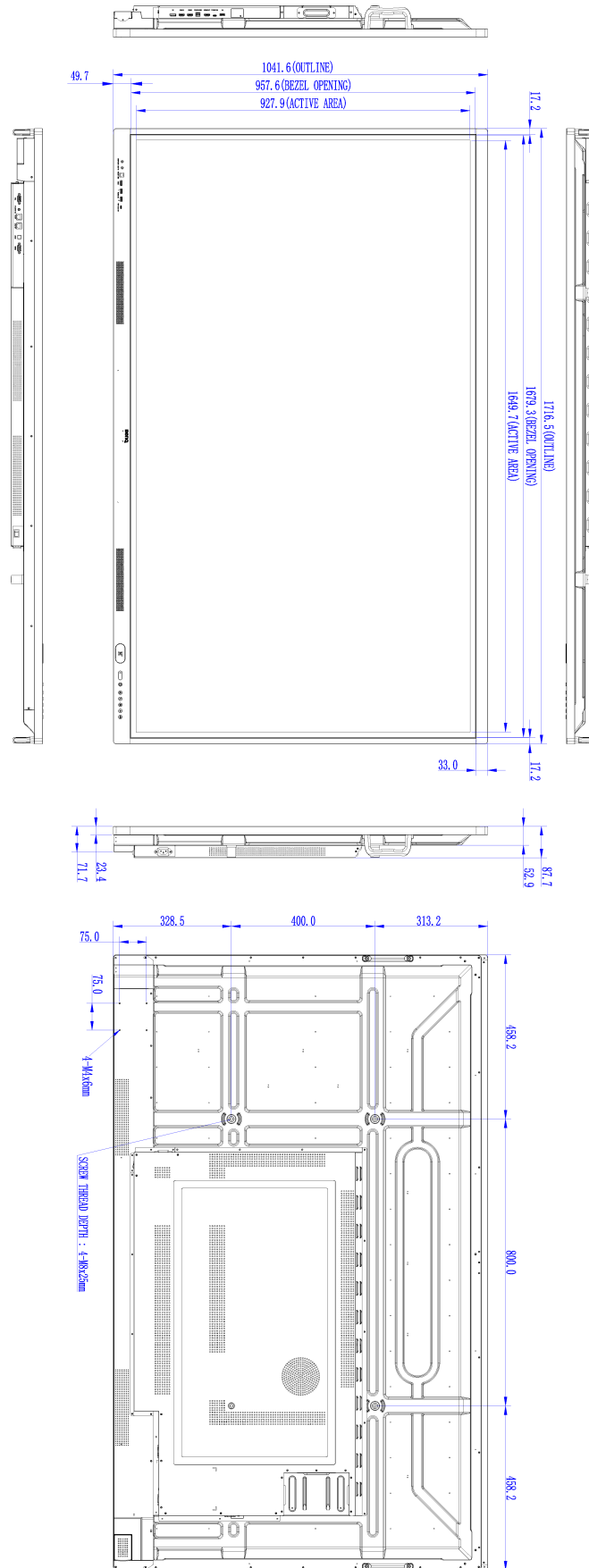

Unit: mm

Dimensions (RE8604F)

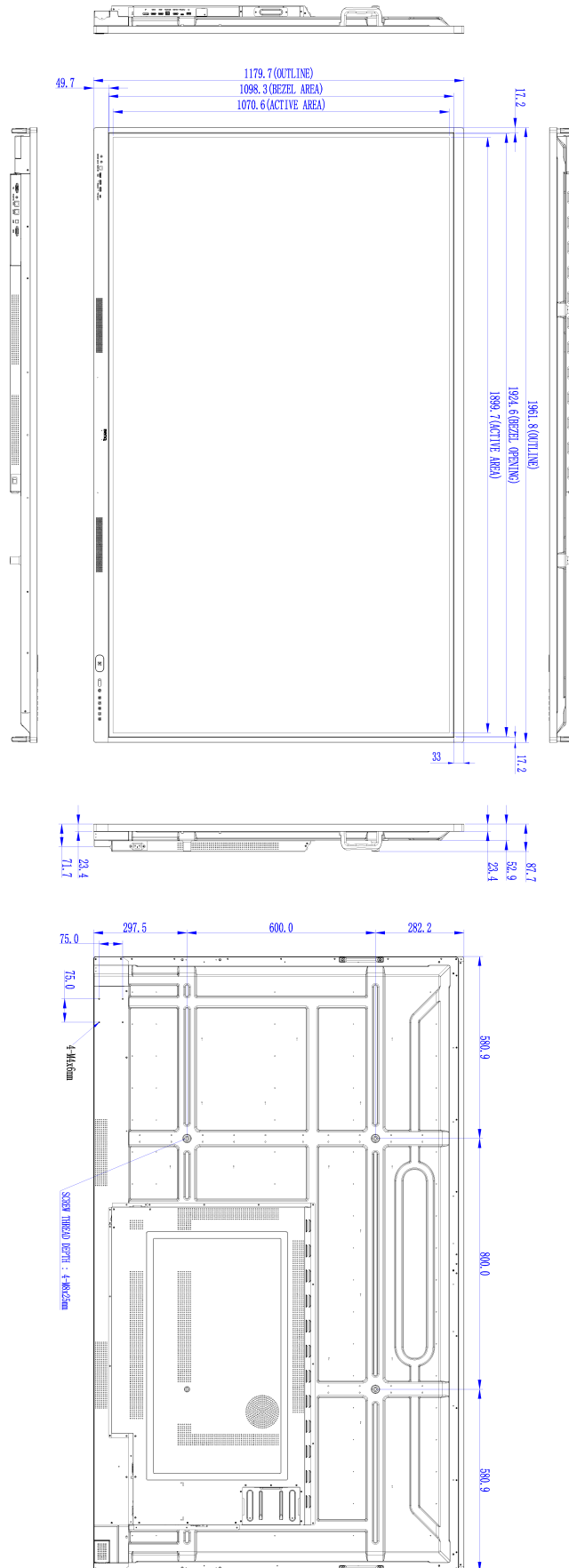

Unit: mm

Dimensions (RE6504FV)

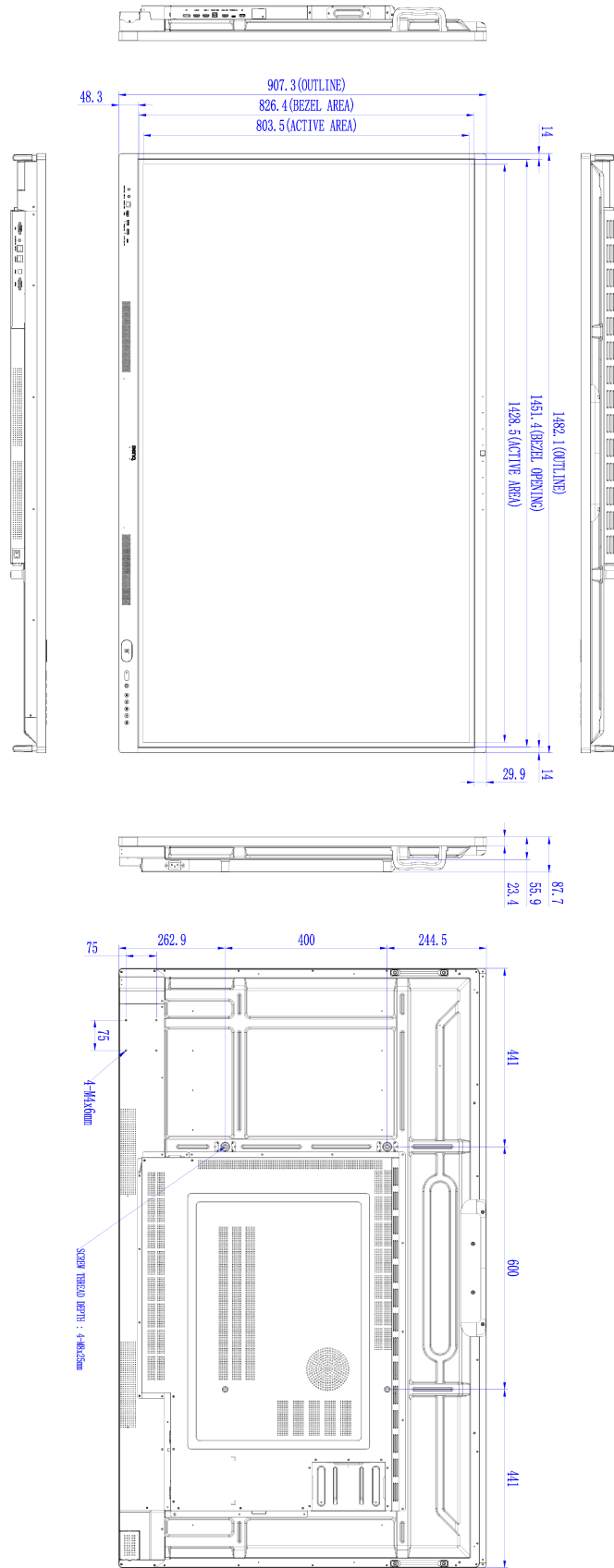

Unit: mm

Dimensions (RE7504FV)

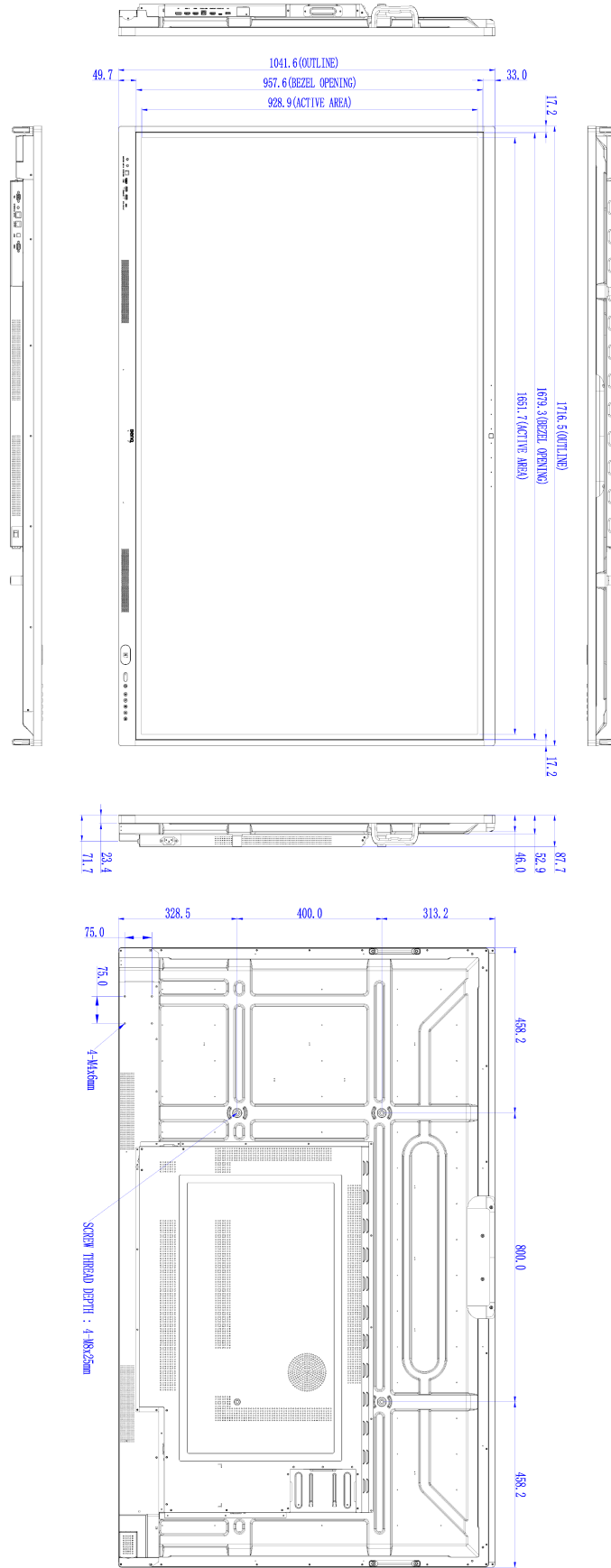

Unit: mm

Dimensions (RE8604FV)

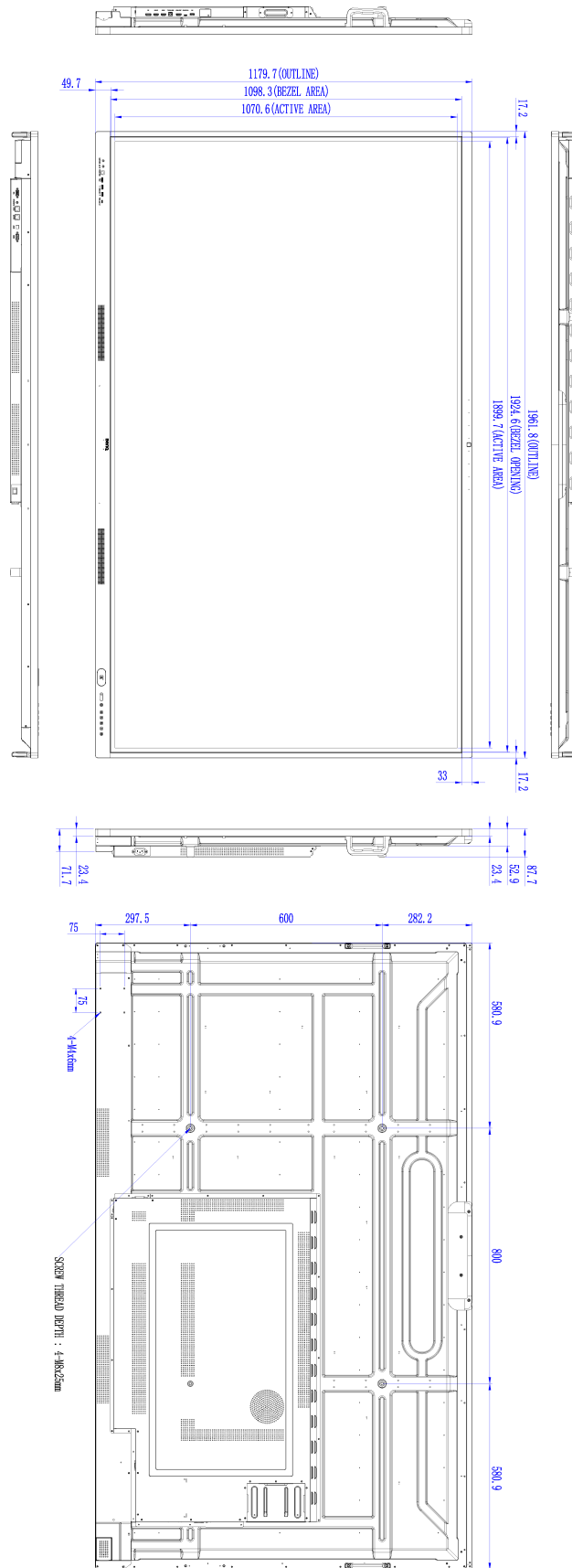

Unit: mm

Dimensions (RE9804FV)

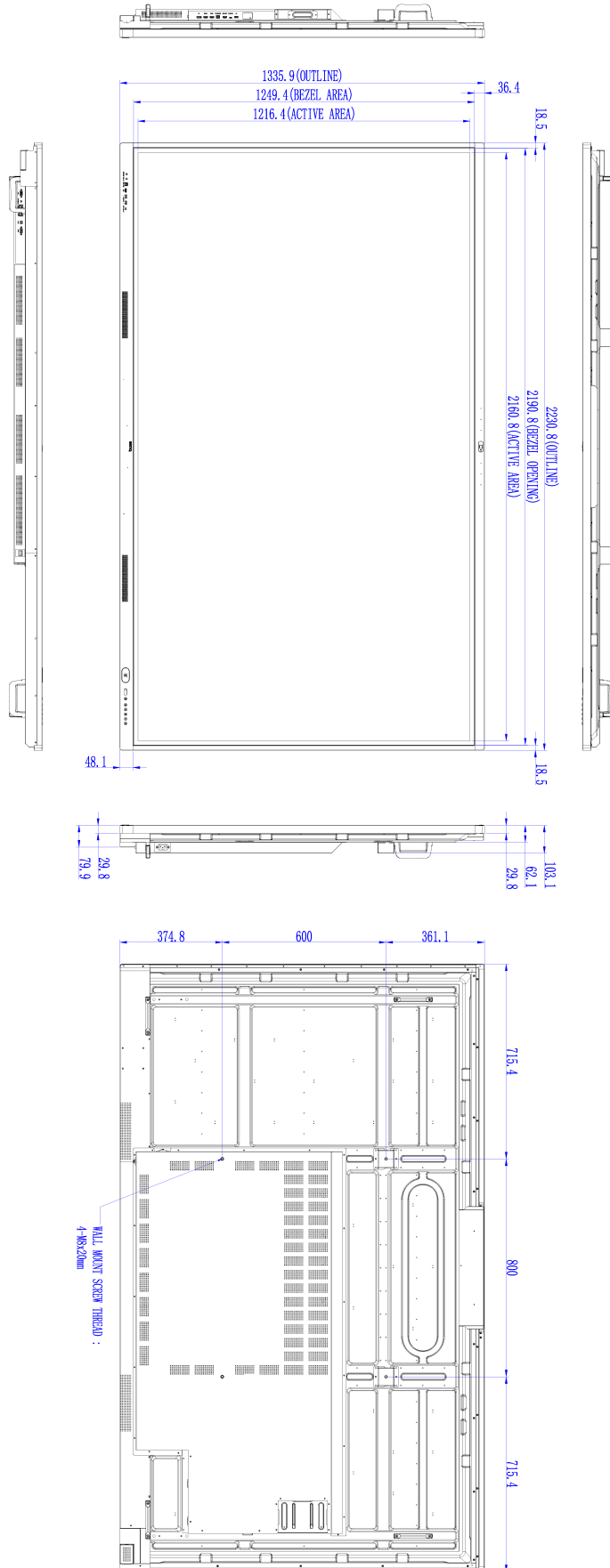

Unit: mm

Supported input signal resolution

| Resolution | Input source | | | |
|--------------------|--------------|-----|----------|----|
| | TYPE C | VGA | HDMI 2.0 | DP |
| 640 x 480 @ 60Hz | | ○ | | |
| 720 x 400 @ 85Hz | | | | |
| 800 x 600 @ 60Hz | | ○ | ○ | |
| 1024 x 768 @ 60Hz | | ○ | ○ | |
| 1280 x 768 @ 60Hz | | ○ | ○ | |
| 1280 x 960 @ 60Hz | | | ○ | |
| 1280 x 1024 @ 60Hz | | ○ | ○ | |
| 1360 x 768 @ 60Hz | | ○ | ○ | |
| 1366 x 900 @ 60Hz | | ○ | ○ | |
| 1680 x 1050 @ 60Hz | | ○ | ○ | |
| 1920 x 1080 @ 60Hz | ○ | ○ | ○ | ○ |
| 3840 x 2160 @ 24Hz | ○ | | ○ | ○ |
| 3840 x 2160 @ 25Hz | ○ | | ○ | ○ |
| 3840 x 2160 @ 30Hz | ○ | | ○ | ○ |
| 3840 x 2160 @ 50Hz | ○ | | ○ | ○ |
| 3840 x 2160 @ 60Hz | ○ | | ○ | ○ |
| 480i (60Hz) | | | ○ | ○ |
| 480p (60Hz) | | | ○ | ○ |
| 576i (50Hz) | | | ○ | ○ |
| 576p (50Hz) | | | ○ | ○ |
| 720p (50Hz) | | | ○ | ○ |
| 720p (60Hz) | | | ○ | ○ |
| 1080i (50Hz) | | | ○ | ○ |
| 1080i (60Hz) | | | ○ | ○ |
| 1080p (50Hz) | | | ○ | ○ |
| 1080p (60Hz) | | | ○ | ○ |



- ○ : supported
- Blank: not supported

Troubleshooting

| Problem | Solution |
|---|---|
| No picture | <p>Check the following:</p> <ul style="list-style-type: none"> • Is the display turned on? Check the power indicator of the display. • Is the signal source device turned on? Turn on the device and try again. • Are there any loose cable connections? Make sure that all cables are connected firmly. • Have you chosen an unsupported output resolution on the computer? Refer to Supported input signal resolution on page 53 to select a supported resolution and try again. • Have you chosen an unsupported output resolution on the DVD or Blu-ray disc player? Refer to Supported input signal resolution on page 53 to select a supported resolution and try again. |
| No sound | <p>Check the following:</p> <ul style="list-style-type: none"> • Have you turned on the mute function on the display or the input source device? Turn off the mute function or increase the audio volume level and try again. • Are there any loose cable connections? Make sure that all cables are connected firmly. |
| The computer input image looks strange. | <ul style="list-style-type: none"> • Have you chosen an unsupported output resolution on the computer? Refer to Supported input signal resolution on page 53 to select a supported resolution and try again. • Use the Auto adjust function (VGA only) to let the display automatically optimize the display of computer image. • If the result of the Auto adjust function is not satisfactory, use the Phase, H position, and V position functions to manually adjust the image. • Go to Display > Advanced settings > EDID. Set EDID to 1.4 and try again. |
| The control panel buttons do not work. | <p>Have you locked the control panel buttons? Unlock the buttons and try again.</p> |
| The remote control does not work. | <ul style="list-style-type: none"> • Have you locked the remote control function? Unlock the function and try again. • Check for incorrect battery orientation. • Check for dead batteries. • Check your distance and angle from the display. • Check whether remote control is properly being pointed at the display's remote control sensor window. • Check for any obstacle between the remote control and the remote control sensor window. • Check that the remote control sensor window is not under strong fluorescent lighting, or in direct sunlight. • Check for any devices (computer or personal digital assistant, PDA) nearby that transmit infrared signals which may cause interference to signal transmission between the remote control and the display. Turn off the infrared function of these devices. |

| Problem | Solution |
|--|--|
| Remote control failure | <ul style="list-style-type: none"> • Check whether there are other objects between remote control and television remote control receiving window, thus leading to failure of remote control. • Check whether the battery electrode in the remote control is correct. • Check whether remote control needs to replace battery. |
| Machine automatically shutdown. | <ul style="list-style-type: none"> • Whether set sleep or not. • Check whether there is sudden power outage. • Check whether there is no signal automatic shutdown. |
| Signal out of range | <ul style="list-style-type: none"> • Check whether display is set correctly. • Check whether resolution is the best resolution. • Adjust line and field synchronization in menu. |
| Background has vertical lines or streaks. | <ul style="list-style-type: none"> • Select automatic correction in menu. • Adjust clock and phase position in menu. |
| Image lack of color, color is incorrect | <ul style="list-style-type: none"> • Check whether VGA is not well connected or has quality problem. • Adjust chromaticity and brightness or contrast in menu. |
| Display format that is not supported. | <ul style="list-style-type: none"> • Select automatic correction in menu. • Adjust clock and phase position in menu. |
| Touch function invalid | <ul style="list-style-type: none"> • Check whether touch driver is installed and started. • Check whether the size of article touched is comparable with finger. |
| Touch positioning not correct | <ul style="list-style-type: none"> • Check whether driver is properly installed and make correction. • Check whether touch pen is facing the screen. |
| With horizontal or vertical stripes or image dithering | <ul style="list-style-type: none"> • Check whether signal wire is well connected. • Check whether other electronic equipment or power tools are placed around the machine. |
| No color, color is weak or image is weak | <ul style="list-style-type: none"> • Adjust chromaticity and brightness or contrast in menu. • Check whether signal wire is well connected. |
| With image but without sound | <ul style="list-style-type: none"> • Check whether mute button is pressed for mute. • Press VOL+/VOL- to adjust volume. • Check whether audio line is connected correctly. |
| Only one speaker has sound | <ul style="list-style-type: none"> • Adjust sound balance in menu. • Check whether computer sound control panel only sets up one sound channel. • Check whether audio line is connected correctly. |
| VGA output without sound | <ul style="list-style-type: none"> • Check whether the external device is connected with a headphone cable. |