



Maintenance and Service Guide

HP EliteBook 8 G1i 13 inch Notebook AI PC

SUMMARY

This guide provides maintenance information about such topics as spare parts, removal and replacement of parts, security, and backing up.

Legal information

© Copyright 2025 HP Development Company, L.P.

AMD is a trademark of Advanced Micro Devices, Inc. Bluetooth is a trademark owned by its proprietor and used by HP Inc. under license. Chrome is a trademark of Google LLC. Intel, Core, Thunderbolt, and vPro are trademarks of Intel Corporation or its subsidiaries in the U.S. and/or other countries. Microsoft and Windows are either registered trademarks or trademarks of Microsoft Corporation in the United States and/or other countries. NVIDIA is a trademark and/or registered trademark of NVIDIA Corporation in the U.S. and other countries. microSD is a trademark or registered trademark of SD-3C LLC. USB Type-C, USB-C, and the USB 5 Gbps and USB 10 Gbps port logos are trademarks or registered trademarks of USB Implementers Forum. DisplayPort and the DisplayPort logo are trademarks owned by the Video Electronics Standards Association (VESA) in the United States and other countries. Wi-Fi is a registered trademark of Wi-Fi Alliance.

The information contained herein is subject to change without notice. The only warranties for HP products and services are set forth in the express warranty statements accompanying such products and services. Nothing herein should be construed as constituting an additional warranty. HP shall not be liable for technical or editorial errors or omissions contained herein.

First Edition: April 2025

Document Part Number: P36424-001

Product notice

This guide describes features that are common to most models. Some features may not be available on your computer.

Not all features are available in all editions or versions of Windows. Systems may require upgraded and/or separately purchased hardware, drivers, software or BIOS update to take full advantage of Windows functionality. Windows is automatically updated, which is always enabled. High-speed internet and Microsoft account required. ISP fees may apply and additional requirements may apply over time for updates. See <http://www.microsoft.com>.

If your product ships with Windows in S Mode: Windows in S Mode works exclusively with apps from the Microsoft Store within Windows. Certain default settings, features, and apps cannot be changed. Some accessories and apps that are compatible with Windows may not work (including some antivirus, PDF writers, driver utilities, and accessibility apps), and performance may vary, even if you switch out of S Mode. If you switch to Windows, you cannot switch back to S Mode. Learn more at Windows.com/SmodeFAQ.

To access the latest user guides, go to <http://www.hp.com/support>, and follow the instructions to find your product. Then select **Setup & User Guides**.

To help us improve this document, please send any suggestions, comments, or errors to <mailto:hp.doc.feedback@hp.com>. Include the document part number when submitting your feedback.

Software terms

By installing, copying, downloading, or otherwise using any software product preinstalled on this computer, you agree to be bound by the terms of the HP End User License Agreement (EULA). If you do not accept these license terms, your sole remedy is to return the entire unused product (hardware and software) within 14 days for a full refund subject to the refund policy of your seller.

For any further information or to request a full refund of the price of the computer, please contact your seller.

Safety warning notice

Reduce the possibility of heat-related injuries or of overheating the computer by following the practices described.

-
- ⚠ WARNING!** To reduce the possibility of heat-related injuries or of overheating the mobile computer, do not place the mobile computer directly on your lap or obstruct the computer air vents. Use the mobile computer only on a hard, flat surface. Do not allow another hard surface, such as an adjoining optional printer; or a soft surface, such as pillows or rugs or clothing, to block airflow. Also, do not allow the AC adapter to contact the skin or a soft surface, such as pillows or rugs or clothing, during operation. The computer and AC adapter provided by HP comply with the user-accessible surface temperature limits defined by applicable safety standards.
-

Important notice about Customer Self-Repair parts

Your computer includes Customer Self-Repair parts and parts that should be accessed only by an authorized service provider.



IMPORTANT: See [Removal and replacement procedures for Customer Self-Repair parts on page 36](#) for details.

Accessing parts described in [Removal and replacement procedures for authorized service provider parts on page 50](#) can damage the computer or void your warranty.

Table of contents

1 Product description	1
2 Components	5
Right.....	5
Left.....	6
Display	7
Low blue light mode (select products only).....	7
Keyboard area.....	9
Touchpad	9
Touchpad settings	9
Adjusting touchpad settings.....	9
Turning on the touchpad	9
Touchpad components	10
Lights	10
Power button and fingerprint reader.....	12
Special keys.....	13
Bottom	14
Labels	15
3 Illustrated parts catalog	17
Computer major components.....	17
Display assembly subcomponents.....	21
Miscellaneous parts.....	23
4 Removal and replacement procedures preliminary requirements	27
Tools required	27
Service considerations.....	27
Plastic parts.....	27
Cables and connectors.....	27
Drive handling	27
Electrostatic discharge information.....	28
Generating static electricity.....	28
Preventing electrostatic damage to equipment.....	29
Personal grounding methods and equipment.....	29
Grounding the work area.....	30
Recommended materials and equipment.....	30
Cleaning your computer	31
Enabling HP Easy Clean (select products only).....	31
Removing dirt and debris from your computer.....	31
Cleaning your computer with a disinfectant.....	32
Caring for wood veneer (select products only)	33

Packaging and transporting guidelines.....	33
Accessing support information.....	33
5 Removal and replacement procedures for Customer Self-Repair parts.....	36
Component replacement procedures.....	36
Preparation for disassembly.....	36
Bottom cover.....	36
Battery.....	39
Removing and reinstalling the same battery.....	39
Installing a new battery.....	40
WLAN module.....	45
WWAN module.....	46
Solid-state drive.....	48
6 Removal and replacement procedures for authorized service provider parts.....	50
Component replacement procedures.....	50
Speakers.....	50
Touchpad.....	51
NFC module.....	52
Fan.....	53
Heat sink.....	54
Left and right I/O frames.....	55
Audio jack.....	57
Smart card reader.....	58
System board.....	59
Display assembly.....	62
Power button/fingerprint reader.....	68
Power button (no fingerprint reader).....	68
Keyboard removal.....	69
Keyboard.....	70
7 Backing up, restoring, and recovering.....	72
Backing up information and creating recovery media.....	72
Using Windows tools for backing up.....	72
Using the HP Cloud Recovery Download Tool to create a recovery USB flash drive (select products only).....	72
Restoring and recovering your system.....	72
Creating a system restore.....	73
Restoring and recovery methods.....	73
Recovering using the HP Recovery USB flash drive.....	73
Changing the computer boot order.....	74
Using HP Sure Recover (select products only).....	74
8 Computer Setup (BIOS), TPM, and HP Sure Start.....	75
Using Computer Setup.....	75
Navigating and selecting in Computer Setup.....	75
Restoring factory settings in Computer Setup.....	75
Updating the BIOS.....	76
Determining the BIOS version.....	76

Preparing for a BIOS update	76
Downloading a BIOS update	77
Installing a BIOS update	77
Changing the boot order using the f9 prompt	78
TPM BIOS settings (select products only)	78
Using HP Sure Start (select products only).....	78
9 Using HP PC Hardware Diagnostics	79
Using HP PC Hardware Diagnostics Windows (select products only).....	79
Using an HP PC Hardware Diagnostics Windows hardware failure ID code.....	79
Accessing HP PC Hardware Diagnostics Windows	79
Accessing HP PC Hardware Diagnostics Windows from HP Support Assistant.....	79
Accessing HP PC Hardware Diagnostics Windows from the Start menu (select products only).....	80
Downloading HP PC Hardware Diagnostics Windows	80
Downloading the latest HP PC Hardware Diagnostics Windows version from HP.....	80
Downloading the HP PC Hardware Diagnostics Windows from the Microsoft Store.....	80
Downloading HP Hardware Diagnostics Windows by product name or number (select products only)	81
Installing HP PC Hardware Diagnostics Windows.....	81
Using HP PC Hardware Diagnostics UEFI	81
Using an HP PC Hardware Diagnostics UEFI hardware failure ID code.....	81
Starting HP PC Hardware Diagnostics UEFI	81
Starting HP PC Hardware Diagnostics UEFI through HP Hotkey Support software (select products only).....	82
Downloading HP PC Hardware Diagnostics UEFI to a USB flash drive	82
Downloading the latest HP PC Hardware Diagnostics UEFI version	83
Downloading HP PC Hardware Diagnostics UEFI by product name or number (select products only)	83
Using Remote HP PC Hardware Diagnostics UEFI settings (select products only).....	83
Downloading Remote HP PC Hardware Diagnostics UEFI	83
Downloading the latest Remote HP PC Hardware Diagnostics UEFI version	83
Downloading Remote HP PC Hardware Diagnostics UEFI by product name or number.....	84
Customizing Remote HP PC Hardware Diagnostics UEFI settings.....	84
10 Specifications	85
Computer specifications	85
Display specifications.....	85
Solid-state drive specifications	86
11 Statement of memory volatility	88
Current BIOS steps	88
Nonvolatile memory usage	90
Questions and answers	91
12 Power cord set requirements.....	93
Requirements for all countries	93
Requirements for specific countries and regions.....	93

13 Swelling or deformation of notebook battery	96
Swollen notebook batteries.....	96
Swollen battery is not a safety issue.....	96
Discontinue using a swollen battery.....	96
Replace a swollen battery.....	96
Minimize battery swelling.....	96
HP Adaptive Battery Optimizer (consumer notebooks).....	97
HP Battery Health Manager (commercial notebooks).....	97
14 Recycling	98
Index	99

1 Product description

This table provides detailed product information.

Table 1-1 Product components and their descriptions

Category	Description
Product Name	HP EliteBook 8 G1i 13 inch Notebook AI PC
Processors	Intel® Core™ Ultra processors (Series 2) Intel Core Ultra 7 265U with Intel vPro® Enterprise (up to 5.3 GHz with Intel Turbo Boost Technology, 12 MB Intel Smart Cache, 12 cores, 15 W) Intel Core Ultra 7 255U (up to 5.2 GHz with Intel Turbo Boost Technology, 12 MB Intel Smart Cache, 12 cores, 15 W) Intel Core Ultra 5 235U with Intel vPro Enterprise (up to 4.9 GHz with Intel Turbo Boost Technology, 12 MB Intel Smart Cache, 12 cores, 15 W) Intel Core Ultra 5 225U (up to 4.8 GHz with Intel Turbo Boost Technology, 12 MB Intel Smart Cache, 12 cores, 15 W)
Graphics	Unified memory architecture (UMA) Intel integrated Soldered-on-Circuit (SoC)
Display	33.8 cm (13.3 in), WUXGA (1920 × 1200), liquid crystal display (LCD) bent panel, ultrawide viewing angle (UWVA), antiglare Touch-on-panel (TOP), WLED, eDP 1.2 w/o panel self-refresh (PSR), sRGB 62.5%; typical brightness: 300 nits Low blue light (LBL), nontouchscreen, sRGB 100%, eDP1.4 + PSR, HP SureView5, ambient light sensor (ALS) + ambient color sensor (ACS); typical brightness: 800 nits WLED + LBL, nontouchscreen, low power, sRGB 100%, eDP 1.4 + PSR2, ACS; typical brightness: 400 nits LED, nontouchscreen, sRGB 62.5%, eDP 1.2 w/o PSR; typical brightness: 300 nits
Memory	Low-power double data rate (LPDDR5X)-8533 and (LPDDR5X)-7500 support <ul style="list-style-type: none">• 64 GB LPDDR5X-8533 MTps (onboard)• 32 GB LPDDR5X-7500 MTps (onboard)• 16 GB LPDDR5X-7500 MTps (onboard)

Table 1-1 Product components and their descriptions (continued)

Category	Description	
Storage: solid-state drive	Solid-state drives (SSD), PCIe/PCIe-4 × 4, NVMe, M.2 2280	
	<ul style="list-style-type: none"> • 2 TB, PCIe-4 × 4, triple-layer cell (TLC) • 1 TB, PCIe-4 × 4, TLC • 1 TB value, PCIe-4 × 4 • 1 TB value, PCIe • 512 GB, PCIe-4 × 4, TLC • 512 GB, PCIe-4 × 4, self-encrypted OPAL2, TLC • 512 GB value, PCIe • 256 GB value, PCIe, self-encrypted OPAL2 • 256 GB value, PCIe 	
	Audio and video	Poly Studio
		Dual speakers
		HP 5 MP Camera: indicator LED, 1 × infrared (IR) LED, wide field-of-view (WFOV)
		Dual-array digital microphone with appropriate software: beam forming, echo cancellation, noise suppression
	Wireless	Wireless Local Area Network (WLAN)
		Intel Wi-Fi® 7 BE201 + Bluetooth® 5.4, vPro worldwide (WW) WLAN
		Intel Wi-Fi 7 BE201 Bluetooth 5.4, non-vPro WW WLAN
Intel AX211 Wi-Fi 6E Bluetooth 5.3, vPro WW WLAN		
Intel AX211 Wi-Fi 6E Bluetooth 5.3, non-vPro WW WLAN		
Wireless Wide Area Network (WWAN)		
HP 5G Sub-6 Cat 19 WWAN eSIM		
HP 4G LTE Cat19 WWAN eSIM		
Qualcomm 9205 LTE-M (CAT-M1)		
Media card reader		Nano SIM card: Supports microSD™ (optional)
	Smart Card reader (optional)	
	Push-push insertion/removal	
Ports	Hot plug/unplug and autodetect for correct output to wide-aspect vs. standard aspect video	
	Audio-out (headphone)/Audio-in (microphone) combo jack (left side)	
	High-definition multimedia interface (HDMI) 2.1 out up to 4 K @ 60 Hz (left side)	
	Smart Card Reader (optional) (left side)	
	USB4 Type-C® Thunderbolt™ 4 ports (2) (left side), support:	
	<ul style="list-style-type: none"> - DisplayPort™ 2.1 - Power delivery 	

Table 1-1 Product components and their descriptions (continued)

Category	Description
	USB 3.2 Gen 2 Type-C (right side)
	- Power delivery
	- DisplayPort 1.4
	USB 3.2 Gen1 Type A (right side)
	Nano SIM card slot (optional) (right side)
	Security lock slot (right side)
Keyboard/pointing devices	Keyboard: Island-style notebook PC keyboard with touchpad in glacier silver finish with soft gray keys, spill-resistant
	Full size, backlit, island style
	Full size, not backlit, island style
	Full size, not backlit, privacy, island style
	Touchpad
	Clickpad
	Multitouch gestures enabled
	Precision touchpad support
	Taps enabled as default
Power requirements	Battery
	3 cell, 62 Whr, polymer battery, HP Long Life
	HP Fast Charge Technology
	AC adapters - non-Power Factor Correction (nPFC)
	100 W, slim barrel, USB Type-C
	65 W, standard, USB Type-C
	65 W, USB Type-C, GaN
	65 W, slim, USB Type-C, halogen-free
	Power cord
	C5, 1.0 m (3.3 ft), conventional with sticker and C5, 1.0 m (3.3 ft), premium with sticker
Security	Supports Trusted Platform Module (TPM) 2.0, firmware based
	Privacy camera shutter door
	Kensington Nano security lock
	Microphone mute
	Integrated fingerprint reader
Operating system	Windows® 11 Pro
	Windows 11 Pro Education
	Windows 11 Home - HP recommends Windows 11 Pro for Business

Table 1-1 Product components and their descriptions (continued)

Category	Description
	Windows 11 Home Single Language - HP recommends Windows 11 Pro for Business
	Windows 11 Pro (Windows 11 Enterprise available with a Volume Licensing Agreement)
	FreeDOS
Serviceability	End user replaceable parts
	AC adapter
	Base enclosure
	Solid-state drive (SSD)
	WLAN module
	WWAN module

2 Components

Your computer features top-rated components. This chapter provides details about your components, where they are located, and how they work.

Right

Use one of the following illustrations and tables to identify the components on the right side of the computer.

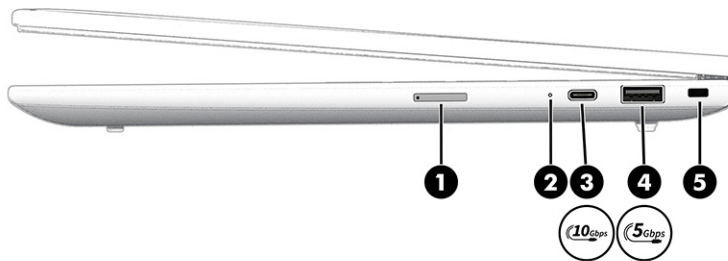

Table 2-1 Right-side components and their descriptions



	Component	Description
(1)	Nano SIM card slot (select products only)	Supports optional Nano SIM cards.
(2)	Battery light	When AC power is connected: <ul style="list-style-type: none">• White: The battery charge is greater than 90 percent.• Amber: The battery charge is from 0 to 90 percent.• Off: The battery is not charging. When AC power is disconnected (battery not charging): <ul style="list-style-type: none">• Blinking amber: The battery has reached a low battery level. When the battery has reached a critical battery level, the battery light begins blinking rapidly.• Off: The battery is not charging.
(3)	 USB Type-C® 10 Gbps port	Connects a USB device, provides high-speed data transfer, and (for select products) charges small devices (such as a smartphone) when the computer is on or in sleep mode. NOTE: Use a standard USB Type-C charging cable or cable adapter (purchased separately) when charging a small external device.
(4)	 USB 5 Gbps port	Connects a USB device and provides high-speed data transfer. NOTE: The port does not provide charging capability.

Table 2-1 Right-side components and their descriptions (continued)

	Component	Description
(5)	 Security cable slot	Attaches an optional security cable to the computer. NOTE: The security cable is designed to act as a deterrent, but it might not prevent the computer from being mishandled or stolen.

Left

Use the illustration and table to identify the components on the left side of the computer.

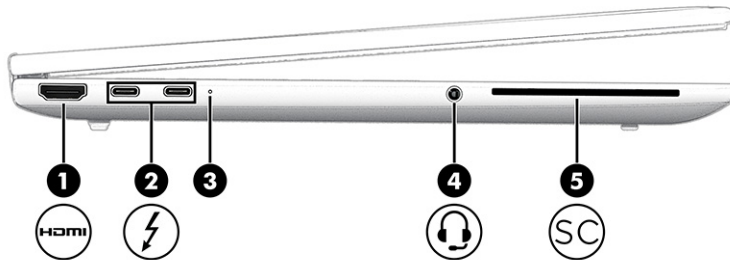

Table 2-2 Left-side components and their descriptions





	Component	Description
(1)	 HDMI port	Connects an optional video or audio device, such as a high-definition television, any compatible digital or audio component, or a high-speed High Definition Multimedia Interface (HDMI) device.
(2)	 USB Type-C power connectors and Thunderbolt™ ports with HP Sleep and Charge and DisplayPort™ output (2)	Connect an AC adapter that has a USB Type-C connector, supplying power to the computer and, if needed, charging the computer battery. - and - Connect USB devices, provide high-speed data transfer, and charge small devices (such as a smartphone). NOTE: Use a standard USB Type-C charging cable or cable adapter (purchased separately) when charging a small external device. - and - Connect a display device that has a USB Type-C connector, providing DisplayPort output. NOTE: Your computer might also support a Thunderbolt docking station.

Table 2-2 Left-side components and their descriptions (continued)

	Component	Description
(3)	Battery light	<p>When AC power is connected:</p> <ul style="list-style-type: none"> • White: The battery charge is greater than 90 percent. • Amber: The battery charge is from 0 to 90 percent. • Off: The battery is not charging. <p>When AC power is disconnected (battery not charging):</p> <ul style="list-style-type: none"> • Blinking amber: The battery has reached a low battery level. When the battery has reached a critical battery level, the battery light begins blinking rapidly. • Off: The battery is not charging.
(4)	 Audio-out (headphone)/Audio-in (microphone) combo jack	<p>Connects optional powered stereo speakers, headphones, earbuds, a headset, or a television audio cable. Also connects an optional headset microphone. This jack does not support optional standalone microphones.</p> <p>WARNING! To reduce the risk of personal injury, adjust the volume before putting on headphones, earbuds, or a headset. For additional safety information, see the <i>Regulatory, Safety, and Environmental Notices</i>.</p> <p>To access this guide:</p> <ul style="list-style-type: none"> ■ Select the Search icon in the taskbar, type HP Documentation in the search box, and then select HP Documentation. <p>NOTE: When a device is connected to the jack, the computer speakers are disabled.</p>
(5)	 Smart card reader	Supports optional smart cards.

Display

Use the following illustration and table to identify the display components.

Low blue light mode (select products only)

Your computer display is shipped from the factory in low blue light mode for improved eye comfort and safety. Also, blue light mode automatically adjusts blue light emissions when you are using the computer at night or for reading.

⚠ WARNING! To reduce the risk of serious injury, read the *Safety & Comfort Guide*. It describes proper workstation setup and proper posture, health, and work habits for computer users. The *Safety & Comfort Guide* also provides important electrical and mechanical safety information. The *Safety & Comfort Guide* is available on the web at <http://www.hp.com/ergo>.

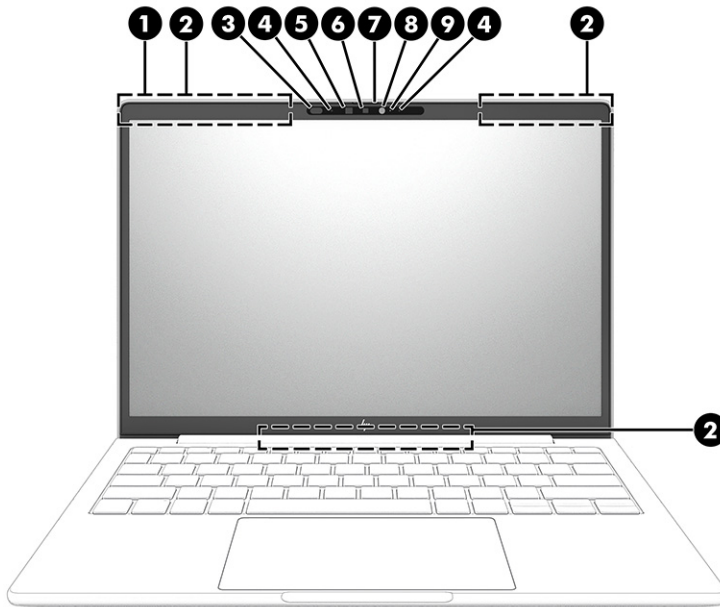



Table 2-3 Display components and their descriptions

	Component	Description
(1)	WLAN antenna	Sends and receives wireless signals to communicate with wireless local area networks (WLANs).
(2)	WWAN antennas (select products only)	Send and receive wireless signals to communicate with wireless local area networks (WWANs).
(3)	Ambient light and color sensor	Adjusts the brightness of the display, depending on the ambient light, and manages and controls the color temperature. Color temperature enables you to measure and adjust the warmth or coolness of the light source
(4)	Internal microphones (2)	Record sound.
(5)	Infrared camera	Allows you to video chat, record video, and record still images. Some cameras also allow a facial recognition logon to Windows, instead of a password logon. NOTE: Camera functions vary depending on the camera hardware and software installed on your product.
(6)	Web camera	Allows you to video chat, record video, and record still images. Some cameras also allow a facial recognition logon to Windows, instead of a password logon. NOTE: Camera functions vary depending on the camera hardware and software installed on your product.
(7)	Camera privacy cover (select products only)	By default, the camera lens is uncovered, but you can slide the camera privacy cover to block the camera's view. To use the camera, slide the camera privacy cover in the opposite direction to reveal the lens. NOTE: If you have both front-facing and rear-facing cameras, when one camera lens is revealed and ready to use, the other is concealed.

Table 2-3 Display components and their descriptions (continued)

	Component	Description
(8)	Infrared camera light	On: The camera is in use.
(9)	Webcam camera light	On: The camera is in use.

 **NOTE:** The antennas are not visible from the outside of the computer. For optimal transmission, keep the areas immediately around the antennas free from obstructions.

For wireless regulatory notices, see the section of the *Regulatory, Safety, and Environmental Notices* that applies to your country or region.

To access this guide:

- Select the **Search** icon in the taskbar, type `HP Documentation` in the search box, and then select **HP Documentation**.

Keyboard area

Keyboards can vary by language.

 **NOTE:** The keyboard, including the function keys and power key (select products only), is disabled in stand, tent, and tablet modes. To enable the keyboard, including the power key, change to the clamshell mode.

Touchpad

The touchpad settings and components are described here.

Touchpad settings

You learn how to adjust the touchpad settings and components here.

Adjusting touchpad settings

Use these steps to adjust touchpad settings and gestures.

1. Select the **Search** icon in the taskbar, type `touchpad settings` in the search box, and then press `enter`.
2. Choose a setting.

Turning on the touchpad

Follow these steps to turn on the touchpad.

1. Select the **Search** icon in the taskbar, type `touchpad settings` in the search box, and then press `enter`.
2. Using an external mouse, click the **Touchpad** button.

If you are not using an external mouse, press the **Tab** key repeatedly until the pointer rests on the **touchpad** button. Then press the `spacebar` to select the button.

Touchpad components

Use the illustration and table to identify the touchpad components.

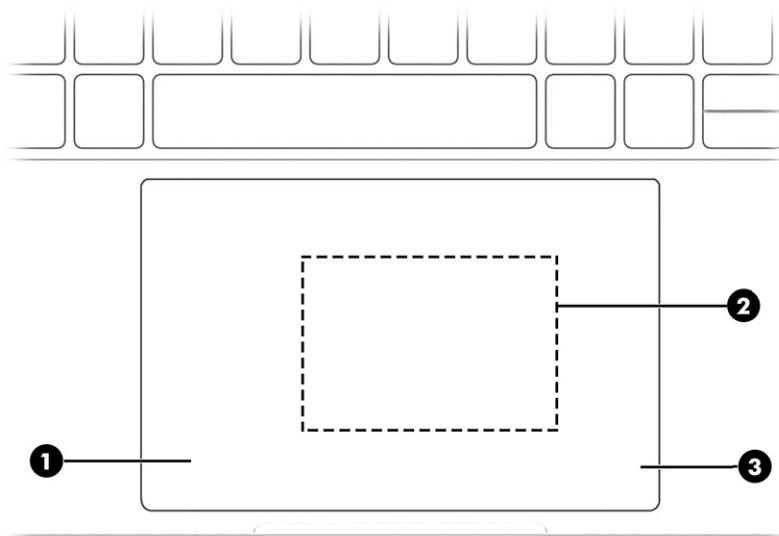

Table 2-4 Touchpad components and their descriptions

	Component	Description
(1)	Left control zone	Textured area that allows you to perform additional gestures.
(2)	Touchpad zone/Near Field Communication (NFC) location (select products only)	Reads your finger gestures to move the pointer or activate items on the screen.
(3)	Right control zone	Textured area that allows you to perform additional gestures.

Lights

Use the illustration and table to identify the lights on the computer.

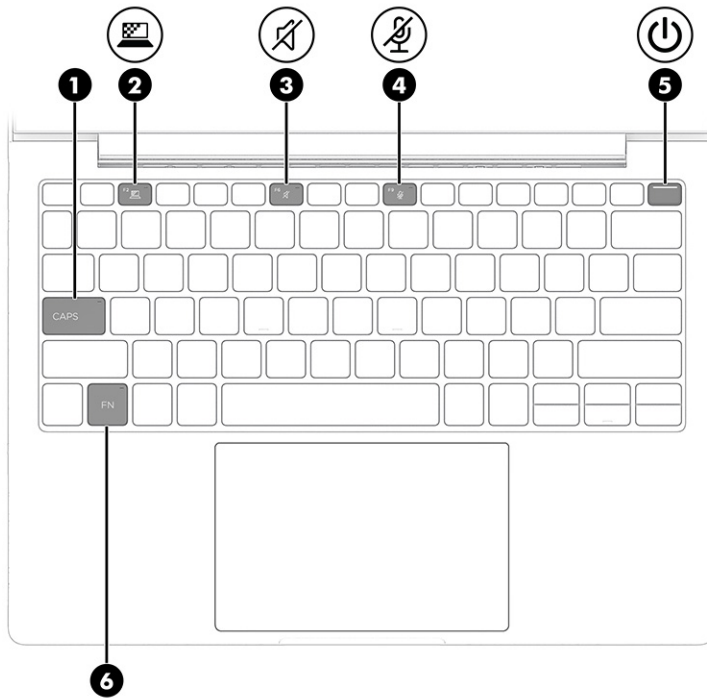







Table 2-5 Lights and their descriptions

	Component	Description
(1)	Caps lock light	On: Caps lock is on, which switches the key input to all capital letters.
(2)	 Privacy key light (select products only)	On: Privacy screen is on, which helps prevent side-angle viewing.
(3)	 Mute light	<ul style="list-style-type: none"> On: Computer sound is off. Off: Computer sound is on.
(4)	 Microphone mute light	<ul style="list-style-type: none"> On: Microphone is off. Off: Microphone is on.
(5)	 Power light	<ul style="list-style-type: none"> On: The computer is on. Blinking (select products only): The computer is in the Sleep state, a power-saving state. The computer shuts off power to the display and other unnecessary components. Off: Depending on your computer model, the computer is off, in Hibernation, or in Sleep. Hibernation is the power-saving state that uses the least amount of power.
(6)	Fn lock light	On: The fn key is locked.

Power button and fingerprint reader

The fingerprint reader is located on the power button (select products only).

-  **IMPORTANT:** To verify that your computer supports fingerprint reader sign-in, select the **Search** icon in the taskbar, type `Sign-in options` in the search box, and then select the **Sign-on options** app. If **Fingerprint recognition** is not listed as an option, then your notebook does not include a fingerprint reader.

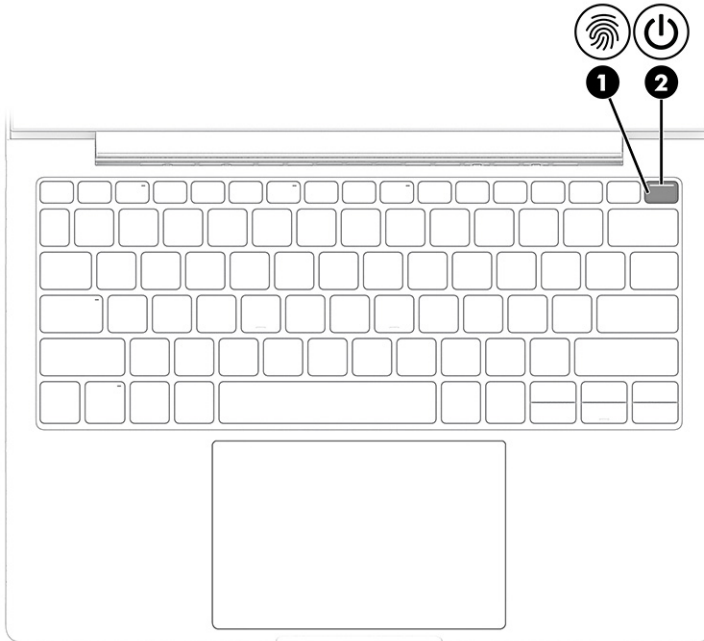



Table 2-6 Power button and fingerprint reader and their descriptions

	Component	Description
(1)	 Power button	<ul style="list-style-type: none"> When the computer is off, press the button briefly to turn on the computer. When the computer is on, press the button briefly to initiate Sleep. When the computer is in the Sleep state, press the button briefly to exit Sleep (select products only). When the computer is in Hibernation, press the button briefly to exit Hibernation. <p>IMPORTANT: Pressing and holding down the power button results in the loss of unsaved information.</p> <p>If the computer has stopped responding and shut down procedures are ineffective, press and hold the power button for at least 4 seconds to turn off the computer.</p> <p>To learn more about your power settings, use the Power icon.</p> <ul style="list-style-type: none"> Right-click the Power icon , and then select Power and sleep settings.
(2)	Fingerprint reader (select products only)	<p>Allows a fingerprint logon to Windows, instead of a password logon.</p> <ul style="list-style-type: none"> Swipe the power button. <p>IMPORTANT: To prevent fingerprint logon issues, make sure when you register your fingerprint that all sides of your finger are registered by the fingerprint reader.</p>

Special keys

Use the illustration and table to identify the special keys.

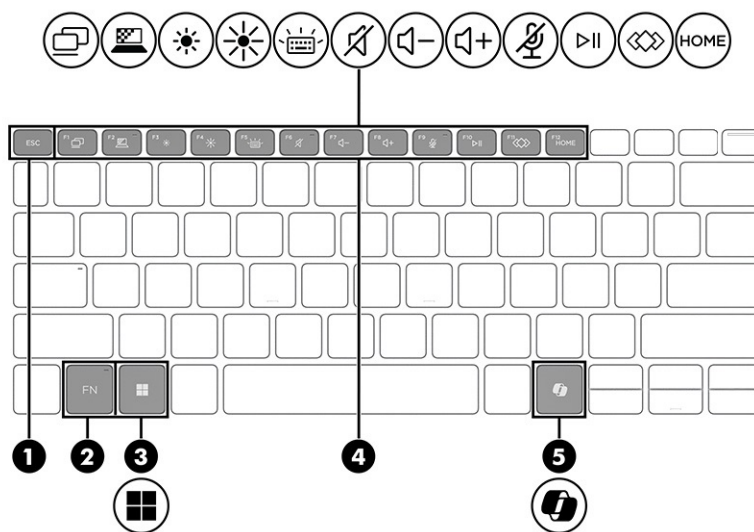



Table 2-7 Special keys and their descriptions

	Component	Description
(1)	<code>esc</code> key	Displays system information when pressed in combination with the <code>fn</code> key.
(2)	<code>fn</code> key	Executes frequently used system functions when pressed in combination with another key. Such key combinations are called <i>hot keys</i> .
(3)	Windows key	Opens the Start menu. NOTE: Pressing the Windows key again will close the Start menu.
(4)	Action keys	Execute frequently used system functions.
(5)	 Windows Copilot key	Opens Windows Copilot (select products only). NOTE: Copilot in Windows requires Windows 11. Some features require a neural processing unit. The timing of feature delivery and availability varies by market and device. You must have a Microsoft account to use the Copilot feature. Where the Copilot feature is not available, pressing the Copilot key opens the Bing search engine. See http://aka.ms/WindowsAIFeatures .

Bottom

Use the illustration and table to identify the bottom components.

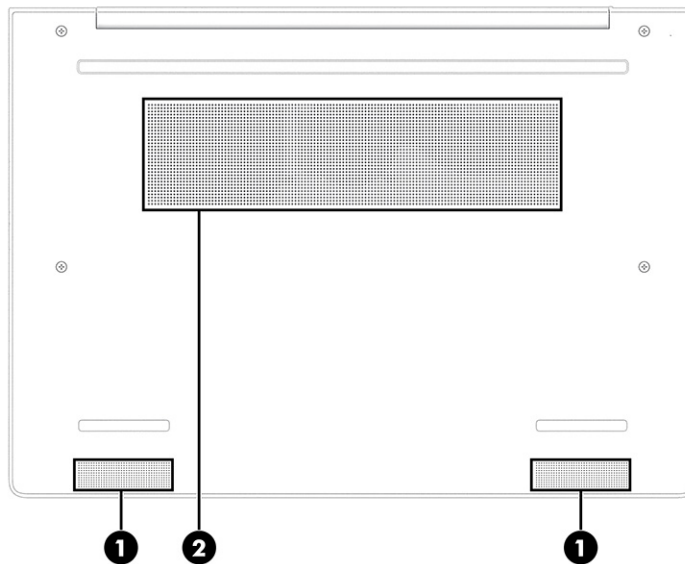

Table 2-8 Bottom components and their descriptions

	Component	Description
(1)	Speakers (2)	Produce sound.

Table 2-8 Bottom components and their descriptions (continued)

	Component	Description
(2)	Vent	Enable airflow to cool internal components. NOTE: The computer fan starts up automatically to cool internal components and prevent overheating. It is normal for the internal fan to cycle on and off during routine operation.

Labels

The labels affixed to the computer provide information you might need when you troubleshoot system problems or travel internationally with the computer. Labels might be in paper form or imprinted on the product.

 **IMPORTANT:** Check the following locations for the labels described in this section: the bottom of the computer, inside the battery bay, under the service door, on the back of the display, or on the bottom of a tablet kickstand.

- Service label—Provides important information to identify your computer. When contacting support, you might be asked for the serial number, the product number, or the model number. Locate this information before you contact support.

Your service label will resemble one of the examples shown below. Refer to the illustration that most closely matches the service label on your computer.

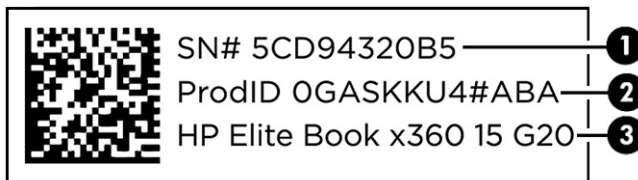

Table 2-9 Service label components

	Component
(1)	Serial number
(2)	Product ID
(3)	HP product name

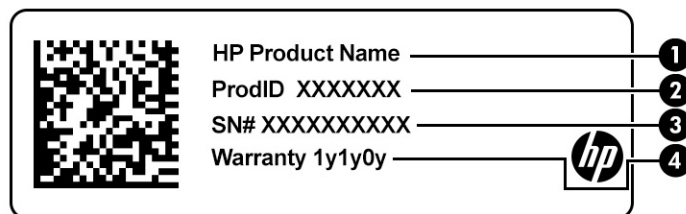

Table 2-10 Service label components

Component	
(1)	HP product name
(2)	Product ID
(3)	Serial number
(4)	Warranty period

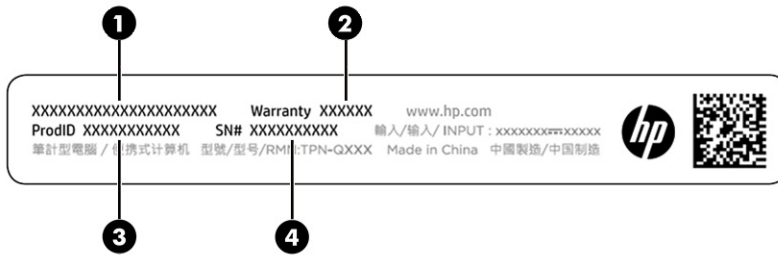

Table 2-11 Service label components

Component	
(1)	HP product name
(2)	Warranty period
(3)	Product ID
(4)	Serial number

- Regulatory labels—Provide regulatory information about the computer.
- Wireless certification labels—Provide information about optional wireless devices and the approval markings for the countries or regions in which the devices have been approved for use.

3 Illustrated parts catalog

Use this chapter to determine the spare parts that are available for the computer.

Computer major components

To identify the computer major components, use this illustration and table.

 **NOTE:** HP continually improves and changes product parts. For complete and current information about supported parts for your computer, go to <https://partsurfer.hp.com/>, select your country or region, and then follow the on-screen instructions.

 **NOTE:** Details about your computer, including model, serial number, product key, and length of warranty, are on the service tag at the bottom of your computer.

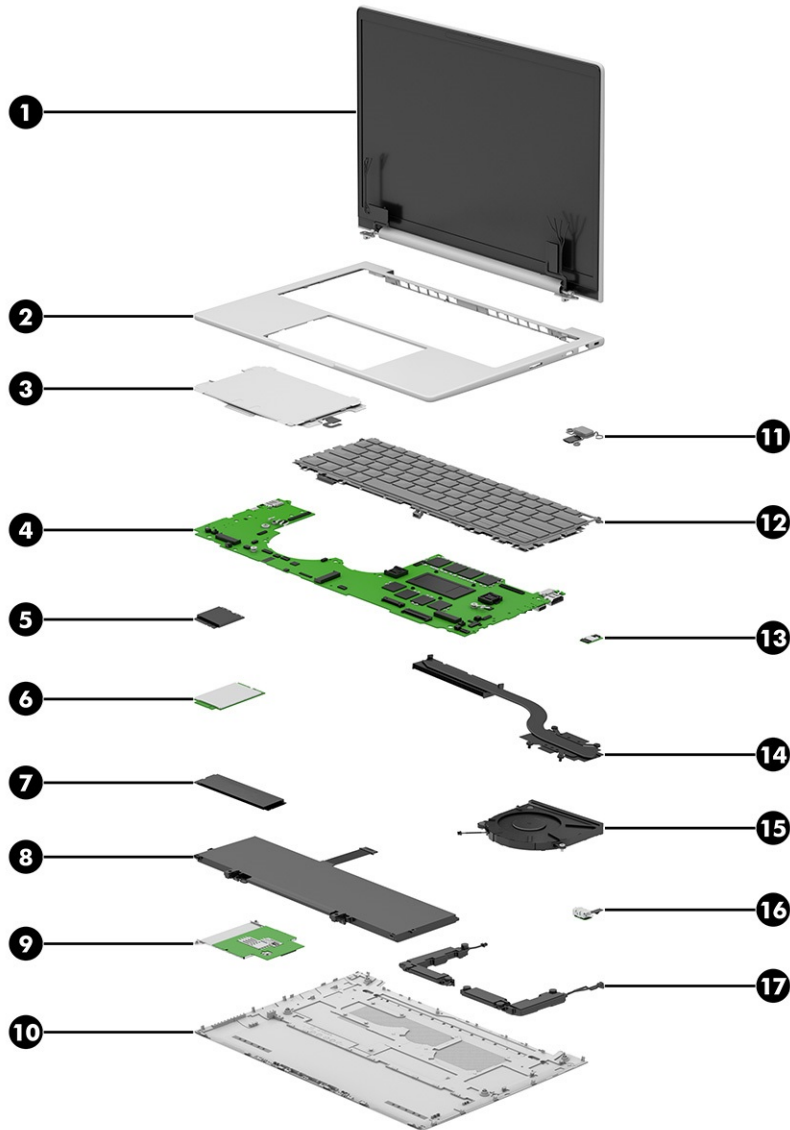

Table 3-1 Computer major component descriptions and part numbers

Item	Component	Spare part number
(1)	Display assembly NOTE: Display spare parts are available as subcomponents, not as whole units. Display subcomponent spare parts are available. For spare part information, see Display assembly subcomponents on page 21 .	not available as a spare part
(2)	Top cover	P34041-001
(3)	Touchpad	
	For use in models without NFC	P33134-001
	For use in models with NFC (includes NFC antenna)	P33135-001

Table 3-1 Computer major component descriptions and part numbers (continued)

Item	Component	Spare part number
(4)	System board (includes integrated processor)	
	NOTE: All system board spare part kits include replacement thermal material.	
	Intel Core Ultra 5 225U processor	P32685-601
	Intel Core Ultra 5 225U processor (The People's Republic of China)	P32686-601
	Intel Core Ultra 5 225U (WLAN)	P32687-601
	Intel Core Ultra 5 225U (PRC) (WLAN)	P32688-601
	Intel Core Ultra 5 225U (OSR)	P32689-601
	Intel Core Ultra 5 225U	P32690-601
	Intel Core Ultra 5 225U (PRC)	P32691-601
	Intel Core Ultra 5 225U	P32692-601
	Intel Core Ultra 5 225U (PRC)	P32693-601
	Intel Core Ultra 5 235U	P32694-601
	Intel Core Ultra 5 235U (PRC)	P32695-601
	Intel Core Ultra 5 235U (WLAN)	P32696-601
	Intel Core Ultra 5 235U (PRC, WLAN)	P32697-601
	Intel Core Ultra 5 235U (OSR)	P32698-601
	Intel Core Ultra 5 235U	P32699-601
	Intel Core Ultra 5 235U (PRC)	P32700-601
	Intel Core Ultra 5 235U (OSR)	P32701-601
	Intel Core Ultra 5 235U	P32702-601
	Intel Core Ultra 5 235U (PRC)	P32703-601
	Intel Core Ultra 5 235U (OSR)	P32704-601
	Intel Core Ultra 7 255U	P32705-601
	Intel Core Ultra 7 255U (PRC)	P32706-601
	Intel Core Ultra 7 255U (WLAN)	P32707-601
	Intel Core Ultra 7 255U (PRC, WLAN)	P32708-601
	Intel Core Ultra 7 255U (OSR)	P32709-601
	Intel Core Ultra 7 255U	P32710-601
	Intel Core Ultra 7 255U (PRC)	P32711-601
	Intel Core Ultra 7 255U	P32712-601
	Intel Core Ultra 7 255U (PRC)	P32713-601
	Intel Core Ultra 7 265U	P32714-601
	Intel Core Ultra 7 265U (PRC)	P32715-601
	Intel Core Ultra 7 265U (OSR)	P32716-601

Table 3-1 Computer major component descriptions and part numbers (continued)

Item	Component	Spare part number
	Intel Core Ultra 7 265U	P32717-601
	Intel Core Ultra 7 265U (PRC)	P32718-601
	Intel Core Ultra 7 265U (OSR)	P32719-601
	Intel Core Ultra 7 265U	P32720-601
	Intel Core Ultra 7 265U (PRC)	P32721-601
	Intel Core Ultra 7 265U (OSR)	P32722-601
(5)	WLAN module	
	Intel AX211 Wi-Fi 6E Bluetooth 5.3 vPro	M53363-001
	Intel AX211 Wi-Fi 6e Bluetooth 5.3	M53366-001
	Intel Wi-Fi 7 BE201 Bluetooth 5.4 vPro	N86465-001
	Intel Wi-Fi 7 BE201 Bluetooth 5.4	N86466-001
(6)	WWAN module	
	HP 4000 4G LTE-Advanced Pro WWAN	P06930-001
	HP 5000 5G Solution WWAN	P20951-001
	Qualcomm 9205 LTE-M (CAT-M1)	M78607-001
(7)	Solid-state drive, (M.2 2280, PCIe-4 x 4)	
	2 TB, (TLC, PRC)	N77396-001
	1TB value, TLC	N45474-001
	1TB value (PRC)	N77394-001
	1TB (TLC, PRC)	N77395-001
	512 GB (TLC, PRC)	N77393-001
	512 GB value (TLC, PRC)	N77392-001
	512 GB, SED OPAL2, TLC	N86921-001
	256 GB, SED OPAL2	N35225-001
	256 GB value (PRC)	N77391-001
(8)	Battery (3 cell, 62 Whr)	P06352-001
(9)	Smart card reader	P33107-001
(10)	Bottom cover	P33118-001
(11)	Power button/fingerprint reader	P33136-001
(12)	Keyboard	
	NOTE: For a detailed list of country codes, see Keyboard removal on page 69 .	
	Backlit, spill-resistant	P39085-001
	Backlit, spill-resistant, privacy	P39086-001
	Not backlit, spill-resistant	P39087-001

Table 3-1 Computer major component descriptions and part numbers (continued)

Item	Component	Spare part number
(13)	Power button (no fingerprint reader)	P34040-001
(14)	Heat sink (includes replacement thermal material)	P33131-001
(15)	Fan	P33132-001
(16)	Audio jack	P33138-001
(17)	Speakers	P33133-001
*	Solid-state drive shield (available in the Bracket Kit)	P33126-001

* not illustrated

Display assembly subcomponents

To identify the display assembly subcomponents, use this illustration and table.

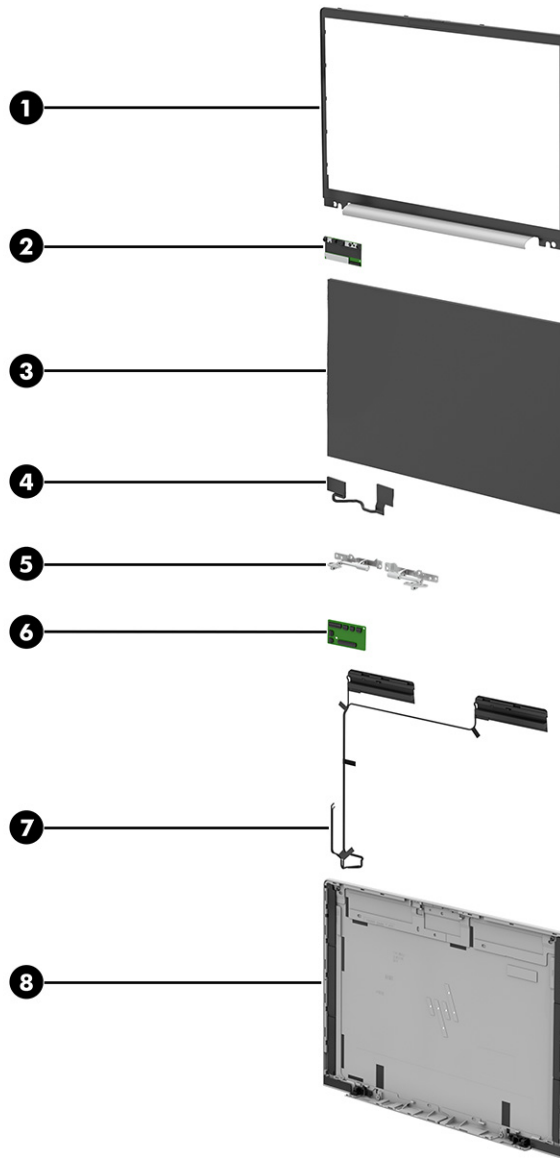

Table 3-2 Display component descriptions and part numbers

Item	Component	Spare part number
(1)	Display bezel	
	Model with an IR camera, ALS/ACS, and hinge cover	P33114-001
	Models with an RGB camera, ALS/ACS, and hinge cover	P33115-001
	Models with a microphone, no camera, and hinge cover	P33116-001
(2)	Camera module	
	RGB camera with cable	P33123-001
	Infrared AI camera with cable	P33124-001
(3)	Display panel	

Table 3-2 Display component descriptions and part numbers (continued)

Item	Component	Spare part number
	300 nits	P34138-001
	300 nits, touch screen	P34139-001
	400 nits	P34140-001
	800 nits	P34141-001
(4)	Display cable	P34038-001
(5)	Hinges	P33117-001
(6)	Display transfer board	not available as a spare part
(7)	WLAN antennas	not available as a spare part
(8)	Display back cover	
	Models with WLAN, 300 nit panel, touch screen	P33108-001
	Models with WWAN, 300 nit panel, touch screen	P33111-001
	Models with WLAN, 400 nit panel	P33109-001
	Models with WWAN, 400 nit panel	P33112-001
	Models with WLAN, Gen5 nit panel	P33110-001
	Models with WWAN, Gen5 nit panel	P33113-001
*	ACS board	P33122-001

* not illustrated

Miscellaneous parts

To identify the miscellaneous parts, use this table.

Table 3-3 Miscellaneous part descriptions and part numbers

Component	Spare part number
AC adapters	
65 W, nPFC, USB-C®, 1.8 m (6.0 ft)	L67440-001
65 W, nPFC, USB-C, halogen free, 1.8 m (6.0 ft)	N90678-001
65 W, nPFC, slim, USB-C	M54350-001
65 W, nPFC, USB-C	N99217-001
100 W, nPFC, USB-C PD	N57045-001
Screw Kit	P33128-001
Cable kit, Computer (includes cables for USB board, smart card reader, audio jack, fingerprint reader, touchpad, and NFC module)	P34039-001

Table 3-3 Miscellaneous part descriptions and part numbers (continued)

Component	Spare part number
Cable Kit, Display (includes cables for microphone module, camera, ACS board, and display transfer board)	P34037-001
Plastics Kit (includes smart card insert, fingerprint reader insert, SIM insert, left and right I/O frames, WWAN rubber spacer, and NI/CU gasket)	P33127-001
Bracket Kit (includes solid-state drive shield, memory module shields [WLAN and WWAN models], memory module thermal pad, USB bracket, fingerprint reader bracket, and SIM tray.)	P33126-001
System board repair support items	P37191-888
Support parts kit for LCD	P45639-001
HDMI-to-VGA adapter	701943-001
USB 3.0-to-Gigabit RJ-45 adapter	M95984-001
USB-C-to-DisplayPort adapter, G2	N81435-001
USB-C to HDMI 2.0 adapter	935325-001
USB-C-to-RJ-45 adapter	M95985-001
USB-C to USB 3.0 adapter	814618-001
USB-C to VGA adapter	831751-001
Hub for infrared and RGB with cable	P33119-001
Hub for microphone with cable	P33120-001
4K USB-C Multiport Hub	N21528-001
Universal USB-C Hub and Laptop Charger Combo	M52950-001
HP Universal USB-C Multiport Hub	M96882-001
USB-C to USB-A Hub	916838-001
USB-C Travel Hub G3	N60372-001
Thunderbolt 120 W G4 dock (with cable)	M97105-001
Thunderbolt 280 W G4 dock (with cable)	M97106-001
USB-C Dock G5 (with cable)	L64086-001
USB-C/A universal dock (with cable)	L64087-001
HP Prelude 15.6 backpack	M16116-001
HP Prelude 15.6 top load case	M16117-001
HP Prelude Pro Recycled 15.6 backpack	M03617-001
HP Prelude Pro Recycled 15.6 top load case	M03618-001
HP Renew Business 14.1 laptop bag	M55007-001
HP Renew Business 15.6 laptop bag	M55006-001
HP Renew Business 17.3 Laptop backpack	M55004-001
HP Renew Business 17.3 laptop bag	M55005-001
HP Renew Executive 16 laptop backpack	N19979-001

Table 3-3 Miscellaneous part descriptions and part numbers (continued)

Component	Spare part number
HP Renew Executive 16 laptop bag	N19980-001
Power cord (C5, conventional, 1.0 m [3.3 ft])	
Argentina	L19357-001
Australia	L19358-001
Brazil	L19359-001
Denmark	L19360-001
Europe (Austria, Belgium, Finland, France, Germany, the Netherlands, Norway, and Sweden)	L19361-001
Israel	L19362-001
India	L19363-001
Italy	L19364-001
Japan	L19365-001
Korea	L19366-001
North America	L19367-001
The People's Republic of China	L19368-001
South Africa	L19369-001
Switzerland	L19370-001
Taiwan	L19372-001
The United Kingdom	L19373-001
Power cord (C5, premium, 1.0 m [3.3 ft])	
Argentina	L30811-001
Australia	L22327-001
Brazil	L30812-001
Denmark	L22322-001
Europe (Austria, Belgium, Finland, France, Germany, the Netherlands, Norway, and Sweden)	L22321-001
India	L22624-001
Israel	L22323-001
Italy	L30813-001
Japan	L22330-001
Korea	L22328-001
North America	L22319-001
The People's Republic of China (PRC)	L21930-001
South Africa	L22325-001
Switzerland	L22324-001
Taiwan	L22329-001

Table 3-3 Miscellaneous part descriptions and part numbers (continued)

Component	Spare part number
Thailand	L22326-001
The United Kingdom	L22320-001
Power cord (C5, sticker, conventional, 1.0 m [3.3 ft])	
Denmark	M79264-001
Europe (Austria, Belgium, Finland, France, Germany, the Netherlands, Norway, and Sweden)	M79266-001
Switzerland	M79265-001
The United Kingdom	M82711-001
Power cord (Thailand)	
C13, premium, 1.0 m [3.3 ft], ADP + cord	M85413-001
C13, sticker, conventional, 1.0 m [3.3 ft], ADP + cord	M85418-001
C13, sticker, premium, 1.0 m [3.3 ft], ADP + cord	M85421-001
Power adapter, duckhead	
Japan	L33157-001

4 Removal and replacement procedures preliminary requirements

Use this information to properly prepare to disassemble and reassemble the computer.

Tools required

You need the following tools to complete the removal and replacement procedures:

- Tweezers
- Nonconductive, nonmarking pry tool
- Magnetic Phillips P1 screwdriver

Service considerations

The following sections include some of the considerations that you must keep in mind during disassembly and assembly procedures.

 **NOTE:** As you remove each subassembly from the computer, place the subassembly and all accompanying screws away from the work area to prevent damage.

Plastic parts

Using excessive force during disassembly and reassembly can damage plastic parts.

Cables and connectors

Handle cables with extreme care to avoid damage.

 **IMPORTANT:** When servicing the computer, be sure that cables are placed in their proper locations during the reassembly process. Improper cable placement can damage the computer.

Apply only the tension required to unseat or seat the cables during removal and insertion. Handle cables by the connector whenever possible. In all cases, avoid bending, twisting, or tearing cables. Be sure that cables are routed so that they cannot be caught or snagged as you remove or replace parts. Handle flex cables with extreme care; these cables tear easily.

Drive handling

Note the following guidelines when handling drives.

 **IMPORTANT:** Drives are fragile components. Handle them with care. To prevent damage to the computer, damage to a drive, or loss of information, observe these precautions:

- Before removing or inserting a hard drive, shut down the computer. If you are unsure whether the computer is off or in Hibernation or Sleep mode, turn the computer on, and then shut it down through the operating system.

- Before handling a drive, be sure that you are discharged of static electricity. While handling a drive, avoid touching the connector.
 - Before removing an optical drive, be sure that a disc is not in the drive, and be sure that the optical drive tray is closed.
 - Handle drives on surfaces covered with at least 2.54 cm (1 inch) of shock-proof foam.
 - Avoid dropping drives from any height onto any surface.
 - After removing a hard drive or an optical drive, place it in a static-proof bag.
 - Avoid exposing an internal hard drive to products that have magnetic fields, such as monitors or speakers.
 - Avoid exposing a drive to temperature extremes or liquids.
 - If a drive must be mailed, place the drive in a bubble pack mailer or other suitable form of protective packaging, and label the package "FRAGILE."
-

Electrostatic discharge information

A sudden discharge of static electricity from your finger or other conductor can destroy static-sensitive devices or microcircuitry. Often the spark is neither felt nor heard, but damage occurs. An electronic device exposed to electrostatic discharge (ESD) might not appear to be affected at all and can work perfectly throughout a normal cycle. The device might function normally for a while, but it has been degraded in the internal layers, reducing its life expectancy.

Networks built into many integrated circuits provide some protection, but in many cases, the discharge contains enough power to alter device parameters or melt silicon junctions.

 **IMPORTANT:** To prevent damage to the device when you remove or install internal components, observe these precautions:

- Keep components in their electrostatic-safe containers until you are ready to install them.
 - Before touching an electronic component, discharge static electricity by using the guidelines described in [Personal grounding methods and equipment on page 29](#).
 - Avoid touching pins, leads, and circuitry. Handle electronic components as little as possible.
 - If you remove a component, place it in an electrostatic-safe container.
-

Generating static electricity

Follow these static electricity guidelines:

- Different activities generate different amounts of static electricity.
- Static electricity increases as humidity decreases.

Table 4-1 Static electricity occurrence based on activity and humidity

Event	55% relative humidity	40% relative humidity	10% relative humidity
Walking across carpet	7,500 V	15,000 V	35,000 V
Walking across vinyl floor	3,000 V	5,000 V	12,000 V
Motions of bench worker	400 V	800 V	6,000 V
Removing dual in-line packages (DIPs) from plastic tube	400 V	700 V	2,000 V
Removing DIPs from vinyl tray	2,000 V	4,000 V	11,500 V
Removing DIPs from polystyrene foam	3,500 V	5,000 V	14,500 V
Removing bubble pack from PCB (printed circuit board)	7,000 V	20,000 V	26,500 V
Packing PCBs in foam-lined box	5,000 V	11,000 V	21,000 V

 **NOTE:** Multiple electric components can be packaged together in plastic tubes, trays, or polystyrene foam.

As little as 700 V of static electricity can degrade a product.

Preventing electrostatic damage to equipment

Many electronic components are sensitive to ESD. Circuitry design and structure determine the degree of sensitivity.

The following packaging and grounding precautions are necessary to prevent static electricity damage to electronic components:

- To avoid hand contact, transport products in static-safe containers such as tubes, bags, or boxes.
- Protect all electrostatic parts and assemblies with conductive or approved containers or packaging.
- Keep electrostatic-sensitive parts in their containers until they arrive at static-free stations.
- Place items on a grounded surface before removing them from their container.
- Always be properly grounded when touching a sensitive component or assembly.
- Avoid contact with pins, leads, or circuitry.
- Place reusable electrostatic-sensitive parts from assemblies in protective packaging or conductive foam.

Personal grounding methods and equipment

Using certain equipment can prevent static electricity damage to electronic components.

- **Wrist straps** are flexible straps with a maximum of $1\text{ M}\Omega \pm 10\%$ resistance in the ground cords. To provide proper ground, wear a strap snug against bare skin. Verify that the ground cord is connected and fits snugly into the banana plug connector on the grounding mat or workstation.
- You can use **heel straps, toe straps, and boot straps** at standing workstations. These straps are compatible with most types of shoes or boots. On conductive floors or dissipative floor mats, use them on both feet with a maximum of $1\text{ M}\Omega \pm 10\%$ resistance between the operator and ground.

Table 4-2 Static shielding protection levels

Method	Voltage
Antistatic plastic	1,500
Carbon-loaded plastic	7,500
Metallized laminate	15,000

Grounding the work area

To prevent static damage at the work area, follow these precautions:

- Cover the work surface with approved static-dissipative material.
- Use a wrist strap connected to a properly grounded work surface and use properly grounded tools and equipment.
- Use static-dissipative mats, foot straps, or air ionizers to give added protection.
- Handle electrostatic sensitive components, parts, and assemblies by the case or PCB laminate. Handle them only at static-free work areas.
- Turn off power and input signals before inserting and removing connectors or test equipment.
- Use fixtures made of static-safe materials when fixtures must directly contact dissipative surfaces.
- Keep the work area free of nonconductive materials, such as ordinary plastic assembly aids and polystyrene foam.
- Use conductive field service tools, such as cutters, screwdrivers, and vacuums.
- Avoid contact with pins, leads, or circuitry.

Recommended materials and equipment

HP recommends certain materials and equipment to prevent static electricity:

- Antistatic tape
- Antistatic smocks, aprons, or sleeve protectors
- Conductive bins and other assembly or soldering aids
- Conductive foam
- Conductive tabletop workstations with ground cord of $1\text{ M}\Omega \pm 10\%$ resistance
- Static-dissipative table or floor mats with hard tie to ground
- Field service kits
- Static awareness labels
- Wrist straps and footwear straps providing $1\text{ M}\Omega \pm 10\%$ resistance
- Material handling packages
- Conductive plastic bags

- Conductive plastic tubes
- Conductive tote boxes
- Opaque shielding bags
- Transparent metallized shielding bags
- Transparent shielding tubes

Cleaning your computer

Cleaning your computer regularly removes dirt and debris so that your device continues to operate at its best. Use the following information to safely clean the external surfaces of your computer.

Enabling HP Easy Clean (select products only)

HP Easy Clean helps you to avoid accidental input while you clean the computer surfaces. This software disables devices such as the keyboard, touch screen, and touchpad for a preset amount of time so that you can clean all computer surfaces.

1. Start HP Easy Clean in one of the following ways:
 - Select the **Start** menu, and then select **HP Easy Clean**.
 - Select the **HP Easy Clean** icon in the taskbar.
 - Select **Start**, and then select the **HP Easy Clean** tile.
2. Now that your device is disabled for a short period, see [Removing dirt and debris from your computer on page 31](#) for the recommended steps to clean the high-touch, external surfaces on your computer. After you remove the dirt and debris, you can also clean the surfaces with a disinfectant. See [Cleaning your computer with a disinfectant on page 32](#) for guidelines to help prevent the spread of harmful bacteria and viruses.

Removing dirt and debris from your computer

Here are the recommended steps to clean dirt and debris from your computer.

For computers with wood veneer, see [Caring for wood veneer \(select products only\) on page 33](#).

1. Wear disposable gloves made of latex (or nitrile gloves, if you are latex-sensitive) when cleaning the surfaces.
2. Turn off your device and unplug the power cord and other connected external devices. Remove any installed batteries from items such as wireless keyboards.

 **CAUTION:** To prevent electric shock or damage to components, never clean a product while it is turned on or plugged in.

3. Moisten a microfiber cloth with water. The cloth should be moist, but not dripping wet.

 **IMPORTANT:** To avoid damaging the surface, avoid abrasive cloths, towels, and paper towels.

4. Wipe the exterior of the product gently with the moistened cloth.



IMPORTANT: Keep liquids away from the product. Avoid getting moisture in any openings. If liquid makes its way inside your HP product, it can cause damage to the product. Do not spray liquids directly on the product. Do not use aerosol sprays, solvents, abrasives, or cleaners containing hydrogen peroxide or bleach that might damage the finish.

5. Start with the display (if applicable). Wipe carefully in one direction, and move from the top of the display to the bottom. Finish with any flexible cables, like power cord, keyboard cable, and USB cables.
6. Be sure that surfaces have completely air-dried before turning the device on after cleaning.
7. Discard the gloves after each cleaning. Clean your hands immediately after you remove the gloves.

See [Cleaning your computer with a disinfectant on page 32](#) for recommended steps to clean the high-touch, external surfaces on your computer to help prevent the spread of harmful bacteria and viruses.

Cleaning your computer with a disinfectant

The World Health Organization (WHO) recommends cleaning surfaces, followed by disinfection, as a best practice for preventing the spread of viral respiratory illnesses and harmful bacteria.

After cleaning the external surfaces of your computer using the steps in [Removing dirt and debris from your computer on page 31](#), [Caring for wood veneer \(select products only\) on page 33](#), or both, you might also choose to clean the surfaces with a disinfectant. A disinfectant that is within HP's cleaning guidelines is an alcohol solution consisting of 70% isopropyl alcohol and 30% water. This solution is also known as rubbing alcohol and is sold in most stores.

Follow these steps when disinfecting high-touch, external surfaces on your computer:

1. Wear disposable gloves made of latex (or nitrile gloves, if you are latex-sensitive) when cleaning the surfaces.
2. Turn off your device and unplug the power cord and other connected external devices. Remove any installed batteries from items such as wireless keyboards.



CAUTION: To prevent electric shock or damage to components, never clean a product while it is turned on or plugged in.

3. Moisten a microfiber cloth with a mixture of 70% isopropyl alcohol and 30% water. The cloth should be moist, but not dripping wet.



CAUTION: Do not use any of the following chemicals or any solutions that contain them, including spray-based surface cleaners: bleach, peroxides (including hydrogen peroxide), acetone, ammonia, ethyl alcohol, methylene chloride, or any petroleum-based materials, such as gasoline, paint thinner, benzene, or toluene.



IMPORTANT: To avoid damaging the surface, avoid abrasive cloths, towels, and paper towels.

4. Wipe the exterior of the product gently with the moistened cloth.



IMPORTANT: Keep liquids away from the product. Avoid getting moisture in any openings. If liquid makes its way inside your HP product, it can cause damage to the product. Do not spray liquids directly on the product. Do not use aerosol sprays, solvents, abrasives, or cleaners containing hydrogen peroxide or bleach that might damage the finish.

5. Start with the display (if applicable). Wipe carefully in one direction, and move from the top of the display to the bottom. Finish with any flexible cables, like power cord, keyboard cable, and USB cables.
6. Be sure that surfaces have completely air-dried before turning the device on after cleaning.
7. Discard the gloves after each cleaning. Clean your hands immediately after you remove the gloves.

Caring for wood veneer (select products only)

Your product might feature high-quality wood veneer. As with all natural wood products, proper care is important for best results over the life of the product. Because of the nature of natural wood, you might see unique variations in the grain pattern or subtle variations in color, which are normal.

- Clean the wood with a dry, static-free microfiber cloth or chamois.
- Avoid cleaning products containing substances such as ammonia, methylene chloride, acetone, turpentine, or other petroleum-based solvents.
- Do not expose the wood to sun or moisture for long periods of time.
- If the wood becomes wet, dry it by dabbing with an absorbent, lint-free cloth.
- Avoid contact with any substance that might dye or discolor the wood.
- Avoid contact with sharp objects or rough surfaces that might scratch the wood.

See [Removing dirt and debris from your computer on page 31](#) for the recommended steps to clean the high-touch, external surfaces on your computer. After you remove the dirt and debris, you can also clean the surfaces with a disinfectant. See [Cleaning your computer with a disinfectant on page 32](#) for sanitizing guidelines to help prevent the spread of harmful bacteria and viruses.

Packaging and transporting guidelines

Follow these grounding guidelines when packaging and transporting equipment:

- To avoid hand contact, transport products in static-safe tubes, bags, or boxes.
- Protect ESD-sensitive parts and assemblies with conductive or approved containers or packaging.
- Keep ESD-sensitive parts in their containers until the parts arrive at static-free workstations.
- Place items on a grounded surface before removing items from their containers.
- Always be properly grounded when touching a component or assembly.
- Store reusable ESD-sensitive parts from assemblies in protective packaging or nonconductive foam.
- Use transporters and conveyors made of antistatic belts and roller bushings. Be sure that mechanized equipment used for moving materials is wired to ground and that proper materials are selected to avoid static charging. When grounding is not possible, use an ionizer to dissipate electric charges.

Accessing support information

To find the HP support that you need, use this information.

Table 4-3 Support information locations



Service consideration	Path to access information
<p>Records of reported failure incidents stored on the computer</p>	<p>Windows:</p> <p>Preoperating system failures are logged in the BIOS Event Log. To view the BIOS Event Log:</p> <ol style="list-style-type: none"> 1. Press the power button. 2. Immediately and repeatedly press esc when the power button light turns white. <p>NOTE: If you do not press esc at the appropriate time, you must restart the computer and again repeatedly press esc when the power button light turns white to access the utility.</p> <ol style="list-style-type: none"> 3. Press f10 to enter the BIOS setup. 4. Complete one of these tasks: <ul style="list-style-type: none"> • (On commercial products) Under the Main tab, select BIOS event log, and then select View BIOS Event Log. • (On consumer products) Under the Main tab, select System Log. <p>Post-operating system failures are logged in the Event Viewer.</p> <ol style="list-style-type: none"> 1. Turn on the computer and allow the operating system to open. 2. Select the search icon  in the taskbar. 3. Type <code>Event Viewer</code>, and then press enter. 4. Select the log from the left panel. Details display in the right panel. <p>Chrome™:</p> <ol style="list-style-type: none"> 1. Go to support.google.com/chrome. 2. Search <code>collect Chrome device logs</code>.
<p>Technical bulletins</p>	<p>To locate technical bulletins:</p> <ol style="list-style-type: none"> 1. Go to www.hp.com. 2. Place the cursor over Problem solving to display more options. 3. Select Support & Troubleshooting. 4. Type the serial number, product number, or product name to go to the product support page. 5. Select Advisories to view technical bulletins.
<p>Repair professionals</p>	<p>To locate repair professionals:</p> <ol style="list-style-type: none"> 1. Go to www.hp.com. 2. Place the cursor over Support resources to display more options. 3. Select Authorized service providers.

Table 4-3 Support information locations (continued)

Service consideration	Path to access information
Component and diagnosis information, failure detection, and required action	To locate diagnosis information and actions: <ol style="list-style-type: none"><li data-bbox="703 310 1206 331">1. Go to http://www.hp.com/go/techcenter/pcdiags.<li data-bbox="703 363 938 384">2. Select Get Support.<li data-bbox="703 415 1445 457">3. Near the bottom of the window, select Notebook PCs, and then select your location.

5 Removal and replacement procedures for Customer Self-Repair parts

This chapter provides removal and replacement procedures for Customer Self-Repair parts.

 **NOTE:** The Customer Self-Repair program is not available in all locations. Installing a part that is not supported by the Customer Self-Repair program can void your warranty. Check your warranty to determine whether Customer Self-Repair is supported in your location.

 **NOTE:** The [HP Support YouTube Channel](#) (in English) has videos that provide step-by-step removal and replacement instructions for many common parts and models.

Component replacement procedures

To remove and replace computer components, use these procedures.

 **NOTE:** Details about your computer, including model, serial number, product key, and length of warranty, are on the service tag at the bottom of your computer.

 **NOTE:** HP continually improves and changes product parts. For complete and current information about supported parts for your computer, go to <https://partsurfer.hp.com/>, select your country or region, and then follow the on-screen instructions.

Make special note of each screw size and location during removal and replacement.

Preparation for disassembly

To remove and replace computer components, use these procedures:

For initial safety procedures, see [Removal and replacement procedures preliminary requirements on page 27](#).

1. Turn off the computer. If you are unsure whether the computer is off or in Hibernation or Sleep mode, turn the computer on, and then shut it down through the operating system.
2. Disconnect the power from the computer by unplugging the power cord from the computer.
3. Disconnect all external devices from the computer.

Bottom cover

To remove the bottom cover, use this procedure and illustration.

Table 5-1 Bottom cover description and part number

Description	Spare part number
Bottom cover	P33118-001

Before removing the bottom cover, prepare the computer for disassembly (see [Preparation for disassembly on page 36](#)).

Remove the bottom cover:

1. Loosen the four captive Phillips screws that secure the bottom cover to the computer.

 **NOTE:** The bottom cover includes a captive (not removable) screw that causes the cover to pop up when you loosen the screw. **After the cover pops up, do not continue to loosen the captive screw.**

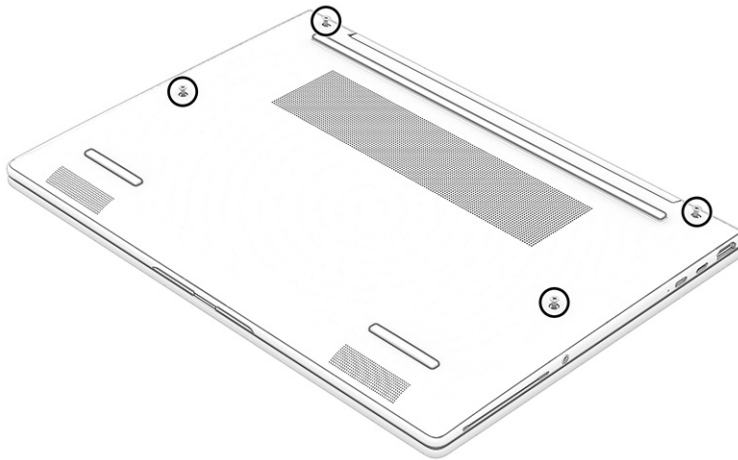

2. Use a nonmarking, nonconductive tool (1) to release the edges of the bottom cover from the computer.
3. Remove the bottom cover (2) from the computer.

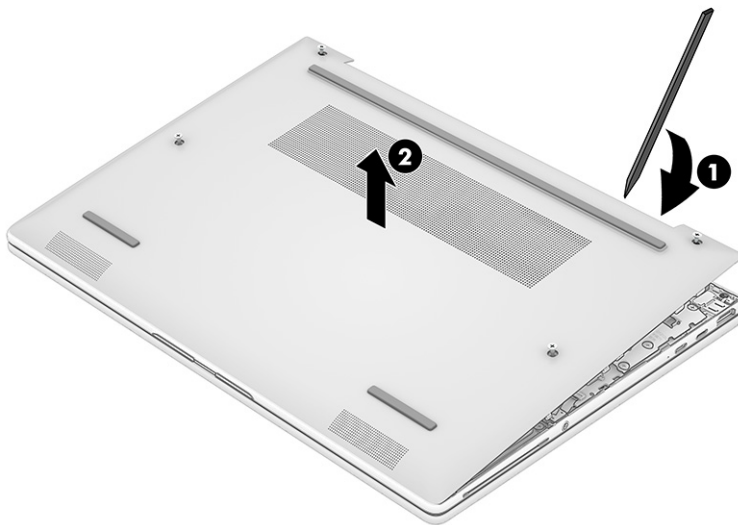

To replace the bottom cover, reverse the removal procedures.







When replacing the bottom cover:

- Remove the Feature Byte label from the inside of the old bottom cover and place it on the inside of the new bottom cover.
- Remove the service tag label from the inside of the old bottom cover and place it on the outside of the new bottom cover.

Be sure to keep these labels with the computer, as the label is required for any future repairs.

Service tag and Feature Byte labels

 **NOTE:** Label appearance might vary.

 <p>HP Long Model Name ProdID AA1234V SNR CNU1234567 Warranty 1y1y0y</p> 	<p>← Service Tag label →</p>	 <p>HP Foris P16 G1 11 ProdID R2R4E56ABN SNR 5C05594B3R Warranty 1y1y0y</p> 
<p>Build ID: XXXXXXXXXXXXX21BYTES</p> <p>Build</p>  <p>Feature Byte: XXXXXXXXXX1112222AAAAAAAAXX XXXXXXXXXX1112222AAAAAAAAXX XXXXXXXXXX1112222AAAAAAAAXX XXXXXXXXXX1112222AAAAAAAAXX</p>  <p>Keyboard Type:</p>	<p>← Feature Byte label →</p>	<p>Feature Byte: 47E0676747M7R7W7m5Aa8CspaquewVW eMxPpAdmEmIn7mVngpDpJngpgrNkxZ.TY</p>  <p>Keyboard Type 0 Host Based Mac Address: See Label on System Board</p>

New bottom cover label locations

Inside of bottom cover (place Feature Byte label here)

 **NOTE:** Bottom cover appearance might vary.

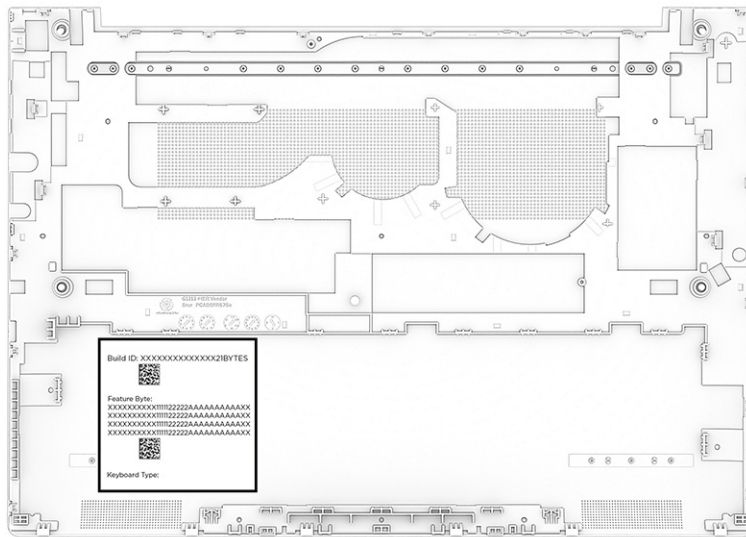

Outside of bottom cover (place service tag label here)

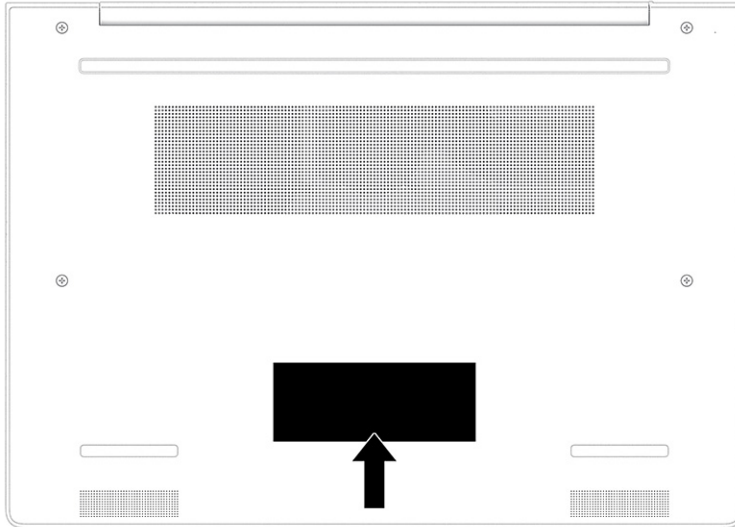

Battery

The battery removal procedure differs depending on whether you are removing and replacing the existing battery or installing a new battery. To install a new battery, you must use a revive kit.

- To remove and replace the existing battery, see [Removing and reinstalling the same battery on page 39](#).
- To install a new battery, see [Installing a new battery on page 40](#).

Removing and reinstalling the same battery

To remove the battery and reinstall it, use this procedure and illustration.

⚠ WARNING! To avoid personal injury and damage to the product:

- Do *not* puncture, twist, or crack the battery.
 - Do *not* cause an external puncture or rupture to the battery, which can cause a short inside the battery that can result in battery thermal runaway.
 - Do *not* handle or touch the battery enclosure with sharp objects such as tweezers or pliers, which might puncture the battery.
 - Do *not* compress or squeeze the battery case with tools or heavy objects stacked on top of the case. These actions can apply undue force on the battery.
 - Do *not* touch the connectors with any metallic surface or object, such as metal tools, screws, or coins, which can cause shorting across the connectors.
-

For additional battery information, see the *Regulatory, Safety, and Environmental Notices*. To access this guide, select the **Search** icon in the taskbar, type `HP Documentation` in the search box, and then select **HP Documentation**.

Before removing the battery, follow these steps:

1. Prepare the computer for disassembly (see [Preparation for disassembly on page 36](#)).
2. Remove the bottom cover (see [Bottom cover on page 36](#)).

⚠ WARNING! To reduce potential safety issues, use only the user-replaceable battery provided with the computer, a replacement battery provided by HP, or a compatible battery purchased from HP.

📝 IMPORTANT: Removing a battery that is the sole power source for the computer can cause loss of information. To prevent loss of information, save your work or shut down the computer through Windows before you remove the battery.

Remove the battery:

1. Disconnect the battery cable (1) from the system board.
2. Open the latches (2) that secure the battery to the computer.
3. Remove the battery from the computer (3).

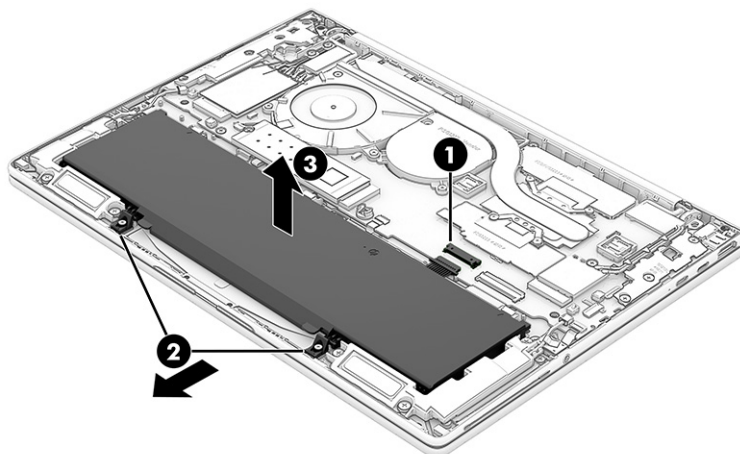

To reinstall the battery, reverse the removal procedures.

📝 NOTE: When reinstalling the battery, be sure to completely reassemble the computer and plug in the AC adapter before turning the computer on.

Installing a new battery

To install a battery, use these procedures and illustrations. You must use a revive kit to remove the old battery and install a new one. The revive kit includes an empty containment tray and a containment tray with a battery preinstalled.

Table 5-2 Battery description and part number

Description	Spare part number
Battery	P06352-001

Before starting this replacement procedure:

- Ensure other individuals are sufficiently clear of your workspace.

- Ensure your workspace is clear of any flammable material such as paper or oils.
- Locate the nearest ABC dry chemical fire-extinguisher for use in an emergency.

⚠ WARNING! This procedure requires removing the battery or disconnecting the battery cable. Use care to avoid bending, twisting, or puncturing the battery regardless of its condition. Failure to follow this replacement guide or to use HP recommended tools might damage the system and/or cause a safety hazard.

- Do *not* remove the battery from the containment tray.
- Do *not* handle or touch the battery enclosure with sharp objects such as tweezers or pliers, which might puncture the battery.
- Do *not* touch the connectors with any metallic surface or object, such as metal tools, screws, or coins, which can cause shorting across the connectors.

Should a part become stuck or difficult to remove when opening a unit where a swollen battery is suspected, or if the battery becomes stuck in the unit, stop, and contact HP Support for assistance. Do not try to remove a battery by force.

📝 NOTE: Latch locations and internal components might vary.

Before removing the battery, follow these steps:

1. Prepare the computer for disassembly (see [Preparation for disassembly on page 36](#)).
2. Remove the bottom cover (see [Bottom cover on page 36](#)).

⚠ WARNING! To reduce potential safety issues, use only the user-replaceable battery provided with the computer, a replacement battery provided by HP, or a compatible battery purchased from HP.

📝 IMPORTANT: Removing a battery that is the sole power source for the computer can cause loss of information. To prevent loss of information, save your work or shut down the computer through Windows before you remove the battery.

1. Remove the battery using the revive kit:
 - a. Disconnect the battery cable from the system board. The connector location might vary.

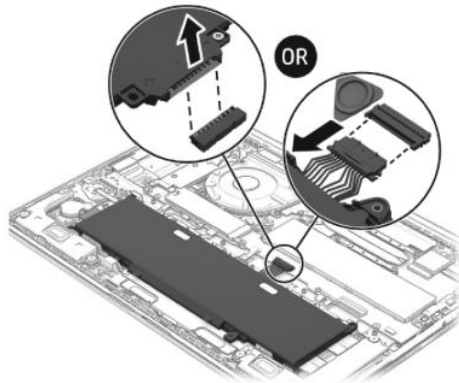

- b. Open the empty battery containment tray.

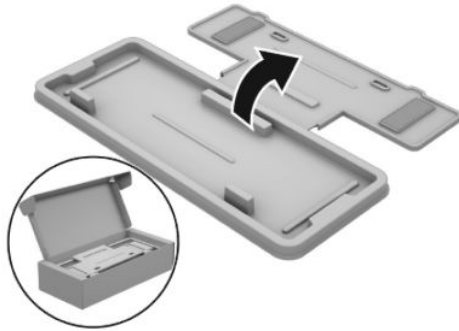

- c. Remove the paper backing layer from the adhesive on the tray.

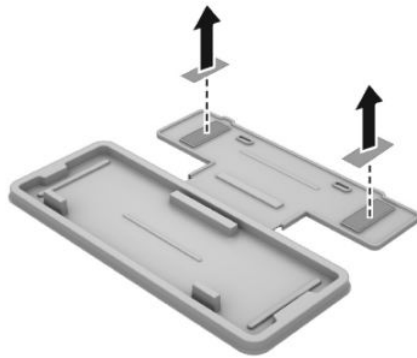

- d. Turn the tray (1) over so that the adhesive is facing down.
- e. Place the tray (2) centered on the battery.
- f. Press down on the indentations on the tray (3) to adhere it to the battery.

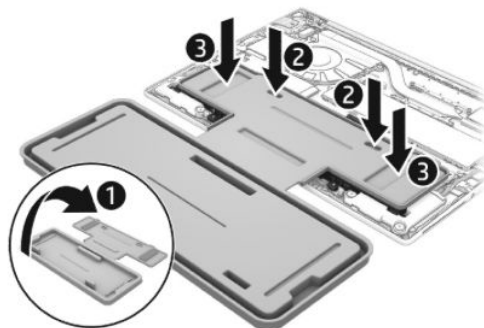

- g. Rotate to unlock the latches (1) that secure the battery to the computer. Number of latches and latch locations might vary.
- h. Lift the top of the tray (2) to remove the battery from the computer.

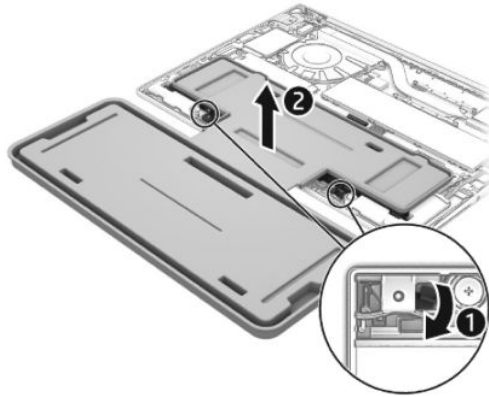

- i. Rotate the battery up and over into the cavity of the containment tray.

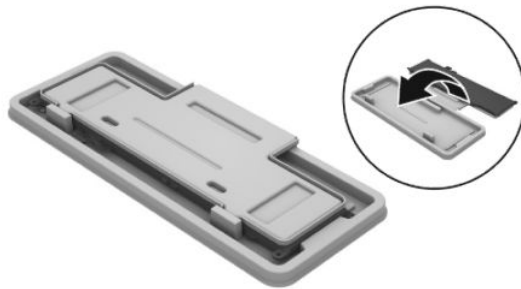

 **NOTE:** Please recycle responsibly. For more information about recycling programs, see the HP website at <http://www.hp.com/recycle>.

- 2. Install the battery using the revive kit:
 - a. Open the containment tray that includes the new battery.

- b. Turn the tray (1) over so the battery is facing downward, and then insert the battery (2) into the computer. Adhesive secures the battery to the tray.

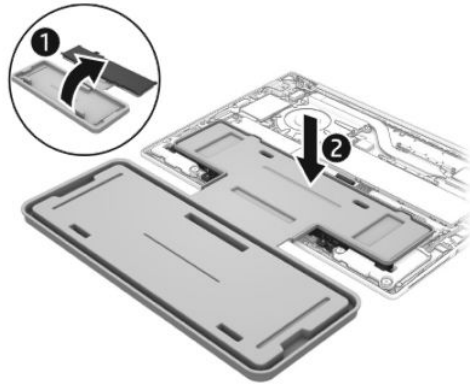

- c. Rotate to lock the latches (1) to secure the battery. Number of latches and latch locations might vary.
- d. Lift the containment tray (2) off the battery.

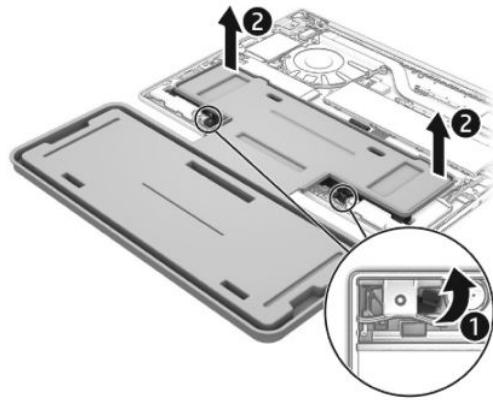

- e. Connect the battery cable to the system board. The connector location might vary.

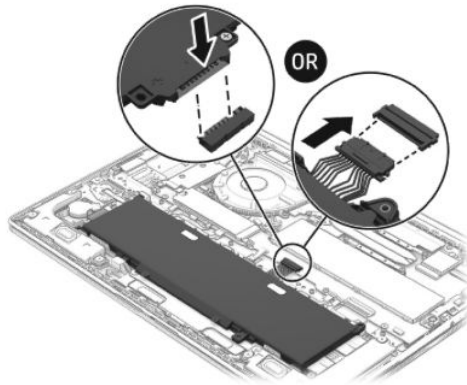

NOTE: When replacing the battery, be sure to completely reassemble the computer and plug in the AC adapter before turning the computer on.

WLAN module

To remove the WLAN module, use this procedure and illustration.

Table 5-3 WLAN module descriptions and part numbers

Description	Spare part number
Intel AX211 Wi-Fi 6E Bluetooth 5.3 vPro	M53363-001
Intel AX211 Wi-Fi 6e Bluetooth 5.3	M53366-001
Intel Wi-Fi 7 BE201 Bluetooth 5.4 vPro	N86465-001
Intel Wi-Fi 7 BE201 Bluetooth 5.4	N86466-001

IMPORTANT: To prevent an unresponsive system, replace the wireless module only with a wireless module authorized for use in the computer by the governmental agency that regulates wireless devices in your country or region. If you replace the module and then receive a warning message, remove the module to restore device functionality, and then contact technical support.

Before removing the WLAN module, follow these steps:

1. Prepare the computer for disassembly (see [Preparation for disassembly on page 36](#)).
2. Remove the bottom cover (see [Bottom cover on page 36](#)).
3. Disconnect the battery cable from the system board (see [Battery on page 39](#)).

Remove the WLAN module:

1. Carefully disconnect the two antenna cables from the module **(1)**.

- Remove the Phillips M2.0 × 4.0 screw (2), and then remove the WLAN module (3).

 **NOTE:** The #1 white WLAN antenna cable connects to the WLAN module #1 Main terminal. The #2 black WLAN antenna cable connects to the WLAN module #1 Aux terminal.

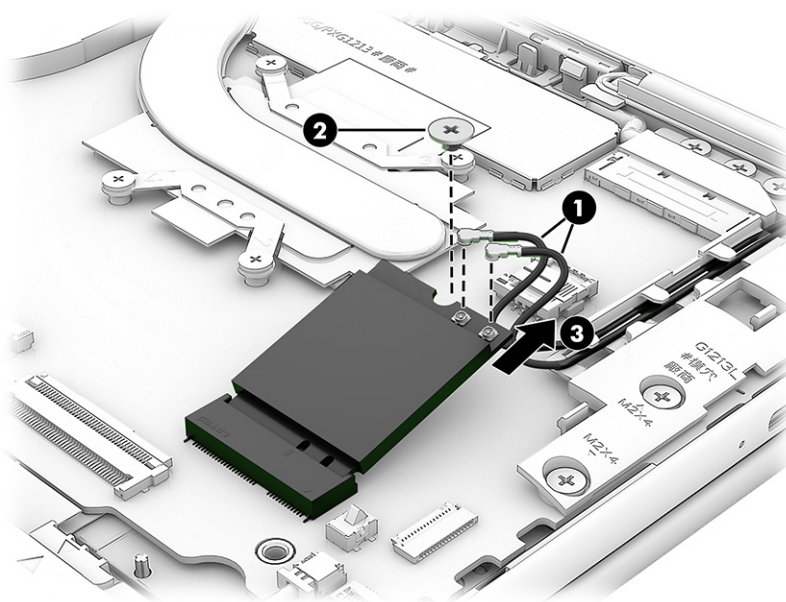

- If the WLAN antenna is not connected to the terminal on the WLAN module, install a protective sleeve on the antenna connector, as shown in the following illustration.

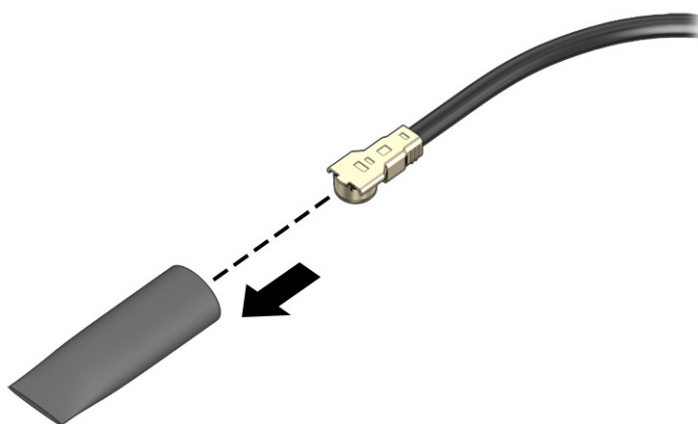

To install the WLAN module, reverse this procedure.

WWAN module

To remove the WWAN module, use this procedure and illustration.

Table 5-4 WWAN module descriptions and part numbers

Description	Spare part number
HP 4000 4G LTE-Advanced Pro WWAN	P06930-001
HP 5000 5G Solution WWAN	P20951-001

Table 5-4 WWAN module descriptions and part numbers (continued)

Description	Spare part number
Qualcomm 9205 LTE-M (CAT-M1)	M78607-001

 **IMPORTANT:** To prevent an unresponsive system, replace the wireless module only with a wireless module authorized for use in the computer by the governmental agency that regulates wireless devices in your country or region. If you replace the module and then receive a warning message, remove the module to restore device functionality, and then contact technical support.

Before removing the WWAN module, follow these steps:

1. Prepare the computer for disassembly (see [Preparation for disassembly on page 36](#)).
2. Remove the bottom cover (see [Bottom cover on page 36](#)).
3. Disconnect the battery cable from the system board (see [Battery on page 39](#)).

Remove the WWAN module:

1. Disconnect the WWAN antenna cables (2) from the terminals on the WWAN module.
2. Remove the Phillips M2.0 × 2.5 screw (1) that secures the WWAN module to the bottom cover. The WWAN module tilts up.
3. Remove the WWAN module (3) by pulling the module away from the slot at an angle.

 **NOTE:** WWAN modules have either two or four ports. The corresponding 5, 6, 7, and 8 antennas on the four port WWAN module connect to ports 5, 6, 7, and 8. The corresponding 5 and 6 antennas on the two port WWAN module connect to ports 5 and 6.

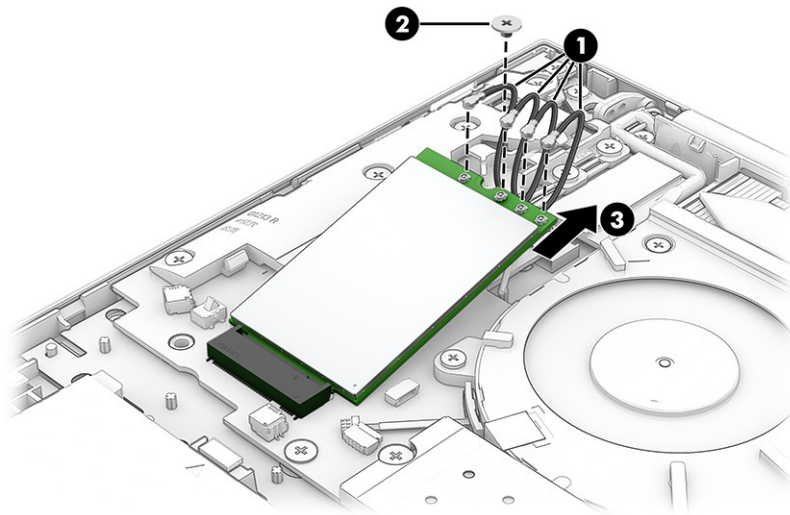

4. If the WWAN antenna is not connected to the terminal on the WWAN module, a protective sleeve must be installed on the antenna connector, as shown in the following illustration.

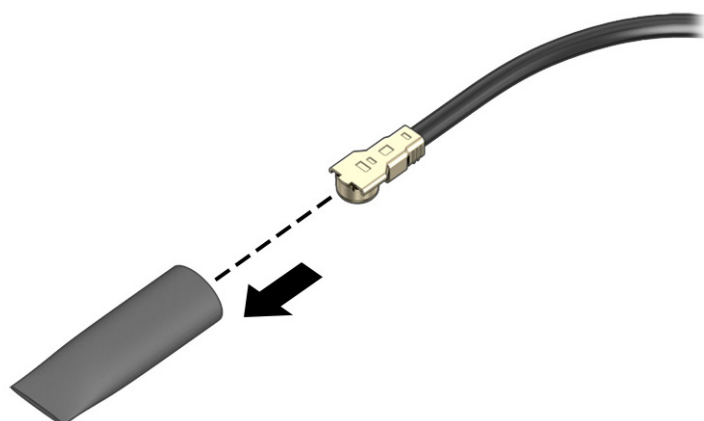

To install the WWAN module, reverse this procedure.

Solid-state drive

To remove the M.2 solid-state drive, use this procedure and illustration.

Table 5-5 Solid-state drive descriptions and part numbers

Description	Spare part number
2 TB, PCIe-4 × 4, TLC	N77396-001
1TB value, PCIe-4 × 4, TLC	N45474-001
1TB value, PCIe-4 × 4	N77394-001
1TB, PCIe-4 × 4	N77395-001
512 GB, PCIe-4 × 4, TLC	N77393-001
512 GB value, PCIe-4 × 4	N77392-001
512 GB, PCIe-4 × 4, SED OPAL2, TLC	N86921-001
256 GB, PCIe-4 × 4, SED OPAL2	N35225-001
256 GB value, PCIe-4 × 4	N77391-001

Before removing the solid-state drive, follow these steps:

1. Prepare the computer for disassembly (see [Preparation for disassembly on page 36](#)).
2. Remove the bottom cover (see [Bottom cover on page 36](#)).
3. Disconnect the battery cable from the system board (see [Battery on page 39](#)).

Remove the solid-state drive:

1. Remove the Phillips M2.0 × 4.0 screw **(1)** that secures the drive to the computer.

2. Pull the drive away (2) from the socket to remove it.

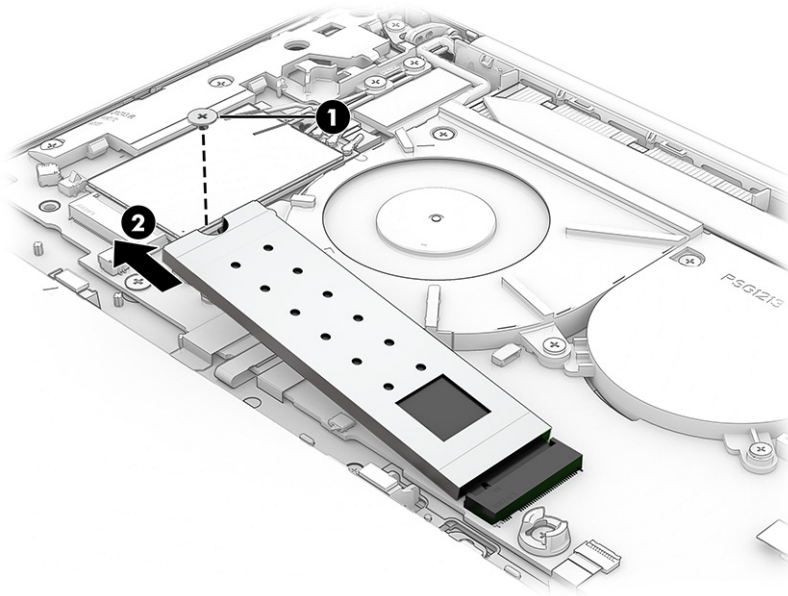

3. Remove the protective sleeve from the solid-state drive.

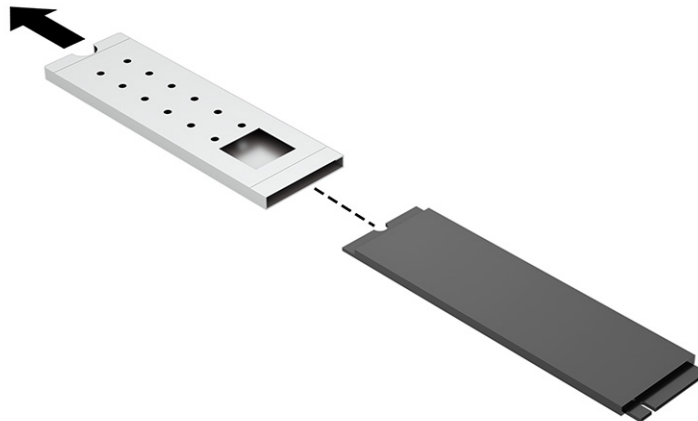

To install the solid-state drive, reverse the removal procedures.





NOTE: Solid-state drives are designed with a notch to prevent incorrect insertion.

6 Removal and replacement procedures for authorized service provider parts

This chapter provides removal and replacement procedures for authorized service provider parts.

 **IMPORTANT:** Only an authorized service provider should access the components described in this chapter. Accessing these parts can damage the computer or void the warranty.

 **NOTE:** Details about your computer, including model, serial number, product key, and length of warranty, are on the service tag at the bottom of your computer.

 **NOTE:** The [HP Support YouTube Channel](#) (in English) has videos that provide step-by-step removal and replacement instructions for many common parts and models.

Component replacement procedures

To remove and replace computer components, use the procedures described in this section.

 **NOTE:** HP continually improves and changes product parts. For complete and current information about supported parts for your computer, go to <https://partsurfer.hp.com/>, select your country or region, and then follow the on-screen instructions.

Make special note of each screw size and location during removal and replacement.

Speakers

To remove the speakers, use this procedure and illustration.

Table 6-1 Speaker description and part number

Description	Spare part number
Speakers (left and right)	P33133-001

Before removing the speakers, follow these steps:

1. Prepare the computer for disassembly (see [Preparation for disassembly on page 36](#)).
2. Remove the bottom cover (see [Bottom cover on page 36](#)).
3. Disconnect the battery cable from the system board (see [Battery on page 39](#)).

Remove the speakers:

1. Disconnect the speaker cables **(1)** from the system board.
2. Remove the three Phillips M1.6 × 1.5 screws **(2)** that secure each speaker to the computer.

3. Remove the speakers from the computer (3).

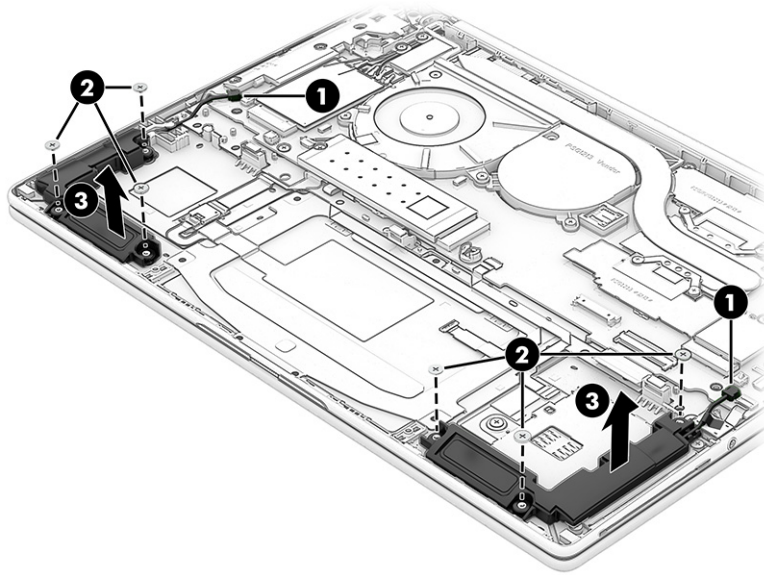

Reverse this procedure to install the speakers.

Touchpad

To remove the touchpad, use this procedure and illustration.

Table 6-2 Touchpad description and part number

Description	Spare part number
Touchpad (for use in models without NFC)	P33134-001
Touchpad (for use in models with NFC (includes NFC antenna))	P33135-001

Before removing the touchpad, follow these steps:

1. Prepare the computer for disassembly (see [Preparation for disassembly on page 36](#)).
2. Remove the bottom cover (see [Bottom cover on page 36](#)).
3. Remove the battery (see [Installing a new battery on page 40](#)).

Remove the touchpad:

1. Disconnect the cable from the ZIF connector on the touchpad (1), and then carefully peel it away from the touchpad bracket.

 **NOTE:** If there is an NFC module and a Smart Card reader module, you must also disconnect the NFC cable (ZIF), and then gently remove the Smart Card reader cable (ZIF).

2. Remove the seven Phillips M1.6 × 1.8 screws (2) that secure the touchpad bracket to the computer.

3. Remove the touchpad bracket from the computer (3).

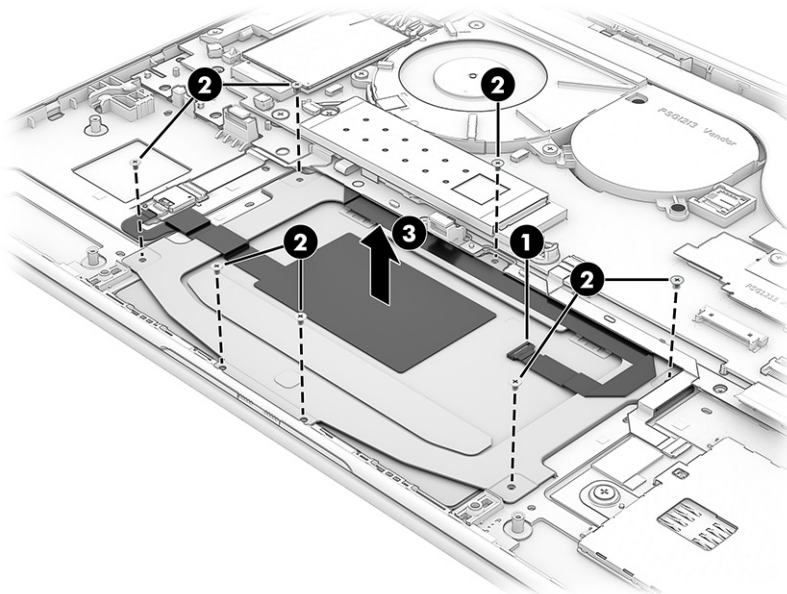

Reverse this procedure to install the touchpad.

NFC module

To remove the NFC module, use this procedure and illustration.



NOTE: The NFC module spare part kit does not include the antenna. The antenna is included in the touchpad spare part kit.

Table 6-3 NFC module descriptions and part numbers

Description	Spare part number
NFC module	M08706-001
NFC module cable (included in Cable Kit)	P34039-001

Before removing the NFC module, follow these steps:

1. Prepare the computer for disassembly (see [Preparation for disassembly on page 36](#)).
2. Remove the bottom cover (see [Bottom cover on page 36](#)).
3. Remove the battery (see [Battery on page 39](#)).
4. Remove the touchpad (see [Touchpad on page 51](#)).

Remove the NFC module:

1. Disconnect the system board cable from the ZIF connector (1) on the top of the NFC module. .

2. Remove the NFC module **(2)** from the computer. The module is secured with adhesive.

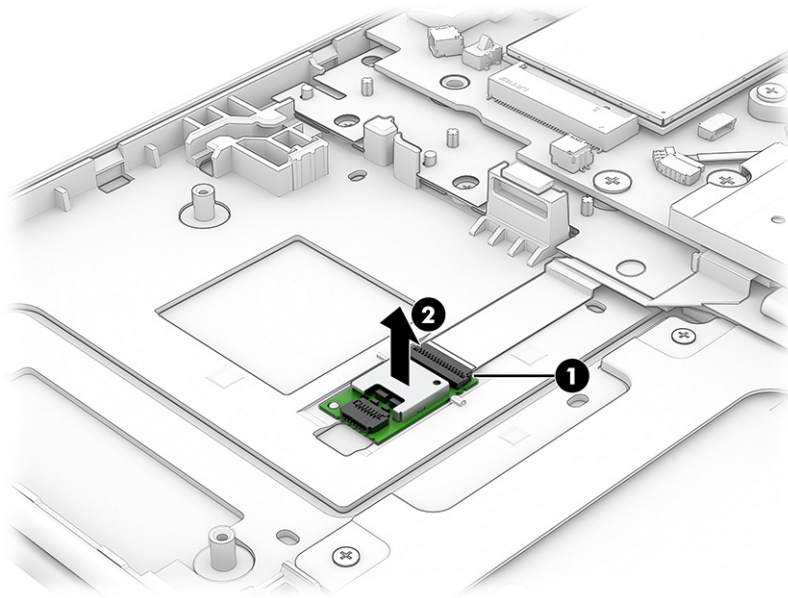

To install the NFC module, reverse this procedure.

Fan

To remove the fan, use this procedure and illustration.

Table 6-4 Fan description and part number

Description	Spare part number
Fan	P33132-001

Before removing the fan, follow these steps:

1. Prepare the computer for disassembly (see [Preparation for disassembly on page 36](#)).
2. Remove the bottom cover (see [Bottom cover on page 36](#)).
3. Disconnect the battery cable from the system board (see [Battery on page 39](#)).

Remove the fan assembly:

1. Disconnect the fan cable **(1)** from the system board.

2. Loosen the three captive Phillips screws (2) that secure the fan to the computer, and then remove the fan from the computer (3).

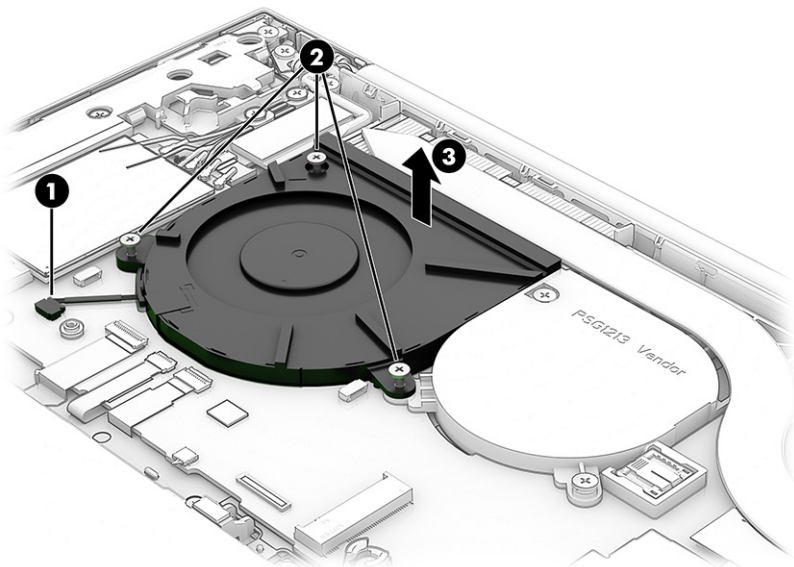

To install the fan, reverse this procedure.

Heat sink

To remove the heat sink, use these procedures and illustrations.

Table 6-5 Heat sink description and part number

Description	Spare part number
Heat sink	P33131-001

Before removing the heat sink, follow these steps:

1. Prepare the computer for disassembly (see [Preparation for disassembly on page 36](#)).
2. Remove the bottom cover (see [Bottom cover on page 36](#)).
3. Disconnect the battery cable from the system board (see [Battery on page 39](#)).

Remove the heat sink:

1. Remove any tape that might be present (1) from the heat sink.
2. In the order indicated on the heat sink, loosen the four captive Phillips screws (2) that secure the heat sink to the computer.

3. Remove the heat sink from the computer (3).

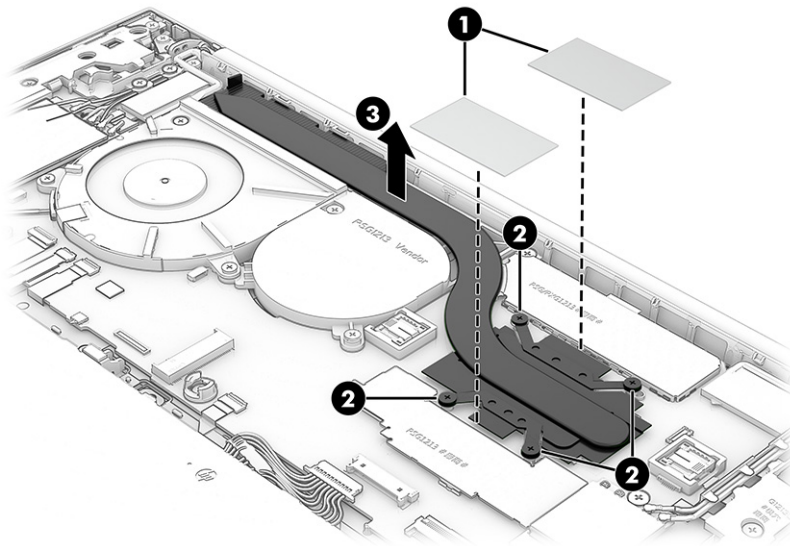

4. Thoroughly clean the thermal material from the surfaces of the heat sink and the system board components each time the heat sink is removed. Replacement thermal material is included with the heat sink and system board spare part kits. The following illustration shows the replacement thermal material locations.

Thermal paste is used on the system board components and on the heat sink areas that service them.

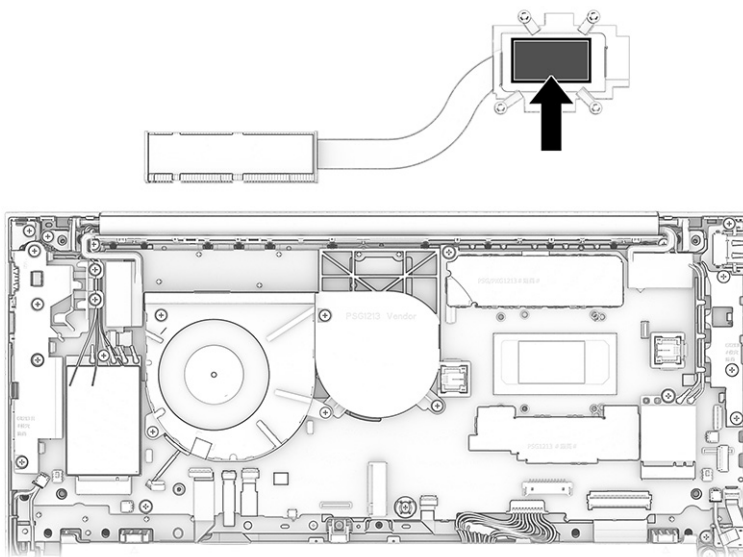

To install the heat sink reverse this procedure.

Left and right I/O frames

To remove the left and right I/O frames, use this procedure and illustration.

Table 6-6 Left and right I/O frames description and part number

Description	Spare part number
Left and right I/O frames are included in the Plastics Kit	P33127-001

Before removing the left and right I/O frames, follow these steps:

1. Prepare the computer for disassembly (see [Preparation for disassembly on page 36](#)).
2. Remove the bottom cover (see [Bottom cover on page 36](#)).
3. Disconnect the battery cable from the system board (see [Battery on page 39](#)).

Remove the left and right I/O frames:

1. Remove the tape **(1)** from the frame, if necessary.
2. Disconnect the cables **(2)** from the WWAN module, and then remove the cables from the routing clips.
3. Remove the display cable **(3)** from the system board.



NOTE: Hold the system board flat when removing the cable to keep it from flexing.

4. Remove the six Phillips M2.0 × 4.0 screws **(4)** that secure the left I/O frame to the computer.
5. Remove the left I/O frame **(5)** from the computer.

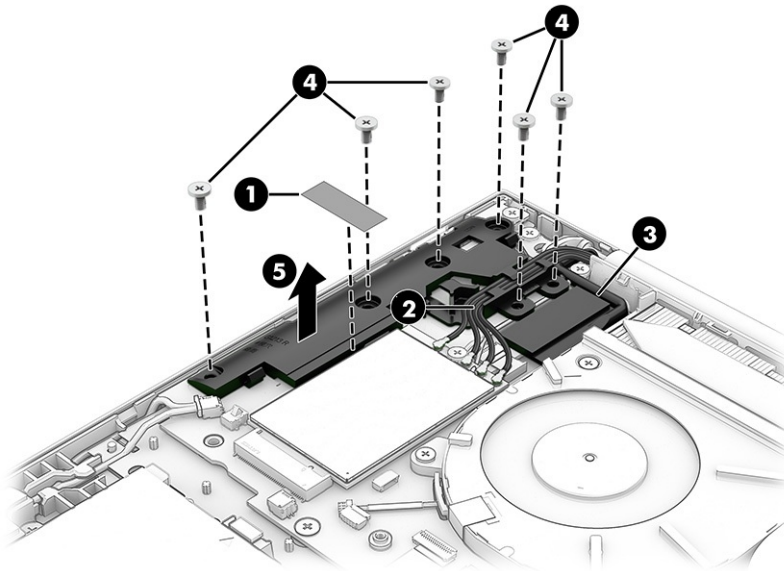

6. Disconnect the cables **(1)** from the WLAN module, and then remove the cables from the routing clips.
7. Disconnect the display cable **(2)**.
8. Remove the three Phillips M2.0 × 4.0 screws **(3)** that secure the right I/O frame to the computer.

9. Remove the right I/O frame (4) from the computer.

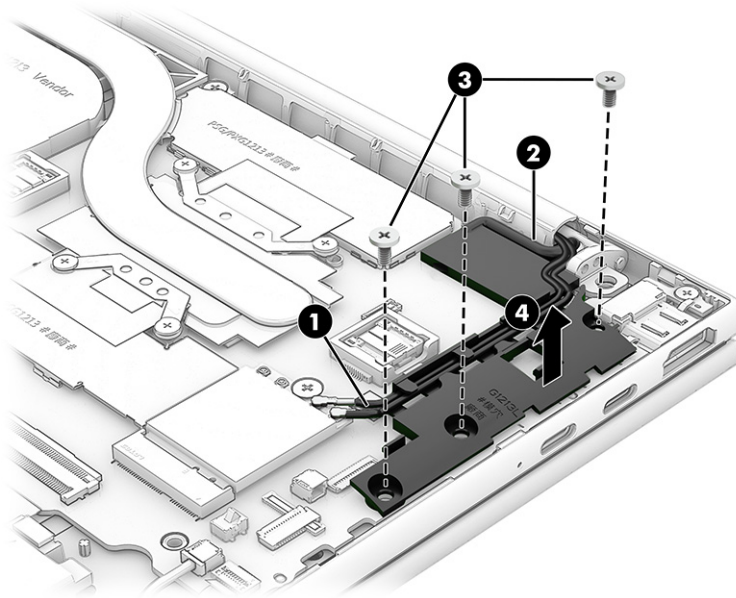

To install the left and right I/O frames, reverse this procedure.

Audio jack

To remove the audio jack, use this procedure and illustration.

Table 6-7 Audio jack description and part number

Description	Spare part number
Audio jack	P33138-001

Before removing the audio jack, follow these steps:

1. Prepare the computer for disassembly (see [Preparation for disassembly on page 36](#)).
2. Remove the bottom cover (see [Bottom cover on page 36](#)).
3. Disconnect the battery cable from the system board (see [Battery on page 39](#)).

Remove the audio jack:

1. Disconnect the audio jack cable (ZIF) (1) from the system board.
2. Remove the Phillips 2.0 × 2.0 screw (2) that secures the audio jack to the computer.

3. Remove the audio jack (3) from the computer.

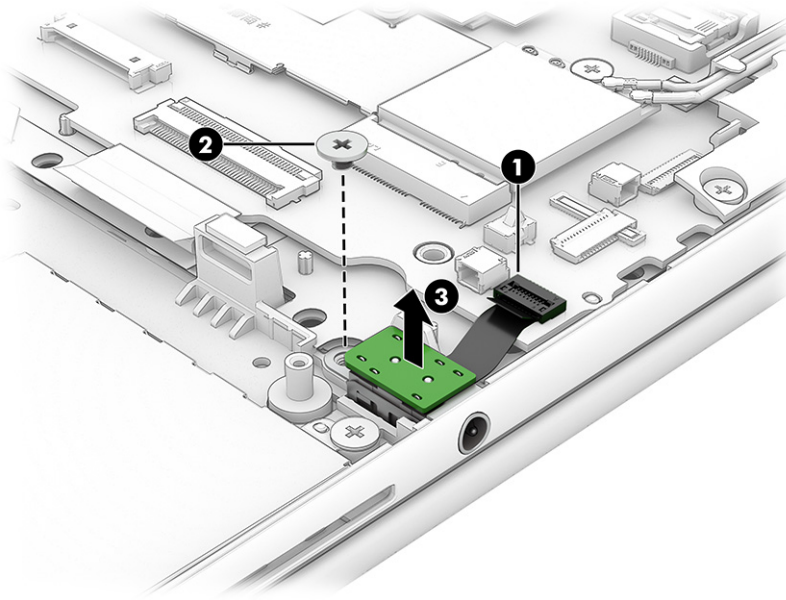

To install the audio jack, reverse this procedure.

Smart card reader

To remove the smart card reader, use this procedure and illustration.



NOTE: The cable for the smart card reader is included in the Cable kit, part number P34039-001.

Table 6-8 Smart card reader descriptions and part numbers

Description	Spare part number
Smart card reader	P33107-001
Cable kit, Computer (includes cables for USB board, smart card reader, audio jack, fingerprint reader, touchpad, and NFC module)	

Before removing the smart card reader, follow these steps:

1. Prepare the computer for disassembly (see [Preparation for disassembly on page 36](#)).
2. Remove the bottom cover (see [Bottom cover on page 36](#)).
3. Remove the battery (see [Battery on page 39](#)).

Remove the smart card reader:

1. Disconnect the smart card reader cable (ZIF) (1).
2. Remove the three Phillips M2.0 × 2.0 screws (2) that secure the smart card reader to the computer. .

- Remove the smart card reader (3) from the computer.

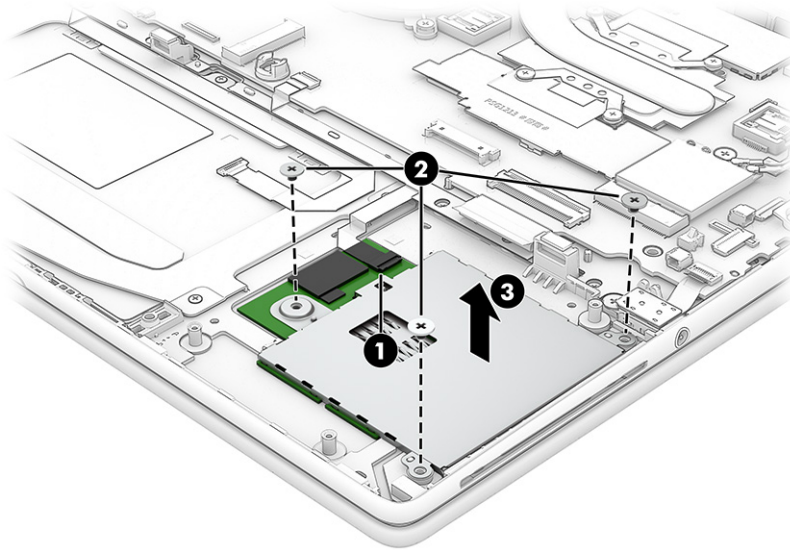

To install the smart card reader, reverse this procedure.

System board

To remove the system board, use these procedures and illustrations.

Table 6-9 System board descriptions and part numbers

Description	Spare part number
System board (includes processor):	
Intel Core Ultra5 225U processor, 16 GB system memory	P32685-601
Intel Core Ultra5 225U processor, 16 GB system memory (People's Republic of China)	P32686-601
Intel Core Ultra5 225U 16 GB system memory (WLAN)	P32687-601
Intel Core Ultra5 225U 16 GB system memory (People's Republic of China), (WLAN)	P32688-601
Intel Core Ultra5 225U 16 GB system memory (OSR)	P32689-601
Intel Core Ultra5 225U 32 GB system memory	P32690-601
Intel Core Ultra5 225U 32 GB system memory (People's Republic of China)	P32691-601
Intel Core Ultra5 225U 64 GB system memory	P32692-601
Intel Core Ultra5 225U 64 GB system memory (People's Republic of China)	P32693-601
Intel Core Ultra5 235U 16 GB system memory	P32694-601
Intel Core Ultra5 235U 16 GB system memory (People's Republic of China)	P32695-601
Intel Core Ultra5 235U 16 GB system memory (WLAN)	P32696-601
Intel Core Ultra5 235U 16 GB system memory (People's Republic of China, WLAN)	P32697-601
Intel Core Ultra5 235U 16 GB system memory (OSR)	P32698-601
Intel Core Ultra5 235U 32 GB system memory	P32699-601

Table 6-9 System board descriptions and part numbers (continued)

Description	Spare part number
Intel Core Ultra5 235U 32 GB system memory (People's Republic of China)	P32700-601
Intel Core Ultra5 235U 32 GB system memory (OSR)	P32701-601
Intel Core Ultra5 235U 64 GB system memory	P32702-601
Intel Core Ultra5 235U 64 GB system memory (People's Republic of China)	P32703-601
Intel Core Ultra5 235U 64 GB system memory (OSR)	P32704-601
Intel Core Ultra7 255U 16 GB system memory	P32705-601
Intel Core Ultra7 255U 16 GB system memory (People's Republic of China)	P32706-601
Intel Core Ultra7 255U 16 GB system memory (WLAN)	P32707-601
Intel Core Ultra7 255U 16 GB system memory (People's Republic of China, WLAN)	P32708-601
Intel Core Ultra7 255U 16 GB system memory (OSR)	P32709-601
Intel Core Ultra7 255U 32 GB system memory	P32710-601
Intel Core Ultra7 255U 32 GB system memory (People's Republic of China)	P32711-601
Intel Core Ultra7 255U 64 GB system memory	P32712-601
Intel Core Ultra7 255U 64 GB system memory (People's Republic of China)	P32713-601
Intel Core Ultra7 265U 16 GB system memory	P32714-601
Intel Core Ultra7 265U 16 GB system memory (People's Republic of China)	P32715-601
Intel Core Ultra7 265U 16 GB system memory (OSR)	P32716-601
Intel Core Ultra7 265U 32 GB system memory	P32717-601
Intel Core Ultra7 265U 32 GB system memory (People's Republic of China)	P32718-601
Intel Core Ultra7 265U 32 GB system memory (OSR)	P32719-601
Intel Core Ultra7 265U 64 GB system memory	P32720-601
Intel Core Ultra7 265U 64 GB system memory (People's Republic of China)	P32721-601
Intel Core Ultra7 265U 64 GB system memory (OSR)	P32722-601

Before removing the system board, follow these steps:

1. Prepare the computer for disassembly (see [Preparation for disassembly on page 36](#)).
2. Remove the bottom cover (see [Bottom cover on page 36](#)).
3. Remove the battery (see [Battery on page 39](#)).
4. Remove the fan (see [Fan on page 53](#)).
5. Remove the left and right I/O frames (see [Left and right I/O frames on page 55](#)).

When you replace the system board, be sure to remove the following components (as applicable) from the defective system board and install them on the replacement system board:

- Heat sink (see [Heat sink on page 54](#)).

- Solid-state drive (see [Solid-state drive on page 48](#))
- WWAN (see [WWAN module on page 46](#))
- WLAN (see [WLAN module on page 45](#))

Remove the system board:

1. Disconnect the following cables from the system board:
 - Fingerprint reader cable (ZIF) (select products only) **(1)**
 - Antenna cables from the WWAN module (select products only) **(2)**
 - Antenna cables from the WLAN module (select products only) **(3)**
 - Speaker cables **(4)**
 - Keyboard cable (ZIF) **(5)**
 - Battery cable **(6)**
 - Smart card reader cable (ZIF) **(7)**
 - Touchpad cable (ZIF) **(8)**
 - Keyboard backlight cable (ZIF) (select products only) **(9)**
 - NFC module cable (ZIF) **(10)**

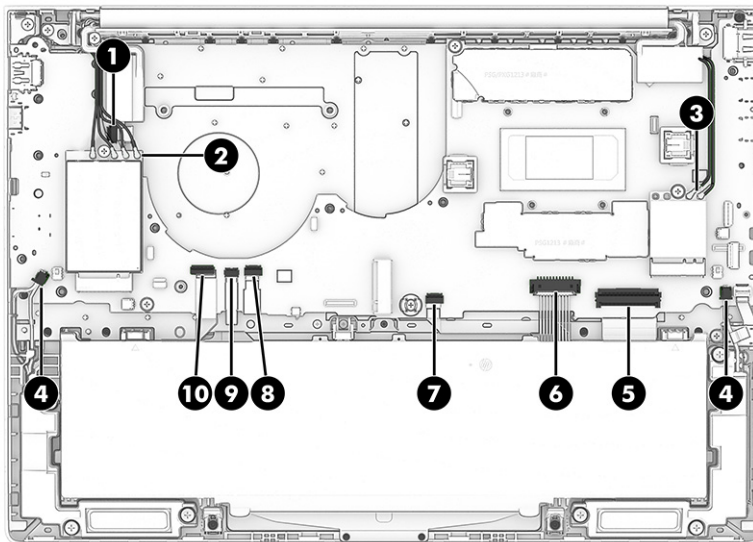

2. Remove the Phillips M1.6 × 2.7, the Phillips M2.0 × 4.0 screws, and the Phillips M2.0 × 2.0 screws that secure the system board to the computer, and then remove the system board.

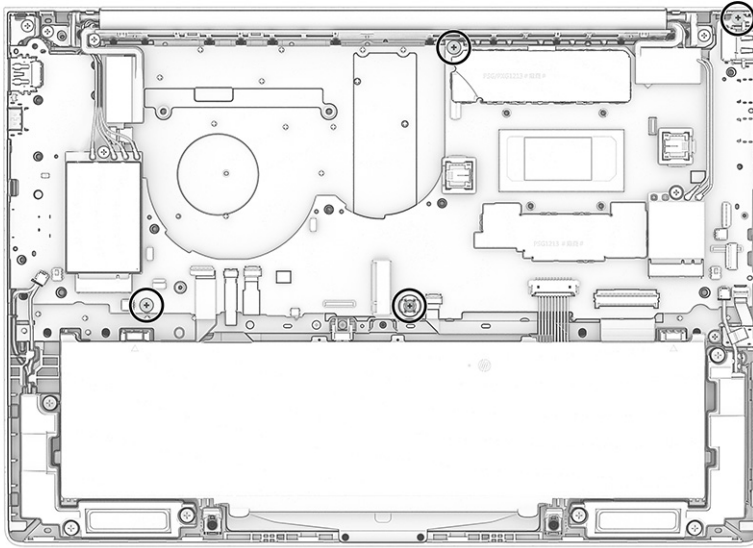

Carefully lift up the left side of the system board (1), and then slide it out (2).

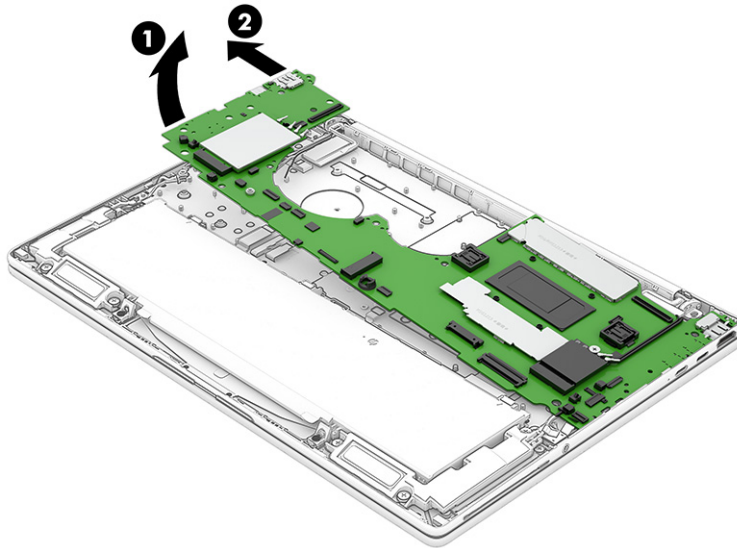

Reverse this procedure to install the system board.

Display assembly

To remove and disassemble the display assembly, use these procedures and illustrations.

Full hinge-up displays are not available as spare parts. Spare parts for displays are available only at the subcomponent level.

Before removing the display panel, follow these steps:

1. Prepare the computer for disassembly (see [Preparation for disassembly on page 36](#)).
2. Remove the bottom cover (see [Bottom cover on page 36](#)).
3. Remove the battery (see [Battery on page 39](#)).
4. Remove the system board (see [System board on page 59](#)).

Remove the display assembly:

1. Rotate the display upward to open the hinges (1).
2. Remove the five Phillips M2.0 × 4.0 screws (2) that secure the display assembly to the computer.
3. Separate the display assembly from the computer (3).

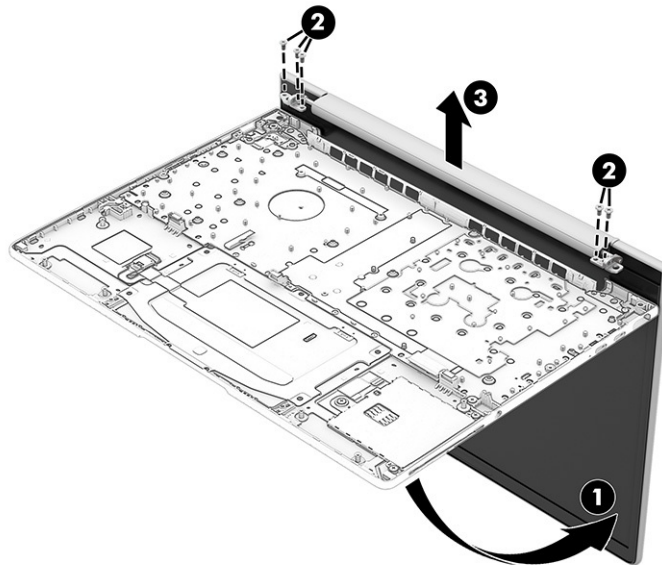

4. To remove the bezel:
 - a. Slide a flat tool (1) across the inside of the bottom of the bezel to release it.
 - b. Flex the top (2) and the inside edges of the left and right sides of the bezel to release it, and then remove the bezel from the display (3).

 **NOTE:** To avoid damaging the panel, do not use a tool to release the inside of the bezel. You can use a tool only when you insert it from the outside of the top, left, and right sides of the bezel. Use your fingers to lift up on the bezel. Avoid pressing down on the panel during removal.

The bezel is available as the following spare part numbers:

- P33114-001: For use on display assemblies equipped with infrared and ALS/ACS
- P33115-001: For use on display assemblies equipped with RGB camera and ALS/ACS
- P33116-001: For use on display assemblies equipped with microphone and no camera

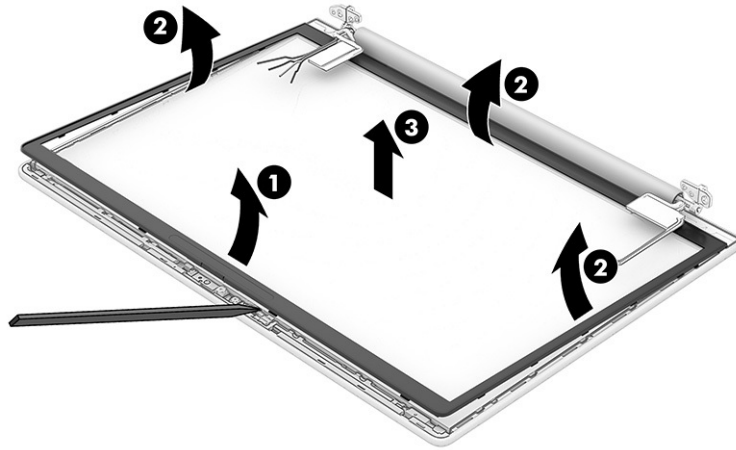

5. To remove the display panel:

- a. The display panel is secured to the display enclosure with tape that is installed under the left and right sides of the panel. To remove the panel, use tweezers to grasp the end of the tape (1). While turning the tweezers, wrap the tape around the tweezers (2) as you continue to pull the tape out from behind the display panel. You must pull the tape multiple times before it is completely removed.
- b. Rotate the display panel over and place it next to the display enclosure.

Display panels are available as the following spare part numbers:

P34139-001: Touchscreen display, 300 nits

P34138-001: Nontouchscreen display, 300 nits

P34140-001: Nontouchscreen display, 400 nits

P34141-001: Nontouchscreen display, 800 nits

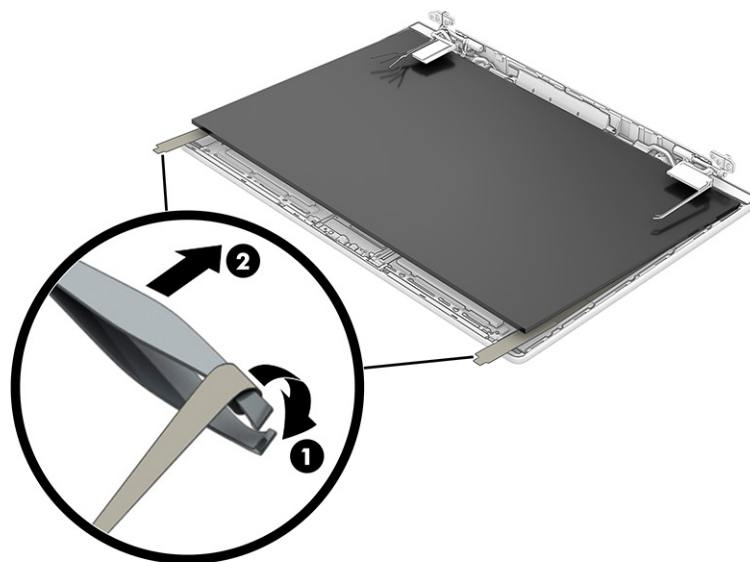

- c. Release the adhesive support strip (1) that secures the display panel cable to the back of the display panel.
- d. Release the retention bar (2) that secures the display panel cable to the back of the display panel.
- e. Remove the panel (3).

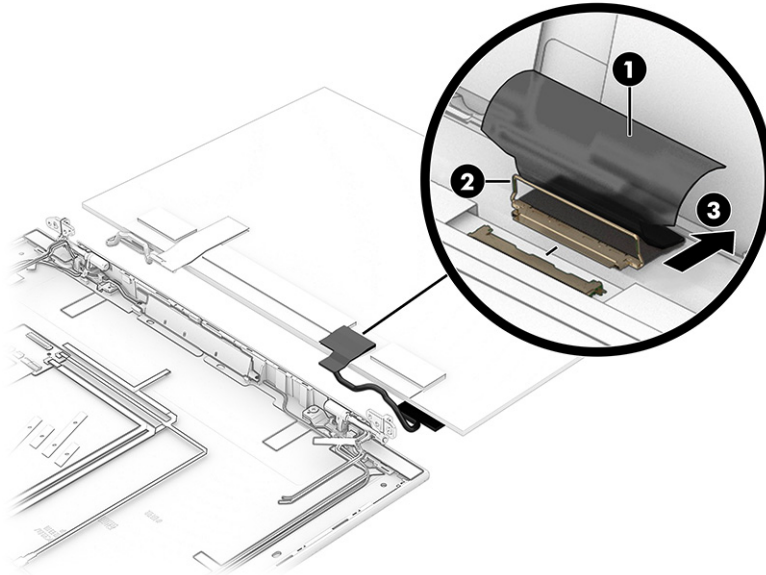

- f. When installing the display panel, install the adhesive strips on each side of the display back cover.



NOTE: When replacing the touch control board or display panel, be sure to update the touch firmware, available on the [HP product support](#) page.

- 6. To remove the camera module:
 - a. Disconnect the cable from the reverse ZIF connector on the module, lift up evenly across the module, and then peel the module up from the display back cover. The camera module is

available as spare part number P33123-001 (RGB camera with cable), or P33124-001 (infrared AI camera with cable).

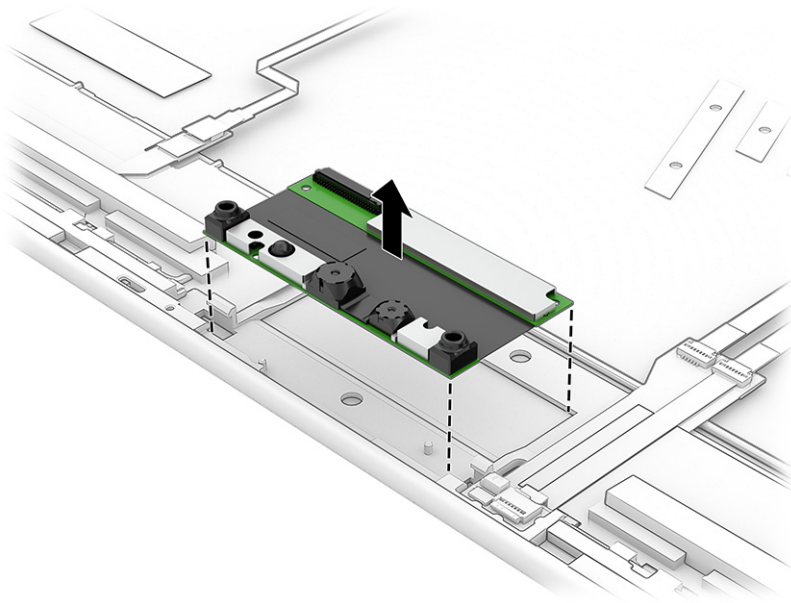

- b. To remove the camera cable, disconnect the cable from the connector on the back cover (1), remove the cable from the clip at the bottom of the display back cover (2), and then remove the cable (3).

Cables are available as the following spare part number:

P34037-001: Cable kit under panel

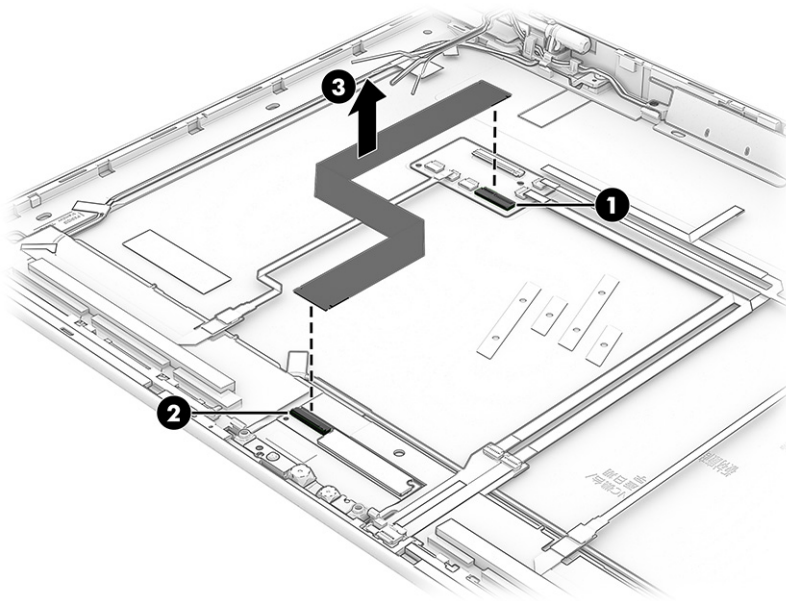

- 7. To remove the microphone module:

- a. Disconnect the cable from the reverse ZIF connector on the module, lift up evenly across the module, and then peel the module up from the display back cover. The microphone module is available as spare part number P33121-001.

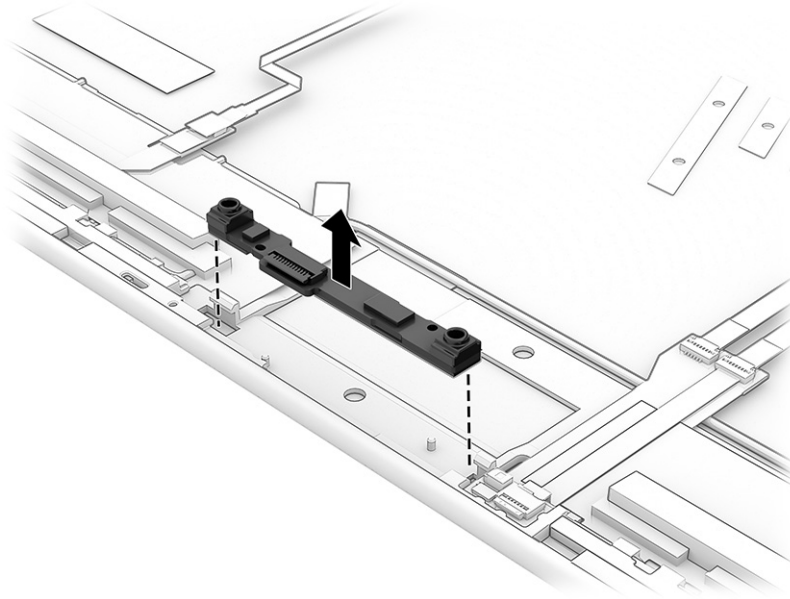

- b. To remove the microphone cable, disconnect the cable from the connector on the back cover (1), remove the cable from the clip at the bottom of the display back cover (2), and then remove the cable (3).

Cables are available as the following spare part number:

P33121-001: Cable included with microphone module

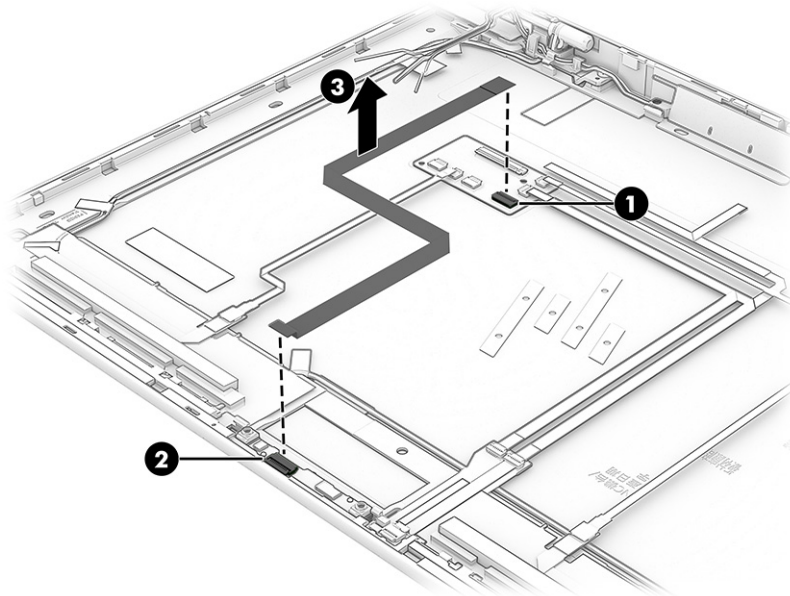

To reassemble and replace the display assembly, reverse this procedure.

Power button/fingerprint reader

To remove the power button/fingerprint reader, use this procedure and illustration.

Table 6-10 Power button/fingerprint reader description and part number

Description	Spare part number
Power button/fingerprint reader	P33136-001

Before removing the power button/fingerprint reader, follow these steps:

1. Prepare the computer for disassembly (see [Preparation for disassembly on page 36](#)).
2. Remove the bottom cover (see [Bottom cover on page 36](#)).
3. Disconnect the battery cable from the system board (see [Battery on page 39](#)).
4. Remove the system board (see [System board on page 59](#)).

Remove the power button/fingerprint reader:

1. Disconnect the cable from the ZIF connector.
2. Remove the power button/fingerprint reader from the computer



NOTE: Be sure to be gentle when you remove the power button/fingerprint reader from the keyboard.

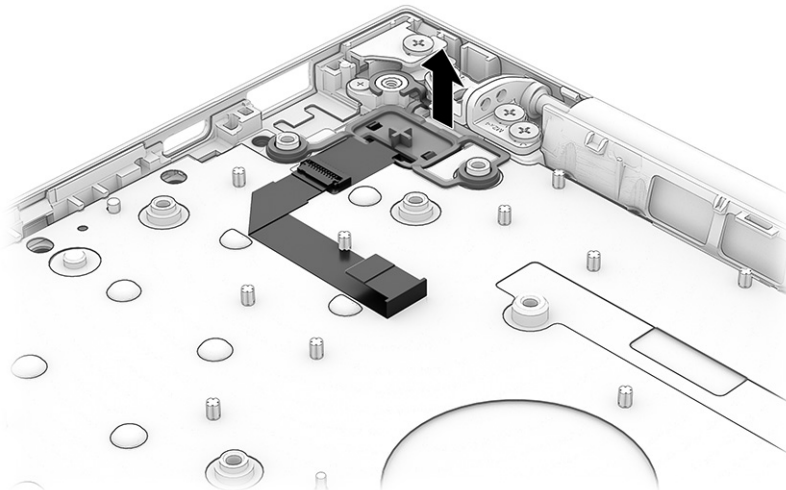

Power button (no fingerprint reader)

To remove the power button, use this procedure and illustration.

Table 6-11 Power button description and part number

Description	Spare part number
Power button (no fingerprint reader)	P34040-001

Before removing the power button, follow these steps:

1. Prepare the computer for disassembly (see [Preparation for disassembly on page 36](#)).
2. Remove the bottom cover (see [Bottom cover on page 36](#)).
3. Disconnect the battery cable from the system board (see [Battery on page 39](#)).
4. Remove the system board (see [System board on page 59](#)).

Remove the power button:

1. Disconnect the cable from the ZIF connector.
2. Remove the power button from the computer.

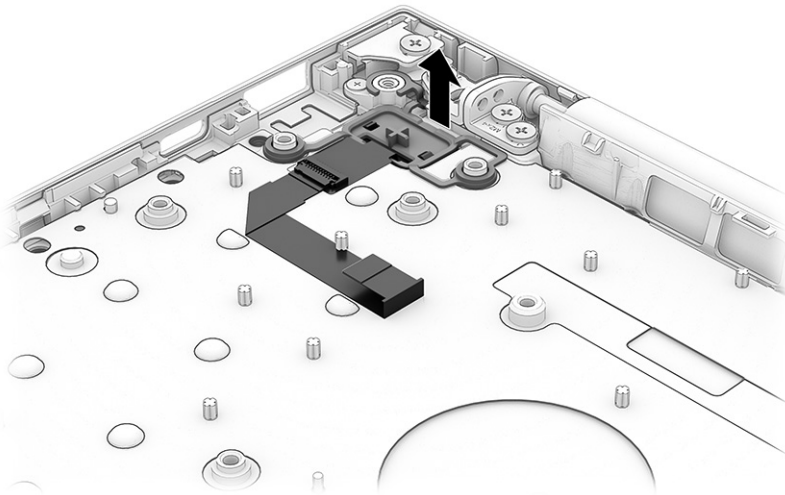

Keyboard removal

The keyboard remains after removing all other spare parts from the computer. In this section, the first table provides the main spare part numbers for the keyboards. The second table provides the country codes.

Table 6-12 Keyboard descriptions and part numbers

Description	Spare part number
Keyboard, backlit, spill-resistant	P39085-xx1
Keyboard with top cover, backlit, spill-resistant, privacy	P39086-xx1
Keyboard with top cover, not backlit, spill-resistant	P39087-xx1

Table 6-13 Spare part country codes

For use in country or region	Spare part number	For use in country or region	Spare part number	For use in country or region	Spare part number
Belgium	-A41	Iceland	-DD1	Saudi Arabia	-171
Brazil	-201	India	-D61	Slovenia	-BA1

Table 6-13 Spare part country codes (continued)

For use in country or region	Spare part number	For use in country or region	Spare part number	For use in country or region	Spare part number
Bulgaria	-261	Israel	-BB1	South Korea	-AD1
Chile	-161	Italy	-061	Spain	-071
Czech Republic/Slovakia	-FL1	Japan	-291	Switzerland	-BG1
Denmark, Finland, and Norway	-DH1	Kazakhstan	-DF1	Taiwan	-AB1
French Canada	-DB1	The Netherlands	-B31	Thailand	-281
France	-051	Northern Africa	-FP1	Turkey	-141
Germany	-041	Portugal	-131	Ukraine	-BD1
Greece	-151	Romania	-271	United Kingdom	-031
Hungary	-211	Russia	-251	United States	-001

Keyboard

To remove the keyboard, use this procedure and illustration.

Before removing the keyboard, follow these steps:

1. Prepare the computer for disassembly (see [Preparation for disassembly on page 36](#)).
2. Remove the bottom cover (see [Bottom cover on page 36](#)).
3. Remove the battery (see [Battery on page 39](#)).
4. Remove the system board (see [System board on page 59](#)).

Remove the keyboard:

1. Remove the 25 Phillips M1.6 × 1.8 screws and seven M1.6 × 2.5 screws **(1)** that secure the keyboard to the computer.

2. Remove the keyboard from the computer (2).

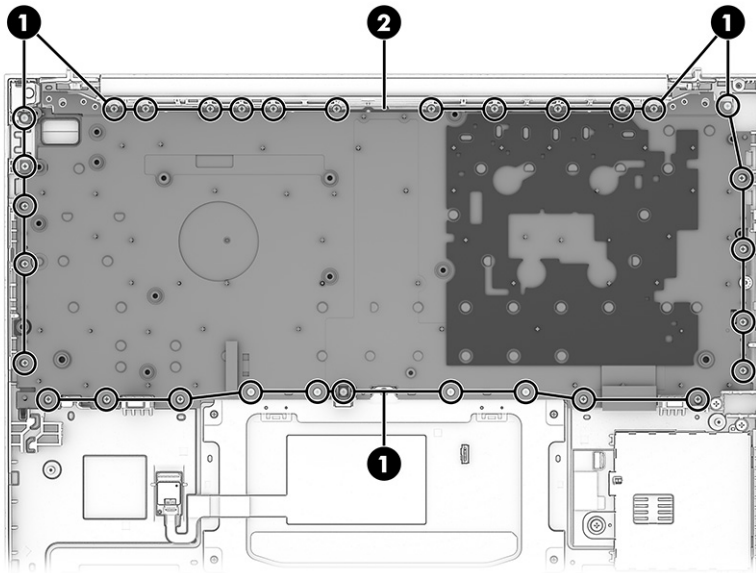

To install the keyboard, reverse this procedure.

7 Backing up, restoring, and recovering

You can use Windows tools or HP software to back up your information, create a restore point, reset your computer, create recovery media, or restore your computer to its factory state. Performing these standard procedures can return your computer to a working state faster.

 **IMPORTANT:** If you are performing recovery procedures on a tablet, the tablet battery must be at least 70% charged before you start the recovery process.

 **IMPORTANT:** For a tablet with a detachable keyboard, connect the tablet to the keyboard base before beginning any recovery process.

Backing up information and creating recovery media

These methods of creating recovery media and backups are available on select products only.

Using Windows tools for backing up

HP recommends that you back up your information immediately after initial setup. You can do this task either using Windows Backup locally with an external USB flash drive or using online tools.

 **NOTE:** If computer storage is 32 GB or less, Microsoft System Restore is disabled by default.

Using the HP Cloud Recovery Download Tool to create a recovery USB flash drive (select products only)

You can use the HP Cloud Recovery Download Tool to create an HP Recovery bootable USB flash drive.

For details:

- Go to <http://www.hp.com>, search for HP Cloud Recovery, and then select the result that matches the type of computer that you have and follow the on-screen instructions.

 **NOTE:** In select countries, if you cannot create the HP Recovery USB flash drive yourself, contact support. Go to <http://www.hp.com/support>, select your country or region, and then follow the on-screen instructions.

 **IMPORTANT:** HP recommends that you follow the [Restoring and recovery methods on page 73](#) to restore your computer before you obtain and use the HP USB flash drive. Using a recent backup can return your machine to a working state sooner than using the HP USB flash drive. After the system is restored, reinstalling all the operating system software released since your initial purchase can be a lengthy process.

Restoring and recovering your system

You have several tools available to recover your system both within and outside of Windows if the desktop cannot load.

HP recommends that you attempt to restore your system using the [Restoring and recovery methods on page 73](#).

Creating a system restore

System Restore is available in Windows. The System Restore software can automatically or manually create restore points, or snapshots, of the system files and settings on the computer at a particular point.

When you use System Restore, it returns your computer to its state at the time you made the restore point. Your personal files and documents should not be affected.

Restoring and recovery methods

After you run the first method, test to see whether the issue still exists before you proceed to the next method, which might now be unnecessary.

1. Run a Microsoft System Restore.
2. Run Reset this PC.

 **NOTE:** The options **Remove everything** and then **Fully clean the drive** can take several hours to complete and leave no information on your computer. It is the safest way to reset your computer before you recycle it.

3. Recover using the HP Recovery USB flash drive. For more information, see [Recovering using the HP Recovery USB flash drive on page 73](#).

For more information about the first two methods, see the Get Help app:

- Select the **Start** button, select **All apps**, select the **Get Help** app, and then enter the task you want to perform.

 **NOTE:** You must be connected to the internet to access the Get Help app.

Recovering using the HP Recovery USB flash drive

You can use the HP Recovery USB flash drive to recover the operating system and drivers that were installed at the factory. On select products, you can create recovery media on a bootable USB flash drive using the HP Cloud Recovery Download Tool.

For details, see [Using the HP Cloud Recovery Download Tool to create a recovery USB flash drive \(select products only\) on page 72](#).

 **NOTE:** In select countries, if you cannot create the HP Recovery USB flash drive yourself, contact support. Go to <http://www.hp.com/support>, select your country or region, and then follow the on-screen instructions.

To recover your system:

- Insert the HP Recovery USB flash drive, and then restart the computer.

 **NOTE:** HP recommends that you follow the [Restoring and recovery methods on page 73](#) to restore your computer before you obtain and use the HP USB flash drive. Using a recent backup can return your machine to a working state sooner than using the HP USB flash drive. After the system is restored, reinstalling all the operating system software released since your initial purchase can be a lengthy process.

Changing the computer boot order

If your computer does not restart using the HP Recovery USB flash drive, you can change the computer boot order, which is the order of devices listed in BIOS for startup information.

 **IMPORTANT:** For a tablet with a detachable keyboard, connect the tablet to the keyboard base before beginning these steps.

To change the boot order:

1. Insert the HP Recovery USB flash drive.
2. Access the system **Startup** menu.
 - For computers or tablets with keyboards attached, turn on or restart the computer or tablet, quickly press **esc**, and then press **f9** for boot options.
 - For tablets without keyboards, turn on or restart the tablet, and then quickly press and hold one of the following buttons:
 - Volume up
 - Volume down

Then select **f9**.
3. Select the USB flash drive to boot from, and then follow the on-screen instructions.

Using HP Sure Recover (select products only)

Select computer models are configured with HP Sure Recover, a PC operating system (OS) recovery solution built into the hardware and software. HP Sure Recover can fully restore the HP OS image without installed recovery software.

Using HP Sure Recover, an administrator or user can restore the system and install:

- Latest version of the operating system
- Platform-specific device drivers
- Software applications, in the case of a custom image

To access the latest documentation for HP Sure Recover, go to <http://www.hp.com/support>. Follow the on-screen instructions to find your product and locate your documentation.

8 Computer Setup (BIOS), TPM, and HP Sure Start

HP provides several tools to help set up and protect your computer.

Using Computer Setup

Computer Setup, or Basic Input/Output System (BIOS), controls communication between all the input and output devices on the system (such as hard drives, display, keyboard, mouse, and printer). Computer Setup includes settings for types of devices installed, the startup sequence of the computer, and amount of system and extended memory.

 **NOTE:** Use extreme care when making changes in Computer Setup. Errors can prevent the computer from operating properly.

To start Computer Setup, turn on or restart the computer, and when the HP logo appears, press **F10** to enter Computer Setup.

Navigating and selecting in Computer Setup

You can navigate and select in Computer Setup using one or more methods.

- To select a menu or a menu item, use the **tab** key and the keyboard arrow keys and then press **enter**, or use a pointing device to select the item.
- To scroll up and down, select the up arrow or the down arrow in the upper-right corner of the screen, or use the up arrow key or the down arrow key on the keyboard.
- To close open dialog boxes and return to the main Computer Setup screen, press **esc**, and then follow the on-screen instructions.

To exit Computer Setup, choose one of the following methods:

- To exit Computer Setup menus without saving your changes, select **Main**, select **Ignore Changes and Exit**, and then select **Yes**.

 **NOTE:** If you are using arrow keys to highlight your choice, you must then press **enter**.

- To save your changes and exit Computer Setup menus, select **Main**, select **Save Changes and Exit**, and then select **Yes**.

 **NOTE:** If you are using arrow keys to highlight your choice, you must then press **enter**.

Your changes go into effect when the computer restarts.

Restoring factory settings in Computer Setup

To return all settings in Computer Setup to the values that were set at the factory, follow these steps.

 **NOTE:** Restoring defaults will not change the hard drive mode.

1. Start Computer Setup. See [Using Computer Setup on page 75](#).
2. Select **Main**, select **Apply Factory Defaults and Exit**, and then select **Yes**.

 **NOTE:** If you are using arrow keys to highlight your choice, you must then press **enter**.

 **NOTE:** On select products, the selections might display **Restore Defaults** instead of **Apply Factory Defaults and Exit**.

Your changes go into effect when the computer restarts.

 **NOTE:** Your password settings and security settings are not changed when you restore the factory settings.

Updating the BIOS

Updated versions of the BIOS might be available on the HP website. Most BIOS updates on the HP website are packaged in compressed files called *SoftPaqs*.

Some download packages contain a file named Readme.txt, which contains information regarding installing and troubleshooting the file.

Determining the BIOS version

To decide whether you need to update Computer Setup (BIOS), first determine the BIOS version on your computer.

If you are already in Windows, you can access BIOS version information (also known as *ROM date* and *System BIOS*) by pressing **fn+esc** (select products only). Or you can use Computer Setup.

1. Start Computer Setup. See [Using Computer Setup on page 75](#).
2. Select **Main**, and then select **System Information**.
3. To exit Computer Setup menus without saving your changes, select **Main**, select **Ignore Changes and Exit**, and then select **Yes**.

 **NOTE:** If you are using arrow keys to highlight your choice, you must then press **enter**.

To check for later BIOS versions, see [Preparing for a BIOS update on page 76](#).

Preparing for a BIOS update

Be sure to follow all prerequisites before downloading and installing a BIOS update.

 **IMPORTANT:** To reduce the risk of damage to the computer or an unsuccessful installation, download and install a BIOS update only when the computer is connected to the following types of reliable external power:

- The HP AC adapter provided with the computer (select products only)
 - A replacement AC adapter provided by HP
 - An AC adapter with the power rating specified on the product label
-

Do not download or install a BIOS update while the computer is operating under these circumstances:

- Running on battery power

- Docked in an optional docking device
- Connected to an optional docking power source

During the download and installation, follow these instructions:

- Do not disconnect power on the computer by unplugging the power cord from the AC outlet.
- Do not shut down the computer or initiate Sleep.
- Do not insert, remove, connect, or disconnect any device, cable, or cord.

Downloading a BIOS update

After you review the prerequisites, you can check for and download BIOS updates.

1. Perform one of these tasks:
 - Select the **Search** icon in the taskbar, type `support` in the search box, and then select the **HP Support Assistant** app.
 - Select the question mark icon (select products only) in the taskbar.
2. Select **Updates**, and then select **Check for updates and messages**.
3. Follow the on-screen instructions.
4. At the download area, follow these steps:
 - a. Identify the most recent BIOS update and compare it to the BIOS version currently installed on your computer. Make a note of the date, name, or other identifier. You might need this information to locate the update later, after it has been downloaded to your hard drive.
 - b. Follow the on-screen instructions to download your selection to the hard drive.

Make a note of the path to the location on your hard drive where the BIOS update is downloaded. You will need to access this path when you are ready to install the update.



NOTE: If you connect your computer to a network, consult the network administrator before installing any software updates, especially system BIOS updates.

Installing a BIOS update

BIOS installation procedures vary. Follow any instructions that are displayed on the screen after the download is complete. If no instructions are displayed, follow these steps.

1. Select the **Search** icon in the taskbar, type `file` in the search box, and then select **File Explorer**.
2. Select your hard drive designation. The hard drive designation is typically Local Disk (C:).
3. Using the hard drive path you recorded earlier, open the folder that contains the update.
4. Double-click the file that has an `.exe` extension (for example, `filename.exe`).
The BIOS installation begins.
5. Complete the installation by following the on-screen instructions.



NOTE: After a message on the screen reports a successful installation, you can delete the downloaded file from your hard drive.

Changing the boot order using the f9 prompt

To dynamically choose a boot device for the current startup sequence, follow these steps.

1. Access the Boot Device Options menu:
 - Turn on or restart the computer, and when the HP logo appears, press **f9** to enter the Boot Device Options menu.
2. Select a boot device, press **enter**, and then follow the on-screen instructions.

TPM BIOS settings (select products only)

TPM provides additional security for your computer. You can modify the TPM settings in Computer Setup (BIOS).

 **IMPORTANT:** Before enabling Trusted Platform Module (TPM) functionality on this system, you must ensure that your intended use of TPM complies with relevant local laws, regulations and policies, and approvals or licenses must be obtained if applicable. For any compliance issues arising from your operation or usage of TPM that violates the previously mentioned requirement, you shall bear all the liabilities wholly and solely. HP will not be responsible for any related liabilities.

 **NOTE:** If you change the TPM setting to Hidden, TPM is not visible in the operating system.

To access TPM settings in Computer Setup:

1. Start Computer Setup. See [Using Computer Setup on page 75](#).
2. Select **Security**, select **TPM Embedded Security**, and then follow the on-screen instructions.

Using HP Sure Start (select products only)

Select computer models are configured with HP Sure Start, a technology that monitors the computer's BIOS for attacks or corruption. If the BIOS becomes corrupted or is attacked, HP Sure Start automatically restores the BIOS to its previously safe state, without user intervention.

HP Sure Start is configured and already enabled so that most users can use the HP Sure Start default configuration. Advanced users can customize the default configuration.

To access the latest documentation on HP Sure Start, go to <http://www.hp.com/support>. Select **Find your product**, and then follow the on-screen instructions.

9 Using HP PC Hardware Diagnostics

You can use the HP PC Hardware Diagnostics utility to determine whether your computer hardware is running properly. The three versions are HP PC Hardware Diagnostics Windows, HP PC Hardware Diagnostics UEFI (Unified Extensible Firmware Interface), and (for select products only) Remote HP PC Hardware Diagnostics UEFI, a firmware feature.

Using HP PC Hardware Diagnostics Windows (select products only)

HP PC Hardware Diagnostics Windows is a Windows-based utility that allows you to run diagnostic tests to determine whether the computer hardware is functioning properly. The tool runs within the Windows operating system to diagnose hardware failures.

If HP PC Hardware Diagnostics Windows is not installed on your computer, you must download and install it. To download HP PC Hardware Diagnostics Windows, see [Downloading HP PC Hardware Diagnostics Windows on page 80](#).

Using an HP PC Hardware Diagnostics Windows hardware failure ID code

When HP PC Hardware Diagnostics Windows detects a failure that requires hardware replacement, a 24-digit failure ID code is generated for select component tests. For interactive tests, such as keyboard, mouse, or audio and video palette, you must perform troubleshooting steps before you can receive a failure ID.

You have several options after you receive a failure ID:

- Select **Next** to open the Event Automation Service (EAS) page, where you can log the case.
- Scan the QR code with your mobile device, which takes you to the EAS page, where you can log the case.
- Select the box next to the 24-digit failure ID to copy your failure code and send it to support.

Accessing HP PC Hardware Diagnostics Windows

After HP PC Hardware Diagnostics Windows is installed, you can access it from HP Support Assistant or the Start menu.

Accessing HP PC Hardware Diagnostics Windows from HP Support Assistant

After HP PC Hardware Diagnostics Windows is installed, follow these steps to access it from HP Support Assistant:

1. Complete one of the following tasks:
 - Select the **Search** icon in the taskbar, type `support` in the search box, and then select the **HP Support Assistant** app.
 - Select the question mark icon in the taskbar.
2. Select **Fixes & Diagnostics**.

3. Select **Run hardware diagnostics**, and then select **Launch**.
4. When the tool opens, select the type of diagnostic test that you want to run, and then follow the on-screen instructions.

 **NOTE:** To stop a diagnostic test, select **Cancel**.

Accessing HP PC Hardware Diagnostics Windows from the Start menu (select products only)

After HP PC Hardware Diagnostics Windows is installed, follow these steps to access it from the Start menu:

1. Select the **Start** button, and then select **All apps**.
2. Select **HP PC Hardware Diagnostics Windows**.
3. When the tool opens, select the type of diagnostic test that you want to run, and then follow the on-screen instructions.

 **NOTE:** To stop a diagnostic test, select **Cancel**.

Downloading HP PC Hardware Diagnostics Windows

The HP PC Hardware Diagnostics Windows downloading instructions are provided in English only. You must use a Windows computer to download this tool because only .exe files are provided.

Downloading the latest HP PC Hardware Diagnostics Windows version from HP

To download HP PC Hardware Diagnostics Windows from HP, follow these steps:

1. Go to <http://www.hp.com/go/techcenter/pcdiags>. The HP PC Diagnostics home page is displayed.
2. Select **Diagnose PC Hardware issues in Windows**, scroll down to the expanded window that appears, and then select **Download**.
3. A pop-up that asks what you want to do with the file opens. Select **Open** or **Save As**. The latest version of the diagnostics tool opens or downloads to the selected location.

Downloading the HP PC Hardware Diagnostics Windows from the Microsoft Store

You can download the HP PC Hardware Diagnostics Windows from the Microsoft Store:

1. Select the Microsoft Store app on your desktop or select the **Search** icon in the taskbar, and then type `Microsoft Store` in the search box.
2. Type `HP PC Hardware Diagnostics Windows` in the **Microsoft Store** search box.
3. Follow the on-screen directions.

The tool downloads to the selected location.

Downloading HP Hardware Diagnostics Windows by product name or number (select products only)

You can download HP PC Hardware Diagnostics Windows by product name or number.

 **NOTE:** For some products, you might have to download the software to a USB flash drive by using the product name or number.

1. Go to <http://www.hp.com/support>.
2. Select **Software and Drivers**, select your type of product, and then enter the product name or number in the search box that is displayed.
3. In the **Diagnostics** section, select **Download**, and then follow the on-screen instructions to select the specific Windows diagnostics version to be downloaded to your computer or USB flash drive.

The tool downloads to the selected location.

Installing HP PC Hardware Diagnostics Windows

To install HP PC Hardware Diagnostics Windows, navigate to the folder on your computer or the USB flash drive where the .exe file downloaded, double-click the .exe file, and then follow the on-screen instructions.

Using HP PC Hardware Diagnostics UEFI

HP PC Hardware Diagnostics Unified Extensible Firmware Interface (UEFI) allows you to run diagnostic tests to determine whether the computer hardware is functioning properly. The tool runs outside the operating system so that it can isolate hardware failures from issues that are caused by the operating system or other software components.

 **NOTE:** For some products, you must use a Windows computer and a USB flash drive to download and create the HP UEFI support environment because only .exe files are provided. For more information, see [Downloading HP PC Hardware Diagnostics UEFI to a USB flash drive on page 82](#).

If your PC does not start in Windows, you can use HP PC Hardware Diagnostics UEFI to diagnose hardware issues.

Using an HP PC Hardware Diagnostics UEFI hardware failure ID code

When HP PC Hardware Diagnostics UEFI detects a failure that requires hardware replacement, a 24-digit failure ID code is generated.

For assistance in solving the problem, complete one of these tasks:

- Select **Contact HP**, accept the HP privacy disclaimer, and then use a mobile device to scan the failure ID code that appears on the next screen. The HP Customer Support - Service Center page appears with your failure ID and product number automatically filled in. Follow the on-screen instructions.
- Contact support, and provide the failure ID code.

Starting HP PC Hardware Diagnostics UEFI

To start HP PC Hardware Diagnostics UEFI, follow this procedure.

1. Turn on or restart the computer, and quickly press **esc**.
2. Press **f2**.

The BIOS searches three places for the diagnostic tools, in the following order:

- a. Connected USB flash drive



NOTE: To download the HP PC Hardware Diagnostics UEFI tool to a USB flash drive, see [Downloading the latest HP PC Hardware Diagnostics UEFI version on page 83](#).

- b. Hard drive

- c. BIOS

3. When the diagnostic tool opens, select the type of diagnostic test that you want to run, and then follow the on-screen instructions.

Starting HP PC Hardware Diagnostics UEFI through HP Hotkey Support software (select products only)

This section describes how to start HP PC Hardware Diagnostics UEFI through HP Hotkey Support software.



NOTE: You must disable fast boot to access HP PC Hardware Diagnostics UEFI from the HP System Information application.

To disable fast boot:

1. Turn on or restart the computer, and when the HP logo appears, press **f10** to enter Computer Setup.
2. Select **Advanced**, and then select **Boot Options**.
3. Clear **Fast Boot**.
4. Select **Save Changes and Exit**, and then select **Yes**.

To start HP PC Hardware Diagnostics UEFI through HP Hotkey Support software, follow this procedure:

1. From the **Start** menu, open the HP System Information Application or press **fn+esc**.
2. In HP System Information screen, select **Run System Diagnostics**, select **Yes** to run the application, and then select **Restart**.



IMPORTANT: To prevent loss of data, save your work in all open apps before restarting your computer.



NOTE: When the restart is complete, the computer opens the HP PC Hardware Diagnostics UEFI Application. Proceed with the troubleshooting tests.

Downloading HP PC Hardware Diagnostics UEFI to a USB flash drive

Downloading HP PC Hardware Diagnostics UEFI to a USB flash drive can be useful in some situations.

- HP PC Hardware Diagnostics UEFI is not included in the preinstallation image.
- HP PC Hardware Diagnostics UEFI is not included in the HP Tool partition.

- The hard drive is damaged.



NOTE: The HP PC Hardware Diagnostics UEFI downloading instructions are provided in English only, and you must use a Windows computer to download and create the HP UEFI support environment because only .exe files are provided.

Downloading the latest HP PC Hardware Diagnostics UEFI version

To download the latest HP PC Hardware Diagnostics UEFI version to a USB flash drive, follow these steps:

1. Go to <http://www.hp.com/go/techcenter/pcdiags>. The HP PC Diagnostics home page is displayed.
2. Select **Diagnose PC Hardware Issues outside of the OS**, scroll down to the expanded window that appears, and then select **Download**.
3. A pop-up that asks what you want to do with the file opens. Select **Open** or **Save As**. The latest version of the diagnostics tool opens or downloads to the selected location.

Downloading HP PC Hardware Diagnostics UEFI by product name or number (select products only)

You can download HP PC Hardware Diagnostics UEFI by product name or number (select products only) to a USB flash drive.



NOTE: For some products, you might have to download the software to a USB flash drive by using the product name or number.

1. Go to <http://www.hp.com/support>.
2. Enter the product name or number, select your computer, and then select your operating system.
3. In the **Diagnostics** section, follow the on-screen instructions to select and download the specific UEFI Diagnostics version for your computer.

Using Remote HP PC Hardware Diagnostics UEFI settings (select products only)

Remote HP PC Hardware Diagnostics UEFI is a firmware (BIOS) feature that downloads HP PC Hardware Diagnostics UEFI to your computer. It can then run the diagnostics on your computer, and it might upload results to a preconfigured server.

For more information about Remote HP PC Hardware Diagnostics UEFI, go to <http://www.hp.com/go/techcenter/pcdiags>, select **Diagnose Other Potential Issues**, scroll down to **Remote PC Hardware Diagnostics UEFI**, and then select **Learn More**.

Downloading Remote HP PC Hardware Diagnostics UEFI

Remote HP PC Hardware Diagnostics UEFI is also available as a SoftPaq that you can download to a server.

Downloading the latest Remote HP PC Hardware Diagnostics UEFI version

You can download the latest Remote HP PC Hardware Diagnostics UEFI version to a USB flash drive.

1. Go to <http://www.hp.com/go/techcenter/pcdiags>. The HP PC Diagnostics home page is displayed.

2. Select **Diagnose PC Hardware Issues outside of the OS**, scroll down to the expanded window that appears, and then select **Download**.
3. A pop-up that asks what you want to do with the file opens. Select **Open** or **Save As**. The latest version of the diagnostics tool opens or downloads to the selected location.

Downloading Remote HP PC Hardware Diagnostics UEFI by product name or number

You can download Remote HP PC Hardware Diagnostics UEFI by product name or number.



NOTE: For some products, you might have to download the software by using the product name or number.

1. Go to <http://www.hp.com/support>.
2. Select **Software and Drivers**, select your type of product, enter the product name or number in the search box that is displayed, select your computer, and then select your operating system.
3. In the **Diagnostics** section, follow the on-screen instructions to select and download the **Remote UEFI** version for the product.

Customizing Remote HP PC Hardware Diagnostics UEFI settings

Using the Remote HP PC Hardware Diagnostics setting in Computer Setup (BIOS), you can perform several customizations.

- Set a schedule for running diagnostics unattended. You can also start diagnostics immediately in interactive mode by selecting **Execute Remote HP PC Hardware Diagnostics UEFI**.
- Set the location for downloading the diagnostic tools. This feature provides access to the tools from the HP website or from a server that has been preconfigured for use. Your computer does not require the traditional local storage, such as a hard drive or USB flash drive, to run remote diagnostics.
- Set a location for storing the test results. You can also set the user name and password that you use for uploads.
- Display status information about the diagnostics run previously.

To customize Remote HP PC Hardware Diagnostics UEFI settings, follow these steps:

1. Turn on or restart the computer, and when the HP logo appears, press **f10** to enter Computer Setup.
2. Select **Advanced**, and then select **Settings**.
3. Make your customization selections.
4. Select **Main**, then select **Save Changes and Exit** to save your settings.

Your changes take effect when the computer restarts.

10 Specifications

This chapter provides specifications for your computer system.

Computer specifications

This section provides specifications for your computer. When you travel with your computer, the computer dimensions and weights, as well as input power ratings and operating specifications, provide helpful information.

Table 10-1 Computer specifications

	Metric	U.S.
Dimensions		
Width	301.8 mm	11.9 in
Depth	214.9 mm	8.4 in
Height (front to back)	18.9 mm	0.7 in
Weight		
	1.29 kg	2.8 lb
Input power		
Operating voltage and current	19.5 V DC @ 2.31 A - 45 W	
	19.5 V DC @ 3.33 A - 65 W	
Temperature		
Operating	0°C to 35°C	32°F to 95°F
Nonoperating	-20°C to 60°C	-4°F to 140°F
Relative humidity (noncondensing)		
Operating	10% to 90%	
Nonoperating	5% to 95%	
Maximum altitude (unpressurized)		
Operating	-15 m to 3,048 m	-50 ft to 10,000 ft
Nonoperating	-15 m to 12,192 m	-50 ft to 40,000 ft

 **NOTE:** Applicable product safety standards specify thermal limits for plastic surfaces. The device operates well within this range of temperatures.

Display specifications

This section provides specifications for your display.

Table 10-2 Display specifications

	Metric	U.S.
Active diagonal size	33.8 cm	13.3 in
Resolution	1920 × 1200 (WUXGA)	
Surface treatment	Antiglare	
Brightness	300 nits 400 nits 800 nits	
Viewing angle	UWVA	
Backlight	WLED	
Display panel interface	eDP	

Solid-state drive specifications

This section provides specifications for your solid-state drives.

Table 10-3 Solid-state drive specifications

	256 GB*	512 GB*	1TB*
Dimensions			
Height	1.0 mm	1.0 mm	1.0 mm
Length	50.8 mm	50.8 mm	50.8 mm
Width	28.9 mm	28.9 mm	28.9 mm
Weight	< 10 g	< 10 g	< 10 g
Interface type			
Ready time, maximum (to not busy)	1.0 ms	< 1.0 ms	1.0 ms
Access times, logical	0.1 ms	0.1 ms	0.1 ms
Transfer rate			
Sequential read	up to 2150 MBps	up to 2150 MBps	up to 2150 MBps
Random read	Up to 300,000 IOPs	Up to 300,000 IOPs	Up to 300,000 IOPs
Sequential write	up to 1550 MBps	up to 1550 MBps	up to 1550 MBps
Random write	Up to 100,000 IOPs	Up to 100,000 IOPs	Up to 100,000 IOPs
Total logical sectors	468,883,296	1,000,215,216	1,500,336,388
Operating temperature	0°C to 70°C (32°F to 158°F)	0°C to 70°C (32°F to 158°F)	0°C to 70°C (32°F to 158°F)

*1 GB = 1 billion bytes when referring to hard drive storage capacity. Actual accessible capacity is less. Actual drive specifications might differ slightly.



NOTE: Certain restrictions and exclusions apply. Contact support for details.

11 Statement of memory volatility

For general information regarding nonvolatile memory in HP business computers, and to restore nonvolatile memory that can contain personal data after the system has been turned off and the hard drive has been removed, use these instructions.

HP business computer products that use Intel®-based or AMD®-based system boards contain volatile DDR memory. The amount of nonvolatile memory present in the system depends upon the system configuration. Intel-based and AMD-based system boards contain nonvolatile memory subcomponents as originally shipped from HP, with the following assumptions:

- No subsequent modifications were made to the system.
- No applications, features, or functionality were added to or installed on the system.

Following system shutdown and removal of all power sources from an HP business computer system, personal data can remain on volatile system memory (DIMMs) for a finite period of time and also remains in nonvolatile memory. Use the following steps to remove personal data from the computer, including the nonvolatile memory found in Intel-based and AMD-based system boards.

 **NOTE:** If your tablet has a keyboard base, connect to the keyboard base before beginning steps in this chapter.

Current BIOS steps

Use these instructions to restore nonvolatile memory.

1. Follow these steps to restore the nonvolatile memory that can contain personal data. Restoring or reprogramming nonvolatile memory that does not store personal data is neither necessary nor recommended.
 - a. Turn on or restart the computer, and then quickly press **esc**.

 **NOTE:** If the system has a BIOS administrator password, type the password at the prompt.

- b. Select **Main**, select **Apply Factory Defaults and Exit**, and then select **Yes** to load defaults. The computer restarts.
- c. During the restart, press **esc** while the "Press the ESC key for Startup Menu" message is displayed at the bottom of the screen.

 **NOTE:** If the system has a BIOS administrator password, type the password at the prompt.

- d. Select the **Security** menu, select **Restore Security Settings to Factory Defaults**, and then select **Yes** to restore security level defaults. The computer restarts.
- e. During the restart, press **esc** while the "Press the ESC key for Startup Menu" message is displayed at the bottom of the screen.

 **NOTE:** If the system has a BIOS administrator password, type the password at the prompt.

- f. If an asset or ownership tag is set, select the **Security** menu and scroll down to the **Utilities** menu. Select **System IDs**, and then select **Asset Tracking Number**. Clear the tag, and then make the selection to return to the prior menu.
- g. If a DriveLock password is set, select the **Security** menu, and scroll down to **Hard Drive Utilities** under the **Utilities** menu. Select **Hard Drive Utilities**, select **DriveLock**, and then clear the check box for **DriveLock password on restart**. Select **OK** to proceed.
- h. Select the **Main** menu, and then select **Reset BIOS Security to factory default**. Select **Yes** at the warning message. The computer restarts.
- i. During the restart, press **esc** while the "Press the ESC key for Startup Menu" message is displayed at the bottom of the screen.



NOTE: If the system has a BIOS administrator password, type the password at the prompt.

- j. Select the **Main** menu, select **Apply Factory Defaults and Exit**, select **Yes** to save changes and exit, and then select **Shutdown**.
 - k. Restart the system. If the system has a Trusted Platform Module (TPM), fingerprint reader, or both, one or two prompts will appear—one to clear the TPM and the other to Reset Fingerprint Sensor. Press or tap **f1** to accept or **f2** to reject.
 - l. Remove all power and system batteries for at least 24 hours.
2. Complete one of the following tasks:
- Remove and retain the storage drive.
 - Clear the drive contents by using a third-party utility designed to erase data from an SSD.
 - Clear the contents of the drive by using the following BIOS Setup Secure Erase command option steps:



NOTE: If you clear data using Secure Erase, you cannot recover it.

- a. Turn on or restart the computer, and then quickly press **esc**.
- b. Select the **Security** menu and scroll down to the **esc** menu.
- c. Select **Hard Drive Utilities**.
- d. Finish by completing one of these tasks:
 - Under **Utilities**, select **Secure Erase**, select the hard drive storing the data you want to clear, and then follow the on-screen instructions to continue.
 - Clear the contents of the drive using the following Disk Sanitizer commands steps:
 - i. Turn on or restart the computer, and then quickly press **esc**.
 - ii. Select the **Security** menu and scroll down to the **Utilities** menu.
 - iii. Select **Hard Drive Utilities**.

- iv. Under **Utilities**, select **Disk Sanitizer**, select the hard drive with the data that you want to clear, and then follow the on-screen instructions to continue.



NOTE: The amount of time it takes for Disk Sanitizer to run can take several hours. Plug the computer into an AC outlet before starting.

Nonvolatile memory usage

Use this table to troubleshoot nonvolatile memory usage.

Table 11-1 Troubleshooting information for nonvolatile memory usage

Description	Volatility description	Storage user data	How to erase
Primary storage device, holds the OS, applications, and application settings	Nonvolatile, 8-256 GB of eMMC or NVMe SSD storage, removable	Yes ¹	Follow instructions below under “Erase the Primary Storage Device.”
System memory (RAM), holds transient data during system operation	Volatile, SODIMM socket. Removable (4 GB/8 GB/16 GB)	Yes	Unplug unit from power.
Permanent system BIOS settings	Nonvolatile; 16 KB; stored	No ²	Follow instructions below under “Clearing BIOS Settings.”
System boot ROM (BIOS)	Nonvolatile memory, 128 Mbit (16 MB) socketed, removable	No	Download the latest BIOS for your model from the HP website and follow the instructions to flash the BIOS that are on the website.
RTC (CMOS) RAM	Volatile memory, 256 bytes located in AMD embedded System on Chip (SoC)	No	<p>Desktop computers with a CMOS button:</p> <p>Unplug unit from main power, remove top cover and press the Clear CMOS button.</p> <p>Notebook and desktop computers without a CMOS button:</p> <ol style="list-style-type: none"> 1. Press and hold power button for 12 seconds. 2. Press Windows key + V, and then press power button.
Keyboard/mouse (ROM)	Nonvolatile, 2 KB embedded in the super I/O controller (SIO2)	Yes	N/A
Keyboard/mouse (RAM)	Volatile, 256 bytes embedded in the super I/O controller (SIO2)	No	Unplug unit from main power.
LOM EEPROM	Nonvolatile, 2 MB embedded in LAN controller	No	N/A
Trusted Platform Module (TPM)	Nonvolatile; 51 KB ROM for firmware and 38 KB system parametric data	No ³	Follow instructions below under “Clearing TPM.”

¹ Under typical operation, the only user data stored on the primary storage device are preferences for device configuration and settings for connections. However, the administrator can configure the system to allow users to store data locally.

² The only user data potentially stored in BIOS Settings are the ownership and asset tags, administrator password, and startup password.

³ The Trusted Platform Module might contain encrypted passwords or certificates generated from user or administrator input.

Questions and answers

Use this section to answer your questions about nonvolatile memory.

1. How can the BIOS settings be restored (returned to factory settings)?

 **IMPORTANT:** The restore defaults feature does not securely erase any information on your hard drive. See question and answer 6 for steps to securely erase information.

The restore defaults feature does not reset the Custom Secure Boot keys. See question and answer 7 for information about resetting the keys.

- Turn on or restart the computer, and then quickly press **esc**.
- Select **Main**, and then select **Apply Factory Defaults and Exit**.
- Follow the on-screen instructions.
- Select **Main**, select **Save Changes and Exit**, and then follow the on-screen instructions.

2. What is a UEFI BIOS?

The Unified Extensible Firmware Interface (UEFI) BIOS is an industry-standard software interface between the platform firmware and an operating system (OS). It replaces the older legacy BIOS architecture.

The UEFI BIOS provides an interface to display the system information and configuration settings and to change the configuration of your computer before an OS is loaded. BIOS provides a secure runtime environment that supports a GUI. In this environment, you can use either a pointing device (touch screen, touchpad, pointing stick, or USB mouse) or the keyboard to navigate and make menu and configuration selections. The UEFI BIOS also contains basic system diagnostics.

In addition, the UEFI BIOS works to initialize the computer's hardware before loading and executing the OS; the runtime environment allows the loading and execution of software programs from storage devices to provide more functionality, such as advanced hardware diagnostics (with the ability to display more detailed system information) and advanced firmware management and recovery software.

3. Where is the UEFI BIOS located?

The UEFI BIOS is located on a flash memory chip. You must use a utility to write to the chip.

4. What kind of configuration data is stored on the DIMM Serial Presence Detect (SPD) memory module? How would this data be written?

The DIMM SPD memory contains information about the memory module, such as size, serial number, data width, speed and timing, voltage, and thermal information. This information is written by the module manufacturer and stored on an EEPROM. You cannot write to this EEPROM when the memory module is installed in a computer. Third-party tools do exist that can write to the EEPROM when the memory module is not installed in a computer. Various third-party tools are available to read SPD memory.

5. What is meant by “Restore the nonvolatile memory found in Intel-based system boards”?

This message relates to clearing the Real Time Clock (RTC) CMOS memory that contains computer configuration data.

6. How can the BIOS security be reset to factory defaults and erase the data?

 **IMPORTANT:** Resetting results in the loss of information.

These steps do not reset Custom Secure Boot Keys. See question and answer 7 for information about resetting the keys.

- a. Turn on or restart the computer, and then quickly press **esc**.
- b. Select **Main**, and then select **Reset Security to Factory Defaults**.
- c. Follow the on-screen instructions.
- d. Select **Main**, select **Save Changes and Exit**, and then follow the on-screen instructions.

7. How can the Custom Secure Boot Keys be reset?

Secure Boot is a feature to ensure that only authenticated code can start on a platform. If you enabled Secure Boot and created Custom Secure Boot Keys, disabling Secure Boot does not clear the keys. You must also select to clear the Custom Secure Boot Keys. Use the same Secure Boot access procedure that you used to create the Custom Secure Boot Keys, but select to clear or delete all Secure Boot Keys.

- a. Turn on or restart the computer, and then quickly press **esc**.
- b. Select the **Security** menu, select **Secure Boot Configuration**, and then follow the on-screen instructions.
- c. At the **Secure Boot Configuration** window, select **Secure Boot**, select **Clear Secure Boot Keys**, and then follow the on-screen instructions to continue.

12 Power cord set requirements

This chapter provides power cord requirements for countries and regions.

The wide-range input feature of the computer permits it to operate from any line voltage from 100 V AC to 120 V AC, or from 220 V AC to 240 V AC.

The three-conductor power cord set included with the computer meets the requirements for use in the country or region where the equipment is purchased.

Power cord sets for use in other countries or regions must meet the requirements of the country and region where the computer is used.

Requirements for all countries

These power cord requirements are applicable to all countries and regions.

- The length of the power cord set must be at least **1.0 m** (3.3 ft) and no more than **2.0 m** (6.5 ft).
- All power cord sets must be approved by an acceptable accredited agency responsible for evaluation in the country or region where the power cord set will be used.
- The power cord sets must have a minimum current capacity of 10 A and a nominal voltage rating of 125 V AC or 250 V AC, as required by the power system of each country or region.
- The appliance coupler must meet the mechanical configuration of an EN 60 320/IEC 320 Standard Sheet C13 connector for mating with the appliance inlet on the back of the computer.

Requirements for specific countries and regions

To determine power cord requirements for specific countries and regions, use this table.

Table 12-1 Power cord requirements for specific countries and regions

Country/region	Accredited agency	Applicable note number
Argentina	IRAM	1
Australia	SAA	1
Austria	OVE	1
Belgium	CEBEC	1
Brazil	ABNT	1
Canada	CSA	2
Chile	IMQ	1
Denmark	DEMKO	1
Finland	FIMKO	1
France	UTE	1

Table 12-1 Power cord requirements for specific countries and regions (continued)

Country/region	Accredited agency	Applicable note number
Germany	VDE	1
India	BIS	1
Israel	SII	1
Italy	IMQ	1
Japan	JIS	3
Netherlands	KEMA	1
New Zealand	SANZ	1
Norway	NEMKO	1
PRC	CCC	4
Saudi Arabia	SASO	7
Singapore	PSB	1
South Africa	SABS	1
South Korea	KTL	5
Sweden	SEMKO	1
Switzerland	SEV	1
Taiwan	BSMI	6
Thailand	TISI	1
United Kingdom	ASTA	1
United States	UL	2

1. The flexible cord must be Type HO5VV-F, three-conductor, 0.75 mm² conductor size. Power cord set fittings (appliance coupler and wall plug) must bear the certification mark of the agency responsible for evaluation in the country or region where it will be used.
2. The flexible cord must be Type SVT/SJT or equivalent, No. 18 AWG, three-conductor. The wall plug must be a two-pole grounding type with a NEMA 5-15P (15 A, 125 V AC) or NEMA 6-15P (15 A, 250 V AC) configuration. CSA or C-UL mark. UL file number must be on each element.
3. The appliance coupler, flexible cord, and wall plug must bear a T mark and registration number in accordance with the Japanese Dentori Law. The flexible cord must be Type VCTF, three-conductor, 0.75 mm² or 1.25 mm² conductor size. The wall plug must be a two-pole grounding type with a Japanese Industrial Standard C8303 (7 A, 125 V AC) configuration.
4. The flexible cord must be Type RVV, three-conductor, 0.75 mm² conductor size. Power cord set fittings (appliance coupler and wall plug) must bear the CCC certification mark.
5. The flexible cord must be Type HO5VV-F three-conductor, 0.75 mm² conductor size. KTL logo and individual approval number must be on each element. Approval number and logo must be printed on a flag label.
6. The flexible cord must be Type HVCTF three-conductor, 1.25 mm² conductor size. Power cord set fittings (appliance coupler, cable, and wall plug) must bear the BSMI certification mark.

7. For 127 V AC, the flexible cord must be Type SVT or SJT 3-conductor, 18 AWG, with plug NEMA 5-15P (15 A, 125 V AC), with UL and CSA or C-UL marks. For 240 V AC, the flexible cord must be Type H05VV-F three-conductor, 0.75 mm² or 1.00 mm² conductor size, with plug BS 1363/A with BSI or ASTA marks.

13 Swelling or deformation of notebook battery

To protect your hardware from potential damage, HP recommends that if you are experiencing battery swelling, stop using the notebook until you can replace the battery.

You can contact HP to understand what battery replacement options are available. To learn more about Lithium-ion batteries and the factors that can accelerate battery swelling, see https://support.hp.com/us-en/document/ish_6824662-6824706-16.

Swollen notebook batteries

You might notice that your notebook battery has become somewhat deformed or swollen over time. In some cases, the battery swelling might be significant enough to impact other components of the system including the touchpad, keyboard, and chassis.

Swollen battery is not a safety issue

A swollen battery does not present a safety issue. It is the result of the generation of gases per the normal degradation of the battery cell over time.

HP has worked closely with our battery cell suppliers and third-party industry experts to help minimize the potential for HP batteries to swell over time and to identify that swollen batteries are not a safety issue.

Discontinue using a swollen battery

To protect your hardware from potential damage, HP recommends that, if you are experiencing battery swelling, you stop using the notebook until the battery can be replaced.

You can contact <https://www.hp.com/go/contacthp> to understand what battery replacement options are available.

Replace a swollen battery

If a battery is under warranty, HP will replace the battery per the terms and conditions of the HP Worldwide Limited Warranty or applicable HP Care Packs.

For batteries no longer under warranty, contact HP to purchase a genuine HP replacement battery.

Minimize battery swelling

Multiple factors can accelerate battery swelling.

To help mitigate battery swelling over time, you can use either HP Adaptive Battery Optimizer (consumer notebooks) or HP Battery Health Manager (commercial notebooks) settings to improve battery longevity and performance for various use scenarios.

HP Adaptive Battery Optimizer (consumer notebooks)

HP Adaptive Battery Optimizer technology can help mitigate the factors that cause the battery to swell. It is available on select HP OMEN, HP Spectre, HP Pavilion, and HP ENVY notebook computers.

HP Adaptive Battery Optimizer has been available on select gaming notebooks since 2019 and select consumer notebooks since 2020. To learn more about enabling HP Adaptive Battery Optimizer on your HP notebook, see <https://support.hp.com/us-en/document/c06310986>.

HP Battery Health Manager (commercial notebooks)

HP Battery Health Manager provides an easy-to-manage solution to help mitigate factors that cause the battery to swell. It is available on select HP ProBook and HP EliteBook notebook computers.

HP Battery Health Manager is available on select commercial notebooks manufactured since 2016. To learn more about HP Battery Health Manager, see https://support.hp.com/us-en/document/ish_4449597-3519507-16.

14 Recycling

When a nonrechargeable or rechargeable battery has reached the end of its useful life, do not dispose of the battery in general household waste. Follow the local laws and regulations in your area for battery disposal.

HP encourages customers to recycle used electronic hardware, HP original print cartridges, and rechargeable batteries. For more information about recycling programs, see the HP website at <http://www.hp.com/recycle>.

Index

A

- AC adapters, spare part numbers 23
- ambient light and color sensor, identifying 8
- audio jack
 - removal 57
 - spare part numbers 57
- audio-out (headphone)/audio-in (microphone) combo jack, identifying 7
- audio, product description 2

B

- backup, creating 72
- backups 72
- battery
 - illustrated 20
 - spare part number 20
- battery light 5, 7
- battery swelling 96
- BIOS
 - determining version 76
 - downloading an update 77
 - preparing for an update 76
 - updating 76
- Bluetooth label 15
- boot order
 - changing using the f9 prompt 78
- boot order, changing 74
- bottom cover
 - illustrated 20
 - removal 36
 - spare part number 20, 36
- buttons
 - power 13

C

- camera 8
 - identifying 8
- camera light, identifying 9
- camera privacy cover, identifying 8
- caps lock light, identifying 11
- caring for your computer 31

- cautions
 - electrostatic discharge 27, 28
- cleaning your computer 31
 - caring for wood veneer 33
 - disinfecting 32
 - HP Easy Clean 31
 - removing dirt and debris 31
- components
 - bottom 14
 - display 7
 - keyboard area 9
 - left side 6
 - right side 5
- computer major components 17
- Computer Setup
 - navigating and selecting 75
 - restoring factory settings 75
 - starting 75
- computer specifications 85
- connector, power 6
- control zone 10

D

- display
 - specifications 85
- display assembly
 - subcomponents 21
- display back cover
 - illustrated 21
 - spare part number 21
- display bezel
 - illustrated 21
 - spare part number 21
- display cable
 - illustrated 21
 - spare part number 21
- display components 7
- display panel
 - illustrated 21
 - product description 1
 - spare part number 21

E

- electrostatic discharge (ESD) 27, 28
 - preventing damage 27-29
- esc key, identifying 14

F

- fan
 - illustrated 21
 - removal 53
 - spare part number 21, 53
- fingerprint reader
 - illustrated 20
 - spare part number 20
- fingerprint reader, identifying 13
- fn key, identifying 14
- fn lock light, identifying 11

G

- graphics, product description 1
- grounding methods 27-29
- guidelines
 - packaging 27, 33
 - transporting 27, 33
 - workstation 27

H

- hard drive
 - product description 2
 - specifications 85
- HDMI port, identifying 6
- heat sink
 - illustrated 21
 - removal 54
 - spare part number 21
 - spare part numbers 54
- hinge
 - illustrated 21
 - spare part number 21
- hinge cover
 - illustrated 21
 - spare part number 21
- HP PC Hardware Diagnostics UEFI
 - downloading 82
 - failure ID code 81
 - HP Hotkey Support software 82
 - starting 81, 82
 - using 81
- HP PC Hardware Diagnostics Windows
 - accessing 79, 80
 - downloading 80

- failure ID code 79
- installing 81
- using 79
- HP Recovery media recovery 73
- HP Sure Recover 74
- HP Sure Start 88

I

- illustrated parts catalog 17
- internal microphones, identifying 8

J

- jacks
 - audio-out (headphone)/audio-in (microphone) combo 7

K

- keyboard
 - product description 3
 - removal 70
 - spare part number 70
- keyboard with top cover
 - spare part numbers 69
- keys
 - esc 14
 - fn 14
 - Windows 14

L

- labels
 - Bluetooth 15
 - regulatory 15
 - serial number 15
 - service 15
 - wireless certification 15
 - WLAN 15
- left and right I/O frames
 - removal 55
 - spare part numbers 55
- left control zone, identifying 10
- left side components 6
- lights
 - AC adapter and battery 5, 7
 - battery 5, 7
 - camera 9
 - caps lock 11
 - fn lock 11
 - microphone mute 11
 - power 11
 - privacy key 11
- lights, mute 11

- low blue light mode 7

M

- media card reader, product description 2
- memory
 - nonvolatile 88
 - volatile 88
- memory module
 - product description 1
- microphone
 - product description 2
- microphone mute light, identifying 11
- model name 1
- mute light, identifying 11

N

- nano SIM card slot, identifying 5
- NFC module
 - removal 52
 - spare part numbers 52
- nonvolatile memory 88

O

- operating system, product description 3

P

- packaging guidelines 27, 33
- pointing device, product description 3
- ports
 - HDMI 6
 - product description 2
 - USB SuperSpeed 5
 - USB Type-C power connector and Thunderbolt port with HP Sleep and Charge 6
 - USB Type-C SuperSpeed 5
- power button (no fingerprint reader)
 - spare part numbers 68
- power button, identifying 13
- power button/fingerprint reader
 - spare part numbers 68
- power connector
 - identifying USB Type-C 6
- power cord
 - requirements for all countries 93
 - requirements for specific countries and regions 93

- set requirements 93
- power cords, spare part numbers 23
- power key
 - illustrated 20
 - spare part number 20
- power key, no FPR
 - spare part number 21
- power lights 11
- power requirements, product description 3
- primary storage
 - product description 2
- privacy key light 11
- processor
 - product description 1
- product description
 - audio 2
 - display panel 1
 - graphics 1
 - hard drive 2
 - keyboard 3
 - media card reader 2
 - memory module 1
 - microphone 2
 - operating system 3
 - pointing device 3
 - ports 2
 - power requirements 3
 - primary storage 2
 - processors 1
 - product name 1
 - security 3
 - serviceability 4
 - solid-state drive 2
 - video 2
 - wireless 2
- product name 1
- product name and number, computer 15

R

- recovery 72
 - discs 73
 - media 73
 - USB flash drive 73
- recovery media 72
 - creating using HP Cloud Recovery Download Tool 72
 - creating using Windows tools 72
- regulatory information
- regulatory label 15

- wireless certification labels 15
- Remote HP PC Hardware
 - Diagnostics UEFI settings
 - customizing 84
 - using 83
- removal and replacement
 - procedures 36, 50
 - solid-state drive 48
- removing personal data from
 - volatile system memory 88
- restoring 72
- restoring and recovery
 - methods 73
- right control zone, identifying 10
- right side components 5

S

- Screw Kit, spare part number 23
- security cable slot, identifying 6
- security, product description 3
- serial number, computer 15
- service labels, locating 15
- serviceability, product description 4
- setup utility
 - navigating and selecting 75
 - restoring factory settings 75
- slots
 - nano SIM card 5
 - security cable 6
 - smart card 7
- smart card reader
 - illustrated 20
 - removal 58
 - spare part number 20
 - spare part numbers 58
- smart card slot, identifying 7
- solid-state drive
 - illustrated 20
 - product description 2
 - removal and replacement 48
 - spare part number 20
 - specifications 86
- spare part country codes 69
- speaker
 - illustrated 21
 - removal 50
 - spare part number 21, 50
- speakers, identifying 14
- special keys, using 13
- specifications
 - computer 85
 - display 85
 - hard drive 85

- solid-state drive 86
- static electricity 27, 28
- support information 33
- Sure Start
 - using 78
- swelling or deformation of
 - notebook battery 96
- system board
 - illustrated 19
 - removal 59
 - spare part number 19
 - spare part numbers 59
- system memory, removing
 - personal data from volatile 88
- system restore 73
- system restore point, creating 72

T

- top cover/keyboard
 - illustrated 20
 - spare part number 20
- touchpad
 - illustrated 18
 - removal 51
 - settings 9
 - spare part number 18
 - spare part numbers 51
- touchpad zone, identifying 10
- TPM settings 78
- transporting guidelines 27, 33
- traveling with the computer 15

U

- USB port, identifying 5
- USB Type-C port, identifying 5
- USB Type-C power connector and Thunderbolt port with HP Sleep and Charge, identifying 6

V

- vent, identifying 15
- video, product description 2

W

- Windows
 - backup 72
 - recovery media 72
 - system restore point 72
- Windows key, identifying 14
- Windows tools, using 72
- wireless antennas
 - illustrated 21
 - spare part number 21

- wireless antennas, identifying 8
- wireless certification label 15
- wireless, product description 2
- WLAN antenna, identifying 8
- WLAN antennas, identifying 8
- WLAN device 15
- WLAN label 15
- WLAN module
 - removal 45
 - spare part numbers 45
- workstation guidelines 27
- WWAN module
 - removal 46
 - spare part numbers 46