



Maintenance and Service Guide

HP EliteBook 645 14 inch G11 Notebook PC

SUMMARY

This guide provides maintenance information about such topics as spare parts, removal and replacement of parts, security, and backing up.

Legal information

© Copyright 2024 HP Development Company, L.P.

AMD, Ryzen, and Radeon are trademarks of Advanced Micro Devices, Inc. Bluetooth is a trademark owned by its proprietor and used by HP Inc. under license. Intel and Thunderbolt are trademarks of Intel Corporation or its subsidiaries in the U.S. and/or other countries. Microsoft and Windows are either registered trademarks or trademarks of Microsoft Corporation in the United States and/or other countries. Realtek is a trademark of Realtek Semiconductor Corporation. USB4, USB Type-C, and USB-C are registered trademarks of USB Implementers Forum. DisplayPort™ and the DisplayPort™ logo are trademarks owned by the Video Electronics Standards Association (VESA®) in the United States and other countries. Miracast and Wi-Fi are registered trademarks of Wi-Fi Alliance.

The information contained herein is subject to change without notice. The only warranties for HP products and services are set forth in the express warranty statements accompanying such products and services. Nothing herein should be construed as constituting an additional warranty. HP shall not be liable for technical or editorial errors or omissions contained herein.

First Edition: April 2024

Document Part Number: N81607-001

Product notice

This guide describes features that are common to most models. Some features may not be available on your computer.

Not all features are available in all editions or versions of Windows. Systems may require upgraded and/or separately purchased hardware, drivers, software or BIOS update to take full advantage of Windows functionality. Windows is automatically updated, which is always enabled. High-speed internet and Microsoft account required. ISP fees may apply and additional requirements may apply over time for updates. See <http://www.windows.com>.

If your product ships with Windows in S Mode: Windows in S Mode works exclusively with apps from the Microsoft Store within Windows. Certain default settings, features, and apps cannot be changed. Some accessories and apps that are compatible with Windows may not work (including some antivirus, PDF writers, driver utilities, and accessibility apps), and performance may vary, even if you switch out of S Mode. If you switch to Windows, you cannot switch back to S Mode. Learn more at Windows.com/SmodeFAQ.

To access the latest user guides, go to <http://www.hp.com/support>, and follow the instructions to find your product. Then select **Manuals**.

Software terms

By installing, copying, downloading, or otherwise using any software product preinstalled on this computer, you agree to be bound by the terms of the HP End User License Agreement (EULA). If you do not accept these license terms, your sole remedy is to return the entire unused product (hardware and software) within 14 days for a full refund subject to the refund policy of your seller.

For any further information or to request a full refund of the price of the computer, please contact your seller.

Safety warning notice

Reduce the possibility of heat-related injuries or of overheating the computer by following the practices described.

-
- ⚠ WARNING!** To reduce the possibility of heat-related injuries or of overheating the computer, do not place the computer directly on your lap or obstruct the computer air vents. Use the computer only on a hard, flat surface. Do not allow another hard surface, such as an adjoining optional printer, or a soft surface, such as pillows or rugs or clothing, to block airflow. Also, do not allow the AC adapter to come into contact with the skin or a soft surface, such as pillows or rugs or clothing, during operation. The computer and the AC adapter provided by HP comply with the user-accessible surface temperature limits defined by applicable safety standards.
-

Important notice about Customer Self-Repair parts

Your computer includes Customer Self-Repair parts and parts that should be accessed only by an authorized service provider.



IMPORTANT: See "Removal and replacement procedures for Customer Self-Repair parts" for details.

Accessing parts described in "Removal and replacement procedures for authorized service provider parts" can damage the computer or void your warranty.

Table of contents

1 Product description	1
2 Components	5
Right.....	5
Left.....	5
Display	7
Low blue light mode (select products only).....	7
Keyboard area	9
Touchpad	9
Touchpad settings	9
Adjusting touchpad settings.....	9
Turning on the touchpad	9
Touchpad components	9
Lights	10
Button and fingerprint reader	11
Special keys.....	13
Bottom	14
Rear	15
Labels	15
Using a SIM card (select products only).....	17
Determining the correct SIM card size for your computer	17
Inserting a SIM card in an external slot	17
3 Components	18
Right.....	18
Left.....	18
Display	20
Low blue light mode (select products only).....	20
Keyboard area	22
Touchpad	22
Touchpad settings	22
Adjusting touchpad settings.....	22
Turning on the touchpad	22
Touchpad components	22
Lights	23
Button and fingerprint reader	24
Special keys.....	26
Bottom	27
Rear	28
Labels	28

Using a SIM card (select products only).....	30
Determining the correct SIM card size for your computer	30
Inserting a SIM card in an external slot	30
4 Illustrated parts catalog	31
Computer major components.....	31
Display assembly subcomponents	34
Screw Kit components.....	36
Miscellaneous parts.....	37
5 Illustrated parts catalog	42
Computer major components.....	42
Display assembly subcomponents	45
Screw Kit components.....	47
Miscellaneous parts.....	48
6 Removal and replacement procedures preliminary requirements.....	53
Tools required	53
Service considerations	53
Plastic parts.....	53
Cables and connectors.....	53
Drive handling	53
Electrostatic discharge information.....	54
Generating static electricity.....	54
Preventing electrostatic damage to equipment.....	55
Personal grounding methods and equipment.....	55
Grounding the work area.....	56
Recommended materials and equipment.....	56
Cleaning your computer	57
Enabling HP Easy Clean (select products only).....	57
Removing dirt and debris from your computer.....	57
Cleaning your computer with a disinfectant.....	58
Caring for wood veneer (select products only).....	59
Packaging and transporting guidelines.....	59
Accessing support information	60
7 Removal and replacement procedures for Customer Self-Repair parts.....	62
Component replacement procedures	62
Preparation for disassembly.....	62
Bottom cover	62
Using a SIM card (select products only).....	63
Determining the correct SIM card size for your computer	64
Inserting a SIM card in an external slot	64
Memory modules.....	64
WLAN module.....	66
WWAN module.....	67

Solid-state drive.....	69
8 Removal and replacement procedures for authorized service provider parts.....	74
Component replacement procedures	74
Preparation for disassembly.....	74
Battery.....	74
Speakers.....	76
Fingerprint reader board.....	77
Fan.....	78
I/O board.....	79
NFC module	80
Smart card reader	81
Touchpad	83
Heat sink	84
System board	85
Display assembly.....	88
Top cover with keyboard.....	95
9 Backing up, restoring, and recovering.....	97
Backing up information and creating recovery media.....	97
Using Windows tools for backing up.....	97
Using the HP Cloud Recovery Download Tool to create recovery media (select products only).....	97
Restoring and recovering your system.....	97
Creating a system restore	98
Restoring and recovery methods.....	98
Recovering using HP Recovery media	98
Changing the computer boot order	99
Using HP Sure Recover (select products only).....	99
10 Computer Setup (BIOS), TPM, and HP Sure Start	100
Using Computer Setup	100
Navigating and selecting in Computer Setup	100
Restoring factory settings in Computer Setup.....	100
Updating the BIOS	101
Determining the BIOS version	101
Preparing for a BIOS update.....	101
Downloading a BIOS update	102
Installing a BIOS update	102
Changing the boot order using the f9 prompt	102
TPM BIOS settings (select products only)	103
Using HP Sure Start (select products only).....	103
11 Using HP PC Hardware Diagnostics.....	104
Using HP PC Hardware Diagnostics Windows (select products only).....	104
Using an HP PC Hardware Diagnostics Windows hardware failure ID code.....	104
Accessing HP PC Hardware Diagnostics Windows.....	104
Accessing HP PC Hardware Diagnostics Windows from HP Support Assistant.....	104
Accessing HP PC Hardware Diagnostics Windows from the Start menu (select products only).....	105

Downloading HP PC Hardware Diagnostics Windows.....	105
Downloading the latest HP PC Hardware Diagnostics Windows version from HP	105
Downloading the HP PC Hardware Diagnostics Windows from the Microsoft Store	105
Downloading HP Hardware Diagnostics Windows by product name or number (select products only)	105
Installing HP PC Hardware Diagnostics Windows.....	106
Using HP PC Hardware Diagnostics UEFI	106
Using an HP PC Hardware Diagnostics UEFI hardware failure ID code.....	106
Starting HP PC Hardware Diagnostics UEFI	106
Starting HP PC Hardware Diagnostics UEFI through HP Hotkey Support software (select products only).....	107
Downloading HP PC Hardware Diagnostics UEFI to a USB flash drive.....	107
Downloading the latest HP PC Hardware Diagnostics UEFI version.....	108
Downloading HP PC Hardware Diagnostics UEFI by product name or number (select products only)	108
Using Remote HP PC Hardware Diagnostics UEFI settings (select products only).....	108
Downloading Remote HP PC Hardware Diagnostics UEFI	108
Downloading the latest Remote HP PC Hardware Diagnostics UEFI version.....	108
Downloading Remote HP PC Hardware Diagnostics UEFI by product name or number	108
Customizing Remote HP PC Hardware Diagnostics UEFI settings.....	109
12 Specifications	110
Computer specifications	110
Display specifications.....	110
Solid-state drive specifications	111
13 Statement of memory volatility	113
Current BIOS steps	113
Nonvolatile memory usage	115
Questions and answers	116
Using HP Sure Start (select products only).....	117
14 Power cord set requirements	118
Requirements for all countries	118
Requirements for specific countries and regions.....	118
15 Recycling.....	121
Index.....	122

1 Product description

This table provides detailed product information.

Table 1-1 Product components and their descriptions

Category	Description
Product Name	HP EliteBook 645 14 inch G11 Notebook PC
Processors	AMD® processors
	AMD Ryzen™ 7 7735U (2.70 GHz [4.75 GHz max turbo frequency], 16 MB cache, 8 cores)
	AMD Ryzen 5 7535U (2.90 GHz [4.55 GHz max turbo frequency], 16 MB cache, 6 cores)
	AMD Ryzen 3 7335U (3.00 GHz [4.30 GHz max turbo frequency], 8 MB cache, 4 cores)
	AMD Ryzen 7 PRO 7735U (2.70 GHz [4.75 GHz max turbo frequency], 16 MB cache, 8 cores)
	AMD Ryzen 5 PRO 7535U (2.90 GHz [4.55 GHz max turbo frequency], 16 MB cache, 6 cores)
	AMD Ryzen 3 PRO 7335U (3.00 GHz [4.30 GHz max turbo frequency], 8 MB cache, 4 cores)
Graphics	Internal graphics
	AMD Radeon™ Graphics
	Supports HDMI 2.1
Display	35.6 cm (14.0 in), bent, ultra-wide viewing angle (UWVA), antiglare
	Nontouch
	WLED, 300 nits, NTC 45%
	WLED + low blue light, 400 nits, low power, sRGB 100%
	WLED + low blue light, 1000 nits, sRGB 100%, HP Sure View reflect integrated privacy screen
	Touch
	LED, 300 nits, NTSC 45%
Memory	Two customer-accessible (by IT or self-maintainers only) memory module slots supporting up to 64 GB of RAM
	DDR5-4800 dual-channel support
	Supports the following configurations:
	<ul style="list-style-type: none">• 64 GB (32 × 2)• 32 GB (16 × 2) or (32 × 1)• 16 GB (8 × 2) or (16 × 1)• 8 GB (8 × 1)
Primary storage	Solid-state drives, PCIe-Gen4 × 4, NVMe, M.2 2280
	2 TB, triple-layer cell (TLC)
	1 TB, TLC

Table 1-1 Product components and their descriptions (continued)

Category	Description
	1 TB, self-encrypted OPAL2, TLC
	512 GB, TLC
	512 GB, self-encrypted OPAL2, TLC
	512 GB
	256 GB, self-encrypted OPAL2, TLC
	256 GB
Audio and video	Camera (select products only)
	Full high definition (FHD)
	5 MP + IR (infrared)
	Camera privacy cover
	Audio
	Poly Studio
	Stereo speakers (2 W, 4 ohm per speaker)
	Integrated dual-array microphones (2)
RJ-45 (network) jack	Realtek RTL8111HSH 10/100/1000 Integrated NIC
	Realtek RTL8111EPP 10/100/1000 Integrated NIC
Wireless	Wireless Local Area Network (WLAN) (select products only)
	MediaTek RZ616 Wi-Fi® 6E Bluetooth® 5.3 AIM-T WLAN
	Realtek 8852CE Wi-Fi 6E Bluetooth 5.3 WLAN
	Compatible with Miracast® devices
	Two WLAN antennas
	Supports HP Connection Optimizer
	Supports HP Extended Range Wireless LAN
	Supports WLAN and Bluetooth PLDR
	Wireless Wide Area Network (WWAN) (select products only)
	HP 4G LTE-A Pro Cat16 WWAN eSIM
Ports	HDMI 2.1
	Audio-out (headphone)/audio-in (microphone) combo jack
	USB Type-A 5 Gbps port (power charging, left side)
	USB Type-A 5 Gbps port (data only, right side)
	USB4™ Type-C® 40 Gbps USB Power Delivery DisplayPort™ 1.4, left side) (2)
	RJ-45 (network) jack
	Nano SIM card slot
	Security lock slot (integrated)

Table 1-1 Product components and their descriptions (continued)

Category	Description
Sensors	Hall effect sensor
	Thermal sensor
	Ambient light sensor
	HP Tamper Lock
	Fingerprint sensor (select products only)
Keyboard/pointing devices	HP Standard Notebook Keyboard, spill-resistant, DuraKey
	Backlit
	Not backlit
	Backlit, privacy
	Clickpad with multitouch gesture support
	Microsoft precision touchpad default gestures support
Power requirements	Battery (long life, polymer, fast charge [50% in 30 minutes])
	3 cell, 56 Whr
	Smart AC adapters (USB Type-C) (select products only)
	65 W, nPFC, straight, 1.8 m (6 ft)
	65 W, nPFC, straight, 1.8 m (6 ft), halogen free (HF)
	Power cord (select products only)
	C5, 1.0 m (3.3 ft) conventional
	C5, 1.0 m (3.3 ft), conventional, straight, HF
Security	Fingerprint sensor (select products only)
	Camera privacy cover
	HP Combination Nano Cable Lock
	HP Essential Combination Nano Cable Lock
	Nano Security Lock
Operating system	Windows® 11 Pro
	Windows 11 Pro Education
	Windows 11 Home - HP recommends Windows 11 Pro for Business
	Windows 11 Home Single Language - HP recommends Windows 11 Pro for Business
	Windows 11 Pro (Windows 11 Enterprise or Windows 10 Enterprise available with a Volume Licensing Agreement)
	FreeDOS
Serviceability	End user replaceable parts
	AC adapter
	Solid-state drive

Table 1-1 Product components and their descriptions (continued)

Category	Description
	Memory modules
	WLAN module
	WWAN module
	SIM card
	Bottom cover
	Speaker

2 Components

Your computer features top-rated components. This chapter provides details about your components, where they are located, and how they work.

Right

Use the illustration and table to identify the components on the right side of the computer.

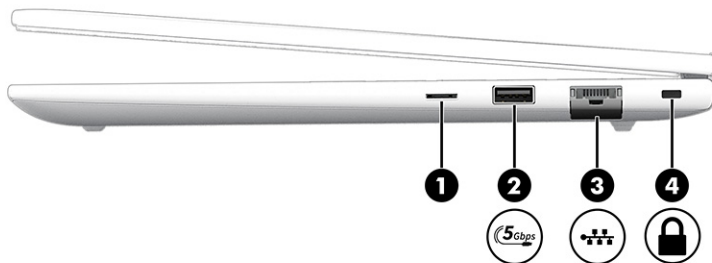





Table 2-1 Right-side components and their descriptions

	Component	Description
(1)	 SIM card slot	Supports a wireless subscriber identity module (SIM) card.
(2)	 USB 5 Gbps powered port	Connects and supplies power to a USB device, provides high-speed data transfer, and (for select products) charges small devices (such as a smartphone) when the computer is on or in Sleep mode. NOTE: Use a standard USB Type-A charging cable or cable adapter (purchased separately) when charging a small external device.
(3)	 RJ-45 (network) jack/status lights	Connects a network cable. <ul style="list-style-type: none">• Green (left): The network is connected.• Amber (right): Activity is occurring on the network.
(4)	 Security cable slot	Attaches an optional security cable to the computer. NOTE: The security cable is designed to act as a deterrent, but it might not prevent the computer from being mishandled or stolen.

Left

Use the illustration and table to identify the components on the left side of the computer.

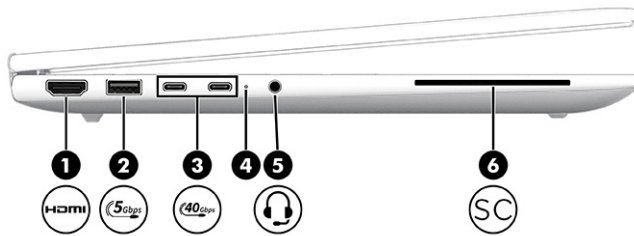

Table 2-2 Left-side components and their descriptions







	Component	Description
(1)	 HDMI port	Connects an optional video or audio device, such as a high-definition television, any compatible digital or audio component, or a high-speed High Definition Multimedia Interface (HDMI) device.
(2)	 USB 5 Gbps port with HP Sleep and Charge	Connects a USB device, provides high-speed data transfer, and charges small devices (such as a smartphone), even when the computer is off. NOTE: Use a standard USB Type-A charging cable or cable adapter (purchased separately) when charging a small external device.
(3)	 USB Type-C® power connector port, 40 Gbps port with DisplayPort™ output	Connects an AC adapter that has a USB Type-C connector, supplying power to the computer and, if needed, charging the computer battery. - and - Connects a USB device, provides high-speed data transfer, and (for select products) charges small devices (such as a smartphone) when the computer is on or in Sleep mode. NOTE: Use a standard USB Type-C charging cable or cable adapter (purchased separately) when charging a small external device. - and - Connects a display device that has a USB Type-C connector, providing DisplayPort output.
(4)	 Power light	<ul style="list-style-type: none"> • On: The computer is on. • Blinking: The computer is in the Sleep state, a power-saving state. The computer shuts off power to the display and other unneeded components. • Off: The computer is off or in Hibernation. Hibernation is a power-saving state that uses the least amount of power.

Table 2-2 Left-side components and their descriptions (continued)

	Component	Description
(5)	 Audio-out (headphone)/Audio-in (microphone) combo jack	<p>Connects optional powered stereo speakers, headphones, earbuds, a headset, or a television audio cable. Also connects an optional headset microphone. This jack does not support optional standalone microphones.</p> <p>WARNING! To reduce the risk of personal injury, adjust the volume before putting on headphones, earbuds, or a headset. For additional safety information, see the <i>Regulatory, Safety, and Environmental Notices</i>.</p> <p>To access this guide:</p> <ul style="list-style-type: none">■ Select the Search icon in the taskbar, type HP Documentation in the search box, and then select HP Documentation. <p>NOTE: When a device is connected to the jack, the computer speakers are disabled.</p>
(6)	 Smart card reader	Supports optional smart cards.

Display

Use the illustration and table to identify the display components.

Low blue light mode (select products only)

Your computer display is shipped from the factory in low blue light mode for improved eye comfort and safety. Also, blue light mode automatically adjusts blue light emissions when you are using the computer at night or for reading.

⚠ WARNING! To reduce the risk of serious injury, read the *Safety & Comfort Guide*. It describes proper workstation setup and proper posture, health, and work habits for computer users. The *Safety & Comfort Guide* also provides important electrical and mechanical safety information. The *Safety & Comfort Guide* is available on the web at <http://www.hp.com/ergo>.

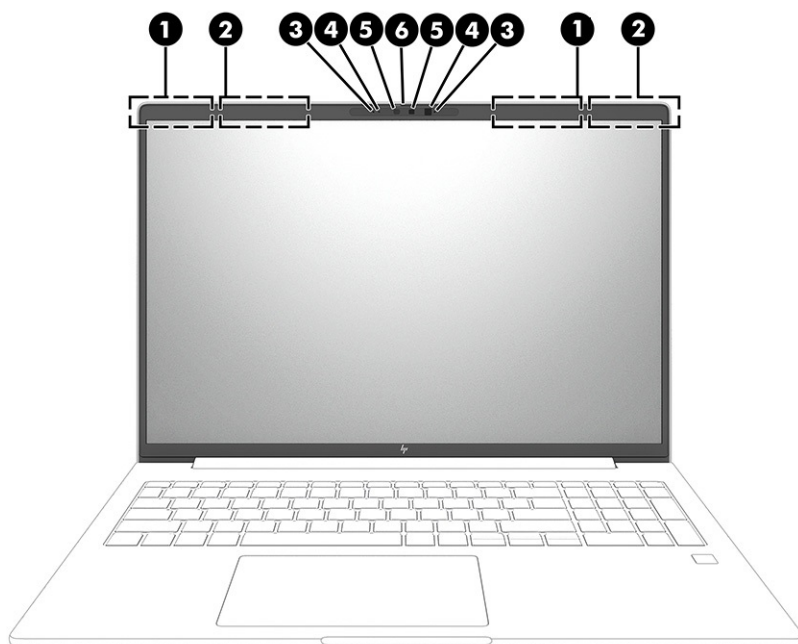

Table 2-3 Display components and their descriptions

	Component	Description
(1)	WLAN antennas* (2)	Send and receive wireless signals to communicate with wireless local area networks (WLANs).
(2)	WWAN antennas* (2)	Send and receive wireless signals to communicate with wireless wide area networks (WWANs) and low-power wide area networks (LPWAN).
(3)	Internal microphones (2)	Record sound.
(4)	Camera lights (2)	On: One or more cameras are in use.
(5)	Cameras (2) (select products only)	Allow you to video chat, record video, and record still images. Some cameras also allow a facial recognition logon to Windows, instead of a password logon.
		NOTE: Camera functions vary depending on the camera hardware and software installed on your product.
(6)	Camera privacy cover (select products only)	By default, the camera lens is uncovered, but you can slide the camera privacy cover to block the camera's view. To use the camera, slide the camera privacy cover in the opposite direction to reveal the lens.
		NOTE: If you have both front-facing and rear-facing cameras, when one camera lens is revealed and ready to use, the other is concealed.

*The antennas are not visible from the outside of the computer. For optimal transmission, keep the areas immediately around the antennas free from obstructions.

For wireless regulatory notices, see the section of the *Regulatory, Safety, and Environmental Notices* that applies to your country or region.

To access this guide:

- Select the **Search** icon in the taskbar, type `HP Documentation` in the search box, and then select **HP Documentation**.

Keyboard area

Keyboards can vary by language.



NOTE: The keyboard, including the function keys and power key (select products only), is disabled in stand, tent, and tablet modes. To enable the keyboard, including the power key, change to the clamshell mode.

Touchpad

The touchpad settings and components are described here.

Touchpad settings

You learn how to adjust the touchpad settings and components here.

Adjusting touchpad settings

Use these steps to adjust touchpad settings and gestures.

1. Select the **Search** icon in the taskbar, type `touchpad settings` in the search box, and then press `enter`.
2. Choose a setting.

Turning on the touchpad

Follow these steps to turn on the touchpad.

1. Select the **Search** icon in the taskbar, type `touchpad settings` in the search box, and then press `enter`.
2. Using an external mouse, click the **Touchpad** button.

If you are not using an external mouse, press the `Tab` key repeatedly until the pointer rests on the **touchpad** button. Then press the `spacebar` to select the button.

Touchpad components

Use the illustration and table to identify the touchpad components.

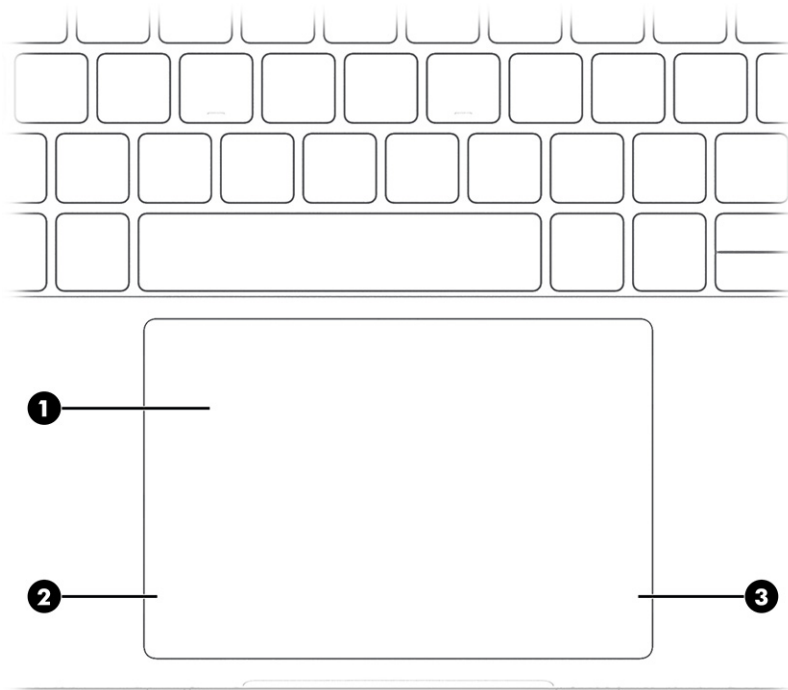

Table 2-4 Touchpad components and their descriptions

	Component	Description
(1)	Touchpad zone	Reads your finger gestures to move the pointer or activate items on the screen.
(2)	Left control zone	Textured area that allows you to perform additional gestures.
(3)	Right control zone	Textured area that allows you to perform additional gestures.

Lights

Use the illustration and table to identify the lights on the computer.

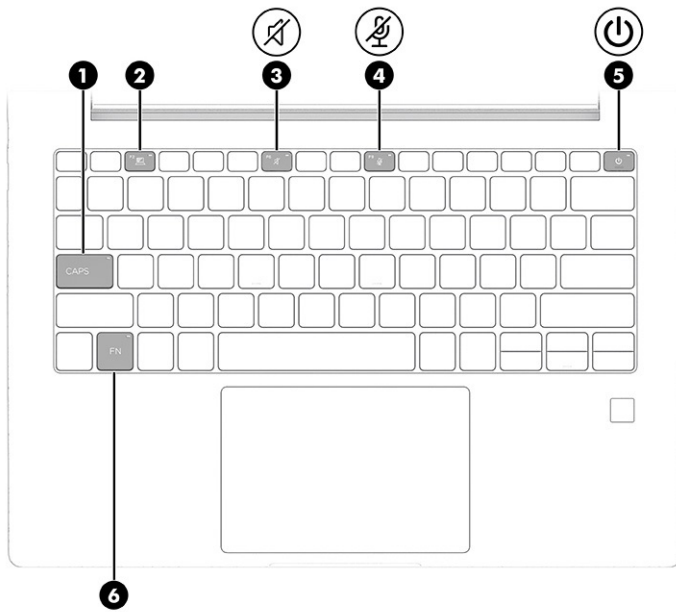





Table 2-5 Lights and their descriptions

	Component	Description
(1)	Caps lock light	On: Caps lock is on, which switches the key input to all capital letters.
(2)	Privacy key light	On: Privacy screen is on, which helps prevent side-angle viewing.
(3)	 Mute light	<ul style="list-style-type: none"> On: Computer sound is off. Off: Computer sound is on.
(4)	 Microphone mute light	<ul style="list-style-type: none"> On: Microphone is off. Off: Microphone is on.
(5)	 Power light	<ul style="list-style-type: none"> On: The computer is on. Blinking (select products only): The computer is in the Sleep state, a power-saving state. The computer shuts off power to the display and other unnecessary components. Off: Depending on your computer model, the computer is off, in Hibernation, or in Sleep. Hibernation is the power-saving state that uses the least amount of power.
(6)	Fn lock light	On: The fn key is locked.

Button and fingerprint reader

Fingerprint readers can be located on the touchpad, on a side panel of the computer, or on the top cover below the keyboard.

 **IMPORTANT:** To verify that your computer supports fingerprint reader sign-in, select the **Search** icon in the taskbar, type `Sign-in options` in the search box, and then select the **Sign-on options** app. If

Fingerprint recognition is not listed as an option, then your notebook does not include a fingerprint reader.

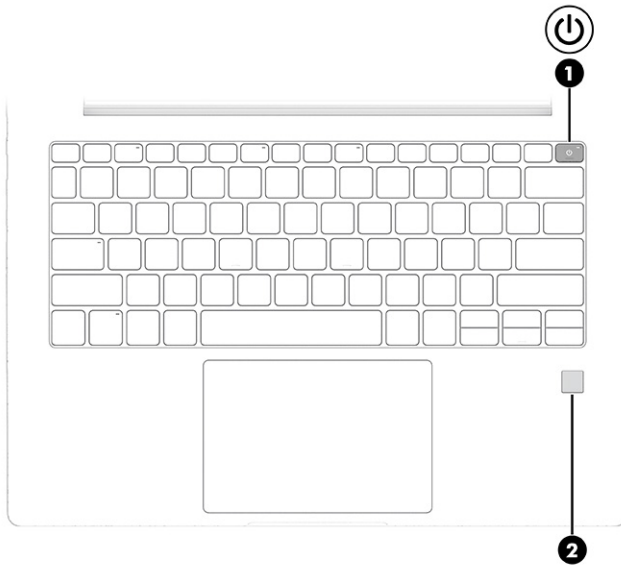



Table 2-6 Button and fingerprint reader and their descriptions

	Component	Description
(1) 	Power button	<ul style="list-style-type: none"> • When the computer is off, press the button briefly to turn on the computer. • When the computer is on, press the button briefly to initiate Sleep. • When the computer is in the Sleep state, press the button briefly to exit Sleep (select products only). • When the computer is in Hibernation, press the button briefly to exit Hibernation. <p>IMPORTANT: Pressing and holding down the power button results in the loss of unsaved information.</p> <p>If the computer has stopped responding and shutdown procedures are ineffective, press and hold the power button for at least 4 seconds to turn off the computer.</p> <p>To learn more about your power settings, use the Power icon.</p> <ul style="list-style-type: none"> • Right-click the Power icon  and then select Power and sleep settings.
(2)	Fingerprint reader (select products only)	<p>Allows a fingerprint logon to Windows, instead of a password logon.</p> <ul style="list-style-type: none"> ▪ Touch your finger to the fingerprint reader. <p>IMPORTANT: To prevent fingerprint logon issues, make sure when you register your fingerprint that all sides of your finger are registered by the fingerprint reader.</p>

Special keys

Use the illustration and table to identify the special keys.

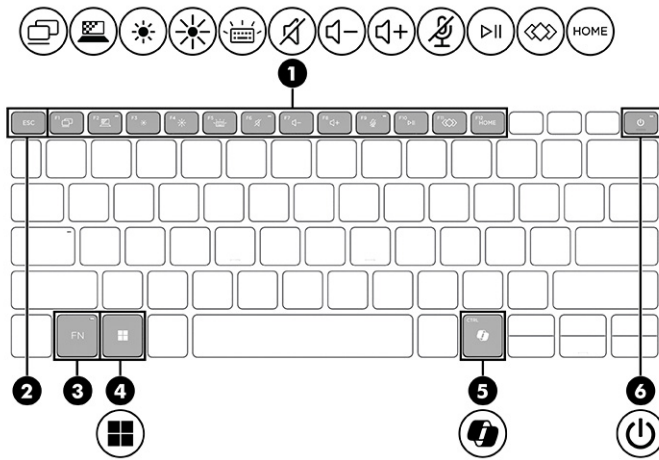

Table 2-7 Special keys and their descriptions



	Component	Description
(1)	Action keys	Execute frequently used system functions.
(2)	<code>esc</code> key	Displays system information when pressed in combination with the <code>fn</code> key.
(3)	<code>fn</code> key	Executes frequently used system functions when pressed in combination with another key. Such key combinations are called <i>hot keys</i> .
(4)	Windows key	Opens the Start menu. NOTE: Pressing the Windows key again will close the Start menu.
(5)	Windows Copilot key 	Opens Windows Copilot (select products only).

Table 2-7 Special keys and their descriptions (continued)

	Component	Description
(6)	 Power button	<ul style="list-style-type: none"> • When the computer is off, press the button briefly to turn on the computer. • When the computer is on, press the button briefly to initiate Sleep. • When the computer is in the Sleep state, press the button briefly to exit Sleep (select products only). • When the computer is in Hibernation, press the button briefly to exit Hibernation. <p>IMPORTANT: Pressing and holding down the power button results in the loss of unsaved information.</p> <p>If the computer has stopped responding and shutdown procedures are ineffective, press and hold the power button for at least 4 seconds to turn off the computer.</p> <p>To learn more about your power settings, use the Power icon.</p> <ul style="list-style-type: none"> • Right-click the Power icon , and then select Power and sleep settings.

Bottom

Use the illustration and table to identify the bottom components.

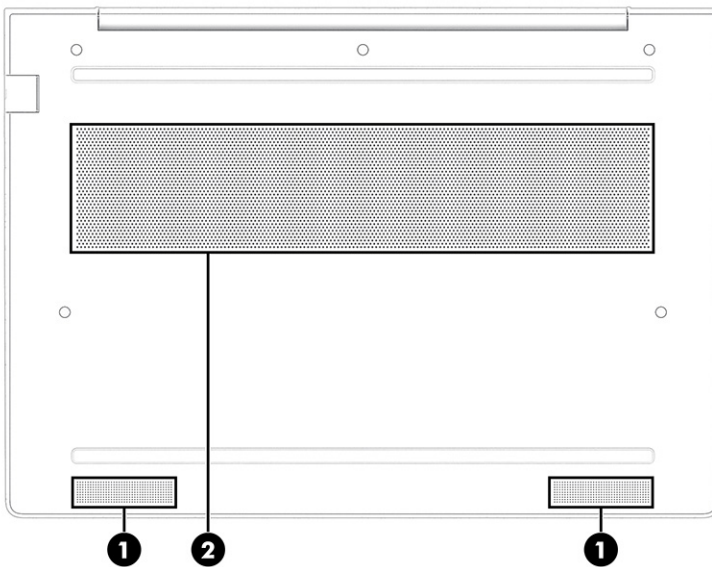

Table 2-8 Bottom components and their descriptions

Component	Description
(1) Speakers (2)	Produce sound.

Table 2-8 Bottom components and their descriptions (continued)

Component	Description
(2) Vent	Enables airflow to cool internal components. NOTE: The computer fan starts up automatically to cool internal components and prevent overheating. It is normal for the internal fan to cycle on and off during routine operation.

Rear

Use the illustration and table to identify the rear component.

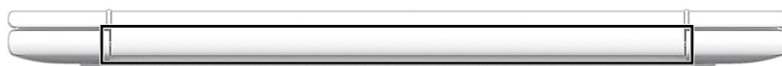



Table 2-9 Rear component and its descriptions

Component	Description
Vent	Enables airflow to cool internal components. NOTE: The computer fan starts up automatically to cool internal components and prevent overheating. It is normal for the internal fan to cycle on and off during routine operation.

Labels

The labels affixed to the computer provide information you might need when you troubleshoot system problems or travel internationally with the computer. Labels might be in paper form or imprinted on the product.

 **IMPORTANT:** Check the following locations for the labels described in this section: the bottom of the computer, inside the battery bay, under the service door, on the back of the display, or on the bottom of a tablet kickstand.

- Service label—Provides important information to identify your computer. When contacting support, you might be asked for the serial number, the product number, or the model number. Locate this information before you contact support.

Your service label will resemble one of the examples shown below. Refer to the illustration that most closely matches the service label on your computer.

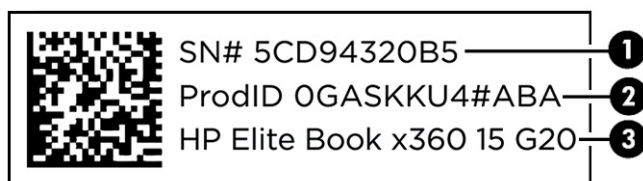

Table 2-10 Service label components

Component	
(1)	Serial number
(2)	Product ID
(3)	HP product name

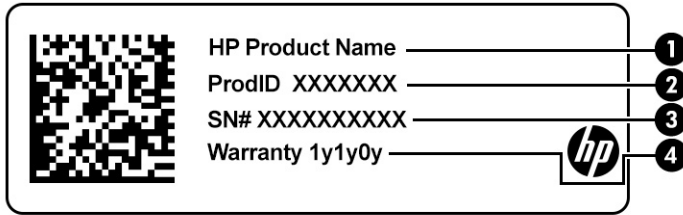

Table 2-11 Service label components

Component	
(1)	HP product name
(2)	Product ID
(3)	Serial number
(4)	Warranty period

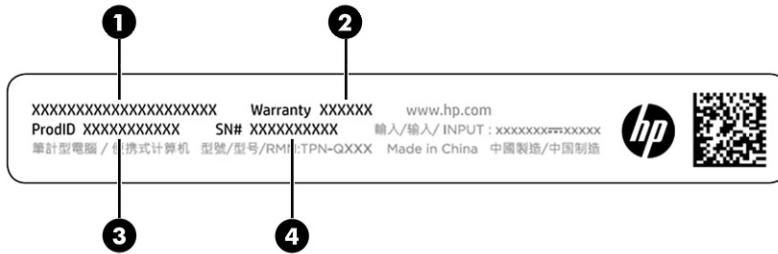



Table 2-12 Service label components

Component	
(1)	HP product name
(2)	Warranty period
(3)	Product ID
(4)	Serial number

- Regulatory labels—Provide regulatory information about the computer.
- Wireless certification labels—Provide information about optional wireless devices and the approval markings for the countries or regions in which the devices have been approved for use.

Using a SIM card (select products only)

Use these instructions to insert a SIM card.

 **IMPORTANT:** You can damage the SIM card if you insert the wrong size card or insert it or the SIM card tray in the wrong direction. The card might also become stuck in the slot. Do not use SIM card adapters. To prevent damage to the SIM card or connectors, use minimal force when inserting or removing a SIM card.

Determining the correct SIM card size for your computer

Before purchasing a SIM card, follow these instructions to determine the correct SIM card size for your computer.

1. Go to <http://www.hp.com/support>, and then search for your computer by product name or number.
2. Select **Product Information**.
3. Refer to the listed options to determine which card to purchase.

Inserting a SIM card in an external slot

To insert a SIM card in an external slot, follow these steps.

1. Turn off the computer by using the **Shut down** command.
2. Insert the SIM card into the SIM card slot, and then press in on the SIM card until it is firmly seated.

 **NOTE:** Your SIM card or the SIM card slot in your computer might look different from the illustration in this section.

 **NOTE:** Your SIM card slot might have an icon to show which way the card should be inserted into the computer.

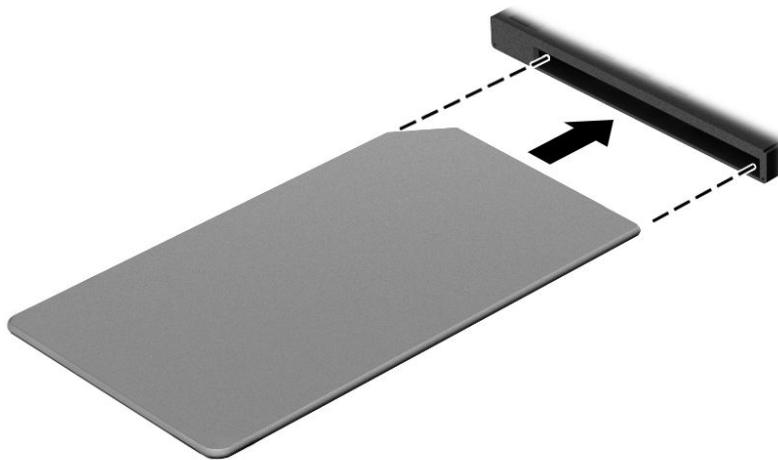

To remove the SIM card, press in gently on the card to disengage the SIM lock, and then remove it from the slot.

3 Components

Your computer features top-rated components. This chapter provides details about your components, where they are located, and how they work.

Right

Use the illustration and table to identify the components on the right side of the computer.

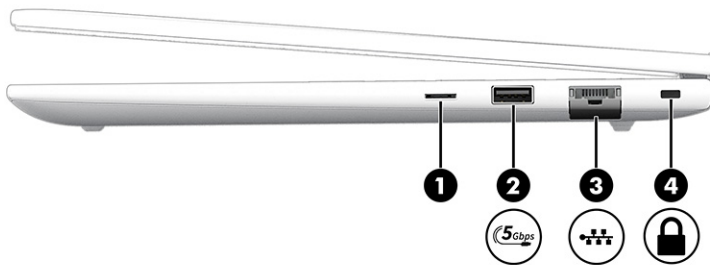





Table 3-1 Right-side components and their descriptions

	Component	Description
(1)	 SIM card slot	Supports a wireless subscriber identity module (SIM) card.
(2)	 USB 5 Gbps powered port	Connects and supplies power to a USB device, provides high-speed data transfer, and (for select products) charges small devices (such as a smartphone) when the computer is on or in Sleep mode. NOTE: Use a standard USB Type-A charging cable or cable adapter (purchased separately) when charging a small external device.
(3)	 RJ-45 (network) jack/status lights	Connects a network cable. <ul style="list-style-type: none">• Green (left): The network is connected.• Amber (right): Activity is occurring on the network.
(4)	 Security cable slot	Attaches an optional security cable to the computer. NOTE: The security cable is designed to act as a deterrent, but it might not prevent the computer from being mishandled or stolen.

Left

Use the illustration and table to identify the components on the left side of the computer.

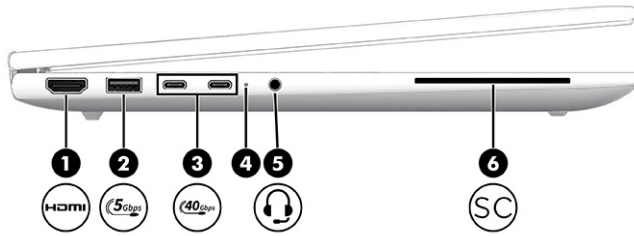

Table 3-2 Left-side components and their descriptions







	Component	Description
(1)	 HDMI port	Connects an optional video or audio device, such as a high-definition television, any compatible digital or audio component, or a high-speed High Definition Multimedia Interface (HDMI) device.
(2)	 USB 5 Gbps port with HP Sleep and Charge	Connects a USB device, provides high-speed data transfer, and charges small devices (such as a smartphone), even when the computer is off. NOTE: Use a standard USB Type-A charging cable or cable adapter (purchased separately) when charging a small external device.
(3)	 USB Type-C® power connector port, 40 Gbps port with DisplayPort™ output	Connects an AC adapter that has a USB Type-C connector, supplying power to the computer and, if needed, charging the computer battery. - and - Connects a USB device, provides high-speed data transfer, and (for select products) charges small devices (such as a smartphone) when the computer is on or in Sleep mode. NOTE: Use a standard USB Type-C charging cable or cable adapter (purchased separately) when charging a small external device. - and - Connects a display device that has a USB Type-C connector, providing DisplayPort output.
(4)	 Power light	<ul style="list-style-type: none"> • On: The computer is on. • Blinking: The computer is in the Sleep state, a power-saving state. The computer shuts off power to the display and other unneeded components. • Off: The computer is off or in Hibernation. Hibernation is a power-saving state that uses the least amount of power.

Table 3-2 Left-side components and their descriptions (continued)

	Component	Description
(5)	 Audio-out (headphone)/Audio-in (microphone) combo jack	<p>Connects optional powered stereo speakers, headphones, earbuds, a headset, or a television audio cable. Also connects an optional headset microphone. This jack does not support optional standalone microphones.</p> <p>WARNING! To reduce the risk of personal injury, adjust the volume before putting on headphones, earbuds, or a headset. For additional safety information, see the <i>Regulatory, Safety, and Environmental Notices</i>.</p> <p>To access this guide:</p> <ul style="list-style-type: none">■ Select the Search icon in the taskbar, type HP Documentation in the search box, and then select HP Documentation. <p>NOTE: When a device is connected to the jack, the computer speakers are disabled.</p>
(6)	 Smart card reader	Supports optional smart cards.

Display

Use the illustration and table to identify the display components.

Low blue light mode (select products only)

Your computer display is shipped from the factory in low blue light mode for improved eye comfort and safety. Also, blue light mode automatically adjusts blue light emissions when you are using the computer at night or for reading.

- ⚠ WARNING!** To reduce the risk of serious injury, read the *Safety & Comfort Guide*. It describes proper workstation setup and proper posture, health, and work habits for computer users. The *Safety & Comfort Guide* also provides important electrical and mechanical safety information. The *Safety & Comfort Guide* is available on the web at <http://www.hp.com/ergo>.

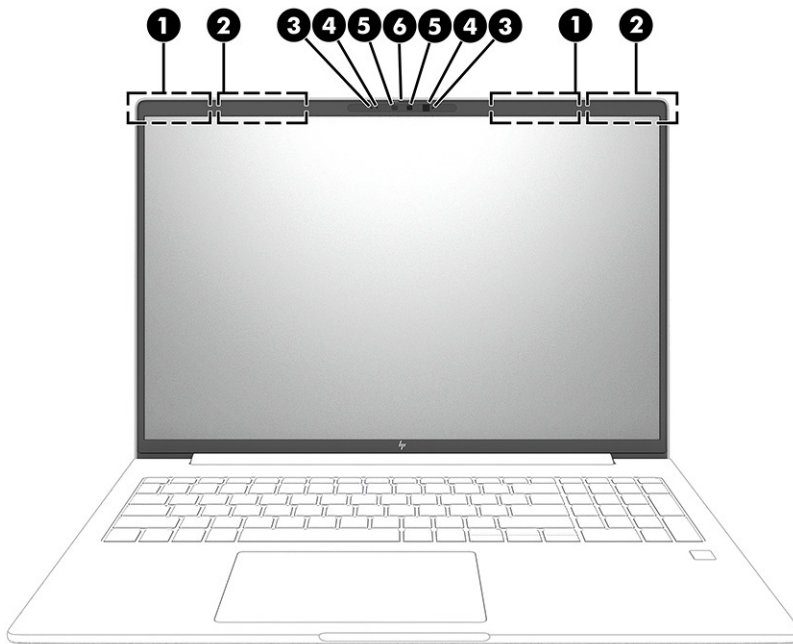

Table 3-3 Display components and their descriptions

Component	Description
(1) WLAN antennas* (2)	Send and receive wireless signals to communicate with wireless local area networks (WLANs).
(2) WWAN antennas* (2)	Send and receive wireless signals to communicate with wireless wide area networks (WWANs) and low-power wide area networks (LPWAN).
(3) Internal microphones (2)	Record sound.
(4) Camera lights (2)	On: One or more cameras are in use.
(5) Cameras (2) (select products only)	Allow you to video chat, record video, and record still images. Some cameras also allow a facial recognition logon to Windows, instead of a password logon. NOTE: Camera functions vary depending on the camera hardware and software installed on your product.
(6) Camera privacy cover (select products only)	By default, the camera lens is uncovered, but you can slide the camera privacy cover to block the camera's view. To use the camera, slide the camera privacy cover in the opposite direction to reveal the lens. NOTE: If you have both front-facing and rear-facing cameras, when one camera lens is revealed and ready to use, the other is concealed.

*The antennas are not visible from the outside of the computer. For optimal transmission, keep the areas immediately around the antennas free from obstructions.

For wireless regulatory notices, see the section of the *Regulatory, Safety, and Environmental Notices* that applies to your country or region.

To access this guide:

- Select the **Search** icon in the taskbar, type `HP Documentation` in the search box, and then select **HP Documentation**.

Keyboard area

Keyboards can vary by language.



NOTE: The keyboard, including the function keys and power key (select products only), is disabled in stand, tent, and tablet modes. To enable the keyboard, including the power key, change to the clamshell mode.

Touchpad

The touchpad settings and components are described here.

Touchpad settings

You learn how to adjust the touchpad settings and components here.

Adjusting touchpad settings

Use these steps to adjust touchpad settings and gestures.

1. Select the **Search** icon in the taskbar, type `touchpad settings` in the search box, and then press `enter`.
2. Choose a setting.

Turning on the touchpad

Follow these steps to turn on the touchpad.

1. Select the **Search** icon in the taskbar, type `touchpad settings` in the search box, and then press `enter`.
2. Using an external mouse, click the **Touchpad** button.

If you are not using an external mouse, press the `Tab` key repeatedly until the pointer rests on the **touchpad** button. Then press the `spacebar` to select the button.

Touchpad components

Use the illustration and table to identify the touchpad components.

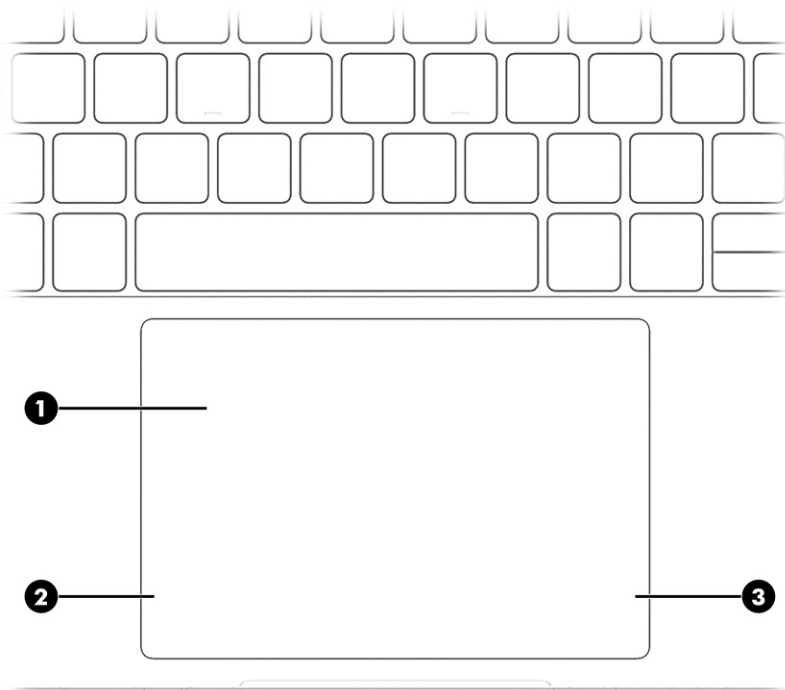

Table 3-4 Touchpad components and their descriptions

	Component	Description
(1)	Touchpad zone	Reads your finger gestures to move the pointer or activate items on the screen.
(2)	Left control zone	Textured area that allows you to perform additional gestures.
(3)	Right control zone	Textured area that allows you to perform additional gestures.

Lights

Use the illustration and table to identify the lights on the computer.

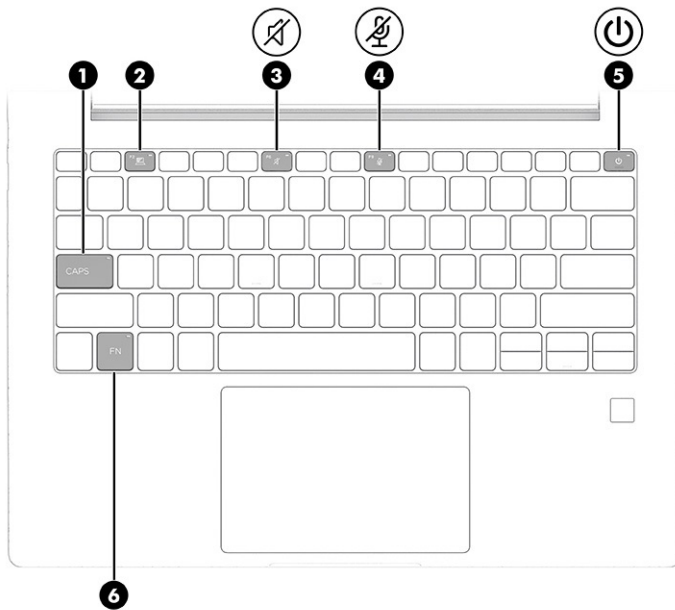





Table 3-5 Lights and their descriptions

	Component	Description
(1)	Caps lock light	On: Caps lock is on, which switches the key input to all capital letters.
(2)	Privacy key light	On: Privacy screen is on, which helps prevent side-angle viewing.
(3)	 Mute light	<ul style="list-style-type: none"> On: Computer sound is off. Off: Computer sound is on.
(4)	 Microphone mute light	<ul style="list-style-type: none"> On: Microphone is off. Off: Microphone is on.
(5)	 Power light	<ul style="list-style-type: none"> On: The computer is on. Blinking (select products only): The computer is in the Sleep state, a power-saving state. The computer shuts off power to the display and other unnecessary components. Off: Depending on your computer model, the computer is off, in Hibernation, or in Sleep. Hibernation is the power-saving state that uses the least amount of power.
(6)	Fn lock light	On: The fn key is locked.

Button and fingerprint reader

Fingerprint readers can be located on the touchpad, on a side panel of the computer, or on the top cover below the keyboard.

 **IMPORTANT:** To verify that your computer supports fingerprint reader sign-in, select the **Search** icon in the taskbar, type `Sign-in options` in the search box, and then select the **Sign-on options** app. If

Fingerprint recognition is not listed as an option, then your notebook does not include a fingerprint reader.

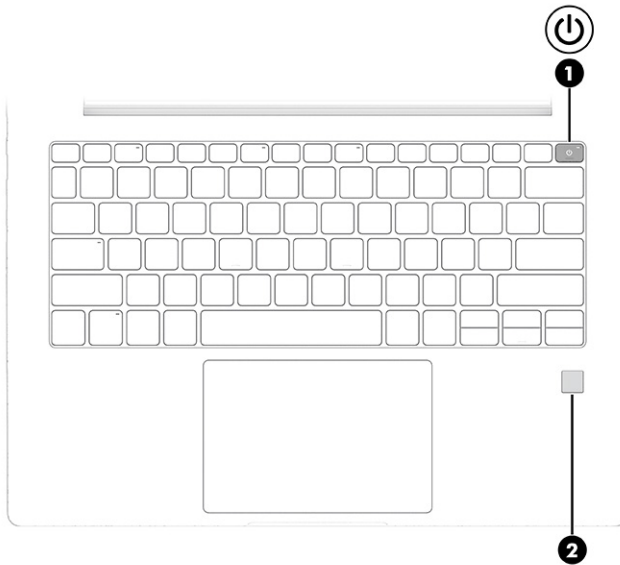



Table 3-6 Button and fingerprint reader and their descriptions

	Component	Description
(1)	 Power button	<ul style="list-style-type: none"> • When the computer is off, press the button briefly to turn on the computer. • When the computer is on, press the button briefly to initiate Sleep. • When the computer is in the Sleep state, press the button briefly to exit Sleep (select products only). • When the computer is in Hibernation, press the button briefly to exit Hibernation. <p>IMPORTANT: Pressing and holding down the power button results in the loss of unsaved information.</p> <p>If the computer has stopped responding and shutdown procedures are ineffective, press and hold the power button for at least 4 seconds to turn off the computer.</p> <p>To learn more about your power settings, use the Power icon.</p> <ul style="list-style-type: none"> • Right-click the Power icon , and then select Power and sleep settings.
(2)	Fingerprint reader (select products only)	<p>Allows a fingerprint logon to Windows, instead of a password logon.</p> <ul style="list-style-type: none"> ■ Touch your finger to the fingerprint reader. <p>IMPORTANT: To prevent fingerprint logon issues, make sure when you register your fingerprint that all sides of your finger are registered by the fingerprint reader.</p>

Special keys

Use the illustration and table to identify the special keys.

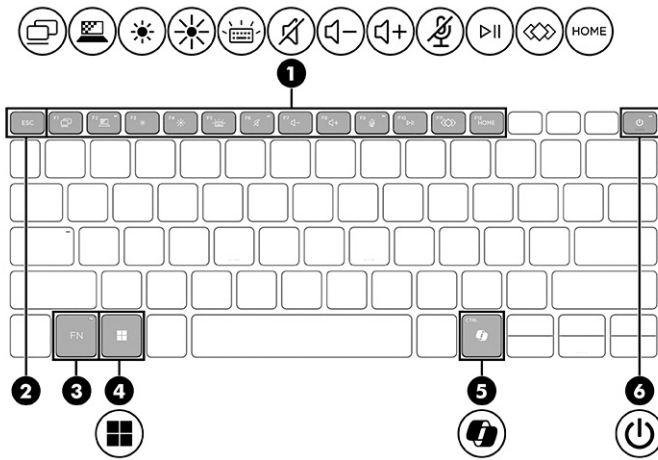



Table 3-7 Special keys and their descriptions

	Component	Description
(1)	Action keys	Execute frequently used system functions.
(2)	<code>esc</code> key	Displays system information when pressed in combination with the <code>fn</code> key.
(3)	<code>fn</code> key	Executes frequently used system functions when pressed in combination with another key. Such key combinations are called <i>hot keys</i> .
(4)	Windows key	Opens the Start menu. NOTE: Pressing the Windows key again will close the Start menu.
(5)	Windows Copilot key	Opens Windows Copilot (select products only).

Table 3-7 Special keys and their descriptions (continued)

	Component	Description
(6)	 Power button	<ul style="list-style-type: none"> When the computer is off, press the button briefly to turn on the computer. When the computer is on, press the button briefly to initiate Sleep. When the computer is in the Sleep state, press the button briefly to exit Sleep (select products only). When the computer is in Hibernation, press the button briefly to exit Hibernation. <p>IMPORTANT: Pressing and holding down the power button results in the loss of unsaved information.</p> <p>If the computer has stopped responding and shutdown procedures are ineffective, press and hold the power button for at least 4 seconds to turn off the computer.</p> <p>To learn more about your power settings, use the Power icon.</p> <ul style="list-style-type: none"> Right-click the Power icon  and then select Power and sleep settings.

Bottom

Use the illustration and table to identify the bottom components.

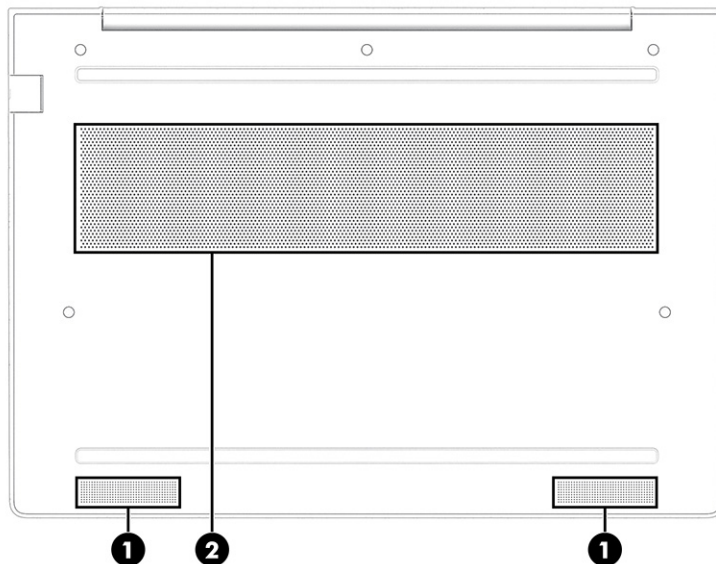

Table 3-8 Bottom components and their descriptions

Component	Description
(1)	Speakers (2) Produce sound.

Table 3-8 Bottom components and their descriptions (continued)

Component	Description
(2) Vent	Enables airflow to cool internal components. NOTE: The computer fan starts up automatically to cool internal components and prevent overheating. It is normal for the internal fan to cycle on and off during routine operation.

Rear

Use the illustration and table to identify the rear component.

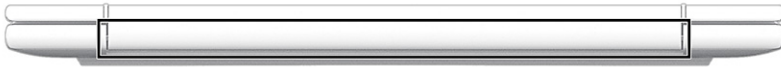



Table 3-9 Rear component and its descriptions

Component	Description
Vent	Enables airflow to cool internal components. NOTE: The computer fan starts up automatically to cool internal components and prevent overheating. It is normal for the internal fan to cycle on and off during routine operation.

Labels

The labels affixed to the computer provide information you might need when you troubleshoot system problems or travel internationally with the computer. Labels might be in paper form or imprinted on the product.

 **IMPORTANT:** Check the following locations for the labels described in this section: the bottom of the computer, inside the battery bay, under the service door, on the back of the display, or on the bottom of a tablet kickstand.

- Service label—Provides important information to identify your computer. When contacting support, you might be asked for the serial number, the product number, or the model number. Locate this information before you contact support.

Your service label will resemble one of the examples shown below. Refer to the illustration that most closely matches the service label on your computer.

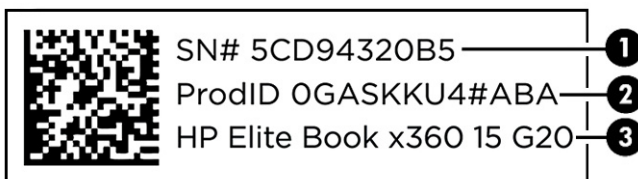

Table 3-10 Service label components

Component	
(1)	Serial number
(2)	Product ID
(3)	HP product name

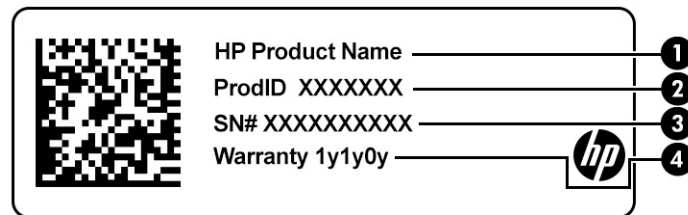

Table 3-11 Service label components

Component	
(1)	HP product name
(2)	Product ID
(3)	Serial number
(4)	Warranty period

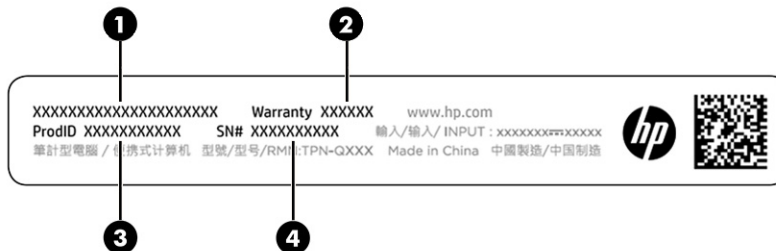



Table 3-12 Service label components

Component	
(1)	HP product name
(2)	Warranty period
(3)	Product ID
(4)	Serial number

- Regulatory labels—Provide regulatory information about the computer.
- Wireless certification labels—Provide information about optional wireless devices and the approval markings for the countries or regions in which the devices have been approved for use.

Using a SIM card (select products only)

Use these instructions to insert a SIM card.

 **IMPORTANT:** You can damage the SIM card if you insert the wrong size card or insert it or the SIM card tray in the wrong direction. The card might also become stuck in the slot. Do not use SIM card adapters. To prevent damage to the SIM card or connectors, use minimal force when inserting or removing a SIM card.

Determining the correct SIM card size for your computer

Before purchasing a SIM card, follow these instructions to determine the correct SIM card size for your computer.

1. Go to <http://www.hp.com/support>, and then search for your computer by product name or number.
2. Select **Product Information**.
3. Refer to the listed options to determine which card to purchase.

Inserting a SIM card in an external slot

To insert a SIM card in an external slot, follow these steps.

1. Turn off the computer by using the **Shut down** command.
2. Insert the SIM card into the SIM card slot, and then press in on the SIM card until it is firmly seated.

 **NOTE:** Your SIM card or the SIM card slot in your computer might look different from the illustration in this section.

 **NOTE:** Your SIM card slot might have an icon to show which way the card should be inserted into the computer.

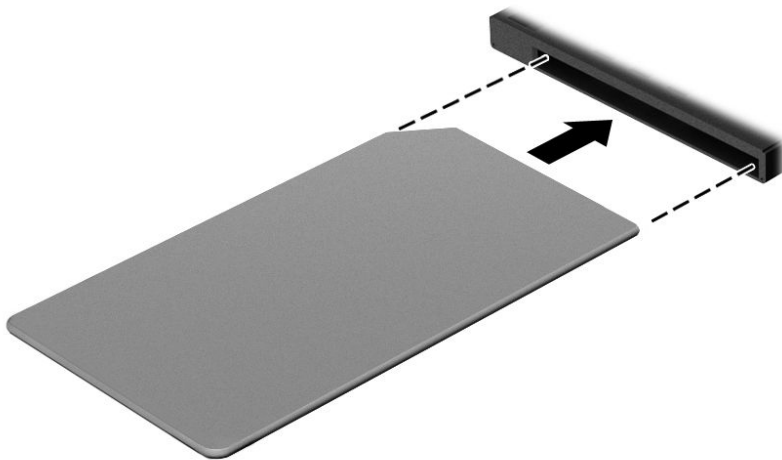

To remove the SIM card, press in gently on the card to disengage the SIM lock, and then remove it from the slot.

4 Illustrated parts catalog

Use this chapter to determine the spare parts that are available for the computer.

Computer major components

To identify the computer major components, use this illustration and table.

 **NOTE:** HP continually improves and changes product parts. For complete and current information about supported parts for your computer, go to <http://partsurfer.hp.com>, select your country or region, and then follow the on-screen instructions.

 **NOTE:** Details about your computer, including model, serial number, product key, and length of warranty, are on the service tag at the bottom of your computer.

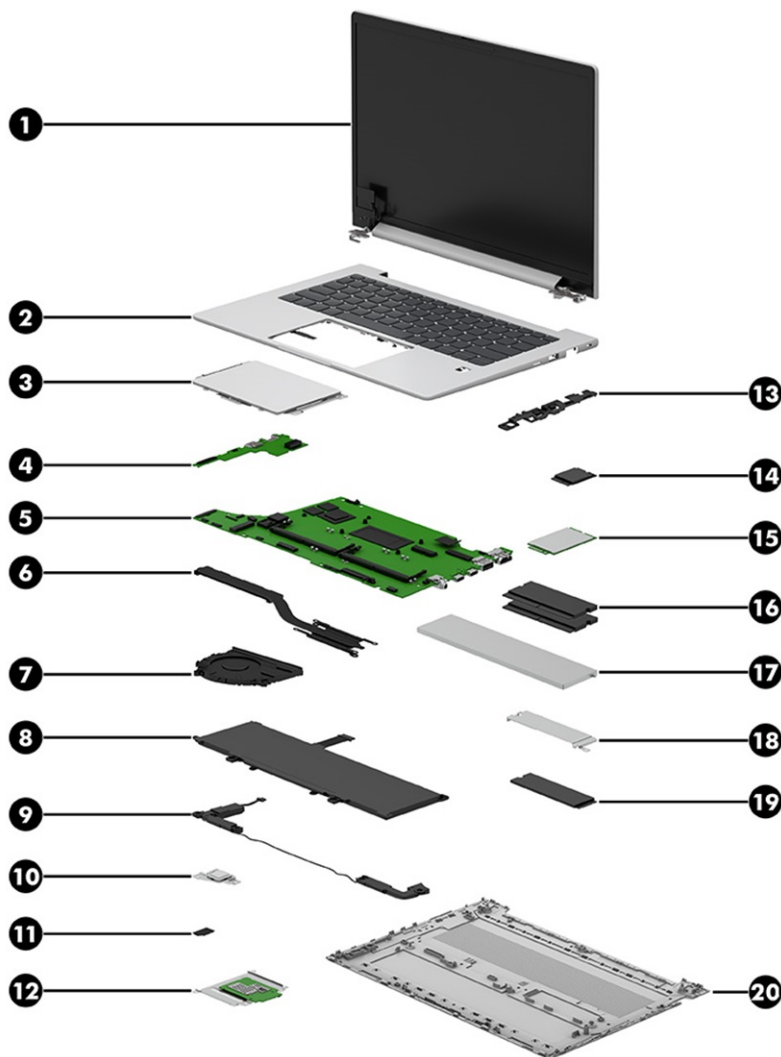

Table 4-1 Computer major component descriptions and part numbers

Item	Component	Spare part number
(1)	<p>Display assembly</p> <p>NOTE: Display spare parts are available only as subcomponents. For spare part information, see Display assembly subcomponents on page 34.</p>	not available as a spare part
(2)	<p>Top cover with keyboard</p> <p>NOTE: For a detailed list of country codes, see Top cover with keyboard on page 95.</p>	
	Backlit	N98719-001
	Backlit, privacy	N98718-001
	Not backlit	N98720-001
(3)	<p>Touchpad</p> <p>NOTE: The touchpad cable is available in the Cable Kit as spare part number N98721-001.</p>	N96237-001
	Models without NFC	N96237-001
	Models with NFC	N96238-001
(4)	<p>I/O board</p> <p>NOTE: The I/O board cables are available in the Cable Kit as spare part number N98721-001. The RJ-45 door is available as spare part number N96450-001 for plastic models and N96449-001 for metal models.</p>	
	Models without a Ryzen PRO processor	
	<ul style="list-style-type: none"> Models with WLAN only 	N95961-001
	<ul style="list-style-type: none"> Models with WLAN and WWAN 	N95962-001
	Models with a Ryzen PRO processor	
	<ul style="list-style-type: none"> Models with WLAN only 	P07357-001
	<ul style="list-style-type: none"> Models with WLAN and WWAN 	P07358-001
(5)	<p>System board (includes integrated processor)</p> <p>NOTE: All system board spare part kits include replacement thermal material.</p> <p>All system boards use the following part numbers:</p> <p>xxxxxx-001: Non-Windows operating systems</p> <p>xxxxxx-601: Windows operating system</p>	
	AMD Ryzen 7 7735U processor	N95973-xx1
	AMD Ryzen 7 7735U processor and WWAN	N95972-xx1
	AMD Ryzen 5 7535U processor	N95969-xx1
	AMD Ryzen 5 7535U processor and WWAN	N95968-xx1
	AMD Ryzen 3 7335U processor	N95967-xx1
	AMD Ryzen 3 7335U processor and WWAN	N95966-xx1
	AMD Ryzen 7 PRO 7735U processor and WWAN	N95974-xx1
	AMD Ryzen 5 PRO 7535U processor	N95971-xx1

Table 4-1 Computer major component descriptions and part numbers (continued)

Item	Component	Spare part number
	AMD Ryzen 5 PRO 7535U processor and WWAN	N95970-xx1
	AMD Ryzen 3 PRO 7335U processor	N95965-xx1
	AMD Ryzen 3 PRO 7335U processor and WWAN	N95964-xx1
(6)	Heat sink	N96443-001
(7)	Fan	N96441-001
(8)	Battery	
	3 cell, 56 Whr	N70706-005
(9)	Speaker	N96451-001
(10)	Fingerprint reader (not illustrated)	N96242-001
	NOTE: The fingerprint reader cable is available in the Cable Kit as spare part number N98721-001. The fingerprint reader bracket is available as spare part number N96233-001. The fingerprint reader insert (for use in models without a fingerprint reader) is available in the Plastics Kit as spare part number N96234-001	
(11)	NFC module	914758-001
	NOTE: The NFC antenna is available as spare part number N96725-001.	
(12)	Smart card reader	N96232-001
(13)	System board bracket (available in the Plastics Kit)	N96234-001
(14)	WLAN module	
	MediaTek RZ616 Wi-Fi 6E Bluetooth 5.3 AIM-T WLAN	N22541-005
	Realtek 8852CE Wi-Fi 6E Bluetooth 5.3 WLAN	N19618-005
(15)	WWAN module	
	HP 4000 4G LTE-Advanced Pro	N65633-005
(16)	Memory modules (DDR5, PC-5600)	
	32 GB	N50075-001
	32 GB, not made in China (NMIC)	N97399-001
	32 GB, for use in the People's Republic of China (PRC)	N77400-001
	16 GB	N38627-001
	16 GB, NMIC	N93773-001
	16 GB, for use in the PRC	N77399-001
	8 GB	N37792-001
	8 GB, for use in the PRC	N77398-001
(17)	Memory cover	not available as a spare part
(18)	SSD cover	N96251-001
(19)	Solid-state drive (PCIe-4 × 4, M.2 2280)	
	NOTE: The solid-state drive support kit is available as spare part number N96251-001.	

Table 4-1 Computer major component descriptions and part numbers (continued)

Item	Component	Spare part number
	2 TB, TLC	M52027-001
	2 TB, TLC, for use in the People's Republic of China (PRC)	N77396-001
	1 TB, TLC	M16560-001
	1 TB, TLC, for use in the PRC	N77395-001
	1 TB, TLC, NMIC	N22908-001
	1 TB, TLC, self-encrypting drive (SED)	N23415-001
	1 TB, TLC, self-encrypting drive (SED), NMIC	N24954-001
	512 GB	N45476-001
	512 GB, TLC	M17436-001
	512 GB, TLC, self-encrypting drive (SED)	M52031-001
	512 GB, TLC, for use in the PRC	N77393-001
	512 GB, for use in the PRC	N77392-001
	256 GB	N45477-001
	256 GB, self-encrypting drive (SED)	N35225-001
	256 GB, for use in the PRC	N77391-001
(20)	Bottom cover	
	Plastic	N96446-001
	Metal	N96448-001

Display assembly subcomponents

To identify the display assembly subcomponents, use this illustration and table.

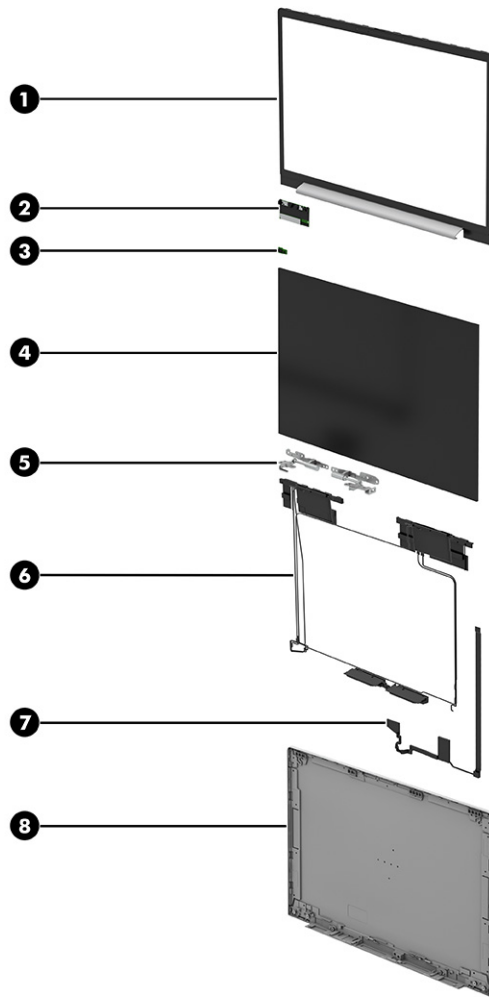

Table 4-2 Display component descriptions and part numbers

Item	Component	Spare part number
(1)	Display bezel	
	For use in models with an FHD camera	N96562-001
	For use in models with an IR camera	N96561-001
	For use in models with no camera	N96563-001
	For use in models with an IR camera and privacy display	N96564-001
(2)	Camera module	
	FHD camera	N96913-001
	5 MP + IR camera	N96912-001
*	Microphone module	N99998-001
(3)	Ambient light sensor	N96911-001
(4)	Display panel (WUXGA, includes cover and bezel adhesive)	
	300 nits. touch screen	N98714-001

Table 4-2 Display component descriptions and part numbers (continued)

Item	Component	Spare part number
	300 nits	N98715-001
	400 nits	N98717-001
	1000 nits, privacy	N98716-001
(5)	Hinges (includes left and right hinges, display panel stretchable tape, and bezel adhesive)	N96454-001
(6)	Wireless antennas and cables (includes WLAN antennas, WWAN antennas, display panel stretchable tape, and bezel adhesive)	N96452-001
(7)	Display/camera cable (includes cover and bezel adhesive)	N96453-001
(8)	Display back cover (includes wireless antennas and bezel adhesive)	
	Models with a 300 nit panel, WLAN, no WWAN	N96535-001
	Models with a 300 nit panel, IR camera, WLAN, no WWAN	N96536-001
	Models with a 300 nit panel, WLAN, WWAN	N96540-001
	Models with a 300 nit panel, IR camera, WLAN, WWAN	N96537-001
	Models with a 1000 nit privacy panel, IR camera, WLAN, no WWAN	N96542-001
	Models with a 1000 nit privacy panel, IR camera, WLAN, WWAN	N96543-001
	Models with a 400 nit panel, IR camera, WLAN, no WWAN	N96544-001
	Models with a 400 nit panel, WLAN, no WWAN	N96545-001
	Models with a 400 nit panel, IR camera, WLAN, WWAN	N96546-001
*	NFC antenna	N96725-001

*not illustrated

Screw Kit components

To identify Screw Kit contents, use this illustration and table.

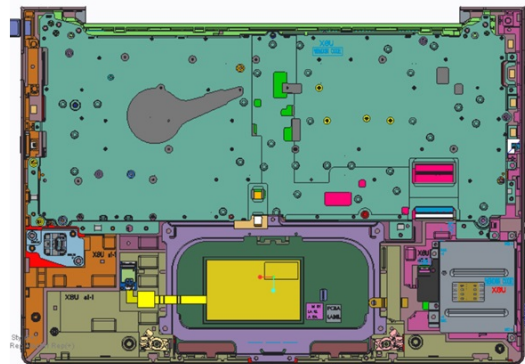
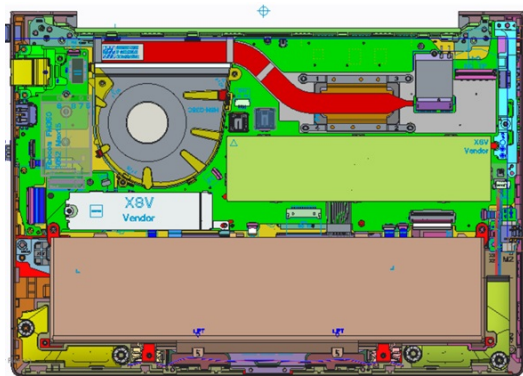

Table 4-3 Screw Kit contents

Location	Driver	Dia	Lng	Head dia	Head thick	Plate	Qty	Location
●	#1	M2.5	4L	4.5	0.8	BZN	5	Hinge system
●	#1	M2	2L	7	0.55	BZN	8	Spk(4)/Touch pad (4)
○	#1	M2	1.8L	5	0.7	BNI	3	Main PCB(2)/WWAN PCBA(1)
●	#1	M2	2.5L	4.5	0.5	NI	1	WWAN 5G
●	#1	M2	2.5L	4.5	0.5	NI	1	WLAN
●	#1	M2	2.5L	4.5	0.5	NI	1	SSD 2280
●	#1	M2	2.5L	4.5	0.5	NI	4	Smart card
●	#1	M2	2.5L	4.5	0.5	NI	2	FPR
●	#1	M2	2.5L	4.5	0.5	NI	4	Heat sink
●	#1	M2	2.5L	4.5	0.5	NI	1	WWAN 4G
●	#1	M2	4L	4.6	0.8	BNI	8	USB board PCBA(2)/RJ-45 holder(3)/IO holder(3)
●	#1	M2	4L	4.6	0.8	BNI	3	Fan
●	#1	M2	4L	4.6	0.8	BNI	1	Audio PCBA
●	#1	M2	4L	4.6	0.8	BNI	1	SSD plate
●	#0	M1.6	2L	3	0.5	BZN	3	Touchpad(3)
●	#1	M2.5	7.3L	4.3	0.8	Pike silver	5	Base

Miscellaneous parts

To identify the miscellaneous parts, use this table.

Table 4-4 Miscellaneous part descriptions and part numbers

Component	Spare part number
AC adapters	
280 W, PFC, 7.4 mm	M52952-001
120 W, PFC, 7.4 mm	L89695-001
120 W, PFC, 4.5 mm	M95377-001
65 W, nPFC, USB-C®, 1.8 m (6.0 ft)	L67440-001
65 W, nPFC, USB-C, 1.8 m (6.0 ft), halogen free (HF)	N90678-001
65 W, nPFC, USB-C	M54350-001
65 W, USB Type-C	N05175-001
Headset	
Blackwire 3325	N45998-001

Table 4-4 Miscellaneous part descriptions and part numbers (continued)

Component	Spare part number
Blackwire 5220	N46012-001
Voyager 4320	N57159-001
Voyager 60UC	N73088-001
USB-C-to-DisplayPort adapter	831753-001
USB-C-to-DisplayPort adapter G2 (TAA)	N81436-001
USB-C-to-DisplayPort2 adapter	N81435-001
USB-C-to-HDMI 2.0 adapter	935325-001
USB-C-to-VGA adapter	831751-001
USB-C-to-USB-A adapter	L65254-001
USB-C (male)-to-USB-C (male) adapter	L65253-001
HDMI-to-VGA adapter	701943-001
HP Universal USB-C Multiport Hub	M96882-001
Multiport USB-C Travel Hub	N60372-001
HP 14.1 Business Slim Top Load Case	L05333-001
HP Executive 16 Laptop Backpack	N19979-001
HP Executive 16 Laptop Bag	N19980-001
HP Prelude 15.6 Top Load Case	M16117-001
HP Prelude 15.6 Backpack	M16116-001
HP Business 17.3 Laptop Case	M55004-001
HP Business 14.1 Laptop Case	M55007-001
HP Prelude Pro 15.6 Top Load Case	M03618-001
HP Prelude Pro 15.6 Backpack	M03617-001
Screw Kit (for use with HP USB-C Dock G5)	L64089-001
Screw Kit (for use in product component removal and replacement)	N96250-001
Plastics and Rubber Kit (includes fingerprint reader insert, I/O holder, SIM card insert, smart card insert, left and right battery hooks, and SSD frame support)	N96234-001
Bracket Kit (includes smart card bracket and fingerprint reader bracket)	N96233-001
USB mouse	L95713-001
HP Wireless Premium Mouse	923947-001
HP 435 Wireless Mouse	M62277-001
HP 235 Wireless Mouse	M86086-001
HP USB Keyboard	L95712-001
HP 125 Wired Keyboard	M27881-001
Nano lock	918431-001
HP Nano Combination Cable Lock	N10500-001

Table 4-4 Miscellaneous part descriptions and part numbers (continued)

Component	Spare part number
HP Essential Nano Combination Cable Lock	N10501-001
External optical drive	747080-001
Thunderbolt™ 120 W G4 dock (with cable)	M97105-001
Thunderbolt 280 W G4 dock (with cable)	M97106-001
Thunderbolt dock 120 W (with cable)	L15809-001
USB-C Dock G5 (with cable)	L64086-001
Bottom case for USB-C G5 Dock	L65256-001
Cable kit for use with Thunderbolt 120 W G4 dock	M88058-001
Cable kit for use with Thunderbolt 280 W G4 dock	M88059-001
Power cord (C13, premium, 1.0 m [3.3 ft])	
Argentina	L32029-001
Australia	N24670-001
Denmark	N24672-001
Europe (Austria, Belgium, Finland, France, Germany, the Netherlands, Norway, and Sweden)	N24669-001
India	N24679-001
Israel	N24678-001
Italy	L32031-001
Japan	N24680-001
North America	N24671-001
People's Republic of China	N24676-001
South Africa	N24674-001
South Korea	N24675-001
Switzerland	N24673-001
Taiwan	N24677-001
The United Kingdom	N24668-001
Power adapter, duckhead	
Japan	L33157-001
Power cord (C5, conventional, 1.0 m [3.3 ft], HF)	
Denmark	M79264-001
Europe (Austria, Belgium, Finland, France, Germany, the Netherlands, Norway, and Sweden)	M79266-001
Switzerland	M79265-001
Power cord (C5, conventional, 1.0 m [3.3 ft])	
Argentina	L19357-001
Australia	L19358-001

Table 4-4 Miscellaneous part descriptions and part numbers (continued)

Component	Spare part number
Brazil	L19359-001
Denmark	L19360-001
Europe (Austria, Belgium, Finland, France, Germany, the Netherlands, Norway, and Sweden)	L19361-001
Europe (ADP + cord)	N16170-001
India	L19363-001
Israel	L19362-001
Italy	L19364-001
Japan	L19365-001
North America	L19367-001
People's Republic of China	L19368-001
South Africa	L19369-001
South Korea	L19366-001
Switzerland	L19370-001
Taiwan	L19372-001
Thailand	L19371-001
Thailand (ADP + cord)	M85418-001
The United Kingdom	L19373-001
The United Kingdom, HF	M82711-001
Power cord (C5, conventional, 1.8 m [6.0 ft])	
Argentina	L19357-002
Australia	L19358-002
Brazil	L19359-002
Denmark	L19360-002
Europe (Austria, Belgium, Finland, France, Germany, the Netherlands, Norway, and Sweden)	L19361-002
India	L19363-002
Israel	L19362-002
Italy	L19364-002
Japan	L19365-002
North America	L19367-002
People's Republic of China	L19368-002
South Africa	L19369-002
South Korea	L19366-002
Switzerland	L19370-002
Taiwan	L19372-002

Table 4-4 Miscellaneous part descriptions and part numbers (continued)

Component	Spare part number
Thailand	L19371-002
The United Kingdom	L19373-002
Power cord (C5, premium, straight, 1.0 m [3.3 ft])	
Argentina	L30811-001
Australia	L22327-001
Brazil	L30812-001
Brazil, duckhead	L19341-002
Denmark	L22322-001
Europe (Austria, Belgium, Finland, France, Germany, the Netherlands, Norway, and Sweden)	L22321-001
India	L22624-001
Israel	L22323-001
Italy	L30813-001
Japan	L22330-001
North America	L22319-001
People's Republic of China (PRC)	L21930-001
South Africa	L22325-001
South Korea	L22328-001
Switzerland	L22324-001
Taiwan	L22329-001
Thailand (ADP + cord)	L22326-001
Thailand bundle	M85421-001
The United Kingdom	L22320-001

5 Illustrated parts catalog

Use this chapter to determine the spare parts that are available for the computer.

Computer major components

To identify the computer major components, use this illustration and table.

 **NOTE:** HP continually improves and changes product parts. For complete and current information about supported parts for your computer, go to <http://partsurfer.hp.com>, select your country or region, and then follow the on-screen instructions.

 **NOTE:** Details about your computer, including model, serial number, product key, and length of warranty, are on the service tag at the bottom of your computer.

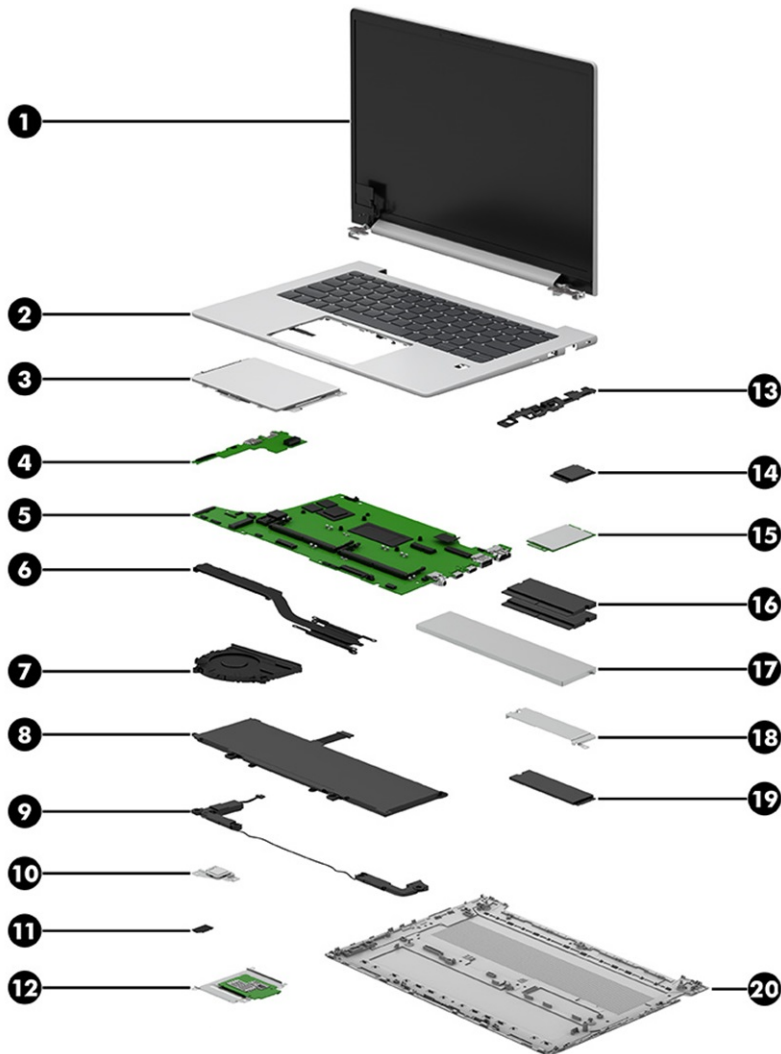

Table 5-1 Computer major component descriptions and part numbers

Item	Component	Spare part number
(1)	<p>Display assembly</p> <p>NOTE: Display spare parts are available only as subcomponents. For spare part information, see Display assembly subcomponents on page 34.</p>	not available as a spare part
(2)	<p>Top cover with keyboard</p> <p>NOTE: For a detailed list of country codes, see Top cover with keyboard on page 95.</p>	
	Backlit	N98719-001
	Backlit, privacy	N98718-001
	Not backlit	N98720-001
(3)	<p>Touchpad</p> <p>NOTE: The touchpad cable is available in the Cable Kit as spare part number N98721-001.</p>	N96237-001
	Models without NFC	N96237-001
	Models with NFC	N96238-001
(4)	<p>I/O board</p> <p>NOTE: The I/O board cables are available in the Cable Kit as spare part number N98721-001. The RJ-45 door is available as spare part number N96450-001 for plastic models and N96449-001 for metal models.</p>	
	Models without a Ryzen PRO processor	
	<ul style="list-style-type: none"> Models with WLAN only 	N95961-001
	<ul style="list-style-type: none"> Models with WLAN and WWAN 	N95962-001
	Models with a Ryzen PRO processor	
	<ul style="list-style-type: none"> Models with WLAN only 	P07357-001
	<ul style="list-style-type: none"> Models with WLAN and WWAN 	P07358-001
(5)	<p>System board (includes integrated processor)</p> <p>NOTE: All system board spare part kits include replacement thermal material.</p> <p>All system boards use the following part numbers:</p> <p>xxxxxx-001: Non-Windows operating systems</p> <p>xxxxxx-601: Windows operating system</p>	
	AMD Ryzen 7 7735U processor	N95973-xx1
	AMD Ryzen 7 7735U processor and WWAN	N95972-xx1
	AMD Ryzen 5 7535U processor	N95969-xx1
	AMD Ryzen 5 7535U processor and WWAN	N95968-xx1
	AMD Ryzen 3 7335U processor	N95967-xx1
	AMD Ryzen 3 7335U processor and WWAN	N95966-xx1
	AMD Ryzen 7 PRO 7735U processor and WWAN	N95974-xx1
	AMD Ryzen 5 PRO 7535U processor	N95971-xx1

Table 5-1 Computer major component descriptions and part numbers (continued)

Item	Component	Spare part number
	AMD Ryzen 5 PRO 7535U processor and WWAN	N95970-xx1
	AMD Ryzen 3 PRO 7335U processor	N95965-xx1
	AMD Ryzen 3 PRO 7335U processor and WWAN	N95964-xx1
(6)	Heat sink	N96443-001
(7)	Fan	N96441-001
(8)	Battery	
	3 cell, 56 Whr	N70706-005
(9)	Speaker	N96451-001
(10)	Fingerprint reader (not illustrated)	N96242-001
	NOTE: The fingerprint reader cable is available in the Cable Kit as spare part number N98721-001. The fingerprint reader bracket is available as spare part number N96233-001. The fingerprint reader insert (for use in models without a fingerprint reader) is available in the Plastics Kit as spare part number N96234-001	
(11)	NFC module	914758-001
	NOTE: The NFC antenna is available as spare part number N96725-001.	
(12)	Smart card reader	N96232-001
(13)	System board bracket (available in the Plastics Kit)	N96234-001
(14)	WLAN module	
	MediaTek RZ616 Wi-Fi 6E Bluetooth 5.3 AIM-T WLAN	N22541-005
	Realtek 8852CE Wi-Fi 6E Bluetooth 5.3 WLAN	N19618-005
(15)	WWAN module	
	HP 4000 4G LTE-Advanced Pro	N65633-005
(16)	Memory modules (DDR5, PC-5600)	
	32 GB	N50075-001
	32 GB, not made in China (NMIC)	N97399-001
	32 GB, for use in the People's Republic of China (PRC)	N77400-001
	16 GB	N38627-001
	16 GB, NMIC	N93773-001
	16 GB, for use in the PRC	N77399-001
	8 GB	N37792-001
	8 GB, for use in the PRC	N77398-001
(17)	Memory cover	not available as a spare part
(18)	SSD cover	N96251-001
(19)	Solid-state drive (PCIe-4 × 4, M.2 2280)	
	NOTE: The solid-state drive support kit is available as spare part number N96251-001.	

Table 5-1 Computer major component descriptions and part numbers (continued)

Item	Component	Spare part number
	2 TB, TLC	M52027-001
	2 TB, TLC, for use in the People's Republic of China (PRC)	N77396-001
	1 TB, TLC	M16560-001
	1 TB, TLC, for use in the PRC	N77395-001
	1 TB, TLC, NMIC	N22908-001
	1 TB, TLC, self-encrypting drive (SED)	N23415-001
	1 TB, TLC, self-encrypting drive (SED), NMIC	N24954-001
	512 GB	N45476-001
	512 GB, TLC	M17436-001
	512 GB, TLC, self-encrypting drive (SED)	M52031-001
	512 GB, TLC, for use in the PRC	N77393-001
	512 GB, for use in the PRC	N77392-001
	256 GB	N45477-001
	256 GB, self-encrypting drive (SED)	N35225-001
	256 GB, for use in the PRC	N77391-001
(20)	Bottom cover	
	Plastic	N96446-001
	Metal	N96448-001

Display assembly subcomponents

To identify the display assembly subcomponents, use this illustration and table.

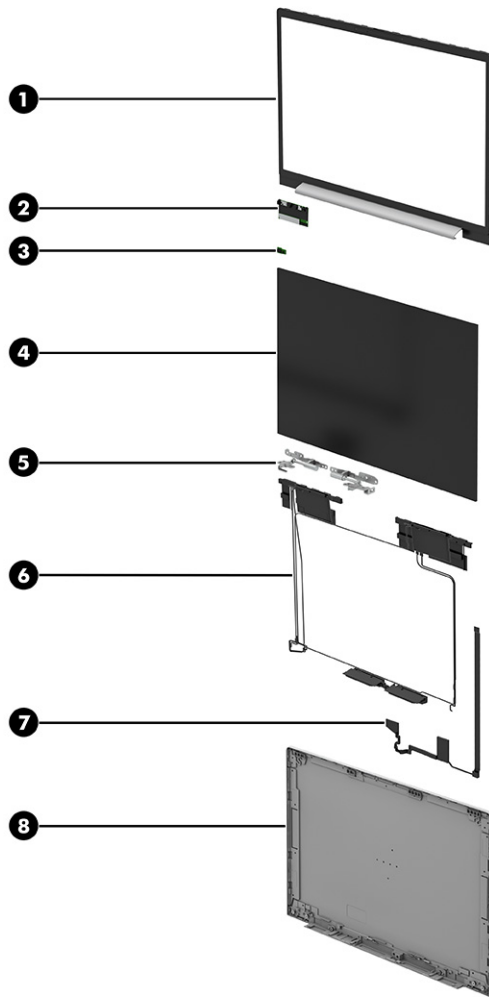

Table 5-2 Display component descriptions and part numbers

Item	Component	Spare part number
(1)	Display bezel	
	For use in models with an FHD camera	N96562-001
	For use in models with an IR camera	N96561-001
	For use in models with no camera	N96563-001
	For use in models with an IR camera and privacy display	N96564-001
(2)	Camera module	
	FHD camera	N96913-001
	5 MP + IR camera	N96912-001
*	Microphone module	N99998-001
(3)	Ambient light sensor	N96911-001
(4)	Display panel (WUXGA, includes cover and bezel adhesive)	
	300 nits. touch screen	N98714-001

Table 5-2 Display component descriptions and part numbers (continued)

Item	Component	Spare part number
	300 nits	N98715-001
	400 nits	N98717-001
	1000 nits, privacy	N98716-001
(5)	Hinges (includes left and right hinges, display panel stretchable tape, and bezel adhesive)	N96454-001
(6)	Wireless antennas and cables (includes WLAN antennas, WWAN antennas, display panel stretchable tape, and bezel adhesive)	N96452-001
(7)	Display/camera cable (includes cover and bezel adhesive)	N96453-001
(8)	Display back cover (includes wireless antennas and bezel adhesive)	
	Models with a 300 nit panel, WLAN, no WWAN	N96535-001
	Models with a 300 nit panel, IR camera, WLAN, no WWAN	N96536-001
	Models with a 300 nit panel, WLAN, WWAN	N96540-001
	Models with a 300 nit panel, IR camera, WLAN, WWAN	N96537-001
	Models with a 1000 nit privacy panel, IR camera, WLAN, no WWAN	N96542-001
	Models with a 1000 nit privacy panel, IR camera, WLAN, WWAN	N96543-001
	Models with a 400 nit panel, IR camera, WLAN, no WWAN	N96544-001
	Models with a 400 nit panel, WLAN, no WWAN	N96545-001
	Models with a 400 nit panel, IR camera, WLAN, WWAN	N96546-001
*	NFC antenna	N96725-001

*not illustrated

Screw Kit components

To identify Screw Kit contents, use this illustration and table.

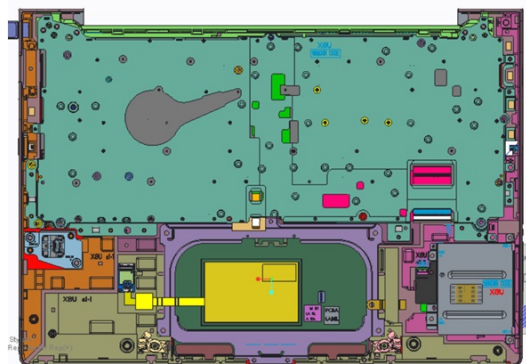
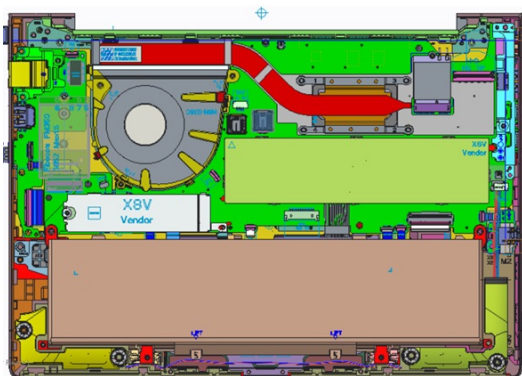

Table 5-3 Screw Kit contents

Location	Driver	Dia	Lng	Head dia	Head thick	Plate	Qty	Location
●	#1	M2.5	4L	4.5	0.8	BZN	5	Hinge system
●	#1	M2	2L	7	0.55	BZN	8	Spk(4)/Touch pad (4)
○	#1	M2	1.8L	5	0.7	BNI	3	Main PCB(2)/WWAN PCBA(1)
●	#1	M2	2.5L	4.5	0.5	NI	1	WWAN 5G
●	#1	M2	2.5L	4.5	0.5	NI	1	WLAN
●	#1	M2	2.5L	4.5	0.5	NI	1	SSD 2280
●	#1	M2	2.5L	4.5	0.5	NI	4	Smart card
●	#1	M2	2.5L	4.5	0.5	NI	2	FPR
●	#1	M2	2.5L	4.5	0.5	NI	4	Heat sink
●	#1	M2	2.5L	4.5	0.5	NI	1	WWAN 4G
●	#1	M2	4L	4.6	0.8	BNI	8	USB board PCBA(2)/RJ-45 holder(3)/IO holder(3)
●	#1	M2	4L	4.6	0.8	BNI	3	Fan
●	#1	M2	4L	4.6	0.8	BNI	1	Audio PCBA
●	#1	M2	4L	4.6	0.8	BNI	1	SSD plate
●	#0	M1.6	2L	3	0.5	BZN	3	Touchpad(3)
●	#1	M2.5	7.3L	4.3	0.8	Pike silver	5	Base

Miscellaneous parts

To identify the miscellaneous parts, use this table.

Table 5-4 Miscellaneous part descriptions and part numbers

Component	Spare part number
AC adapters	
280 W, PFC, 7.4 mm	M52952-001
120 W, PFC, 7.4 mm	L89695-001
120 W, PFC, 4.5 mm	M95377-001
65 W, nPFC, USB-C®, 1.8 m (6.0 ft)	L67440-001
65 W, nPFC, USB-C, 1.8 m (6.0 ft), halogen free (HF)	N90678-001
65 W, nPFC, USB-C	M54350-001
65 W, USB Type-C	N05175-001
Headset	
Blackwire 3325	N45998-001

Table 5-4 Miscellaneous part descriptions and part numbers (continued)

Component	Spare part number
Blackwire 5220	N46012-001
Voyager 4320	N57159-001
Voyager 60UC	N73088-001
USB-C-to-DisplayPort adapter	831753-001
USB-C-to-DisplayPort adapter G2 (TAA)	N81436-001
USB-C-to-DisplayPort2 adapter	N81435-001
USB-C-to-HDMI 2.0 adapter	935325-001
USB-C-to-VGA adapter	831751-001
USB-C-to-USB-A adapter	L65254-001
USB-C (male)-to-USB-C (male) adapter	L65253-001
HDMI-to-VGA adapter	701943-001
HP Universal USB-C Multiport Hub	M96882-001
Multiport USB-C Travel Hub	N60372-001
HP 14.1 Business Slim Top Load Case	L05333-001
HP Executive 16 Laptop Backpack	N19979-001
HP Executive 16 Laptop Bag	N19980-001
HP Prelude 15.6 Top Load Case	M16117-001
HP Prelude 15.6 Backpack	M16116-001
HP Business 17.3 Laptop Case	M55004-001
HP Business 14.1 Laptop Case	M55007-001
HP Prelude Pro 15.6 Top Load Case	M03618-001
HP Prelude Pro 15.6 Backpack	M03617-001
Screw Kit (for use with HP USB-C Dock G5)	L64089-001
Screw Kit (for use in product component removal and replacement)	N96250-001
Plastics and Rubber Kit (includes fingerprint reader insert, I/O holder, SIM card insert, smart card insert, left and right battery hooks, and SSD frame support)	N96234-001
Bracket Kit (includes smart card bracket and fingerprint reader bracket)	N96233-001
USB mouse	L95713-001
HP Wireless Premium Mouse	923947-001
HP 435 Wireless Mouse	M62277-001
HP 235 Wireless Mouse	M86086-001
HP USB Keyboard	L95712-001
HP 125 Wired Keyboard	M27881-001
Nano lock	918431-001
HP Nano Combination Cable Lock	N10500-001

Table 5-4 Miscellaneous part descriptions and part numbers (continued)

Component	Spare part number
HP Essential Nano Combination Cable Lock	N10501-001
External optical drive	747080-001
Thunderbolt™ 120 W G4 dock (with cable)	M97105-001
Thunderbolt 280 W G4 dock (with cable)	M97106-001
Thunderbolt dock 120 W (with cable)	L15809-001
USB-C Dock G5 (with cable)	L64086-001
Bottom case for USB-C G5 Dock	L65256-001
Cable kit for use with Thunderbolt 120 W G4 dock	M88058-001
Cable kit for use with Thunderbolt 280 W G4 dock	M88059-001
Power cord (C13, premium, 1.0 m [3.3 ft])	
Argentina	L32029-001
Australia	N24670-001
Denmark	N24672-001
Europe (Austria, Belgium, Finland, France, Germany, the Netherlands, Norway, and Sweden)	N24669-001
India	N24679-001
Israel	N24678-001
Italy	L32031-001
Japan	N24680-001
North America	N24671-001
People's Republic of China	N24676-001
South Africa	N24674-001
South Korea	N24675-001
Switzerland	N24673-001
Taiwan	N24677-001
The United Kingdom	N24668-001
Power adapter, duckhead	
Japan	L33157-001
Power cord (C5, conventional, 1.0 m [3.3 ft], HF)	
Denmark	M79264-001
Europe (Austria, Belgium, Finland, France, Germany, the Netherlands, Norway, and Sweden)	M79266-001
Switzerland	M79265-001
Power cord (C5, conventional, 1.0 m [3.3 ft])	
Argentina	L19357-001
Australia	L19358-001

Table 5-4 Miscellaneous part descriptions and part numbers (continued)

Component	Spare part number
Brazil	L19359-001
Denmark	L19360-001
Europe (Austria, Belgium, Finland, France, Germany, the Netherlands, Norway, and Sweden)	L19361-001
Europe (ADP + cord)	N16170-001
India	L19363-001
Israel	L19362-001
Italy	L19364-001
Japan	L19365-001
North America	L19367-001
People's Republic of China	L19368-001
South Africa	L19369-001
South Korea	L19366-001
Switzerland	L19370-001
Taiwan	L19372-001
Thailand	L19371-001
Thailand (ADP + cord)	M85418-001
The United Kingdom	L19373-001
The United Kingdom, HF	M82711-001
Power cord (C5, conventional, 1.8 m [6.0 ft])	
Argentina	L19357-002
Australia	L19358-002
Brazil	L19359-002
Denmark	L19360-002
Europe (Austria, Belgium, Finland, France, Germany, the Netherlands, Norway, and Sweden)	L19361-002
India	L19363-002
Israel	L19362-002
Italy	L19364-002
Japan	L19365-002
North America	L19367-002
People's Republic of China	L19368-002
South Africa	L19369-002
South Korea	L19366-002
Switzerland	L19370-002
Taiwan	L19372-002

Table 5-4 Miscellaneous part descriptions and part numbers (continued)

Component	Spare part number
Thailand	L19371-002
The United Kingdom	L19373-002
Power cord (C5, premium, straight, 1.0 m [3.3 ft])	
Argentina	L30811-001
Australia	L22327-001
Brazil	L30812-001
Brazil, duckhead	L19341-002
Denmark	L22322-001
Europe (Austria, Belgium, Finland, France, Germany, the Netherlands, Norway, and Sweden)	L22321-001
India	L22624-001
Israel	L22323-001
Italy	L30813-001
Japan	L22330-001
North America	L22319-001
People's Republic of China (PRC)	L21930-001
South Africa	L22325-001
South Korea	L22328-001
Switzerland	L22324-001
Taiwan	L22329-001
Thailand (ADP + cord)	L22326-001
Thailand bundle	M85421-001
The United Kingdom	L22320-001

6 Removal and replacement procedures preliminary requirements

Use this information to properly prepare to disassemble and reassemble the computer.

Tools required

You need the following tools to complete the removal and replacement procedures:

- Tweezers
- Nonconductive, nonmarking pry tool
- Magnetic Phillips P1 screwdriver

Service considerations

The following sections include some of the considerations that you must keep in mind during disassembly and assembly procedures.

 **NOTE:** As you remove each subassembly from the computer, place the subassembly (and all accompanying screws) away from the work area to prevent damage.

Plastic parts

Using excessive force during disassembly and reassembly can damage plastic parts.

Cables and connectors

Handle cables with extreme care to avoid damage.

 **IMPORTANT:** When servicing the computer, be sure that cables are placed in their proper locations during the reassembly process. Improper cable placement can damage the computer.

Apply only the tension required to unseat or seat the cables during removal and insertion. Handle cables by the connector whenever possible. In all cases, avoid bending, twisting, or tearing cables. Be sure that cables are routed so that they cannot be caught or snagged as you remove or replace parts. Handle flex cables with extreme care; these cables tear easily.

Drive handling

Note the following guidelines when handling drives.

 **IMPORTANT:** Drives are fragile components. Handle them with care. To prevent damage to the computer, damage to a drive, or loss of information, observe these precautions:

- Before removing or inserting a hard drive, shut down the computer. If you are unsure whether the computer is off or in Hibernation, turn the computer on, and then shut it down through the operating system.

- Before handling a drive, be sure that you are discharged of static electricity. While handling a drive, avoid touching the connector.
 - Before removing an optical drive, be sure that a disc is not in the drive, and be sure that the optical drive tray is closed.
 - Handle drives on surfaces covered with at least 2.54 cm (1 inch) of shock-proof foam.
 - Avoid dropping drives from any height onto any surface.
 - After removing a hard drive or an optical drive, place it in a static-proof bag.
 - Avoid exposing an internal hard drive to products that have magnetic fields, such as monitors or speakers.
 - Avoid exposing a drive to temperature extremes or liquids.
 - If a drive must be mailed, place the drive in a bubble pack mailer or other suitable form of protective packaging, and label the package "FRAGILE."
-

Electrostatic discharge information

A sudden discharge of static electricity from your finger or other conductor can destroy static-sensitive devices or microcircuitry. Often the spark is neither felt nor heard, but damage occurs. An electronic device exposed to electrostatic discharge (ESD) might not appear to be affected at all and can work perfectly throughout a normal cycle. The device might function normally for a while, but it has been degraded in the internal layers, reducing its life expectancy.

Networks built into many integrated circuits provide some protection, but in many cases, the discharge contains enough power to alter device parameters or melt silicon junctions.



IMPORTANT: To prevent damage to the device when you remove or install internal components, observe these precautions:

- Keep components in their electrostatic-safe containers until you are ready to install them.
 - Before touching an electronic component, discharge static electricity by using the guidelines described in [Personal grounding methods and equipment on page 55](#).
 - Avoid touching pins, leads, and circuitry. Handle electronic components as little as possible.
 - If you remove a component, place it in an electrostatic-safe container.
-

Generating static electricity

Follow these static electricity guidelines:

- Different activities generate different amounts of static electricity.
- Static electricity increases as humidity decreases.

Table 6-1 Static electricity occurrence based on activity and humidity

Event	Relative humidity		
	55%	40%	10%
Walking across carpet	7,500 V	15,000 V	35,000 V
Walking across vinyl floor	3,000 V	5,000 V	12,000 V
Motions of bench worker	400 V	800 V	6,000 V
Removing dual in-line packages (DIPs) from plastic tube	400 V	700 V	2,000 V
Removing DIPs from vinyl tray	2,000 V	4,000 V	11,500 V
Removing DIPs from polystyrene foam	3,500 V	5,000 V	14,500 V
Removing bubble pack from PCB (printed circuit board)	7,000 V	20,000 V	26,500 V
Packing PCBs in foam-lined box	5,000 V	11,000 V	21,000 V

 **NOTE:** Multiple electric components can be packaged together in plastic tubes, trays, or polystyrene foam.

As little as 700 V of static electricity can degrade a product.

Preventing electrostatic damage to equipment

Many electronic components are sensitive to ESD. Circuitry design and structure determine the degree of sensitivity.

The following packaging and grounding precautions are necessary to prevent static electricity damage to electronic components:

- To avoid hand contact, transport products in static-safe containers such as tubes, bags, or boxes.
- Protect all electrostatic parts and assemblies with conductive or approved containers or packaging.
- Keep electrostatic-sensitive parts in their containers until they arrive at static-free stations.
- Place items on a grounded surface before removing them from their container.
- Always be properly grounded when touching a sensitive component or assembly.
- Avoid contact with pins, leads, or circuitry.
- Place reusable electrostatic-sensitive parts from assemblies in protective packaging or conductive foam.

Personal grounding methods and equipment

Using certain equipment can prevent static electricity damage to electronic components.

- **Wrist straps** are flexible straps with a maximum of $1\text{ M}\Omega \pm 10\%$ resistance in the ground cords. To provide proper ground, a strap must be worn snug against bare skin. The ground cord must be connected and fit snugly into the banana plug connector on the grounding mat or workstation.

- You can use **heel straps, toe straps, and boot straps** at standing workstations. These straps are compatible with most types of shoes or boots. On conductive floors or dissipative floor mats, use them on both feet with a maximum of $1\text{ M}\Omega \pm 10\%$ resistance between the operator and ground.

Table 6-2 Static shielding protection levels

Static shielding protection levels	
Method	Voltage
Antistatic plastic	1,500
Carbon-loaded plastic	7,500
Metallized laminate	15,000

Grounding the work area

To prevent static damage at the work area, follow these precautions:

- Cover the work surface with approved static-dissipative material.
- Use a wrist strap connected to a properly grounded work surface and use properly grounded tools and equipment.
- Use static-dissipative mats, foot straps, or air ionizers to give added protection.
- Handle electrostatic sensitive components, parts, and assemblies by the case or PCB laminate. Handle them only at static-free work areas.
- Turn off power and input signals before inserting and removing connectors or test equipment.
- Use fixtures made of static-safe materials when fixtures must directly contact dissipative surfaces.
- Keep the work area free of nonconductive materials, such as ordinary plastic assembly aids and polystyrene foam.
- Use conductive field service tools, such as cutters, screwdrivers, and vacuums.
- Avoid contact with pins, leads, or circuitry.

Recommended materials and equipment

HP recommends certain materials and equipment to prevent static electricity:

- Antistatic tape
- Antistatic smocks, aprons, or sleeve protectors
- Conductive bins and other assembly or soldering aids
- Conductive foam
- Conductive tabletop workstations with ground cord of $1\text{ M}\Omega \pm 10\%$ resistance
- Static-dissipative table or floor mats with hard tie to ground
- Field service kits
- Static awareness labels

- Wrist straps and footwear straps providing 1 M Ω \pm 10% resistance
- Material handling packages
- Conductive plastic bags
- Conductive plastic tubes
- Conductive tote boxes
- Opaque shielding bags
- Transparent metallized shielding bags
- Transparent shielding tubes

Cleaning your computer

Cleaning your computer regularly removes dirt and debris so that your device continues to operate at its best. Use the following information to safely clean the external surfaces of your computer.

Enabling HP Easy Clean (select products only)

HP Easy Clean helps you to avoid accidental input while you clean the computer surfaces. This software disables devices such as the keyboard, touch screen, and touchpad for a preset amount of time so that you can clean all computer surfaces.

1. Start HP Easy Clean in one of the following ways:
 - Select the **Start** menu, and then select **HP Easy Clean**.
 - Select the **HP Easy Clean** icon in the taskbar.
 - Select **Start**, and then select the **HP Easy Clean** tile.
2. Now that your device is disabled for a short period, see [Removing dirt and debris from your computer on page 57](#) for the recommended steps to clean the high-touch, external surfaces on your computer. After you remove the dirt and debris, you can also clean the surfaces with a disinfectant. See [Cleaning your computer with a disinfectant on page 58](#) for guidelines to help prevent the spread of harmful bacteria and viruses.

Removing dirt and debris from your computer

Here are the recommended steps to clean dirt and debris from your computer.

For computers with wood veneer, see [Caring for wood veneer \(select products only\) on page 59](#).

1. Wear disposable gloves made of latex (or nitrile gloves, if you are latex-sensitive) when cleaning the surfaces.
2. Turn off your device and unplug the power cord and other connected external devices. Remove any installed batteries from items such as wireless keyboards.

⚠ CAUTION: To prevent electric shock or damage to components, never clean a product while it is turned on or plugged in.

3. Moisten a microfiber cloth with water. The cloth should be moist, but not dripping wet.

 **IMPORTANT:** To avoid damaging the surface, avoid abrasive cloths, towels, and paper towels.

4. Wipe the exterior of the product gently with the moistened cloth.

 **IMPORTANT:** Keep liquids away from the product. Avoid getting moisture in any openings. If liquid makes its way inside your HP product, it can cause damage to the product. Do not spray liquids directly on the product. Do not use aerosol sprays, solvents, abrasives, or cleaners containing hydrogen peroxide or bleach that might damage the finish.

5. Start with the display (if applicable). Wipe carefully in one direction, and move from the top of the display to the bottom. Finish with any flexible cables, like power cord, keyboard cable, and USB cables.
6. Be sure that surfaces have completely air-dried before turning the device on after cleaning.
7. Discard the gloves after each cleaning. Clean your hands immediately after you remove the gloves.

See [Cleaning your computer with a disinfectant on page 58](#) for recommended steps to clean the high-touch, external surfaces on your computer to help prevent the spread of harmful bacteria and viruses.

Cleaning your computer with a disinfectant

The World Health Organization (WHO) recommends cleaning surfaces, followed by disinfection, as a best practice for preventing the spread of viral respiratory illnesses and harmful bacteria.

After cleaning the external surfaces of your computer using the steps in [Removing dirt and debris from your computer on page 57](#), [Caring for wood veneer \(select products only\) on page 59](#), or both, you might also choose to clean the surfaces with a disinfectant. A disinfectant that is within HP's cleaning guidelines is an alcohol solution consisting of 70% isopropyl alcohol and 30% water. This solution is also known as rubbing alcohol and is sold in most stores.

Follow these steps when disinfecting high-touch, external surfaces on your computer:

1. Wear disposable gloves made of latex (or nitrile gloves, if you are latex-sensitive) when cleaning the surfaces.
2. Turn off your device and unplug the power cord and other connected external devices. Remove any installed batteries from items such as wireless keyboards.

 **CAUTION:** To prevent electric shock or damage to components, never clean a product while it is turned on or plugged in.

3. Moisten a microfiber cloth with a mixture of 70% isopropyl alcohol and 30% water. The cloth should be moist, but not dripping wet.

 **CAUTION:** Do not use any of the following chemicals or any solutions that contain them, including spray-based surface cleaners: bleach, peroxides (including hydrogen peroxide), acetone, ammonia, ethyl alcohol, methylene chloride, or any petroleum-based materials, such as gasoline, paint thinner, benzene, or toluene.

 **IMPORTANT:** To avoid damaging the surface, avoid abrasive cloths, towels, and paper towels.

4. Wipe the exterior of the product gently with the moistened cloth.

 **IMPORTANT:** Keep liquids away from the product. Avoid getting moisture in any openings. If liquid makes its way inside your HP product, it can cause damage to the product. Do not spray liquids directly on the product. Do not use aerosol sprays, solvents, abrasives, or cleaners containing hydrogen peroxide or bleach that might damage the finish.

5. Start with the display (if applicable). Wipe carefully in one direction, and move from the top of the display to the bottom. Finish with any flexible cables, like power cord, keyboard cable, and USB cables.
6. Be sure that surfaces have completely air-dried before turning the device on after cleaning.
7. Discard the gloves after each cleaning. Clean your hands immediately after you remove the gloves.

Caring for wood veneer (select products only)

Your product might feature high-quality wood veneer. As with all natural wood products, proper care is important for best results over the life of the product. Because of the nature of natural wood, you might see unique variations in the grain pattern or subtle variations in color, which are normal.

- Clean the wood with a dry, static-free microfiber cloth or chamois.
- Avoid cleaning products containing substances such as ammonia, methylene chloride, acetone, turpentine, or other petroleum-based solvents.
- Do not expose the wood to sun or moisture for long periods of time.
- If the wood becomes wet, dry it by dabbing with an absorbent, lint-free cloth.
- Avoid contact with any substance that might dye or discolor the wood.
- Avoid contact with sharp objects or rough surfaces that might scratch the wood.

See [Removing dirt and debris from your computer on page 57](#) for the recommended steps to clean the high-touch, external surfaces on your computer. After you remove the dirt and debris, you can also clean the surfaces with a disinfectant. See [Cleaning your computer with a disinfectant on page 58](#) for sanitizing guidelines to help prevent the spread of harmful bacteria and viruses.

Packaging and transporting guidelines

Follow these grounding guidelines when packaging and transporting equipment:

- To avoid hand contact, transport products in static-safe tubes, bags, or boxes.
- Protect ESD-sensitive parts and assemblies with conductive or approved containers or packaging.
- Keep ESD-sensitive parts in their containers until the parts arrive at static-free workstations.
- Place items on a grounded surface before removing items from their containers.
- Always be properly grounded when touching a component or assembly.
- Store reusable ESD-sensitive parts from assemblies in protective packaging or nonconductive foam.

- Use transporters and conveyors made of antistatic belts and roller bushings. Be sure that mechanized equipment used for moving materials is wired to ground and that proper materials are selected to avoid static charging. When grounding is not possible, use an ionizer to dissipate electric charges.

Accessing support information

To find the HP support that you need, use this information.

Table 6-3 Support information locations



Service consideration	Path to access information
Records of reported failure incidents stored on the computer	<p>Windows®:</p> <p>Preoperating system failures are logged in the BIOS Event Log. To view the BIOS Event Log:</p> <ol style="list-style-type: none"> 1. Press the power button. 2. Immediately and repeatedly press esc when the power button light turns white. <p>NOTE: If you do not press esc at the appropriate time, you must restart the computer and again repeatedly press esc when the power button light turns white to access the utility.</p> <ol style="list-style-type: none"> 3. Press f10 to enter the BIOS setup. 4. (On commercial products) Under the Main tab, select BIOS event log, and then select View BIOS Event Log. <p>- or -</p> <p>(On consumer products) Under the Main tab, select System Log.</p> <p>Post-operating system failures are logged in the Event Viewer.</p> <ol style="list-style-type: none"> 1. Turn on the computer and allow the operating system to open. 2. Select the search icon  in the taskbar. 3. Type <code>Event Viewer</code>, and then press enter. 4. Select the log from the left panel. Details display in the right panel. <p>Chrome™:</p> <ol style="list-style-type: none"> 1. Go to support.google.com/chrome. 2. Search <code>collect Chrome device logs</code>.
Technical bulletins	<p>To locate technical bulletins:</p> <ol style="list-style-type: none"> 1. Go to www.hp.com. 2. Place the cursor over Problem solving to display more options. 3. Select Support & Troubleshooting. 4. Type the serial number, product number, or product name to go to the product support page. 5. Select Advisories to view technical bulletins.

Table 6-3 Support information locations (continued)

Service consideration	Path to access information
Repair professionals	To locate repair professionals: <ol style="list-style-type: none">1. Go to www.hp.com.2. Place the cursor over Support resources to display more options.3. Select Authorized service providers.
Component and diagnosis information, failure detection, and required action	To locate diagnosis information and actions: <ol style="list-style-type: none">1. Go to http://www.hp.com/go/techcenter/pcdiags.2. Select Get Support.3. Near the bottom of the window, select Notebook PCs, and then select your location.

7 Removal and replacement procedures for Customer Self-Repair parts

This chapter provides removal and replacement procedures for Customer Self-Repair parts.

 **NOTE:** The Customer Self-Repair program is not available in all locations. Installing a part that is not supported by the Customer Self-Repair program can void your warranty. Check your warranty to determine whether Customer Self-Repair is supported in your location.

Component replacement procedures

To remove and replace computer components, use these procedures.

 **NOTE:** Details about your computer, including model, serial number, product key, and length of warranty, are on the service tag at the bottom of your computer.

 **NOTE:** HP continually improves and changes product parts. For complete and current information about supported parts for your computer, go to <https://partsurfer.hp.com/partsurfer/>, select your country or region, and then follow the on-screen instructions.

Make special note of each screw size and location during removal and replacement.

Preparation for disassembly

To remove and replace computer components, use these procedures:

For initial safety procedures, see [Removal and replacement procedures preliminary requirements on page 53](#).

1. Turn off the computer. If you are unsure whether the computer is off or in Hibernation, turn the computer on, and then shut it down through the operating system.
2. Disconnect the power from the computer by unplugging the power cord from the computer.
3. Disconnect all external devices from the computer.

Bottom cover

To remove the bottom cover, use this procedure and illustration.

Table 7-1 Bottom cover descriptions and part numbers

Description	Spare part number
Bottom cover, plastic	N96446-001
Bottom cover, metal	N96448-001

NOTE: Metal bottom covers are available on models with 64 GB of system memory.



NOTE: Depending on configure, the bottom cover might be metal or plastic.

Before removing the bottom cover, prepare the computer for disassembly (see [Preparation for disassembly on page 62](#)).

Remove the bottom cover:

1. Loosen the five captive Phillips screws that secure the bottom cover to the computer.

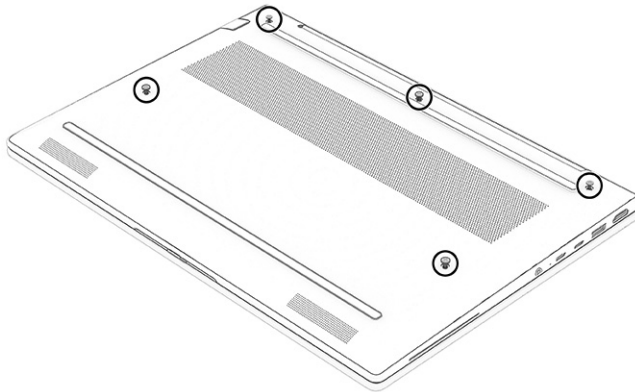

2. Starting near the hinges, use a nonmarking, nonconductive tool **(1)** to release the edges of the bottom cover from the computer.
3. Remove the bottom cover from the computer **(2)**.

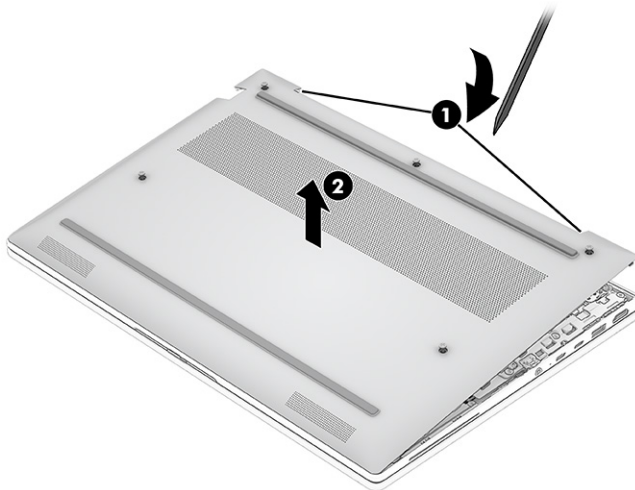

To replace the bottom cover, reverse the removal procedures.

Using a SIM card (select products only)

Use these instructions to insert a SIM card.



IMPORTANT: You can damage the SIM card if you insert the wrong size card or insert it or the SIM card tray in the wrong direction. The card might also become stuck in the slot. Do not use SIM card

adapters. To prevent damage to the SIM card or connectors, use minimal force when inserting or removing a SIM card.

Determining the correct SIM card size for your computer

Before purchasing a SIM card, follow these instructions to determine the correct SIM card size for your computer.

1. Go to <http://www.hp.com/support>, and then search for your computer by product name or number.
2. Select **Product Information**.
3. Refer to the listed options to determine which card to purchase.

Inserting a SIM card in an external slot

To insert a SIM card in an external slot, follow these steps.

1. Turn off the computer by using the Shut down command.
2. Insert the SIM card into the SIM card slot, and then press in on the SIM card until it is firmly seated.

 **NOTE:** Your SIM card or the SIM card slot in your computer might look different from the illustration in this section.

 **NOTE:** Your SIM card slot may have an icon to show which way the card should be inserted into the computer.

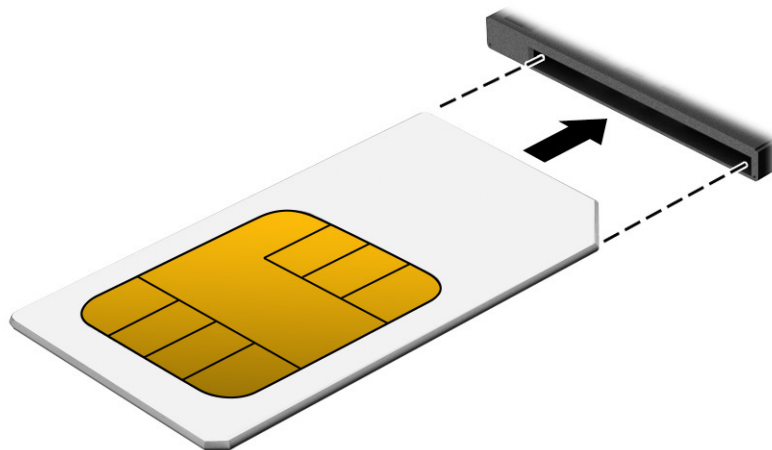

To remove the SIM card, press in gently on the card to disengage the SIM lock, and then remove it from the slot.

Memory modules

To remove the memory modules, use this procedure and illustration.

Table 7-2 Memory module descriptions and part numbers

Description	Spare part number
32 GB	N50075-001

Table 7-2 Memory module descriptions and part numbers (continued)

Description	Spare part number
32 GB, NMIC	N97399-001
32 GB, for use in the PRC	N77400-001
16 GB	N38627-001
16 GB, NMIC	N93773-001
16 GB, for use in the PRC	N77399-001
8 GB	N37792-001
8 GB, for use in the PRC	N77398-001

Before removing the memory, follow these steps:

1. Prepare the computer for disassembly (see [Preparation for disassembly on page 62](#)).
2. Remove the bottom cover (see [Bottom cover on page 62](#)).
3. Disconnect the battery cable from the system board (see [Battery on page 74](#)).
1. Lift the cover off the memory modules.

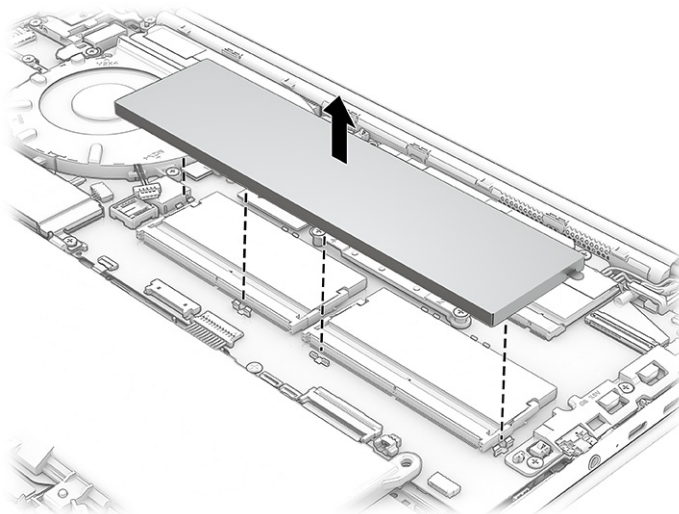

2. Spread the two retention clips outward **(1)** until the memory module tilts up at a 45° angle, and then remove the module **(2)**. Use the same procedure to remove all memory modules.

To prevent damage to the memory module, hold the memory module by the edges only. Do not touch the components on the memory module.

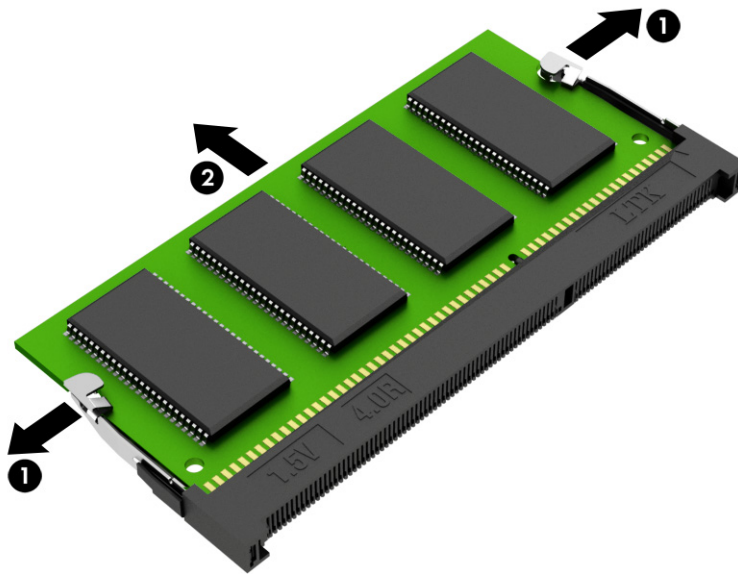

To install a memory module, reverse the removal procedures.

WLAN module

To remove the WLAN module, use this procedure and illustration.

Table 7-3 WLAN module descriptions and part numbers

Description	Spare part number
MediaTek RZ616 Wi-Fi 6E Bluetooth 5.3 AIM-T WLAN	N22541-005
Realtek 8852CE Wi-Fi 6E Bluetooth 5.3 WLAN	N19618-005

IMPORTANT: To prevent an unresponsive system, replace the wireless module only with a wireless module authorized for use in the computer by the governmental agency that regulates wireless devices in your country or region. If you replace the module and then receive a warning message, remove the module to restore device functionality, and then contact technical support.

Before removing the WLAN module, follow these steps:

1. Prepare the computer for disassembly (see [Preparation for disassembly on page 62](#)).
2. Remove the bottom cover (see [Bottom cover on page 62](#)).
3. Disconnect the battery cable from the system board (see [Battery on page 74](#)).

Remove the WLAN module:

1. Remove the plastic protector **(1)** that covers the antennas.
2. Carefully disconnect the antenna cables **(2)** from the module.

- Remove the Phillips M2.0 × 3.0 screw (3), and then pull the WLAN module (4) out of the socket.

 **NOTE:** The #1 white WLAN antenna cable connects to the WLAN module #1 Main terminal. The #2 black WLAN antenna cable connects to the WLAN module #1 Aux terminal.

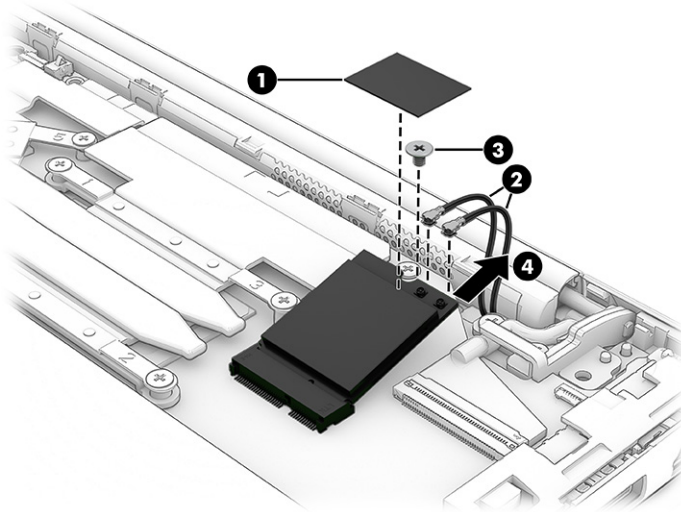

- If the WLAN antenna is not connected to the terminal on the WLAN module, install a protective sleeve on the antenna connector, as shown in the following illustration.

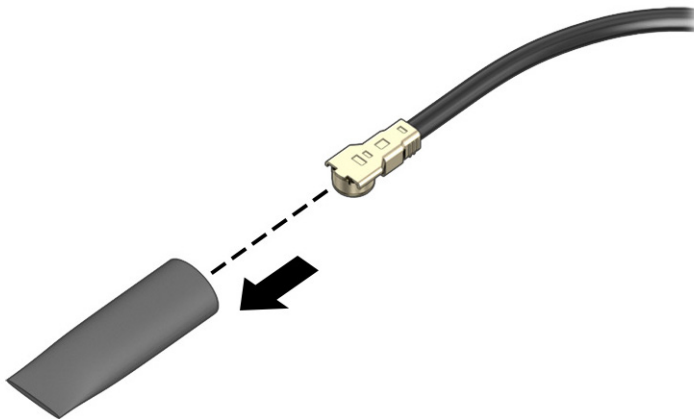

To install the WLAN module, reverse this procedure.

WWAN module

To remove the WWAN module, use this procedure and illustration.

Table 7-4 WWAN module description and part number

Description	Spare part number
HP 4000 4G LTE-Advanced Pro	N65633-005

 **IMPORTANT:** To prevent an unresponsive system, replace the wireless module only with a wireless module authorized for use in the computer by the governmental agency that regulates wireless

devices in your country or region. If you replace the module and then receive a warning message, remove the module to restore device functionality, and then contact technical support.

Before removing the WWAN module, follow these steps:

1. Prepare the computer for disassembly (see [Preparation for disassembly on page 62](#)).
2. Remove the bottom cover (see [Bottom cover on page 62](#)).
3. Disconnect the battery cable from the system board (see [Battery on page 74](#)).

Remove the WWAN module:

1. Remove the plastic protector **(1)** that covers the antennas.
2. Disconnect the antenna cables **(2)** from the terminals on the module. The number of antenna cables can vary.
3. Remove the Phillips M2.0 × 3.0 screw **(3)** that secures the module to the bottom cover. The WWAN module tilts up.
4. Remove the module **(4)** by pulling the module away from the slot at an angle.

 **NOTE:** Antenna cable colors might vary. Be sure to match the number on the cable with the number next to the connector on the module.

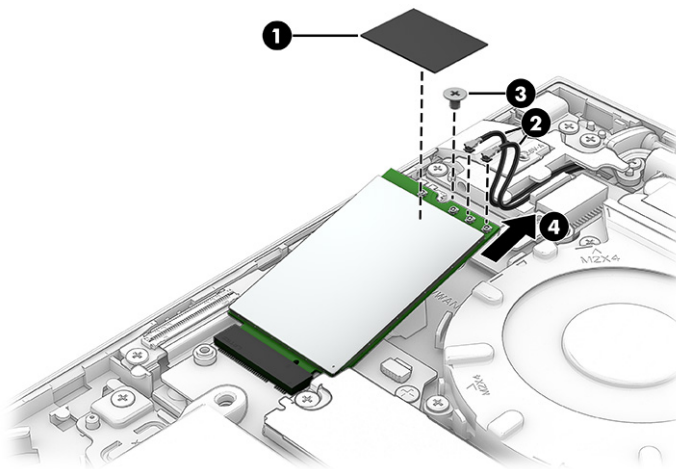

- If the WWAN antenna is not connected to the terminal on the WWAN module, a protective sleeve must be installed on the antenna connector, as shown in the following illustration.

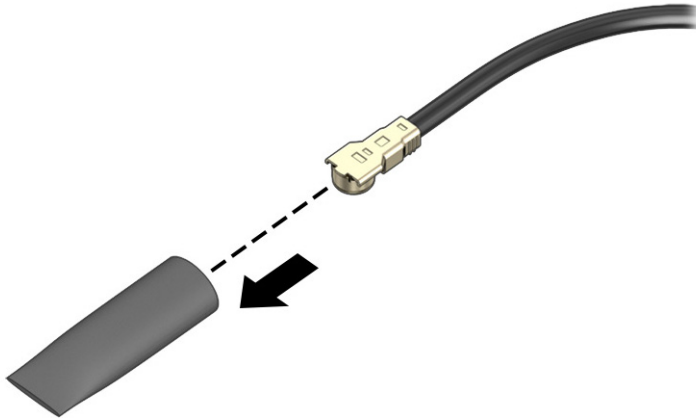

To install the WWAN module, reverse this procedure.

When installing a WWAN module, use the following illustration to determine the proper screw location for the module.

(1): Long WWAN module

(2): Short WWAN module

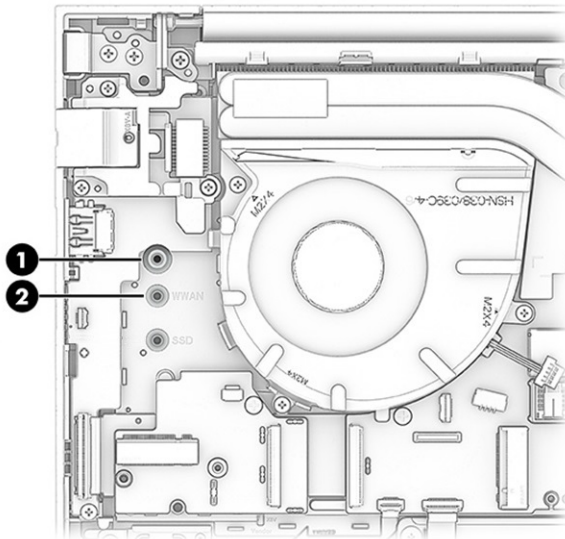

Solid-state drive

To remove the solid-state drive (SSD), use this procedure and illustration.

Table 7-5 Solid-state drive descriptions and part numbers

Description	Spare part number
2 TB, TLC	M52027-001
2 TB, TLC, for use in the People's Republic of China (PRC)	N77396-001

Table 7-5 Solid-state drive descriptions and part numbers (continued)

Description	Spare part number
1 TB, TLC	M16560-001
1 TB, TLC, for use in the PRC	N77395-001
1 TB, TLC, NMIC	N22908-001
1 TB, TLC, self-encrypting drive (SED)	N23415-001
1 TB, TLC, self-encrypting drive (SED), NMIC	N24954-001
512 GB	N45476-001
512 GB, TLC	M17436-001
512 GB, TLC, self-encrypting drive (SED)	M52031-001
512 GB, TLC, for use in the PRC	N77393-001
512 GB, for use in the PRC	N77392-001
256 GB	N45477-001
256 GB, self-encrypting drive (SED)	N35225-001
256 GB, for use in the PRC	N77391-001
Solid-state drive support kit	N96251-001

Before removing the SSD, follow these steps:

1. Prepare the computer for disassembly (see [Preparation for disassembly on page 62](#)).
2. Remove the bottom cover (see [Bottom cover on page 62](#)).
3. Disconnect the battery cable from the system board (see [Battery on page 74](#)).

Remove the M.2 2280 SSD:

1. Remove the Phillips M2.0 × 2.5 screw **(1)** from the drive assembly.
2. Remove the Phillips M2.0 × 4.0 screw **(2)** from the drive assembly.
3. Lift the end of the drive assembly **(3)** up, and then pull the assembly **(4)** away from the socket to remove it.

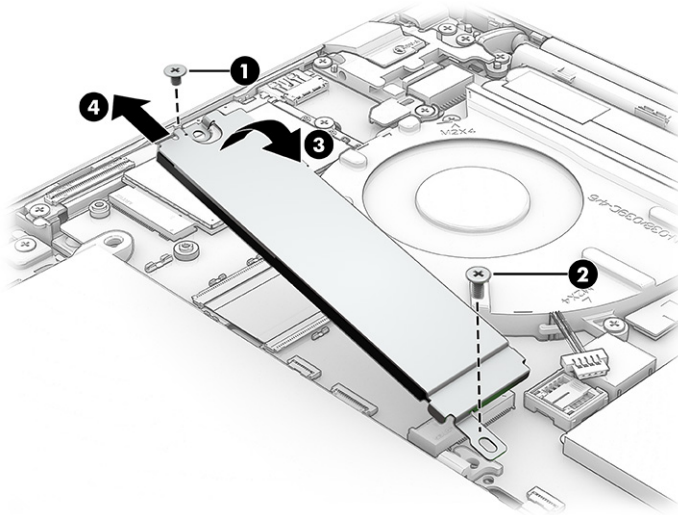

4. When installing an SSD, be sure a thermal pad is installed on the bottom of the drive bracket as shown in the following illustration.

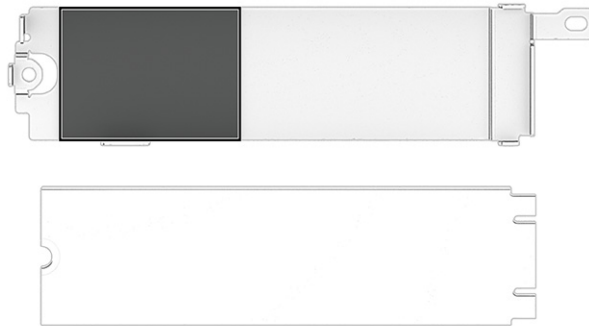

 **NOTE:** You do not need to remove the SSD screw hole bracket when replacing an SSD. However, if the bracket comes loose, use the following steps to completely remove and replace it.

5. Pull the bracket straight up and off the system board.

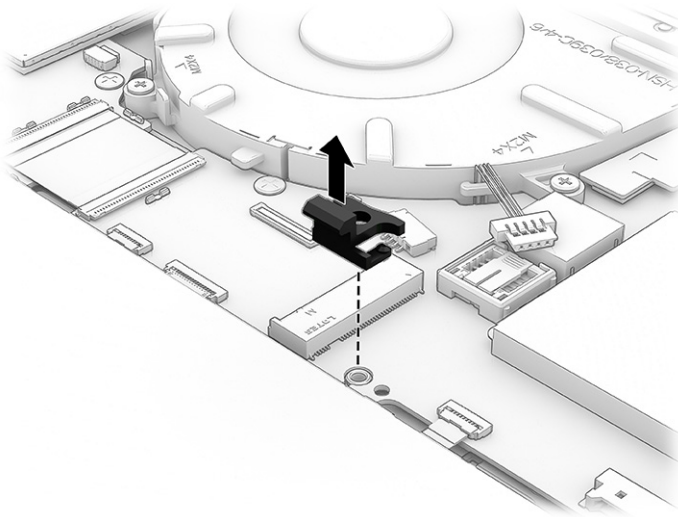

6. To install the SSD screw hole bracket, insert the bracket onto the system board at the orientation shown in the following illustration.

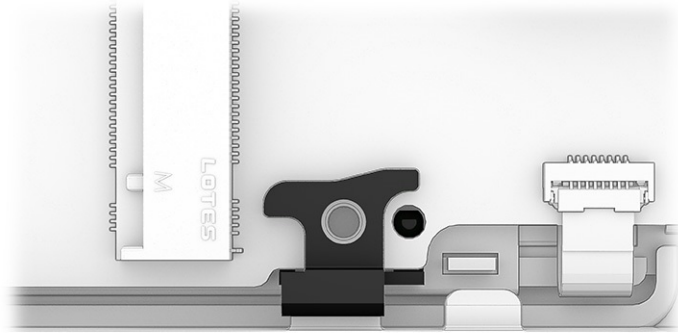

Remove the M.2 2280 SSD from models with a metal bottom cover:

1. Peel back the plastic SSD cover (1).
2. Remove the Phillips M2.0 × 3.0 screw (2) from the drive, and then pull the drive (3) out of the socket.

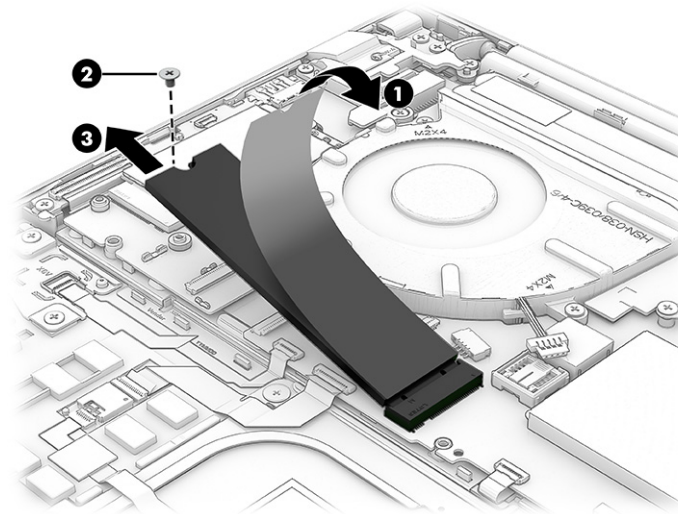

To install the solid-state drive, reverse the removal procedures.



NOTE: Solid-state drives are designed with a notch to prevent incorrect insertion.

8 Removal and replacement procedures for authorized service provider parts

This chapter provides removal and replacement procedures for authorized service provider parts.

 **IMPORTANT:** Only an authorized service provider should access the components described in this chapter. Accessing these parts can damage the computer or void the warranty.

 **NOTE:** Details about your computer, including model, serial number, product key, and length of warranty, are on the service tag at the bottom of your computer.

Component replacement procedures

To remove and replace computer components, use these procedures.

 **NOTE:** HP continually improves and changes product parts. For complete and current information about supported parts for your computer, go to <http://partsurfer.hp.com>, select your country or region, and then follow the on-screen instructions.

You must remove, replace, or loosen as many as 53 screws when you service the parts described in this chapter. Make special note of each screw size and location during removal and replacement.

Preparation for disassembly

To remove and replace computer components, use these procedures:

For initial safety procedures, see [Removal and replacement procedures preliminary requirements on page 53](#).

1. Turn off the computer. If you are unsure whether the computer is off or in Hibernation, turn the computer on, and then shut it down through the operating system.
2. Disconnect the power from the computer by unplugging the power cord from the computer.
3. Disconnect all external devices from the computer.

Battery

To remove the battery, use this procedure and illustration.

Table 8-1 Battery descriptions and part numbers

Description	Spare part number
3 cell, 56 Whr	N70706-005
Battery latches (included in the Plastics Kit)	N96234-001

 **WARNING!** To avoid personal injury and damage to the product:

- Do *not* puncture, twist, or crack the battery.
- Do *not* cause an external puncture or rupture to the battery. They can cause a short inside the battery, which can result in battery thermal runaway.
- Do *not* handle or touch the battery enclosure with sharp objects such as tweezers or pliers, which might puncture the battery.
- Do *not* compress or squeeze the battery case with tools or heavy objects stacked on top of the case. These actions can apply undue force on the battery.
- Do *not* touch the connectors with any metallic surface or object, such as metal tools, screws, or coins, which can cause shorting across the connectors.

Before removing the battery, follow these steps:

1. Prepare the computer for disassembly (see [Preparation for disassembly on page 62](#)).
2. Remove the bottom cover (see [Bottom cover on page 62](#)).

⚠ WARNING! To reduce potential safety issues, use only the user-replaceable battery provided with the computer, a replacement battery provided by HP, or a compatible battery purchased from HP.

📌 IMPORTANT: Removing a battery that is the sole power source for the computer can cause loss of information. To prevent loss of information, save your work or shut down the computer through Windows before you remove the battery.

Remove the battery:

1. Disconnect the battery cable (1) from the system board.
2. Open the two latches (2) that secure the battery to the computer.
3. Use the tabs (3) to remove the battery from the computer.

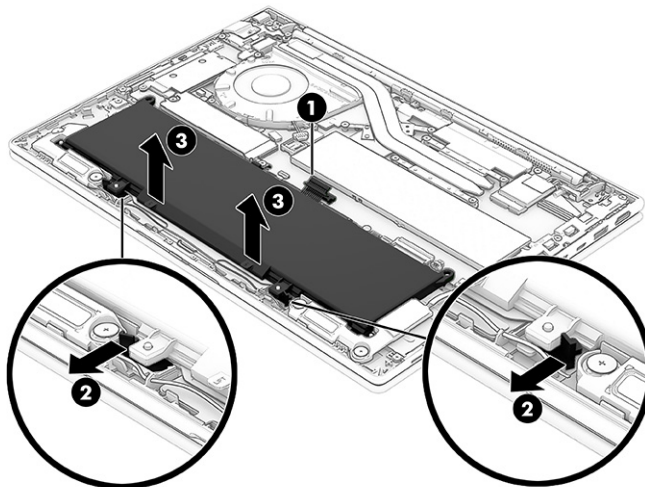

4. To remove the battery latches, rotate the latches **(1)**, and then use a tool to release the latches **(2)** from the computer.

 **NOTE:** It is not necessary to remove the battery latches during normal battery replacement. Only replace the latches if they are missing or broken.

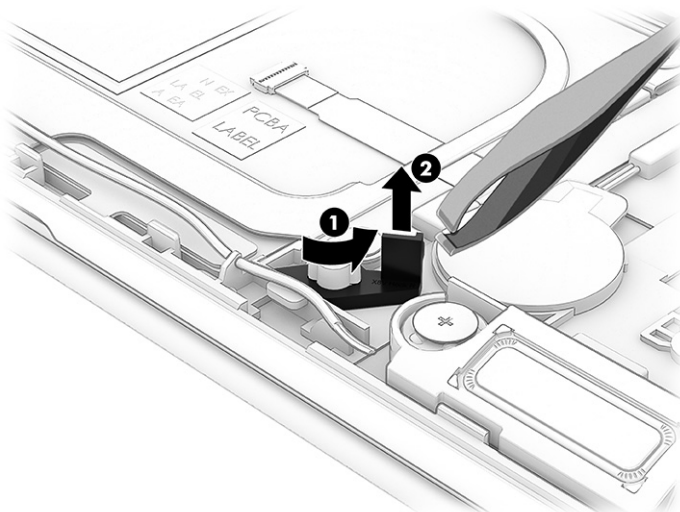

To install the battery, reverse the removal procedures.

 **NOTE:** When replacing the battery, be sure to align the battery on the pins and then lock the latches.

Speakers

To remove the speakers, use this procedure and illustration.

Table 8-2 Speakers description and part number

Description	Spare part number
Speakers	N96451-001

Before removing the speakers, follow these steps:

1. Prepare the computer for disassembly (see [Preparation for disassembly on page 62](#)).
2. Remove the bottom cover (see [Bottom cover on page 62](#)).
3. Disconnect the battery cable from the system board (see [Battery on page 74](#)).

Remove the speakers:

1. Disconnect the speaker cable from the system board connector **(1)**.
2. Remove the four Phillips M2.0 × 2.0 screws **(2)** that secure the speaker to the computer.
3. Remove the cable from the clips and tape **(3)** between the speakers.

4. Remove the speakers (4).

 **NOTE:** When removing the speakers, make note of the location of the rubber isolators (5) in the screw holes. The absence of or damage to these isolators can result in degraded speaker performance.

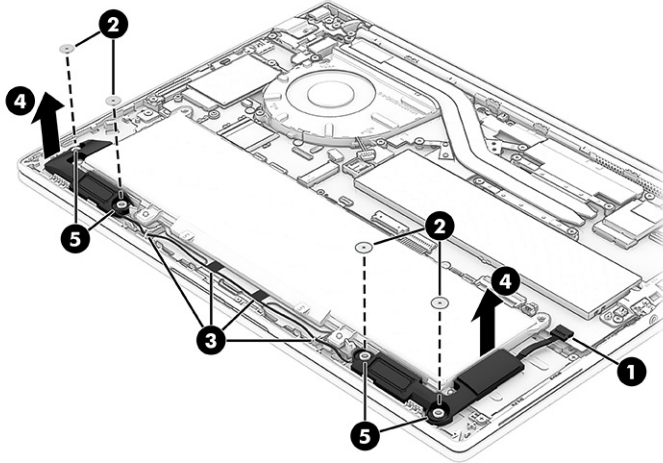

To install the speakers, reverse this procedure.

Fingerprint reader board

To remove the fingerprint reader board, use this procedure and illustration.

Table 8-3 Fingerprint reader board descriptions and part numbers

Description	Spare part number
Fingerprint reader board	N96242-001
Fingerprint reader board cable (included in the Cable Kit)	N98721-001
Fingerprint reader insert (included in the Plastics Kit)	N96234-001
Fingerprint reader bracket	N96233-001

Before removing the fingerprint reader board, follow these steps:

1. Prepare the computer for disassembly (see [Preparation for disassembly on page 62](#)).
2. Remove the bottom cover (see [Bottom cover on page 62](#)).
3. Remove the battery (see [Battery on page 74](#)).
4. Remove the right speaker (see [Speakers on page 76](#)).

Remove the fingerprint reader board:

1. Disconnect the cable from the ZIF connector (1) on the fingerprint reader .
2. Remove the two Phillips M2.0 × 2.5 screws (2) that secure the fingerprint reader bracket to the computer, and then remove the bracket (3).

3. Remove the fingerprint reader board **(4)** from the computer.

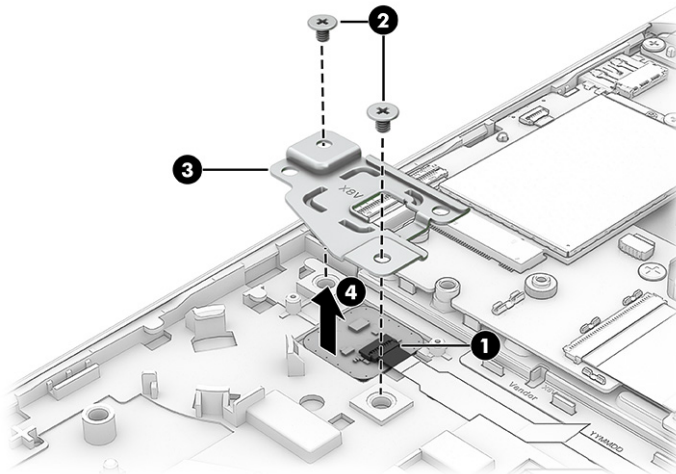

To install the fingerprint reader board, reverse this procedure.

Fan

To remove the fan, use this procedure and illustration.

Table 8-4 Fan description and part number

Description	Spare part number
Fan	N96441-001

Before removing the fan, follow these steps:

1. Prepare the computer for disassembly (see [Preparation for disassembly on page 62](#)).
2. Remove the bottom cover (see [Bottom cover on page 62](#)).
3. Disconnect the battery cable from the system board (see [Battery on page 74](#)).

Remove the fan assembly:

1. Disconnect the fan cable from the system board connector **(1)**.
2. Remove camera cable from the clip **(2)** on the fan.
3. Remove the three Phillips 2.0 × 4.0 screws **(3)** that secure the fan to the computer.

- Remove the fan **(4)** from the computer.

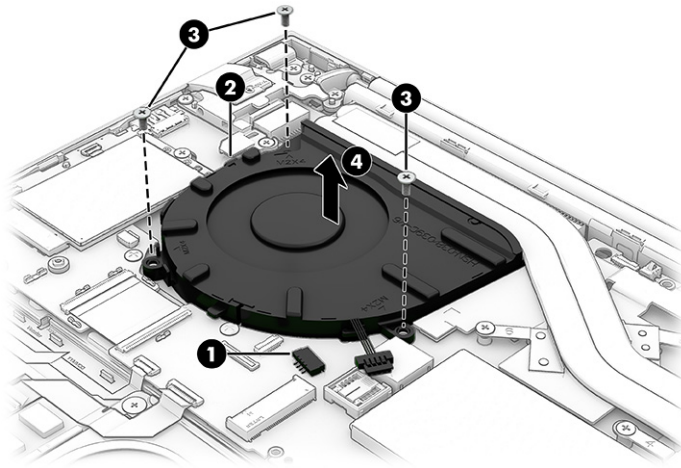

To install the fan, reverse this procedure.

I/O board

To remove the I/O board, use this procedure and illustration.

Table 8-5 I/O board descriptions and part numbers

Description	Spare part number
I/O board for use in models without a Ryzen PRO processor with only WLAN	N95961-001
I/O board for use in models without a Ryzen PRO processor with WLAN and WWAN	N95962-001
I/O board for use in models with a Ryzen PRO processor with only WLAN	P07357-001
I/O board for use in models with a Ryzen PRO processor with WLAN and WWAN	P07358-001
I/O board cables (included in Cable Kit)	N98721-001
RJ-45 (network) jack door, plastic	N96450-001
RJ-45 (network) jack door, metal	N96449-001

Before removing the I/O board, follow these steps:

- Prepare the computer for disassembly (see [Preparation for disassembly on page 62](#)).
- Remove the bottom cover (see [Bottom cover on page 62](#)).
- Remove the battery (see [Battery on page 74](#)).
- Remove the fan (see [Fan on page 78](#)).

Remove the I/O board:

- Disconnect the cables from the smaller ZIF connector **(1)** and larger ZIF connector **(2)** on the I/O board.
- Remove the four Phillips M2.0 × 4.0 screws **(3)** that secure the board to the computer, and then remove the network jack door **(4)** from the board.

3. Lift the front of the board (5) up, and then pull the board (6) into the computer to remove it.

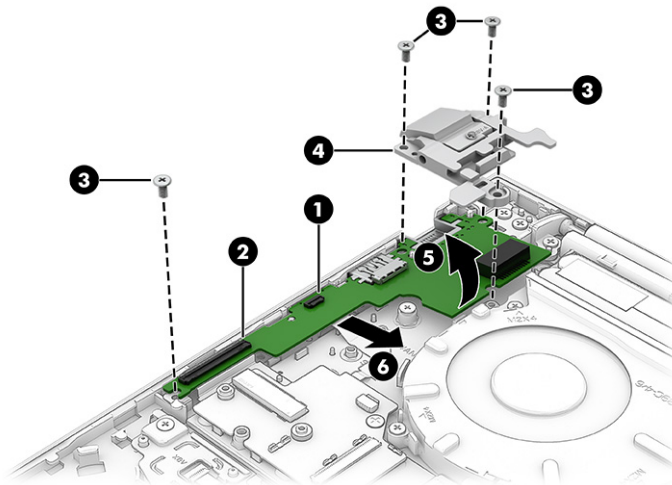

To install the I/O board, reverse this procedure.

NFC module

To remove the NFC module, use this procedure and illustration.

Table 8-6 NFC module descriptions and part numbers

Description	Spare part number
NFC module	914758-001
NOTE: The NFC module spare part kit does not include the antenna. The antenna is included in the touchpad spare part kit.	
NFC module cable (included in Cable Kit)	N98721-001
NFC antenna	N96725-001

Before removing the NFC module, follow these steps:

1. Prepare the computer for disassembly (see [Preparation for disassembly on page 62](#)).
2. Remove the bottom cover (see [Bottom cover on page 62](#)).
3. Remove the battery (see [Battery on page 74](#)).

Remove the NFC module:

1. Disconnect the system board cable from the ZIF connector (1) on the top of the NFC module.
2. Disconnect the touchpad antenna cable from the ZIF connector (2) on the bottom of the NFC module.

- Remove the NFC module (3) from the computer. The module is secured with adhesive.

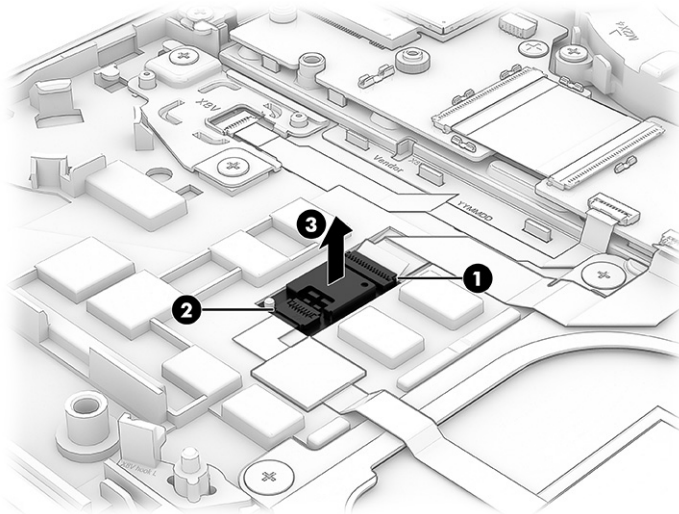

To install the NFC module, reverse this procedure.

When installing an NFC module, be sure to place the hole in the module onto the peg in the computer.

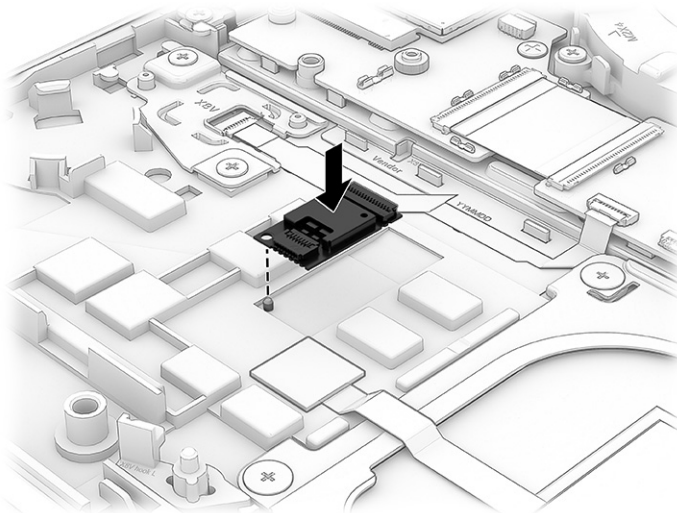

Smart card reader

To remove the smart card reader, use this procedure and illustration.

Table 8-7 Smart card reader descriptions and part numbers

Descriptions	Spare part numbers
Smart card reader	N96232-001
NOTE: The smart card reader spare part kit does not include the antenna. The antenna is included in the touchpad spare part kit.	
Smart card reader cable (included in Cable Kit)	N98721-001

Before removing the smart card reader, follow these steps:

1. Prepare the computer for disassembly (see [Preparation for disassembly on page 62](#)).
2. Remove the bottom cover (see [Bottom cover on page 62](#)).
3. Remove the battery (see [Battery on page 74](#)).
4. Remove the left speaker (see [Speakers on page 76](#)).

Remove the smart card reader:

1. Remove the four Phillips M2.0 × 2.5 screws **(1)** from the smart card reader bracket.
2. Remove the bracket **(2)**.

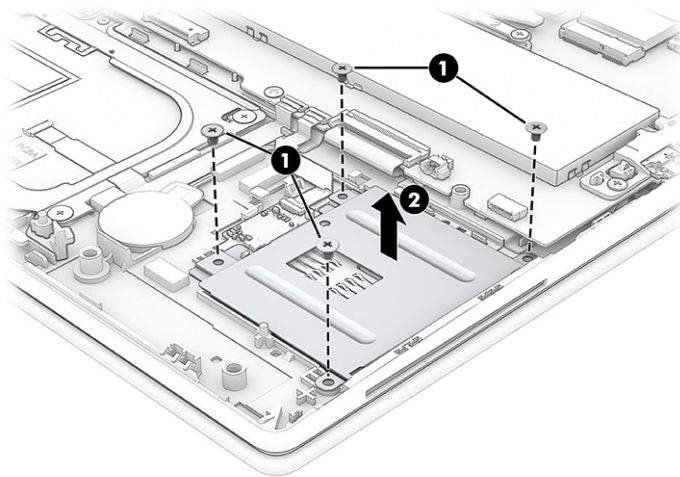

3. Lift the tape **(1)** off the connector on the smart card reader.
4. Disconnect the cable from the ZIF connector **(2)** on the smart card reader.
5. Remove the smart card reader **(3)** from the computer.

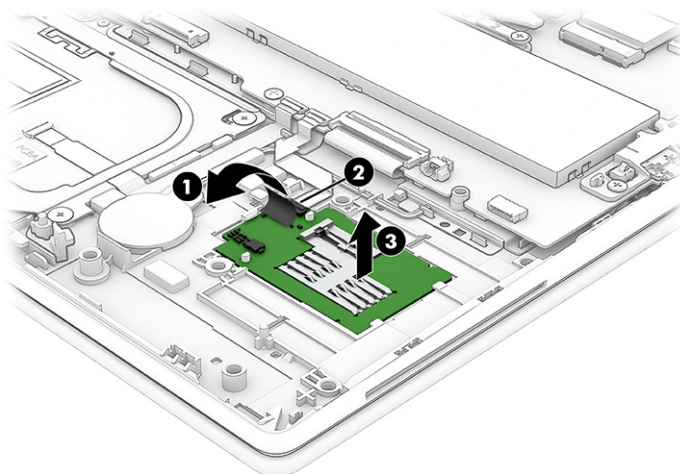

To install the smart card reader, reverse this procedure.

Touchpad

To remove the touchpad, use this procedure and illustration.

Table 8-8 Touchpad descriptions and part numbers

Description	Spare part number
Touchpad for use in models without NFC	N96237-001
Touchpad for use in models with NFC	N96237-001
Touchpad cable (included in Cable Kit)	N98721-001

Before removing the touchpad, follow these steps:

1. Prepare the computer for disassembly (see [Preparation for disassembly on page 62](#)).
2. Remove the bottom cover (see [Bottom cover on page 62](#)).
3. Remove the battery (see [Battery on page 74](#)).

Remove the touchpad:

1. Move the speaker cable **(1)** from the touchpad.



NOTE: If you have to remove tape from the cable, be careful to leave the cable intact.

2. Disconnect the system board cable from the ZIF connector **(2)** on the touchpad.
3. Disconnect the cable from the ZIF connector **(3)** on the NFC module.
4. Remove the four Phillips M2.0× 2.0 screws **(4)** that secure the touchpad to the computer.
5. Remove the three Phillips M1.6 × 2.0 screws **(5)** that secure the touchpad to the computer.
6. Remove the touchpad **(6)** from the computer.

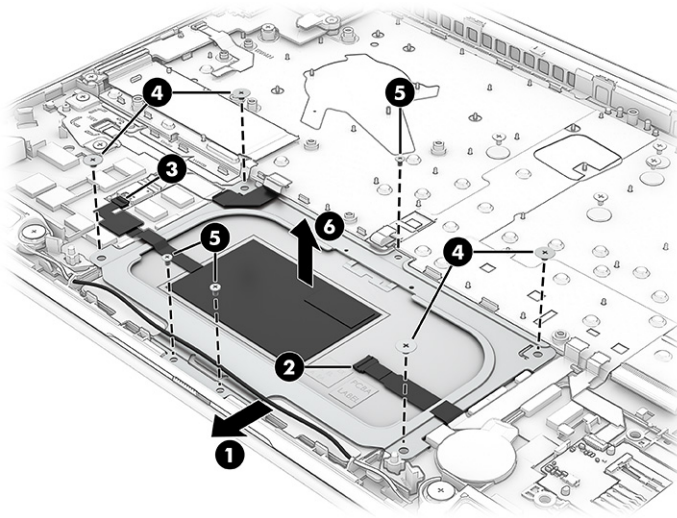

To install the touchpad, reverse this procedure.

Heat sink

To remove the heat sink, use these procedures and illustrations.

Table 8-9 Heat sink description and part number

Description	Spare part number
Heat sink	N96443-001

Before removing the heat sink, follow these steps:

1. Prepare the computer for disassembly (see [Preparation for disassembly on page 62](#)).
2. Remove the bottom cover (see [Bottom cover on page 62](#)).
3. Disconnect the battery cable from the system board (see [Battery on page 74](#)).

Remove the heat sink:

1. In the order indicated on the heat sink, loosen the four captive Phillips screws **(1)** that secure the heat sink to the computer.
2. Remove the heat sink **(2)** from the computer.

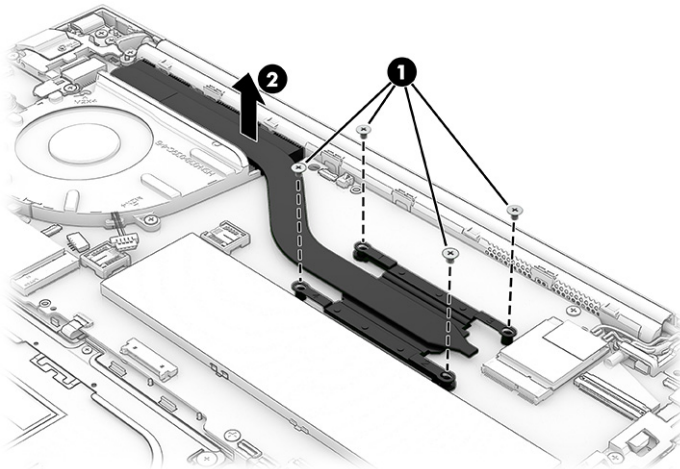

3. Be sure to install thermal material onto the heat sink in the location shown in the following illustration.

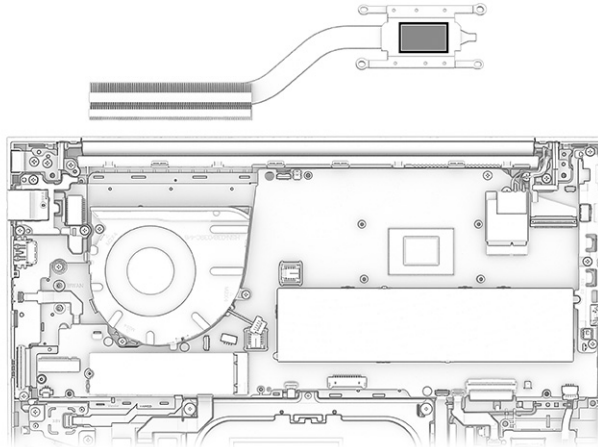

To install the heat sink, reverse this procedure.

System board

To remove the system board, use these procedures and illustrations.

Table 8-10 System board descriptions and part numbers

Description	Spare part number
System board (includes integrated processor)	
All system boards use the following part numbers:	
xxxxxx-001: Non-Windows operating systems	
xxxxxx-601: Windows operating system	
AMD Ryzen 7 7735U processor	N95973-xx1
AMD Ryzen 7 7735U processor and WWAN	N95972-xx1
AMD Ryzen 5 7535U processor	N95969-xx1
AMD Ryzen 5 7535U processor and WWAN	N95968-xx1
AMD Ryzen 3 7335U processor	N95967-xx1
AMD Ryzen 3 7335U processor and WWAN	N95966-xx1
AMD Ryzen 7 PRO 7735U processor and WWAN	N95974-xx1
AMD Ryzen 5 PRO 7535U processor	N95971-xx1
AMD Ryzen 5 PRO 7535U processor and WWAN	N95970-xx1
AMD Ryzen 3 PRO 7335U processor	N95965-xx1
AMD Ryzen 3 PRO 7335U processor and WWAN	N95964-xx1

Before removing the system board, follow these steps:

1. Prepare the computer for disassembly (see [Preparation for disassembly on page 62](#)).

2. Remove the bottom cover (see [Bottom cover on page 62](#)).
3. Remove the battery (see [Battery on page 74](#)).
4. Remove the fan (see [Fan on page 78](#)).



NOTE: You do not have to remove the heat sink to remove the system board.

When you replace the system board, be sure to remove the following components (as applicable) from the defective system board and install them on the replacement system board:

- Memory modules (see [Memory modules on page 64](#)).
- WLAN module (see [WLAN module on page 66](#)).
- WWAN module (see [WWAN module on page 67](#)).
- Solid-state drive (see [Solid-state drive on page 69](#)).
- Heat sink (see [Heat sink on page 84](#)).

Remove the system board:

1. Disconnect the following cables from the system board:



NOTE: You should not disconnect the RTC battery cable from the system board.

- Antenna cables from the WLAN module (select products only) **(1)**
- Display cable **(2)** (ZIF)
- Speaker cable **(3)**
- Keyboard cable (reverse ZIF) **(4)**
- Smart card reader cable (ZIF) **(5)**
- Touchpad cable (ZIF) **(6)**
- Keyboard backlight cable (ZIF) (select products only) **(7)**
- NFC module cable (ZIF) **(8)**
- Fingerprint reader cable (ZIF) (select products only) **(9)**
- I/O board cable (ZIF) from I/O board **(10)**

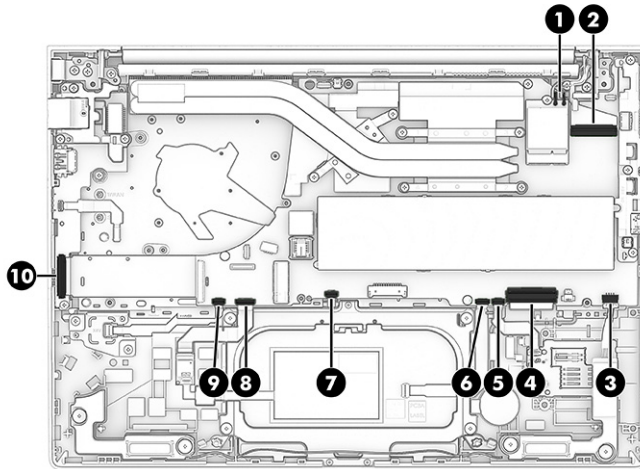

2. Remove the three Phillips M2.0 × 1.8 screws (1).
3. Remove the three Phillips M2.0 × 4.0 screws (2).
4. Remove the plastic I/O bracket (3) from the right edge of the board.

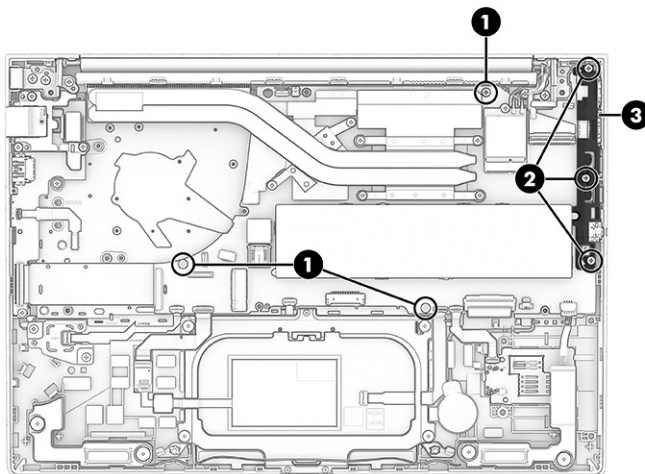

5. Lift the side of the system board **(1)** upward, and then pull the system board **(2)** away from the connectors on the side of the computer to remove it.

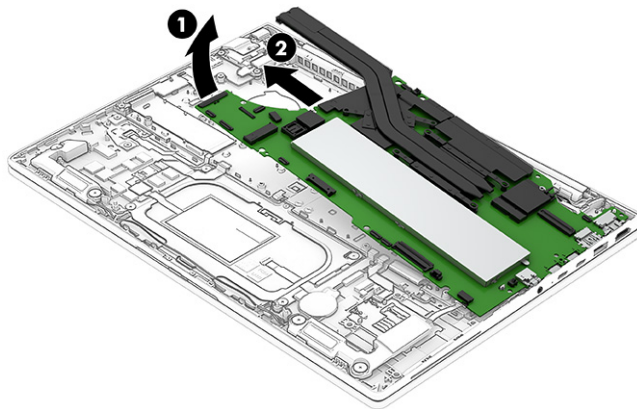

To install the system board, reverse this procedure.

Display assembly

To remove and disassemble the display assembly, use these procedures and illustrations.

Full hinge-up displays are not available as spare parts. Spare parts for displays are available only at the subcomponent level.

Before removing the display panel, follow these steps:

1. Prepare the computer for disassembly (see [Preparation for disassembly on page 62](#)).
2. Remove the bottom cover (see [Bottom cover on page 62](#)).
3. Disconnect the battery cable from the system board (see [Battery on page 74](#)).

Remove the display assembly:

1. (Select models only) Disconnect the antenna cables **(1)** from the WWAN module.
2. (Select models only) Disconnect the WWAN cable from the system board connector **(2)**.
3. (Select models only) Remove the WWAN cable and antenna cables from the routing channel **(3)** in the RJ-45 door bracket.
4. Disconnect the antenna cables **(4)** from the WLAN module.
5. Disconnect the display cable **(5)** from the system board ZIF connector.

6. Remove the display cable and WLAN antenna cables from the metal clip (6) at the bottom of the hinge.

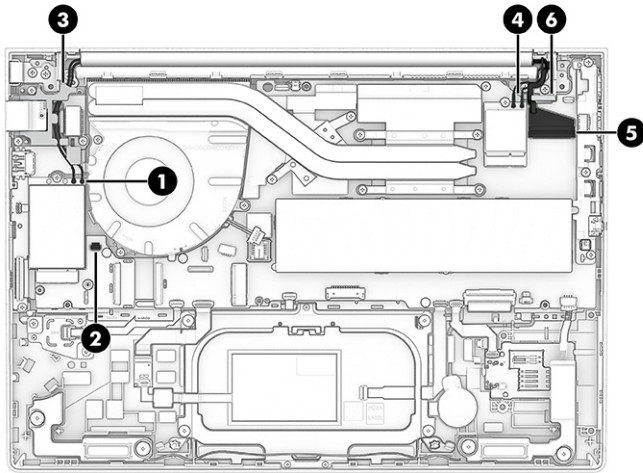

7. Remove the six Phillips M2.5 × 4.0 screws that secure the display assembly to the computer.

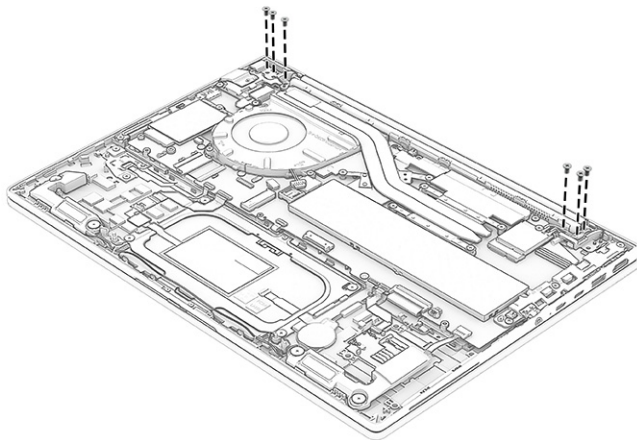

8. Open the computer (1) to approximately 170°
9. Separate the display assembly (2) from the computer.

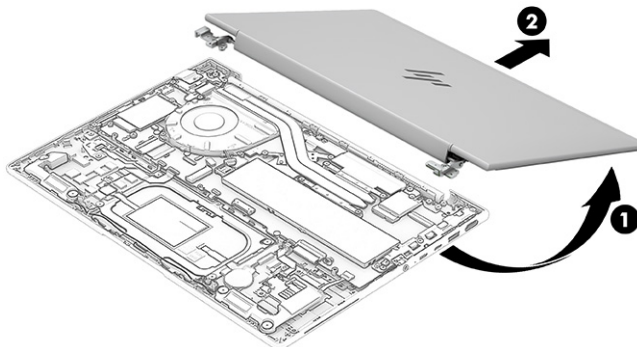

10. To remove the bezel:
 - a. Flex the top **(1)**, the left and right sides **(2)**, and then the bottom of the bezel **(3)** to release it.
 - b. Remove the bezel **(4)** from the display.

 **NOTE:** To avoid damaging the panel, do not use a tool to release the inside of the bezel. You can use a tool only when you insert it from the outside of the top, left, and right sides of the bezel. Use your fingers to lift up on the bezel. Avoid pressing down on the panel during removal.

The display bezel is available as the following spare part numbers:

N96561-001: Models with an FHD camera

N965612-001: Models with an IR camera

N96563-001: Models with no camera

N96564-001: Models with an IR camera and privacy display

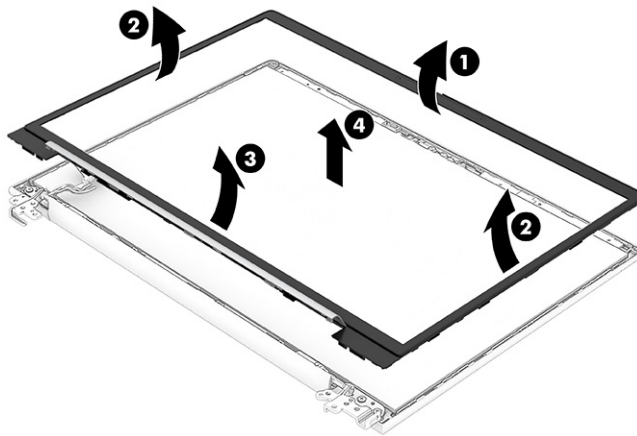

11. To remove the display panel:
 - a. The display panel is secured to the display enclosure with tape that is installed under the sides of the panel. To remove the panel, from all four corners, use tweezers to pull the end of the tape **(1)** out from behind the panel. Use tweezers or your fingers to pull the tape **(2)** out from behind the display panel. You must pull the tape multiple times before it is completely removed.
 - b. Rotate the display panel over and place it next to the display enclosure **(3)**.

Display panels are available as the following spare part numbers:

N98714-001: WUXGA, 300 nit panel, touch screen

N98715-001: WUXGA, 300 nit panel

N98716-001: WUXGA, 1000 nit privacy panel

N98717-001: WUXGA, 400 nit panel

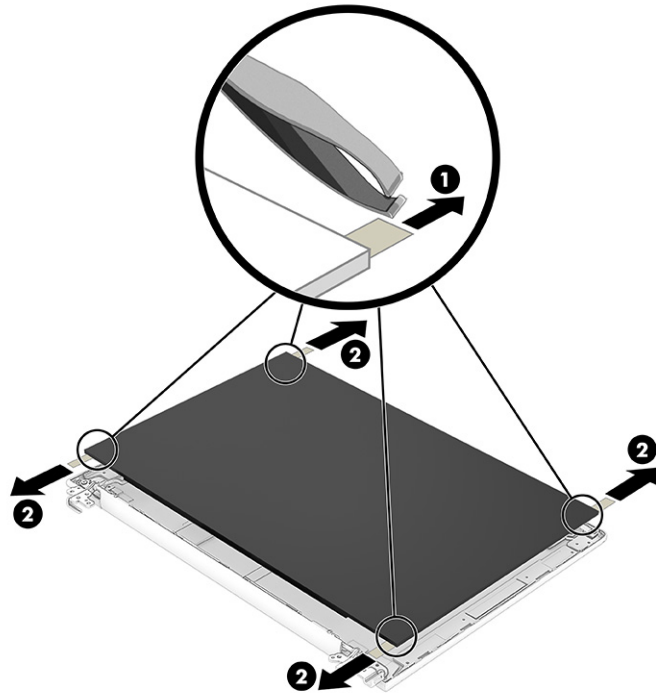

- c. Lift the tape (1) and the locking arm (2) from the connector on the display panel, and then disconnect the cable (3) from the panel.

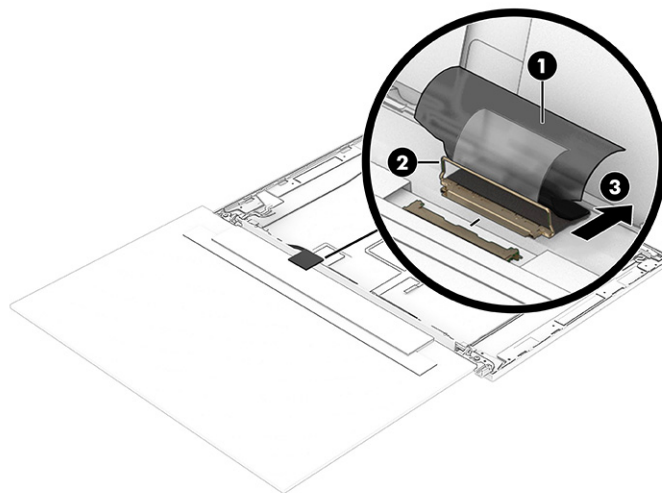

- 12. To remove an IR camera module:

- a. Disconnect the cable from the ZIF connector (1) on the module. Starting on the left side of the module, use a tool (2) to release the module, and then remove the module (3). The IR camera module is available as spare part number N96912-001.

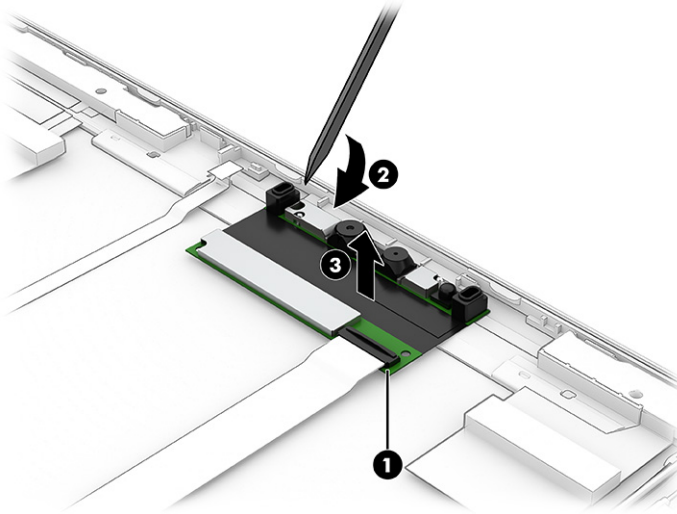

- b. IR cameras use different black protective tape depending on the panel. When installing a new IR camera, be sure to add new tape that matches the shape of the tape on the old camera.

13. To remove an FHD camera module:

- Starting on the left side of the module, use a tool (1) to release the module. Lift the module (2) up, and then disconnect the cable from the ZIF connector on the module. The FHD camera module is available as spare part number N96913-001. The microphone module is available as spare part number N99998-001.

 **NOTE:** During installation, note that the cable routes under the camera module before it connects to the module.

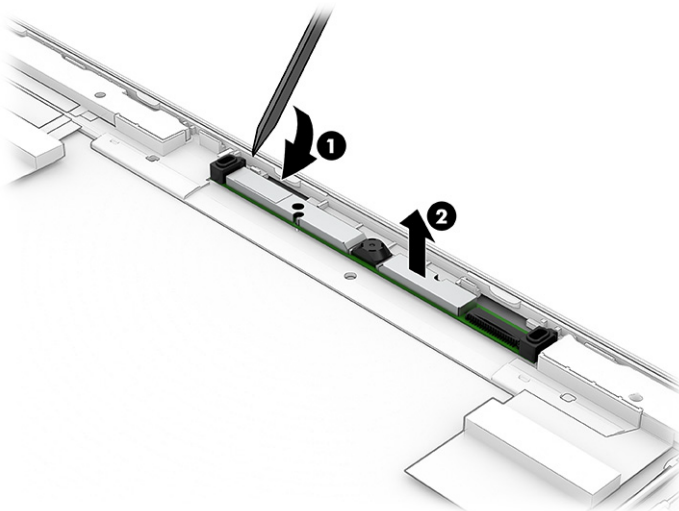

14. To remove the ambient light sensor (ALS):

- Disconnect the cable from the ZIF connector **(1)** on the board, and then use a tool **(2)** to release the board from the display. The ALS is available as spare part number N96911-001.

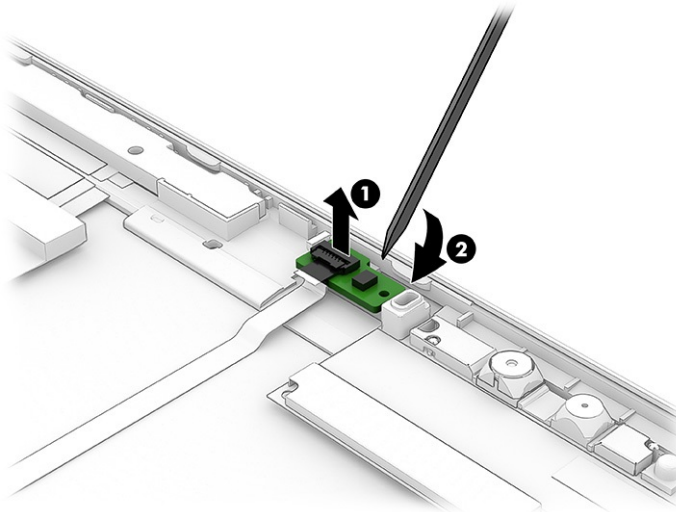

15. To remove the hinges from the display enclosure:

- Remove the three Phillips M2.0 × 2.0 screws **(1)** from each hinge.
- Remove the cables **(2)** from the left hinge.
- Remove the cables **(3)** from the right hinge.
- Remove the hinges **(4)** from the display.

The hinges are available as spare part number N96454-001.

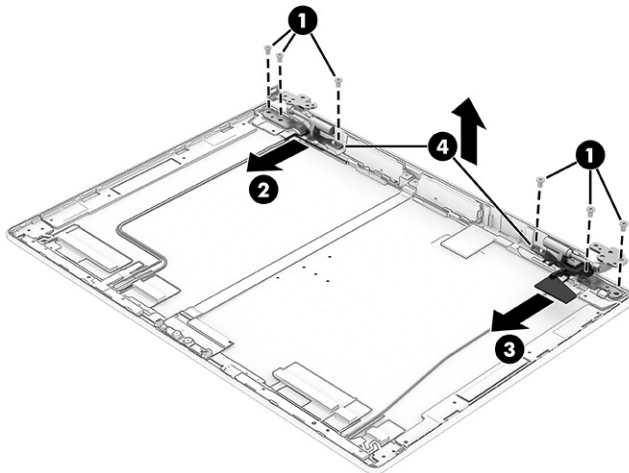

16. To remove the display panel/camera cable on models with an IR camera:

- Disconnect the cable from the ZIF connector **(1)** on the camera module.
- Peel the cable **(2)** off the inside of the display rear cover.

- c. Remove the cable from the clips **(3)** along the bottom near the left hinge.

The display panel/camera cable is available as spare part number N96453-001.

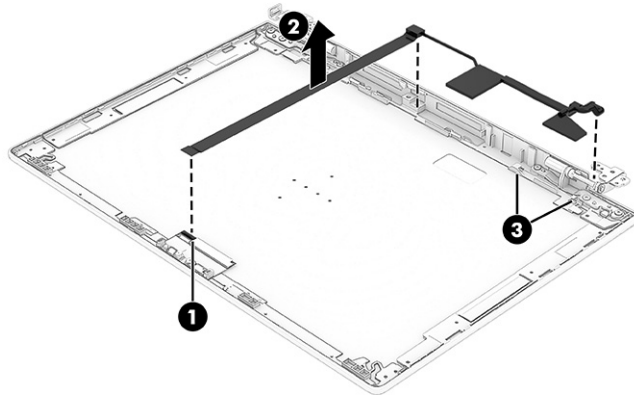

- 17. To remove the display panel/camera cable on models with an FHD camera:

- a. With the camera module removed, peel the cable **(1)** off the inside of the display rear cover.
- b. Remove the cable from the clips **(2)** along the bottom near the left hinge.

The display panel/camera cable is available as spare part number N96453-001.

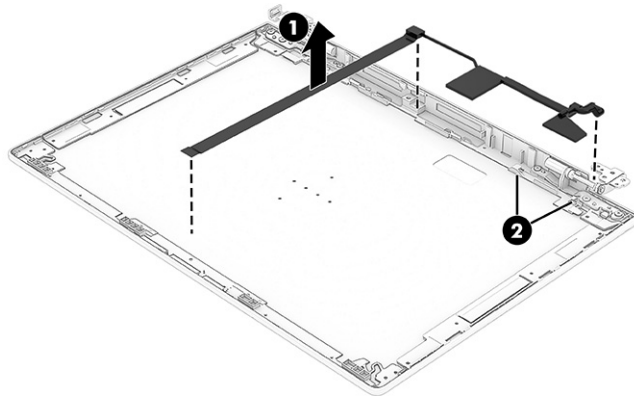

- 18. To remove the wireless antennas and cables:

The wireless antennas and cables, including both WLAN and WWAN antennas, are available as spare part number N96452-001.

- a. Remove the display cable and WLAN cables from the clips **(1)** near the left hinge.
- b. Remove the WWAN cable and WWAN antenna cables from the clips **(2)** near the right hinge.
- c. Remove the WLAN antenna cable from the clips **(3)** along the bottom of the display rear cover.
- d. Lift the six plastic clips **(4)**.
- e. Remove the long black strip of tape **(5)** from each antenna at the top.

- f. Peel the antennas (6) off the display rear cover.

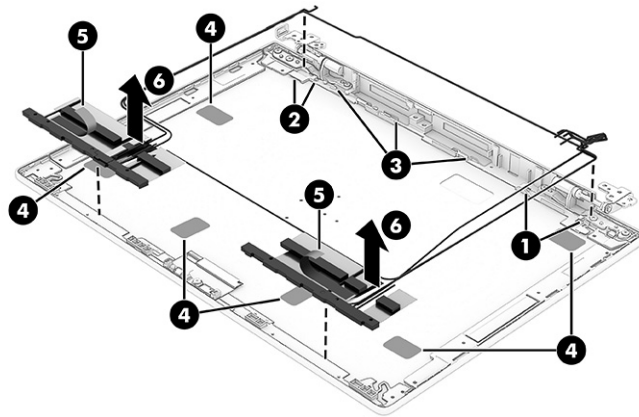

To reassemble and replace the display assembly, reverse these procedures.

Top cover with keyboard

The top cover with keyboard remains after removing all other spare parts from the computer. In this section, the first table provides the main spare part number for the top covers with keyboards. The second table provides the country codes.

Table 8-11 Top cover with keyboard descriptions and part numbers

Description	Spare part number
Top cover with keyboard, backlit	N98719-001
Top cover with keyboard, backlit, privacy	N98718-001
Top cover with keyboard, not backlit	N98720-001

Table 8-12 Spare part country codes

For use in country or region	Spare part number	For use in country or region	Spare part number	For use in country or region	Spare part number
Belgium	-A41	Hungary	-211	Saudi Arabia	-171
Brazil	-201	Iceland	-DD1	Slovenia	-BA1
Bulgaria	-261	India	-D61	South Korea	-AD1
Chile	-161	Israel	-BB1	Spain	-071
Czech Republic/Slovakia	-FL1	Italy	-061	Switzerland	-BG1
Denmark	-081	Japan	-291	Taiwan	-AB1
Denmark, Finland, and Norway	-DH1	The Netherlands	-B31	Thailand	-281
French Canada	-DB1	Northern Africa	-FP1	Turkey	-141
Finland/Sweden	-B71	Norway	-091	Turkey-F	-541
France	-051	Portugal	-131	Ukraine	-BD1

Table 8-12 Spare part country codes (continued)

For use in country or region	Spare part number	For use in country or region	Spare part number	For use in country or region	Spare part number
Germany	-041	Romania	-271	United Kingdom	-031
Greece	-151	Russia	-251	United States	-001

9 Backing up, restoring, and recovering

You can use Windows tools or HP software to back up your information, create a restore point, reset your computer, create recovery media, or restore your computer to its factory state. Performing these standard procedures can return your computer to a working state faster.

 **IMPORTANT:** If you are performing recovery procedures on a tablet, the tablet battery must be at least 70% charged before you start the recovery process.

 **IMPORTANT:** For a tablet with a detachable keyboard, connect the tablet to the keyboard base before beginning any recovery process.

Backing up information and creating recovery media

These methods of creating recovery media and backups are available on select products only.

Using Windows tools for backing up

HP recommends that you back up your information immediately after initial setup. You can do this task either using Windows Backup locally with an external USB flash drive or using online tools.

 **NOTE:** If computer storage is 32 GB or less, Microsoft® System Restore is disabled by default.

Using the HP Cloud Recovery Download Tool to create recovery media (select products only)

You can use the HP Cloud Recovery Download Tool to create HP Recovery media on a bootable USB flash drive.

For details:

- Go to <http://www.hp.com>, search for HP Cloud Recovery, and then select the result that matches the type of computer that you have.

 **NOTE:** If you cannot create recovery media yourself, contact support to obtain recovery discs. Go to <http://www.hp.com/support>, select your country or region, and then follow the on-screen instructions.

 **IMPORTANT:** HP recommends that you follow the [Restoring and recovery methods on page 98](#) to restore your computer before you obtain and use the HP recovery discs. Using a recent backup can return your machine to a working state sooner than using the HP recovery discs. After the system is restored, reinstalling all the operating system software released since your initial purchase can be a lengthy process.

Restoring and recovering your system

You have several tools available to recover your system both within and outside of Windows if the desktop cannot load.

HP recommends that you attempt to restore your system using the [Restoring and recovery methods on page 98](#).

Creating a system restore

System Restore is available in Windows. The System Restore software can automatically or manually create restore points, or snapshots, of the system files and settings on the computer at a particular point.

When you use System Restore, it returns your computer to its state at the time you made the restore point. Your personal files and documents should not be affected.

Restoring and recovery methods

After you run the first method, test to see whether the issue still exists before you proceed to the next method, which might now be unnecessary.

1. Run a Microsoft System Restore.
2. Run Reset this PC.



NOTE: The options **Remove everything** and then **Fully clean the drive** can take several hours to complete and leave no information on your computer. It is the safest way to reset your computer before you recycle it.

3. Recover using HP Recovery media. For more information, see [Recovering using HP Recovery media on page 98](#).

For more information about the first two methods, see the Get Help app:

- Select the **Start** button, select **All apps**, select the **Get Help** app, and then enter the task you want to perform.



NOTE: You must be connected to the internet to access the Get Help app.

Recovering using HP Recovery media

You can use HP Recovery media to recover the operating system and drivers that were installed at the factory. On select products, you can create recovery media on a bootable USB flash drive using the HP Cloud Recovery Download Tool.

For details, see [Using the HP Cloud Recovery Download Tool to create recovery media \(select products only\) on page 97](#).



NOTE: If you cannot create recovery media yourself, contact support to obtain recovery discs. Go to <http://www.hp.com/support>, select your country or region, and then follow the on-screen instructions.

To recover your system:

- Insert the HP Recovery media, and then restart the computer.



NOTE: HP recommends that you follow the [Restoring and recovery methods on page 98](#) to restore your computer before you obtain and use the HP recovery discs. Using a recent backup can return your machine to a working state sooner than using the HP recovery discs. After the system is restored, reinstalling all the operating system software released since your initial purchase can be a lengthy process.

Changing the computer boot order

If your computer does not restart using the HP Recovery media, you can change the computer boot order, which is the order of devices listed in BIOS for startup information. You can select an optical drive or a USB flash drive, depending on the location of your HP Recovery media.

 **IMPORTANT:** For a tablet with a detachable keyboard, connect the tablet to the keyboard base before beginning these steps.

To change the boot order:

1. Insert the HP Recovery media.
2. Access the system **Startup** menu.
 - For computers or tablets with keyboards attached, turn on or restart the computer or tablet, quickly press **esc**, and then press **f9** for boot options.
 - For tablets without keyboards, turn on or restart the tablet, and then quickly press and hold one of the following buttons:
 - Volume up
 - Volume down

Then select **f9**.
3. Select the optical drive or USB flash drive from which you want to boot, and then follow the on-screen instructions.

Using HP Sure Recover (select products only)

Select computer models are configured with HP Sure Recover, a PC operating system (OS) recovery solution built into the hardware and software. HP Sure Recover can fully restore the HP OS image without installed recovery software.

Using HP Sure Recover, an administrator or user can restore the system and install:

- Latest version of the operating system
- Platform-specific device drivers
- Software applications, in the case of a custom image

To access the latest documentation for HP Sure Recover, go to <http://www.hp.com/support>. Follow the on-screen instructions to find your product and locate your documentation.

10 Computer Setup (BIOS), TPM, and HP Sure Start

HP provides several tools to help set up and protect your computer.

Using Computer Setup

Computer Setup, or Basic Input/Output System (BIOS), controls communication between all the input and output devices on the system (such as hard drives, display, keyboard, mouse, and printer). Computer Setup includes settings for types of devices installed, the startup sequence of the computer, and amount of system and extended memory.

 **NOTE:** Use extreme care when making changes in Computer Setup. Errors can prevent the computer from operating properly.

To start Computer Setup, turn on or restart the computer, and when the HP logo appears, press **f10** to enter Computer Setup.

Navigating and selecting in Computer Setup

You can navigate and select in Computer Setup using one or more methods.

- To select a menu or a menu item, use the **tab** key and the keyboard arrow keys and then press **enter**, or use a pointing device to select the item.
- To scroll up and down, select the up arrow or the down arrow in the upper-right corner of the screen, or use the up arrow key or the down arrow key on the keyboard.
- To close open dialog boxes and return to the main Computer Setup screen, press **esc**, and then follow the on-screen instructions.

To exit Computer Setup, choose one of the following methods:

- To exit Computer Setup menus without saving your changes, select **Main**, select **Ignore Changes and Exit**, and then select **Yes**.

 **NOTE:** If you are using arrow keys to highlight your choice, you must then press **enter**.

- To save your changes and exit Computer Setup menus, select **Main**, select **Save Changes and Exit**, and then select **Yes**.

 **NOTE:** If you are using arrow keys to highlight your choice, you must then press **enter**.

Your changes go into effect when the computer restarts.

Restoring factory settings in Computer Setup

To return all settings in Computer Setup to the values that were set at the factory, follow these steps.

 **NOTE:** Restoring defaults will not change the hard drive mode.

1. Start Computer Setup. See [Using Computer Setup on page 100](#).
2. Select **Main**, select **Apply Factory Defaults and Exit**, and then select **Yes**.

 **NOTE:** If you are using arrow keys to highlight your choice, you must then press **enter**.

 **NOTE:** On select products, the selections might display **Restore Defaults** instead of **Apply Factory Defaults and Exit**.

Your changes go into effect when the computer restarts.

 **NOTE:** Your password settings and security settings are not changed when you restore the factory settings.

Updating the BIOS

Updated versions of the BIOS might be available on the HP website. Most BIOS updates on the HP website are packaged in compressed files called *SoftPaqs*.

Some download packages contain a file named Readme.txt, which contains information regarding installing and troubleshooting the file.

Determining the BIOS version

To decide whether you need to update Computer Setup (BIOS), first determine the BIOS version on your computer.

If you are already in Windows, you can access BIOS version information (also known as *ROM date* and *System BIOS*) by pressing **fn+esc** (select products only). Or you can use Computer Setup.

1. Start Computer Setup. See [Using Computer Setup on page 100](#).
2. Select **Main**, and then select **System Information**.
3. To exit Computer Setup menus without saving your changes, select **Main**, select **Ignore Changes and Exit**, and then select **Yes**.

 **NOTE:** If you are using arrow keys to highlight your choice, you must then press **enter**.

To check for later BIOS versions, see [Preparing for a BIOS update on page 101](#).

Preparing for a BIOS update

Be sure to follow all prerequisites before downloading and installing a BIOS update.

 **IMPORTANT:** To reduce the risk of damage to the computer or an unsuccessful installation, download and install a BIOS update only when the computer is connected to reliable external power using the AC adapter. Do not download or install a BIOS update while the computer is running on battery power, docked in an optional docking device, or connected to an optional power source. During the download and installation, follow these instructions:

Do not disconnect power on the computer by unplugging the power cord from the AC outlet.

Do not shut down the computer or initiate Sleep.

Do not insert, remove, connect, or disconnect any device, cable, or cord.

Downloading a BIOS update

After you review the prerequisites, you can check for and download BIOS updates.

1. Perform one of these tasks:
 - Select the **Search** icon in the taskbar, type `support` in the search box, and then select the **HP Support Assistant** app.
 - Select the question mark icon (select products only) in the taskbar.
2. Select **Updates**, and then select **Check for updates and messages**.
3. Follow the on-screen instructions.
4. At the download area, follow these steps:
 - a. Identify the most recent BIOS update and compare it to the BIOS version currently installed on your computer. Make a note of the date, name, or other identifier. You might need this information to locate the update later, after it has been downloaded to your hard drive.
 - b. Follow the on-screen instructions to download your selection to the hard drive.

Make a note of the path to the location on your hard drive where the BIOS update is downloaded. You will need to access this path when you are ready to install the update.



NOTE: If you connect your computer to a network, consult the network administrator before installing any software updates, especially system BIOS updates.

Installing a BIOS update

BIOS installation procedures vary. Follow any instructions that are displayed on the screen after the download is complete. If no instructions are displayed, follow these steps.

1. Select the **Search** icon in the taskbar, type `file` in the search box, and then select **File Explorer**.
2. Select your hard drive designation. The hard drive designation is typically Local Disk (C:).
3. Using the hard drive path you recorded earlier, open the folder that contains the update.
4. Double-click the file that has an `.exe` extension (for example, `filename.exe`).
The BIOS installation begins.
5. Complete the installation by following the on-screen instructions.



NOTE: After a message on the screen reports a successful installation, you can delete the downloaded file from your hard drive.

Changing the boot order using the f9 prompt

To dynamically choose a boot device for the current startup sequence, follow these steps.

1. Access the Boot Device Options menu:
 - Turn on or restart the computer, and when the HP logo appears, press **f9** to enter the Boot Device Options menu.
2. Select a boot device, press **enter**, and then follow the on-screen instructions.

TPM BIOS settings (select products only)

TPM provides additional security for your computer. You can modify the TPM settings in Computer Setup (BIOS).

 **IMPORTANT:** Before enabling Trusted Platform Module (TPM) functionality on this system, you must ensure that your intended use of TPM complies with relevant local laws, regulations and policies, and approvals or licenses must be obtained if applicable. For any compliance issues arising from your operation or usage of TPM that violates the previously mentioned requirement, you shall bear all the liabilities wholly and solely. HP will not be responsible for any related liabilities.

 **NOTE:** If you change the TPM setting to Hidden, TPM is not visible in the operating system.

To access TPM settings in Computer Setup:

1. Start Computer Setup. See [Using Computer Setup on page 100](#).
2. Select **Security**, select **TPM Embedded Security**, and then follow the on-screen instructions.

Using HP Sure Start (select products only)

Select computer models are configured with HP Sure Start, a technology that monitors the computer's BIOS for attacks or corruption. If the BIOS becomes corrupted or is attacked, HP Sure Start automatically restores the BIOS to its previously safe state, without user intervention.

HP Sure Start is configured and already enabled so that most users can use the HP Sure Start default configuration. Advanced users can customize the default configuration.

To access the latest documentation on HP Sure Start, go to <http://www.hp.com/support>. Select **Find your product**, and then follow the on-screen instructions.

11 Using HP PC Hardware Diagnostics

You can use the HP PC Hardware Diagnostics utility to determine whether your computer hardware is running properly. The three versions are HP PC Hardware Diagnostics Windows, HP PC Hardware Diagnostics UEFI (Unified Extensible Firmware Interface), and (for select products only) Remote HP PC Hardware Diagnostics UEFI, a firmware feature.

Using HP PC Hardware Diagnostics Windows (select products only)

HP PC Hardware Diagnostics Windows is a Windows-based utility that allows you to run diagnostic tests to determine whether the computer hardware is functioning properly. The tool runs within the Windows operating system to diagnose hardware failures.

If HP PC Hardware Diagnostics Windows is not installed on your computer, you must download and install it. To download HP PC Hardware Diagnostics Windows, see [Downloading HP PC Hardware Diagnostics Windows on page 105](#).

Using an HP PC Hardware Diagnostics Windows hardware failure ID code

When HP PC Hardware Diagnostics Windows detects a failure that requires hardware replacement, a 24-digit failure ID code is generated for select component tests. For interactive tests, such as keyboard, mouse, or audio and video palette, you must perform troubleshooting steps before you can receive a failure ID.

You have several options after you receive a failure ID:

- Select **Next** to open the Event Automation Service (EAS) page, where you can log the case.
- Scan the QR code with your mobile device, which takes you to the EAS page, where you can log the case.
- Select the box next to the 24-digit failure ID to copy your failure code and send it to support.

Accessing HP PC Hardware Diagnostics Windows

After HP PC Hardware Diagnostics Windows is installed, you can access it from HP Support Assistant or the Start menu.

Accessing HP PC Hardware Diagnostics Windows from HP Support Assistant

After HP PC Hardware Diagnostics Windows is installed, follow these steps to access it from HP Support Assistant:

1. Complete one of the following tasks:
 - Select the **Search** icon in the taskbar, type `support` in the search box, and then select the **HP Support Assistant** app.
 - Select the question mark icon in the taskbar.
2. Select **Fixes & Diagnostics**.

3. Select **Run hardware diagnostics**, and then select **Launch**.
4. When the tool opens, select the type of diagnostic test that you want to run, and then follow the on-screen instructions.

 **NOTE:** To stop a diagnostic test, select **Cancel**.

Accessing HP PC Hardware Diagnostics Windows from the Start menu (select products only)

After HP PC Hardware Diagnostics Windows is installed, follow these steps to access it from the Start menu:

1. Select the **Start** button, and then select **All apps**.
2. Select **HP PC Hardware Diagnostics Windows**.
3. When the tool opens, select the type of diagnostic test that you want to run, and then follow the on-screen instructions.

 **NOTE:** To stop a diagnostic test, select **Cancel**.

Downloading HP PC Hardware Diagnostics Windows

The HP PC Hardware Diagnostics Windows downloading instructions are provided in English only. You must use a Windows computer to download this tool because only .exe files are provided.

Downloading the latest HP PC Hardware Diagnostics Windows version from HP

To download HP PC Hardware Diagnostics Windows from HP, follow these steps:

1. Go to <http://www.hp.com/go/techcenter/pcdiags>. The HP PC Diagnostics home page is displayed.
2. Select **Download HP Diagnostics Windows**, and then select the specific Windows diagnostics version to download to your computer or a USB flash drive.

The tool downloads to the selected location.

Downloading the HP PC Hardware Diagnostics Windows from the Microsoft Store

You can download the HP PC Hardware Diagnostics Windows from the Microsoft Store:

1. Select the Microsoft Store app on your desktop or select the **Search** icon in the taskbar, and then type `Microsoft Store` in the search box.
2. Type `HP PC Hardware Diagnostics Windows` in the **Microsoft Store** search box.
3. Follow the on-screen directions.

The tool downloads to the selected location.

Downloading HP Hardware Diagnostics Windows by product name or number (select products only)

You can download HP PC Hardware Diagnostics Windows by product name or number.

 **NOTE:** For some products, you might have to download the software to a USB flash drive by using the product name or number.

1. Go to <http://www.hp.com/support>.
2. Select **Software and Drivers**, select your type of product, and then enter the product name or number in the search box that is displayed.
3. In the **Diagnostics** section, select **Download**, and then follow the on-screen instructions to select the specific Windows diagnostics version to be downloaded to your computer or USB flash drive.

The tool downloads to the selected location.

Installing HP PC Hardware Diagnostics Windows

To install HP PC Hardware Diagnostics Windows, navigate to the folder on your computer or the USB flash drive where the .exe file downloaded, double-click the .exe file, and then follow the on-screen instructions.

Using HP PC Hardware Diagnostics UEFI

HP PC Hardware Diagnostics Unified Extensible Firmware Interface (UEFI) allows you to run diagnostic tests to determine whether the computer hardware is functioning properly. The tool runs outside the operating system so that it can isolate hardware failures from issues that are caused by the operating system or other software components.



NOTE: For some products, you must use a Windows computer and a USB flash drive to download and create the HP UEFI support environment because only .exe files are provided. For more information, see [Downloading HP PC Hardware Diagnostics UEFI to a USB flash drive on page 107](#).

If your PC does not start in Windows, you can use HP PC Hardware Diagnostics UEFI to diagnose hardware issues.

Using an HP PC Hardware Diagnostics UEFI hardware failure ID code

When HP PC Hardware Diagnostics UEFI detects a failure that requires hardware replacement, a 24-digit failure ID code is generated.

For assistance in solving the problem, complete one of these tasks:

- Select **Contact HP**, accept the HP privacy disclaimer, and then use a mobile device to scan the failure ID code that appears on the next screen. The HP Customer Support - Service Center page appears with your failure ID and product number automatically filled in. Follow the on-screen instructions.
- Contact support, and provide the failure ID code.

Starting HP PC Hardware Diagnostics UEFI

To start HP PC Hardware Diagnostics UEFI, follow this procedure.

1. Turn on or restart the computer, and quickly press **esc**.
2. Press **f2**.

The BIOS searches three places for the diagnostic tools, in the following order:

- a. Connected USB flash drive



NOTE: To download the HP PC Hardware Diagnostics UEFI tool to a USB flash drive, see [Downloading the latest HP PC Hardware Diagnostics UEFI version on page 108](#).

- b. Hard drive
 - c. BIOS
3. When the diagnostic tool opens, select the type of diagnostic test that you want to run, and then follow the on-screen instructions.

Starting HP PC Hardware Diagnostics UEFI through HP Hotkey Support software (select products only)

This section describes how to start HP PC Hardware Diagnostics UEFI through HP Hotkey Support software.



NOTE: You must disable fast boot to access HP PC Hardware Diagnostics UEFI from the HP System Information application.

To disable fast boot:

1. Turn on or restart the computer, and when the HP logo appears, press **f10** to enter Computer Setup.
2. Select **Advanced**, and then select **Boot Options**.
3. Clear **Fast Boot**.
4. Select **Save Changes and Exit**, and then select **Yes**.

To start HP PC Hardware Diagnostics UEFI through HP Hotkey Support software, follow this procedure.:

1. From the **Start** menu, open the HP System Information Application or press **fn+esc**.
2. In HP System Information screen, select **Run System Diagnostics**, select **Yes** to run the application, and then select **Restart**.



IMPORTANT: To prevent loss of data, save your work in all open apps before restarting your computer.



NOTE: When the restart is complete, the computer opens the HP PC Hardware Diagnostics UEFI Application. Proceed with the troubleshooting tests.

Downloading HP PC Hardware Diagnostics UEFI to a USB flash drive

Downloading HP PC Hardware Diagnostics UEFI to a USB flash drive can be useful in some situations.

- HP PC Hardware Diagnostics UEFI is not included in the preinstallation image.
- HP PC Hardware Diagnostics UEFI is not included in the HP Tool partition.
- The hard drive is damaged.



NOTE: The HP PC Hardware Diagnostics UEFI downloading instructions are provided in English only, and you must use a Windows computer to download and create the HP UEFI support environment because only `.exe` files are provided.

Downloading the latest HP PC Hardware Diagnostics UEFI version

To download the latest HP PC Hardware Diagnostics UEFI version to a USB flash drive, follow this procedure:

1. Go to <http://www.hp.com/go/techcenter/pcdiags>. The HP PC Diagnostics home page is displayed.
2. Select **Download HP Diagnostics UEFI**, and then select **Run**.

Downloading HP PC Hardware Diagnostics UEFI by product name or number (select products only)

You can download HP PC Hardware Diagnostics UEFI by product name or number (select products only) to a USB flash drive.



NOTE: For some products, you might have to download the software to a USB flash drive by using the product name or number.

1. Go to <http://www.hp.com/support>.
2. Enter the product name or number, select your computer, and then select your operating system.
3. In the **Diagnostics** section, follow the on-screen instructions to select and download the specific UEFI Diagnostics version for your computer.

Using Remote HP PC Hardware Diagnostics UEFI settings (select products only)

Remote HP PC Hardware Diagnostics UEFI is a firmware (BIOS) feature that downloads HP PC Hardware Diagnostics UEFI to your computer. It can then run the diagnostics on your computer, and it might upload results to a preconfigured server.

For more information about Remote HP PC Hardware Diagnostics UEFI, go to <http://www.hp.com/go/techcenter/pcdiags>, and then select **Find out more**.

Downloading Remote HP PC Hardware Diagnostics UEFI

Remote HP PC Hardware Diagnostics UEFI is also available as a SoftPaq that you can download to a server.

Downloading the latest Remote HP PC Hardware Diagnostics UEFI version

You can download the latest Remote HP PC Hardware Diagnostics UEFI version to a USB flash drive.

1. Go to <http://www.hp.com/go/techcenter/pcdiags>. The HP PC Diagnostics home page is displayed.
2. Select **Download Remote Diagnostics**, and then select **Run**.

Downloading Remote HP PC Hardware Diagnostics UEFI by product name or number

You can download Remote HP PC Hardware Diagnostics UEFI by product name or number.



NOTE: For some products, you might have to download the software by using the product name or number.

1. Go to <http://www.hp.com/support>.

2. Select **Software and Drivers**, select your type of product, enter the product name or number in the search box that is displayed, select your computer, and then select your operating system.
3. In the **Diagnostics** section, follow the on-screen instructions to select and download the **Remote UEFI** version for the product.

Customizing Remote HP PC Hardware Diagnostics UEFI settings

Using the Remote HP PC Hardware Diagnostics setting in Computer Setup (BIOS), you can perform several customizations.

- Set a schedule for running diagnostics unattended. You can also start diagnostics immediately in interactive mode by selecting **Execute Remote HP PC Hardware Diagnostics UEFI**.
- Set the location for downloading the diagnostic tools. This feature provides access to the tools from the HP website or from a server that has been preconfigured for use. Your computer does not require the traditional local storage, such as a hard drive or USB flash drive, to run remote diagnostics.
- Set a location for storing the test results. You can also set the user name and password that you use for uploads.
- Display status information about the diagnostics run previously.

To customize Remote HP PC Hardware Diagnostics UEFI settings, follow these steps:

1. Turn on or restart the computer, and when the HP logo appears, press **f10** to enter Computer Setup.
2. Select **Advanced**, and then select **Settings**.
3. Make your customization selections.
4. Select **Main**, then select **Save Changes and Exit** to save your settings.

Your changes take effect when the computer restarts.

12 Specifications

This chapter provides specifications for your computer system.

Computer specifications

This section provides specifications for your computer. When you travel with your computer, the computer dimensions and weights, as well as input power ratings and operating specifications, provide helpful information.

Table 12-1 Computer specifications

	Metric	U.S.
Dimensions		
Width	318.6 mm	12.54 in
Depth	224.4 mm	8.83 in
Height (front)	10.9 mm	0.43 in
Height (rear)	17.0 mm	0.67 in
Weight	1.4 kg	3.08 lbs
Input power		
Operating voltage and current	19.5 V DC @ 2.31 A - 45 W	
	19.5 V DC @ 3.33 A - 65 W	
Temperature		
Operating	5°C to 35°C	41°F to 95°F
Nonoperating	-20°C to 60°C	-4°F to 140°F
Relative humidity (noncondensing)		
Operating	10% to 90%	
Nonoperating	5% to 95%	
Maximum altitude (unpressurized)		
Operating	-15 m to 3,048 m	-50 ft to 10,000 ft
Nonoperating	-15 m to 12,192 m	-50 ft to 40,000 ft



NOTE: Applicable product safety standards specify thermal limits for plastic surfaces. The device operates well within this range of temperatures.

Display specifications

This section provides specifications for your display.

Table 12-2 Display specifications

	Metric	U.S.
Active diagonal size	35.6 cm	14.0 in
Resolution	2560 × 1600 (WQXGA) 1920 × 1200 (WUXGA)	
Surface treatment	Antiglare	
Brightness	300 nits 400 nits 500 nits (WQXGA)	
Viewing angle	UWVA	
Backlight	LED WLED	
Display panel interface	eDP	

Solid-state drive specifications

This section provides specifications for your solid-state drives.

Table 12-3 Solid-state drive specifications

	256 GB*	512 GB*	1 TB*
Dimensions			
Height	1.0 mm	1.0 mm	1.0 mm
Length	50.8 mm	50.8 mm	50.8 mm
Width	28.9 mm	28.9 mm	28.9 mm
Weight	< 10 g	< 10 g	< 10 g
Interface type			
Ready time, maximum (to not busy)	1.0 ms	< 1.0 ms	1.0 ms
Access times, logical	0.1 ms	0.1 ms	0.1 ms
Transfer rate			
Sequential read	up to 2150 MBps	up to 2150 MBps	up to 2150 MBps
Random read	Up to 300,000 IOPs	Up to 300,000 IOPs	Up to 300,000 IOPs
Sequential write	up to 1550 MBps	up to 1550 MBps	up to 1550 MBps
Random write	Up to 100,000 IOPs	Up to 100,000 IOPs	Up to 100,000 IOPs
Total logical sectors	468,883,296	1,000,215,216	1,500,336,388
Operating temperature	0°C to 70°C (32°F to 158°F)		

*1 GB = 1 billion bytes when referring to hard drive storage capacity. Actual accessible capacity is less. Actual drive specifications might differ slightly.



NOTE: Certain restrictions and exclusions apply. Contact support for details.

13 Statement of memory volatility

For general information regarding nonvolatile memory in HP business computers, and to restore nonvolatile memory that can contain personal data after the system has been turned off and the hard drive has been removed, use these instructions.

HP business computer products that use Intel®-based or AMD®-based system boards contain volatile DDR memory. The amount of nonvolatile memory present in the system depends upon the system configuration. Intel-based and AMD-based system boards contain nonvolatile memory subcomponents as originally shipped from HP, with the following assumptions:

- No subsequent modifications were made to the system.
- No applications, features, or functionality were added to or installed on the system.

Following system shutdown and removal of all power sources from an HP business computer system, personal data can remain on volatile system memory (DIMMs) for a finite period of time and also remains in nonvolatile memory. Use the following steps to remove personal data from the computer, including the nonvolatile memory found in Intel-based and AMD-based system boards.

 **NOTE:** If your tablet has a keyboard base, connect to the keyboard base before beginning steps in this chapter.

Current BIOS steps

Use these instructions to restore nonvolatile memory.

1. Follow these steps to restore the nonvolatile memory that can contain personal data. Restoring or reprogramming nonvolatile memory that does not store personal data is neither necessary nor recommended.

- a. Turn on or restart the computer, and then quickly press **esc**.

 **NOTE:** If the system has a BIOS administrator password, type the password at the prompt.

- b. Select **Main**, select **Apply Factory Defaults and Exit**, and then select **Yes** to load defaults. The computer restarts.
- c. During the restart, press **esc** while the "Press the ESC key for Startup Menu" message is displayed at the bottom of the screen.

 **NOTE:** If the system has a BIOS administrator password, type the password at the prompt.

- d. Select the **Security** menu, select **Restore Security Settings to Factory Defaults**, and then select **Yes** to restore security level defaults. The computer restarts.
- e. During the restart, press **esc** while the "Press the ESC key for Startup Menu" message is displayed at the bottom of the screen.

 **NOTE:** If the system has a BIOS administrator password, type the password at the prompt.

- f. If an asset or ownership tag is set, select the **Security** menu and scroll down to the **Utilities** menu. Select **System IDs**, and then select **Asset Tracking Number**. Clear the tag, and then make the selection to return to the prior menu.
- g. If a DriveLock password is set, select the **Security** menu, and scroll down to **Hard Drive Utilities** under the **Utilities** menu. Select **Hard Drive Utilities**, select **DriveLock**, and then clear the check box for **DriveLock password on restart**. Select **OK** to proceed.
- h. Select the **Main** menu, and then select **Reset BIOS Security to factory default**. Select **Yes** at the warning message. The computer restarts.
- i. During the restart, press **esc** while the "Press the ESC key for Startup Menu" message is displayed at the bottom of the screen.



NOTE: If the system has a BIOS administrator password, type the password at the prompt.

- j. Select the **Main** menu, select **Apply Factory Defaults and Exit**, select **Yes** to save changes and exit, and then select **Shutdown**.
 - k. Restart the system. If the system has a Trusted Platform Module (TPM), fingerprint reader, or both, one or two prompts will appear—one to clear the TPM and the other to Reset Fingerprint Sensor. Press or tap **f1** to accept or **f2** to reject.
 - l. Remove all power and system batteries for at least 24 hours.
2. Complete one of the following:
- Remove and retain the storage drive.
- or -
 - Clear the drive contents by using a third-party utility designed to erase data from an SSD.
- or -
 - Clear the contents of the drive by using the following BIOS Setup Secure Erase command option steps:



NOTE: If you clear data using Secure Erase, you cannot recover it.

- a. Turn on or restart the computer, and then quickly press **esc**.
- b. Select the **Security** menu and scroll down to the **esc** menu.
- c. Select **Hard Drive Utilities**.
- d. Under **Utilities**, select **Secure Erase**, select the hard drive storing the data you want to clear, and then follow the on-screen instructions to continue.
- or -
Clear the contents of the drive using the following Disk Sanitizer commands steps:
 - i. Turn on or restart the computer, and then quickly press **esc**.
 - ii. Select the **Security** menu and scroll down to the **Utilities** menu.
 - iii. Select **Hard Drive Utilities**.

- iv. Under **Utilities**, select **Disk Sanitizer**, select the hard drive with the data that you want to clear, and then follow the on-screen instructions to continue.

 **NOTE:** The amount of time it takes for Disk Sanitizer to run can take several hours. Plug the computer into an AC outlet before starting.

Nonvolatile memory usage

Use this table to troubleshoot nonvolatile memory usage.

Table 13-1 Troubleshooting information for nonvolatile memory usage

Description	Volatility description	Storage user data	How to erase
Primary storage device, holds the OS, applications, and application settings	Non-volatile, 8-256 GB of eMMC or NVMe SSD storage, removable	Yes ¹	Follow instructions below under "Erase the Primary Storage Device"
System memory (RAM), holds transient data during system operation	Volatile, SODIMM socket. Removable (4 GB/8 GB/16 GB)	Yes	Unplug unit from power
Permanent system BIOS settings	Non-volatile; 16 KB; stored	No ²	Follow instructions below under "Clearing BIOS Settings"
System boot ROM (BIOS)	Non-volatile memory, 128 Mbit (16 MB) socketed, removable	No	Download the latest BIOS for your model from the HP website and follow the instructions to flash the BIOS that are on the website
RTC (CMOS) RAM	Volatile memory, 256 bytes located in AMD embedded System on Chip (SoC)	No	<p>Desktop computers with a CMOS button:</p> <p>Unplug unit from main power, remove top cover and press the Clear CMOS button.</p> <p>Notebook and desktop computers without a CMOS button:</p> <ol style="list-style-type: none"> 1. Press and hold power button for 12 seconds. 2. Press Windows key + V, and then press power button.
Keyboard/mouse (ROM)	Non-volatile, 2 KB embedded in the super I/O controller (SIO2)	Yes	N/A
Keyboard/mouse (RAM)	Volatile, 256 bytes embedded in the super I/O controller (SIO2)	No	Unplug unit from main power
LOM EEPROM	Non-volatile, 2 MB embedded in LAN controller	No	N/A
Trusted Platform Module (TPM)	Non-volatile; 51 KB ROM for firmware and 38 KB system parametric data	No ³	Follow instructions below under "Clearing TPM"

¹ Under typical operation, the only user data stored on the primary storage device are preferences for device configuration and settings for connections. However, the administrator can configure the system to allow users to store data locally.

² The only user data potentially stored in BIOS Settings are the ownership and asset tags, administrator password, and startup password.

³ The Trusted Platform Module may contain encrypted passwords or certificates generated from user or administrator input.

Questions and answers

Use this section to answer your questions about nonvolatile memory.

1. How can the BIOS settings be restored (returned to factory settings)?

 **IMPORTANT:** The restore defaults feature does not securely erase any information on your hard drive. See question and answer 6 for steps to securely erase information.

The restore defaults feature does not reset the Custom Secure Boot keys. See question and answer 7 for information about resetting the keys.

- a. Turn on or restart the computer, and then quickly press **esc**.
- b. Select **Main**, and then select **Apply Factory Defaults and Exit**.
- c. Follow the on-screen instructions.
- d. Select **Main**, select **Save Changes and Exit**, and then follow the on-screen instructions.

2. What is a UEFI BIOS, and how is it different from a legacy BIOS?

The Unified Extensible Firmware Interface (UEFI) BIOS is an industry-standard software interface between the platform firmware and an operating system (OS). It replaces the older BIOS architecture but supports much of the legacy BIOS functionality.

Like the legacy BIOS, the UEFI BIOS provides an interface to display the system information and configuration settings and to change the configuration of your computer before an OS is loaded. BIOS provides a secure runtime environment that supports a Graphic User Interface (GUI). In this environment, you can use either a pointing device (touch screen, touchpad, pointing stick, or USB mouse) or the keyboard to navigate and make menu and configuration selections. The UEFI BIOS also contains basic system diagnostics.

The UEFI BIOS provides functionality beyond that of the legacy BIOS. In addition, the UEFI BIOS works to initialize the computer's hardware before loading and executing the OS; the runtime environment allows the loading and execution of software programs from storage devices to provide more functionality, such as advanced hardware diagnostics (with the ability to display more detailed system information) and advanced firmware management and recovery software.

HP has provided options in Computer Setup (BIOS) to allow you to run in legacy BIOS, if required by the operating system. Examples of this requirement would be if you upgrade or downgrade the OS.

3. Where is the UEFI BIOS located?

The UEFI BIOS is located on a flash memory chip. You must use a utility to write to the chip.

4. **What kind of configuration data is stored on the DIMM Serial Presence Detect (SPD) memory module? How would this data be written?**

The DIMM SPD memory contains information about the memory module, such as size, serial number, data width, speed and timing, voltage, and thermal information. This information is written by the module manufacturer and stored on an EEPROM. You cannot write to this EEPROM when the memory module is installed in a computer. Third-party tools do exist that can write to the EEPROM when the memory module is not installed in a computer. Various third-party tools are available to read SPD memory.

5. **What is meant by “Restore the nonvolatile memory found in Intel-based system boards”?**

This message relates to clearing the Real Time Clock (RTC) CMOS memory that contains computer configuration data.

6. **How can the BIOS security be reset to factory defaults and erase the data?**

 **IMPORTANT:** Resetting results in the loss of information.

These steps do not reset Custom Secure Boot Keys. See question and answer 7 for information about resetting the keys.

- a. Turn on or restart the computer, and then quickly press **esc**.
- b. Select **Main**, and then select **Reset Security to Factory Defaults**.
- c. Follow the on-screen instructions.
- d. Select **Main**, select **Save Changes and Exit**, and then follow the on-screen instructions.

7. **How can the Custom Secure Boot Keys be reset?**

Secure Boot is a feature to ensure that only authenticated code can start on a platform. If you enabled Secure Boot and created Custom Secure Boot Keys, disabling Secure Boot does not clear the keys. You must also select to clear the Custom Secure Boot Keys. Use the same Secure Boot access procedure that you used to create the Custom Secure Boot Keys, but select to clear or delete all Secure Boot Keys.

- a. Turn on or restart the computer, and then quickly press **esc**.
- b. Select the **Security** menu, select **Secure Boot Configuration**, and then follow the on-screen instructions.
- c. At the **Secure Boot Configuration** window, select **Secure Boot**, select **Clear Secure Boot Keys**, and then follow the on-screen instructions to continue.

Using HP Sure Start (select products only)

Select computer models are configured with HP Sure Start, a technology that continuously monitors your computer's BIOS for attacks or corruption.

If the BIOS becomes corrupted or is attacked, HP Sure Start restores the BIOS to its previously safe state, without user intervention. Those select computer models ship with HP Sure Start configured and enabled. HP Sure Start is configured and already enabled so that most users can use the HP Sure Start default configuration. Advanced users can customize the default configuration.

To access the latest documentation on HP Sure Start, go to <http://www.hp.com/support>.

14 Power cord set requirements

This chapter provides power cord requirements for countries and regions.

The wide-range input feature of the computer permits it to operate from any line voltage from 100 V AC to 120 V AC, or from 220 V AC to 240 V AC.

The three-conductor power cord set included with the computer meets the requirements for use in the country or region where the equipment is purchased.

Power cord sets for use in other countries or regions must meet the requirements of the country and region where the computer is used.

Requirements for all countries

These power cord requirements are applicable to all countries and regions.

- The length of the power cord set must be at least **1.0 m** (3.3 ft) and no more than **2.0 m** (6.5 ft).
- All power cord sets must be approved by an acceptable accredited agency responsible for evaluation in the country or region where the power cord set will be used.
- The power cord sets must have a minimum current capacity of 10 A and a nominal voltage rating of 125 V AC or 250 V AC, as required by the power system of each country or region.
- The appliance coupler must meet the mechanical configuration of an EN 60 320/IEC 320 Standard Sheet C13 connector for mating with the appliance inlet on the back of the computer.

Requirements for specific countries and regions

To determine power cord requirements for specific countries and regions, use this table.

Table 14-1 Power cord requirements for specific countries and regions

Country/region	Accredited agency	Applicable note number
Argentina	IRAM	1
Australia	SAA	1
Austria	OVE	1
Belgium	CEBEC	1
Brazil	ABNT	1
Canada	CSA	2
Chile	IMQ	1
Denmark	DEMKO	1
Finland	FIMKO	1
France	UTE	1

Table 14-1 Power cord requirements for specific countries and regions (continued)

Country/region	Accredited agency	Applicable note number
Germany	VDE	1
India	BIS	1
Israel	SII	1
Italy	IMQ	1
Japan	JIS	3
Netherlands	KEMA	1
New Zealand	SANZ	1
Norway	NEMKO	1
People's Republic of China	CCC	4
Saudi Arabia	SASO	7
Singapore	PSB	1
South Africa	SABS	1
South Korea	KTL	5
Sweden	SEMKO	1
Switzerland	SEV	1
Taiwan	BSMI	6
Thailand	TISI	1
United Kingdom	ASTA	1
United States	UL	2

1. The flexible cord must be Type HO5VV-F, three-conductor, 0.75 mm² conductor size. Power cord set fittings (appliance coupler and wall plug) must bear the certification mark of the agency responsible for evaluation in the country or region where it will be used.
2. The flexible cord must be Type SVT/SJT or equivalent, No. 18 AWG, three-conductor. The wall plug must be a two-pole grounding type with a NEMA 5-15P (15 A, 125 V AC) or NEMA 6-15P (15 A, 250 V AC) configuration. CSA or C-UL mark. UL file number must be on each element.
3. The appliance coupler, flexible cord, and wall plug must bear a T mark and registration number in accordance with the Japanese Dentori Law. The flexible cord must be Type VCTF, three-conductor, 0.75 mm² or 1.25 mm² conductor size. The wall plug must be a two-pole grounding type with a Japanese Industrial Standard C8303 (7 A, 125 V AC) configuration.
4. The flexible cord must be Type RVV, three-conductor, 0.75 mm² conductor size. Power cord set fittings (appliance coupler and wall plug) must bear the CCC certification mark.
5. The flexible cord must be Type H05VV-F three-conductor, 0.75 mm² conductor size. KTL logo and individual approval number must be on each element. Approval number and logo must be printed on a flag label.
6. The flexible cord must be Type HVCTF three-conductor, 1.25 mm² conductor size. Power cord set fittings (appliance coupler, cable, and wall plug) must bear the BSMI certification mark.

7. For 127 V AC, the flexible cord must be Type SVT or SJT 3-conductor, 18 AWG, with plug NEMA 5-15P (15 A, 125 V AC), with UL and CSA or C-UL marks. For 240 V AC, the flexible cord must be Type H05VV-F three-conductor, 0.75 mm² or 1.00 mm² conductor size, with plug BS 1363/A with BSI or ASTA marks.

15 Recycling

When a nonrechargeable or rechargeable battery has reached the end of its useful life, do not dispose of the battery in general household waste. Follow the local laws and regulations in your area for battery disposal.

HP encourages customers to recycle used electronic hardware, HP original print cartridges, and rechargeable batteries. For more information about recycling programs, see the HP website at <http://www.hp.com/recycle>.

Index

- A**
 - AC adapters, spare part numbers 37, 48
 - audio-out (headphone)/audio-in (microphone) combo jack, identifying 7, 20
 - audio, product description 2
- B**
 - backup, creating 97
 - backups 97
 - battery
 - illustrated 33, 44
 - spare part number 33, 44
 - BIOS
 - determining version 101
 - downloading an update 101, 102
 - updating 101
 - Bluetooth label 15, 28
 - boot order
 - changing using the f9 prompt 102
 - boot order, changing 99
 - bottom cover
 - illustrated 34, 45
 - removal 62
 - spare part number 34, 45, 62
 - buttons
 - power 12, 14, 25, 27
- C**
 - camera 8, 21
 - identifying 8, 21
 - camera light, identifying 8, 21
 - camera privacy cover, identifying 8, 21
 - caps lock light, identifying 11, 24
 - caring for your computer 57
 - cautions
 - electrostatic discharge 53, 54
 - cleaning your computer 57
 - caring for wood veneer 59
 - disinfecting 58
 - HP Easy Clean 57
 - removing dirt and debris 57
 - components
 - bottom 14, 27
 - display 7, 20
 - keyboard area 9, 22
 - left side 5, 18
 - rear 15, 28
 - right side 5, 18
 - computer major components 31, 42
 - Computer Setup
 - navigating and selecting 100
 - restoring factory settings 100
 - starting 100
 - computer specifications 110
 - control zone 10, 23
- D**
 - display
 - specifications 110
 - display assembly
 - subcomponents 34, 45
 - display back cover
 - illustrated 36, 47
 - spare part number 36, 47
 - display bezel
 - illustrated 35, 46
 - spare part number 35, 46
 - display cable
 - illustrated 36, 47
 - spare part number 36, 47
 - display components 7, 20
 - display panel
 - illustrated 35, 46
 - product description 1
 - spare part number 35, 46
- E**
 - electrostatic discharge (ESD) 53, 54
 - preventing damage 53-55
 - esc key, identifying 13, 26
- F**
 - fan
 - illustrated 33, 44
 - removal 78
 - spare part number 33, 44, 78
 - fingerprint reader
 - illustrated 33, 44
 - spare part number 33, 44
 - fingerprint reader board
 - removal 77
 - spare part numbers 77
 - fingerprint reader, identifying 12, 25
 - fn key, identifying 13, 26
 - fn lock light, identifying 11, 24
- G**
 - graphics, product description 1
 - grounding methods 53-55
 - guidelines
 - packaging 53, 59
 - transporting 53, 59
 - workstation 53
- H**
 - hard drive
 - product description 1
 - specifications 110
 - HDMI port, identifying 6, 19
 - heat sink
 - removal 84
 - spare part numbers 84
 - hinge
 - illustrated 36, 47
 - spare part number 36, 47
 - HP PC Hardware Diagnostics UEFI
 - downloading 107
 - failure ID code 106
 - HP Hotkey Support software 107
 - starting 106, 107
 - using 106
 - HP PC Hardware Diagnostics Windows
 - accessing 104, 105
 - downloading 105
 - failure ID code 104
 - installing 106
 - using 104
 - HP Recovery media
 - recovery 98
 - HP Sure Recover 99

HP Sure Start 113, 117

I

I/O board

illustrated 32, 43

removal 79

spare part number 32, 43, 79

illustrated parts catalog 31, 42

internal microphones,

identifying 8, 21

J

jacks

audio-out (headphone)/audio-in
(microphone) combo 7, 20

network 5, 18

RJ-45 (network) 5, 18

K

keyboard

product description 3

keys

esc 13, 26

fn 13, 26

Windows 13, 26

Windows Copilot 13, 26

L

labels

Bluetooth 15, 28

regulatory 15, 28

serial number 15, 28

service 15, 28

wireless certification 15, 28

WLAN 15, 28

left control zone, identifying 10,
23

left side components 5, 18

lights

camera 8, 21

caps lock 11, 24

fn lock 11, 24

microphone mute 11, 24

power 6, 11, 19, 24

privacy key 11, 24

RJ-45 (network) 5, 18

lights, mute 11, 24

low blue light mode 7, 20

M

memory

nonvolatile 113

volatile 113

memory module

illustrated 33, 44

product description 1

spare part number 33, 44

memory modules

removal 64

spare part numbers 64

microphone

product description 2

microphone mute light,

identifying 11, 24

model name 1

mute light, identifying 11, 24

N

network jack, identifying 5, 18

NFC antenna

spare part number 36, 47

NFC module

removal 80

spare part number 80

nonvolatile memory 113

O

operating system, product
description 3

P

packaging guidelines 53, 59

Plastics Kit, spare part

number 38, 49

pointing device, product

description 3

ports

HDMI 6, 19

product description 2

USB port with HP Sleep and

Charge 6, 19

USB SuperSpeed 5, 18

USB Type-C 6, 19

USB Type-C DisplayPort 6, 19

USB Type-C power

connector 6, 19

power button, identifying 12, 14,
25, 27

power connector

identifying 6, 19

power cord

requirements for all

countries 118

requirements for specific

countries and regions 118

set requirements 118

power cords, spare part

numbers 39, 41, 50, 52

power lights 6, 11, 19, 24

power requirements, product
description 3

primary storage

product description 1

privacy key light 11, 24

processor

product description 1

product description

audio 2

display panel 1

graphics 1

hard drive 1

keyboard 3

memory module 1

microphone 2

operating system 3

pointing device 3

ports 2

power requirements 3

primary storage 1

processors 1

product name 1

RJ-45 (network) jack 2

security 3

sensors 3

serviceability 3

solid-state drive 1

video 2

wireless 2

product name 1

product name and number,
computer 15, 28

R

recovery 97

discs 98

media 98

USB flash drive 98

recovery media 97

creating using HP Cloud

Recovery Download

Tool 97

creating using Windows

tools 97

regulatory information

regulatory label 15, 28

wireless certification

labels 15, 28

- Remote HP PC Hardware
 - Diagnostics UEFI settings
 - customizing 109
 - using 108
- removal and replacement
 - procedures 62, 74
 - solid-state drive 69
- removing personal data from
 - volatile system memory 113
- restoring 97
- restoring and recovery
 - methods 98
- right control zone, identifying 10, 23
- right side components 5, 18
- RJ-45 (network) jack,
 - identifying 5, 18
- RJ-45 (network) jack, product
 - description 2
- RJ-45 (network) lights,
 - identifying 5, 18

S

- Screw Kit content 36, 47
- Screw Kit, spare part number 38, 49
- security cable slot, identifying 5, 18
- security, product description 3
- sensors
 - product description 3
- serial number, computer 15, 28
- service labels, locating 15, 28
- serviceability, product
 - description 3
- setup utility
 - navigating and selecting 100
 - restoring factory settings 100
- SIM card slot, identifying 5, 18
- SIM card, correct size 17, 30, 64
- SIM card, inserting 17, 30, 63, 64
- slots
 - security cable 5, 18
 - SIM card 5, 18
- smart card reader
 - removal 81
 - spare part number 81
- smart card reader, identifying 7, 20
- solid-state drive
 - illustrated 33, 44
 - product description 1
 - removal and replacement 69
 - spare part number 33, 44

- specifications 111
- spare part country codes 95
- speaker
 - illustrated 33, 44
 - spare part number 33, 44
- speakers
 - removal 76
 - spare part numbers 76
- speakers, identifying 14, 27
- special keys, using 13, 26
- specifications
 - computer 110
 - display 110
 - hard drive 110
 - solid-state drive 111
- static electricity 53, 54
- support information 60
- Sure Start
 - using 103
- system board
 - illustrated 32, 43
 - removal 85
 - spare part number 32, 43
 - spare part numbers 85
- system memory, removing
 - personal data from
 - volatile 113
- system restore 98
- system restore point, creating 97

T

- top cover with keyboard
 - illustrated 32, 43
 - spare part numbers 32, 43, 95
- touchpad
 - illustrated 32, 43
 - removal 83
 - settings 9, 22
 - spare part number 32, 43, 83
- touchpad zone, identifying 10, 23
- TPM settings 103
- transporting guidelines 53, 59
- traveling with the computer 15, 28

U

- USB port with HP Sleep and
 - Charge, identifying 6, 19
- USB powered port, identifying 5, 18
- USB Type-C port, identifying 6, 19
- USB Type-C power connector port,
 - identifying 6, 19

V

- vent, identifying 15, 28
- video, product description 2

W

- Windows
 - backup 97
 - recovery media 97
 - system restore point 97
- Windows Copilot key,
 - identifying 13, 26
- Windows key, identifying 13, 26
- Windows tools, using 97
- wireless antennas
 - illustrated 36, 47
 - spare part number 36, 47
- wireless antennas, identifying 8, 21
- wireless certification label 15, 28
- wireless, product description 2
- WLAN antennas, identifying 8, 21
- WLAN device 15, 28
- WLAN label 15, 28
- WLAN module
 - illustrated 33, 44
 - removal 66
 - spare part number 33, 44
 - spare part numbers 66
- workstation guidelines 53
- WWAN antennas, identifying 8, 21
- WWAN module
 - removal 67
 - spare part numbers 67