



Maintenance and Service Guide

SUMMARY

This guide provides information about spare parts, removal and replacement of parts, security, backing up, and more.

Legal information

© Copyright 2023 HP Development Company, L.P.

AMD is a trademark of Advanced Micro Devices, Inc. Bluetooth is a trademark owned by its proprietor and used by HP Inc. under license. Chrome and Google are trademarks of Google LLC. The terms HDMI, HDMI High-Definition Multimedia Interface, and the HDMI Logo are trademarks or registered trademarks of HDMI Licensing Administrator, Inc. Intel, Thunderbolt, and XMM are trademarks of Intel Corporation or its subsidiaries in the U.S. and/or other countries. Realtek™ is a trademark of Realtek Semiconductor Corporation. Microsoft and Windows are either registered trademarks or trademarks of Microsoft Corporation in the United States and/or other countries. USB Type-C and USB-C are registered trademarks of USB Implementers Forum. DisplayPort™ and the DisplayPort™ logo are trademarks owned by the Video Electronics Standards Association (VESA) in the United States and other countries.

The information contained herein is subject to change without notice. The only warranties for HP products and services are set forth in the express warranty statements accompanying such products and services. Nothing herein should be construed as constituting an additional warranty. HP shall not be liable for technical or editorial errors or omissions contained herein.

First Edition: March 2023

Document Part Number: N33040-001

Product notice

This guide describes features that are common to most models. Some features may not be available on your computer.

Not all features are available in all editions or versions of Windows. Systems may require upgraded and/or separately purchased hardware, drivers, software or BIOS update to take full advantage of Windows functionality. Windows is automatically updated, which is always enabled. High-speed internet and Microsoft account required. ISP fees may apply and additional requirements may apply over time for updates. See <http://www.microsoft.com>.

If your product ships with Windows in S

Mode: Windows in S Mode works exclusively with apps from the Microsoft Store within Windows. Certain default settings, features, and apps cannot be changed. Some accessories and apps that are compatible with Windows may not work (including some antivirus, PDF writers, driver utilities, and accessibility apps), and performance may vary, even if you switch out of S Mode. If you switch to Windows, you cannot switch back to S Mode. Learn more at Windows.com/SmodeFAQ.

To access the latest user guides, go to <http://www.hp.com/support>, and follow the instructions to find your product. Then select **Manuals**.

Software terms

By installing, copying, downloading, or otherwise using any software product preinstalled on this computer, you agree to be bound by the terms of the HP End User License Agreement (EULA). If you do not accept these license terms, your sole remedy is to return the entire unused product (hardware and software) within 14 days for a full refund subject to the refund policy of your seller.

For any further information or to request a full refund of the price of the computer, please contact your seller.

Safety warning notice

Reduce the possibility of heat-related injuries or of overheating the computer by following the practices described.

⚠ WARNING! To reduce the possibility of heat-related injuries or of overheating the computer, do not place the computer directly on your lap or obstruct the computer air vents. Use the computer only on a hard, flat surface. Do not allow another hard surface, such as an adjoining optional printer, or a soft surface, such as pillows or rugs or clothing, to block airflow. Also, do not allow the AC adapter to come into contact with the skin or a soft surface, such as pillows or rugs or clothing, during operation. The computer and the AC adapter comply with the user-accessible surface temperature limits defined by applicable safety standards.

Important notice about Customer Self-Repair parts

Your computer includes Customer Self-Repair parts and parts that should be accessed by only an authorized service provider.



IMPORTANT: See "Removal and replacement procedures for Customer Self-Repair parts" for details.

Accessing parts described in "Removal and replacement procedures for authorized service provider parts" can damage the computer or void your warranty.

Table of contents

1 Product description	1
2 Components	5
Locating hardware	5
Locating software	5
Right	5
Left	6
Display	7
Low blue light mode (select products only)	7
Keyboard area	9
Touchpad	9
Touchpad settings	9
Adjusting touchpad settings	9
Turning on the touchpad	9
Touchpad components	9
Lights	10
Power button	11
Bottom	12
Labels	13
3 Illustrated parts catalog	15
Computer major components	15
Brackets	29
Cables	29
Miscellaneous parts	30
4 Removal and replacement procedures preliminary requirements	35
Tools required	35
Service considerations	35
Plastic parts	35
Cables and connectors	35
Drive handling	35
Electrostatic discharge information	36
Generating static electricity	36

Preventing electrostatic damage to equipment.....	37
Personal grounding methods and equipment.....	37
Grounding the work area.....	38
Recommended materials and equipment.....	38
Cleaning your computer.....	39
Enabling HP Easy Clean (select products only).....	39
Removing dirt and debris from your computer.....	39
Cleaning your computer with a disinfectant.....	40
Caring for wood veneer (select products only).....	41
Packaging and transporting guidelines.....	41
Accessing support information.....	42
5 Removal and replacement procedures for authorized service provider parts.....	44
Component replacement procedures.....	44
Preparation for disassembly.....	44
Bottom cover.....	44
Battery.....	45
WWAN module.....	46
WWAN auxiliary antenna.....	48
Solid-state drive.....	49
WLAN module.....	50
Connector board cables.....	52
Connector board.....	52
POGO board cable.....	53
POGO board.....	54
Power connector cable.....	55
Display assembly.....	56
System board.....	59
Heat sink.....	63
Speakers.....	64
RTC battery.....	65
Touchpad cable.....	66
Touchpad.....	67
Top cover webcam.....	68
Top cover webcam cable.....	69
Top cover/keyboard.....	70
6 Using Setup Utility (BIOS).....	72
Starting Setup Utility (BIOS).....	72
Updating Setup Utility (BIOS).....	72
Determining the BIOS version.....	72
Preparing for a BIOS update.....	73
Downloading a BIOS update.....	73
Installing a BIOS update.....	74
7 Computer Setup (BIOS), TPM, and HP Sure Start.....	75
Using Computer Setup.....	75
Navigating and selecting in Computer Setup.....	75

Restoring factory settings in Computer Setup.....	76
Updating the BIOS	76
Determining the BIOS version	76
Preparing for a BIOS update.....	76
Downloading a BIOS update.....	77
Installing a BIOS update.....	77
Changing the boot order using the f9 prompt	77
TPM BIOS settings (select products only)	78
Using HP Sure Start (select products only).....	78
8 Backing up, restoring, and recovering.....	79
Backing up information and creating recovery media.....	79
Using Windows tools for backing up.....	79
Using the HP Cloud Recovery Download Tool to create recovery media (select products only).....	79
Restoring and recovering your system.....	80
Creating a system restore	80
Restoring and recovery methods.....	80
Recovering using HP Recovery media	80
Changing the computer boot order	81
Using HP Sure Recover (select products only).....	81
9 Using HP PC Hardware Diagnostics	82
Using HP PC Hardware Diagnostics Windows (select products only).....	82
Using an HP PC Hardware Diagnostics Windows hardware failure ID code.....	82
Accessing HP PC Hardware Diagnostics Windows.....	82
Accessing HP PC Hardware Diagnostics Windows from HP Support Assistant.....	82
Accessing HP PC Hardware Diagnostics Windows from the Start menu (select products only).....	83
Downloading HP PC Hardware Diagnostics Windows.....	83
Downloading the latest HP PC Hardware Diagnostics Windows version from HP.....	83
Downloading the HP PC Hardware Diagnostics Windows from the Microsoft Store.....	83
Downloading HP Hardware Diagnostics Windows by product name or number (select products only)	84
Installing HP PC Hardware Diagnostics Windows.....	84
Using HP PC Hardware Diagnostics UEFI	84
Using an HP PC Hardware Diagnostics UEFI hardware failure ID code.....	84
Starting HP PC Hardware Diagnostics UEFI.....	85
Downloading HP PC Hardware Diagnostics UEFI to a USB flash drive.....	85
Downloading the latest HP PC Hardware Diagnostics UEFI version.....	85
Downloading HP PC Hardware Diagnostics UEFI by product name or number (select products only)	85
Using Remote HP PC Hardware Diagnostics UEFI settings (select products only).....	86
Downloading Remote HP PC Hardware Diagnostics UEFI.....	86
Downloading the latest Remote HP PC Hardware Diagnostics UEFI version.....	86
Downloading Remote HP PC Hardware Diagnostics UEFI by product name or number.....	86
Customizing Remote HP PC Hardware Diagnostics UEFI settings.....	86
10 Specifications.....	88
Computer specifications.....	88

29.5 cm (11.6 in) display specifications.....	89
11 Statement of memory volatility.....	90
Current BIOS steps	90
Nonvolatile memory usage	92
Questions and answers	95
Using HP Sure Start (select products only).....	96
12 Power cord set requirements.....	97
Requirements for all countries	97
Requirements for specific countries and regions	97
13 Recycling.....	100
Index.....	101

1 Product description

This table provides detailed product information.

Table 1-1 Product components and their descriptions

Category	Description
Product Name	HP Pro x360 Fortis 11 inch G11 Notebook PC
Processors	Intel® N200 processor (8 cores, 6 MB L2 cache, 6 W) Intel N100 processor (4 cores, 6 MB L2 cache, 6 W)
Chipset	Intel integrated soldered-on-chip (SoC)
Display	29.5 cm (11.6 in), liquid crystal display (LCD), high definition (HD) (1366×768), brightview, light-emitting diode (LED), ultra wide viewing area (UWVA), 50% character generation (CG), embedded DisplayPort® (eDP), touchscreen display panel with slim bezel; typical brightness: 250 nits 29.5 cm (11.6 in), LCD, HD (1366×768), brightview, LED, super vertical alignment (SVA), 45% CG, eDP, touchscreen display panel with slim bezel; typical brightness: 250 nits
Memory	Integrated system memory supporting up to 32 GB of RAM in the following configurations: <ul style="list-style-type: none">• 32 GB, 1.2 v, internal controller (32 GB × 16)• 16 GB, 1.2 v, internal controller (16 GB × 16)• 8 GB, 1.2 v, internal controller (8 GB × 16) Double data rate (DDR4)-3200
Storage: eMMC	Support for 64 GB, MO-76, embedded MultiMediaCard (eMMC), MMC v.5.0 internal system storage
Storage: solid-state drive	Support for 256 GB or 128 GB, 2230, peripheral component interconnect express (PCIe), nonvolatile memory express (NVMe), value solid-state drive system storage (not available on computer models equipped with eMMC storage)
Audio and video	Support for dual speakers Support for integrated, HD, USB 2.0, fixed, 720p webcam Dual-array microphone integrated with webcam

Table 1-1 Product components and their descriptions (continued)

Category	Description	
Wireless	Wireless Local Area Network (WLAN)	
	Intel AX211 Wi-Fi® 6E + Bluetooth® 5.3 M.2 2230 160 MHz CNVi worldwide WLAN module	
	Realtek™ 8852CE Wi-Fi 6E + Bluetooth 5.3 M.2 2230 PCI-e + USB WW WLAN module	
	Internal wireless network controller: RTK GBE Ethernet controller (non-DASH QFN32) RTL8111HSH-CG	
	Wireless Wide Area Network (WWAN): Intel XMM® 7560 R+ LTE-Advanced Pro (Cat 16) WWAN module	
	WWAN service providers: AT&T and Verizon	
Ports	Hot plug/unplug and autodetect for correct output to wide-aspect vs. standard-aspect video	
	<ul style="list-style-type: none"> • Audio-out (headphone)/Audio-in (microphone) combo jack • High-definition multimedia interface (HDMI®) port • Power connector • RJ-45 (network) jack • USB SuperSpeed 5, 10, or 20 Gbps port • USB Type-C® power connector and SuperSpeed 5, 10, or 20 Gbps port with DisplayPort™ output 	
	Keyboard/pointing devices	Keyboard: Island-style, spill-resistant, notebook PC keyboard with touchpad in emerald green and jet black finishes
		Touchpad
		Touchpad with image sensor
		Multitouch gestures enabled
		Precision touchpad support
	Taps enabled as default	
Digital pen	HP slim rechargeable digital pen	
Power requirements	Battery: 3 cell, 42 WHr, Long Life, polymer battery	
	HP Fast Charge Technology	
	AC adapter:	
	HP Smart Adapter 65 W (non-Power Factor Correction (non-PFC), EM, 4.5 mm, slim)	
	HP Smart Adapter 45 W (non-PFC, standard right angle barrel, 4.5 mm, slim, C8 connector [2 prong])	
	HP Smart Adapter 45 W (non-PFC, standard straight barrel, 4.5 mm, slim)	
	HP USB Type-C AC adapter 45 W (non-PFC, standard straight barrel, 1.8 m [6.0 ft], slim)	
	Power cord:	
	<ul style="list-style-type: none"> • C5, 1.0 m (3.3 ft), conventional with sticker • C5, 1.0 m (3.3 ft), conventional with sticker, HF • C7, 1.0 m (3.3 ft), conventional with tag 	
Security	HP Essential combination nano cable lock	
	HP combination nano cable lock	

Table 1-1 Product components and their descriptions (continued)

Category	Description
Operating system	FreeDOS
	Windows® 10 Enterprise 64
	Windows 10 Enterprise 64 LTSC 2109 (21H2)
	Windows 11 Enterprise 64
	Windows 11 Home 64 Chinese Market CPPP
	Windows 11 Home 64 High-end Chinese Market CPPP
	Windows 11 Home 64 Plus
	Windows 11 Home 64 Plus Africa Market PPP
	Windows 11 Home 64 Plus APAC EM PPP
	Windows 11 Home 64 Plus India Market PPP
	Windows 11 Home 64 Plus Indonesia Market PPP
	Windows 11 Home 64 Plus
	Windows 11 Home 64 Single Language
	Windows 11 Home 64 Single Language Africa Market PPP
	Windows 11 Home 64 Single Language APAC EM PPP
	Windows 11 Home 64 Single Language India Market PPP
	Windows 11 Home 64 Single Language Indonesia Market PPP
	Windows 11 Home 64 StF MSNA for Higher Education
	Windows 11 Home 64 StF MSNA for Higher Education Strategic
	Windows 11 Professional 64
	Windows 11 Professional 64 Chinese Market
	Windows 11 Professional 64 Downgrade Windows 10 Professional 64
	Windows 11 Professional 64 Downgrade Windows 10 Professional 64 Chinese Market
	Windows 11 Professional 64 Downgrade Windows 10 Professional 64 Entry
	Windows 11 Professional 64 Downgrade Windows 10 Professional 64 Entry Chinese Market
	Windows 11 Professional 64 Downgrade Windows 10 Professional 64 StF MSNA Entry
	Windows 11 Professional 64 Downgrade Windows 10 Professional 64 StF MSNA Entry Emerging Market
	Windows 11 Professional 64 Downgrade Windows 10 Professional 64 StF MSNA Standard
	Windows 11 Professional 64 Downgrade Windows 10 Professional 64 StF MSNA Strategic
	Windows 11 Professional 64 Entry
	Windows 11 Professional 64 Entry Chinese Market
	Windows 11 Professional 64 StF MSNA Entry
	Windows 11 Professional 64 StF MSNA Entry Emerging Market
Windows 11 Professional 64 StF MSNA Standard	

Table 1-1 Product components and their descriptions (continued)

Category	Description
	Windows 11 Professional 64 StF MSNA Strategic
	Windows 11 SE 64
Serviceability	End user replaceable parts: AC adapter and power cord

2 Components

Your computer features top-rated components. This chapter provides details about your components, where they are located, and how they work.

Locating hardware

Use these instructions to find out what hardware is installed on your computer.

- Select the **Search** icon in the taskbar, type `device manager` in the search box, and then select the **Device Manager** app.

A list displays all the devices installed on your computer.

For information about system hardware components and the system BIOS version number, press `fn+esc` (select products only).

Locating software

Use these instructions to find out what software is installed on your computer:

- Right-click the **Start** button, and then select **Apps and Features**.

Right

Use the illustration and table to identify the components on the right side of the computer.

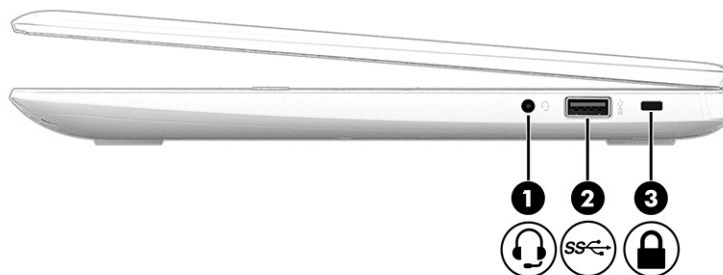





Table 2-1 Right-side components and their descriptions

Component	Description
<p>(1)  Audio-out (headphone)/Audio-in (microphone) combo jack</p>	<p>Connects optional powered stereo speakers, headphones, earbuds, a headset, or a television audio cable. Also connects an optional headset microphone. This jack does not support optional standalone microphones.</p> <p>WARNING! To reduce the risk of personal injury, adjust the volume before putting on headphones, earbuds, or a headset. For additional safety information, see the <i>Regulatory, Safety, and Environmental Notices</i>.</p> <p>To access this guide:</p> <ul style="list-style-type: none"> Select the Search icon in the taskbar, type HP Documentation in the search box, and then select HP Documentation. <p>NOTE: When a device is connected to the jack, the computer speakers are disabled.</p>
<p>(2)  USB SuperSpeed 5, 10, or 20 Gbps port</p>	<p>Connects a USB device, provides high-speed data transfer, and (for select products) charges small devices (such as a smartphone) when the computer is on or in Sleep mode.</p> <p>NOTE: Use a standard USB Type-A charging cable or cable adapter (purchased separately) when charging a small external device.</p>
<p>(3)  Security cable slot</p>	<p>Attaches an optional security cable to the computer.</p> <p>NOTE: The security cable is designed to act as a deterrent, but it might not prevent the computer from being mishandled or stolen.</p>

Left

Use the illustration and table to identify the components on the left side of the computer.

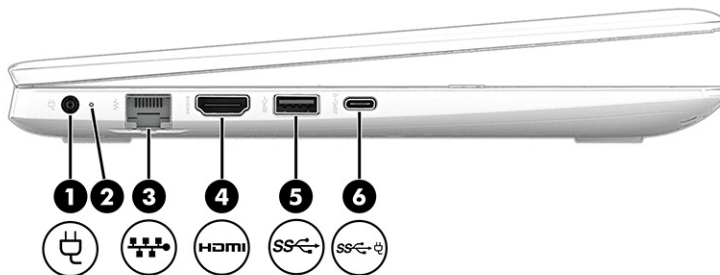





Table 2-2 Left-side components and their descriptions

Component	Description
<p>(1)  Power connector</p>	<p>Connects an AC adapter.</p>

Table 2-2 Left-side components and their descriptions (continued)

Component	Description
(2) Power light	<ul style="list-style-type: none"> On: The computer is on. Blinking (select products only): The computer is in the Sleep state, a power-saving state. The computer shuts off power to the display and other unnecessary components. Off: Depending on your computer model, the computer is off, in Hibernation, or in Sleep. Hibernation is the power-saving state that uses the least amount of power.
(3)  RJ-45 (network) jack/status lights	<p>Connects a network cable.</p> <ul style="list-style-type: none"> Green (left): The network is connected. Amber (right): Activity is occurring on the network.
(4)  HDMI® port	<p>Connects an optional video or audio device, such as a high-definition television, any compatible digital or audio component, or a high-speed High Definition Multimedia Interface (HDMI) device.</p>
(5)  USB SuperSpeed 5, 10, or 20 Gbps port	<p>Connects a USB device, provides high-speed data transfer, and (for select products) charges small devices (such as a smartphone) when the computer is on or in Sleep mode.</p> <p>NOTE: Use a standard USB Type-A charging cable or cable adapter (purchased separately) when charging a small external device.</p>
(6)  USB Type-C® power connector and SuperSpeed 5, 10, or 20 Gbps port with DisplayPort™ output	<p>Connects an AC adapter that has a USB Type-C connector, supplying power to the computer and, if needed, charging the computer battery.</p> <p>- and -</p> <p>Connects a USB device, provides high-speed data transfer, and (for select products) charges small devices (such as a smartphone) when the computer is on or in Sleep mode.</p> <p>NOTE: Use a standard USB Type-C charging cable or cable adapter (purchased separately) when charging a small external device.</p> <p>- and -</p> <p>Connects a display device that has a USB Type-C connector, providing DisplayPort output.</p>

Display

Use the illustration and table to identify the display components.

Low blue light mode (select products only)

Your computer display is shipped from the factory in low blue light mode for improved eye comfort and safety. Also, blue light mode automatically adjusts blue light emissions when you are using the computer at night or for reading.

⚠ WARNING! To reduce the risk of serious injury, read the *Safety & Comfort Guide*. It describes proper workstation setup and proper posture, health, and work habits for computer users. The *Safety & Comfort Guide* also provides important electrical and mechanical safety information. The *Safety & Comfort Guide* is available on the web at <http://www.hp.com/ergo>.

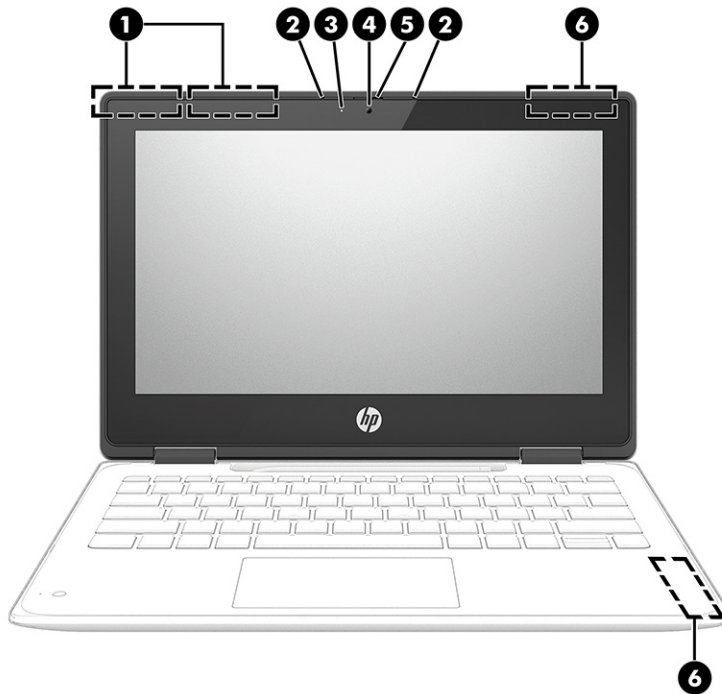

Table 2-3 Display components and their descriptions

Component	Description
(1) WLAN antennas (2)*	Send and receive wireless signals to communicate with wireless local area networks (WLANs).
(2) Internal microphones (2)	Record sound.
(3) Camera light	On: One or more cameras are in use.
(4) Camera	Allows you to video chat, record video, and record still images. Some cameras also allow a facial recognition logon to Windows, instead of a password logon. NOTE: Camera functions vary depending on the camera hardware and software installed on your product.
(5) Camera privacy cover (select products only)	By default, the camera lens is uncovered, but you can slide the camera privacy cover to block the camera's view. To use the camera, slide the camera privacy cover in the opposite direction to reveal the lens. NOTE: If you have both front-facing and rear-facing cameras, when one camera lens is revealed and ready to use, the other is concealed.
(6) WWAN antennas (2)*	Send and receive wireless signals to communicate with wireless wide area networks (WWANs).

Table 2-3 Display components and their descriptions (continued)

Component	Description
	<p>*The antennas are not visible from the outside of the computer. For optimal transmission, keep the areas immediately around the antennas free from obstructions.</p> <p>For wireless regulatory notices, see the section of the <i>Regulatory, Safety, and Environmental Notices</i> that applies to your country or region.</p> <p>To access this guide:</p> <ul style="list-style-type: none">■ Select the Search icon in the taskbar, type <code>HP Documentation</code> in the search box, and then select HP Documentation.

Keyboard area

Keyboards can vary by language.

Touchpad

The touchpad settings and components are described here.

Touchpad settings

You learn how to adjust the touchpad settings and components here.

Adjusting touchpad settings

Use these steps to adjust touchpad settings and gestures.

1. Select the **Search** icon (select products only) in the taskbar, type `touchpad settings` in the search box, and then press `enter`.
2. Choose a setting.

Turning on the touchpad

Follow these steps to turn on the touchpad.

1. Select the **Search** icon (select products only) in the taskbar, type `touchpad settings` in the search box, and then press `enter`.
2. Using an external mouse, click the **Touchpad** button.

If you are not using an external mouse, press the `Tab` key repeatedly until the pointer rests on the **touchpad** button. Then press the `spacebar` to select the button.

Touchpad components

Use the illustration and table to identify the pen garage and touchpad components.

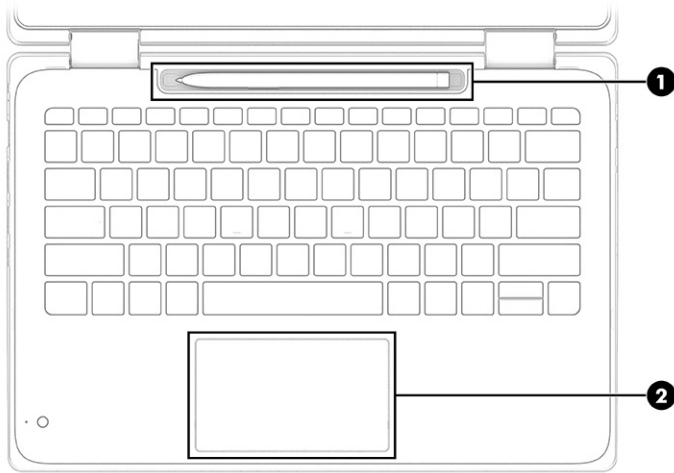

Table 2-4 Touchpad components and their descriptions

Component		Description
(1)	Pen garage (select products only)	Stores the computer digital pen.
(2)	Touchpad zone	Reads your finger gestures to move the pointer or activate items on the screen.

Lights

Use the illustration and table to identify the lights on the computer.

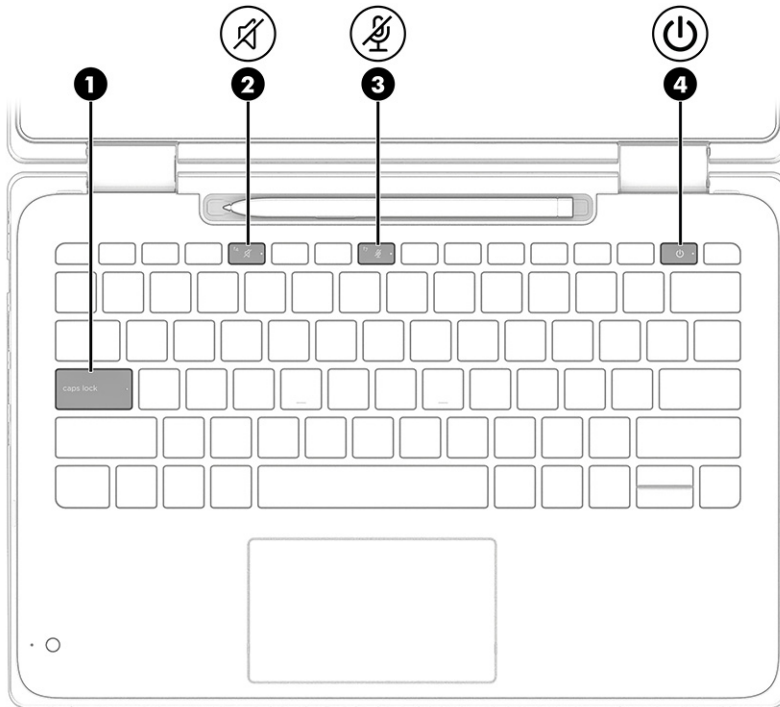





Table 2-5 Lights and their descriptions

Component		Description
(1)	Caps lock light	On: Caps lock is on, which switches the key input to all capital letters.
(2)	 Mute light	<ul style="list-style-type: none">• On: Computer sound is off.• Off: Computer sound is on.
(3)	 Microphone mute light	<ul style="list-style-type: none">• On: Microphone is off.• Off: Microphone is on.
(4)	 Power light	<ul style="list-style-type: none">• On: The computer is on.• Blinking (select products only): The computer is in the Sleep state, a power-saving state. The computer shuts off power to the display and other unnecessary components.• Off: Depending on your computer model, the computer is off, in Hibernation, or in Sleep. Hibernation is the power-saving state that uses the least amount of power.

Power button

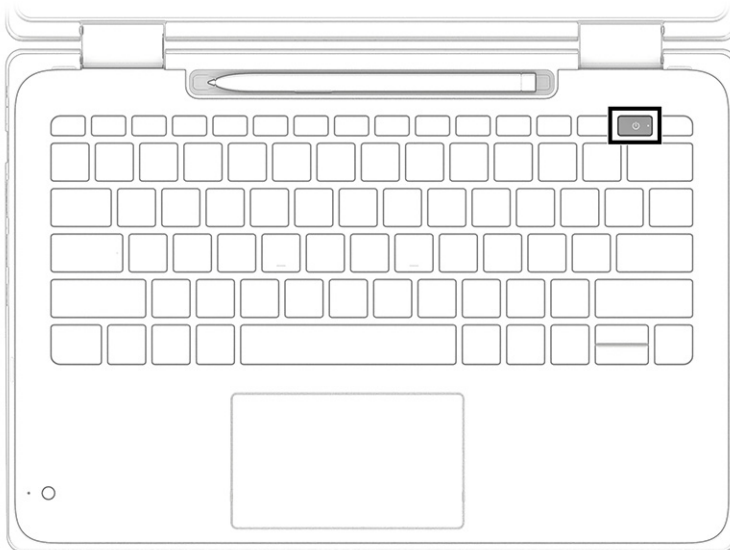



Table 2-6 Power button and its description

Component	Description
 Power button	<ul style="list-style-type: none">• When the computer is off, press the button briefly to turn on the computer.• When the computer is on, press the button briefly to initiate Sleep.• When the computer is in the Sleep state, press the button briefly to exit Sleep (select products only).• When the computer is in Hibernation, press the button briefly to exit Hibernation. <p>IMPORTANT: Pressing and holding down the power button results in the loss of unsaved information.</p> <p>If the computer has stopped responding and shutdown procedures are ineffective, press and hold the power button for at least 4 seconds to turn off the computer.</p> <p>To learn more about your power settings, use the Power icon.</p> <ul style="list-style-type: none">• Right-click the Power icon , and then select Power and sleep settings.

Bottom

Use the illustration and table to identify the bottom components.

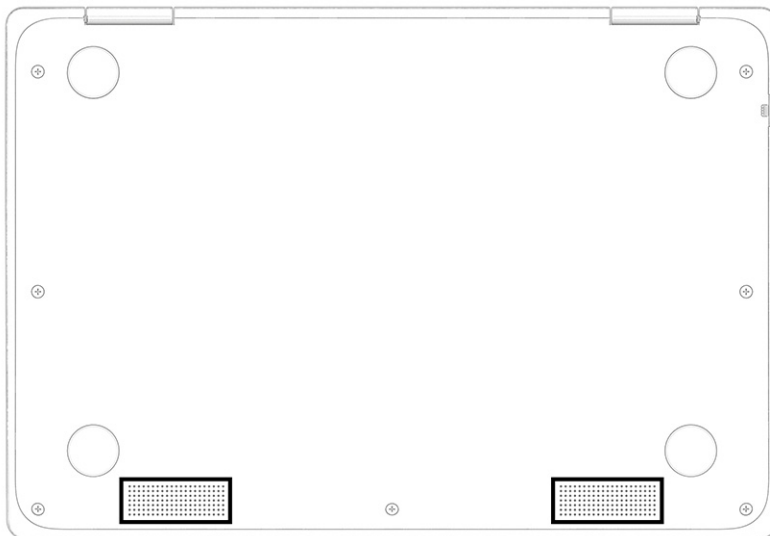

Table 2-7 Bottom components and their descriptions

Component	Description
Speakers	Produce sound.

Labels

The labels affixed to the computer provide information that you might need when you troubleshoot system problems or travel internationally with the computer. Labels can be in paper form or imprinted on the product.

IMPORTANT: Check the following locations for the labels described in this section: the bottom of the computer, inside the battery bay, under the service door, on the back of the display, or on the bottom of a tablet kickstand.

- Service label—Provides important information to identify your computer. When contacting support, you may be asked for the serial number, the product number, or the model number. Locate this information before you contact support.

Your service label will resemble one of the following examples. Refer to the illustration that most closely matches the service label on your computer.

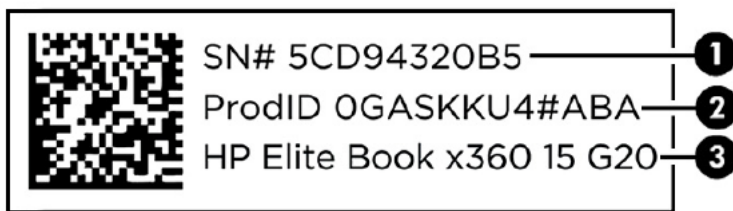

Table 2-8 Service label components and their descriptions

Component	
(1)	Serial number
(2)	Product ID
(3)	HP product name

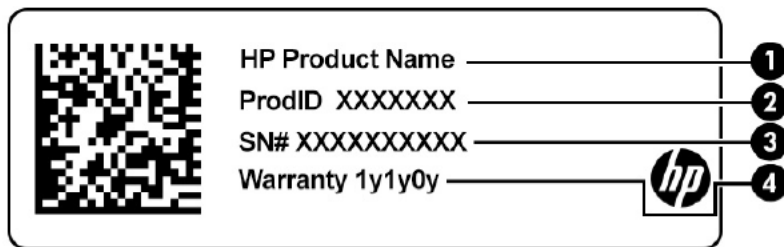

Table 2-9 Service label components and their descriptions

Component	
(1)	HP product name
(2)	Product ID
(3)	Serial number

Table 2-9 Service label components and their descriptions (continued)

Component	
(4)	Warranty period

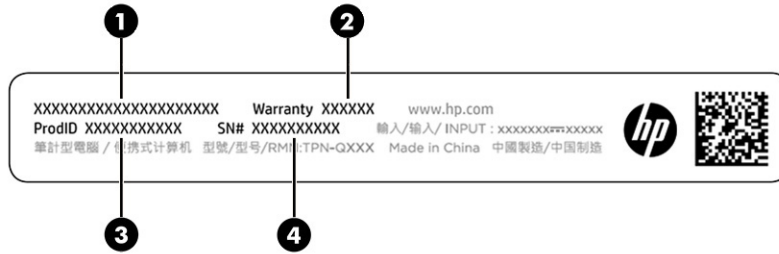

Table 2-10 Service label components and their descriptions

Component	
(1)	HP product name
(2)	Warranty period
(3)	Product ID
(4)	Serial number

- Regulatory labels—Provide regulatory information about the computer.
- Wireless certification labels—Provide information about optional wireless devices and the approval markings for the countries or regions in which the devices have been approved for use.

3 Illustrated parts catalog

Use this table to determine the spare parts that are available for the computer.

Computer major components

To identify the computer major components, use this illustration and table.

 **NOTE:** HP continually improves and changes product parts. For complete and current information about supported parts for your computer, go to <http://partsurfer.hp.com>, select your country or region, and then follow the on-screen instructions.

 **NOTE:** Details about your computer, including model, serial number, product key, and length of warranty, are on the service tag at the bottom of your computer.

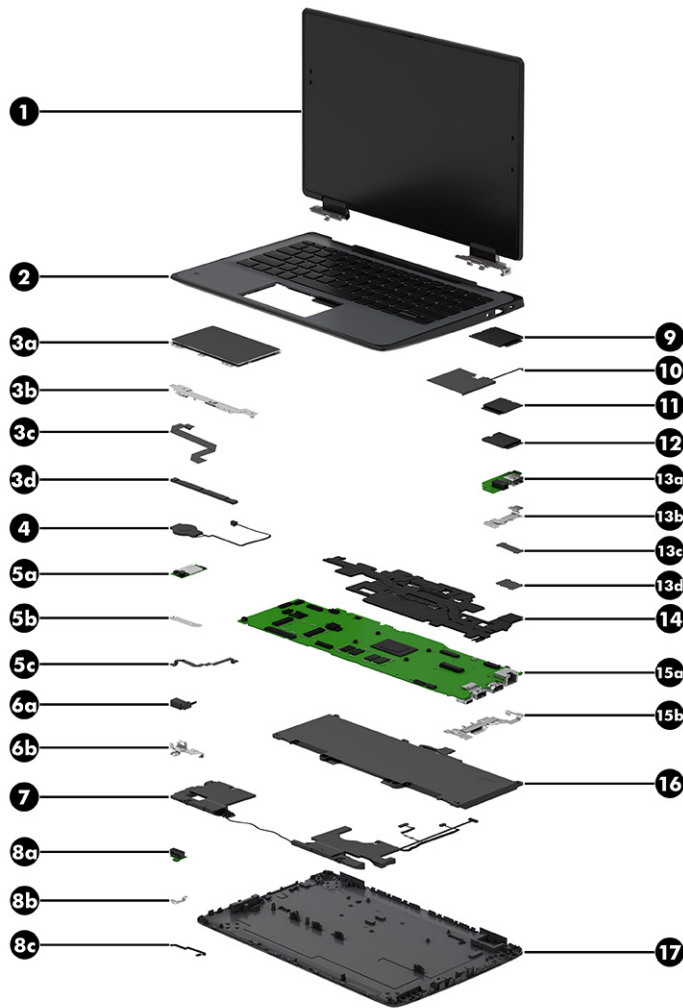

Table 3-1 Computer major component descriptions and part numbers

Item	Component	Spare part number
(1)	Display assembly: The display assembly is available only as a whole unit.	
	29.5 cm (11.6 in), UWVA, HD, Brightview, touchscreen display assembly in emerald green finish for use only on computer models equipped with WWAN capability (includes WWAN antenna cables and transceivers); typical brightness: 250 nits	N35464-001
	29.5 cm (11.6 in), UWVA, HD, Brightview, touchscreen display assembly in jet black finish for use only on computer models equipped with WWAN capability (includes WWAN antenna cables and transceivers); typical brightness: 250 nits	N35465-001
	29.5 cm (11.6 in), UWVA, HD, Brightview, touchscreen display assembly in emerald green finish for use only on computer models equipped without WWAN capability (includes WLAN antenna cables and transceivers); typical brightness: 250 nits	N35462-001
	29.5 cm (11.6 in), UWVA, HD, Brightview, touchscreen display assembly in jet black finish for use only on computer models equipped without WWAN capability (includes WLAN antenna cables and transceivers); typical brightness: 250 nits	N35463-001
	29.5 cm (11.6 in), SVA, HD, Brightview, touchscreen display assembly in emerald green finish for use only on computer models equipped with WWAN capability (includes WWAN antenna cables and transceivers); typical brightness: 250 nits	N35460-001

Table 3-1 Computer major component descriptions and part numbers (continued)

Item	Component	Spare part number
	29.5 cm (11.6 in), SVA, HD, Brightview, touchscreen display assembly in jet black finish for use only on computer models equipped with WWAN capability (includes WWAN antenna cables and transceivers); typical brightness: 250 nits	N35461-001
	29.5 cm (11.6 in), SVA, HD, Brightview, touchscreen display assembly in emerald green finish for use only on computer models equipped without WWAN capability (includes WLAN antenna cables and transceivers); typical brightness: 250 nits	N35458-001
	29.5 cm (11.6 in), SVA, HD, Brightview, touchscreen display assembly in jet black finish for use only on computer models equipped without WWAN capability (includes WLAN antenna cables and transceivers); typical brightness: 250 nits	N35459-001
(2)	Top cover/keyboard with clickpad, pen garage, and top cover webcam in emerald green finish (spill-resistant, includes keyboard cable)	N37144-xxx
	For use in country or region:	Country code:
	For use in Belgium	-A41
	For use in Bulgaria	-261
	For use in the Czech Republic and Slovakia	-FL1
	For use in Denmark	-081
	For use in Denmark, Finland, and Norway	-DH1
	For use in France	-051
	For use in French Canada	-DB1
	For use in Germany	-041
	NOTE: The German keyboard spare part number may vary by computer model.	
	For use in Greece	-151
	For use in Hungary	-211
	For use in Iceland	-DD1
	For use in India	-D61
	For use in Israel	-BB1
	For use in Italy	-061
	For use in Japan	-291
	For use in Kazakhstan	-DF1
	For use in Latin America	-161
	For use in the Netherlands	-B31
	For use in North Africa	-FP1
	For use in Norway	-091
	For use in Portugal	-131
	For use in Romania	-271
	For use in Russia	-251
	For use in Saudi Arabia	-171

Table 3-1 Computer major component descriptions and part numbers (continued)

Item	Component	Spare part number
	For use in Slovenia	-BA1
	For use in South Korea	-AD1
	For use in Spain	-071
	For use in Sweden and Finland	-B71
	For use in Switzerland	-BG1
	For use in Taiwan	-AB1
	For use in Thailand	-281
	For use in Turkey	-141
	For use in Ukraine	-BD1
	For use in the United Kingdom	-031
	For use in the United States	-001
(2)	Top cover/keyboard with clickpad, pen garage, and top cover webcam in jet black finish (spill-resistant, includes keyboard cable)	N37148-xxx
	For use in country or region:	Country code:
	For use in Belgium	-A41
	For use in Bulgaria	-261
	For use in the Czech Republic and Slovakia	-FL1
	For use in Denmark	-081
	For use in Denmark, Finland, and Norway	-DH1
	For use in France	-051
	For use in French Canada	-DB1
	For use in Germany	-041
	NOTE: The German keyboard spare part number may vary by computer model.	
	For use in Greece	-151
	For use in Hungary	-211
	For use in Iceland	-DD1
	For use in India	-D61
	For use in Israel	-BB1
	For use in Italy	-061
	For use in Japan	-291
	For use in Kazakhstan	-DF1
	For use in Latin America	-161
	For use in the Netherlands	-B31
	For use in North Africa	-FP1

Table 3-1 Computer major component descriptions and part numbers (continued)

Item	Component	Spare part number
	For use in Norway	-091
	For use in Portugal	-131
	For use in Romania	-271
	For use in Russia	-251
	For use in Saudi Arabia	-171
	For use in Slovenia	-BA1
	For use in South Korea	-AD1
	For use in Spain	-071
	For use in Sweden and Finland	-B71
	For use in Switzerland	-BG1
	For use in Taiwan	-AB1
	For use in Thailand	-281
	For use in Turkey	-141
	For use in Ukraine	-BD1
	For use in the United Kingdom	-031
	For use in the United States	-001
(2)	Top cover/keyboard with clickpad and pen garage in emerald green finish (spill-resistant, includes keyboard cable)	N37145-xxx
	For use in country or region:	Country code:
	For use in Belgium	-A41
	For use in Bulgaria	-261
	For use in the Czech Republic and Slovakia	-FL1
	For use in Denmark	-081
	For use in Denmark, Finland, and Norway	-DH1
	For use in France	-051
	For use in French Canada	-DB1
	For use in Germany	-041
	NOTE: The German keyboard spare part number may vary by computer model.	
	For use in Greece	-151
	For use in Hungary	-211
	For use in Iceland	-DD1
	For use in India	-D61
	For use in Israel	-BB1
	For use in Italy	-061

Table 3-1 Computer major component descriptions and part numbers (continued)

Item	Component	Spare part number
	For use in Japan	-291
	For use in Kazakhstan	-DF1
	For use in Latin America	-161
	For use in the Netherlands	-B31
	For use in North Africa	-FP1
	For use in Norway	-091
	For use in Portugal	-131
	For use in Romania	-271
	For use in Russia	-251
	For use in Saudi Arabia	-171
	For use in Slovenia	-BA1
	For use in South Korea	-AD1
	For use in Spain	-071
	For use in Sweden and Finland	-B71
	For use in Switzerland	-BG1
	For use in Taiwan	-AB1
	For use in Thailand	-281
	For use in Turkey	-141
	For use in Ukraine	-BD1
	For use in the United Kingdom	-031
	For use in the United States	-001
(2)	Top cover/keyboard with clickpad and pen garage in jet black finish (spill-resistant, includes keyboard cable)	N37149-xxx
	For use in country or region:	Country code:
	For use in Belgium	-A41
	For use in Bulgaria	-261
	For use in the Czech Republic and Slovakia	-FL1
	For use in Denmark	-081
	For use in Denmark, Finland, and Norway	-DH1
	For use in France	-051
	For use in French Canada	-DB1
	For use in Germany	-041
	NOTE: The German keyboard spare part number may vary by computer model.	
	For use in Greece	-151

Table 3-1 Computer major component descriptions and part numbers (continued)

Item	Component	Spare part number
	For use in Hungary	-211
	For use in Iceland	-DD1
	For use in India	-D61
	For use in Israel	-BB1
	For use in Italy	-061
	For use in Japan	-291
	For use in Kazakhstan	-DF1
	For use in Latin America	-161
	For use in the Netherlands	-B31
	For use in North Africa	-FP1
	For use in Norway	-091
	For use in Portugal	-131
	For use in Romania	-271
	For use in Russia	-251
	For use in Saudi Arabia	-171
	For use in Slovenia	-BA1
	For use in South Korea	-AD1
	For use in Spain	-071
	For use in Sweden and Finland	-B71
	For use in Switzerland	-BG1
	For use in Taiwan	-AB1
	For use in Thailand	-281
	For use in Turkey	-141
	For use in Ukraine	-BD1
	For use in the United Kingdom	-031
	For use in the United States	-001
(2)	Top cover/keyboard with clickpad and top cover webcam in emerald green finish (spill-resistant, includes keyboard cable)	N37143-xxx
	For use in country or region:	Country code:
	For use in Belgium	-A41
	For use in Bulgaria	-261
	For use in the Czech Republic and Slovakia	-FL1
	For use in Denmark	-081
	For use in Denmark, Finland, and Norway	-DH1
	For use in France	-051

Table 3-1 Computer major component descriptions and part numbers (continued)

Item	Component	Spare part number
	For use in French Canada	-DB1
	For use in Germany	-041
	NOTE: The German keyboard spare part number may vary by computer model.	
	For use in Greece	-151
	For use in Hungary	-211
	For use in Iceland	-DD1
	For use in India	-D61
	For use in Israel	-BB1
	For use in Italy	-061
	For use in Japan	-291
	For use in Kazakhstan	-DF1
	For use in Latin America	-161
	For use in the Netherlands	-B31
	For use in North Africa	-FP1
	For use in Norway	-091
	For use in Portugal	-131
	For use in Romania	-271
	For use in Russia	-251
	For use in Saudi Arabia	-171
	For use in Slovenia	-BA1
	For use in South Korea	-AD1
	For use in Spain	-071
	For use in Sweden and Finland	-B71
	For use in Switzerland	-BG1
	For use in Taiwan	-AB1
	For use in Thailand	-281
	For use in Turkey	-141
	For use in Ukraine	-BD1
	For use in the United Kingdom	-031
	For use in the United States	-001
(2)	Top cover/keyboard with clickpad and top cover webcam in jet black finish (spill-resistant, includes keyboard cable)	N37146-xxx
	For use in country or region:	Country code:
	For use in Belgium	-A41

Table 3-1 Computer major component descriptions and part numbers (continued)

Item	Component	Spare part number
	For use in Bulgaria	-261
	For use in the Czech Republic and Slovakia	-FL1
	For use in Denmark	-081
	For use in Denmark, Finland, and Norway	-DH1
	For use in France	-051
	For use in French Canada	-DB1
	For use in Germany	-041
	NOTE: The German keyboard spare part number may vary by computer model.	
	For use in Greece	-151
	For use in Hungary	-211
	For use in Iceland	-DD1
	For use in India	-D61
	For use in Israel	-BB1
	For use in Italy	-061
	For use in Japan	-291
	For use in Kazakhstan	-DF1
	For use in Latin America	-161
	For use in the Netherlands	-B31
	For use in North Africa	-FP1
	For use in Norway	-091
	For use in Portugal	-131
	For use in Romania	-271
	For use in Russia	-251
	For use in Saudi Arabia	-171
	For use in Slovenia	-BA1
	For use in South Korea	-AD1
	For use in Spain	-071
	For use in Sweden and Finland	-B71
	For use in Switzerland	-BG1
	For use in Taiwan	-AB1
	For use in Thailand	-281
	For use in Turkey	-141
	For use in Ukraine	-BD1
	For use in the United Kingdom	-031

Table 3-1 Computer major component descriptions and part numbers (continued)

Item	Component	Spare part number
	For use in the United States	-001
(2)	Top cover/keyboard with clickpad in emerald green finish (spill-resistant, includes keyboard cable)	N37142-xxx
	For use in country or region:	Country code:
	For use in Belgium	-A41
	For use in Bulgaria	-261
	For use in the Czech Republic and Slovakia	-FL1
	For use in Denmark	-081
	For use in Denmark, Finland, and Norway	-DH1
	For use in France	-051
	For use in French Canada	-DB1
	For use in Germany	-041
	NOTE: The German keyboard spare part number may vary by computer model.	
	For use in Greece	-151
	For use in Hungary	-211
	For use in Iceland	-DD1
	For use in India	-D61
	For use in Israel	-BB1
	For use in Italy	-061
	For use in Japan	-291
	For use in Kazakhstan	-DF1
	For use in Latin America	-161
	For use in the Netherlands	-B31
	For use in North Africa	-FP1
	For use in Norway	-091
	For use in Portugal	-131
	For use in Romania	-271
	For use in Russia	-251
	For use in Saudi Arabia	-171
	For use in Slovenia	-BA1
	For use in South Korea	-AD1
	For use in Spain	-071
	For use in Sweden and Finland	-B71
	For use in Switzerland	-BG1

Table 3-1 Computer major component descriptions and part numbers (continued)

Item	Component	Spare part number
	For use in Taiwan	-AB1
	For use in Thailand	-281
	For use in Turkey	-141
	For use in Ukraine	-BD1
	For use in the United Kingdom	-031
	For use in the United States	-001
(2)	Top cover/keyboard with clickpad in jet black finish (spill-resistant, includes keyboard cable)	N37147-xxx
	For use in country or region:	Country code:
	For use in Belgium	-A41
	For use in Bulgaria	-261
	For use in the Czech Republic and Slovakia	-FL1
	For use in Denmark	-081
	For use in Denmark, Finland, and Norway	-DH1
	For use in France	-051
	For use in French Canada	-DB1
	For use in Germany	-041
	NOTE: The German keyboard spare part number may vary by computer model.	
	For use in Greece	-151
	For use in Hungary	-211
	For use in Iceland	-DD1
	For use in India	-D61
	For use in Israel	-BB1
	For use in Italy	-061
	For use in Japan	-291
	For use in Kazakhstan	-DF1
	For use in Latin America	-161
	For use in the Netherlands	-B31
	For use in North Africa	-FP1
	For use in Norway	-091
	For use in Portugal	-131
	For use in Romania	-271
	For use in Russia	-251
	For use in Saudi Arabia	-171
	For use in Slovenia	-BA1

Table 3-1 Computer major component descriptions and part numbers (continued)

Item	Component	Spare part number
	For use in South Korea	-AD1
	For use in Spain	-071
	For use in Sweden and Finland	-B71
	For use in Switzerland	-BG1
	For use in Taiwan	-AB1
	For use in Thailand	-281
	For use in Turkey	-141
	For use in Ukraine	-BD1
	For use in the United Kingdom	-031
	For use in the United States	-001
(3a)	Touchpad: NOTE: The touchpad spare part kit does not include the touchpad bracket or the touchpad cable. The touchpad bracket is included in the Bracket Kit, spare part number N37486-001. The touchpad cable is included in the Cable Kit, spare part number N05697-001.	
	In emerald green finish	N37488-001
	In jet black finish	N00442-001
(3b)	Touchpad bracket: The touchpad bracket is included in the Bracket Kit, spare part number N37486-001.	
(3c)	Touchpad cable: The touchpad cable is included in the Cable Kit, spare part number N05697-001.	
(3d)	Touchpad rubber pad: The touchpad cable is included in the Touchpad Rubber Kit, spare part number N08506-001.	
(4)	RTC battery (includes cable and double-sided adhesive)	N43797-001
(5a)	Top cover webcam NOTE: The top cover webcam spare part kit includes the top cover webcam bracket or top cover webcam cable. The top cover webcam bracket is included in the Bracket Kit, spare part number N37486-001. The top cover webcam cable cable is included in the Cable Kit, spare part number N05697-001.	N00444-001
(5b)	Top cover webcam bracket: The top cover webcam bracket is included in the Bracket Kit, spare part number N37486-001.	
(5c)	Top cover webcam cable: The top cover webcam cable is included in the Cable Kit, spare part number N05697-001.	
(6a)	Power connector cable (includes cable and connector): NOTE: The power connector cable spare part kit does not include the power connector cable bracket. The power connector cable bracket is included in the Bracket Kit, spare part number N37486-001.	N02674-001
(6b)	Power connector cable bracket: The power connector cable bracket is included in the Bracket Kit, spare part number N37486-001.	
(7)	Speakers (includes left and right speakers, cables, and four rubber isolators)	N02671-001
(8a)	POGO board NOTE: The POGO board spare part kit does not include the POGO board bracket or POGO board cable. The POGO board bracket is included in the Bracket Kit, spare part number N37486-001. The POGO board cable is included in the Cable Kit, spare part number N05697-001.	N02670-001

Table 3-1 Computer major component descriptions and part numbers (continued)

Item	Component	Spare part number
(8b)	POGO board bracket: The POGO board bracket is included in the Bracket Kit, spare part number N37486-001.	
(8c)	POGO board cable: The POGO board cable is included in the Cable Kit, spare part number N05697-001.	
(9)	Intel XMM 7560 R+ LTE-Advanced Pro (Cat 16) WWAN module	N37489-001
	WWAN module cover (not illustrated, includes double-sided adhesive): This component is included in the Plastics Kit, spare part number N37487-001.	
(10)	WWAN auxiliary antenna (includes WWAN auxiliary antenna cable and transceiver and double-sided adhesive)	N37485-001
(11)	WLAN module:	
	Intel AX211 Wi-Fi 6E + Bluetooth 5.2 M.2 2230 non-Vpro 160 MHz CNVi WW WLAN module	M53366-002
	Realtek RTL8111 HSH-CG WLAN module	N19618-002
	WLAN module sponge (not illustrated, includes double-sided adhesive): This component is included in the Plastics Kit, spare part number N19226-001.	
(12)	Solid-state drive:	
	256 GB, 2230, PCIe, NVMe, value solid-state drive	N41961-001
	128 GB, 2230, PCIe, NVMe, value solid-state drive	N41960-001
(13a)	Connector board (includes audio jack and USB port)	N02669-001
	NOTE: The connector board spare part kit does not include the connector board bracket, audio jack cable, or USB port cable. The connector board bracket is included in the Bracket Kit, spare part number N37486-001. The audio jack cable and the USB port cable are included in the Cable Kit, spare part number N05697-001.	
(13b)	Connector board bracket: The connector board bracket is included in the Bracket Kit, spare part number N37486-001.	
(13c)	Audio jack cable: The audio jack cable is included in the Cable Kit, spare part number N05697-001.	
(13d)	USB port cable: The USB port cable is included in the Cable Kit, spare part number N05697-001.	
(14)	Heat sink (includes captive screws and replacement thermal material)	N38632-001
	NOTE: Replacement thermal material is also available in the Thermal Pad Kit, spare part number M86338-001.	
(15a)	System board (includes integrated processor, UMA graphics subsystem memory, and replacement thermal material):	
	NOTE: Replacement thermal material is also available in the Thermal Pad Kit, spare part number M86338-001.	
	NOTE: The system board spare part kit does not include the system board I/O bracket. The system board I/O bracket is included in the Bracket Kit, spare part number N37486-001.	
	Equipped with an Intel N200 processor (8 cores, 6 MB L3 cache, 6 W), 16 GB of system memory, and the Windows 11 operating system for use on computer models with WWAN capability	N36370-601
	Equipped with an Intel N200 processor (8 cores, 6 MB L3 cache, 6 W), 16 GB of system memory, and a non-Windows operating system for use on computer models with WWAN capability	N36370-001
	Equipped with an Intel N200 processor (8 cores, 6 MB L3 cache, 6 W), 16 GB of system memory, and the Windows 11 operating system for use on computer models without WWAN capability	N36369-601
	Equipped with an Intel N200 processor (8 cores, 6 MB L3 cache, 6 W), 16 GB of system memory, and a non-Windows operating system for use on computer models without WWAN capability	N36369-001
	Equipped with an Intel N200 processor (8 cores, 6 MB L3 cache, 6 W), 8 GB of system memory, and the Windows 11 operating system for use on computer models with WWAN capability	N36360-601

Table 3-1 Computer major component descriptions and part numbers (continued)

Item	Component	Spare part number
	Equipped with an Intel N200 processor (8 cores, 6 MB L3 cache, 6 W), 8 GB of system memory, and a non-Windows operating system for use on computer models with WWAN capability	N36360-001
	Equipped with an Intel N200 processor (8 cores, 6 MB L3 cache, 6 W), 8 GB of system memory, and the Windows 11 operating system for use on computer models without WWAN capability	N36359-601
	Equipped with an Intel N200 processor (8 cores, 6 MB L3 cache, 6 W), 8 GB of system memory, and a non-Windows operating system for use on computer models without WWAN capability	N36359-001
	Equipped with an Intel N200 processor (8 cores, 6 MB L3 cache, 6 W), 4 GB of system memory, and the Windows 11 operating system for use on computer models with WWAN capability	N41833-601
	Equipped with an Intel N200 processor (8 cores, 6 MB L3 cache, 6 W), 4 GB of system memory, and a non-Windows operating system for use on computer models with WWAN capability	N41833-001
	Equipped with an Intel N200 processor (8 cores, 6 MB L3 cache, 6 W), 4 GB of system memory, and the Windows 11 operating system for use on computer models without WWAN capability	N41834-601
	Equipped with an Intel N200 processor (8 cores, 6 MB L3 cache, 6 W), 4 GB of system memory, and a non-Windows operating system for use on computer models without WWAN capability	N41834-001
	Equipped with an Intel N100 processor (4 cores, 6 MB L3 cache, 6 W), 16 GB of system memory, and the Windows 11 operating system for use on computer models with WWAN capability	N36367-601
	Equipped with an Intel N100 processor (4 cores, 6 MB L3 cache, 6 W), 16 GB of system memory, and a non-Windows operating system for use on computer models with WWAN capability	N36367-001
	Equipped with an Intel N100 processor (4 cores, 6 MB L3 cache, 6 W), 16 GB of system memory, and the Windows 11 operating system for use on computer models without WWAN capability	N36368-601
	Equipped with an Intel N100 processor (4 cores, 6 MB L3 cache, 6 W), 16 GB of system memory, and a non-Windows operating system for use on computer models without WWAN capability	N36368-001
	Equipped with an Intel N100 processor (4 cores, 6 MB L3 cache, 6 W), 8 GB of system memory, and the Windows 11 operating system for use on computer models with WWAN capability	N36355-601
	Equipped with an Intel N100 processor (4 cores, 6 MB L3 cache, 6 W), 8 GB of system memory, and a non-Windows operating system for use on computer models with WWAN capability	N36355-001
	Equipped with an Intel N100 processor (4 cores, 6 MB L3 cache, 6 W), 8 GB of system memory, and the Windows 11 operating system for use on computer models without WWAN capability	N36356-601
	Equipped with an Intel N100 processor (4 cores, 6 MB L3 cache, 6 W), 8 GB of system memory, and a non-Windows operating system for use on computer models without WWAN capability	N36356-001
	Equipped with an Intel N100 processor (4 cores, 6 MB L3 cache, 6 W), 4 GB of system memory, and the Windows 11 operating system for use on computer models with WWAN capability	N41831-601
	Equipped with an Intel N100 processor (4 cores, 6 MB L3 cache, 6 W), 4 GB of system memory, and a non-Windows operating system for use on computer models with WWAN capability	N41831-001
	Equipped with an Intel N100 processor (4 cores, 6 MB L3 cache, 6 W), 4 GB of system memory, and the Windows 11 operating system for use on computer models without WWAN capability	N41832-601
	Equipped with an Intel N100 processor (4 cores, 6 MB L3 cache, 6 W), 4 GB of system memory, and a non-Windows operating system for use on computer models without WWAN capability	N41832-001
	Equipped with an Intel N100 processor (4 cores, 6 MB L3 cache, 6 W), 4 GB of system memory, 64 GB of eMMC system storage, and the Windows 11 operating system for use on computer models without WWAN capability	N36354-601
	Equipped with an Intel N100 processor (4 cores, 6 MB L3 cache, 6 W), 4 GB of system memory, 64 GB of eMMC system storage, and a non-Windows operating system for use on computer models without WWAN capability	N36354-001

Table 3-1 Computer major component descriptions and part numbers (continued)

Item	Component	Spare part number
(16b)	System board I/O bracket: The system board I/O bracket is included in the Bracket Kit, spare part number N37486-001.	
(16)	3 cell, 42 Whr, Li-Ion battery (includes cable)	N37484-001
(17)	Bottom cover in emerald green finish (includes four rubber feet and seven captive screws)	N37482-001

Brackets

To identify the Bracket Kit components, use this illustration and table.

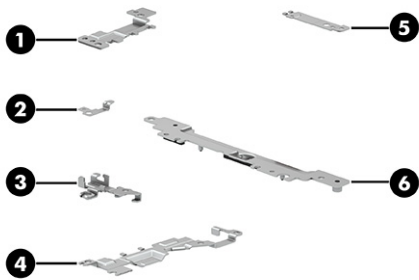

Table 3-2 Bracket Kit components descriptions

Item	Component
	The brackets listed below are available in the Bracket Kit, spare part number N37486-001.
(1)	Connector board bracket
(2)	POGO board bracket
(3)	Power connector cable bracket
(4)	System board I/O bracket
(5)	Top cover webcam bracket
(6)	Touchpad bracket

Cables

To identify the Cable Kit components, use this illustration and table.

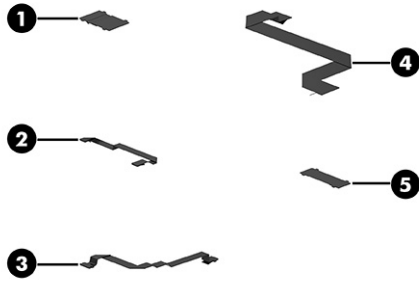

Table 3-3 Cable Kit components descriptions

Item	Component
The cables listed below are available in the Cable Kit, spare part number N05697-001.	
(1)	Audio jack cable
(2)	POGO board cable
(3)	Top cover webcam cable
(4)	Touchpad cable
(5)	USB port cable

Miscellaneous parts

To identify the miscellaneous parts, use this table.

Table 3-4 Miscellaneous part descriptions and part numbers

Component	Spare part number
AC adapter:	
120 W HP Smart AC adapter (PFC, RC, 4.5 mm, slim barrel)	M95377-001
65 W HP Smart AC adapter (non-PFC, EM, RC, 4.5 mm)	913691-850
65 W AC adapter (non-PFC, straight, 3 pin, 4.5 mm)	710412-001
65 W USB-Type C AC adapter	N01575-001
45 W HP Smart AC adapter (non-PFC, RC, 4.5 mm, non-slim barrel)	741727-001
45 W HP Smart AC adapter (non-PFC, RC, 4.5 mm, 2 pin)	742436-001
45 W AC adapter (non-PFC, USB Type-C, 1.8 m, 3 pin)	L43407-001
Adapter:	
HP HDMI-to-VGA adapter	701943-001
HP USB 3.0-to-Gigabit RJ45 adapter	M95984-001
HP USB Type-C-to-DisplayPort adapter	831753-001
HP USB Type-C-to-HDMI 2.0 adapter	935325-001
HP USB Type-C-to-RJ45 adapter	M95985-001
HP USB Type-C-to-VGA adapter	831751-001

Table 3-4 Miscellaneous part descriptions and part numbers (continued)

Component	Spare part number
USB Type-C-to-USB Type-A adapter	L65254-001
Backpack:	
HP business 17.3 in laptop backpack	M55004-001
HP Prelude Pro 15.6 backpack	M03617-001
HP business 14.1 in laptop bag	M55007-001
Bottom case:	
Bottom case for HP USB Type-C dock	L65256-001
Bottom case for USB Type-C/Type-A universal dock	L64088-001
Bracket Kit (includes connector board bracket, POGO board bracket, power connector cable bracket, system board I/O bracket, top cover webcam bracket, and touchpad bracket)	N37486-001
Case:	
HP Always On black 11.6 in case	M16115-001
HP Prelude Pro 15.6 top load case	M03618-001
Cable Kit (includes audio jack cable, POGO board cable, top cover webcam cable, touchpad cable, and USB port cable)	N05697-001
USB Type-C male-to-USB Type-C male cable (1.0 m [3.3 ft])	L65253-001
Dock:	
HP Thunderbolt® dock 120 W (includes cable)	L15809-001
HP USB Type-C dock (includes cable)	L64086-001
HP USB Type-C/Type-A universal dock (includes cable)	L64087-001
HP USB External DVD+-RW Drive	747080-001
Duckhead adapter for use in Japan	L33157-001
Hub:	
HP Smart AC adapter hub (7.4 mm)	734734-001
HP USB Type-C-to-USB Type-A hub	916838-001
HP USB Type-C travel hub	L72056-001
HP universal USB Type-C MultiPort hub	M96882-001
HP USB keyboard for use in the United States	L95712-001
Lock:	
HP Essential nano combination cable lock	N10501-001
HP nano combination cable lock	N10500-001
HP nano lock	918431-001
HP SureKey cable lock	L65088-001
Mouse:	
HP 128 laser wired mouse	M27885-001

Table 3-4 Miscellaneous part descriptions and part numbers (continued)

Component	Spare part number
HP 435 wireless mouse	M62277-001
HP Bluetooth travel mouse	L62043-001
HP USB mouse	L95713-001
Plastics Kit:	
For use on computer models equipped with WWAN capability (includes battery gasket, touchpad gasket, and WWAN module shield)	N37487-001
For use on computer models not equipped with WWAN capability (includes battery gasket, service cover gasket, and WLAN module shield)	N05694-001
Power cord (C5, 1.0 m [3.3 ft], conventional with sticker) + AC adapter bundle for use in Europe	N16170-001
Power cord (C5, 1.0 m [3.3 ft], conventional with sticker) + AC adapter bundle for use in Thailand	M85418-001
Power cord (C5, 1.8 m [6.0 ft], conventional with sticker, high frequency):	
For use in Denmark	M79264-001
For use in Europe	M79266-001
For use in Israel	M82712-001
For use in Switzerland	M79265-001
For use in the United Kingdom	M82711-001
Power cord (C5, 1.8 m [6.0 ft], conventional with sticker):	
For use in Argentina	L19357-002
For use in Australia	L19358-002
For use in Denmark	L19360-002
For use in Europe	L19361-002
For use in India	L19363-002
For use in Israel	L19362-002
For use in Italy	L19364-002
For use in Japan	L19365-002
For use in North America	L19367-002
For use in the People's Republic of China	L19368-002
For use in South Africa	L19369-002
For use in South Korea	L19366-002
For use in Switzerland	L19370-002
For use in Taiwan	L19372-002
For use in Thailand	L19371-002
For use in the United Kingdom	L19373-002
Power cord (C5, 1.0 m [3.3 ft], conventional with sticker):	
For use in Argentina	L19357-001

Table 3-4 Miscellaneous part descriptions and part numbers (continued)

Component	Spare part number
For use in Australia	L19358-001
For use in Denmark	L19360-001
For use in Europe	L19361-001
For use in India	L19363-001
For use in Israel	L19362-001
For use in Italy	L19364-001
For use in Japan	L19365-001
For use in North America	L19367-001
For use in the People's Republic of China	L19368-001
For use in South Africa	L19369-001
For use in South Korea	L19366-001
For use in Switzerland	L19370-001
For use in Taiwan	L19372-001
For use in Thailand	L19371-001
For use in the United Kingdom	L19373-001
Power cord (C13, 1.0 m [3.3 ft], premium with tag):	
For use in Argentina	L32029-001
For use in Brazil	L32030-001
For use in Italy	L32031-001
Power cord (C13, 1.0 m [3.3 ft], premium with tag, low wattage):	
For use in Argentina	401328-018
For use in India	403440-008
For use in Italy	109197-012
Power cord (C5, 1.0 m [3.3 ft], premium with tag):	
For use in Argentina	920689-003
For use in Australia	L30769-001
For use in Brazil	L30770-001
For use in Denmark	L30771-001
For use in Europe	L30772-001
For use in India	920689-016
For use in Israel	L30773-001
For use in Italy	L30774-001
For use in Japan	L30775-001
For use in North America	920689-001

Table 3-4 Miscellaneous part descriptions and part numbers (continued)

Component	Spare part number
For use in the People's Republic of China	920689-014
For use in South Africa	L30777-001
For use in South Korea	L30776-001
For use in Switzerland	L30778-001
For use in Taiwan	L30780-001
For use in the United Kingdom	L30781-001
Power cord (C5, 1.0 m [3.3 ft], conventional with sticker, HF):	
For use in Denmark	M79264-001
For use in Europe	M79266-001
For use in Switzerland	M79265-001
Rubber Kit:	
For use on computer models equipped with WWAN capability (includes WWAN antenna cable rubber and WLAN antenna cable rubber)	N02673-001
For use on computer models not equipped with WWAN capability (includes WLAN antenna cable rubber)	N05695-001
Screw Kit	
HP reversible 11.6 in sleeve	L81451-001

4 Removal and replacement procedures preliminary requirements

Use this information to properly prepare to disassemble and reassemble the computer.

Tools required

You need the following tools to complete the removal and replacement procedures:

- Nonconductive, nonmarking pry tool
- Phillips P0 screwdriver
- Phillips P1 screwdriver

Service considerations

The following sections include some of the considerations that you must keep in mind during disassembly and assembly procedures.

 **NOTE:** As you remove each subassembly from the computer, place the subassembly (and all accompanying screws) away from the work area to prevent damage.

Plastic parts

Using excessive force during disassembly and reassembly can damage plastic parts.

Cables and connectors

Handle cables with extreme care to avoid damage.

 **IMPORTANT:** When servicing the computer, be sure that cables are placed in their proper locations during the reassembly process. Improper cable placement can damage the computer.

Apply only the tension required to unseat or seat the cables during removal and insertion. Handle cables by the connector whenever possible. In all cases, avoid bending, twisting, or tearing cables. Be sure that cables are routed so that they cannot be caught or snagged as you remove or replace parts. Handle flex cables with extreme care; these cables tear easily.

Drive handling

Note the following guidelines when handling drives.

 **IMPORTANT:** Drives are fragile components. Handle them with care. To prevent damage to the computer, damage to a drive, or loss of information, observe these precautions:

- Before removing or inserting a hard drive, shut down the computer. If you are unsure whether the computer is off or in Hibernation, turn the computer on, and then shut it down through the operating system.
 - Before handling a drive, be sure that you are discharged of static electricity. While handling a drive, avoid touching the connector.
 - Before removing an optical drive, be sure that a disc is not in the drive, and be sure that the optical drive tray is closed.
 - Handle drives on surfaces covered with at least 2.54 cm (1 inch) of shock-proof foam.
 - Avoid dropping drives from any height onto any surface.
 - After removing a hard drive or an optical drive, place it in a static-proof bag.
 - Avoid exposing an internal hard drive to products that have magnetic fields, such as monitors or speakers.
 - Avoid exposing a drive to temperature extremes or liquids.
 - If a drive must be mailed, place the drive in a bubble pack mailer or other suitable form of protective packaging, and label the package “FRAGILE.”
-

Electrostatic discharge information

A sudden discharge of static electricity from your finger or other conductor can destroy static-sensitive devices or microcircuitry. Often the spark is neither felt nor heard, but damage occurs. An electronic device exposed to electrostatic discharge (ESD) might not appear to be affected at all and can work perfectly throughout a normal cycle. The device might function normally for a while, but it has been degraded in the internal layers, reducing its life expectancy.

Networks built into many integrated circuits provide some protection, but in many cases, the discharge contains enough power to alter device parameters or melt silicon junctions.

 **IMPORTANT:** To prevent damage to the device when you remove or install internal components, observe these precautions:

- Keep components in their electrostatic-safe containers until you are ready to install them.
 - Before touching an electronic component, discharge static electricity by using the guidelines described in [Personal grounding methods and equipment on page 37](#).
 - Avoid touching pins, leads, and circuitry. Handle electronic components as little as possible.
 - If you remove a component, place it in an electrostatic-safe container.
-

Generating static electricity

Follow these static electricity guidelines:

- Different activities generate different amounts of static electricity.
- Static electricity increases as humidity decreases.

Table 4-1 Static electricity occurrence based on activity and humidity

Event	Relative humidity		
	55%	40%	10%
Walking across carpet	7,500 V	15,000 V	35,000 V
Walking across vinyl floor	3,000 V	5,000 V	12,000 V
Motions of bench worker	400 V	800 V	6,000 V
Removing dual in-line packages (DIPs) from plastic tube	400 V	700 V	2,000 V
Removing DIPs from vinyl tray	2,000 V	4,000 V	11,500 V
Removing DIPs from polystyrene foam	3,500 V	5,000 V	14,500 V
Removing bubble pack from PCB (printed circuit board)	7,000 V	20,000 V	26,500 V
Packing PCBs in foam-lined box	5,000 V	11,000 V	21,000 V

Multiple electric components can be packaged together in plastic tubes, trays, or polystyrene foam.



NOTE: As little as 700 V of static electricity can degrade a product.

Preventing electrostatic damage to equipment

Many electronic components are sensitive to ESD. Circuitry design and structure determine the degree of sensitivity.

The following packaging and grounding precautions are necessary to prevent static electricity damage to electronic components:

- To avoid hand contact, transport products in static-safe containers such as tubes, bags, or boxes.
- Protect all electrostatic parts and assemblies with conductive or approved containers or packaging.
- Keep electrostatic-sensitive parts in their containers until they arrive at static-free stations.
- Place items on a grounded surface before removing them from their container.
- Always be properly grounded when touching a sensitive component or assembly.
- Avoid contact with pins, leads, or circuitry.
- Place reusable electrostatic-sensitive parts from assemblies in protective packaging or conductive foam.

Personal grounding methods and equipment

Using certain equipment can prevent static electricity damage to electronic components.

- **Wrist straps** are flexible straps with a maximum of $1\text{ M}\Omega \pm 10\%$ resistance in the ground cords. To provide proper ground, a strap must be worn snug against bare skin. The ground cord must be connected and fit snugly into the banana plug connector on the grounding mat or workstation.
- You can use **heel straps, toe straps, and boot straps** at standing workstations. These straps are compatible with most types of shoes or boots. On conductive floors or dissipative floor mats, use them on both feet with a maximum of $1\text{ M}\Omega \pm 10\%$ resistance between the operator and ground.

Table 4-2 Static shielding protection levels

Static shielding protection levels	
Method	Voltage
Antistatic plastic	1,500
Carbon-loaded plastic	7,500
Metallized laminate	15,000

Grounding the work area

To prevent static damage at the work area, follow these precautions:

- Cover the work surface with approved static-dissipative material.
- Use a wrist strap connected to a properly grounded work surface and use properly grounded tools and equipment.
- Use static-dissipative mats, foot straps, or air ionizers to give added protection.
- Handle electrostatic sensitive components, parts, and assemblies by the case or PCB laminate. Handle them only at static-free work areas.
- Turn off power and input signals before inserting and removing connectors or test equipment.
- Use fixtures made of static-safe materials when fixtures must directly contact dissipative surfaces.
- Keep the work area free of nonconductive materials, such as ordinary plastic assembly aids and polystyrene foam.
- Use conductive field service tools, such as cutters, screwdrivers, and vacuums.
- Avoid contact with pins, leads, or circuitry.

Recommended materials and equipment

HP recommends certain materials and equipment to prevent static electricity:

- Antistatic tape
- Antistatic smocks, aprons, or sleeve protectors
- Conductive bins and other assembly or soldering aids
- Conductive foam
- Conductive tabletop workstations with ground cord of $1\text{ M}\Omega \pm 10\%$ resistance
- Static-dissipative table or floor mats with hard tie to ground
- Field service kits
- Static awareness labels
- Wrist straps and footwear straps providing $1\text{ M}\Omega \pm 10\%$ resistance
- Material handling packages

- Conductive plastic bags
- Conductive plastic tubes
- Conductive tote boxes
- Opaque shielding bags
- Transparent metallized shielding bags
- Transparent shielding tubes

Cleaning your computer

Cleaning your computer regularly removes dirt and debris so that your device continues to operate at its best. Use the following information to safely clean the external surfaces of your computer.

Enabling HP Easy Clean (select products only)

HP Easy Clean helps you to avoid accidental input while you clean the computer surfaces. This software disables devices such as the keyboard, touch screen, and touchpad for a preset amount of time so that you can clean all computer surfaces.

1. Start HP Easy Clean in one of the following ways:
 - Select the **Start** menu, and then select **HP Easy Clean**.
- or -
 - Select the **HP Easy Clean** icon in the taskbar.
- or -
 - Select **Start**, and then select the **HP Easy Clean** tile.
2. Now that your device is disabled for a short period, see [Removing dirt and debris from your computer on page 39](#) for the recommended steps to clean the high-touch, external surfaces on your computer. After you remove the dirt and debris, you can also clean the surfaces with a disinfectant. See [Cleaning your computer with a disinfectant on page 40](#) for guidelines to help prevent the spread of harmful bacteria and viruses.

Removing dirt and debris from your computer

Here are the recommended steps to clean dirt and debris from your computer.

For computers with wood veneer, see [Caring for wood veneer \(select products only\) on page 41](#).

1. Wear disposable gloves made of latex (or nitrile gloves, if you are latex-sensitive) when cleaning the surfaces.
2. Turn off your device and unplug the power cord and other connected external devices. Remove any installed batteries from items such as wireless keyboards.

 **CAUTION:** To prevent electric shock or damage to components, never clean a product while it is turned on or plugged in.

3. Moisten a microfiber cloth with water. The cloth should be moist, but not dripping wet.

 **IMPORTANT:** To avoid damaging the surface, avoid abrasive cloths, towels, and paper towels.

4. Wipe the exterior of the product gently with the moistened cloth.

 **IMPORTANT:** Keep liquids away from the product. Avoid getting moisture in any openings. If liquid makes its way inside your HP product, it can cause damage to the product. Do not spray liquids directly on the product. Do not use aerosol sprays, solvents, abrasives, or cleaners containing hydrogen peroxide or bleach that might damage the finish.

5. Start with the display (if applicable). Wipe carefully in one direction, and move from the top of the display to the bottom. Finish with any flexible cables, like power cord, keyboard cable, and USB cables.
6. Be sure that surfaces have completely air-dried before turning the device on after cleaning.
7. Discard the gloves after each cleaning. Clean your hands immediately after you remove the gloves.

See [Cleaning your computer with a disinfectant on page 40](#) for recommended steps to clean the high-touch, external surfaces on your computer to help prevent the spread of harmful bacteria and viruses.

Cleaning your computer with a disinfectant

The World Health Organization (WHO) recommends cleaning surfaces, followed by disinfection, as a best practice for preventing the spread of viral respiratory illnesses and harmful bacteria.

After cleaning the external surfaces of your computer using the steps in [Removing dirt and debris from your computer on page 39](#), [Caring for wood veneer \(select products only\) on page 41](#), or both, you might also choose to clean the surfaces with a disinfectant. A disinfectant that is within HP's cleaning guidelines is an alcohol solution consisting of 70% isopropyl alcohol and 30% water. This solution is also known as rubbing alcohol and is sold in most stores.

Follow these steps when disinfecting high-touch, external surfaces on your computer:

1. Wear disposable gloves made of latex (or nitrile gloves, if you are latex-sensitive) when cleaning the surfaces.
2. Turn off your device and unplug the power cord and other connected external devices. Remove any installed batteries from items such as wireless keyboards.

 **CAUTION:** To prevent electric shock or damage to components, never clean a product while it is turned on or plugged in.

3. Moisten a microfiber cloth with a mixture of 70% isopropyl alcohol and 30% water. The cloth should be moist, but not dripping wet.

 **CAUTION:** Do not use any of the following chemicals or any solutions that contain them, including spray-based surface cleaners: bleach, peroxides (including hydrogen peroxide), acetone, ammonia, ethyl alcohol, methylene chloride, or any petroleum-based materials, such as gasoline, paint thinner, benzene, or toluene.

 **IMPORTANT:** To avoid damaging the surface, avoid abrasive cloths, towels, and paper towels.

4. Wipe the exterior of the product gently with the moistened cloth.

 **IMPORTANT:** Keep liquids away from the product. Avoid getting moisture in any openings. If liquid makes its way inside your HP product, it can cause damage to the product. Do not spray liquids directly on the product. Do not use aerosol sprays, solvents, abrasives, or cleaners containing hydrogen peroxide or bleach that might damage the finish.

5. Start with the display (if applicable). Wipe carefully in one direction, and move from the top of the display to the bottom. Finish with any flexible cables, like power cord, keyboard cable, and USB cables.
6. Be sure that surfaces have completely air-dried before turning the device on after cleaning.
7. Discard the gloves after each cleaning. Clean your hands immediately after you remove the gloves.

Caring for wood veneer (select products only)

Your product might feature high-quality wood veneer. As with all natural wood products, proper care is important for best results over the life of the product. Because of the nature of natural wood, you might see unique variations in the grain pattern or subtle variations in color, which are normal.

- Clean the wood with a dry, static-free microfiber cloth or chamois.
- Avoid cleaning products containing substances such as ammonia, methylene chloride, acetone, turpentine, or other petroleum-based solvents.
- Do not expose the wood to sun or moisture for long periods of time.
- If the wood becomes wet, dry it by dabbing with an absorbent, lint-free cloth.
- Avoid contact with any substance that might dye or discolor the wood.
- Avoid contact with sharp objects or rough surfaces that might scratch the wood.

See [Removing dirt and debris from your computer on page 39](#) for the recommended steps to clean the high-touch, external surfaces on your computer. After you remove the dirt and debris, you can also clean the surfaces with a disinfectant. See [Cleaning your computer with a disinfectant on page 40](#) for sanitizing guidelines to help prevent the spread of harmful bacteria and viruses.

Packaging and transporting guidelines

Follow these grounding guidelines when packaging and transporting equipment:

- To avoid hand contact, transport products in static-safe tubes, bags, or boxes.
- Protect ESD-sensitive parts and assemblies with conductive or approved containers or packaging.
- Keep ESD-sensitive parts in their containers until the parts arrive at static-free workstations.
- Place items on a grounded surface before removing items from their containers.
- Always be properly grounded when touching a component or assembly.
- Store reusable ESD-sensitive parts from assemblies in protective packaging or nonconductive foam.

- Use transporters and conveyors made of antistatic belts and roller bushings. Be sure that mechanized equipment used for moving materials is wired to ground and that proper materials are selected to avoid static charging. When grounding is not possible, use an ionizer to dissipate electric charges.

Accessing support information

To find the HP support that you need, use this information.

Table 4-3 Support information locations



Service consideration	Path to access information
Records of reported failure incidents stored on the computer	<p>Windows:</p> <p>Preoperating system failures are logged in the BIOS Event Log. To view the BIOS Event Log:</p> <ol style="list-style-type: none"> 1. Press the power button. 2. Immediately and repeatedly press esc when the power button light turns white. <p>NOTE: If you do not press esc at the appropriate time, you must restart the computer and again repeatedly press esc when the power button light turns white to access the utility.</p> <ol style="list-style-type: none"> 3. Press f10 to enter the BIOS setup. 4. (On commercial products) Under the Main tab, select BIOS event log, and then select View BIOS Event Log. <p>- or -</p> <p>(On consumer products) Under the Main tab, select System Log.</p> <p>Post-operating system failures are logged in the Event Viewer.</p> <ol style="list-style-type: none"> 1. Turn on the computer and allow the operating system to open. 2. Select the search icon  in the taskbar. 3. Type <code>Event Viewer</code>, and then press enter. 4. Select the log from the left panel. Details display in the right panel. <p>Chrome:</p> <ol style="list-style-type: none"> 1. Go to support.google.com/chrome. 2. Search <code>collect Chrome device logs</code>.
Technical bulletins	<p>To locate technical bulletins:</p> <ol style="list-style-type: none"> 1. Go to www.hp.com. 2. Place the cursor over Problem solving to display more options. 3. Select Support & Troubleshooting. 4. Type the serial number, product number, or product name to go to the product support page. 5. Select Advisories to view technical bulletins.

Table 4-3 Support information locations (continued)

Service consideration	Path to access information
Repair professionals	To locate repair professionals: <ol style="list-style-type: none"><li data-bbox="703 312 932 333">1. Go to www.hp.com.<li data-bbox="703 361 1362 382">2. Place the cursor over Support resources to display more options.<li data-bbox="703 409 1091 430">3. Select Authorized service providers.
Component and diagnosis information, failure detection, and required action	To locate diagnosis information and actions: <ol style="list-style-type: none"><li data-bbox="703 512 1203 533">1. Go to http://www.hp.com/go/techcenter/pcdiags.<li data-bbox="703 560 932 581">2. Select Get Support.<li data-bbox="703 609 1445 653">3. Near the bottom of the window, select Notebook PCs, and then select your location.

5 Removal and replacement procedures for authorized service provider parts

This chapter provides removal and replacement procedures for authorized service provider parts.

 **IMPORTANT:** Only an authorized service provider should access the components described in this chapter. Accessing these parts can damage the computer or void the warranty.

 **NOTE:** Details about your computer, including model, serial number, product key, and length of warranty, are on the service tag at the bottom of your computer.

Component replacement procedures

To remove and replace computer components, use the procedures described in this section.

 **NOTE:** HP continually improves and changes product parts. For complete and current information about supported parts for your computer, go to <http://partsurfer.hp.com>, select your country or region, and then follow the on-screen instructions.

Make special note of each screw size and location during removal and replacement.

Preparation for disassembly

To remove and replace computer components, use these procedures:

For initial safety procedures, see [Removal and replacement procedures preliminary requirements on page 35](#).

1. Turn off the computer. If you are unsure whether the computer is off or in Hibernation, turn the computer on, and then shut it down through the operating system.
2. Disconnect the power from the computer by unplugging the power cord from the computer.
3. Disconnect all external devices from the computer.

Bottom cover

To remove the bottom cover, use this procedure and illustration.

Table 5-1 Bottom cover description and part number

Description	Spare part number
Bottom cover in emerald green finish (includes four rubber feet and seven captive screws)	N37482-001

Before removing the bottom cover, prepare the computer for disassembly (see [Preparation for disassembly on page 44](#)).

Remove the bottom cover:

1. Close the computer and rest it upside down on a flat work surface with the front toward you.
2. Loosen the seven Phillips captive screws (1) that secure the bottom cover to the computer.
3. Insert a thin, plastic tool, such as a case utility tool (2), into the display hinge areas and release the rear edge of the bottom cover from the computer.
4. Swing the rear edge of the bottom cover (3) up and forward, and then remove the bottom cover.

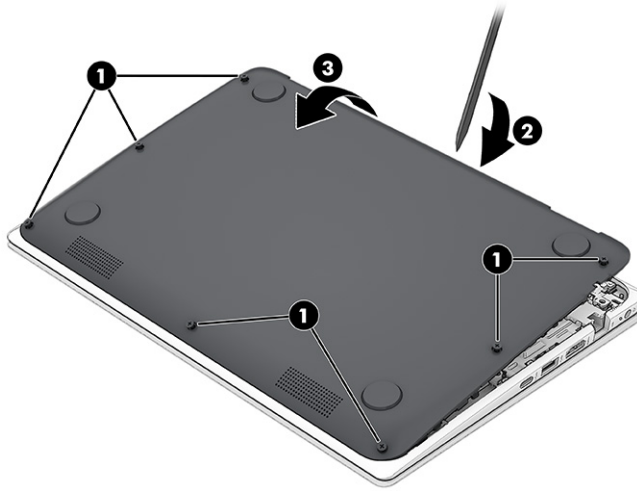

To replace the bottom cover, reverse the removal procedures.

Battery

To remove the battery, use this procedure and illustration.

Table 5-2 Battery description and part number

Description	Spare part number
3 cell, 42 Whr, Li-ion battery (includes cable)	N37484-001

⚠ WARNING! To avoid personal injury and damage to the product:

- Do *not* puncture, twist, or crack the battery.
- Do *not* cause an external puncture or rupture to the battery. They can cause a short inside the battery, which can result in battery thermal runaway.
- Do *not* handle or touch the battery enclosure with sharp objects such as tweezers or pliers, which might puncture the battery.
- Do *not* compress or squeeze the battery case with tools or heavy objects stacked on top of the case. These actions can apply undue force on the battery.

- Do *not* touch the connectors with any metallic surface or object, such as metal tools, screws, or coins, which can cause shorting across the connectors.

Before removing the battery, follow these steps:

1. Prepare the computer for disassembly (see [Preparation for disassembly on page 44](#)).
2. Remove the bottom cover (see [Bottom cover on page 44](#)).

⚠ WARNING! To reduce potential safety issues, use only the user-replaceable battery provided with the computer, a replacement battery provided by HP, or a compatible battery purchased from HP.

📌 IMPORTANT: Removing a battery that is the sole power source for the computer can cause loss of information. To prevent loss of information, save your work or shut down the computer through Windows before you remove the battery.

Remove the battery:

1. Disconnect the battery cable (1) from the system board.
2. Remove the seven Phillips M2.5×5.2 screws (2) that secure the battery to the computer.
3. Swing the battery rear edge (3) up and forward until it rests at an angle.
4. Slide the battery (4) up and away from the computer and remove it.

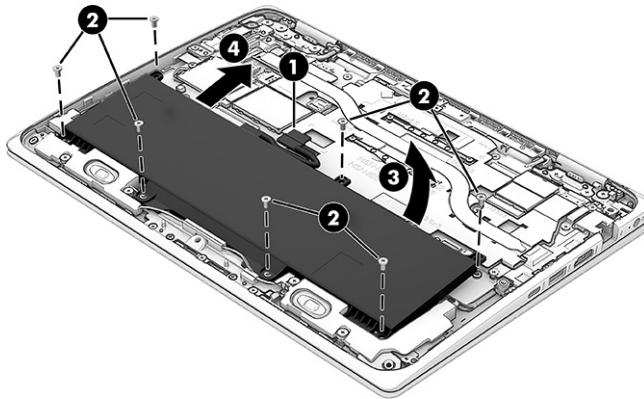

To replace the battery, reverse the removal procedures.

WWAN module

To remove the WWAN module, use this procedure and illustration.

Table 5-3 WWAN module description and part number

Description	Spare part number
Intel XMM 7560 R+ LTE-Advanced Pro (Cat 16) WWAN module	N37489-001

📌 IMPORTANT: To prevent an unresponsive system, replace the wireless module only with a wireless module authorized for use in the computer by the governmental agency that regulates wireless

devices in your country or region. If you replace the module and then receive a warning message, remove the module to restore device functionality, and then contact technical support.

Before removing the WWAN module, follow these steps:

1. Prepare the computer for disassembly (see [Preparation for disassembly on page 44](#)).
2. Remove the bottom cover (see [Bottom cover on page 44](#)).
3. Disconnect the battery cable from the system board (see [Battery on page 45](#)).

Remove the WWAN module:

1. Release the heat sink shield **(1)** that partially covers the WWAN module.
2. Release the WWAN module cover **(2)** that secures the WWAN antenna cables to the WWAN module.

The WWAN module cover is included in the Plastics Kit, spare part number N37487-001.

3. Carefully disconnect the WWAN antenna cables **(3)** from the terminals on the WWAN module.

Computer models can have up to four WWAN antenna cables. The antenna cables have tags that identify them with a number that corresponds to a WWAN module terminal. Connect each WWAN antenna cable to the corresponding WWAN module terminal.

4. Remove the Phillips M2.0 × 4.5 screw **(4)** that secures the WWAN module to the system board.

The WWAN module tilts up.

5. Remove the WWAN module **(5)** by pulling the module away from the slot at an angle.

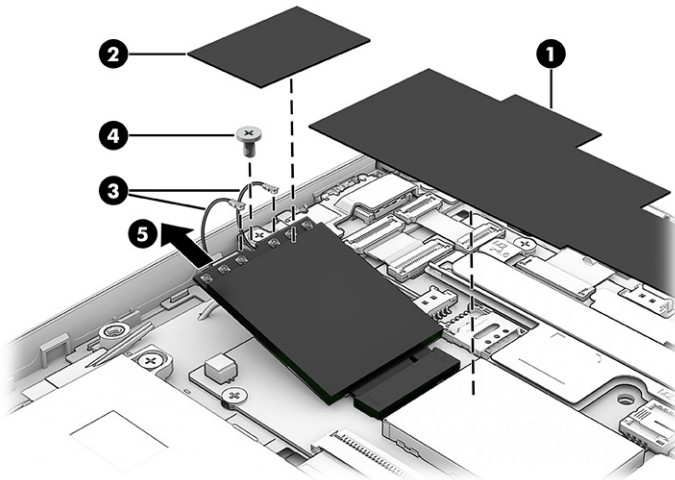

6. If the WWAN antenna is not connected to the terminal on the WWAN module, a protective sleeve must be installed on the antenna connector, as shown in the following illustration.

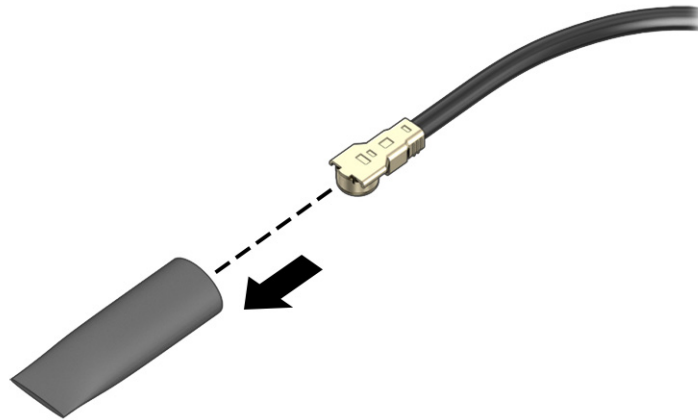

To replace the WWAN module, reverse the removal procedures.



NOTE: The WWAN module is designed with a notch to prevent incorrect insertion.

WWAN auxiliary antenna

To remove the WWAN auxiliary antenna, use this procedure and illustration.

Table 5-4 WWAN auxiliary antenna description and part number

Description	Spare part number
WWAN auxiliary antenna	N37485-001

Before removing the WWAN auxiliary antenna, follow these steps:

1. Prepare the computer for disassembly (see [Preparation for disassembly on page 44](#)).
2. Remove the bottom cover (see [Bottom cover on page 44](#)).
3. Disconnect the battery cable from the system board (see [Battery on page 45](#)).

Remove the WWAN auxiliary antenna:

1. Release the WWAN module cover that secures the WWAN antenna cables to the WWAN module.
The WWAN module cover is included in the Plastics Kit, spare part number N37487-001.
2. Carefully disconnect the WWAN auxiliary antenna cable (1) from the terminal on the WWAN module.
Computer models can have up to four WWAN antenna cables. The antenna cables have tags that identify them with a number that corresponds to a WWAN module terminal. Connect each WWAN antenna cable to the corresponding WWAN module terminal.
3. Remove the retention tape (2) that secures the WWAN auxiliary antenna cable to the computer.

4. Release the WWAN auxiliary antenna cable from the retention clips **(3)** and routing channel that secures it.
5. Detach the WWAN auxiliary antenna transceiver **(4)** from the computer. The WWAN auxiliary antenna transceiver is attached to the computer with double-sided adhesive.

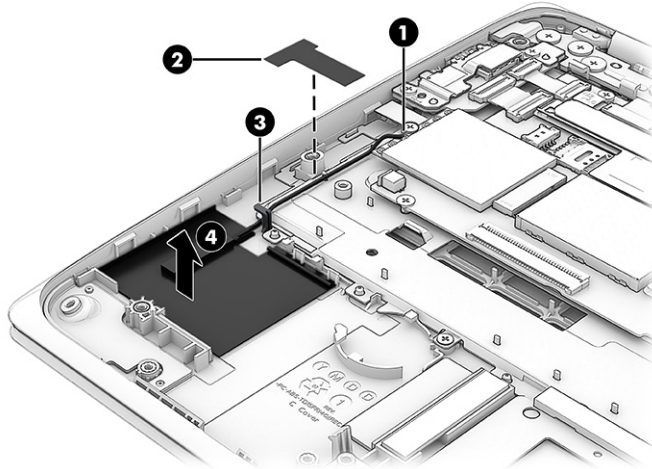

6. Remove the WWAN auxiliary antenna.

To install the WWAN auxiliary antenna, reverse the removal procedures.

Solid-state drive

To remove the solid-state drive, use this procedure and illustration.

Table 5-5 Solid-state drive description and part number

Description	Spare part number
256 GB, 2230, PCIe, NVMe, value solid-state drive	N41961-001
128 GB, 2230, PCIe, NVMe, value solid-state drive	N41960-001

Before removing the solid-state drive, follow these steps:

1. Prepare the computer for disassembly (see [Preparation for disassembly on page 44](#)).
2. Remove the bottom cover (see [Bottom cover on page 44](#)).
3. Disconnect the battery cable from the system board (see [Battery on page 45](#)).

Remove the solid-state drive:

1. Remove the heat sink shield **(1)** that covers the solid-state drive.
2. Remove the Phillips M2.0 × 4.5 screw **(2)** that secures the solid-state drive to the computer.

The solid-state drive tilts up.

3. Remove the solid-state drive (3) by pulling the drive away from the slot at an angle.

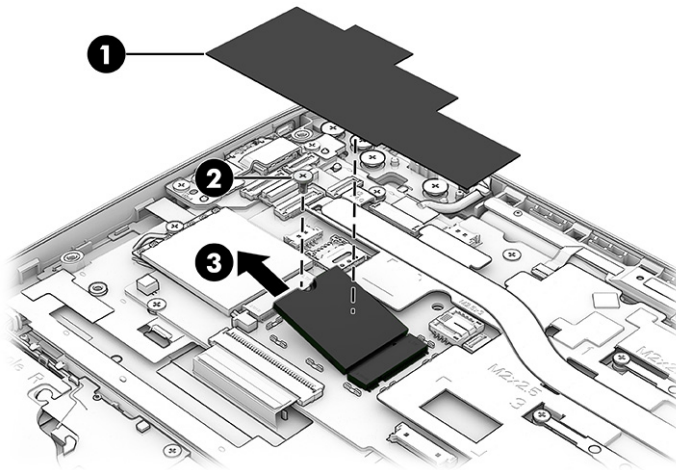

To replace the solid-state drive, reverse the removal procedures.

 **NOTE:** The solid-state drive is designed with a notch to prevent incorrect insertion.

WLAN module

To remove the WLAN module, use this procedure and illustration.

Table 5-6 WLAN module descriptions and part numbers

Description	Spare part number
Realtek RTL8111 HSH-CG WLAN module	N19618-002
Intel AX211 Wi-Fi 6E + Bluetooth 5.2 M.2 2230 non-Vpro 160 MHz CNVi WW WLAN module	M53366-002

 **IMPORTANT:** To prevent an unresponsive system, replace the wireless module only with a wireless module authorized for use in the computer by the governmental agency that regulates wireless devices in your country or region. If you replace the module and then receive a warning message, remove the module to restore device functionality, and then contact technical support.

Before removing the WLAN module, follow these steps:

1. Prepare the computer for disassembly (see [Preparation for disassembly on page 44](#)).
2. Remove the bottom cover (see [Bottom cover on page 44](#)).
3. Disconnect the battery cable from the system board (see [Battery on page 45](#)).

Remove the WLAN module:

1. Release the WLAN module sponge (1) that secures the WLAN antenna cables to the WLAN module.
The WLAN module sponge is included in the Plastics Kit, spare part number N05694-001.

2. Carefully disconnect the two WLAN antenna cables (2) from the terminals on the WLAN module.

Computer models have either one or two WLAN antennas. On models with two antennas, the #1 WLAN antenna cable connects to the WLAN module #1 Main terminal. The #2 WLAN antenna cable connects to the WLAN module #2 Aux terminal.

3. Remove the Phillips M2.0 × 4.5 screw (3) that secures the WLAN module to the system board.

The WLAN module tilts up.

4. Remove the WLAN module (4) by pulling the module away from the slot at an angle.

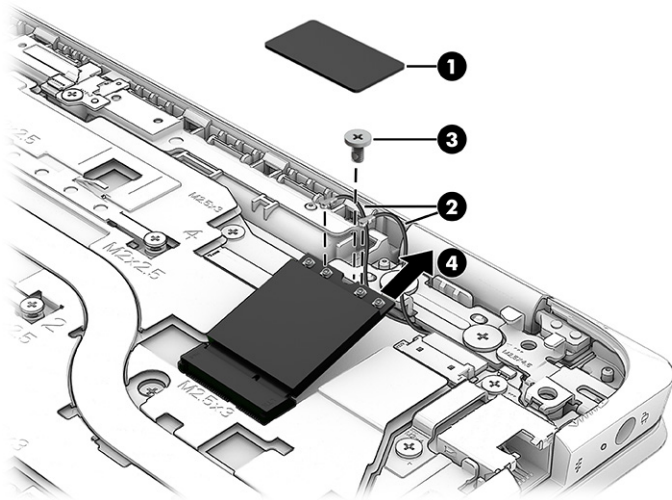

5. If the WLAN antenna is not connected to the terminal on the WLAN module, install a protective sleeve on the antenna connector, as shown in the following illustration.

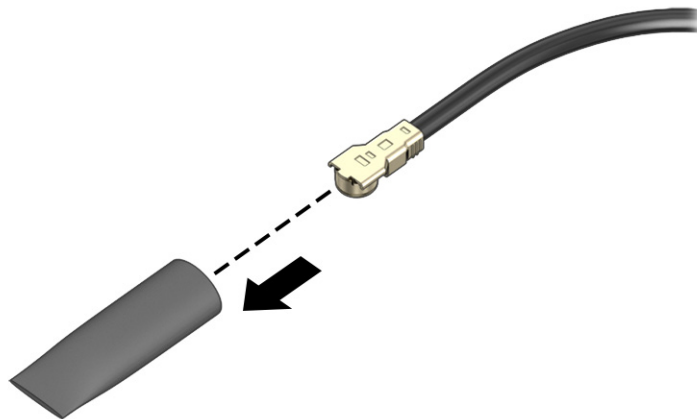

To replace the WLAN module, reverse the removal procedures.

 **NOTE:** The WLAN module is designed with a notch to prevent incorrect insertion.

Connector board cables

To remove the connector board cables, use this procedure and illustration.

 **NOTE:** The audio jack cable and USB port cable are included in the Cable Kit, spare part number N05697-001.

Before removing the connector board cables, follow these steps:

1. Prepare the computer for disassembly (see [Preparation for disassembly on page 44](#)).
2. Remove the bottom cover (see [Bottom cover on page 44](#)).
3. Disconnect the battery cable from the system board (see [Battery on page 45](#)).

Remove the connector board cables:

1. Release the zero insertion force (ZIF) connector **(1)** the audio jack cable is connected to, and then disconnect the audio jack cable from the system board.
2. Release the ZIF connector **(2)** the audio jack cable is connected to, and then disconnect the audio jack cable from the connector board.
3. Release the ZIF connector **(3)** the USB port cable is connected to, and then disconnect the USB port cable from the system board.
4. Release the ZIF connector **(4)** the USB port cable is connected to, and then disconnect the USB port cable from the connector board.
5. Remove the audio jack board cable **(5)** and the USB port cable from the computer.

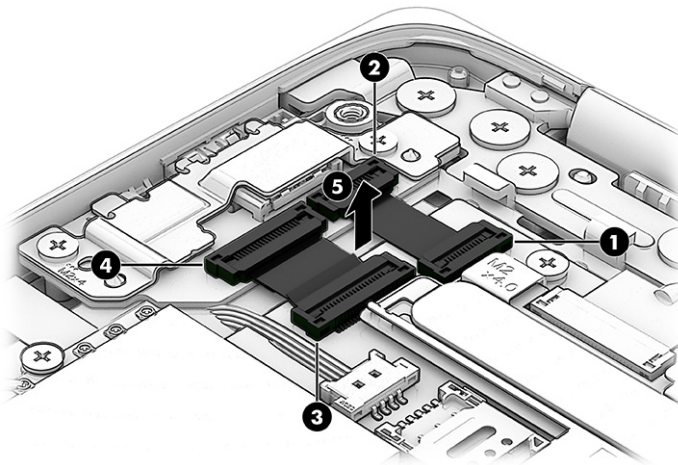

To replace the audio jack board cable and the USB port cable, reverse the removal procedures.

Connector board

To remove the connector board, use this procedure and illustration.

Table 5-7 Connector board description and part number

Description	Spare part number
Connector board	N02669-001

NOTE: The connector board spare part kit does not include the connector board bracket, audio jack cable, or USB port cable. The connector board bracket is included in the Bracket Kit, spare part number N37486-001. The audio jack cable and the USB port cable are included in the Cable Kit, spare part number N05697-001.

Before removing the connector board, follow these steps:

1. Prepare the computer for disassembly (see [Preparation for disassembly on page 44](#)).
2. Remove the bottom cover (see [Bottom cover on page 44](#)).
3. Disconnect the battery cable from the system board (see [Battery on page 45](#)).
4. Remove the audio jack cable and USB port cable (see [Connector board cables on page 52](#)).

Remove the connector board:

1. Remove the two Phillips M2.0 × 4.5 screws **(1)** that secure the connector board to the computer.
2. Remove the connector board bracket **(2)**.
The connector board bracket is included in the Bracket Kit, spare part number N37486-001.
3. Remove the connector board **(3)** from the computer.

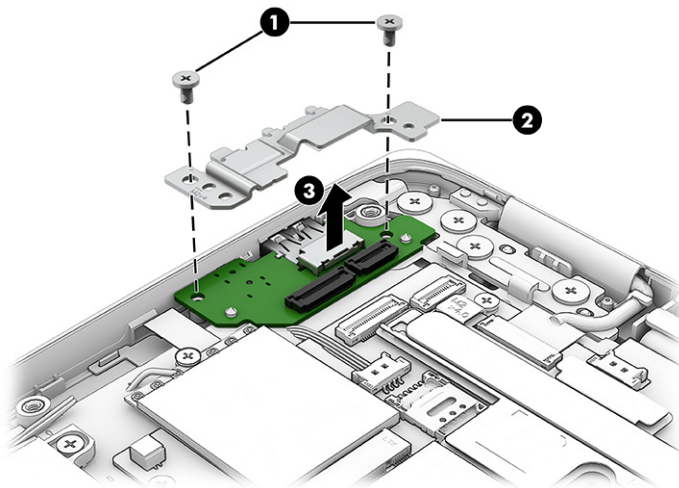

To replace the connector board, reverse the removal procedures.

POGO board cable

To remove the POGO board cable, use this procedure and illustration.

The POGO board cable is available in the Cable Kit, spare part number N05697-001.

Before removing the POGO board cable, follow these steps:

1. Prepare the computer for disassembly (see [Preparation for disassembly on page 44](#)).
2. Remove the bottom cover (see [Bottom cover on page 44](#)).
3. Disconnect the battery cable from the system board (see [Battery on page 45](#)).

Remove the POGO board cable:

1. Release the ZIF connector **(1)** the POGO board cable is connected to, and then disconnect the POGO board cable from the system board.
2. Release the ZIF connector **(2)** the POGO board cable is connected to, and then disconnect the POGO board cable from the POGO board.
3. Detach the POGO board cable **(3)** from the computer. (The POGO board cable is attached to the computer with double-sided adhesive.)

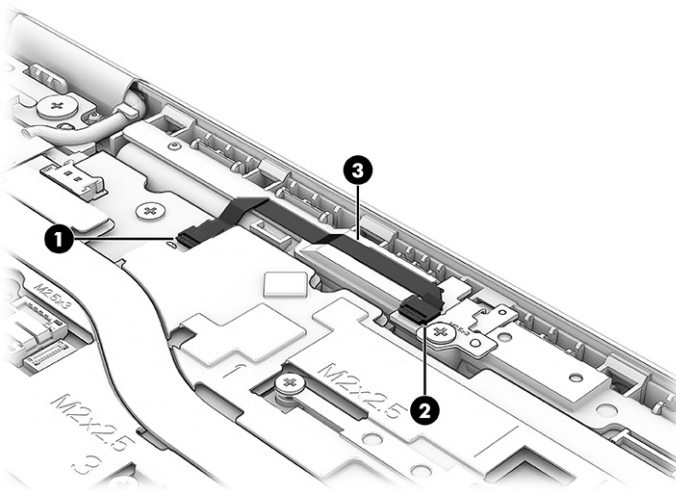

4. Remove the POGO board cable.

To install the POGO board cable, reverse the removal procedures.

POGO board

To remove the POGO board, use this procedure and illustration.

Table 5-8 POGO board description and part number

Description	Spare part number
POGO board	N02670-001

NOTE: The POGO board spare part kit does not include the POGO board bracket or POGO board cable. The POGO board bracket is included in the Bracket Kit, spare part number N37486-001. The POGO board cable is included in the Cable Kit, spare part number N05697-001.

Before removing the POGO board, follow these steps:

1. Prepare the computer for disassembly (see [Preparation for disassembly on page 44](#)).
2. Remove the bottom cover (see [Bottom cover on page 44](#)).

3. Disconnect the battery cable from the system board (see [Battery on page 45](#)).
4. Remove the POGO board cable (see [POGO board cable on page 53](#)).

Remove the POGO board:

1. Remove the Phillips M2.0 × 3.4 screw **(1)** that secures the POGO board and bracket to the top cover/keyboard.
2. Remove the POGO board bracket **(2)**.
The POGO board bracket is included in the Bracket Kit, spare part number N37486-001.
3. Remove the POGO board **(3)**.

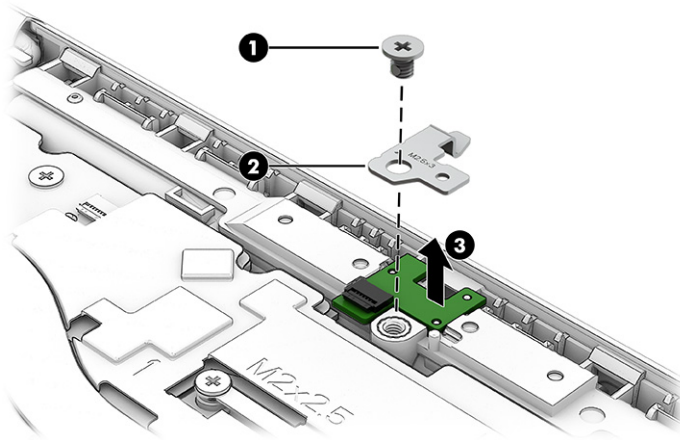

To replace the POGO board and bracket, reverse the removal procedures.

Power connector cable

To remove the power connector cable, use this procedure and illustration.

Table 5-9 Power connector cable description and part number

Description	Spare part number
Power connector cable	N02674-001

NOTE: The power connector cable spare part kit does not include the power connector cable bracket. The power connector cable bracket is included in the Bracket Kit, spare part number N37486-001.

Before removing the power connector cable, follow these steps:

1. Prepare the computer for disassembly (see [Preparation for disassembly on page 44](#)).
2. Remove the bottom cover (see [Bottom cover on page 44](#)).
3. Disconnect the battery cable from the system board (see [Battery on page 45](#)).

Remove the power connector cable:

1. Disconnect the power connector cable **(1)** from the system board.

2. Remove the Phillips M2.5 × 5.1 screw (2) that secures the power connector cable and bracket to the computer.
3. Remove the power connector cable bracket (3).
The power connector cable bracket is included in the Bracket Kit, spare part number N37486-001.
4. Remove the power connector cable (4) from the computer.

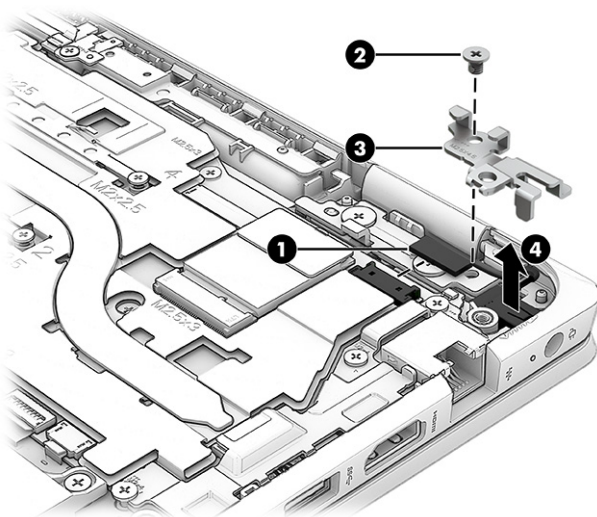

To replace the power connector cable and bracket, reverse the removal procedures.

Display assembly

To remove and disassemble the display assembly, use these procedures and illustrations.

The display assembly is available as both a full hinge-up assembly and at the subcomponent level. Full hinge-up assembly spare part information is presented in the following table. Subcomponent level spare part information is available in the subcomponent level disassembly subsection.

Table 5-10 Display assembly descriptions and part numbers

Description	Spare part number
The display assembly is available only as a whole unit.	
29.5 cm (11.6 in), HD, Brightview, touchscreen display assembly:	
Display assembly in emerald green finish for use only on computer models equipped with WWAN capability (includes WWAN antenna cables and transceivers); typical brightness: 250 nits	N35464-001
Display assembly in jet black finish for use only on computer models equipped with WWAN capability (includes WWAN antenna cables and transceivers); typical brightness: 250 nits	N35465-001
Display assembly in emerald green finish for use only on computer models equipped without WWAN capability (includes WLAN antenna cables and transceivers); typical brightness: 250 nits	N35462-001
Display assembly in jet black finish for use only on computer models equipped without WWAN capability (includes WLAN antenna cables and transceivers); typical brightness: 250 nits	N35463-001
29.5 cm (11.6 in), SVA, HD, Brightview, touchscreen display assembly:	
Display assembly in emerald green finish for use only on computer models equipped with WWAN capability (includes WWAN antenna cables and transceivers); typical brightness: 250 nits	N35460-001

Table 5-10 Display assembly descriptions and part numbers (continued)

Description	Spare part number
Display assembly in jet black finish for use only on computer models equipped with WWAN capability (includes WWAN antenna cables and transceivers); typical brightness: 250 nits	N35461-001
Display assembly in emerald green finish for use only on computer models equipped without WWAN capability (includes WLAN antenna cables and transceivers); typical brightness: 250 nits	N35458-001
Display assembly in jet black finish for use only on computer models equipped without WWAN capability (includes WLAN antenna cables and transceivers); typical brightness: 250 nits	N35459-001

Before removing the display assembly, follow these steps:

1. Prepare the computer for disassembly (see [Preparation for disassembly on page 44](#)).
2. Remove the bottom cover (see [Bottom cover on page 44](#)).
3. Disconnect the battery cable from the system board (see [Battery on page 45](#)).
4. Remove the power connector cable (see [Power connector cable on page 55](#)).

Remove the display assembly:

1. Release the ZIF connector **(1)** the webcam cable is connected to, and then disconnect the webcam cable from the system board.
2. Release the webcam cable from the retention clip **(2)** that is built into the computer.
3. Release the WWAN module cover **(3)**.

The WWAN module cover is included in the Plastics Kit, spare part number N37487-001.

4. Carefully disconnect the WWAN antenna cables **(4)** from the terminals on the WWAN module.

 **NOTE:** Computer models can have up to four WWAN antenna cables. The antenna cables have tags that identify them with a number that corresponds to a WWAN module terminal. Connect each WWAN antenna cable to the corresponding WWAN module terminal.

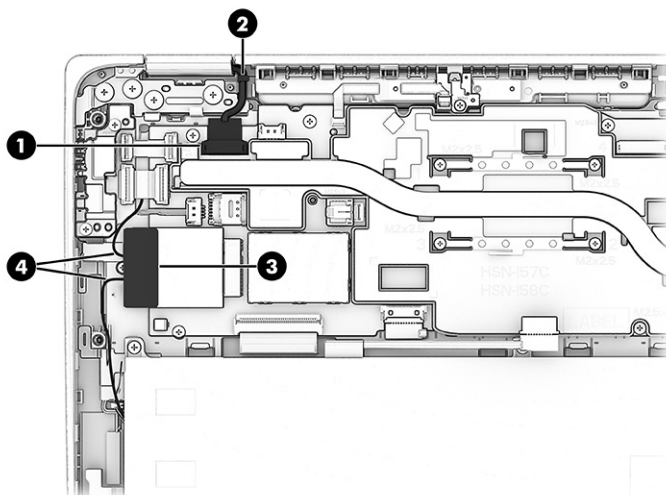

5. Release the ZIF connector **(1)** the display panel cable is connected to, and then disconnect the display panel cable from the system board.
6. Release the display panel cable from the retention clip **(2)** that is built into the computer.
7. Remove the WLAN module sponge **(3)**.
The WLAN module sponge is included in the Plastics Kit, spare part number N05694-001.
8. Carefully disconnect the WLAN antenna cables **(4)** from the terminals on the WLAN module.

 **NOTE:** Computer models have either one or two WLAN antennas. On models with two antennas, the #1 WLAN antenna cable connects to the WLAN module #1 Main terminal. The #2 WLAN antenna cable connects to the WLAN module #2 Aux terminal.

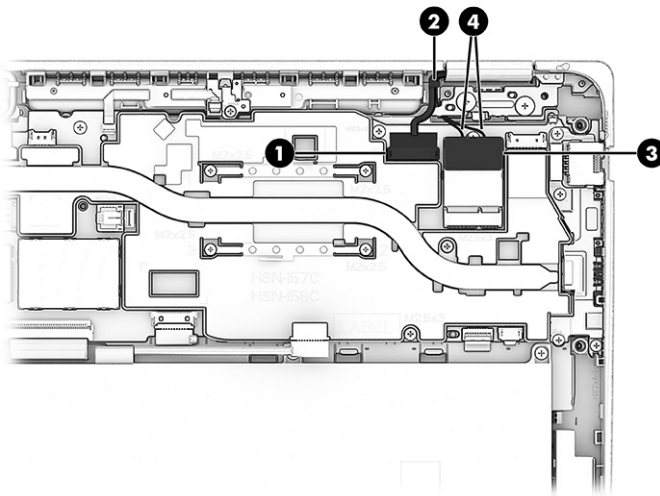

9. Remove the six Phillips M2.5 × 5.1 screws **(1)** that secure the display assembly to the computer.
10. Swing the front edge of the display assembly **(2)** away from the top cover/keyboard until it rests at a 90-degree angle.
11. Separate the display assembly **(3)** from the top cover/keyboard.

When removing the display assembly, make note of the location and position of the grounding foil strip **(4)**.

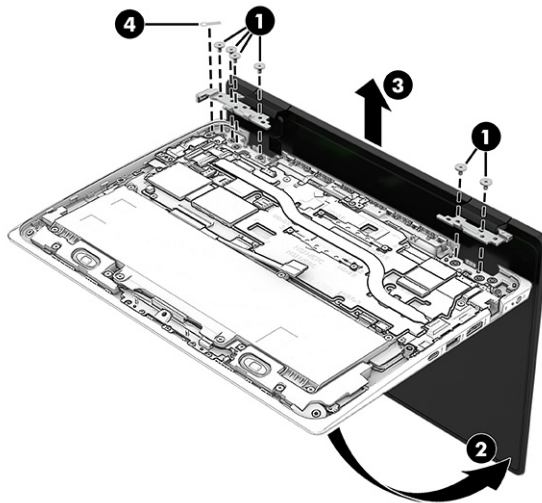

To replace the display assembly, reverse the removal procedures.

System board

To remove the system board, use these procedures and illustrations.

Table 5-11 System board descriptions and part numbers

Description	Spare part number
NOTE: All system board spare part kits include an integrated processor, a UMA graphics subsystem memory, and replacement thermal material). Replacement thermal material is also available in the Thermal Pad Kit, spare part number M86338-001.	
NOTE: The system board spare part kit does not include the system board I/O bracket. The system board I/O bracket is included in the Bracket Kit, spare part number N37486-001.	
Equipped with an Intel N200 processor (8 cores, 6 MB L3 cache, 6 W), 16 GB of system memory, and the Windows 11 operating system for use on computer models with WWAN capability	N36370-601
Equipped with an Intel N200 processor (8 cores, 6 MB L3 cache, 6 W), 16 GB of system memory, and a non-Windows operating system for use on computer models with WWAN capability	N36370-001
Equipped with an Intel N200 processor (8 cores, 6 MB L3 cache, 6 W), 16 GB of system memory, and the Windows 11 operating system for use on computer models without WWAN capability	N36369-601
Equipped with an Intel N200 processor (8 cores, 6 MB L3 cache, 6 W), 16 GB of system memory, and a non-Windows operating system for use on computer models without WWAN capability	N36369-001
Equipped with an Intel N200 processor (8 cores, 6 MB L3 cache, 6 W), 8 GB of system memory, and the Windows 11 operating system for use on computer models with WWAN capability	N36360-601
Equipped with an Intel N200 processor (8 cores, 6 MB L3 cache, 6 W), 8 GB of system memory, and a non-Windows operating system for use on computer models with WWAN capability	N36360-001
Equipped with an Intel N200 processor (8 cores, 6 MB L3 cache, 6 W), 8 GB of system memory, and the Windows 11 operating system for use on computer models without WWAN capability	N36359-601
Equipped with an Intel N200 processor (8 cores, 6 MB L3 cache, 6 W), 8 GB of system memory, and a non-Windows operating system for use on computer models without WWAN capability	N36359-001
Equipped with an Intel N200 processor (8 cores, 6 MB L3 cache, 6 W), 4 GB of system memory, and the Windows 11 operating system for use on computer models with WWAN capability	N41833-601
Equipped with an Intel N200 processor (8 cores, 6 MB L3 cache, 6 W), 4 GB of system memory, and a non-Windows operating system for use on computer models with WWAN capability	N41833-001

Table 5-11 System board descriptions and part numbers (continued)

Description	Spare part number
Equipped with an Intel N200 processor (8 cores, 6 MB L3 cache, 6 W), 4 GB of system memory, and the Windows 11 operating system for use on computer models without WWAN capability	N41834-601
Equipped with an Intel N200 processor (8 cores, 6 MB L3 cache, 6 W), 4 GB of system memory, and a non-Windows operating system for use on computer models without WWAN capability	N41834-001
Equipped with an Intel N100 processor (4 cores, 6 MB L3 cache, 6 W), 16 GB of system memory, and the Windows 11 operating system for use on computer models with WWAN capability	N36367-601
Equipped with an Intel N100 processor (4 cores, 6 MB L3 cache, 6 W), 16 GB of system memory, and a non-Windows operating system for use on computer models with WWAN capability	N36367-001
Equipped with an Intel N100 processor (4 cores, 6 MB L3 cache, 6 W), 16 GB of system memory, and the Windows 11 operating system for use on computer models without WWAN capability	N36368-601
Equipped with an Intel N100 processor (4 cores, 6 MB L3 cache, 6 W), 16 GB of system memory, and a non-Windows operating system for use on computer models without WWAN capability	N36368-001
Equipped with an Intel N100 processor (4 cores, 6 MB L3 cache, 6 W), 8 GB of system memory, and the Windows 11 operating system for use on computer models with WWAN capability	N36355-601
Equipped with an Intel N100 processor (4 cores, 6 MB L3 cache, 6 W), 8 GB of system memory, and a non-Windows operating system for use on computer models with WWAN capability	N36355-001
Equipped with an Intel N100 processor (4 cores, 6 MB L3 cache, 6 W), 8 GB of system memory, and the Windows 11 operating system for use on computer models without WWAN capability	N36356-601
Equipped with an Intel N100 processor (4 cores, 6 MB L3 cache, 6 W), 8 GB of system memory, and a non-Windows operating system for use on computer models without WWAN capability	N36356-001
Equipped with an Intel N100 processor (4 cores, 6 MB L3 cache, 6 W), 4 GB of system memory, and the Windows 11 operating system for use on computer models with WWAN capability	N41831-601
Equipped with an Intel N100 processor (4 cores, 6 MB L3 cache, 6 W), 4 GB of system memory, and a non-Windows operating system for use on computer models with WWAN capability	N41831-001
Equipped with an Intel N100 processor (4 cores, 6 MB L3 cache, 6 W), 4 GB of system memory, and the Windows 11 operating system for use on computer models without WWAN capability	N41832-601
Equipped with an Intel N100 processor (4 cores, 6 MB L3 cache, 6 W), 4 GB of system memory, and a non-Windows operating system for use on computer models without WWAN capability	N41832-001
Equipped with an Intel N100 processor (4 cores, 6 MB L3 cache, 6 W), 4 GB of system memory, 64 GB of eMMC system storage, and the Windows 11 operating system for use on computer models without WWAN capability	N36354-601
Equipped with an Intel N100 processor (4 cores, 6 MB L3 cache, 6 W), 4 GB of system memory, 64 GB of eMMC system storage, and a non-Windows operating system for use on computer models without WWAN capability	N36354-001

Before removing the system board, follow these steps:

1. Prepare the computer for disassembly (see [Preparation for disassembly on page 44](#)).
2. Remove the bottom cover (see [Bottom cover on page 44](#)).
3. Disconnect the battery cable from the system board (see [Battery on page 45](#)).

When you replace the system board, be sure to remove the following components (as applicable) from the defective system board and install them on the replacement system board:

- WWAN module (see [WWAN module on page 46](#)).

- WLAN module (see [WLAN module on page 50](#)).
- Heat sink (see [Heat sink on page 63](#)).

Remove the system board:

1. Release the two ZIF connectors **(1)** the audio jack cable and USB port cable are connected to, and then disconnect the audio jack cable and USB port cable from the system board.
2. Release the ZIF connector **(2)** the webcam cable is connected to, and then disconnect the webcam cable from the system board.
3. Release the ZIF connector **(3)** the POGO board cable is connected to, and then disconnect the POGO board cable from the system board.
4. Release the ZIF connector **(4)** the display panel cable is connected to, and then disconnect the display panel cable from the system board.
5. Remove the WLAN module sponge, and then carefully disconnect the WLAN antenna cables **(5)** from the terminals on the WLAN module.



NOTE: The WLAN module sponge is included in the Plastics Kit, spare part number N05694-001.

Computer models have either one or two WLAN antennas. On models with two antennas, the #1 WLAN antenna cable connects to the WLAN module **#1 Main** terminal. The #2 WLAN antenna cable connects to the WLAN module **#2 Aux** terminal.

6. Disconnect the power connector cable **(6)** from the system board.
7. Release the ZIF connector **(7)** the top cover webcam cable is connected to, and then disconnect the top cover webcam cable from the system board.
8. Release the ZIF connector **(8)** the touchpad cable is connected to, and then disconnect the touchpad cable from the system board.
9. Release the ZIF connector **(9)** the keyboard cable is connected to, and then disconnect the keyboard cable from the system board.
10. Disconnect the RTC battery cable **(10)** from the system board.
11. Remove the WWAN module cover, and then carefully disconnect the WWAN antenna cables **(11)** from the terminals on the WWAN module.



NOTE: The WWAN module cover is included in the Plastics Kit, spare part number N37487-001.

Computer models can have up to four WWAN antenna cables. The antenna cables have tags that identify them with a number that corresponds to a WWAN module terminal. Connect each WWAN antenna cable to the corresponding WWAN module terminal.

12. Disconnect the speaker cable (12) from the system board.

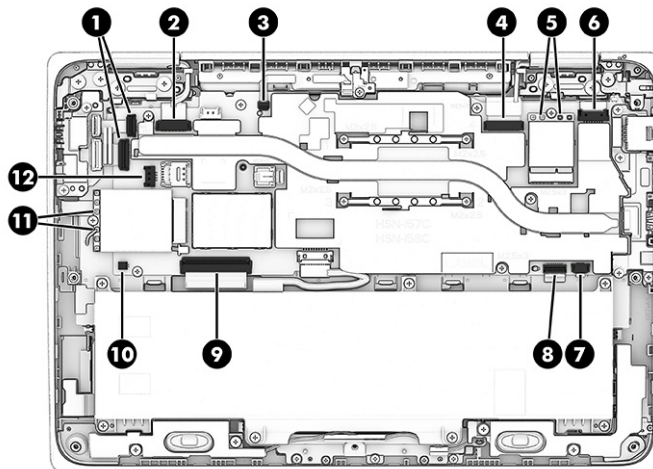

13. Remove the five Phillips M2.0 × 4.5 screws (1) that secure the system board to the computer.
14. Remove the six Phillips M2.5 × 3.4 screws (2) that secure the system board and I/O bracket to the computer.
15. Remove the I/O bracket (3).

The I/O bracket is included in the Bracket Kit, spare part number N37486-001.

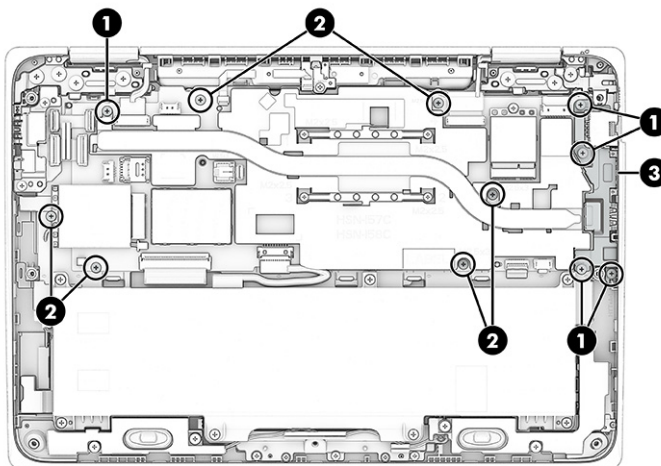

16. Lift the left edge of the system board (1) until it rests at an angle.

17. Remove the system board (2) by sliding it up and to the left at an angle.

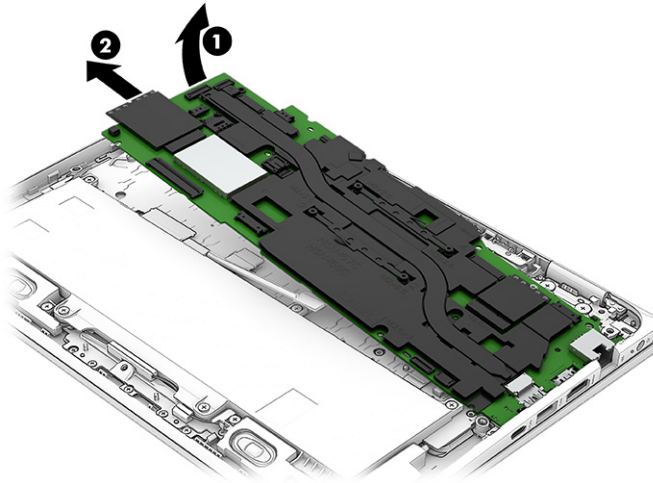

To install the system board, reverse the removal procedures.

Heat sink

To remove the heat sink, use these procedures and illustrations.

Table 5-12 Heat sink descriptions and part numbers

Description	Spare part number
Heat sink (includes replacement thermal material)	N38632-001

NOTE: Replacement thermal material is also available in the Thermal Pad Kit, spare part number M86338-001.

Before removing the heat sink, follow these steps:

1. Prepare the computer for disassembly (see [Preparation for disassembly on page 44](#)).
2. Remove the bottom cover (see [Bottom cover on page 44](#)).
3. Disconnect the battery cable from the system board (see [Battery on page 45](#)).
4. Remove the system board (see [Battery on page 45](#)).

Remove the heat sink:

1. Release the heat sink shield (1) that secures the heat sink to the system board.
2. In the order indicated on the heat sink, remove the four Phillips M2.0 × 3.0 screws (2) that secure the heat sink to the system board.

- Remove the heat sink (3).

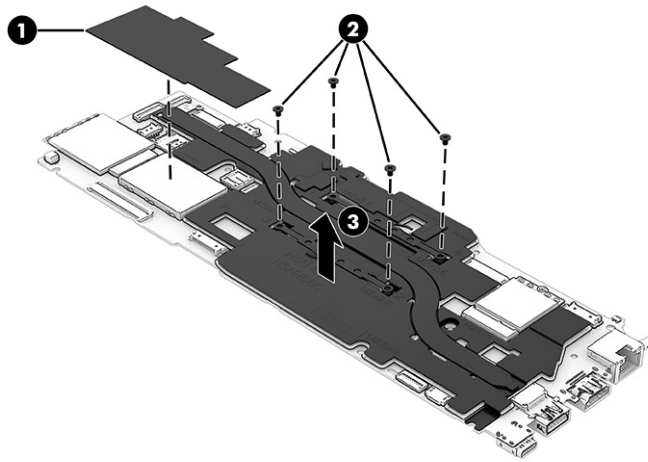

- Thoroughly clean the thermal material from the surfaces of the heat sink and the system board components each time the heat sink is removed. Replacement thermal material is included with the heat sink and system board spare part kits. The following illustrations show the replacement thermal material locations.

Thermal paste is used on the processor (1) and on the heat sink area (2) that services the processor.

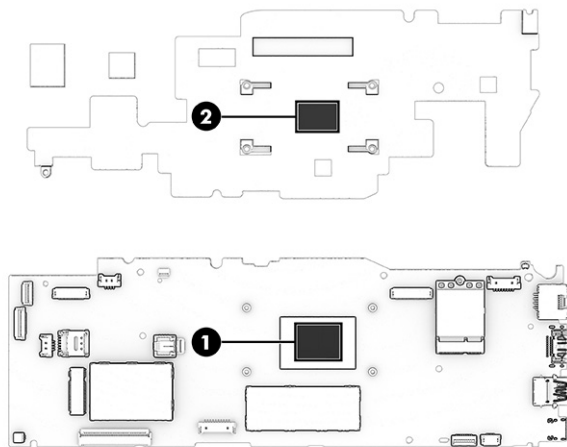

To replace the heat sink, reverse the removal procedures.

Speakers

To remove the speakers, use this procedure and illustration.

Table 5-13 Speaker description and part number

Description	Spare part number
Speaker Kit (includes left and right speakers, cables, and four rubber isolators)	N02671-001

Before removing the speakers, follow these steps:

1. Prepare the computer for disassembly (see [Preparation for disassembly on page 44](#)).
2. Remove the bottom cover (see [Bottom cover on page 44](#)).
3. Remove the battery (see [Battery on page 45](#)).

Remove the speakers:

1. Disconnect the speaker cable (1) from the system board.
2. Release the tape (2) that secures the speaker cable to the computer.
3. Release the speaker cable from the retention clip (3) that is built into the computer.
4. Release the speaker cable from the two rubber routing channels (4) that are built into the touchpad bracket.
5. Remove the four Phillips M2.0 × 6.5 shoulder screws (5) that secure the speakers to the computer.
6. Remove the speakers (6) from the computer.

 **NOTE:** When removing the speakers, make note of the location of the rubber isolator locations (7). The absence of or damage to these isolators can result in degraded speaker performance.

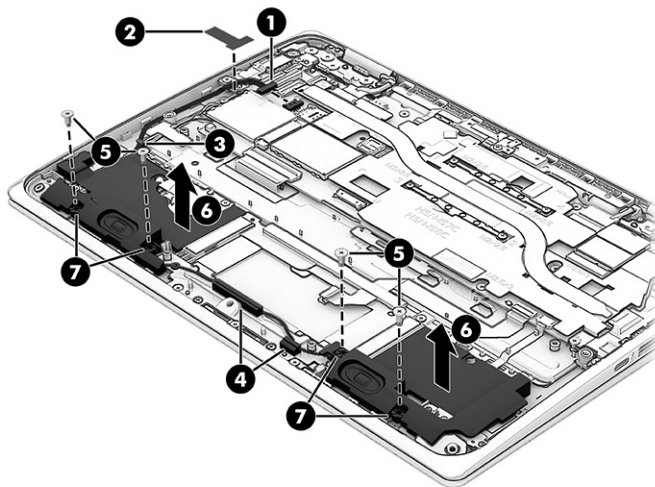

To replace the speakers, reverse the removal procedures.

RTC battery

To remove the RTC battery, use this procedure and illustration.

Table 5-14 RTC battery description and part number

Description	Spare part number
RTC battery (includes cable and double-sided adhesive)	N43797-001

Before removing the RTC battery, follow these steps:

1. Prepare the computer for disassembly (see [Preparation for disassembly on page 44](#)).
2. Remove the bottom cover (see [Bottom cover on page 44](#)).
3. Remove the battery (see [Battery on page 45](#)).

Remove the RTC battery:

1. Disconnect the RTC battery cable **(1)** from the system board.
2. Release the tape **(2)** that secures the RTC battery cable to the computer.
3. Release the RTC battery cable from the three retention clips **(3)** that are built into the computer.
4. Release the RTC battery from the three retention clips **(4)** that are built into the computer.
5. Remove the RTC battery **(5)** from the computer.

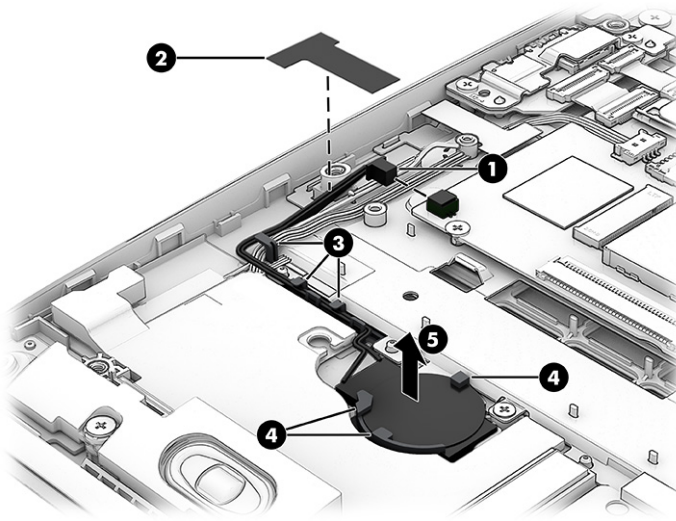

To replace the RTC battery, reverse the removal procedures.

Touchpad cable

To remove the touchpad cable, use this procedure and illustration.

The touchpad cable is available in the Cable Kit, spare part number N05697-001.

Before removing the touchpad cable, follow these steps:

1. Prepare the computer for disassembly (see [Preparation for disassembly on page 44](#)).
2. Remove the bottom cover (see [Bottom cover on page 44](#)).
3. Remove the battery (see [Battery on page 45](#)).

Remove the touchpad cable:

1. Release the ZIF connector **(1)** the touchpad cable is connected to, and then disconnect the touchpad cable from the system board.
2. Release the ZIF connector **(2)** the touchpad cable is connected to, and then disconnect the touchpad cable from the touchpad.

3. Detach the touchpad cable (3) from the computer. The touchpad cable is attached to the computer with double-sided adhesive.

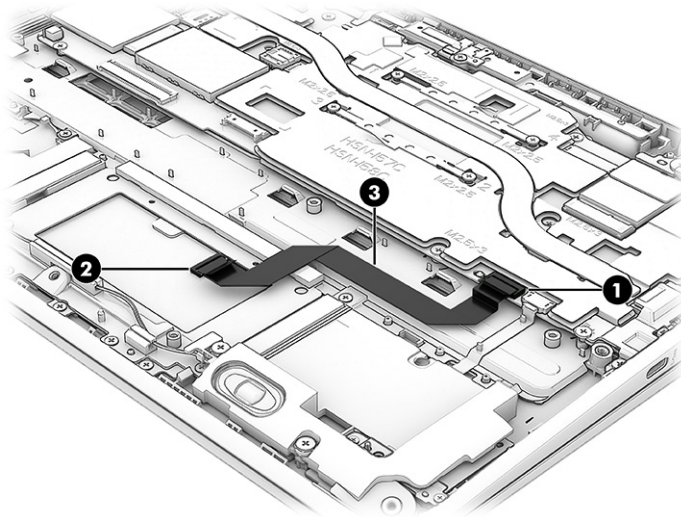

4. Remove the touchpad cable.

To replace the touchpad cable, reverse the removal procedures.

Touchpad

To remove the touchpad, use this procedure and illustration.

Table 5-15 Touchpad descriptions and part numbers

Description	Spare part number
In emerald green finish	N37488-001
In jet black finish	N00442-001

NOTE: The touchpad spare part kit does not include the touchpad bracket or the touchpad cable. The touchpad bracket is included in the Bracket Kit, spare part number N37486-001. The touchpad cable is included in the Cable Kit, spare part number N05697-001.

Before removing the touchpad, follow these steps:

1. Prepare the computer for disassembly (see [Preparation for disassembly on page 44](#)).
2. Remove the bottom cover (see [Bottom cover on page 44](#)).
3. Remove the battery (see [Battery on page 45](#)).
4. Remove the touchpad cable (see [Touchpad cable on page 66](#)).

Remove the touchpad:

1. Release the speaker cable from the two rubber routing channels (1) that are built into the touchpad bracket.
2. Release the foil grounding strips (2) that secure the touchpad bracket to the computer.
3. Remove the four Phillips M2.0 × 3.0 screws (3) that secure the touchpad to the computer.

4. Remove the touchpad bracket (4).

The touchpad bracket is included in the Bracket Kit, spare part number N37486-001.

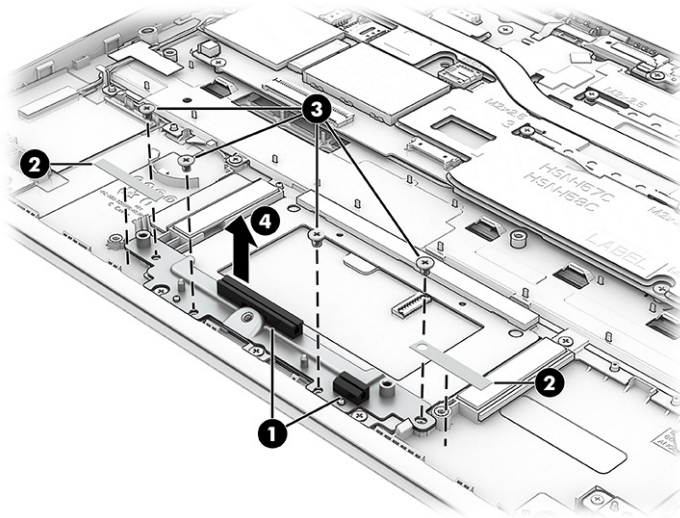

5. Release the rubber strip (1) that covers the touchpad screws.
6. Remove the six Phillips M2.0 × 2.3 screws (2) that secure the touchpad to the computer.
7. Remove the touchpad (3).

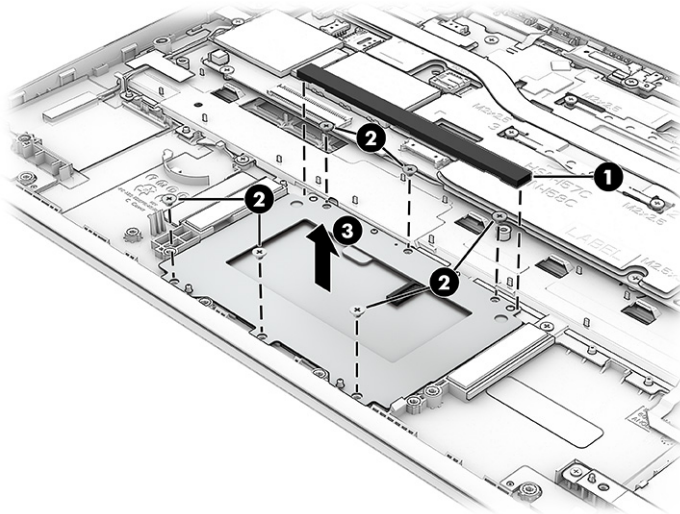

To replace the touchpad and bracket, reverse the removal procedures.

Top cover webcam

To remove the top cover webcam, use this procedure and illustration.

Table 5-16 Top cover webcam description and part number

Description	Spare part number
Top cover webcam	N00444-001

NOTE: The top cover webcam spare part kit does not include the top cover webcam cable. The top cover webcam cable is included in the Cable Kit, spare part number N19223-001.

NOTE: The top cover webcam spare part kit includes the top cover webcam bracket or top cover webcam cable. The top cover webcam bracket is included in the Bracket Kit, spare part number N37486-001. The top cover webcam cable is included in the Cable Kit, spare part number N05697-001.

Before removing the top cover webcam, follow these steps:

1. Prepare the computer for disassembly (see [Preparation for disassembly on page 44](#)).
2. Remove the bottom cover (see [Bottom cover on page 44](#)).
3. Remove the battery (see [Battery on page 45](#)).

Remove the top cover webcam:

1. Release the ZIF connector **(1)** the top cover webcam cable is connected to, and then disconnect the top cover webcam cable from the system board.
2. Remove the two Phillips M2.0 × 2.3 broadhead screws **(2)** that secure the top cover webcam to the computer.
3. Remove the top cover webcam bracket **(3)**.

The top cover webcam bracket is included in the Bracket Kit, spare part number N37486-001.

4. Remove the top cover webcam **(4)** from the computer.

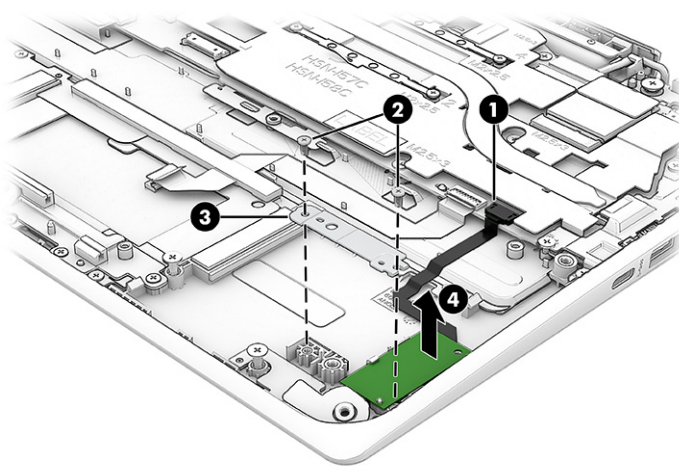

To replace the top cover webcam, reverse the removal procedures.

Top cover webcam cable

To remove the top cover webcam cable, use this procedure and illustration.



NOTE: The top cover webcam cable is included in the Cable Kit, spare part number N37486-001.

Before removing the top cover webcam cable, follow these steps:

1. Prepare the computer for disassembly (see [Preparation for disassembly on page 44](#)).
2. Remove the bottom cover (see [Bottom cover on page 44](#)).
3. Remove the battery (see [Battery on page 45](#)).
4. Remove the top cover webcam (see [Top cover webcam on page 68](#)).

Remove the top cover webcam cable:

- Release the ZIF connector **(1)** the top cover webcam cable is connected to, and then disconnect the top cover webcam cable **(2)** from the top cover webcam.

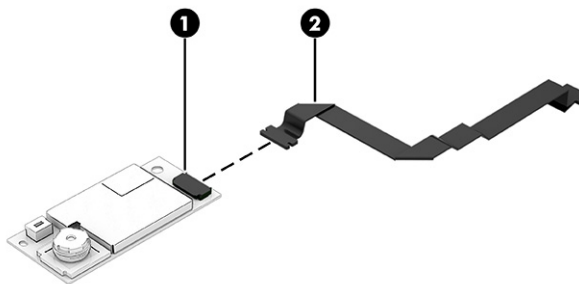

To replace the top cover webcam cable, reverse the removal procedures.

Top cover/keyboard

The top cover/keyboard remains after removing all other spare parts from the computer. In this section, the first table provides the main spare part number for the top cover/keyboards. The second table provides the country codes.

Table 5-17

Description	Spare part number
Top cover/keyboard with clickpad, pen garage, and top cover webcam in emerald green finish (spill-resistant, includes keyboard cable)	N37144-xxx
with clickpad, pen garage, and top cover webcam in jet black finish (spill-resistant, includes keyboard cable)	N37148-xxx
Top cover/keyboard with clickpad and pen garage in emerald green finish (spill-resistant, includes keyboard cable)	N37145-xxx
Top cover/keyboard with clickpad and pen garage in jet black finish (spill-resistant, includes keyboard cable)	N37149-xxx
Top cover/keyboard with clickpad and top cover webcam in emerald green finish (spill-resistant, includes keyboard cable)	N37143-xxx
Top cover/keyboard with clickpad and top cover webcam in jet black finish (spill-resistant, includes keyboard cable)	N37146-xxx
Top cover/keyboard with clickpad in emerald green finish (spill-resistant, includes keyboard cable)	N37142-xxx

Table 5-17 (continued)

Description	Spare part number
Top cover/keyboard with clickpad in jet black finish (spill-resistant, includes keyboard cable)	N37147-xxx



NOTE: The German keyboard spare part number may vary by computer model.

Table 5-18 Spare part country codes

For use in country or region	Spare part number	For use in country or region	Spare part number	For use in country or region	Spare part number
Belgium	-A41	Israel	-BB1	Slovenia	-BA1
Bulgaria	-261	Italy	-061	South Korea	-AD1
The Czech Republic and Slovakia	-FL1	Japan	-291	Spain	-071
Denmark	-081	Kazakhstan	-DF1	Sweden and Finland	-B71
Denmark, Finland, and Norway	-DH1	Latin America	-161	Switzerland	-BG1
France	-051	The Netherlands	-B31	Taiwan	-AB1
French Canada	-DB1	North Africa	-FP1	Thailand	-281
Germany	-041	Norway	-091	Turkey	-141
Greece	-151	Portugal	-131	Ukraine	-BD1
Hungary	-211	Romania	-271	United Kingdom	-031
Iceland	-DD1	Russia	-251	United States	-001
India	-D61	Saudi Arabia	-171		

6 Using Setup Utility (BIOS)

Setup Utility, or Basic Input/Output System (BIOS), controls communication between all the input and output devices on the system (such as disk drives, display, keyboard, mouse, and printer). Setup Utility (BIOS) includes settings for the types of devices installed, the startup sequence of the computer, and the amount of system and extended memory.



NOTE: To start Setup Utility on convertible computers, your computer must be in notebook mode and you must use the keyboard attached to your notebook.

Starting Setup Utility (BIOS)

You have several ways to access the Setup Utility (BIOS).



IMPORTANT: Use extreme care when making changes in Setup Utility (BIOS). Errors can prevent the computer from operating properly.

- Turn on or restart the computer and quickly press **f10**.

- or -

Turn on or restart the computer, quickly press **esc**, and then press **f10** when the Start menu is displayed.

Updating Setup Utility (BIOS)

Updated versions of Setup Utility (BIOS) might be available on the HP website. Most BIOS updates on the HP website are packaged in compressed files called *SoftPaqs*. Some download packages contain a file named *Readme.txt*, which contains information regarding installing and troubleshooting the file.

Determining the BIOS version

To decide whether you need to update Setup Utility (BIOS), first determine the BIOS version on your computer.

To reveal the BIOS version information (also known as *ROM date* and *System BIOS*), use one of these options.

- HP Support Assistant

1. Select the **Search** icon in the taskbar, type `support` in the search box, and then select the **HP Support Assistant** app.

- or -

Select the question mark icon in the taskbar.

2. Under **My notebook**, select **Specifications**.
- Setup Utility (BIOS)
 1. Start Setup Utility (BIOS) (see [Starting Setup Utility \(BIOS\) on page 72](#)).
 2. Select **Main**, and then make note of the BIOS version.
 3. Select **Exit**, select one of the options, and then follow the on-screen instructions.
 - In Windows, press **ctrl+alt+s**.

To check for later BIOS versions, see [Preparing for a BIOS update on page 73](#).

Preparing for a BIOS update

Be sure to follow all prerequisites before downloading and installing a BIOS update.

 **IMPORTANT:** To reduce the risk of damage to the computer or an unsuccessful installation, download and install a BIOS update only when the computer is connected to reliable external power using the AC adapter. Do not download or install a BIOS update while the computer is running on battery power, docked in an optional docking device, or connected to an optional power source. During the download and installation, follow these instructions:

- Do not disconnect power from the computer by unplugging the power cord from the AC outlet.
- Do not shut down the computer or initiate Sleep.
- Do not insert, remove, connect, or disconnect any device, cable, or cord.

 **NOTE:** If your computer is connected to a network, consult the network administrator before installing any software updates, especially system BIOS updates.

Downloading a BIOS update

After you review the prerequisites, you can check for and download BIOS updates.

1. Select the **Search** icon in the taskbar, type `support` in the search box, and then select the **HP Support Assistant** app.

- or -
Select the question mark icon in the taskbar.
2. Select **Updates**. The **Checking for Updates** window opens, and Windows checks for updates.
3. Follow the on-screen instructions.
4. At the download area, follow these steps:
 - a. Identify the most recent BIOS update and compare it to the BIOS version currently installed on your computer. If the update is more recent than your BIOS version, make a note of the date, name, or other identifier. You might need this information to locate the update later, after it has been downloaded to your hard drive.
 - b. Follow the on-screen instructions to download your selection to the hard drive.

Make a note of the path to the location on your hard drive where the BIOS update is downloaded. You will need to access this path when you are ready to install the update.

Installing a BIOS update

BIOS installation procedures vary. Follow any instructions that appear on the screen after the download is complete. If no instructions appear, follow these steps.

1. Select the **Search** icon in the taskbar, type `file` in the search box, and then select **File Explorer**.
2. Select your hard drive designation. The hard drive designation is typically Local Disk (C:).
3. Using the hard drive path you recorded earlier, open the folder that contains the update.
4. Double-click the file that has an `.exe` extension (for example, `filename.exe`).

The BIOS installation begins.

5. Complete the installation by following the on-screen instructions.



NOTE: After a message on the screen reports a successful installation, you can delete the downloaded file from your hard drive.

7 Computer Setup (BIOS), TPM, and HP Sure Start

HP provides several tools to help set up and protect your computer.

Using Computer Setup

Computer Setup, or Basic Input/Output System (BIOS), controls communication between all the input and output devices on the system (such as hard drives, display, keyboard, mouse, and printer). Computer Setup includes settings for types of devices installed, the startup sequence of the computer, and amount of system and extended memory.

 **NOTE:** Use extreme care when making changes in Computer Setup. Errors can prevent the computer from operating properly.

To start Computer Setup, turn on or restart the computer, and when the HP logo appears, press **f10** to enter Computer Setup.

Navigating and selecting in Computer Setup

You can navigate and select in Computer Setup using one or more methods.

- To select a menu or a menu item, use the **tab** key and the keyboard arrow keys and then press **enter**, or use a pointing device to select the item.
- To scroll up and down, select the up arrow or the down arrow in the upper-right corner of the screen, or use the up arrow key or the down arrow key on the keyboard.
- To close open dialog boxes and return to the main Computer Setup screen, press **esc**, and then follow the on-screen instructions.

To exit Computer Setup, choose one of the following methods:

- To exit Computer Setup menus without saving your changes, select **Main**, select **Ignore Changes and Exit**, and then select **Yes**.

 **NOTE:** If you are using arrow keys to highlight your choice, you must then press **enter**.

- To save your changes and exit Computer Setup menus, select **Main**, select **Save Changes and Exit**, and then select **Yes**.

 **NOTE:** If you are using arrow keys to highlight your choice, you must then press **enter**.

Your changes go into effect when the computer restarts.

Restoring factory settings in Computer Setup

To return all settings in Computer Setup to the values that were set at the factory, follow these steps.

 **NOTE:** Restoring defaults will not change the hard drive mode.

1. Start Computer Setup. See [Using Computer Setup on page 75](#).
2. Select **Main**, select **Apply Factory Defaults and Exit**, and then select **Yes**.

 **NOTE:** If you are using arrow keys to highlight your choice, you must then press **enter**.

 **NOTE:** On select products, the selections might display **Restore Defaults** instead of **Apply Factory Defaults and Exit**.

Your changes go into effect when the computer restarts.

 **NOTE:** Your password settings and security settings are not changed when you restore the factory settings.

Updating the BIOS

Updated versions of the BIOS might be available on the HP website. Most BIOS updates on the HP website are packaged in compressed files called *SoftPaqs*.

Some download packages contain a file named *Readme.txt*, which contains information regarding installing and troubleshooting the file.

Determining the BIOS version

To decide whether you need to update Computer Setup (BIOS), first determine the BIOS version on your computer.

If you are already in Windows, you can access BIOS version information (also known as *ROM date* and *System BIOS*) by pressing **fn+esc** (select products only). Or you can use Computer Setup.

1. Start Computer Setup. See [Using Computer Setup on page 75](#).
2. Select **Main**, and then select **System Information**.
3. To exit Computer Setup menus without saving your changes, select **Main**, select **Ignore Changes and Exit**, and then select **Yes**.

 **NOTE:** If you are using arrow keys to highlight your choice, you must then press **enter**.

To check for later BIOS versions, see [Preparing for a BIOS update on page 76](#).

Preparing for a BIOS update

Be sure to follow all prerequisites before downloading and installing a BIOS update.

 **IMPORTANT:** To reduce the risk of damage to the computer or an unsuccessful installation, download and install a BIOS update only when the computer is connected to reliable external power using the AC adapter. Do not download or install a BIOS update while the computer is running on battery power, docked in an optional docking device, or connected to an optional power source. During the download and installation, follow these instructions:

Do not disconnect power on the computer by unplugging the power cord from the AC outlet.

Do not shut down the computer or initiate Sleep.

Do not insert, remove, connect, or disconnect any device, cable, or cord.

Downloading a BIOS update

After you review the prerequisites, you can check for and download BIOS updates.

1. Select the **Search** icon in the taskbar, type `support` in the search box, and then select the **HP Support Assistant** app.

- or -
Select the question mark icon (select products only) in the taskbar.
2. Select **Updates**, and then select **Check for updates and messages**.
3. Follow the on-screen instructions.
4. At the download area, follow these steps:
 - a. Identify the most recent BIOS update and compare it to the BIOS version currently installed on your computer. Make a note of the date, name, or other identifier. You might need this information to locate the update later, after it has been downloaded to your hard drive.
 - b. Follow the on-screen instructions to download your selection to the hard drive.

Make a note of the path to the location on your hard drive where the BIOS update is downloaded. You will need to access this path when you are ready to install the update.



NOTE: If you connect your computer to a network, consult the network administrator before installing any software updates, especially system BIOS updates.

Installing a BIOS update

BIOS installation procedures vary. Follow any instructions that are displayed on the screen after the download is complete. If no instructions are displayed, follow these steps.

1. Select the **Search** icon in the taskbar, type `file` in the search box, and then select **File Explorer**.
2. Select your hard drive designation. The hard drive designation is typically Local Disk (C:).
3. Using the hard drive path you recorded earlier, open the folder that contains the update.
4. Double-click the file that has an `.exe` extension (for example, `filename.exe`).

The BIOS installation begins.
5. Complete the installation by following the on-screen instructions.



NOTE: After a message on the screen reports a successful installation, you can delete the downloaded file from your hard drive.

Changing the boot order using the f9 prompt

To dynamically choose a boot device for the current startup sequence, follow these steps.

1. Access the Boot Device Options menu:
 - Turn on or restart the computer, and when the HP logo appears, press **f9** to enter the Boot Device Options menu.
2. Select a boot device, press **enter**, and then follow the on-screen instructions.

TPM BIOS settings (select products only)

TPM provides additional security for your computer. You can modify the TPM settings in Computer Setup (BIOS).

 **IMPORTANT:** Before enabling Trusted Platform Module (TPM) functionality on this system, you must ensure that your intended use of TPM complies with relevant local laws, regulations and policies, and approvals or licenses must be obtained if applicable. For any compliance issues arising from your operation or usage of TPM that violates the previously mentioned requirement, you shall bear all the liabilities wholly and solely. HP will not be responsible for any related liabilities.

 **NOTE:** If you change the TPM setting to Hidden, TPM is not visible in the operating system.

To access TPM settings in Computer Setup:

1. Start Computer Setup. See [Using Computer Setup on page 75](#).
2. Select **Security**, select **TPM Embedded Security**, and then follow the on-screen instructions.

Using HP Sure Start (select products only)

Select computer models are configured with HP Sure Start, a technology that monitors the computer's BIOS for attacks or corruption. If the BIOS becomes corrupted or is attacked, HP Sure Start automatically restores the BIOS to its previously safe state, without user intervention.

HP Sure Start is configured and already enabled so that most users can use the HP Sure Start default configuration. Advanced users can customize the default configuration.

To access the latest documentation on HP Sure Start, go to <http://www.hp.com/support>. Select **Find your product**, and then follow the on-screen instructions.

8 Backing up, restoring, and recovering

You can use Windows tools or HP software to back up your information, create a restore point, reset your computer, create recovery media, or restore your computer to its factory state. Performing these standard procedures can return your computer to a working state faster.

 **IMPORTANT:** If you are performing recovery procedures on a tablet, the tablet battery must be at least 70% charged before you start the recovery process.

 **IMPORTANT:** For a tablet with a detachable keyboard, connect the tablet to the keyboard base before beginning any recovery process.

Backing up information and creating recovery media

These methods of creating recovery media and backups are available on select products only.

Using Windows tools for backing up

HP recommends that you back up your information immediately after initial setup. You can do this task either using Windows Backup locally with an external USB flash drive or using online tools.

 **NOTE:** If computer storage is 32 GB or less, Microsoft® System Restore is disabled by default.

Using the HP Cloud Recovery Download Tool to create recovery media (select products only)

You can use the HP Cloud Recovery Download Tool to create HP Recovery media on a bootable USB flash drive.

For details:

- Go to <http://www.hp.com>, search for HP Cloud Recovery, and then select the result that matches the type of computer that you have.

 **NOTE:** If you cannot create recovery media yourself, contact support to obtain recovery discs. Go to <http://www.hp.com/support>, select your country or region, and then follow the on-screen instructions.

 **IMPORTANT:** HP recommends that you follow the [Restoring and recovery methods on page 80](#) to restore your computer before you obtain and use the HP recovery discs. Using a recent backup can return your machine to a working state sooner than using the HP recovery discs. After the system is restored, reinstalling all the operating system software released since your initial purchase can be a lengthy process.

Restoring and recovering your system

You have several tools available to recover your system both within and outside of Windows if the desktop cannot load.

HP recommends that you attempt to restore your system using the [Restoring and recovery methods on page 80](#).

Creating a system restore

System Restore is available in Windows. The System Restore software can automatically or manually create restore points, or snapshots, of the system files and settings on the computer at a particular point.

When you use System Restore, it returns your computer to its state at the time you made the restore point. Your personal files and documents should not be affected.

Restoring and recovery methods

After you run the first method, test to see whether the issue still exists before you proceed to the next method, which might now be unnecessary.

1. Run a Microsoft System Restore.
2. Run Reset this PC.



NOTE: The options **Remove everything** and then **Fully clean the drive** can take several hours to complete and leave no information on your computer. It is the safest way to reset your computer before you recycle it.

3. Recover using HP Recovery media. For more information, see [Recovering using HP Recovery media on page 80](#).

For more information about the first two methods, see the Get Help app:

- Select the **Start** button, select **All apps**, select the **Get Help** app, and then enter the task you want to perform.



NOTE: You must be connected to the internet to access the Get Help app.

Recovering using HP Recovery media

You can use HP Recovery media to recover the operating system and drivers that were installed at the factory. On select products, you can create recovery media on a bootable USB flash drive using the HP Cloud Recovery Download Tool.

For details, see [Using the HP Cloud Recovery Download Tool to create recovery media \(select products only\) on page 79](#).



NOTE: If you cannot create recovery media yourself, contact support to obtain recovery discs. Go to <http://www.hp.com/support>, select your country or region, and then follow the on-screen instructions.

To recover your system:

- Insert the HP Recovery media, and then restart the computer.

 **NOTE:** HP recommends that you follow the [Restoring and recovery methods on page 80](#) to restore your computer before you obtain and use the HP recovery discs. Using a recent backup can return your machine to a working state sooner than using the HP recovery discs. After the system is restored, reinstalling all the operating system software released since your initial purchase can be a lengthy process.

Changing the computer boot order

If your computer does not restart using the HP Recovery media, you can change the computer boot order, which is the order of devices listed in BIOS for startup information. You can select an optical drive or a USB flash drive, depending on the location of your HP Recovery media.

 **IMPORTANT:** For a tablet with a detachable keyboard, connect the tablet to the keyboard base before beginning these steps.

To change the boot order:

1. Insert the HP Recovery media.
2. Access the system **Startup** menu.
 - For computers or tablets with keyboards attached, turn on or restart the computer or tablet, quickly press **esc**, and then press **f9** for boot options.
 - For tablets without keyboards, turn on or restart the tablet, quickly press and hold the volume up button, and then select **f9**.

– or –

Turn on or restart the tablet, quickly press and hold the volume down button, and then select **f9**.
3. Select the optical drive or USB flash drive from which you want to boot, and then follow the on-screen instructions.

Using HP Sure Recover (select products only)

Select computer models are configured with HP Sure Recover, a PC operating system (OS) recovery solution built into the hardware and software. HP Sure Recover can fully restore the HP OS image without installed recovery software.

Using HP Sure Recover, an administrator or user can restore the system and install:

- Latest version of the operating system
- Platform-specific device drivers
- Software applications, in the case of a custom image

To access the latest documentation for HP Sure Recover, go to <http://www.hp.com/support>. Follow the on-screen instructions to find your product and locate your documentation.

9 Using HP PC Hardware Diagnostics

You can use the HP PC Hardware Diagnostics utility to determine whether your computer hardware is running properly. The three versions are HP PC Hardware Diagnostics Windows, HP PC Hardware Diagnostics UEFI (Unified Extensible Firmware Interface), and (for select products only) Remote HP PC Hardware Diagnostics UEFI, a firmware feature.

Using HP PC Hardware Diagnostics Windows (select products only)

HP PC Hardware Diagnostics Windows is a Windows-based utility that allows you to run diagnostic tests to determine whether the computer hardware is functioning properly. The tool runs within the Windows operating system to diagnose hardware failures.

If HP PC Hardware Diagnostics Windows is not installed on your computer, you must download and install it. To download HP PC Hardware Diagnostics Windows, see [Downloading HP PC Hardware Diagnostics Windows on page 83](#).

Using an HP PC Hardware Diagnostics Windows hardware failure ID code

When HP PC Hardware Diagnostics Windows detects a failure that requires hardware replacement, a 24-digit failure ID code is generated for select component tests. For interactive tests, such as keyboard, mouse, or audio and video palette, you must perform troubleshooting steps before you can receive a failure ID.

- You have several options after you receive a failure ID:
 - Select **Next** to open the Event Automation Service (EAS) page, where you can log the case.
 - Scan the QR code with your mobile device, which takes you to the EAS page, where you can log the case.
 - Select the box next to the 24-digit failure ID to copy your failure code and send it to support.

Accessing HP PC Hardware Diagnostics Windows

After HP PC Hardware Diagnostics Windows is installed, you can access it from HP Support Assistant or the Start menu.

Accessing HP PC Hardware Diagnostics Windows from HP Support Assistant

After HP PC Hardware Diagnostics Windows is installed, follow these steps to access it from HP Support Assistant:

1. Complete one of the following tasks:
 - Select the **Search** icon in the taskbar, type `support` in the search box, and then select the **HP Support Assistant** app.
 - Select the question mark icon in the taskbar.
2. Select **Fixes & Diagnostics**.
3. Select **Run hardware diagnostics**, and then select **Launch**.
4. When the tool opens, select the type of diagnostic test that you want to run, and then follow the on-screen instructions.

 **NOTE:** To stop a diagnostic test, select **Cancel**.

Accessing HP PC Hardware Diagnostics Windows from the Start menu (select products only)

After HP PC Hardware Diagnostics Windows is installed, follow these steps to access it from the Start menu:

1. Select the **Start** button, and then select **All apps**.
2. Select **HP PC Hardware Diagnostics Windows**.
3. When the tool opens, select the type of diagnostic test that you want to run, and then follow the on-screen instructions.

 **NOTE:** To stop a diagnostic test, select **Cancel**.

Downloading HP PC Hardware Diagnostics Windows

The HP PC Hardware Diagnostics Windows downloading instructions are provided in English only. You must use a Windows computer to download this tool because only .exe files are provided.

Downloading the latest HP PC Hardware Diagnostics Windows version from HP

To download HP PC Hardware Diagnostics Windows from HP, follow these steps:

1. Go to <http://www.hp.com/go/techcenter/pcdiags>. The HP PC Diagnostics home page is displayed.
2. Select **Download HP Diagnostics Windows**, and then select the specific Windows diagnostics version to download to your computer or a USB flash drive.

The tool downloads to the selected location.

Downloading the HP PC Hardware Diagnostics Windows from the Microsoft Store

You can download the HP PC Hardware Diagnostics Windows from the Microsoft Store:

1. Select the Microsoft Store app on your desktop or select the **Search** icon in the taskbar, and then type `Microsoft Store` in the search box.
2. Type `HP PC Hardware Diagnostics Windows` in the **Microsoft Store** search box.
3. Follow the on-screen directions.

The tool downloads to the selected location.

Downloading HP Hardware Diagnostics Windows by product name or number (select products only)

You can download HP PC Hardware Diagnostics Windows by product name or number.

 **NOTE:** For some products, you might have to download the software to a USB flash drive by using the product name or number.

1. Go to <http://www.hp.com/support>.
2. Select **Software and Drivers**, select your type of product, and then enter the product name or number in the search box that is displayed.
3. In the **Diagnostics** section, select **Download**, and then follow the on-screen instructions to select the specific Windows diagnostics version to be downloaded to your computer or USB flash drive.

The tool downloads to the selected location.

Installing HP PC Hardware Diagnostics Windows

To install HP PC Hardware Diagnostics Windows, navigate to the folder on your computer or the USB flash drive where the .exe file downloaded, double-click the .exe file, and then follow the on-screen instructions.

Using HP PC Hardware Diagnostics UEFI

HP PC Hardware Diagnostics Unified Extensible Firmware Interface (UEFI) allows you to run diagnostic tests to determine whether the computer hardware is functioning properly. The tool runs outside the operating system so that it can isolate hardware failures from issues that are caused by the operating system or other software components.

 **NOTE:** For some products, you must use a Windows computer and a USB flash drive to download and create the HP UEFI support environment because only .exe files are provided. For more information, see [Downloading HP PC Hardware Diagnostics UEFI to a USB flash drive on page 85](#).

If your PC does not start in Windows, you can use HP PC Hardware Diagnostics UEFI to diagnose hardware issues.

Using an HP PC Hardware Diagnostics UEFI hardware failure ID code

When HP PC Hardware Diagnostics UEFI detects a failure that requires hardware replacement, a 24-digit failure ID code is generated.

For assistance in solving the problem:

- Select **Contact HP**, accept the HP privacy disclaimer, and then use a mobile device to scan the failure ID code that appears on the next screen. The HP Customer Support - Service Center page appears with your failure ID and product number automatically filled in. Follow the on-screen instructions.

- or -

Contact support, and provide the failure ID code.

 **NOTE:** To start diagnostics on a convertible computer, your computer must be in notebook mode, and you must use the attached keyboard.

 **NOTE:** If you need to stop a diagnostic test, press **esc**.

Starting HP PC Hardware Diagnostics UEFI

To start HP PC Hardware Diagnostics UEFI, follow this procedure.

1. Turn on or restart the computer, and quickly press **esc**.
2. Press **f2**.

The BIOS searches three places for the diagnostic tools, in the following order:

- a. Connected USB flash drive



NOTE: To download the HP PC Hardware Diagnostics UEFI tool to a USB flash drive, see [Downloading the latest HP PC Hardware Diagnostics UEFI version on page 85](#).

- b. Hard drive
- c. BIOS

3. When the diagnostic tool opens, select the type of diagnostic test that you want to run, and then follow the on-screen instructions.

Downloading HP PC Hardware Diagnostics UEFI to a USB flash drive

Downloading HP PC Hardware Diagnostics UEFI to a USB flash drive can be useful in some situations.

- HP PC Hardware Diagnostics UEFI is not included in the preinstallation image.
- HP PC Hardware Diagnostics UEFI is not included in the HP Tool partition.
- The hard drive is damaged.



NOTE: The HP PC Hardware Diagnostics UEFI downloading instructions are provided in English only, and you must use a Windows computer to download and create the HP UEFI support environment because only .exe files are provided.

Downloading the latest HP PC Hardware Diagnostics UEFI version

To download the latest HP PC Hardware Diagnostics UEFI version to a USB flash drive, follow this procedure:

1. Go to <http://www.hp.com/go/techcenter/pcdiags>. The HP PC Diagnostics home page is displayed.
2. Select **Download HP Diagnostics UEFI**, and then select **Run**.

Downloading HP PC Hardware Diagnostics UEFI by product name or number (select products only)

You can download HP PC Hardware Diagnostics UEFI by product name or number (select products only) to a USB flash drive.



NOTE: For some products, you might have to download the software to a USB flash drive by using the product name or number.

1. Go to <http://www.hp.com/support>.
2. Enter the product name or number, select your computer, and then select your operating system.

3. In the **Diagnostics** section, follow the on-screen instructions to select and download the specific UEFI Diagnostics version for your computer.

Using Remote HP PC Hardware Diagnostics UEFI settings (select products only)

Remote HP PC Hardware Diagnostics UEFI is a firmware (BIOS) feature that downloads HP PC Hardware Diagnostics UEFI to your computer. It can then run the diagnostics on your computer, and it might upload results to a preconfigured server.

For more information about Remote HP PC Hardware Diagnostics UEFI, go to <http://www.hp.com/go/techcenter/pcdiags>, and then select **Find out more**.

Downloading Remote HP PC Hardware Diagnostics UEFI

HP Remote PC Hardware Diagnostics UEFI is also available as a SoftPaq that you can download to a server.

Downloading the latest Remote HP PC Hardware Diagnostics UEFI version

You can download the latest HP PC Hardware Diagnostics UEFI version to a USB flash drive.

1. Go to <http://www.hp.com/go/techcenter/pcdiags>. The HP PC Diagnostics home page is displayed.
2. Select **Download Remote Diagnostics**, and then select **Run**.

Downloading Remote HP PC Hardware Diagnostics UEFI by product name or number

You can download HP Remote PC Hardware Diagnostics UEFI by product name or number.



NOTE: For some products, you might have to download the software by using the product name or number.

1. Go to <http://www.hp.com/support>.
2. Select **Software and Drivers**, select your type of product, enter the product name or number in the search box that is displayed, select your computer, and then select your operating system.
3. In the **Diagnostics** section, follow the on-screen instructions to select and download the **Remote UEFI** version for the product.

Customizing Remote HP PC Hardware Diagnostics UEFI settings

Using the Remote HP PC Hardware Diagnostics setting in Computer Setup (BIOS), you can perform several customizations.

- Set a schedule for running diagnostics unattended. You can also start diagnostics immediately in interactive mode by selecting **Execute Remote HP PC Hardware Diagnostics**.
- Set the location for downloading the diagnostic tools. This feature provides access to the tools from the HP website or from a server that has been preconfigured for use. Your computer does not require the traditional local storage (such as a hard drive or USB flash drive) to run remote diagnostics.
- Set a location for storing the test results. You can also set the user name and password that you use for uploads.

- Display status information about the diagnostics run previously.

To customize Remote HP PC Hardware Diagnostics UEFI settings, follow these steps:

1. Turn on or restart the computer, and when the HP logo appears, press **f10** to enter Computer Setup.
2. Select **Advanced**, and then select **Settings**.
3. Make your customization selections.
4. Select **Exit**, then select **Save Changes and Exit** to save your settings.

Your changes take effect when the computer restarts.

10 Specifications

This chapter provides specifications for your computer system.

Computer specifications

This section provides specifications for your computer. When you travel with your computer, the computer dimensions and weights, as well as input power ratings and operating specifications, provide helpful information.

Table 10-1 Computer specifications

	Metric	U.S.
Dimensions		
Width	297.0 mm	11.7 in
Depth	203.7 mm	8.0 in
Height (front to back)	21.2 mm	0.8 in
Weight		
	1.47 kg	3.24 lb
Input power		
Operating voltage and current	19.5 V dc @ 2.31 A - 45 W	
	19.5 V dc @ 3.33 A - 65 W	
Temperature		
Operating	5°C to 35°C	41°F to 95°F
Nonoperating	-20°C to 60°C	-4°F to 140°F
Relative humidity (noncondensing)		
Operating	10% to 90%	
Nonoperating	5% to 95%	
Maximum altitude (unpressurized)		
Operating	-15 m to 3,048 m	-50 ft to 10,000 ft
Nonoperating	-15 m to 12,192 m	-50 ft to 40,000 ft
NOTE: Applicable product safety standards specify thermal limits for plastic surfaces. The device operates well within this range of temperatures.		

29.5 cm (11.6 in) display specifications

This section provides specifications for your display.

Table 10-2 Display specifications

	Metric	U.S.
Active diagonal size	29.5 cm	11.6 in
Resolution	1366 × 768 (UWVA)	
Surface treatment	Brightview (OLED panel)	
Brightness	250 nits (UWVA, eDP panels)	
Viewing angle	UWVA	
Backlight	OLED	
Display panel interface	eDP	

11 Statement of memory volatility

For general information regarding nonvolatile memory in HP business computers, and to restore nonvolatile memory that can contain personal data after the system has been turned off and the hard drive has been removed, use these instructions.

HP business computer products that use Intel®-based or AMD®-based system boards contain volatile DDR memory. The amount of nonvolatile memory present in the system depends upon the system configuration. Intel-based and AMD-based system boards contain nonvolatile memory subcomponents as originally shipped from HP, with the following assumptions:

- No subsequent modifications were made to the system.
- No applications, features, or functionality were added to or installed on the system.

Following system shutdown and removal of all power sources from an HP business computer system, personal data can remain on volatile system memory (DIMMs) for a finite period of time and also remains in nonvolatile memory. Use the following steps to remove personal data from the computer, including the nonvolatile memory found in Intel-based and AMD-based system boards.



NOTE: If your tablet has a keyboard base, connect to the keyboard base before beginning steps in this chapter.

Current BIOS steps

Use these instructions to restore nonvolatile memory.

1. Follow these steps to restore the nonvolatile memory that can contain personal data. Restoring or reprogramming nonvolatile memory that does not store personal data is neither necessary nor recommended.
 - a. Turn on or restart the computer, and then quickly press **esc**.



NOTE: If the system has a BIOS administrator password, type the password at the prompt.

- b. Select **Main**, select **Apply Factory Defaults and Exit**, and then select **Yes** to load defaults. The computer restarts.
- c. During the restart, press **esc** while the "Press the ESC key for Startup Menu" message is displayed at the bottom of the screen.



NOTE: If the system has a BIOS administrator password, type the password at the prompt.

- d. Select the **Security** menu, select **Restore Security Settings to Factory Defaults**, and then select **Yes** to restore security level defaults. The computer reboots.
- e. During the reboot, press **esc** while the "Press the ESC key for Startup Menu" message is displayed at the bottom of the screen.



NOTE: If the system has a BIOS administrator password, type the password at the prompt.

- f. If an asset or ownership tag is set, select the **Security** menu and scroll down to the **Utilities** menu. Select **System IDs**, and then select **Asset Tracking Number**. Clear the tag, and then make the selection to return to the prior menu.
- g. If a DriveLock password is set, select the **Security** menu, and scroll down to **Hard Drive Utilities** under the **Utilities** menu. Select **Hard Drive Utilities**, select **DriveLock**, and then clear the check box for **DriveLock password on restart**. Select **OK** to proceed.
- h. Select the **Main** menu, and then select **Reset BIOS Security to factory default**. Select **Yes** at the warning message. The computer reboots.
- i. During the reboot, press **esc** while the "Press the ESC key for Startup Menu" message is displayed at the bottom of the screen.



NOTE: If the system has a BIOS administrator password, type the password at the prompt.

- j. Select the **Main** menu, select **Apply Factory Defaults and Exit**, select **Yes** to save changes and exit, and then select **Shutdown**.
- k. Reboot the system. If the system has a Trusted Platform Module (TPM), fingerprint reader, or both, one or two prompts will appear—one to clear the TPM and the other to Reset Fingerprint Sensor. Press or tap **f1** to accept or **f2** to reject.
- l. Remove all power and system batteries for at least 24 hours.

2. Complete one of the following:

- Remove and retain the storage drive.
- or -
- Clear the drive contents by using a third-party utility designed to erase data from an SSD.
- or -
- Clear the contents of the drive by using the following BIOS Setup Secure Erase command option steps:



NOTE: If you clear data using Secure Erase, you cannot recover it.

- a. Turn on or restart the computer, and then quickly press **esc**.
- b. Select the **Security** menu and scroll down to the **esc** menu.
- c. Select **Hard Drive Utilities**.
- d. Under **Utilities**, select **Secure Erase**, select the hard drive storing the data you want to clear, and then follow the on-screen instructions to continue.

- or -

Clear the contents of the drive using the following Disk Sanitizer commands steps:

- i. Turn on or restart the computer, and then quickly press **esc**.
- ii. Select the **Security** menu and scroll down to the **Utilities** menu.
- iii. Select **Hard Drive Utilities**.
- iv. Under **Utilities**, select **Disk Sanitizer**, select the hard drive with the data that you want to clear, and then follow the on-screen instructions to continue.



NOTE: The amount of time it takes for Disk Sanitizer to run can take several hours. Plug the computer into an AC outlet before starting.

Nonvolatile memory usage

Use this table to troubleshoot nonvolatile memory usage.

Table 11-1 Troubleshooting steps for nonvolatile memory usage

Nonvolatile memory type	Amount (Size)	Does this memory store customer data?	Does this memory retain data when power is removed?	What is the purpose of this memory?	How is data entered into this memory?	How is this memory write-protected?
HP Sure Start flash (select models only)	8 MB	No	Yes	Provides protected backup of critical System BIOS code, EC firmware, and critical computer configuration data for select platforms that support HP Sure Start. For more information, see Using HP Sure Start (select products only) on page 96 .	Data cannot be written to this device via the host processor. The content is managed solely by the HP Sure Start Embedded Controller.	This memory is protected by the HP Sure Start Embedded Controller.
Real Time Clock (RTC) battery backed-up CMOS configuration memory	256 bytes	No	Yes	Stores system date and time and noncritical data.	RTC battery backed-up CMOS is programmed using Computer Setup (BIOS), or by changing the Windows date & time.	This memory is not write-protected.

Table 11-1 Troubleshooting steps for nonvolatile memory usage (continued)

Nonvolatile memory type	Amount (Size)	Does this memory store customer data?	Does this memory retain data when power is removed?	What is the purpose of this memory?	How is data entered into this memory?	How is this memory write-protected?
Controller (NIC) EEPROM	64 KB (not customer accessible)	No	Yes	Stores NIC configuration and NIC firmware.	NIC EEPROM is programmed using a utility from the NIC vendor that can be run from DOS.	A utility must be used to write data to this memory and is available from the NIC vendor. Writing data to this ROM in an inappropriate manner will render the NIC nonfunctional.
DIMM Serial Presence Detect (SPD) configuration data	256 bytes per memory module, 128 bytes programmable (not customer accessible)	No	Yes	Stores memory module information.	DIMM SPD is programmed by the memory vendor.	Data cannot be written to this memory when the module is installed in a computer. The specific write-protection method varies by memory vendor.
System BIOS	9 MB	Yes	Yes	Stores system BIOS code and computer configuration data.	System BIOS code is programmed at the factory. Code is updated when the system BIOS is updated. Configuration data and settings are entered using the Computer Setup (BIOS) or a custom utility.	NOTE: Writing data to this ROM in an inappropriate manner can render the computer nonfunctional. A utility must be used for writing data to this memory and is available on the HP website; go to http://www.hp.com/support . Select Find your product , and then follow the on-screen instructions.

Table 11-1 Troubleshooting steps for nonvolatile memory usage (continued)

Nonvolatile memory type	Amount (Size)	Does this memory store customer data?	Does this memory retain data when power is removed?	What is the purpose of this memory?	How is data entered into this memory?	How is this memory write-protected?
Intel Management Engine Firmware (present only in select Elite or Z models. For more information, go to http://www.hp.com/support . Select Identify your product for manuals and specific product information , and then follow the on-screen instructions.)	1.5 MB or 7 MB	Yes	Yes	Stores Management Engine Code, Settings, Provisioning Data and iAMT third-party data store.	Management Engine Code is programmed at the factory. Code is updated via Intel secure firmware update utility. Unique Provisioning Data can be entered at the factory or by an administrator using the Management Engine (MEBx) setup utility. The third-party data store contents can be populated by a remote management console or local applications that have been registered by an administrator to have access to the space.	The Intel chipset is configured to enforce hardware protection to block all direct read-write access to this area. An Intel utility must be used for updating the firmware. Only firmware updates digitally signed by Intel can be applied using this utility.
Bluetooth flash (select products only)	2 megabits	No	Yes	Stores Bluetooth configuration and firmware.	Bluetooth flash is programmed at the factory. Tools for writing data to this memory are not publicly available but can be obtained from the silicon vendor.	A utility must be used for writing data to this memory and is made available through newer versions of the driver whenever the flash requires an upgrade.
802.11 WLAN EEPROM	4 kilobits to 8 kilobits	No	Yes	Stores configuration and calibration data.	802.11 WLAN EEPROM is programmed at the factory. Tools for writing data to this memory are not made public.	A utility must be used for writing data to this memory and is typically not made available to the public unless a firmware upgrade is necessary to address a unique issue.
Camera (select products only)	64 kilobits	No	Yes	Stores camera configuration and firmware.	Camera memory is programmed using a utility from the device manufacturer that can be run from Windows.	A utility must be used for writing data to this memory and is typically not made available to the public unless a firmware upgrade is necessary to address a unique issue.
Fingerprint reader (select products only)	512 KB flash	Yes	Yes	Stores fingerprint templates.	Fingerprint reader memory is programmed by user enrollment in HP ProtectTools Security Manager.	Only a digitally signed application can make the call to write to the flash.

Questions and answers

Use this section to answer your questions about nonvolatile memory.

1. How can the BIOS settings be restored (returned to factory settings)?

 **IMPORTANT:** The restore defaults feature does not securely erase any information on your hard drive. See question and answer 6 for steps to securely erase information.

The restore defaults feature does not reset the Custom Secure Boot keys. See question and answer 7 for information about resetting the keys.

- a. Turn on or restart the computer, and then quickly press **esc**.
- b. Select **Main**, and then select **Apply Factory Defaults and Exit**.
- c. Follow the on-screen instructions.
- d. Select **Main**, select **Save Changes and Exit**, and then follow the on-screen instructions.

2. What is a UEFI BIOS, and how is it different from a legacy BIOS?

The Unified Extensible Firmware Interface (UEFI) BIOS is an industry-standard software interface between the platform firmware and an operating system (OS). It replaces the older BIOS architecture but supports much of the legacy BIOS functionality.

Like the legacy BIOS, the UEFI BIOS provides an interface to display the system information and configuration settings and to change the configuration of your computer before an OS is loaded. BIOS provides a secure runtime environment that supports a Graphic User Interface (GUI). In this environment, you can use either a pointing device (touch screen, touchpad, pointing stick, or USB mouse) or the keyboard to navigate and make menu and configuration selections. The UEFI BIOS also contains basic system diagnostics.

The UEFI BIOS provides functionality beyond that of the legacy BIOS. In addition, the UEFI BIOS works to initialize the computer's hardware before loading and executing the OS; the runtime environment allows the loading and execution of software programs from storage devices to provide more functionality, such as advanced hardware diagnostics (with the ability to display more detailed system information) and advanced firmware management and recovery software.

HP has provided options in Computer Setup (BIOS) to allow you to run in legacy BIOS, if required by the operating system. Examples of this requirement would be if you upgrade or downgrade the OS.

3. Where is the UEFI BIOS located?

The UEFI BIOS is located on a flash memory chip. You must use a utility to write to the chip.

4. What kind of configuration data is stored on the DIMM Serial Presence Detect (SPD) memory module? How would this data be written?

The DIMM SPD memory contains information about the memory module, such as size, serial number, data width, speed and timing, voltage, and thermal information. This information is written by the module manufacturer and stored on an EEPROM. You cannot write to this EEPROM when the memory module is installed in a computer. Third-party tools do exist that can write to the EEPROM when the memory module is not installed in a computer. Various third-party tools are available to read SPD memory.

5. What is meant by "Restore the nonvolatile memory found in Intel-based system boards"?

This message relates to clearing the Real Time Clock (RTC) CMOS memory that contains computer configuration data.

6. How can the BIOS security be reset to factory defaults and erase the data?

 **IMPORTANT:** Resetting results in the loss of information.

These steps do not reset Custom Secure Boot Keys. See question and answer 7 for information about resetting the keys.

- a. Turn on or restart the computer, and then quickly press **esc**.
- b. Select **Main**, and then select **Reset Security to Factory Defaults**.
- c. Follow the on-screen instructions.
- d. Select **Main**, select **Save Changes and Exit**, and then follow the on-screen instructions.

7. How can the Custom Secure Boot Keys be reset?

Secure Boot is a feature to ensure that only authenticated code can start on a platform. If you enabled Secure Boot and created Custom Secure Boot Keys, disabling Secure Boot does not clear the keys. You must also select to clear the Custom Secure Boot Keys. Use the same Secure Boot access procedure that you used to create the Custom Secure Boot Keys, but select to clear or delete all Secure Boot Keys.

- a. Turn on or restart the computer, and then quickly press **esc**.
- b. Select the **Security** menu, select **Secure Boot Configuration**, and then follow the on-screen instructions.
- c. At the **Secure Boot Configuration** window, select **Secure Boot**, select **Clear Secure Boot Keys**, and then follow the on-screen instructions to continue.

Using HP Sure Start (select products only)

Select computer models are configured with HP Sure Start, a technology that continuously monitors your computer's BIOS for attacks or corruption.

If the BIOS becomes corrupted or is attacked, HP Sure Start restores the BIOS to its previously safe state, without user intervention. Those select computer models ship with HP Sure Start configured and enabled. HP Sure Start is configured and already enabled so that most users can use the HP Sure Start default configuration. Advanced users can customize the default configuration.

To access the latest documentation on HP Sure Start, go to <http://www.hp.com/support>.

12 Power cord set requirements

This chapter provides power cord requirements for countries and regions.

The wide-range input feature of the computer permits it to operate from any line voltage from 100 V AC to 120 V AC, or from 220 V AC to 240 V AC.

The three-conductor power cord set included with the computer meets the requirements for use in the country or region where the equipment is purchased.

Power cord sets for use in other countries or regions must meet the requirements of the country and region where the computer is used.

Requirements for all countries

These power cord requirements are applicable to all countries and regions.

- The length of the power cord set must be at least **1.0 m** (3.3 ft) and no more than **2.0 m** (6.5 ft).
- All power cord sets must be approved by an acceptable accredited agency responsible for evaluation in the country or region where the power cord set will be used.
- The power cord sets must have a minimum current capacity of 10 A and a nominal voltage rating of 125 V AC or 250 V AC, as required by the power system of each country or region.
- The appliance coupler must meet the mechanical configuration of an EN 60 320/IEC 320 Standard Sheet C13 connector for mating with the appliance inlet on the back of the computer.

Requirements for specific countries and regions

To determine power cord requirements for specific countries and regions, use this table.

Table 12-1 Power cord requirements for specific countries and regions

Country/region	Accredited agency	Applicable note number
Argentina	IRAM	1
Australia	SAA	1
Austria	OVE	1
Belgium	CEBEC	1
Brazil	ABNT	1
Canada	CSA	2

Table 12-1 Power cord requirements for specific countries and regions (continued)

Country/region	Accredited agency	Applicable note number
Chile	IMQ	1
Denmark	DEMKO	1
Finland	FIMKO	1
France	UTE	1
Germany	VDE	1
India	BIS	1
Israel	SII	1
Italy	IMQ	1
Japan	JIS	3
Netherlands	KEMA	1
New Zealand	SANZ	1
Norway	NEMKO	1
People's Republic of China	CCC	4
Saudi Arabia	SASO	7
Singapore	PSB	1
South Africa	SABS	1
South Korea	KTL	5
Sweden	SEMKO	1
Switzerland	SEV	1
Taiwan	BSMI	6
Thailand	TISI	1
United Kingdom	ASTA	1
United States	UL	2

Table 12-1 Power cord requirements for specific countries and regions (continued)

Country/region	Accredited agency	Applicable note number
		1. The flexible cord must be Type HO5VV-F, three-conductor, 0.75 mm ² conductor size. Power cord set fittings (appliance coupler and wall plug) must bear the certification mark of the agency responsible for evaluation in the country or region where it will be used.
		2. The flexible cord must be Type SVT/SJT or equivalent, No. 18 AWG, three-conductor. The wall plug must be a two-pole grounding type with a NEMA 5-15P (15 A, 125 V AC) or NEMA 6-15P (15 A, 250 V AC) configuration. CSA or C-UL mark. UL file number must be on each element.
		3. The appliance coupler, flexible cord, and wall plug must bear a T mark and registration number in accordance with the Japanese Dentori Law. The flexible cord must be Type VCTF, three-conductor, 0.75 mm ² or 1.25 mm ² conductor size. The wall plug must be a two-pole grounding type with a Japanese Industrial Standard C8303 (7 A, 125 V AC) configuration.
		4. The flexible cord must be Type RVV, three-conductor, 0.75 mm ² conductor size. Power cord set fittings (appliance coupler and wall plug) must bear the CCC certification mark.
		5. The flexible cord must be Type H05VV-F three-conductor, 0.75 mm ² conductor size. KTL logo and individual approval number must be on each element. Approval number and logo must be printed on a flag label.
		6. The flexible cord must be Type HVCTF three-conductor, 1.25 mm ² conductor size. Power cord set fittings (appliance coupler, cable, and wall plug) must bear the BSMI certification mark.
		7. For 127 V AC, the flexible cord must be Type SVT or SJT 3-conductor, 18 AWG, with plug NEMA 5-15P (15 A, 125 V AC), with UL and CSA or C-UL marks. For 240 V AC, the flexible cord must be Type H05VV-F three-conductor, 0.75 mm ² or 1.00 mm ² conductor size, with plug BS 1363/A with BSI or ASTA marks.

13 Recycling

When a nonrechargeable or rechargeable battery has reached the end of its useful life, do not dispose of the battery in general household waste. Follow the local laws and regulations in your area for battery disposal.

HP encourages customers to recycle used electronic hardware, HP original print cartridges, and rechargeable batteries. For more information about recycling programs, see the HP website at <http://www.hp.com/recycle>.

Index

A

- AC adapter
 - product description 2
 - spare part numbers 30
- adapter, spare part numbers 30
- antenna
 - illustrated 27
 - removal 48
 - spare part numbers 27, 48
- audio jack cable
 - illustrated 27, 30
 - removal 52
 - spare part number 27, 30, 52
- audio-out (headphone)/audio-in (microphone) combo jack, identifying 6
- audio, product description 1

B

- backpack, spare part numbers 31
- backup, creating 79
- backups 79
- battery
 - illustrated 29
 - removal 45
 - spare part number 29, 45
- BIOS
 - determining version 72, 76
 - downloading an update 73, 74, 76, 77
 - starting the Setup Utility 72
 - updating 72, 76
- boot order
 - changing using the f9 prompt 77
- boot order, changing 81
- bottom case, spare part numbers 31
- bottom cover
 - illustrated 29
 - removal 44

- spare part number 29, 44
- Bracket Kit
 - contents 29
 - spare part number 29
- Bracket Kit, spare part number 31
- buttons
 - power 12

C

- Cable Kit
 - contents 30
 - spare part number 30
- Cable Kit, spare part number 31
- camera 8
 - identifying 8
- camera lights, identifying 8
- camera privacy cover, identifying 8
- caps lock light, identifying 11
- caring for your computer 39
- case, spare part numbers 31
- cautions
 - electrostatic discharge 35, 36
- chipset, product description 1
- cleaning your computer 39
 - caring for wood veneer 41
 - disinfecting 40
 - HP Easy Clean 39
 - removing dirt and debris 39
- components
 - bottom 12
 - display 7
 - keyboard area 9
 - left side 6
 - right side 5
- Computer Setup
 - navigating and selecting 75
 - restoring factory settings 76
 - starting 75
- computer specifications 88
- connector board
 - removal 52

- spare part number 27, 52
- connector board bracket
 - illustrated 27, 29
 - removal 53
 - spare part number 27, 29, 53
- connector board cable
 - removal 52
 - spare part number 52
- connector, power 6, 7

D

- display assembly
 - illustrated 16
 - removal 56
 - spare part numbers 16, 56
- display components 7
- display panel
 - product description 1
- display specifications 88, 89
- dock, spare part numbers 31
- duckhead adapter, spare part number 31

E

- electrostatic discharge (ESD) 35, 36
 - preventing damage 35-37

G

- grounding methods 35-37
- guidelines
 - packaging 35, 41
 - transporting 35, 41
 - workstation 35

H

- hardware, locating 5
- HDMI port, identifying 7
- heat sink
 - illustrated 27
 - removal 63

- spare part number 27
 - spare part numbers 63
- HP PC Hardware Diagnostics UEFI
 - downloading 85
 - failure ID code 84
 - starting 85
 - using 84
- HP PC Hardware Diagnostics Windows
 - accessing 82, 83
 - downloading 83
 - failure ID code 82
 - installing 84
 - using 82
- HP Recovery media
 - recovery 80
- HP Sure Recover 81
- HP Sure Start 90, 96
- hub, spare part numbers 31

I

- I/O bracket
 - removal 62
 - spare part number 62
- illustrated parts catalog 15

J

- jacks
 - audio-out (headphone)/audio-in (microphone) combo 6
 - network 7
 - RJ-45 (network) 7

K

- keyboard, product description 2
- keyboard, spare part numbers 31

L

- labels
 - contents 13
 - locations 13
- left side components 6
- lights
 - camera 8
 - caps lock 11
 - microphone mute 11
 - power 11
 - RJ-45 (network) 7
- lights, mute 11
- lights, power 7
- lock, spare part numbers 31
- low blue light mode 7

M

- memory
 - nonvolatile 90
 - volatile 90
- memory module
 - product description 1
- microphone mute light, identifying 11
- microphone, identifying 8
- microphone, product description 1
- model name 1
- mouse, spare part numbers 31
- mute light, identifying 11

N

- network jack, identifying 7
- nonvolatile memory 90

O

- onnector board
 - illustrated 27
- op cover webcam cable
 - illustrated 26
- operating system, product description 3
- optical drive, spare part number 31

P

- packaging guidelines 35, 41
- pen garage 10
- pen, product description 2
- Plastics Kit, spare part numbers 32
- POGO board
 - illustrated 26
 - removal 54
 - spare part number 26, 54
- POGO board bracket
 - illustrated 27, 29
 - removal 55
 - spare part number 27, 29
- POGO board cable
 - illustrated 27, 30
 - removal 53
 - spare part number 27, 30, 53
- pointing device, product description 2
- ports
 - HDMI 7
 - product description 2
 - USB SuperSpeed 6, 7

- USB Type-C power connector and SuperSpeed port 7
- power button 12
- power connector
 - identifying 6
 - identifying USB Type-C 7
- power connector cable
 - illustrated 26
 - removal 55
 - spare part number 26, 55
- power connector cable bracket
 - illustrated 26, 29
 - removal 56
 - spare part number 26, 29
- power cord
 - requirements for all countries 97
 - requirements for specific countries and regions 97
 - set requirements 97
 - spare part numbers 32-34
- power light 7
- power lights 11
- power requirements, product description 2
- processor, product description 1
- product description
 - audio 1
 - chipset 1
 - display panel 1
 - keyboard 2
 - memory module 1
 - microphone 1
 - operating system 3
 - pen 2
 - pointing device 2
 - ports 2
 - power requirements 2
 - processors 1
 - product name 1
 - security 2
 - serviceability 4
 - storage 1
 - video 1
 - wireless 2
- product name 1

R

- recovery 79, 80
 - discs 80
 - media 80
 - USB flash drive 80
- recovery media 79

- creating using HP Cloud Recovery Download Tool 79
 - creating using Windows tools 79
- Remote HP PC Hardware Diagnostics UEFI settings
 - customizing 86
 - using 86
- removal and replacement procedures 44
- removing personal data from volatile system memory 90
- restoring 79
- restoring and recovery methods 80
- right side components 5
- RJ-45 (network) jack, identifying 7
- RJ-45 (network) lights, identifying 7
- RTC battery
 - illustrated 26
 - removal 65
 - spare part number 26, 65
- Rubber Kit, spare part numbers 34

S

- Screw Kit, spare part number 34
- security cable slot, identifying 6
- security, product description 2
- serviceability, product description 4
- setup utility
 - navigating and selecting 75
 - restoring factory settings 76
- sleeve, spare part number 34
- slots
 - security cable 6
- software installed, locating 5
- solid-state drive
 - illustrated 27
 - removal 49
 - spare part numbers 27, 49
- spare part country codes 70
- speakers
 - illustrated 26
 - removal 64
 - spare part number 26, 64
- speakers, identifying 12
- specifications
 - computer 88
 - display 88, 89
- static electricity 35, 36

- storage, product description 1
- support information 42
- Sure Start
 - using 78
- system board
 - illustrated 27
 - removal 59
 - spare part numbers 27, 59
- system board I/O bracket
 - illustrated 29
 - spare part number 29
- system memory, removing personal data from volatile 90
- system restore 80
- system restore point, creating 79

T

- top cover webcam
 - illustrated 26
 - removal 68
 - spare part number 26, 68
- top cover webcam bracket
 - illustrated 26, 29
 - removal 69
 - spare part number 26, 29, 69
- top cover webcam cable
 - illustrated 30
 - removal 69
 - spare part number 26, 30, 69
- top cover/keyboard
 - illustrated 17-22, 24, 25
 - spare part numbers 17-22, 24, 25, 70
- touchpad
 - illustrated 26
 - removal 67
 - settings 9
 - spare part numbers 26, 67
- touchpad bracket
 - illustrated 26, 29
 - removal 68
 - spare part number 26, 29, 68
- touchpad cable
 - illustrated 26, 30
 - removal 66
 - spare part number 26, 30, 66
- touchpad rubber pad
 - illustrated 26
 - spare part number 26
- touchpad settings, adjusting 9
- touchpad zone 10
- TPM settings 78
- transporting guidelines 35, 41

U

- USB port cable
 - illustrated 27, 30
 - removal 52
 - spare part number 27, 30, 52
- USB SuperSpeed port, identifying 6, 7
- USB Type-C power connector and SuperSpeed port, identifying 7

V

- video, product description 1

W

- Windows
 - backup 79
 - recovery media 79
 - system restore point 79
- Windows tools, using 79
- wireless antenna
 - illustrated 27
 - removal 48
 - spare part numbers 27, 48
- wireless antennas, identifying 8
- wireless, product description 2
- WLAN antennas, identifying 8
- WLAN module
 - illustrated 27
 - removal 50
 - spare part numbers 27, 50
- WLAN module sponge
 - removal 50, 58, 61
 - spare part number 27, 50, 58, 61
- workstation guidelines 35
- WWAN antenna
 - illustrated 27
 - spare part numbers 27
- WWAN auxiliary antenna
 - removal 48
 - spare part number 48
- WWAN module
 - illustrated 27
 - removal 46
 - spare part number 27, 46
- WWAN module cover
 - removal 47, 48, 57, 61
 - spare part number 27, 47, 48, 57, 61