

ThinkSmart Core Kits Deployment Guide for Microsoft Teams Rooms (MTR)

Lenovo
ThinkSmart

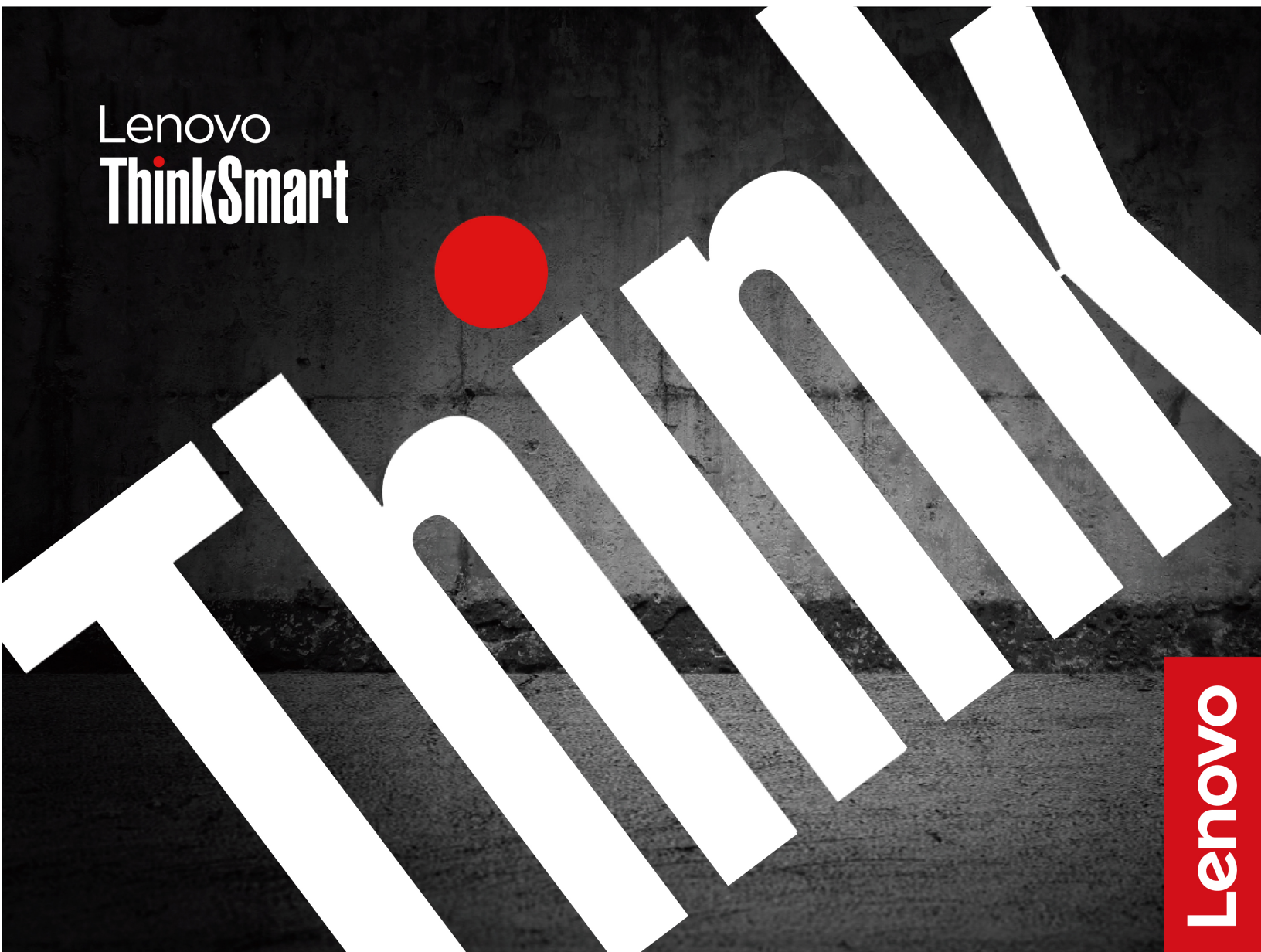

Lenovo

Read this first

Before using this documentation and the product it supports, ensure that you read and understand the following:

- *Generic Safety and Compliance Notices* at <https://smartsupport.lenovo.com/>
- Documentation in the box

Third Edition (August 2023)

© Copyright Lenovo 2021, 2023.

LIMITED AND RESTRICTED RIGHTS NOTICE: If data or software is delivered pursuant to a General Services Administration "GSA" contract, use, reproduction, or disclosure is subject to restrictions set forth in Contract No. GS-35F-05925.

Contents

About this documentation iii

Chapter 1. Solution overview 1

SKU overview	2
ThinkSmart Core connector overview	5
Smart features	6

Chapter 2. Prerequisites for deployment 9

Hardware	9
Software	9
Network	9

Chapter 3. Hardware deployment. . . 11

ThinkSmart Cam	12
ThinkSmart Bar XL.	17
ThinkSmart Controller	19
ThinkSmart Core	20

Chapter 4. Software deployment . . . 25

Windows OOBE settings	25
Claim device to ThinkSmart Manager	27
MTR Setup	36
MTR Settings.	38
Switch between MTR account and administrator account	40

Chapter 5. Typical conferencing scenarios. 41

Learn about MTR home screen	41
Join a scheduled meeting	42
Create a new meeting	43
Invite ThinkSmart Core during a meeting	43
Share content	44

Chapter 6. Secure ThinkSmart Core and information 45

UEFI BIOS passwords	45
Use BIOS security solutions	46
Wipe the storage drive data	46
Intel BIOS guard.	46
Smart USB Protection	46
Use software security solutions.	47
Windows firewalls	47
Computrace Agent software embedded in firmware (for selected models)	47

Chapter 7. UEFI BIOS 49

What is UEFI BIOS.	49
Enter the BIOS menu.	49
Navigate in the BIOS interface	49
Change the display language of UEFI BIOS	49
Change the display mode of UEFI BIOS (for selected models)	50
Set the system date and time	50
Change the priority boot order	50
Enable or disable a device.	51
Enable or disable the configuration change detection feature	51
Enable or disable the automatic power-on feature	51
Enable or disable the ErP LPS compliance mode	52
Change BIOS settings before installing a new operating system	52
Exit the BIOS menu	53
Update UEFI BIOS.	53
Recover from a BIOS update failure	53
Clear CMOS	53

Chapter 8. FAQ 55

Chapter 9. Troubleshooting, diagnostics, and recovery 57

Basic procedure for resolving problems	57
Troubleshooting	57
Startup and shutdown problems	57
MTR problems	58
Display problems	58
Audio problems	60
Network problems	60
Performance problems	61
Drive problems	62
USB device problems	62
Diagnostics	62
Recovery	62
Restore system files and settings to an earlier point	63
Restore your files from a backup	63
Reset from Windows	63
Reset from BIOS	63
Use advanced options	63
Windows automatic recovery.	63
Create and use a recovery USB device	64
Update the device driver	64

Chapter 10. Help and support. 67

Register with Lenovo	67
CRU replacement	67
Self-help resources	68
Additional services	68
Call Lenovo	69
Before you contact Lenovo	69
Lenovo Customer Support Center	69

Appendix A. Specifications	71
---	-----------

Appendix B. Compliance information.	73
--	-----------

Appendix C. Notices and trademarks.	83
--	-----------

About this documentation

- Illustrations in this documentation might look different from your product.
- Documentation content is subject to change without notice. To get the latest documentation, go to <https://smartsupport.lenovo.com/>.
- Microsoft® makes periodic feature changes to the Windows® operating system through Windows Update. Refer to Microsoft resources for the latest information.

Chapter 1. Solution overview

Thanks for choosing ThinkSmart Core Kits.

ThinkSmart Core Kits are modular conferencing solutions to transform conferencing into a collaborative, productive, and smart experience. End users will enjoy the familiar Microsoft Teams Rooms (referred to as MTR) interface and IT administrators will enjoy the easily deployed and managed Windows operating system.





SKU overview

For ThinkSmart Core Kits with ThinkSmart Controller

SKU	Target rooms	Inbox items*
ThinkSmart Core + Controller	Any room that already has audio and video device	
ThinkSmart Core Full Room Kit 1	From small room 16 x 16 feet (4–6 people) to large room 15 x 32 feet (12–16 people)	
ThinkSmart Core Full Room Kit 2	Extra large room (above 16 people)	

* Contact your place of purchase if any item is missing or damaged. Ensure that you retain your proof of purchase and packing material. They might be required to receive warranty service.

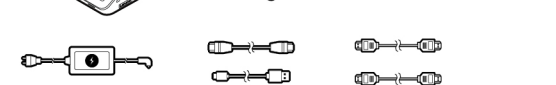
For ThinkSmart Core Kits with Lenovo IP Controller

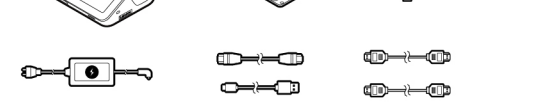
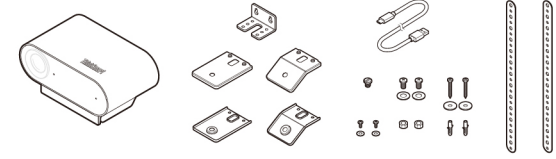
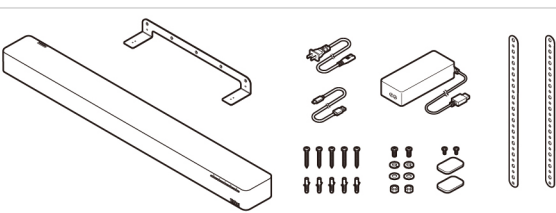
SKU	Target rooms	Inbox items*
ThinkSmart Core + Controller	Any room that already has audio and video device	
		
ThinkSmart Core + Controller	Any room that already has audio and video device	
		
ThinkSmart Core Full Room Kit 1	From small room 16 x 16 feet (4–6 people) to large room 15 x 32 feet (12–16 people)	
		
		
		
		

SKU	Target rooms	Inbox items*
ThinkSmart Core Full Room Kit 2	Extra large room (above 16 people)	

* Contact your place of purchase if any item is missing or damaged. Ensure that you retain your proof of purchase and packing material. They might be required to receive warranty service.

ThinkSmart Core connector overview

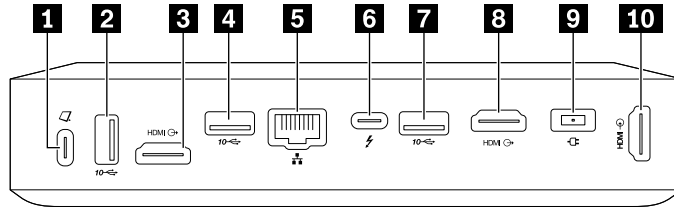

1 USB-C® (3.2 Gen 1) connector	Connect ThinkSmart Controller or other USB-C compatible device for data transfer.
2 USB 3.2 Gen 1 connector	Connect a USB-compatible device, such as a USB keyboard or USB mouse.
3 8 HDMI-out connector	Connect to an external HDMI™ display. This HDMI 1.4 connector supports display resolutions up to 3840 x 2160 pixels, 24 Hz.
4 7 USB 3.2 Gen 2 connector	Connect ThinkSmart Cam, ThinkSmart Bar XL, or other USB device.
5 Ethernet connector	Connect to a local area network (LAN).
6 USB-C (Thunderbolt™ 4) connector	Connect a USB-C device for data transfer.
9 Power connector	Connect to a power supply.
10 HDMI-in connector*	Connect to your computer only. Do not connect an external HDMI display to this connector.

* for selected models

Note: Ensure that the camera or soundbar device connected to ThinkSmart Core is MTR certified before using with the MTR software.

Statement on USB transfer rate

Depending on many factors such as the processing capability of the host and peripheral devices, file attributes, and other factors related to system configuration and operating environments, the actual transfer rate using the various USB connectors on this device will vary and will be slower than the data rate listed below for each corresponding device.

USB device	Data rate (Gbit/s)
3.2 Gen 1 / 3.1 Gen 1	5
3.2 Gen 2 / 3.1 Gen 2	10
Thunderbolt 4	40

Smart features

ThinkSmart Cam — AI features

- **People count and auto zoom/frame:** Auto detect and count the people in the field of view. Then auto frame and zoom in the people to a suitable size. This function makes it easier to monitor the dynamics of the conference.

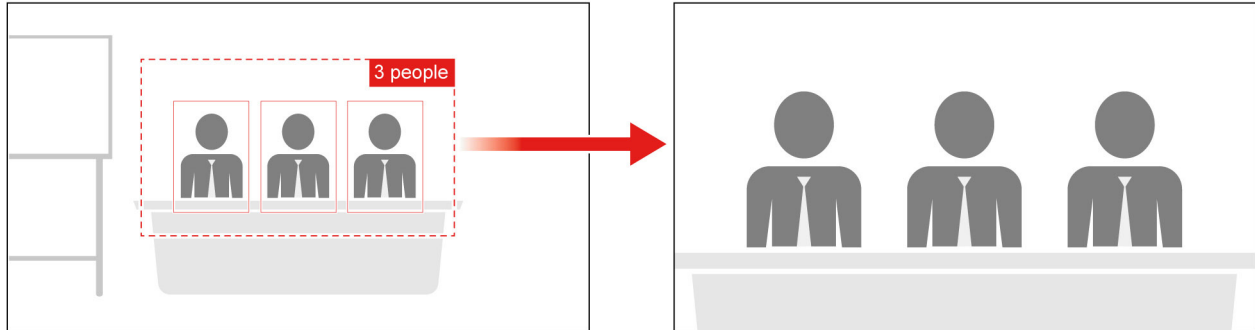

- **Speaker tracking and whiteboard recognition:** Auto track the speaker and count the whiteboard nearby as a person. Then auto frame and zoom in the speaker and the whiteboard to a suitable size. The camera will use Picture-in-Picture mode to replace the original video image in the sub image. This function makes the conference more focus on the speaker and the content of whiteboard.

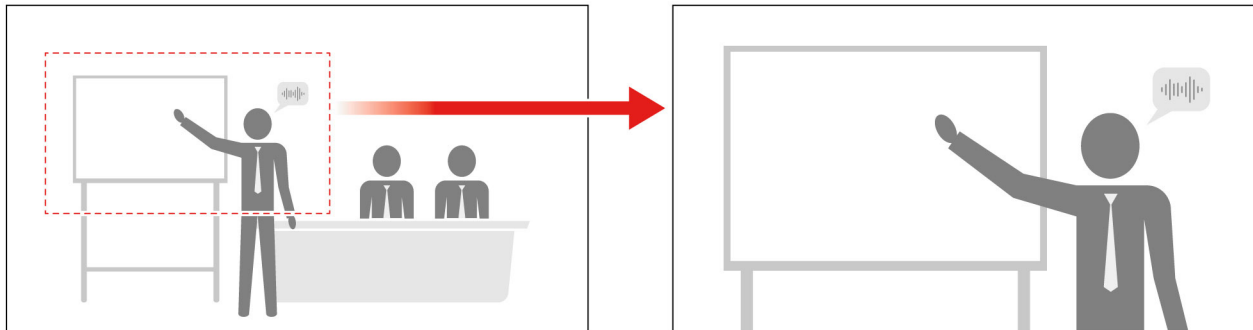

Notes:

- The camera will run the speaker tracking function when the speaker speaks with normal sound volume (greater than 60dB) for over 2 seconds. The speaker should be less than 5 meters away from the camera.
- The camera will run the whiteboard recognition function when the speaker is nearby and speaks for over 2 seconds.
- The camera will zoom out to show all people in the field of view when the speaker stops speaking for over 3 seconds.
- The camera will run the auto zoom/frame function instead of the speaker tracking function when there are more than two speakers and their distance is too close (less than 50 cm).

ThinkSmart Controller

Motion detection: Auto wake up the screen when a person approaches toward it. The detection angle is 90° and the detection distance is up to 3 meters.

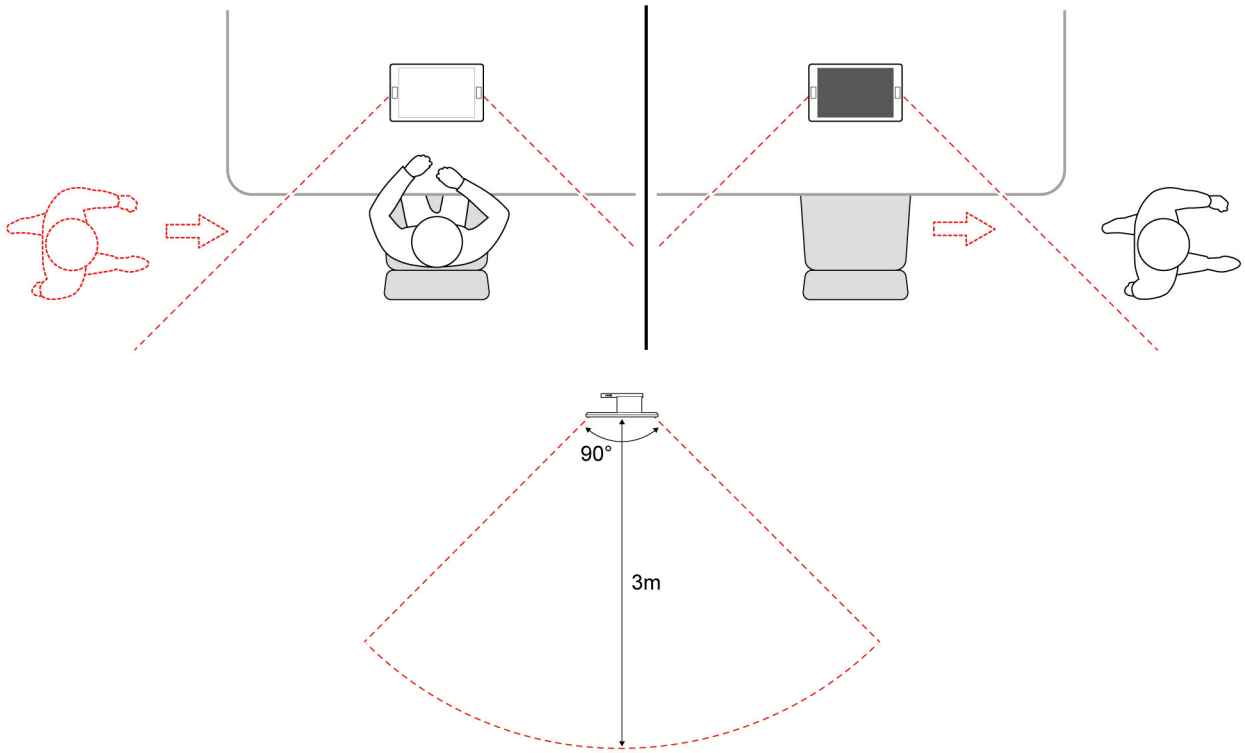

Chapter 2. Prerequisites for deployment

Notes:

- Take ThinkSmart Core Full Room Kit 2 as example to show the maximum configuration. Please prepare anything not available from your kit.
- The following are basic prerequisites for deployment. The total conferencing solution will only work if the proper infrastructures are deployed. Please consult your sales representative for related prerequisites.

Hardware

- At least one external display with cable for HDMI-out connection
- Keyboard and mouse
- RJ45 Ethernet cable
- HDMI cable for HDMI-in connection

You can purchase accessories from Lenovo <https://www.lenovo.com/accessories>.

Software

Get started by a Microsoft Teams Rooms license.

Network

Firewall	Scenario
TCP 443	Signaling packets
TCP 443 UDP 3478 TCP / UDP 50,000 - 59,999	Audio / Video packets
TCP 443 TCP / UDP 50,000 - 59,999	Desktop sharing
TCP 80 and 443	Http / https

Bandwidth (up/down)	Scenario
30 kbps	Peer-to-peer audio calling
130 kbps	Peer-to-peer audio calling and screen sharing
500 kbps	Peer-to-peer quality video calling 360 p at 30 fps
1.2 Mbps	Peer-to-peer HD quality video calling with resolution of HD 720 p at 30 fps
1.5 Mbps	Peer-to-peer HD quality video calling with resolution of HD 1080 p at 30 fps
500 kbps / 1 Mbps	Group Video calling
1 Mbps / 2 Mbps	HD Group video calling (540 p videos on 1080 p screen)

For more information, go to <https://docs.microsoft.com/en-us/microsoftteams/rooms/>.

Chapter 3. Hardware deployment

ThinkSmart Core Kits devices support multiple mounting methods to meet various deployment needs. IT administrators can deploy them according to the actual situation of the conferencing room. The following illustration is for reference only.

Note: Ensure that you deploy with the accompanying devices and components for optimal performance.

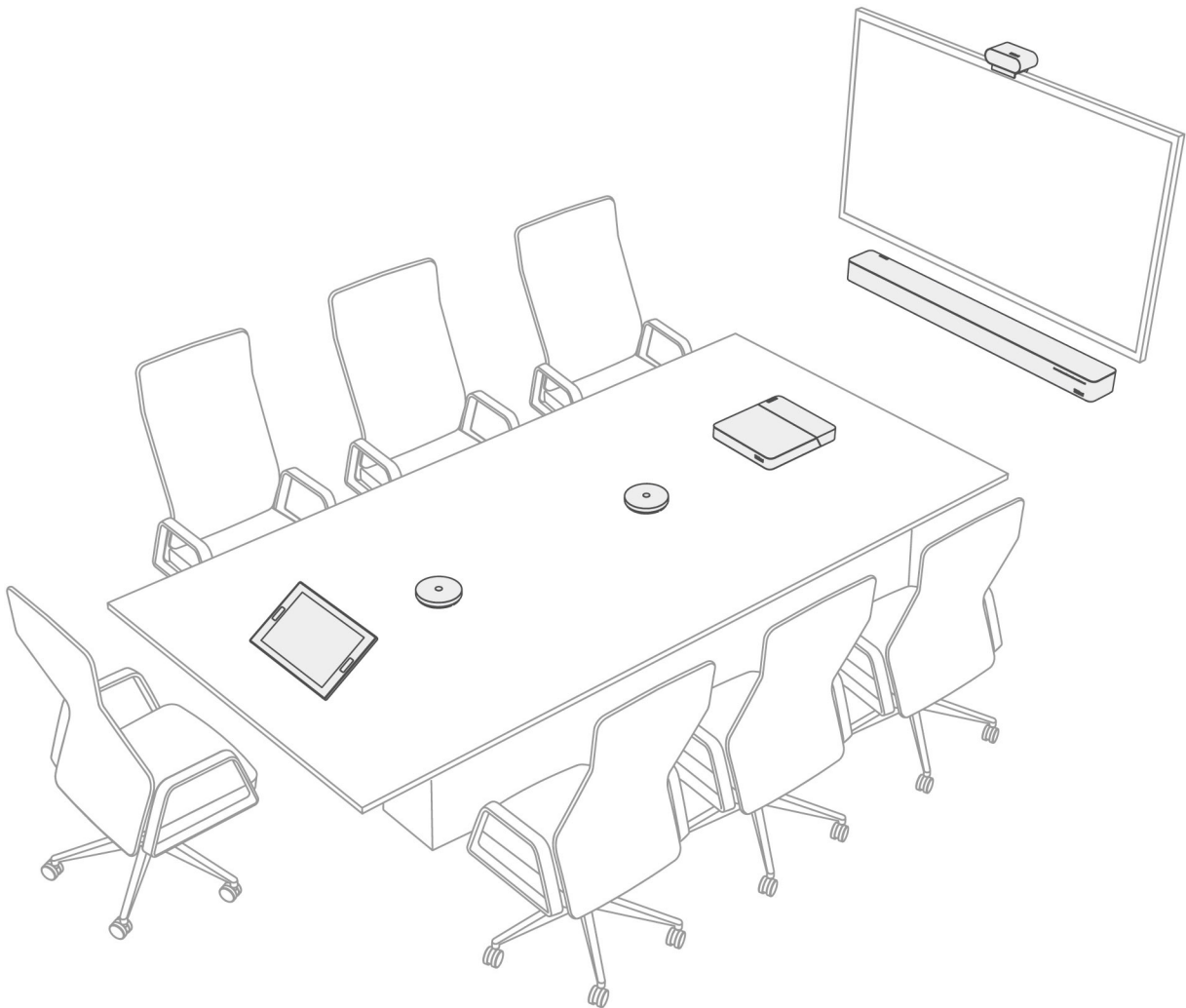

ThinkSmart Cam

1. Do one of the following to mount the camera and connect the camera cable:
 - Mount on ThinkSmart Bar XL.

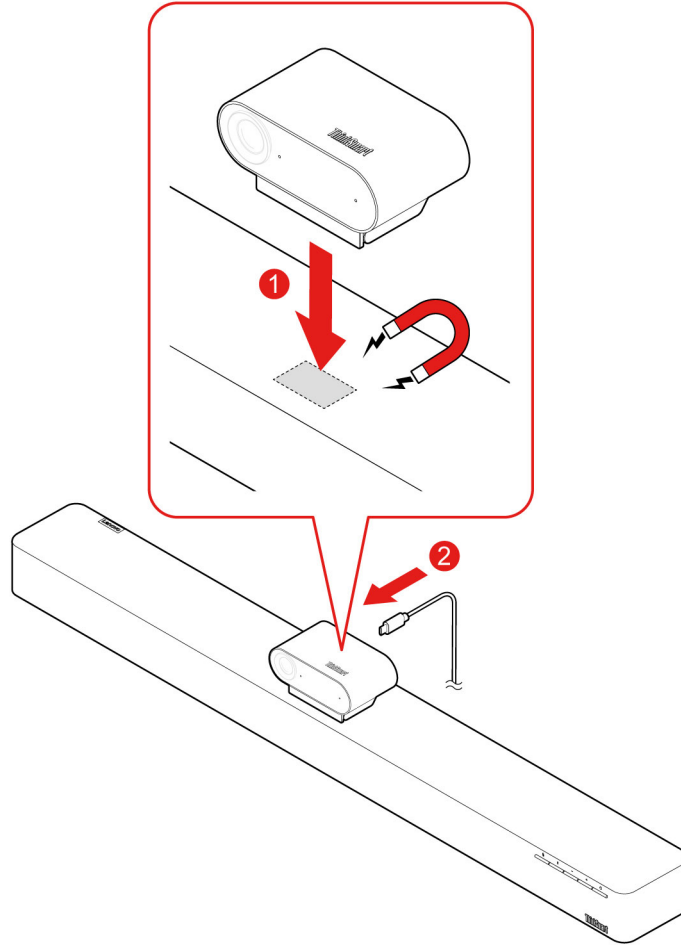

- Mount on TV

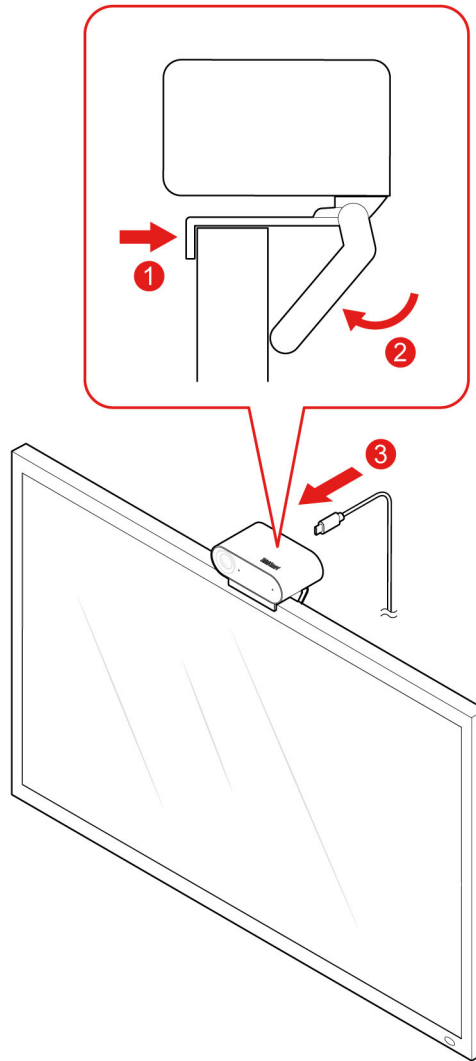

- Mount on wall

Attention: Keep the camera within 2 meters (6.6 feet) from the floor.

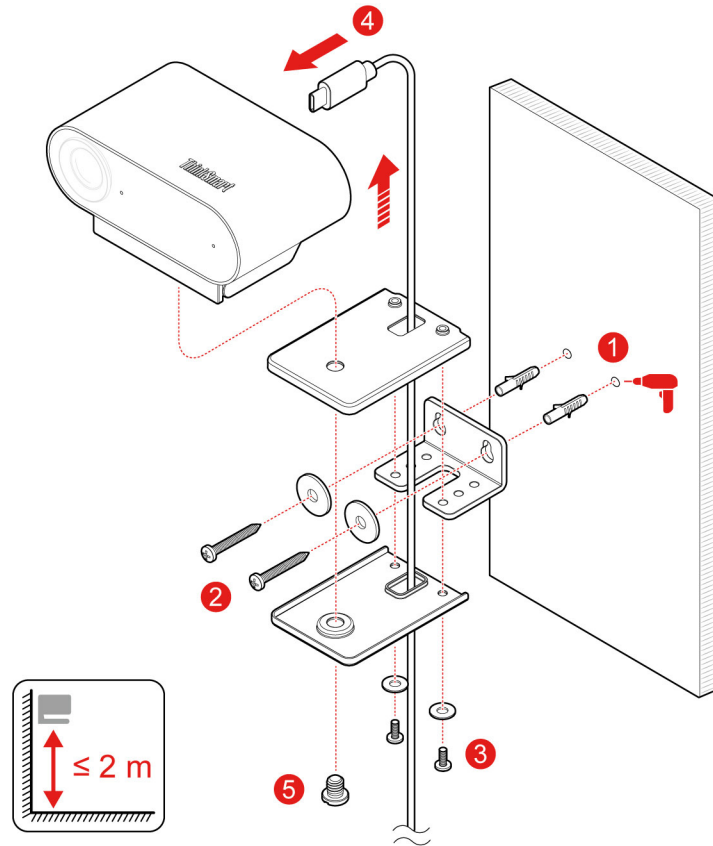

- Mount below TV

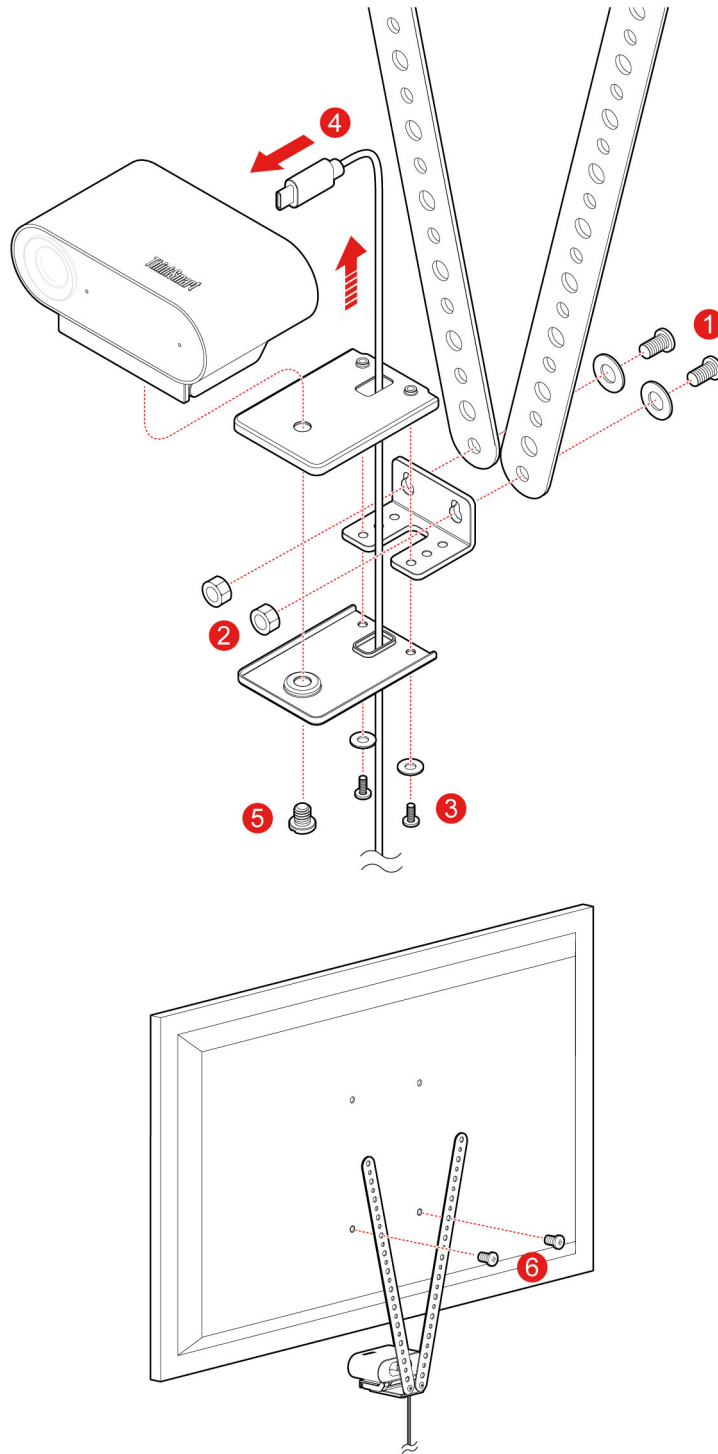

- Mount above TV

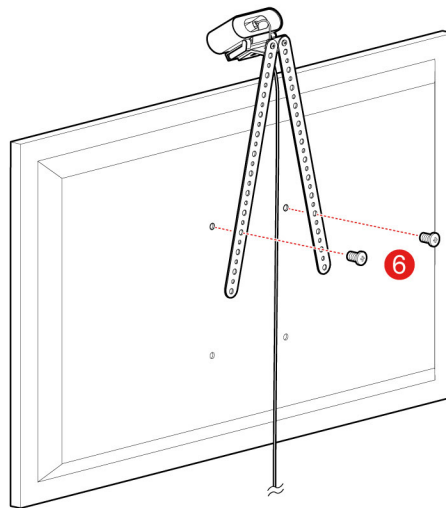
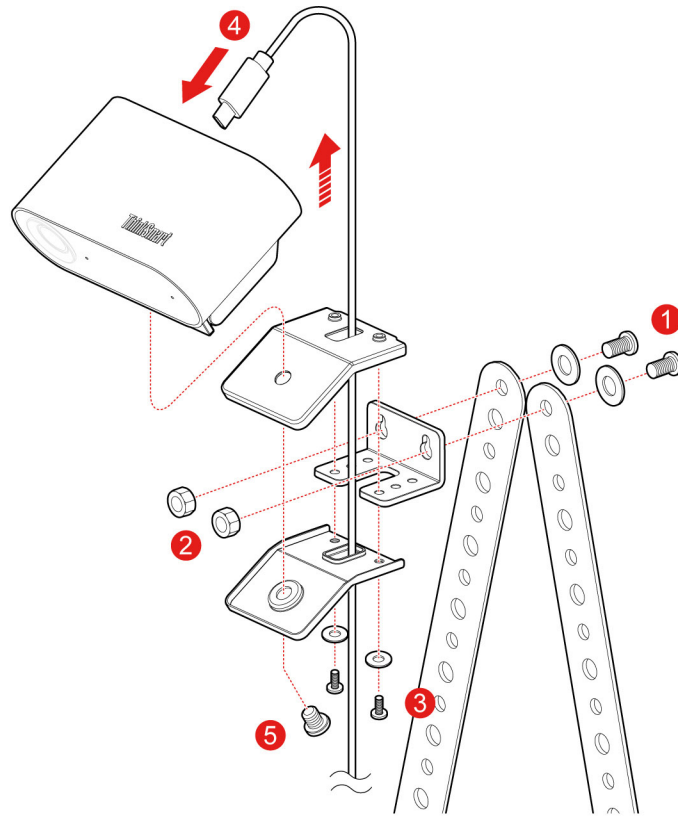

2. Adjust the camera angle.

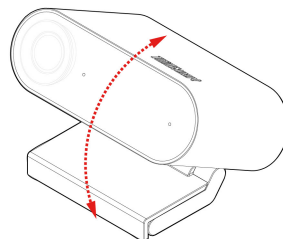

ThinkSmart Bar XL

1. Do one of the following to mount the soundbar:

- Mount on wall

Attention: Keep the soundbar within 2 meters (6.6 feet) from the floor.

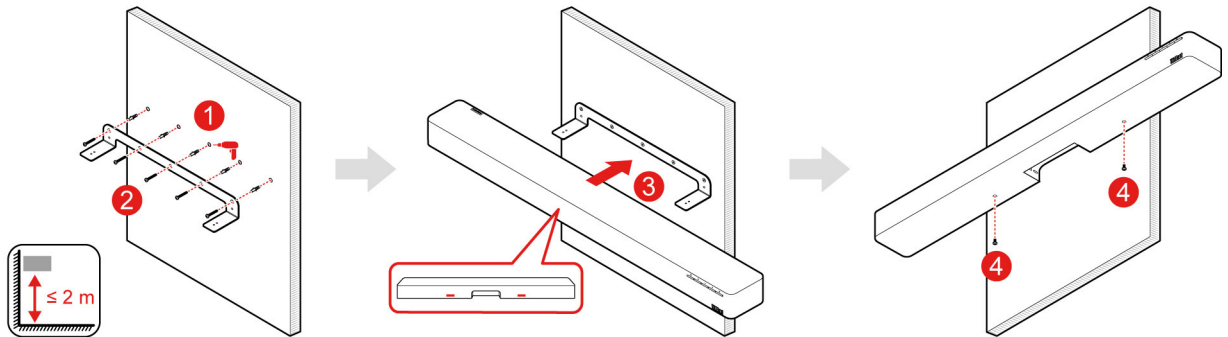

- Mount above TV or below TV

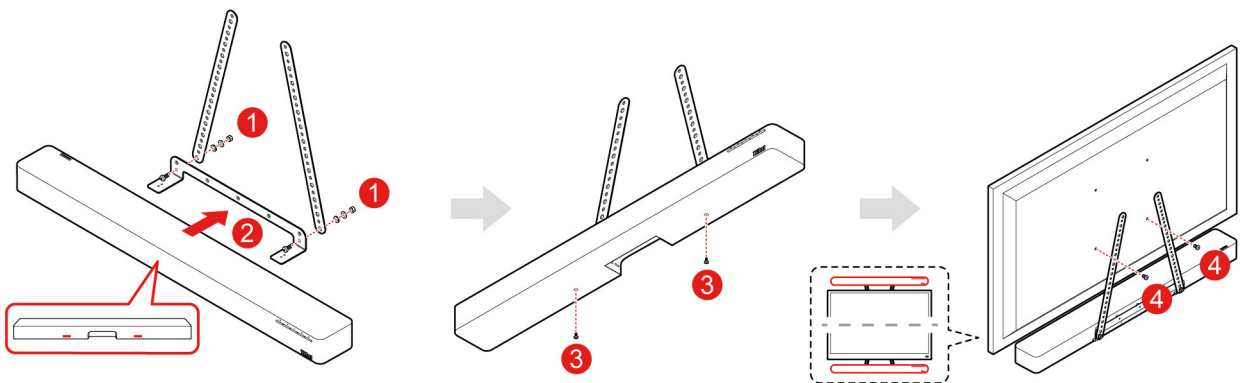

2. Connect the soundbar to a power supply. Connect the satellite microphones and the soundbar cable to the soundbar.

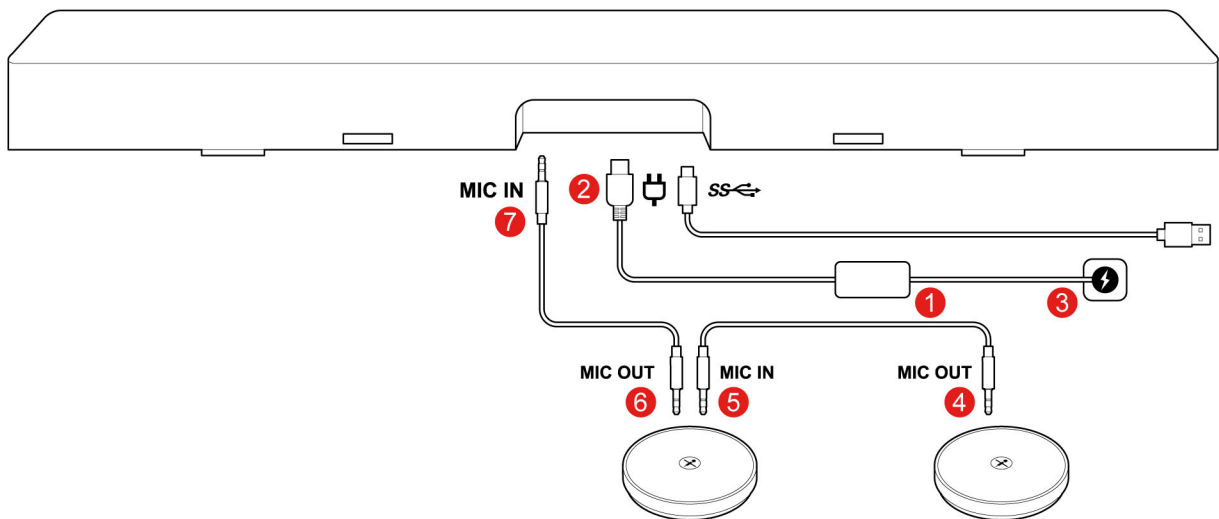

3. Turn on the soundbar by pressing and holding its power button for 3 seconds.

Notes:

- The satellite microphones support daisy chain connection. Ensure that you connect with the correct connectors.
- Keep the soundbar over 8.5 meters (27.9 feet) away from the opposite wall. Keep the satellite microphones 2 ~ 6 meters (6.6 ~ 19.6 feet) apart from each other.

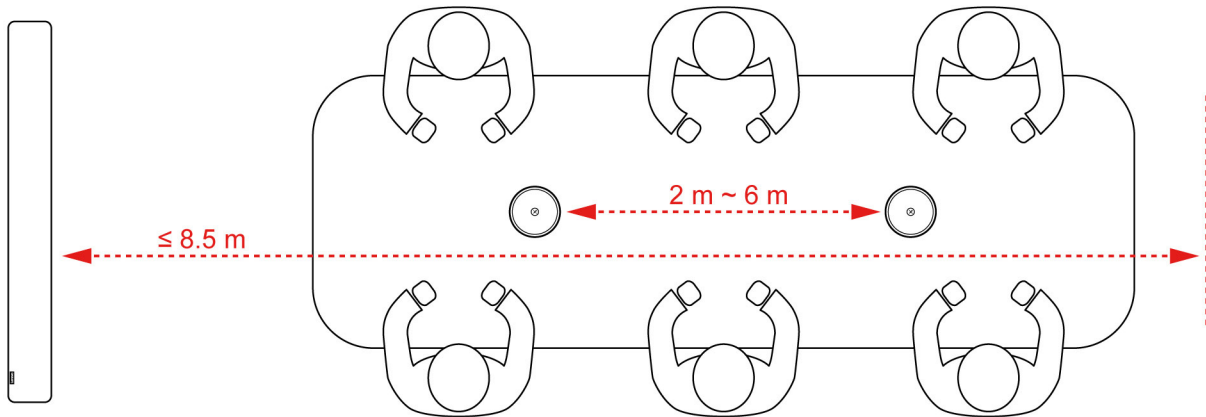

- The soundbar supports Bluetooth connection with a non-MTR device, such as a notebook computer / table / mobile phone.

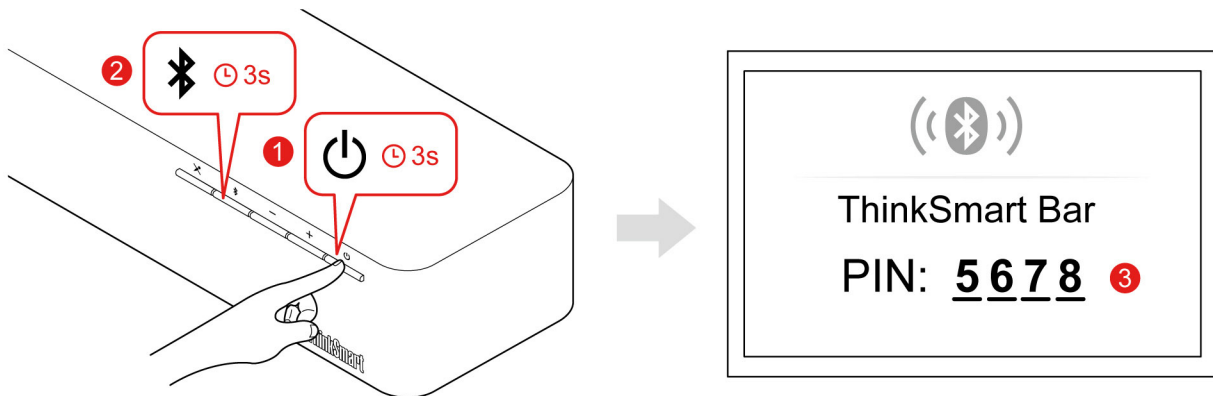

ThinkSmart Controller

1. Place Controller on a table in either 30° or 60 ° position.

Note: Its screen will rotate automatically.

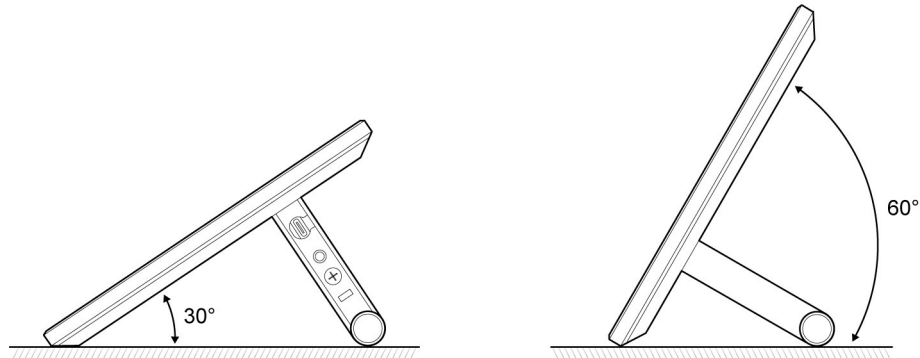

2. Lock Controller to a table or other fixture through a cable lock compliant with Kensington / Lenovo NanoSaver lock standard (using Cleat locking technology). The security-lock slot is located in the Controller stand.

Note: You are responsible for evaluating, selecting, and implementing the locking device and security feature. Lenovo makes no comments, judgments, or warranties about the function, quality, or performance of the locking device and security feature. You can purchase locks from Lenovo.

ThinkSmart Core

1. Open the Core door.

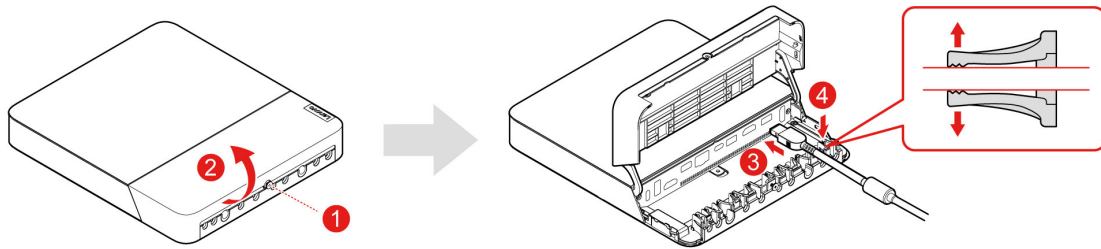

2. Connect a keyboard, a mouse, Controller, external displays, an Ethernet cable, the power adapter and power cord, and your computer to Core.

- For ThinkSmart Core Kits with ThinkSmart Controller

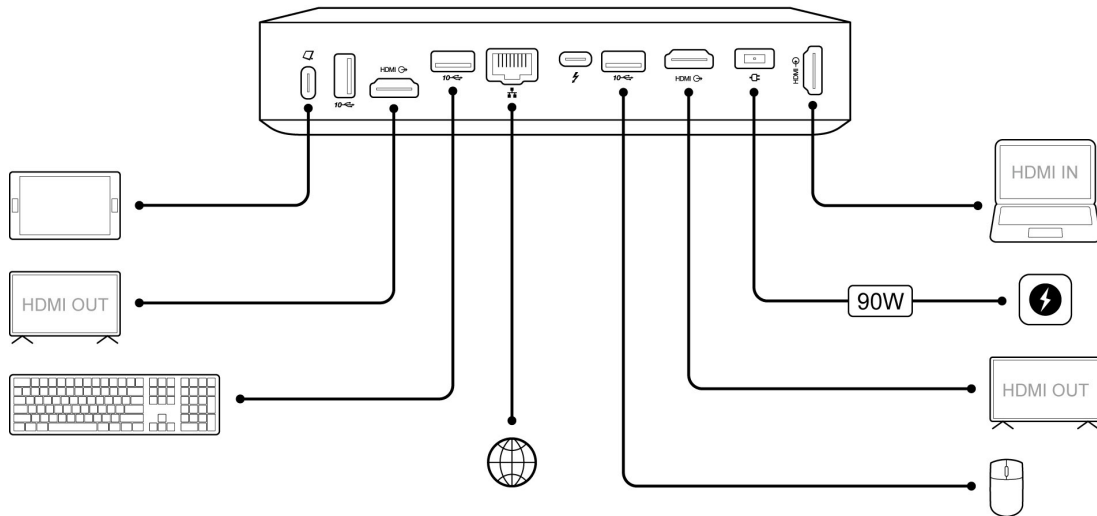

Note: Ensure that you connect your computer to the HDMI-in connector (HDMI \ominus) and connect the external displays to the HDMI-out connectors (HDMI \ominus).

- For ThinkSmart Core Kits with Lenovo IP Controller

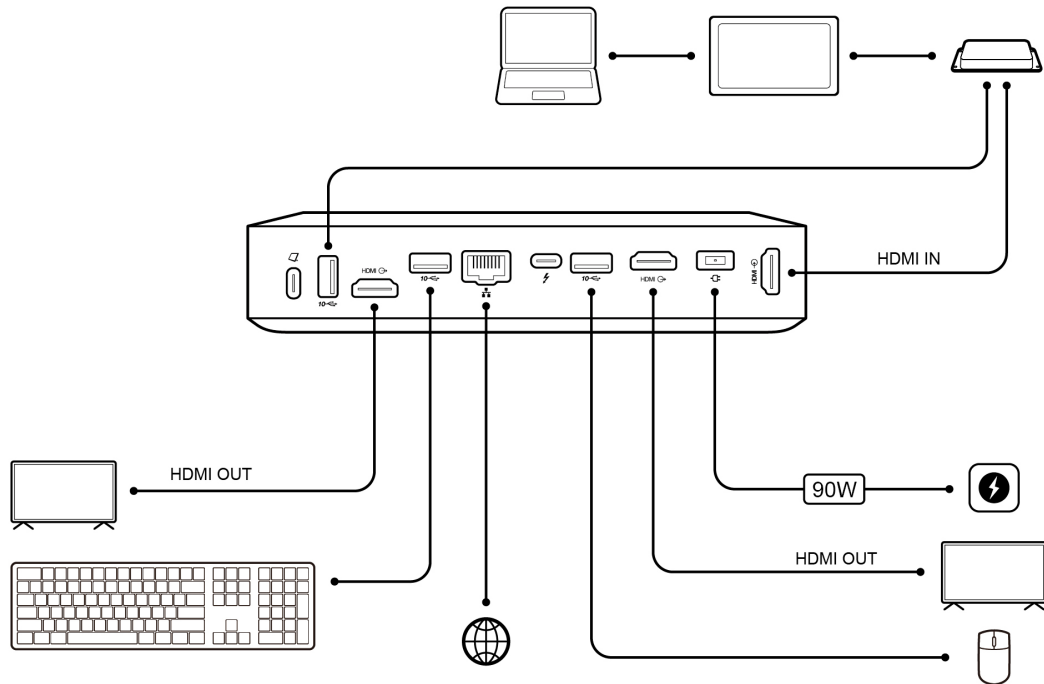

3. Press the power button to turn on Core.

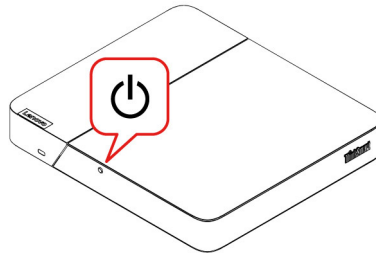

4. Use the keyboard and mouse to complete the following software deployment:

- “Windows OOBE settings” on page 25
- “Claim device to ThinkSmart Manager” on page 27

5. After MTR Setup window is displayed, remove the keyboard and mouse and connect the camera cable and soundbar cable to Core.

Note: Sometimes, the on-screen keyboard is not popped out after you touch the input box on the Controller. In such case, you can keep the external keyboard connected to ThinkSmart Core for operation.

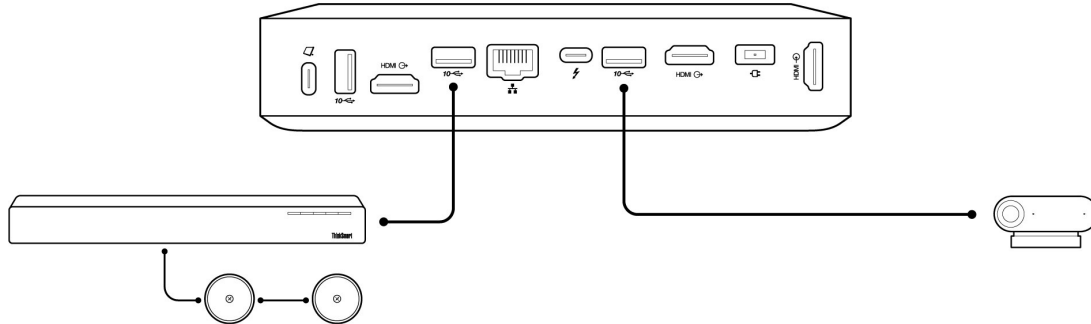

6. Do one of the following to mount Core:

- Mount under table (recommended)

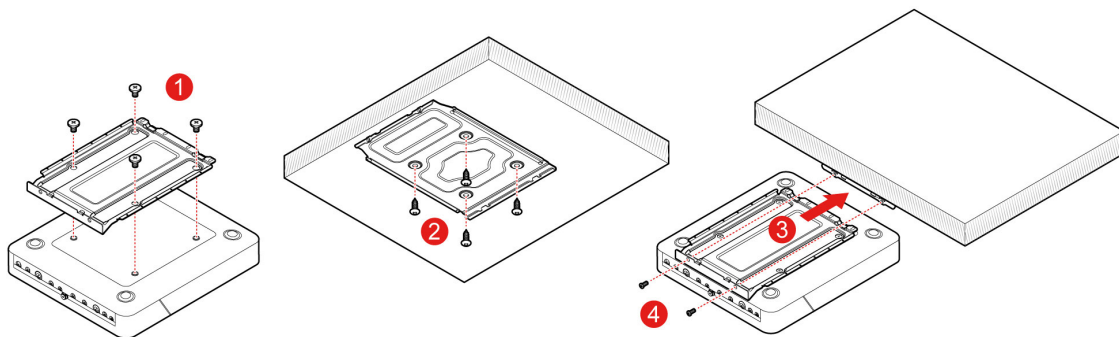

- Mount on wall

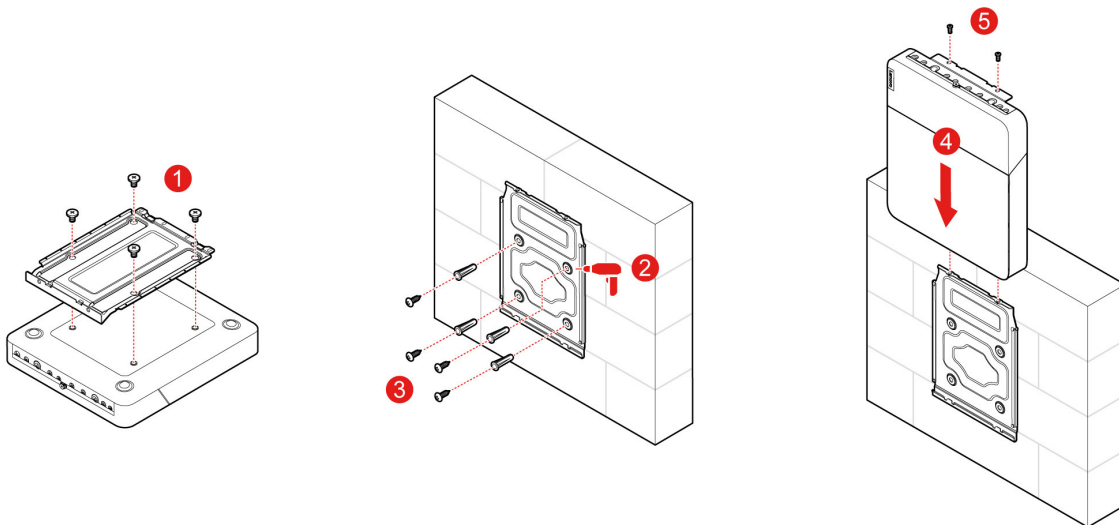

7. Close the Core door.

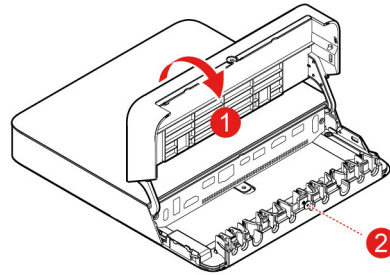

8. Lock Core to a table or other fixture through one of the following cable locks. The security-lock slot is located in the Core door.

- Kensington / Lenovo NanoSaver lock standard (using Cleat locking technology)
- Kensington / Lenovo MicroSaver lock standard (using T-bar locking technology)
- Kensington / Lenovo MiniSaver lock standard (using Cleat locking technology)

Note: You are responsible for evaluating, selecting, and implementing the locking device and security feature. Lenovo makes no comments, judgments, or warranties about the function, quality, or performance of the locking device and security feature. You can purchase locks from Lenovo.

Chapter 4. Software deployment

Windows OOBE settings

When you turn on ThinkSmart Core for the first time, you will see the Windows OOBE basic settings window. Follow on-screen instructions to set the region and keyboard language.

Note: It is working as designed to show the OOBE window on the external display rather than the Controller. Please complete the settings with your keyboard and mouse.

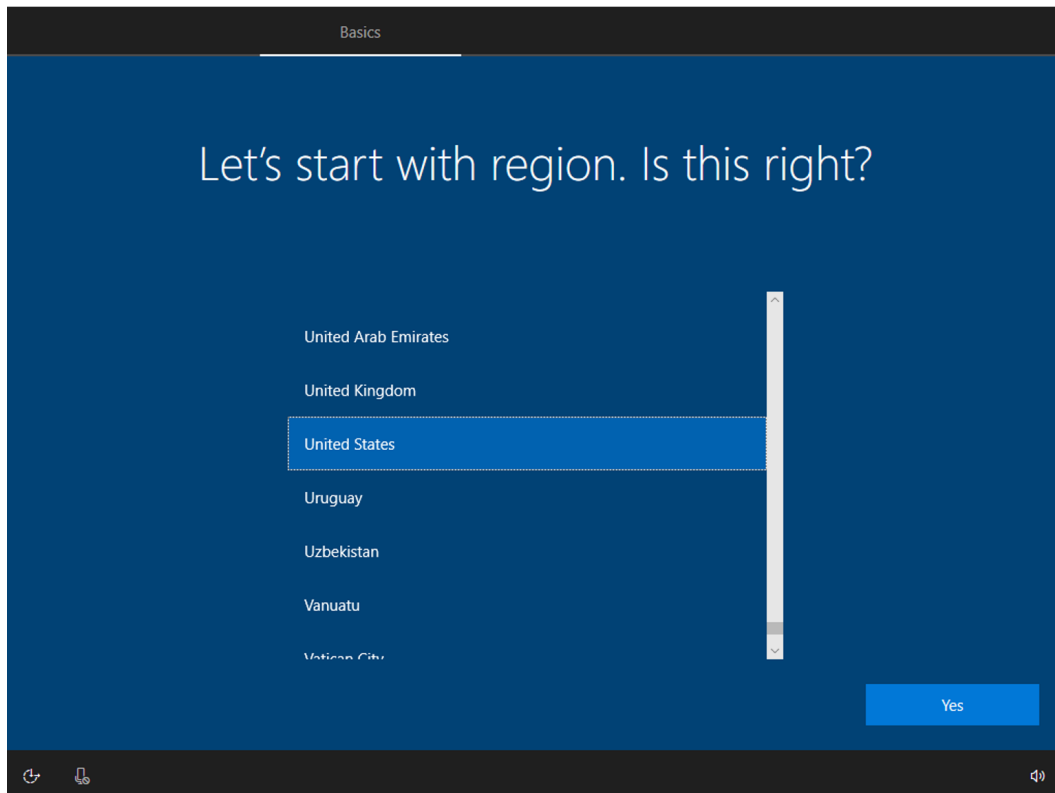

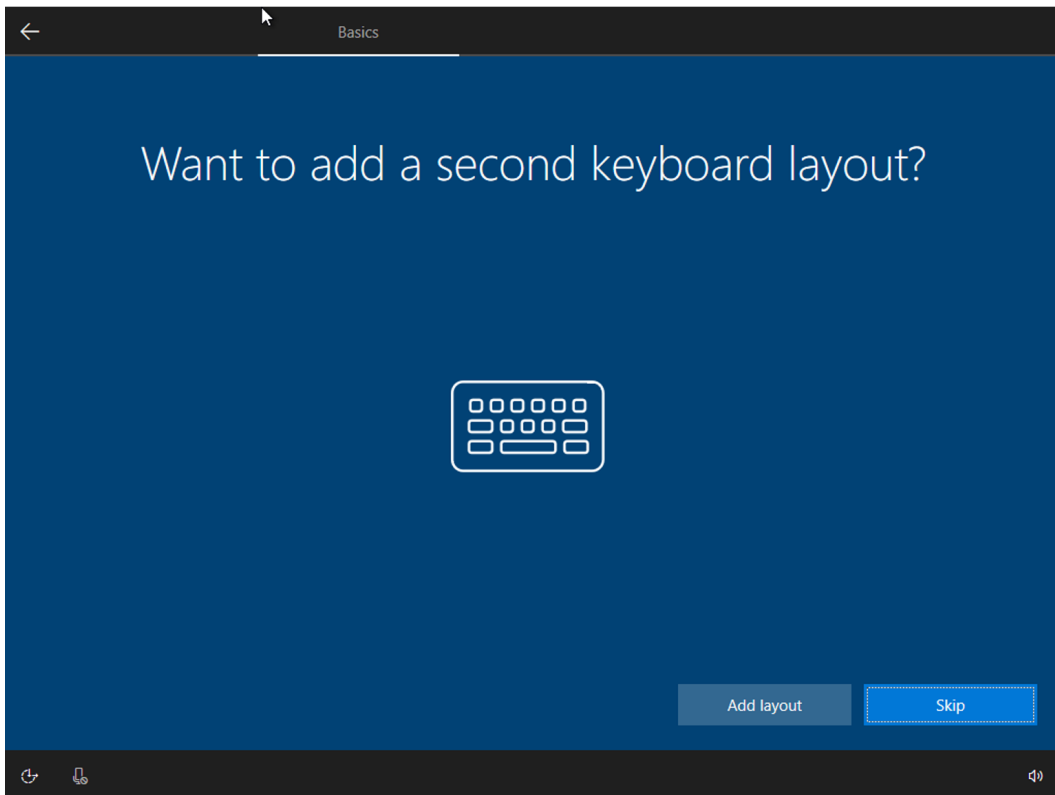
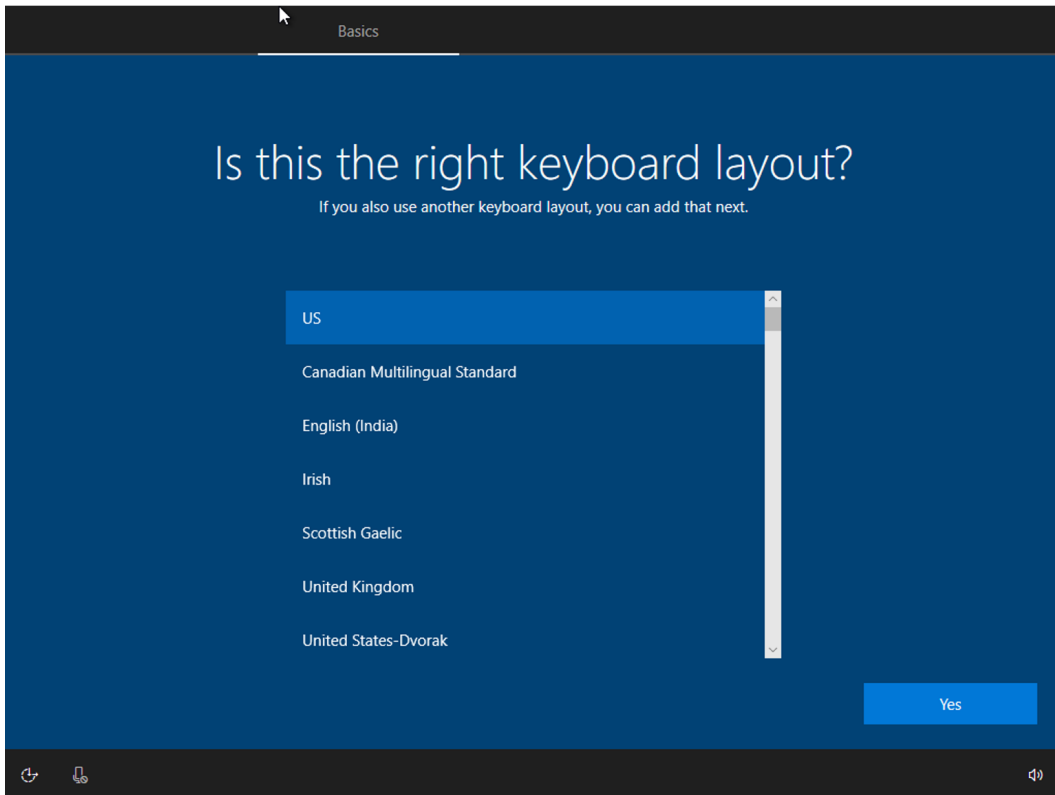

Claim device to ThinkSmart Manager

ThinkSmart Manager is a cloud management console designed for Lenovo smart devices, including ThinkSmart Core. IT administrators can claim ThinkSmart Core to ThinkSmart Manager so as to add, configure, and manage ThinkSmart Core and attached peripherals from cloud.

After the Windows OOBE settings are completed, wait several minutes until the Claim Device to ThinkSmart Manager window is displayed. Then you can claim ThinkSmart Core through the QR code or the PIN code. After claiming, a new Windows administrator password will be generated by ThinkSmart Manager automatically. See the following sections for details.

Note: The Controller touch screen is ready for use now. However, for optimal performance, it is recommended to use the keyboard and mouse to complete the claiming process.

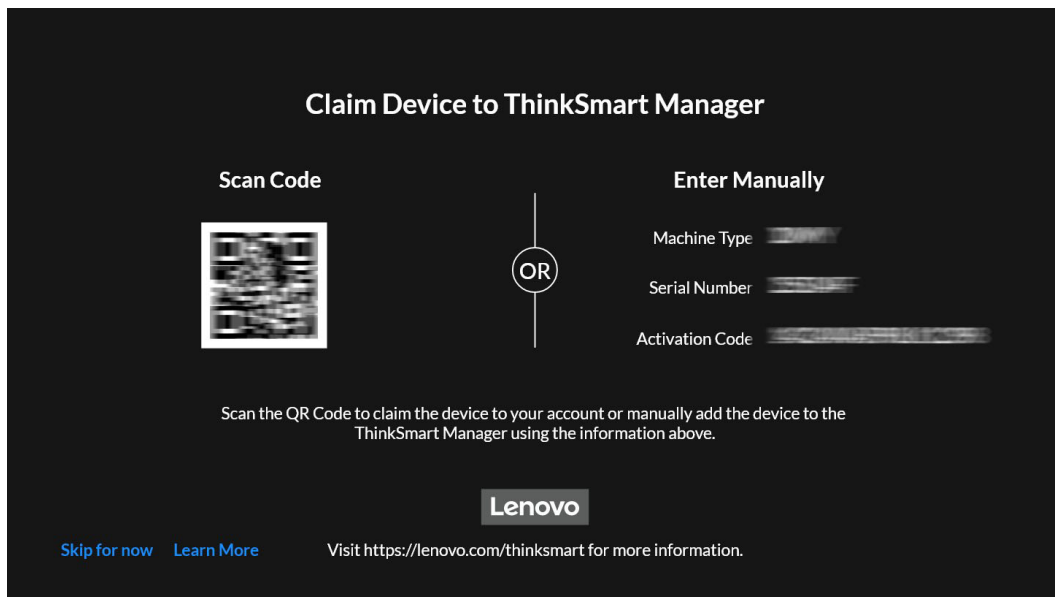

It is recommended that you claim now. However, if you want to claim later, you can:

1. Select **Skip for now** on the Claim Device to ThinkSmart Manager window. The Change Default Administrator Password prompt will be displayed.
2. Set a new Windows administrator password and select **Change password** to complete the process.

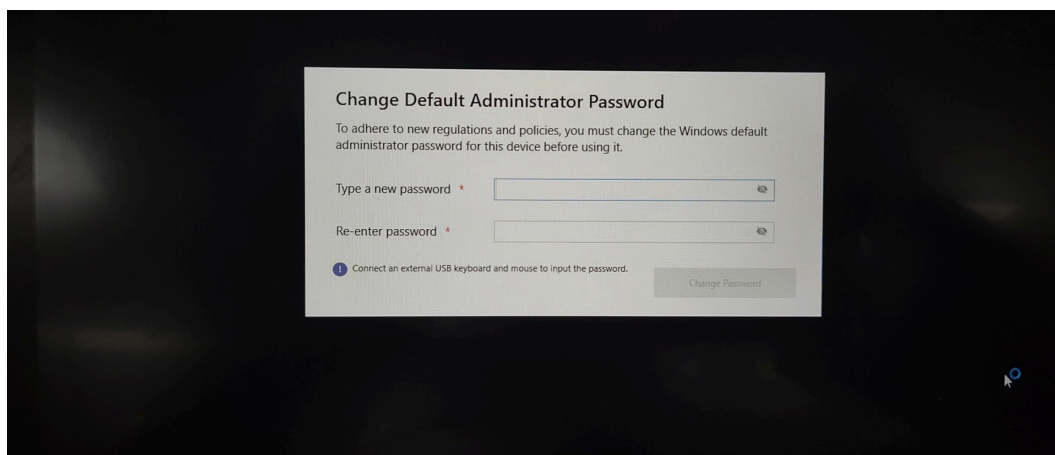

For information about claiming device after Windows OOB, see *ThinkSmart Manager User Guide* at <https://smartsupport.lenovo.com/us/en/downloads/DS542392> to complete the claiming process.

Before claiming

1. Go to <https://console.thinksmart.lenovo.com/> and log in with your Lenovo ID. If you do not have a Lenovo ID, select **Sign up** and follow the on-screen instructions to create a Lenovo ID. Ensure that you validate the e-mail that comes from Lenovo when you first create a Lenovo ID. Once you have validated using the link in the e-mail, you can try to log in to ThinkSmart Manager with your Lenovo ID.

Important: Do not use Lenovo ID's Social Sign-on feature (Facebook, Google, or Windows Live ID) for your ThinkSmart Manager. We recommend you use an e-mail address and password to ensure full functionality.

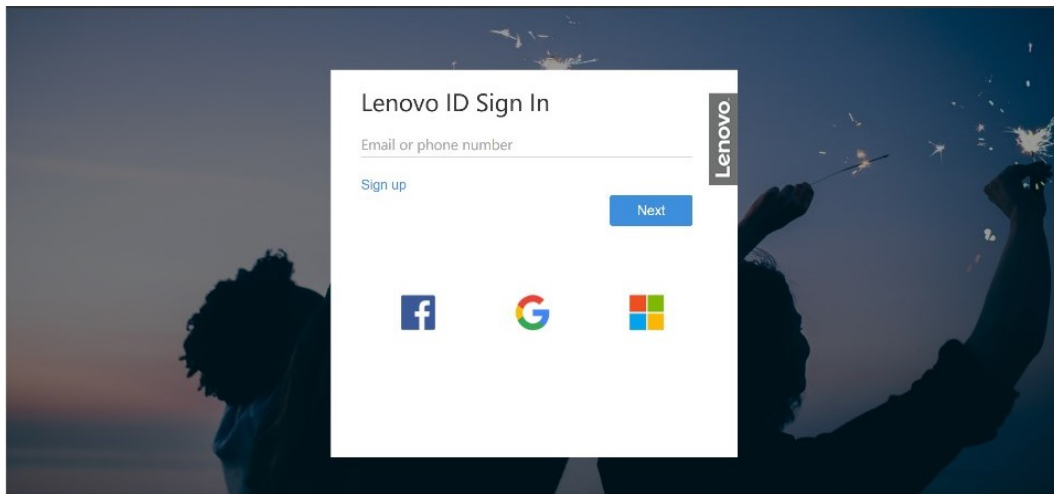

2. The first user from an organization will be required to create a new organization. Select **Create a new organization** and follow the on-screen instructions to fill in the required information.

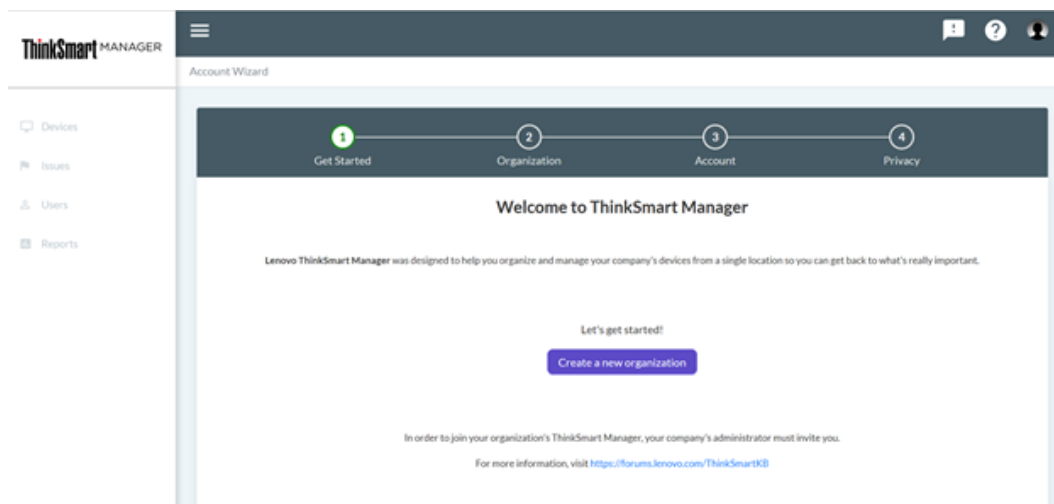

3. That first user is known as an Owner. The owner can send invites from ThinkSmart Manager to people who need access in the organization.

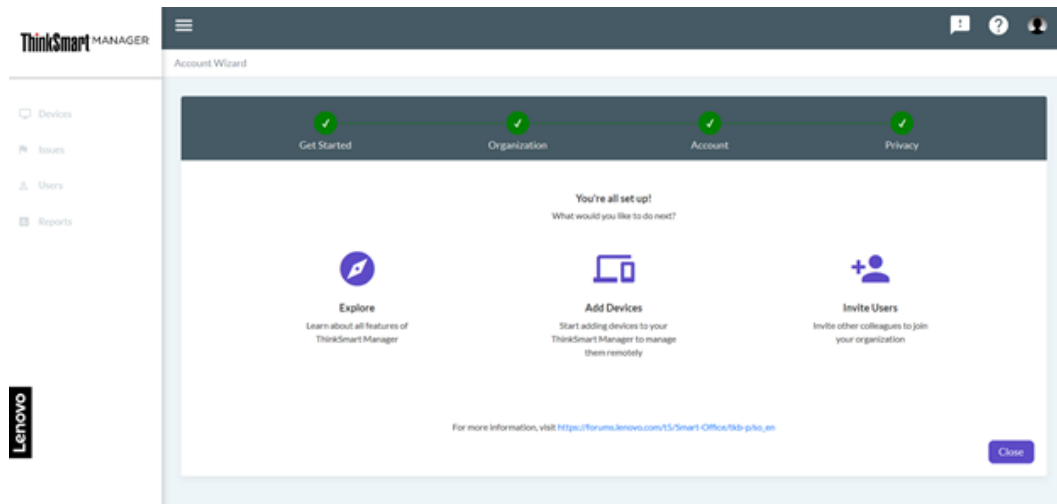

Claiming ways

There are 2 ways to claim a device to ThinkSmart Manager:

- Claim by the QR code or the PIN code from the ThinkSmart Manager application
- Claim by the PIN code from the ThinkSmart Manager Web site

The following sections show the claiming way from the ThinkSmart Manager application. For information about the other claiming way, see *ThinkSmart Manager User Guide* at <https://smartsupport.lenovo.com/us/en/downloads/DS542392>.

Claiming from the ThinkSmart Manager application

Prerequisite

- Prepare a mobile device (such as smart phone) that can scan a QR code.
- Ensure that ThinkSmart Core and the mobile device are connected to the Internet during the claiming process.

Claiming steps

1. Use your mobile device to scan the QR code. Follow on-screen instructions to install the ThinkSmart Manager application and log in with your Lenovo ID.

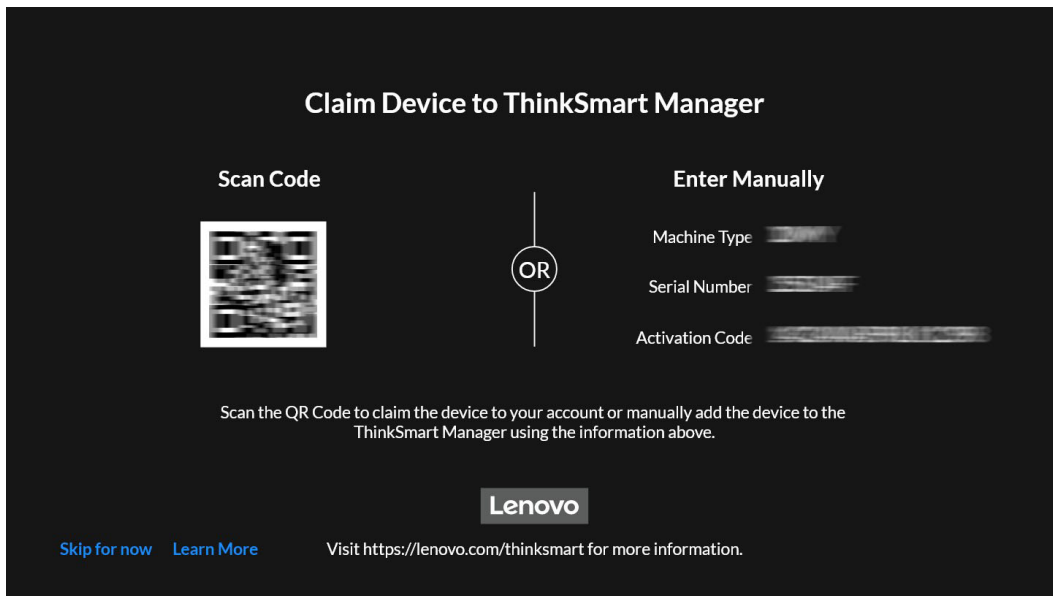

2. Complete the following operations on your mobile device.

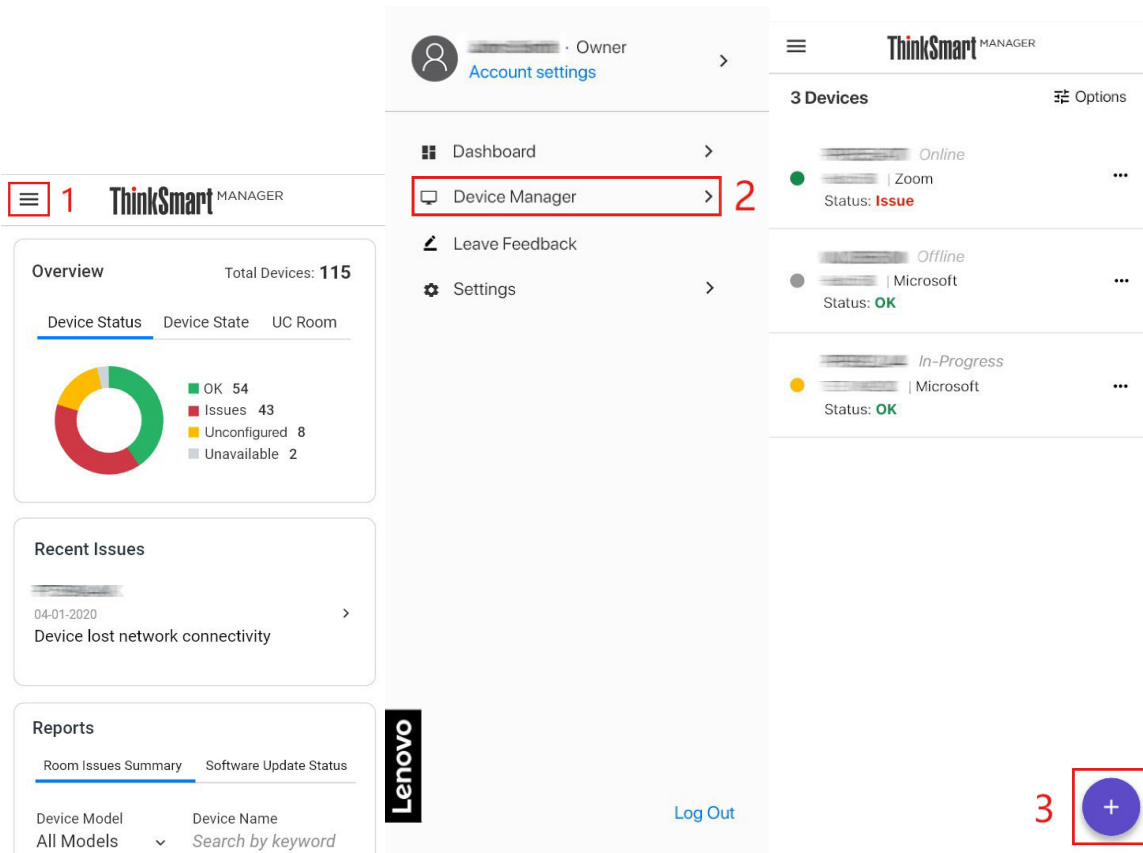

3. Add ThinkSmart Core by one of the following:

- **Scan QR barcode** (recommended): This QR code contains all the information required to add ThinkSmart Core to ThinkSmart Manager. Once scanned, the application will add ThinkSmart Core automatically.
- **Add manually**: Once selected, the application will guide you to select Machine Type and enter Serial Number and the PIN code to add ThinkSmart Core manually.

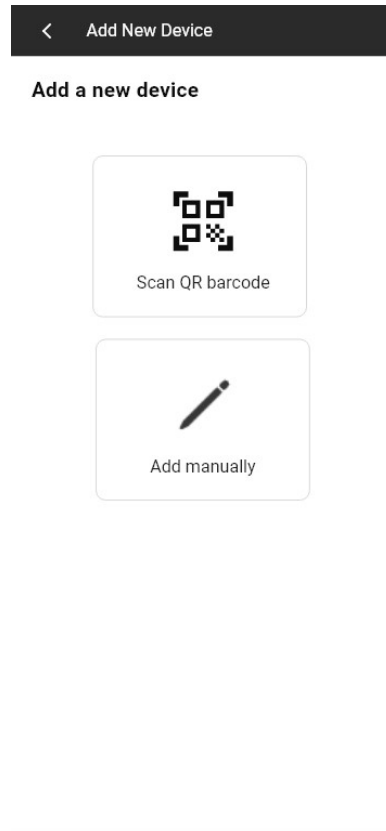

4. Select if you want to apply the default organization configurations to ThinkSmart Core from cloud.
 - Select it if you have configured ThinkSmart Core locally and don't want to apply the default organization configurations.
 - Do not select it if you want to apply the default organization configurations.

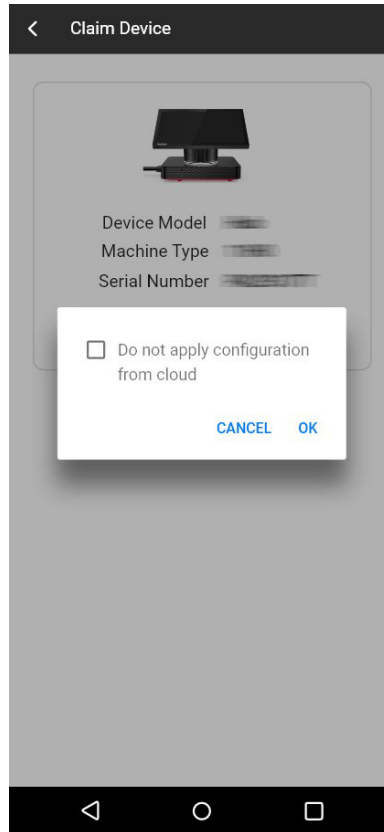

5. The claiming is successful.

DONE

✔ Claim successful!



Device Model [REDACTED]
Machine Type [REDACTED]
Serial Number [REDACTED]

[Configure Device](#)

+ CLAIM ANOTHER DEVICE



6. Follow the on-screen instructions to complete the claiming process.

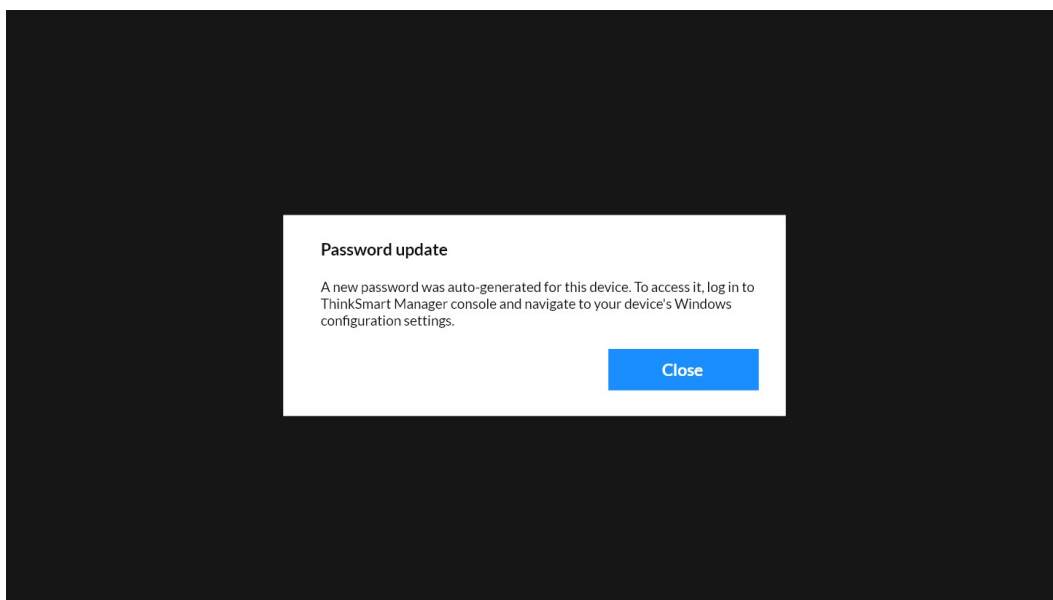
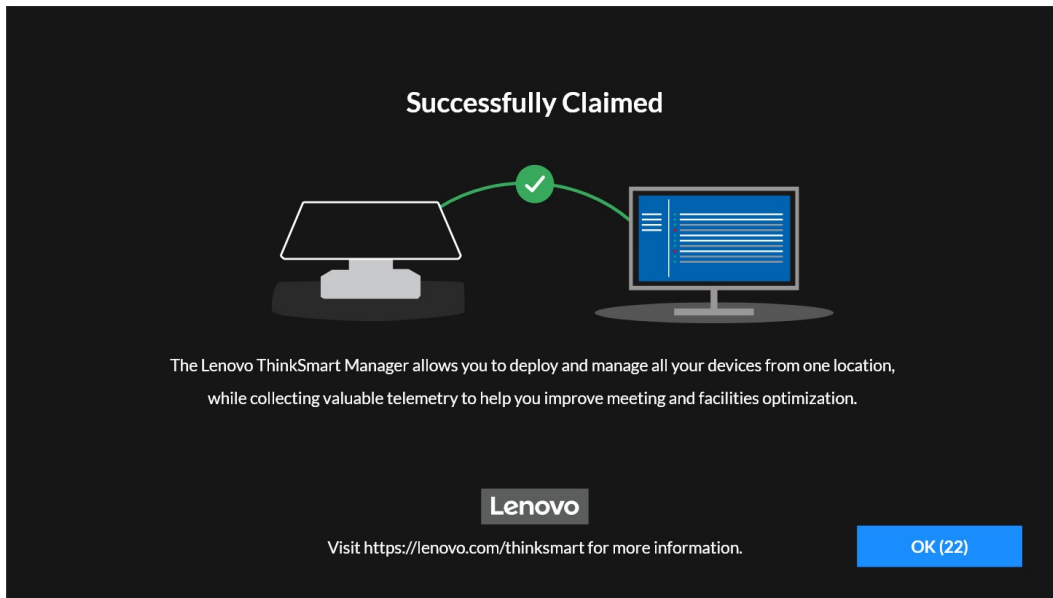

After claiming

You can view the administrator password from ThinkSmart Manager. You will need this password to enter the MTR Settings page or enter the administrator account.

1. Go to <https://console.thinksmart.lenovo.com/> and log in with your Lenovo ID.
2. Select **Devices** on the left navigation panel. The Device List page is displayed.
3. Select the device you want to manage. The device information window is displayed.
4. Select **Configuration** → **Windows** on the right panel. Then, follow the on-screen instructions to view the administrator password.

For information about configuring and managing devices through ThinkSmart Manager, see *ThinkSmart Manager User Guide* at <https://smartsupport.lenovo.com/us/en/downloads/DS542392>.

MTR Setup

After the claiming is completed, wait several minutes until the MTR Setup window is displayed.

1. Select the box and select **Next**.

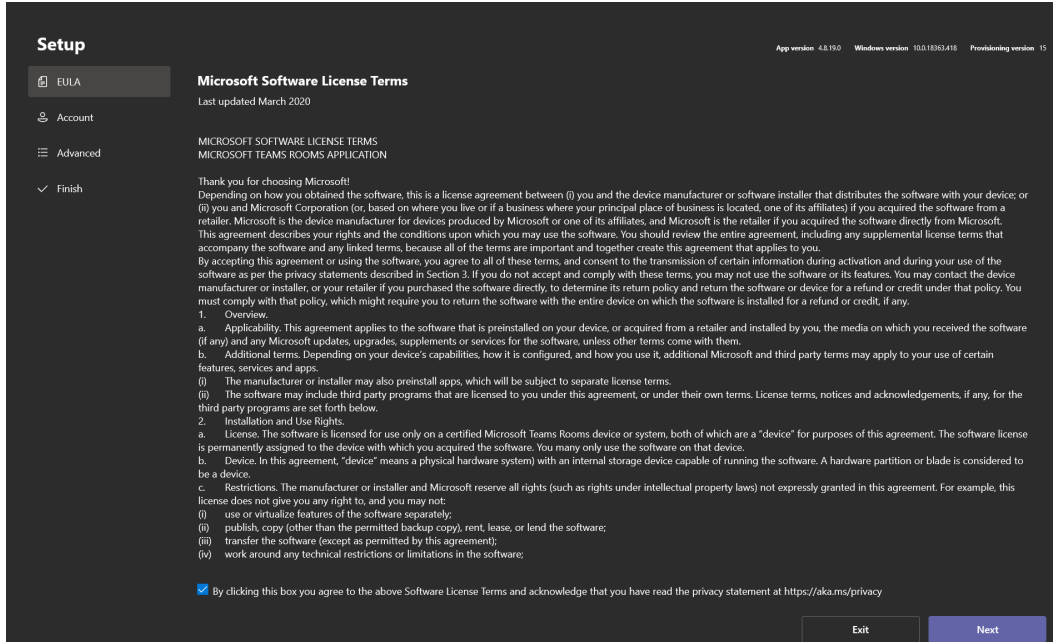

2. Enter an MTR account and password and select the desired meeting mode. Select **Next**.

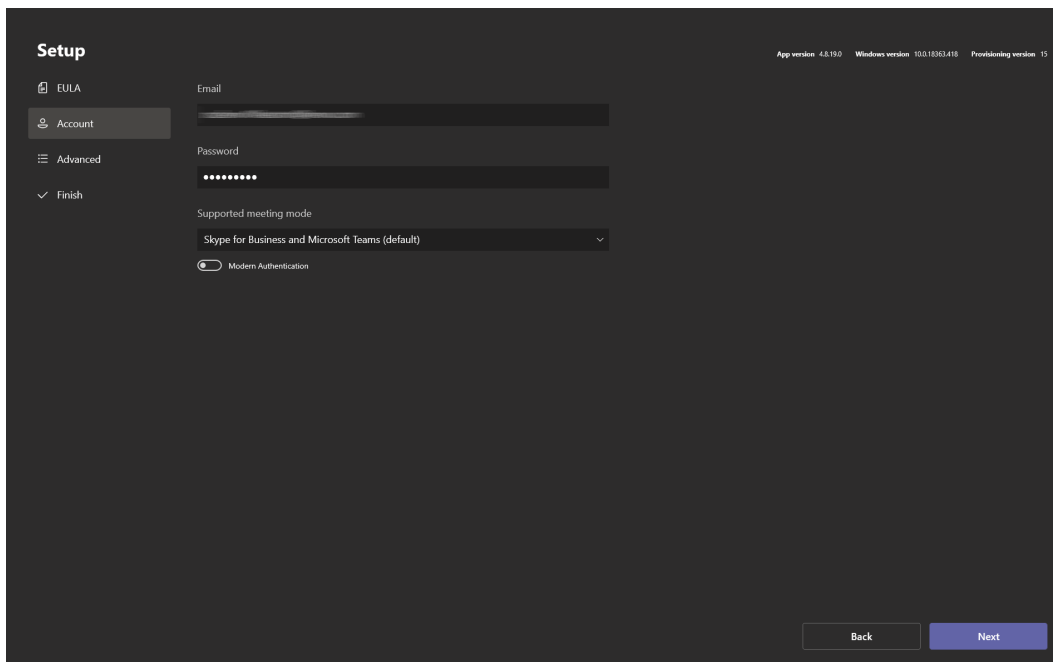

3. Select **Next** and **Finish** to complete the settings.

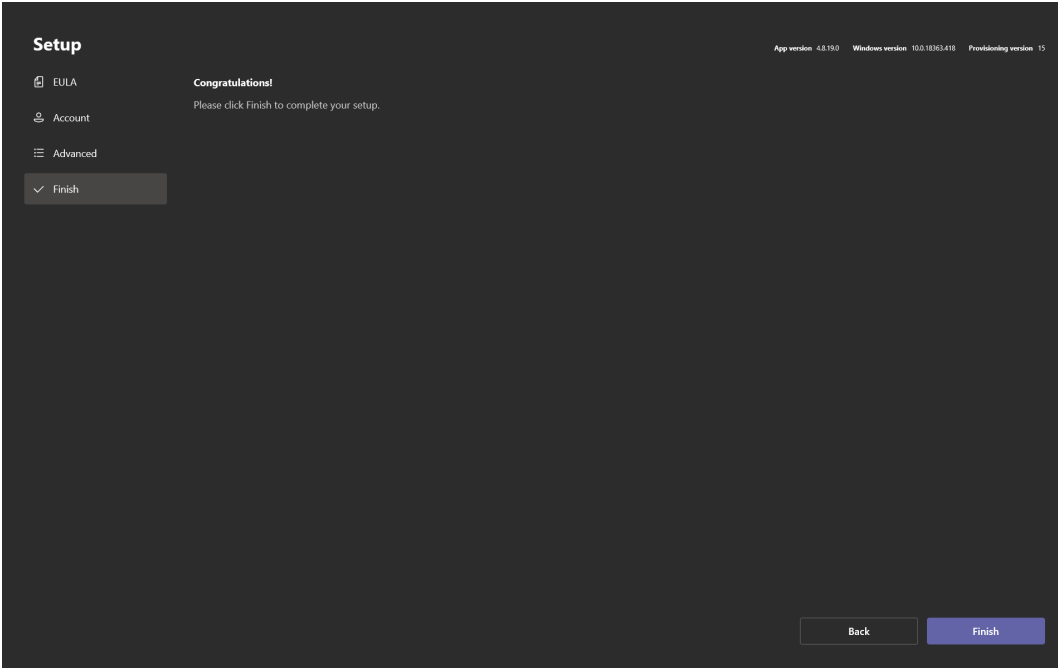
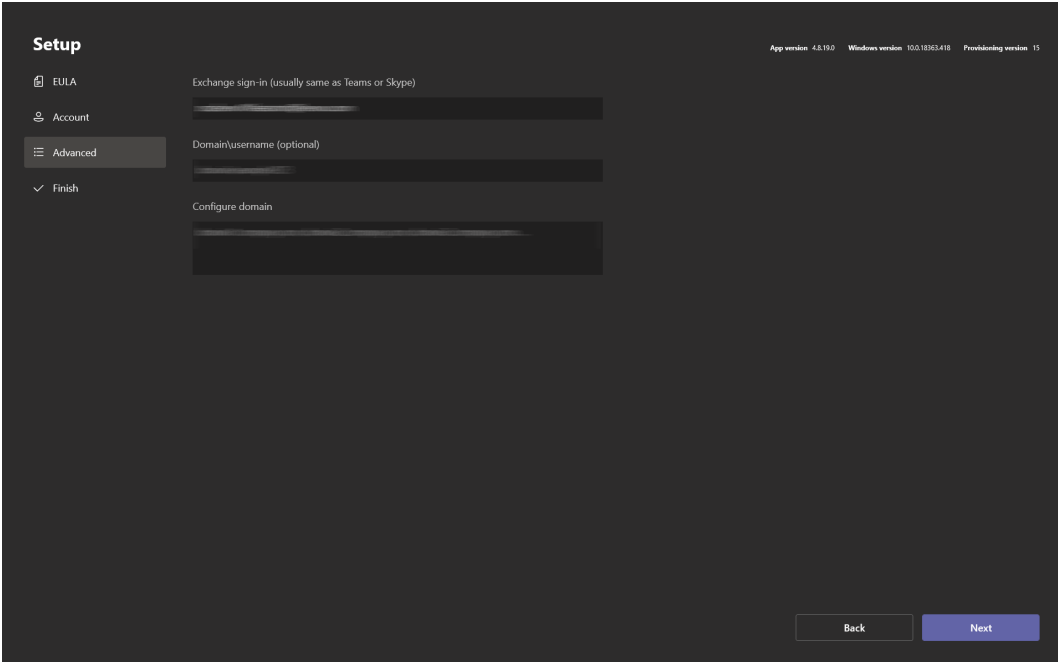

MTR Settings

After the MTR Setup settings are completed, wait several minutes until the MTR home screen is displayed.

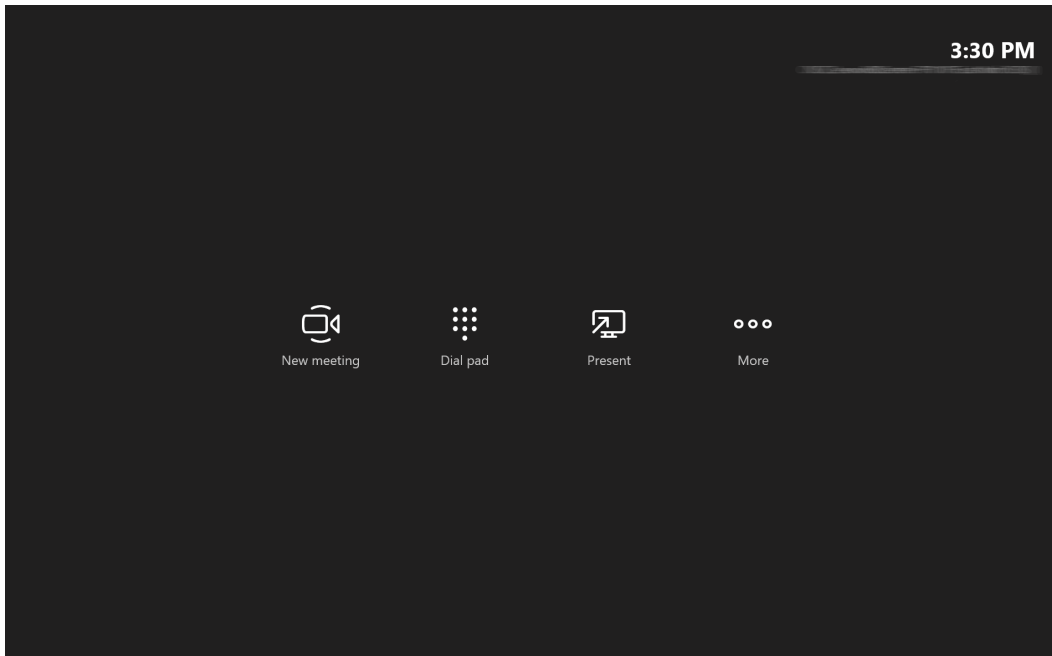

To access MTR Settings:

1. Select **More** → **Settings**.
2. Enter the Windows administrator password as prompted. The MTR Settings page will be displayed.

Then, you can configure the MTR settings and select **Save and exit** to save the settings. For example,

- From the Device tab, turn on **Dual monitor mode** to enable the two external displays connected to ThinkSmart Core.

- From the Peripherals tab, set ThinkSmart Bar as the microphone and speaker for conferencing.

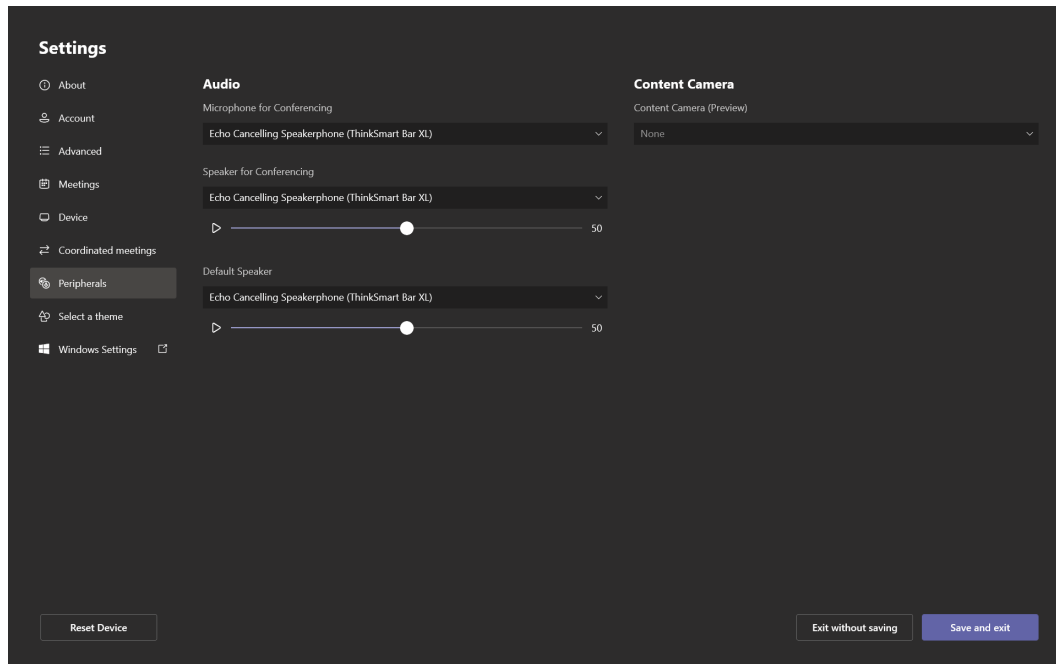

Note: The content camera setting is for a certified content camera only. ThinkSmart Cam is not a content camera, so please keep the original setting.

Switch between MTR account and administrator account

To switch from the MTR account to the administrator account,

1. Go to the MTR Settings page.
2. Select **Windows Settings**.
3. Select **Administrator** and enter the administrator password.

To switch from the administrator account to the MTR account,

1. Open the **Start** menu.
2. Select **Administrator → Sign out**.
3. Select **Skype → Sign in**.

Chapter 5. Typical conferencing scenarios

Note: This chapter provides typical conferencing scenarios with illustrations to help end users quickly get started with MTR. Illustrations might look different from your product. For the latest information about MTR, go to <https://support.microsoft.com/en-us/office/microsoft-teams-rooms-help-e667f40e-5aab-40c1-bd68-611fe0002ba2?ui=en-us&rs=en-us&ad=us>.

Learn about MTR home screen

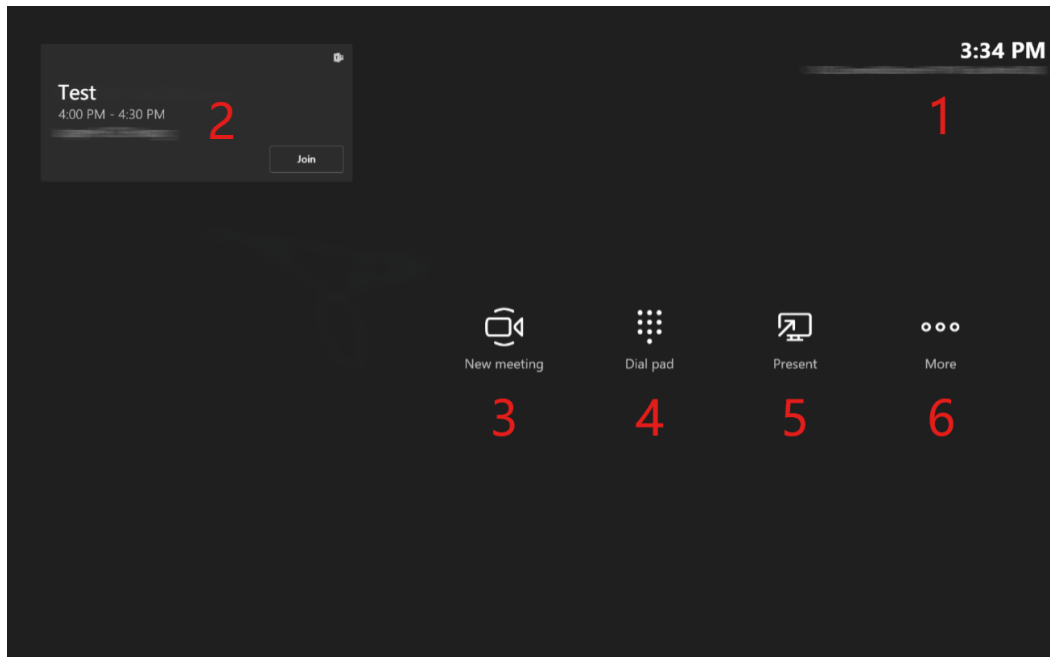

UI	Function
Conference room name	Used to search for the conference room email address (MTR account).
Room calender	Show the scheduled meeting information (title, time, and host). Touch Join to join a scheduled meeting quickly.
New meeting	Select it to start a new meeting.
Dial pad	Select it to make a phone call.
Present	Select it to start or stop content sharing from the connected computer through HDMI-in connection.
More	Select it for more information and settings.

Join a scheduled meeting

1. Send a meeting invitation to attendees and the conference room email address (MTR account). Once the meeting is accepted, it will appear on the room calendar shortly.

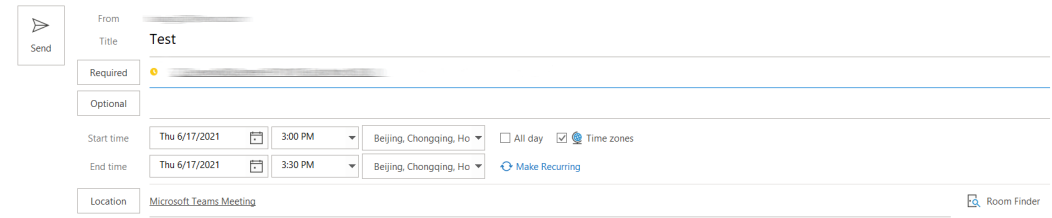

The screenshot shows a meeting invitation form in Microsoft Teams. It includes a 'Send' button, a 'From' field, a 'Title' field with the text 'Test', and 'Required' and 'Optional' attendee lists. The 'Start time' is set to 'Thu 6/17/2021 3:00 PM' in 'Beijing, Chongqing, Ho' with options for 'All day' and 'Time zones'. The 'End time' is 'Thu 6/17/2021 3:30 PM' in the same location, with a 'Make Recurring' link. The 'Location' is 'Microsoft Teams Meeting' and there is a 'Room Finder' icon.

Microsoft Teams meeting

Join on your computer or mobile app
[Click here to join the meeting](#)

2. Select **Join** to join the meeting.

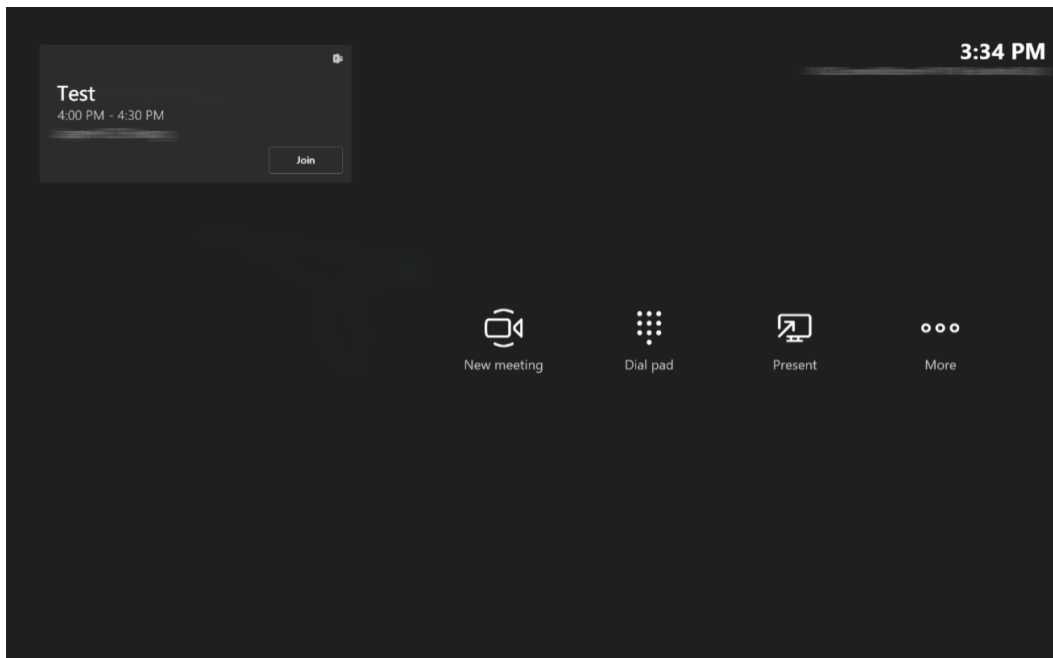

Create a new meeting

1. Select **New meeting**.

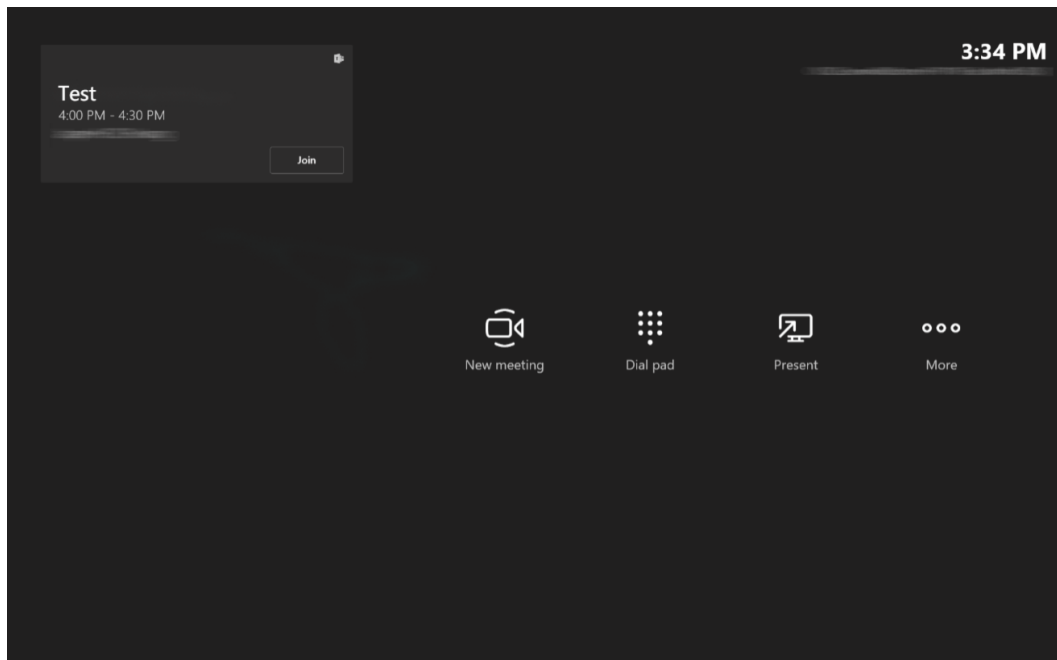

2. Type a name to search and select the people you want to invite. Select **Invite** to create a new meeting.

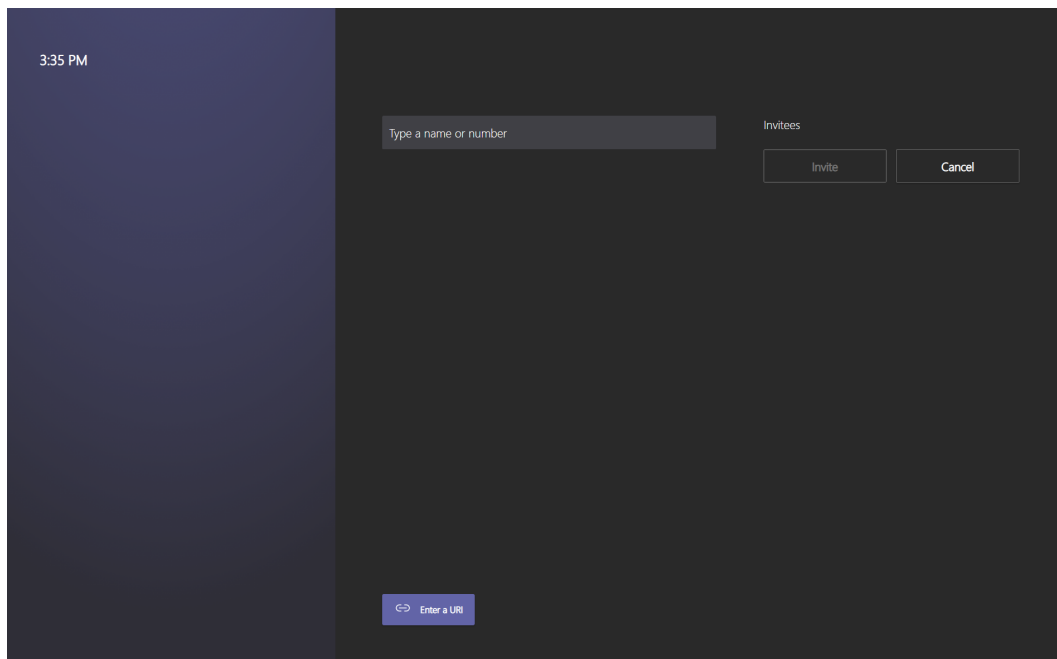

Invite ThinkSmart Core during a meeting

1. Search and select the conference room name from the MTR application on your computer.
2. Accept the call on the Controller to join the meeting.

Share content

Share your screen with in-room attendees

Connect your computer to the HDMI-in connector on ThinkSmart Core. Your screen will be shared automatically.

Share your screen with in-room attendees and remote attendees

1. Connect your computer to the HDMI-in connector on ThinkSmart Core. Your screen will be shared with in-room attendees automatically.
2. Join the meeting from the MTR home screen on the Controller. Your screen will be shared with remote attendees too.

Stop sharing your screen

- To stop sharing with remote attendees, select the stop presenting icon from the Controller.
- To stop sharing with in-room attendees, disconnect your computer from ThinkSmart Core.

Chapter 6. Secure ThinkSmart Core and information

Notes:

- Connect a keyboard to ThinkSmart Core for easy configurations.
- ThinkSmart Core is referred to as “Computer” in this chapter.

UEFI BIOS passwords

You can set passwords in UEFI (Unified Extensible Firmware Interface) BIOS (Basic Input/Output System) to strengthen the security of your computer.

Password types

You can set a power-on password, supervisor password, system management password, or hard disk password in UEFI BIOS to prevent unauthorized access to your computer. However, you are not prompted to enter any UEFI BIOS password when your computer resumes from sleep mode.

- Power-on password

When a power-on password is set, you are prompted to enter a valid password each time the computer is turned on.

- Supervisor password

Setting a supervisor password deters unauthorized users from changing configuration settings. If you are responsible for maintaining the configuration settings of several computers, you might want to set a supervisor password.

When a supervisor password is set, you are prompted to enter a valid password each time you try to enter the BIOS menu.

If both the power-on password and supervisor password are set, you can enter either password. However, you must use your supervisor password to change any configuration settings.

- Hard disk password

Setting a hard disk password prevents unauthorized access to the data on the storage drive. When a hard disk password is set, you are prompted to enter a valid password each time you try to access the storage drive.

Note: After you set a hard disk password, your data on the storage drive is protected even if the storage drive is removed from one computer and installed in another.

- System management password (for selected models)

You can enable the system management password to have the same authority as the supervisor password to control security related features. To customize the authority of the system management password through the UEFI BIOS menu:

1. Restart the computer. When the logo screen is displayed, press F1 or Fn+F1.
2. Select **Security → System Management Password Access Control**.
3. Follow the on-screen instructions.

If you have set both the supervisor password and the system management password, the supervisor password overrides the system management password.

Set, change, and remove a password

Before you start, print these instructions.

1. Restart the computer. When the logo screen is displayed, press F1 or Fn+F1.
2. Select **Security**.
3. Depending on the password type, select **Set Supervisor Password**, **Set Power-On Password**, **Set System Management Password**, or **Hard Disk Password** and press Enter.
4. Follow the on-screen instructions to set, change, or remove a password.
5. Press F10 or Fn+F10 to save the changes and exit.

You should record your passwords and store them in a safe place. If you forget the passwords, contact a Lenovo-authorized service provider to have the passwords removed.

Note: If the hard disk password is forgotten, Lenovo cannot remove the password or recover data from the storage drive.

Use BIOS security solutions

This section provides BIOS solutions to secure your computer and information.

Wipe the storage drive data

It is recommended that you wipe the storage drive data before recycling the storage drive or the computer.

To wipe the storage drive data:

1. Restart the computer. When the logo screen is displayed, press F1 or Fn+F1.
2. Select **Security** → **secure wipe** → **Enabled**.
3. Press F10 or Fn+F10 to save the changes and exit.
4. Restart the computer. When the logo screen is displayed, press F12 or Fn+F12.
5. Select **App Menu** → **secure wipe** and press Enter.
6. Select the storage drive you will wipe and click **NEXT**.
7. Select the entire storage drive or partition to wipe as desired.
8. Select the method as desired and click **NEXT**.
9. Click **Yes** to confirm your option when the prompting window is displayed.
10. If you have set a hard disk password for the storage drive, enter the password. Otherwise, set a temporary password following the on-screen instructions. Then, click **NEXT**. The wiping process begins.

Note: Duration of the wiping process varies depending on the storage drive capacity.

11. Click **Reboot** when you are prompted to reset the system, and then one of the following will happen:
 - If the system storage drive data is wiped, you will be prompted that no operating system is found.
 - If the non-system storage drive data is wiped, the computer restarts automatically.

Intel BIOS guard

The Intel® BIOS Guard module cryptographically verifies all BIOS updates. This hardware-based security helps prevent software and malware attacks on the computers BIOS.

Smart USB Protection

The Smart USB Protection function is a security function that helps prevent data from being copied from the computer to USB storage devices connected to the computer. You can set the Smart USB Protection function to one of the following modes:

- **Disabled** (default setting): You can use the USB storage devices without limitation.

- **Read Only:** You cannot copy data from the computer to the USB storage devices. However, you can access or modify data on the USB storage devices.
- **No Access:** You cannot access the USB storage devices from the computer.

To configure the Smart USB Protection function:

1. Restart the computer. When the logo screen is displayed, press F1 or Fn+F1.
2. Select **Security → Smart USB Protection** and press Enter.
3. Select the desired setting and press Enter.
4. Press F10 or Fn+F10 to save the changes and exit.

Use software security solutions

This section provides software solutions to secure your computer and information.

Windows firewalls

A firewall can be hardware, software, or a combination of both depending on the level of security required. Firewalls work on a set of rules to determine which inbound and outbound connections are authorized. If the computer is preinstalled with a firewall program, it helps protect against computer Internet security threats, unauthorized access, intrusions, and Internet attacks. It also protects your privacy. For more information about how to use the firewall program, refer to the help system of your firewall program.

To use Windows firewalls:

1. Type Control Panel in the Windows search box and then press Enter. View by large icons or small icons.
2. Click Windows Defender Firewall, and then follow the on-screen instructions.

Computrace Agent software embedded in firmware (for selected models)

The Computrace Agent software is an IT asset management and computer theft recovery solution. The software detects if changes have been made on the computer, such as hardware, software, or the computer call-in location. You might have to purchase a subscription to activate the Computrace Agent software.

Chapter 7. UEFI BIOS

Notes:

- Connect a keyboard to ThinkSmart Core for easy configurations.
- ThinkSmart Core is referred to as “Computer” in this chapter.

What is UEFI BIOS

Note: The operating system settings might override any similar settings in UEFI BIOS.

UEFI BIOS is the first program that the computer runs when the computer is turned on. UEFI BIOS initializes the hardware components and loads the operating system and other programs. Your computer comes with a setup program with which you can change UEFI BIOS settings.

Enter the BIOS menu

Restart the computer. When the logo screen is displayed, press F1 or Fn+F1 to enter the BIOS menu.

Note: If you have set BIOS passwords, enter the correct passwords when prompted. You also can select **No** or press Esc to skip the password prompt and enter the BIOS menu. However, you cannot change the system configurations that are protected by passwords.

Navigate in the BIOS interface

Attention: The default configurations are already optimized for you in **boldface**. Improper change of the configurations might cause unexpected results.

Depending on your keyboard, you can navigate in the BIOS interface by pressing the following keys, or combinations of Fn and the following keys:

Key	Function
F1 or Fn+F1	General Help
Esc or Fn+Esc	Exit the submenu
↑ ↓ or Fn+↑ ↓	Locate an item
← → or Fn+← →	Move keyboard focus
+/- or Fn++/-	Change value
Enter	Enter the submenu
F9 or Fn+F9	Setup Defaults
F10 or Fn+F10	Save and exit

Change the display language of UEFI BIOS

UEFI BIOS supports three or four display languages: English, French, simplified Chinese, and Russian (for selected models).

To change the display language of UEFI BIOS:

1. Select **Main → Language** and press Enter.
2. Set the display language as desired.

Change the display mode of UEFI BIOS (for selected models)

You can use UEFI BIOS in the graphic mode or the text mode according to your needs.

The keys on the keyboard used to perform various tasks are displayed at the bottom of the screen. In addition to the keyboard, you also can use the mouse to make selections.

To change the display mode of UEFI BIOS:

1. Restart the computer. When the logo screen is displayed, press F1 or Fn+F1.
2. Select **Main → Setup Mode Select** and press Enter.
3. Set the display mode as desired.

Set the system date and time

1. Restart the computer. When the logo screen is displayed, press F1 or Fn+F1.
2. Select **Main → System Time & Date** and press Enter.
3. Set the system date and time as desired.
4. Press F10 or Fn+F10 to save the changes and exit.

Change the priority boot order

If the computer does not boot from a device as expected, you can change the boot priority order permanently or select a temporary boot device.

Change the priority boot order permanently

1. Depending on the type of the storage device, do one of the following:
 - If the storage device is internal, go to step 2.
 - If the storage device is a disc, ensure that the computer is on or turn on the computer. Then, insert the disc into the optical drive.
 - If the storage device is an external device other than a disc, connect the storage device to the computer.
2. Restart the computer. When the logo screen is displayed, press F1 or Fn+F1.
3. Select **Startup → Priority Boot Order**, and then follow the on-screen instructions to change the boot priority order.
4. You can also select the first priority device group by selecting **Startup → First Boot Device**, and then follow the on-screen instructions to select the first boot device within this group. Your computer will boot from the first boot device before trying the boot priority order you set in the previous step.
5. Press F10 or Fn+F10 to save the changes and exit.

Select a temporary boot device

Note: Not all discs and storage drives are bootable.

1. Depending on the type of the storage device, do one of the following:
 - If the storage device is internal, go to step 2.

- If the storage device is a disc, ensure that the computer is on or turn on the computer. Then, insert the disc into the optical drive.
 - If the storage device is an external device other than a disc, connect the storage device to the computer.
2. Restart the computer. When the logo screen is displayed, press F12 or Fn+F12.
 3. Select the storage device as desired and press Enter.

If you want to change the boot priority order permanently, select **Enter Setup** on Startup Device Menu and press Enter to enter the BIOS menu.

Enable or disable a device

This section provides information about how to enable or disable user access to hardware devices (such as USB connectors or storage drives).

To enable or disable a device, do the following:

1. Restart the computer. When the logo screen is displayed, press F1 or Fn+F1.
2. Select **Devices**.
3. Select the device you want to enable or disable and press Enter.
4. Select the desired setting and press Enter.
5. Press F10 or Fn+F10 to save the changes and exit.

Enable or disable the configuration change detection feature

If you enable configuration change detection, when the POST detects configuration changes of some hardware devices (such as storage drives or memory modules), an error message will be displayed when you turn on the computer.

To enable or disable the configuration change detection feature:

1. Restart the computer. When the logo screen is displayed, press F1 or Fn+F1.
2. Select **Security → Configuration Change Detection** and press Enter.
3. Enable or disable the feature as desired.
4. Press F10 or Fn+F10 to save the changes and exit.

To bypass the error message and log in to the operating system, press F2 or Fn+F2. To clear the error message, enter the BIOS menu, save and then exit.

Enable or disable the automatic power-on feature

The Automatic Power On item in UEFI BIOS provides various options for you to make your computer start up automatically.

To enable or disable the automatic power-on feature:

1. Restart the computer. When the logo screen is displayed, press F1 or Fn+F1.
2. Select **Power → Automatic Power On** and press Enter.
3. Select the feature as desired and press Enter.
4. Enable or disable the feature as desired.
5. Press F10 or Fn+F10 to save the changes and exit.

Enable or disable the ErP LPS compliance mode

Lenovo computers meet the eco-design requirements of the ErP Lot 3 regulation. For more information, go to:

<https://www.lenovo.com/us/en/compliance/eco-declaration>

You can enable the ErP LPS compliance mode to reduce the consumption of electricity when the computer is off or in sleep mode.

To enable or disable the ErP LPS compliance mode:

1. Restart the computer. When the logo screen is displayed, press F1 or Fn+F1.
2. Select **Power** → **Enhanced Power Saving Mode** and press Enter.
3. Depending on whether you select **Enabled** or **Disabled**, do one of the following:
 - If you select **Enabled**, press Enter. Then, select **Power** → **Automatic Power On** and press Enter. Check whether the Wake on LAN feature is disabled automatically. If no, disable it.
 - If you select **Disabled**, press Enter. Then, go to the next step.
4. Press F10 or Fn+F10 to save the changes and exit.

When the ErP LPS compliance mode is enabled, you can wake up the computer by doing one of the following:

- Press the power button.
- Enable the Wake Up on Alarm feature to make the computer wake up at a set time.

To meet the off mode requirement of ErP compliance, you need to disable the Fast Startup function.

1. Go to **Control Panel** and view by large icons or small icons.
2. Click **Power Options** → **Choose what the power buttons do** → **Change settings that are currently unavailable**.
3. Clear the **Turn on fast startup (recommended)** option from the **Shutdown settings** list.

Change BIOS settings before installing a new operating system

BIOS settings vary by operating system. Change the BIOS settings before installing a new operating system.

Microsoft constantly makes updates to the Windows operating system. Before installing a particular Windows version, check the compatibility list for the Windows version. For details, go to:

<https://support.lenovo.com/us/en/solutions/windows-support>

To change the BIOS settings:

1. Restart the computer. When the logo screen is displayed, press F1 or Fn+F1.
2. From the main interface, select **Security** → **Secure Boot** and press Enter.
3. Depending on the operating system to be installed, do one of the following:
 - To install a Windows operating system that supports secure boot, select **Enabled** for **Secure Boot**.
 - To install an operating system that does not support secure boot, such as some Linux operating systems, select **Disabled** for **Secure Boot**.
4. Press F10 or Fn+F10 to save the changes and exit.

Exit the BIOS menu

To exit the BIOS menu, do one of the following:

- If you want to save the new settings, press the F10 key. Then, select **Yes** in the window displayed and press Enter.

Note: For some keyboards, you might need to press Fn+F10 to exit the BIOS menu.

- If you do not want to save the new settings, select **Exit → Discard Changes and Exit** and press Enter. Then, select **Yes** in the window displayed and press Enter.

Update UEFI BIOS

When you install a new program, device driver, or hardware component, you might need to update UEFI BIOS. You can update the BIOS from your operating system or a flash update disc (supported only on selected models).

Download and install the latest UEFI BIOS update package from the Lenovo Support Web site:

1. Go to <https://smartsupport.lenovo.com/>.
2. Download the flash BIOS update driver for the operating system version or the ISO image version (used to create a flash update disc). Then, download the installation instructions for the flash BIOS update driver you have downloaded.
3. Print the installation instructions and follow the instructions to update the BIOS.

Recover from a BIOS update failure

1. Remove all media from the drives and turn off all connected devices.
2. Insert the BIOS update disc into the optical drive, and then turn off the computer.
3. Disconnect all power cords from electrical outlets. Then, remove any parts that impede access to the Clear CMOS/Recovery jumper.
4. Move the jumper from the standard position to the maintenance position.
5. Reconnect the power cords for the computer and the monitor to electrical outlets.
6. Turn on the computer and the monitor. When the computer beeps, the recovery process begins.
7. After the recovery process is completed, the computer will be turned off automatically.

Note: Depending on the computer model, the recovery process will take two to three minutes.

8. Disconnect all power cords from electrical outlets.
9. Move the jumper back to the standard position.
10. Reinstall all the parts that have been removed. Then, reconnect the power cords for the computer and the monitor to electrical outlets.
11. Turn on the computer and the monitor. When the logo screen is displayed, press F1 or Fn+F1.
12. To prevent data loss, ensure that BIOS settings are restored to an earlier point. For BIOS configurations, see Chapter 7 “UEFI BIOS” on page 49.

Clear CMOS

1. Remove all media from the drives and turn off all connected devices and the computer.
2. Disconnect all power cords from electrical outlets. Then, remove any parts that impede access to the Clear CMOS/Recovery jumper.

3. Move the jumper from the standard position to the maintenance position.
4. Reconnect the power cords for the computer and the monitor to electrical outlets.
5. Turn on the computer and the monitor. When the computer beeps, wait for approximately 10 seconds.
6. Turn off the computer by holding the power button for approximately four seconds.
7. Disconnect all power cords from electrical outlets.
8. Move the jumper back to the standard position.
9. Reinstall all the parts that have been removed. Then, reconnect the power cords for the computer and the monitor to electrical outlets.
10. Turn on the computer and the monitor. When the logo screen is displayed, press F1 or Fn+F1.
11. To prevent data loss, ensure that BIOS settings are restored to an earlier point. For BIOS configurations, see Chapter 7 “UEFI BIOS” on page 49.

Chapter 8. FAQ

Question	Answer
Does ThinkSmart Core come with the UC software preloaded?	Yes. ThinkSmart Core comes with the factory imaged Windows operating system and installed with the UC software.
Does ThinkSmart Core support any other UC platforms?	Yes, but it only supports one UC platform at a time.
Is there Lenovo specific software installed on ThinkSmart Core?	Yes. ThinkSmart Manager software is pre-installed from Lenovo factory. ThinkSmart Manager is Lenovo's solution for management at scale for ThinkSmart devices.
Where can I find the user guide, readme, and software download for ThinkSmart Manager?	https://smartsupport.lenovo.com/us/en/downloads/DS542392
Do I need to install an antivirus on ThinkSmart Core?	By default, the Windows operating system is secured through Windows Defender. Organizations should choose security software based on their requirements.
How are the drivers, software, BIOS updates delivered?	All software updates and driver updates are delivered through Windows Update. BIOS updates are manually downloaded from the Lenovo E-support portal.
Can I manage ThinkSmart Core through Microsoft Operations Management Suite (OMS)?	Please refer to https://docs.microsoft.com/zh-cn/microsoftteams/rooms/rooms-deploy .
Does ThinkSmart Core support PXE boot?	Yes.
Does ThinkSmart Core support network boot?	Yes. ThinkSmart Core supports network boot through the Ethernet connector. Restart ThinkSmart Core. During the boot, press F12 multiple times to load the Startup Device Menu. Based on your infrastructure, select the IPv4 or IPv6 option to initiate the network boot.
Does ThinkSmart Core support USB boot?	Yes. Insert a USB key into one of the USB connectors, and then restart ThinkSmart Core. During the boot, press F12 multiple times to load the Startup Device Menu. Based on your infrastructure, select the USB key to initiate the USB boot.
Can ThinkSmart Core work with HDMI extenders through Ethernet?	Yes. ThinkSmart Core is a standard HDMI-compliant device and has been tested to work with products like AMX DXLink HDMI transmitters and receivers.
Does ThinkSmart Core support Wi-Fi® connection?	A wired Ethernet connection is required for initial setup, and it is a MTR best practice to keep a hard-wired connection. Wi-Fi is supported by the hardware when logged in as Administrator, but it cannot be used for meeting calls.
Is ThinkSmart Core compatible with Apple OSX?	Yes. ThinkSmart Core is a device that runs Unified Communications software on a Windows operating system. Most UC software providers offer clients for Windows, Android, Apple OSX and iOS. The HDMI-in connector on ThinkSmart Core supports all the OS mentioned above.
Can I store my presentations or other materials in ThinkSmart Core for sharing?	No. All content sharing happens in real-time through client devices that are connected to ThinkSmart Core. It does not support storing any user data for sharing during meetings.
Does ThinkSmart Core support Consumer Electronics Control (CEC)?	Yes.

Question	Answer
What are the TCP/IP ports that must be opened in the infrastructure?	<p>For the basic default ports requirements, see “Network” on page 9.</p> <p>There may be other requirements based on your environment. Please see</p> <ul style="list-style-type: none"> • https://docs.microsoft.com/en-us/MicrosoftTeams/rooms/rooms-prep • https://docs.microsoft.com/en-us/microsoft-365/enterprise/urls-and-ip-address-ranges?redirectSourcePath=%252fen-us%252farticle%252fOffice-365-URLs-and-IP-address-ranges-8548a211-3fe7-47cb-abb1-355ea5aa88a2=o365-worldwide#BKMK_Identity
How does one configure the network proxy for ThinkSmart Core?	See the proxy configurations at https://docs.microsoft.com/en-us/microsoft-teams/proxy-servers-for-skype-for-business-online .
What is the list of supported peripherals like cameras, extended microphones or speakers?	<p>ThinkSmart Core supports MTR certified audio or video peripherals.</p> <p>For more information, see https://products.office.com/en-us/microsoft-teams/across-devices/devices.</p>
Does ThinkSmart Core support wireless display?	No.
Can I use ThinkSmart Core as a PC?	No. ThinkSmart Core is an appliance and is designed to be a meeting space-based tabletop conference room AV device.
Does ThinkSmart Core support deployment via SCCM?	Yes, For more information, see https://docs.microsoft.com/en-us/microsoftteams/room-systems/room-systems-scale .
What are the supported external cable diameters/types?	<p>We recommend HDMI/USB cables with an external nylon mesh sheathing because they have better grip and will stay securely in place.</p> <ul style="list-style-type: none"> • HDMI cable: 5 mm to 7.5 mm • USB cable: 3.5 mm to 6 mm • Power cable: 3.5 mm to 4.5 mm
What can I do if ThinkSmart Cam is lost during the meeting?	Disconnect it from ThinkSmart Core and reconnect it to ThinkSmart Core.

Chapter 9. Troubleshooting, diagnostics, and recovery

Basic procedure for resolving problems

Use the basic procedure as a starting point for resolving problems.

Prerequisite

Before you start, read “Read this first” on page i and print the following instructions.

1. Check that:
 - a. The cables for all connected devices are connected correctly and securely.
 - b. All components have been reassembled correctly.
 - c. All connected devices that require ac power are connected to properly grounded and working electrical outlets.
 - d. All connected devices are enabled in UEFI BIOS.
 2. See Chapter 9 “Troubleshooting, diagnostics, and recovery” on page 57 to resolve the problem you are experiencing, run the diagnostic program, and recover your operating system.
 3. If the problem persists, contact Lenovo. See Chapter 10 “Help and support” on page 67.
-

Troubleshooting

Use the troubleshooting information to find solutions to problems that have definite symptoms.

Startup and shutdown problems

Problem	Solution
The ThinkSmart Core does not start up after the power button is pressed.	<ul style="list-style-type: none">• Ensure that ThinkSmart Core is correctly connected to power through the accompanying power adapter and power cord.• Ensure that the ThinkSmart Core voltage matches the voltage available at the electrical outlet for your country or region.
The ThinkSmart Core cannot be shut down from the operating system.	Press and hold the power button on the ThinkSmart Core for at least four seconds to turn it off.

MTR problems

Problem	Solution
MTR cannot be logged in.	<ul style="list-style-type: none">• Ensure that the account and password are correct and valid.• Ensure that the ThinkSmart Core is connected to a wired network and is connected to your Office 365 account or your Skype for Business server (depends on your company's deployment).• If the ThinkSmart Core is connected to the Office 365 account, ensure that the account is not running in China.
The camera cannot be turned on in a meeting.	<ul style="list-style-type: none">• Ensure that the account has been granted the authority to use the camera.• Ensure that the camera can work in administrator account with "Camera" application.• Ensure that the camera is not configured as content camera.
The calendar is not displayed.	<ul style="list-style-type: none">• Ensure that the account has been granted the authority to receive meeting invitations automatically.• Check the calendar with Outlook or Office 365 Web site.

Display problems

Problem	Solution
Sometimes, the touch point is not very accurate on the Controller.	Please connect a keyboard and mouse to ThinkSmart Core for operations.
Sometimes, the on-screen keyboard is not popped out after touching the input box on the Controller.	Please connect a keyboard and mouse to ThinkSmart Core for operations.
Sometimes, the on-screen keyboard is not displayed accurately, such as: <ul style="list-style-type: none">• Keyboard not fully displayed• Keyboard letters not fully displayed	Please connect a keyboard and mouse to ThinkSmart Core for operations.
Sometimes, the display mode is duplicate mode after ThinkSmart Core enters the MTR account.	The display mode is extend mode by default under the MTR account. If it is duplicate mode, restart ThinkSmart Core.
Sometimes, the Controller has no display after connected to ThinkSmart Core during the process of claiming device to ThinkSmart Manager.	Disconnect the Controller and reconnect it to ThinkSmart Core. If the problem persists, you can do one of the following: <ul style="list-style-type: none">• Use your keyboard and mouse to perform operations.• Restart ThinkSmart Core.
Sometimes, the Controller is not the main screen and has no screen-rotation function after ThinkSmart Core is reset.	The auto setting of the Controller as the main screen and the auto screen rotation function are controlled by the Controller configuration application. To restore them, download and install the application from https://smartsupport.lenovo.com/ .

Problem	Solution
The Controller screen goes blank while ThinkSmart Core is on.	<ul style="list-style-type: none"> • Ensure that the Controller is connected to ThinkSmart Core correctly and securely. • Tap the Controller screen to wake up the ThinkSmart Core. • The brightness and contrast is set correctly. • ThinkSmart Core voltage matches the voltage available at the electrical outlet for your country or region.
The Controller screen image appears to be flickering.	<ul style="list-style-type: none"> • The Controller screen might be affected by interference from nearby equipment. Magnetic fields around other devices, such as transformers, appliances, fluorescent lights, and other displays, might be causing the problem. Move fluorescent desk lighting or any equipment that produces magnetic fields farther away from the screen. If the problem persists, turn off ThinkSmart Core. Keep other devices at least 305 mm (12 inches) away from ThinkSmart Core. Then, turn on ThinkSmart Core. • Reset the refresh rate. <ol style="list-style-type: none"> 1. Right-click a blank area on the desktop. 2. Click Display settings. On the Display tab, click Advanced display settings → Display adapter properties for Display 1. 3. Click the Monitor tab, and then reset the refresh rate to be the highest and non-interlaced.
The Controller screen image is discolored.	<ul style="list-style-type: none"> • The Controller screen might be affected by interference from nearby equipment. Move fluorescent desk lighting or any equipment that produces magnetic fields farther away from the screen. • Turn off ThinkSmart Core. Keep other devices at least 305 mm (12 inches) away from ThinkSmart Core. Then, turn on ThinkSmart Core.
An external display screen is blank after connected to ThinkSmart Core.	<ul style="list-style-type: none"> • Ensure that the display is connected to ThinkSmart Core correctly and securely. • Select HDMI signals in the signal source setting of the display. • Restart the display. • Change the HDMI cable.
The image on an external display is not clear.	<p>Reset the screen resolution.</p> <ul style="list-style-type: none"> • Right-click a blank area on the desktop. • Click Display settings. • Set the screen resolution to be 1920 x 1080 pixels.

Audio problems

Problem	Solution
ThinkSmart Bar is lost during the MTR meeting.	<ul style="list-style-type: none">• Ensure that it is correctly connected to power through the accompanying power adapter and power cord.• Ensure that it is turned on.• Disconnect it from ThinkSmart Core and reconnect it to ThinkSmart Core.• Ensure that it is set as the audio device for conferencing from MTR Settings.
The sound does not come from the headset or headphones connected to the Controller.	Select the headset or headphones as the default audio output device in advanced sound settings.

Network problems

Problem	Solution
ThinkSmart Core cannot connect to an Ethernet LAN.	<ul style="list-style-type: none">• Connect the cable from the Ethernet connector to the RJ45 connector of ThinkSmart Core.• Enable the Ethernet LAN feature in UEFI BIOS.• Enable the Ethernet LAN adapter.<ol style="list-style-type: none">1. Go to Control Panel and view by large icons or small icons.2. Click Network and Sharing Center → Change adapter settings.3. Right-click the Ethernet LAN adapter icon and click Enable.• Update or reinstall the Ethernet LAN driver.• Install all networking software that is necessary for your network environment. Check with your LAN administrator for the necessary networking software.• Set the same duplex for the switch port and the adapter. If you configured the adapter for full duplex, ensure that the switch port is also configured for full duplex. Setting a wrong duplex mode might degrade performance, cause data loss, or result in lost connections.
When a Gigabit Ethernet model ThinkSmart Core is used at a speed of 1000 Mbps, the Ethernet LAN connection fails or errors occur.	Connect the network cable to the Ethernet connector using Category 5 wiring and a 100 BASE-T hub/switch (not 100 BASE-X).
My ThinkSmart Core is a Gigabit Ethernet model, but it cannot be connected to the network at 1000 Mbps, but at only 100 Mbps.	<ul style="list-style-type: none">• Try another cable.• Set the link partner to auto-negotiate.• Set the switch to be 802.3ab-compliant (gigabit over copper).

Problem	Solution
The Wi-Fi feature does not work.	<p>It is not recommended that you connect to a Wi-Fi network. If you connect to the Wi-Fi network that needs account authentication, the connection will be lost when you log in the conference room system.</p> <p>Connect your ThinkSmart Core to a local network through the Ethernet connector on your ThinkSmart Core with an Ethernet cable.</p>
The Bluetooth feature does not work.	<p>Note: It is not recommended that you connect a Bluetooth-enabled device to ThinkSmart Core.</p> <ul style="list-style-type: none"> • Enable the Bluetooth feature in UEFI BIOS. • Enable all Bluetooth devices. <ol style="list-style-type: none"> 1. Right-click the Start button to open the Start context menu. 2. Click Device Manager. Type the administrator password or provide confirmation if prompted. 3. Expand Bluetooth to display all Bluetooth devices. Right-click each Bluetooth device, and then click Enable device. 4. Expand Network adapters to display all network devices. Right-click each Bluetooth device, and then click Enable device. • Turn on the Bluetooth radio. <ol style="list-style-type: none"> 1. Open the Start menu. 2. Click Settings → Devices → Bluetooth & other devices. 3. Turn on the Bluetooth switch to enable the Bluetooth feature. • Update or reinstall the Bluetooth driver.

Performance problems

Problem	Solution
The free storage drive space is insufficient.	<ul style="list-style-type: none"> • Clean out your Inbox, Sent Items, and Deleted Items folders from your e-mail application. • Clean up your C drive. <ol style="list-style-type: none"> 1. Open the Start menu. 2. Click Windows System → File Explorer → This PC. 3. Right-click your C drive and then click Properties. 4. Check the amount of free space, and then click Disk Cleanup. 5. A list of unnecessary file categories is displayed. Select the category you want to delete, and then click OK.

Drive problems

Problem	Solution
There is a warning icon besides XMOS Control under Other devices of Device Manager in the administrator account.	ThinkSmart Bar is an external device. Connect ThinkSmart Core to Internet to get the ThinkSmart Bar driver updated, then the warning icon will disappear.
"No Operating System Found" message or the system not starting up from the correct storage drive.	<ul style="list-style-type: none">• Ensure that all storage drives are connected correctly and securely.• Ensure that the storage drive ThinkSmart Core starts up from is listed as the first startup device in the UEFI BIOS. Refer to "Change the priority boot order" on page 50. <p>Note: In rare cases, the storage drive with the operating system might get corrupted or damaged. In such cases, you might need to replace the storage drive.</p>

USB device problems

Problem	Solution
A USB device cannot be accessed.	<ul style="list-style-type: none">• Connect the USB cable from the USB connector to the USB device. If the USB device has its own power cord, connect the power cord to a grounded electrical outlet.• Turn on the USB device and keep the device online.• Install any device drivers or programs supplied with the USB device. Refer to the documentation that comes with the USB device for more information.• Disconnect and reconnect the USB connector to reset the USB device.• Ensure that the Smart USB Protection function is disabled in UEFI BIOS.

Diagnostics

Use diagnostic solutions to test hardware components and report operating-system-controlled settings that interfere with the correct operation of your computer.

To use the Lenovo diagnostic:

1. Turn on or restart the computer.
2. Before Windows starts, repeatedly press and release the F10 key until the Lenovo diagnostic opens.

Note: If a BIOS password has been set, the UEFI BIOS will not open until you enter the correct password. For more information, see "UEFI BIOS passwords" on page 45.

3. Follow the instructions on the screen to use the diagnostic program.

Recovery

This section introduces the recovery information of the Windows operating system. Ensure that you read and follow the on-screen recovery instructions. The data on your computer might be deleted during the recovery process. To avoid data loss, make a backup copy of all the data that you want to keep.

Restore system files and settings to an earlier point

1. Go to **Control Panel** and view by large icons or small icons.
2. Click **Recovery** → **Open System Restore**. Then, follow the on-screen instructions.

Restore your files from a backup

Note: If you use the File History tool to restore your files from a backup, ensure that you backed up your data earlier with the tool.

1. Go to **Control Panel** and view by large icons or small icons.
2. Click **File History** → **Restore personal files**. Then, follow the on-screen instructions.

Reset from Windows

Note: The items in the graphical user interface (GUI) might change without notice.

1. Ensure that an external display is connected to the computer.
2. Open the **Start** menu, and then click **Settings** → **Update & Security** → **Recovery**.
3. In the **Reset this PC** section, click **Get started**.
4. Select **Remove everything**. Follow the on-screen instructions to reset your computer.

Notes:

- Reset option **Keep my files** is not supported.
- Please do not turn off or restart your computer during the reset.
- It is normal that the Controller will go blank for a while during the reset process.

Reset from BIOS

Note: The items in the graphical user interface (GUI) might change without notice.

1. Ensure that an external display is connected to the computer.
2. Ensure that a keyboard is connected to the computer.
3. Restart your computer. At the beginning of the boot process, keep pressing F11 on the keyboard until Windows recovery environment opens.
4. Select **Troubleshoot** → **Reset this PC** → **Remove everything**. Follow the on-screen instructions to reset your computer.

Notes:

- Reset option **Keep my files** is not supported.
- Please do not turn off or restart your computer during the reset.
- It is normal that the Controller will go blank for a while during the reset process.

Use advanced options

1. Open the **Start** menu, and then click **Settings** → **Update & security** → **Recovery**.
2. In the **Advanced startup** section, click **Restart now** → **Troubleshoot** → **Advanced options**.
3. Select a preferred option, and then follow the on-screen instructions.

Windows automatic recovery

Note: Ensure that your computer is connected to ac power during the recovery process.

The Windows recovery environment on your computer operates independently from the Windows operating system. It enables you to recover or repair the operating system even if the Windows operating system fails to start.

After two consecutive failed boot attempts, the Windows recovery environment starts automatically. Then, you can choose repair and recovery options by following the on-screen instructions.

Create and use a recovery USB device

It is recommended that you create a recovery USB drive as early as possible as a backup for the Windows recovery programs. With the recovery USB drive, you can troubleshoot and fix the problems even if the preinstalled Windows recovery programs are damaged. If you did not create a recovery USB drive as a precautionary measure, you can contact Lenovo Customer Support Center and purchase one from Lenovo. For a list of the Lenovo Support phone numbers for your country or region, go to:

<https://smartsupport.lenovo.com/supportphonenumberlist>

Create a recovery USB drive

Attention: The creation process deletes anything stored on the USB drive. To avoid data loss, make a backup copy of all the data that you want to keep.

1. Ensure that your computer is connected to ac power.
2. Prepare a USB drive with capacity of at least 16 GB. The actual USB capacity required depends on the size of the recovery image.
3. Connect the prepared USB drive to the computer.
4. Type `recovery` in the search box. Then, click **Create a recovery drive**.
5. Click **Yes** in the User Account Control window to allow the Recovery Media Creator program to start.
6. In the Recovery Drive window, follow the on-screen instructions to create a recovery USB drive.

Use the recovery USB drive

If your computer cannot be started, go to Chapter 10 “Help and support” on page 67 first to try to solve the problem by yourself. If the problem persists, use the recovery USB drive to recover your computer.

1. Ensure that your computer is connected to ac power.
2. Connect the recovery USB drive to the computer.
3. Turn on or restart the computer. When the logo screen is displayed, press F12. The Boot Menu window opens.
4. Select the recovery USB drive as the boot device. Then, follow the on-screen instructions to complete the process.

Update the device driver

Attention: Reinstalling device drivers will change the current configuration of the computer.

You should download the latest driver for a component when you notice poor performance from that component or when you added a component. This action might eliminate the driver as the potential cause of a problem. Download and install the latest driver by one of the following methods:

- From the Lenovo Support Web site:
 - Go to <https://smartsupport.lenovo.com/> and select the entry for your computer. Then, follow the on-screen instructions to download and install necessary drivers and software.
- From Windows Update:

Note: The device drivers provided by Windows Update might not be tested by Lenovo. It is recommended that you get device drivers from Lenovo.

1. Open the **Start** menu.
2. Click **Settings** → **Update & Security** → **Windows Update**.
3. Follow the on-screen instructions.

Chapter 10. Help and support

This chapter provides help and support information for your product.

Note: ThinkSmart Core is referred to as “Computer” in this chapter.

Register with Lenovo

To register with Lenovo, ensure that device is connected to the Internet. Then, go to <http://www.lenovo.com/register> and follow the instructions on the screen to enter the required information into Lenovo database.

The information enables Lenovo to contact you when there is a recall or other severe problem and provide quicker service when you call Lenovo for help. In addition, some locations offer extended privileges and services to registered users.

CRU replacement

Customer Replaceable Units (CRUs) are parts that can be upgraded or replaced by the customer. Lenovo computers contain the following types of CRUs:

- **Self-service CRUs:** Refer to parts that can be installed or replaced easily by customer themselves or by trained service technicians at an additional cost.
- **Optional-service CRUs:** Refer to parts that can be installed or replaced by customers with a greater skill level. Trained service technicians can also provide service to install or replace the parts under the type of warranty designated for the customer’s machine.

If you intend on installing the CRU, Lenovo will ship the CRU to you. CRU information and replacement instructions are shipped with your product and are available from Lenovo at any time upon request. You might be required to return the defective part that is replaced by the CRU. When return is required: (1) return instructions, a prepaid shipping label, and a container will be included with the replacement CRU; and (2) you might be charged for the replacement CRU if Lenovo does not receive the defective CRU within thirty (30) days of your receipt of the replacement CRU. For full details, see the Lenovo Limited Warranty documentation at:

https://www.lenovo.com/warranty/llw_02

Refer to the following CRU list for your computer.

Self-service CRUs

- Core 90 W power adapter and power cord
- Controller unit
- Soundbar unit*
- Soundbar 65 W power adapter and power cord*
- Soundbar cable (5 m)*
- Soundbar brackets and screws*
- Satellite microphones*
- Satellite microphones cables*
- Camera unit*
- Camera brackets and screws*

- Camera cable (5 m)*

* for selected models

See Chapter 3 “Hardware deployment” on page 11 to replace these CRUs.

Self-help resources

Use the following self-help resources to learn more about the product and troubleshoot problems.

Resources	How to access?
Product documentation: <ul style="list-style-type: none"> • Documentation in the box • This <i>Guide</i> • <i>Regulatory Notice</i> 	Go to https://smartsupport.lenovo.com/ . Then, follow the on-screen instructions to filter out the documentation you want.
Lenovo Support Web site with the latest support information of the following: <ul style="list-style-type: none"> • Drivers and software • Diagnostic solutions • Product and service warranty • Product and parts details • Knowledge base and frequently asked questions 	https://smartsupport.lenovo.com/
Windows help information	<ul style="list-style-type: none"> • Open the Start menu and click Get Help or Tips. • Use Windows Search or the Cortana® personal assistant. • Microsoft support Web site: https://support.microsoft.com
Accessibility information	https://www.lenovo.com/accessibility

Additional services

Thank you, Lenovo customer, for your purchase of a ThinkSmart Core kit.

During and after the warranty period, you can purchase additional services from Lenovo at: <https://pcsupport.lenovo.com/warrantyupgrade>. Service availability and service name might vary by country or region.

We expect you will have years of productive meeting experiences with our collaboration solution. To assist you in getting this collaboration solution installed in your environment, we have included two of our most popular ThinkSmart services: Deploy and Maintain.

Customer Action

You must register this service with Lenovo so a service technician can contact you to schedule initial deployment service:

<https://support.lenovo.com/us/en/professionalserviceregistration>

To register, please provide the contact information for the person we should engage with, along with purchase information (place and date of purchase along with sales order or invoice number).

Included Services

- **Deploy:** A ThinkSmart service to help setup, configure and integrate collaboration solution devices into your environment. All deployments include full documentation reports after complete.
- **Maintain:** A one-year (renewable) maintenance contract where technicians will assist with updates and device changes and provide easy to follow Do's and Don'ts. Device operability health check ins will ensure collaboration solution is healthy and running smoothly. Redeployment of solution, if required, into a different meeting space is included.

Note: These services are delivered virtually, with multi-lingual technicians available WW, ready to handle live support via video meeting, phone, email, or IM.

Call Lenovo

If you have tried to correct the problem yourself and still need help, you can call Lenovo Customer Support Center.

Before you contact Lenovo

Prepare the following before you contact Lenovo:

1. Record the problem symptoms and details:
 - What is the problem? Is it continuous or intermittent?
 - Any error message or error code?
 - What operating system are you using? Which version?
 - Which software applications were running at the time of the problem?
 - Can the problem be reproduced? If so, how?
2. Record the system information:
 - Product name
 - Machine type and serial number (on the bottom of the product)

Lenovo Customer Support Center

During the warranty period, you can call Lenovo Customer Support Center for help.

Telephone numbers

For a list of the Lenovo Support phone numbers for your country or region, go to:

<https://smartsupport.lenovo.com/supportphonenumberlist>

Note: Phone numbers are subject to change without notice. If the number for your country or region is not provided, contact your Lenovo reseller or Lenovo marketing representative.

Services available during the warranty period

- Problem determination - Trained personnel are available to assist you with determining if you have a hardware problem and deciding what action is necessary to fix the problem.
- Lenovo hardware repair - If the problem is determined to be caused by Lenovo hardware under warranty, trained service personnel are available to provide the applicable level of service.
- Engineering change management - Occasionally, there might be changes that are required after a product has been sold. Lenovo or your reseller, if authorized by Lenovo, will make selected Engineering Changes (ECs) that apply to your hardware available.

Services not covered

- Replacement or use of parts not manufactured for or by Lenovo or nonwarranted parts
- Identification of software problem sources
- Configuration of UEFI BIOS as part of an installation or upgrade
- Changes, modifications, or upgrades to device drivers
- Installation and maintenance of network operating systems (NOS)
- Installation and maintenance of programs

For the terms and conditions of the Lenovo Limited Warranty that apply to your Lenovo hardware product, see the Lenovo Limited Warranty documentation at:

https://www.lenovo.com/warranty/llw_02

The LLW also is preinstalled on ThinkSmart Core. To access the LLW, go to the following directory:

C:\Windows\System32\oobe\info\default

Appendix A. Specifications

Take ThinkSmart Core Full Room Kit 2 as example to show maximum configuration.

For more specifications, go to <https://smartfind.lenovo.com>.

ThinkSmart Cam

Dimensions	<ul style="list-style-type: none">• Width: 105 mm (4.1 inches)• Height: 36 mm (1.4 inches), 51.7 mm (2 inches) with clamp• Depth: 60.5 mm (2.4 inches)
Weight (without packaging)	Maximum configuration as shipped: 220 g (0.5 lb)

ThinkSmart Bar XL

Soundbar

Dimensions	<ul style="list-style-type: none">• Width: 798 mm (31.4 inches)• Height: 56.5 mm (2.2 inches)• Depth: 91.3 mm (3.6 inches)
Weight (without packaging)	Maximum configuration as shipped: 3.6 kg (7.9 lb)
Power supply	65-watt automatic voltage-sensing power supply

Satellite microphones

Dimensions	<ul style="list-style-type: none">• Width: 100 mm (3.9 inches)• Height: 20 mm (0.8 inches)
Weight (without packaging)	Maximum configuration as shipped: 220 g (0.5 lb)

ThinkSmart Controller and ThinkSmart Core

ThinkSmart Controller

Dimensions	<ul style="list-style-type: none">• Width: 265.5 mm (10.5 inches)• Height: 168.1 mm (6.6 inches)• Depth: 13 mm (0.5 inches) , 83.3 mm (3.3 inches) with the stand
Weight (without packaging)	Maximum configuration as shipped: 753.8 g (1.7 lb)

ThinkSmart Core

Dimensions	<ul style="list-style-type: none">• Width: 226 mm (8.9 inches)• Height: 37.5 mm (1.5 inches), 51.7 mm (2 inches) with the clamp unfolded• Depth: 200 mm (7.9 inches)
Weight (without packaging)	Maximum configuration as shipped: 1.1 kg (2.4 lb)
Hardware configuration	<ol style="list-style-type: none">1. Right-click Start to open the Start context menu.2. Click Device Manager.
Power supply	90-watt automatic voltage-sensing power supply
Electrical input	<ul style="list-style-type: none">• Input voltage: From 100 V ac to 240 V ac• Input frequency: 50/60 Hz
Microprocessor	To view the microprocessor information, right-click Start and then click System .
Storage device	M.2 solid-state drive
Network features	<ul style="list-style-type: none">• Ethernet LAN• Wireless LAN
Operating system	Windows
Preloaded Lenovo apps	ThinkSmart Manager
Preloaded 3rd party apps	Microsoft Teams Rooms

Operating environment

Maximum altitude (without pressurization)

- Operating: From -15.2 m (-50 ft) to 3048 m (10 000 ft)
- Storage: From -15.2 m (-50 ft) to 10 668 m (35 000 ft)

Temperature

- Operating: From 10°C (50°F) to 35°C (95°F)
- Storage in original shipping packaging: From -20°C (-4°F) to 60°C (140°F)
- Storage without packaging: From -10°C (14°F) to 60°C (140°F)

Note: If your product is stored or transported in temperatures less than 10°C (50°F), allow the product to rise slowly to an optimal operating temperature before use. This process might take up to two hours. Using the product in a lower operating temperature might result in irreparable damage to your product.

Relative humidity

- Operating: 20%-80% (non-condensing)
- Storage: 20%–90% (non-condensing)

Appendix B. Compliance information

This chapter provides radio frequency compliance statements, electromagnetic emission notices and environmental information about Lenovo products.

Certification-related information

Product name: ThinkSmart Core series

Machine types: 11LQ, 11LR, 11LS, 11LT, 11S2, 11S3, 11S4, 11S5, 11RV, 11RW, 11RX, 11RY, 11S0, 11S1, and 11S6

Further compliance information related to your product is available at <https://www.lenovo.com/compliance>.

Radio frequency compliance statements

Computer models equipped with wireless communications comply with the radio frequency and safety standards of any country or region in which it has been approved for wireless use.

Besides this document, ensure that you read the *Regulatory Notice* for your country or region before using the wireless devices contained in your computer. The *Regulatory Notice* contains specific regulatory information about these wireless devices. To access the latest *Regulatory Notice*, go to <https://support.lenovo.com>.

European Union (EU) / United Kingdom (UK) – Radio Equipment Compliance

Mark	Contact
------	---------



EU Contact: Lenovo (Slovakia), Landererova 12, 811 09 Bratislava, Slovakia



UK contact: Lenovo, Redwood, Crockford Lane, Basingstoke, RG24 8WQ, UK.

This product is in conformity with all the requirements and essential norms that apply to EU Council Radio Equipment Directive 2014/53/EU on the approximation of the laws of the Member States, as well as the UK Radio Equipment Regulations SI 2017 No. 1206, relating to radio equipment.

The full text of the system EU declaration of conformity is available at:
<https://www.lenovo.com/us/en/compliance/eu-doc>

The full text of the system UK declaration of conformity is available at:
<https://www.lenovo.com/us/en/compliance/uk-doc>

Lenovo cannot accept responsibility for any failure to satisfy the protection requirements resulting from a non-recommended modification of the product, including the installation of option cards from other manufacturers. This product has been tested and found to comply with the limits for Class B equipment

according to European and UK compliance standards. The limits for Class B equipment were derived for typical residential environments to provide reasonable protection against interference with certified communication devices.

RF exposure information

This device meets the EU / UK requirements, and the International Commission on Non-Ionizing Radiation Protection (ICNIRP) guidelines for general public's exposure to electromagnetic fields.

To limit RF exposure, and to comply with the RF exposure requirements (SAR, Specific Absorption Rate), use this device under good radio signal conditions, and maintain the correct user distance from the wireless antennas. Refer to your *User Guide* for the wireless antenna locations.

- For devices where the location of the wireless antennas is close to the user's body (< 20 cm), the specific SAR values and statement are provided in the documentation that came with your device.
- For devices where the location of the wireless antennas is > 20 cm from the user, there is not a specific SAR value and the device must be operated at a minimum separation distance of 20 cm from the user's body.

Brazil

Este equipamento não tem direito à proteção contra interferência prejudicial e não pode causar interferência em sistemas devidamente autorizados.

This equipment is not protected against harmful interference and may not cause interference with duly authorized systems.

Mexico

Advertencia: En Mexico la operación de este equipo está sujeta a las siguientes dos condiciones: (1) es posible que este equipo o dispositivo no cause interferencia perjudicial y (2) este equipo o dispositivo debe aceptar cualquier interferencia, incluyendo la que pueda causar su operación no deseada.

Singapore

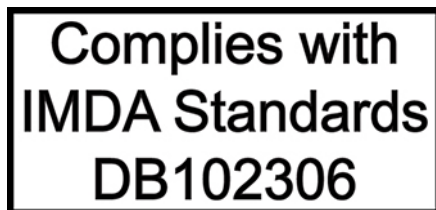

Korea

무선설비 전파 혼신 (사용주파수 2400 ~ 2483.5 , 5725 ~ 5825 무선제품해당)

해당 무선설비가 전파혼신 가능성이 있으므로 인명안전과 관련된 서비스는 할 수 없음

SAR 정보

본 장치는 전파 노출에 대한 가이드라인을 충족합니다.

본 장치는 무선 송수신기입니다. 본 장치는 국제 가이드라인으로 권장되는 전파 노출에 대한 제한을 초과하지 않도록 설계되었습니다. 장치 액세서리 및 최신 부품을 사용할 경우 SAR 값이 달라질 수 있습니다. SAR 값은

국가 보고 및 테스트 요구 사항과 네트워크 대역에 따라 다를 수 있습니다. 본 장치는 사람의 신체에서 20mm 이상의 거리에서 사용할 수 있습니다.

Electromagnetic emission notices

Federal Communications Commission (FCC) Supplier's Declaration of Conformity

Notes:

- The statements below regarding FCC are only valid for products that are shipping to the United States.
- Refer to the product label information to identify the specific model name and number of your product.

This equipment has been tested and found to comply with the limits for a Class B digital device, pursuant to Part 15 of the FCC Rules. These limits are designed to provide reasonable protection against harmful interference in a residential installation. This equipment generates, uses, and can radiate radio frequency energy and, if not installed and used in accordance with the instructions, may cause harmful interference to radio communications. However, there is no guarantee that interference will not occur in a particular installation. If this equipment does cause harmful interference to radio or television reception, which can be determined by turning the equipment off and on, the user is encouraged to try to correct the interference by one or more of the following measures:

- Reorient or relocate the receiving antenna.
- Increase the separation between the equipment and receiver.
- Connect the equipment into an outlet on a circuit different from that to which the receiver is connected.
- Consult an authorized dealer or service representative for help.

Lenovo is not responsible for any radio or television interference caused by using other than recommended cables and connectors or by unauthorized changes or modifications to this equipment. Unauthorized changes or modifications could void the user's authority to operate the equipment.

This device complies with Part 15 of the FCC Rules. Operation is subject to the following two conditions: (1) this device may not cause harmful interference, and (2) this device must accept any interference received, including interference that may cause undesired operation.

Responsible Party:
Lenovo (United States) Incorporated
7001 Development Drive
Morrisville, NC 27560
Email: FCC@lenovo.com



Industry Canada compliance statement

CAN ICES-003(B)/NMB-003(B)

European Union (EU) / United Kingdom (UK) – Electromagnetic Compatibility Compliance

This product is in conformity with the protection requirements of EU Council Directive 2014/30/EU on the approximation of the laws of the Member States, as well as UK SI 2016 No. 1091 with amendments, relating

to the electromagnetic compatibility limits for Class B equipment. These Class B requirements are intended to offer adequate protection to broadcast services within residential environments.

German Class B compliance statement

Hinweis zur Einhaltung der Klasse B zur elektromagnetischen Verträglichkeit

Dieses Produkt entspricht den Schutzanforderungen der EU-Richtlinie zur elektromagnetischen Verträglichkeit Angleichung der Rechtsvorschriften über die elektromagnetische Verträglichkeit in den EU-Mitgliedsstaaten und hält die Grenzwerte der Klasse B der Norm gemäß Richtlinie.

Um dieses sicherzustellen, sind die Geräte wie in den Handbüchern beschrieben zu installieren und zu betreiben. Des Weiteren dürfen auch nur von der Lenovo empfohlene Kabel angeschlossen werden. Lenovo übernimmt keine Verantwortung für die Einhaltung der Schutzanforderungen, wenn das Produkt ohne Zustimmung der Lenovo verändert bzw. wenn Erweiterungskomponenten von Fremdherstellern ohne Empfehlung der Lenovo gesteckt/eingebaut werden.

Zulassungsbescheinigung laut dem Deutschen Gesetz über die elektromagnetische Verträglichkeit von Betriebsmitteln, EMVG vom 20. Juli 2007 (früher Gesetz über die elektromagnetische Verträglichkeit von Geräten), bzw. der EU Richtlinie 2014/30/EU, der EU Richtlinie 2014/53/EU Artikel 3.1b), für Geräte der Klasse B.

Dieses Gerät ist berechtigt, in Übereinstimmung mit dem Deutschen EMVG das EG-Konformitätszeichen - CE - zu führen. Verantwortlich für die Konformitätserklärung nach Paragraf 5 des EMVG ist die Lenovo (Deutschland) GmbH, Meitnerstr. 9, D-70563 Stuttgart.

Japan VCCI Class B compliance statement

この装置は、クラスB機器です。この装置は、住宅環境で使用することを目的としていますが、この装置がラジオやテレビジョン受信機に近接して使用されると、受信障害を引き起こすことがあります。
取扱説明書に従って正しい取り扱いをして下さい。

VCCI-B

Japan compliance statement for products which connect to the power mains with rated current less than or equal to 20 A per phase

日本の定格電流が 20A/相 以下の機器に対する高調波電流規制
高調波電流規格 JIS C 61000-3-2 適合品

Japan notice for ac power cord

The ac power cord shipped with your product can be used only for this specific product. Do not use the ac power cord for other devices.

本製品およびオプションに電源コード・セットが付属する場合は、それぞれ専用のものになっていますので他の電気機器には使用しないでください。

Korea Communications Commission (KCC) statement

A 급 기기 사용자 안내문(업무용 방송통신기자재)^ㄹ
이 기기는 업무용 환경에서 사용할 목적으로 적합성평가를 받은
기기로서 가정용 환경에서 사용하는 경우 전파간섭의 우려가
있습니다^ㄹ

This is electromagnetic wave compatibility equipment for business (Type A). Sellers and users need to pay attention to it. This is for any areas other than home.

Environmental information

This section provides environmental, recycling, and RoHS information of countries and regions about Lenovo products.

Recycling and environmental information

Lenovo encourages owners of information technology (IT) equipment to responsibly recycle their equipment when it is no longer needed. Lenovo offers a variety of programs and services to assist equipment owners in recycling their IT products. For information about recycling Lenovo products, go to:

<https://www.lenovo.com/recycling>

The latest environmental information about our products is available at:

<https://www.lenovo.com/ecodeclaration>

Important battery recycling and WEEE information

Take back and recycling information for WEEE and batteries/accumulators in the European Union and the United Kingdom



The crossed-out wheeled bin marking applies only to countries with WEEE and batteries waste regulations including the European Union (EU), and United Kingdom (UK).

Appliances and batteries/accumulators are labeled in accordance with local regulations concerning waste electrical and electronic equipment (WEEE) and waste batteries and waste accumulators. These regulations determine the framework for the return and recycling of used appliances and used batteries/accumulators as applicable within each geography. This label is applied to various products to indicate that the product is not to be thrown away, but rather put in the established collection systems for reclaiming these end of life products.

The label on the battery may also include a chemical symbol for the metal concerned in the battery (Pb for lead, Hg for mercury, and Cd for cadmium).

Users of electrical and electronic equipment (EEE) and users of batteries/accumulators with the crossed-out wheeled bin marking must not dispose of end of life products as unsorted municipal waste, but use the collection framework available to them for the return, recycle, and recovery of WEEE and waste batteries/accumulators and to minimize any potential effects of EEE and batteries on the environment and human health due to the presence of hazardous substances.

Lenovo electrical and electronic equipment (EEE) may contain parts and components, which at end-of-life might qualify as hazardous waste.

EEE and waste electrical and electronic equipment (WEEE) can be delivered free of charge to the place of sale or any distributor that sells electrical and electronic equipment of the same nature and function as the used EEE or WEEE.

Before placing electrical and electronic equipment (EEE) in the waste collection stream or in waste collection facilities, the end user of equipment containing batteries and/or accumulators must remove those batteries and accumulators for separate collection.

Dispose of lithium batteries and battery packs from Lenovo products:

A coin-cell type lithium battery might be installed inside your Lenovo product. You can find details about the battery in the product documentation. If the battery needs to be replaced, contact your place of purchase or contact Lenovo for service. If you need to dispose of a lithium battery, insulate it with vinyl tape, contact your place of purchase or a waste-disposal operator, and follow their instructions.

Your Lenovo device might contain a lithium-ion battery pack or a nickel metal hydride battery pack. You can find details on the battery pack in the product documentation. If you need to dispose of a battery pack, insulate it with vinyl tape, contact Lenovo sales, service, or your place of purchase, or a waste-disposal operator, and follow their instructions. You also can refer to the instructions provided in the user guide for your product.

For proper collection and treatment, go to:

<https://www.lenovo.com/environment>

For additional WEEE information, go to:

<https://www.lenovo.com/recycling>

WEEE information for Hungary

Lenovo, as a producer, bears the cost incurred in connection with the fulfillment of Lenovo's obligations under Hungary Law No. 197/2014 (VIII.1.) subsections (1)-(5) of section 12.

EU ErP (EcoDesign) Directive (2009/125/EC) - external power adapters (Regulation (EU) 2019/1782), Ecodesign for Energy-Related Products Regulations 2010 - UK SI 2010 No. 2617 (Ext PSU), SI 2020 No. 485 (Ntwk Standby), SI 2014 No. 1290 as amended

Lenovo products are compliant with the EU EcoDesign (ErP) Directive and UK EcoDesign for Energy-related Products Regulations. Refer to the following for details. For EU, refer to the system declaration <https://www.lenovo.com/us/en/compliance/eu-doc>, and for UK refer to the system declaration <https://www.lenovo.com/us/en/compliance/uk-doc>.

Japan recycling statements

Collect and recycle a disused Lenovo computer or monitor

If you are a company employee and need to dispose of a Lenovo computer or monitor that is the property of the company, you must do so in accordance with the Law for Promotion of Effective Utilization of Resources. Computers and monitors are categorized as industrial waste and should be properly disposed of by an industrial waste disposal contractor certified by a local government. In accordance with the Law for Promotion of Effective Utilization of Resources, Lenovo Japan provides, through its PC Collecting and Recycling Services, for the collecting, reuse, and recycling of disused computers and monitors. For details, visit the Lenovo Web site at:

https://www.lenovo.com/us/en/social_responsibility/sustainability/ptb_japan

Pursuant to the Law for Promotion of Effective Utilization of Resources, the collecting and recycling of home-used computers and monitors by the manufacturer was begun on October 1, 2003. This service is provided free of charge for home-used computers sold after October 1, 2003. For details, go to:

https://www.lenovo.com/us/en/social_responsibility/sustainability/ptb_japan

Dispose of Lenovo computer components

Some Lenovo computer products sold in Japan may have components that contain heavy metals or other environmental sensitive substances. To properly dispose of disused components, such as a printed circuit board or drive, use the methods described above for collecting and recycling a disused computer or monitor.

Dispose of disused lithium batteries from Lenovo computers

A button-shaped lithium battery is installed inside your Lenovo computer to provide power to the computer clock while the computer is off or disconnected from the main power source. If you need to replace it with a new one, contact your place of purchase or contact Lenovo for service. If you need to dispose of a disused lithium battery, insulate it with vinyl tape, contact your place of purchase or an industrial-waste-disposal operator, and follow their instructions.

Disposal of a lithium battery must comply with local ordinances and regulations.

Recycling information for Brazil

Declarações de Reciclagem no Brasil

Descarte de um Produto Lenovo Fora de Uso

Equipamentos elétricos e eletrônicos não devem ser descartados em lixo comum, mas enviados à pontos de coleta, autorizados pelo fabricante do produto para que sejam encaminhados e processados por empresas especializadas no manuseio de resíduos industriais, devidamente certificadas pelos órgãos ambientais, de acordo com a legislação local.

A Lenovo possui um canal específico para auxiliá-lo no descarte desses produtos. Caso você possua um produto Lenovo em situação de descarte, ligue para o nosso SAC ou encaminhe um e-mail para: reciclar@lenovo.com, informando o modelo, número de série e cidade, a fim de enviarmos as instruções para o correto descarte do seu produto Lenovo.

Recycling information for mainland China

《废弃电器电子产品回收处理管理条例》提示性说明

联想鼓励拥有联想品牌产品的用户当不再需要此类产品时，遵守国家废弃电器电子产品回收处理相关法律法规，将其交给当地具有国家认可的回收处理资质的厂商进行回收处理。更多回收服务信息，请点击进入<http://support.lenovo.com.cn/activity/551.htm>

Restriction of Hazardous Substances (RoHS) Directive of countries and regions

The latest environmental information about Lenovo products is available at:
<https://www.lenovo.com/us/en/compliance/eco-declaration>

European Union (EU) / United Kingdom (UK) RoHS

This Lenovo product, with included parts (cables, cords, and so on) meets the requirements of EU Directive 2011/65/EU (as amended by Directive 2015/863/EU) and UK SI 2012 No. 3032 on the restriction of the use of certain hazardous substances in electrical and electronic equipment ("RoHS recast" or "RoHS 2").

For more information about Lenovo worldwide compliance on RoHS, go to:

<https://www.lenovo.com/rohs-communication>

Turkish WEEE / RoHS

Turkish WEEE/RoHS

Türkiye AEEE yönetmeliğine Uygunluk Beyanı

Bu Lenovo ürünü, T.C. Çevre ve Şehircilik Bakanlığı'nın „Atık Elektrikli ve Elektronik Eşyaların Kontrolü Yönetmeliğine (AEEE)" uygundur.

AEEE yönetmeliğine Uygundur.

Ukraine RoHS

Цим підтверджуємо, що продукція Леново відповідає вимогам нормативних актів України, які обмежують вміст небезпечних речовин

India RoHS

RoHS compliant as per E-Waste (Management) Rules.

Mainland China RoHS

产品中有害物质的名称及含量

部件名称	有害物质					
	铅(Pb)	汞(Hg)	镉(Cd)	六价铬 (Cr(VI))	多溴联苯 (PBB)	多溴二苯醚 (PBDE)
印刷电路板组件*	X	O	O	O	O	O
硬盘	X	O	O	O	O	O
光驱	X	O	O	O	O	O
内存	X	O	O	O	O	O
电脑I/O 附件	X	O	O	O	O	O
电源	X	O	O	O	O	O
键盘	X	O	O	O	O	O
鼠标	X	O	O	O	O	O
机箱/ 附件	X	O	O	O	O	O
液晶面板	X	O	O	O	O	O
电池	X	O	O	O	O	O

本表格依据 SJ/T 11364 的规定编制。
O: 表示该有害物质在该部件所有均质材料中的含量均在 GB/T 26572 规定的限量要求以下。
X: 表示该有害物质至少在该部件的某一均质材料中的含量超出 GB/T 26572 规定的限量要求。
注: 表中标记“X”的部件, 皆因全球技术发展水平限制而无法实现有害物质的替代。
印刷电路板组件*: 包括印刷电路板及其零部件、电容和连接器。
根据型号的不同, 可能不会含有以上所有部件, 请以实际购买机型为准。



在中华人民共和国境内销售的电子信息产品必须标识此标志, 标志内的数字代表在正常使用状态下的产品的环保使用期限。

中国大陆 RoHS 合格评定制度标识

依照《电器电子产品有害物质限制使用合格评定制度实施安排》，《绿色产品标识使用管理办法》以及市场监管总局关于明确电器电子产品有害物质限制使用合格评定制度“供方符合性标志”的公告中对于合格评定标识的相关要求，联想公司针对纳入《电器电子产品有害物质限制使用达标管理目录》内的产品，使用自我声明的合格评定方式，并使用如下合格评定标识：



Taiwan RoHS

單元	限用物質及其化學符號					
	鉛 (Pb)	汞 (Hg)	鎘 (Cd)	六價鉻 (Cr ⁺⁶)	多溴聯苯 (PBB)	多溴二苯醚 (PBDE)
印刷電路板 及電子組件	-	○	○	○	○	○
外殼	-	○	○	○	○	○
鏡頭	-	○	○	○	○	○
網線	-	○	○	○	○	○
托架	-	○	○	○	○	○

備考 1. “超出 0.1 wt %” 及 “超出 0.01 wt %” 係指限用物質之百分比含量超出百分比含量基準值。
備考 2. “○” 係指該項限用物質之百分比含量未超出百分比含量基準值。
備考 3. “-” 係指該項限用物質為排除項目。

Battery recycling information for Taiwan



廢電池請回收

Other compliance information

This section provides other compliance information of countries and regions about Lenovo products.

Export classification notice

This product is subject to the United States Export Administration Regulations (EAR) and has an Export Classification Control Number (ECCN) of 5A992.c. It can be re-exported except to any of the embargoed countries in the EAR E1 country list.

Lenovo product service information for Taiwan

委製商/進口商名稱: 荷蘭商聯想股份有限公司台灣分公司
進口商地址: 臺北市中山區樂群三路128號16樓
進口商電話: 0800-000-702 (代表號)

Taiwan precautionary vision statement

警語：使用過度恐傷害視力

注意事項：

- 使用30分鐘請休息10分鐘。
- 未滿2歲幼兒不看螢幕，2歲以上每天看螢幕不要超過1小時。

Supplemental information for the Eurasian Union (for selected models)

- **Назначение** : персональный компьютер для личного и служебного использования, для передачи данных, с поддержкой различных профилей подключения (Wi-Fi, Bluetooth и пр.).
- **Изготовитель** : Леново ПЦ ХК Лимитед, 23/Ф Линколн Хаус, Тайку Плэйс 979 Кингз Роуд, Куарри Бэй, Гонконг (Lenovo PC HK Limited, 23/F Lincoln House, Taikoo Place 979 King's Road, Quarry Bay, Hong Kong)
- **Страна производства** : Китай
- **Наименование и местонахождение уполномоченного изготовителем лица** : ООО «Леново (Восточная Европа/Азия)» 143401, Московская область, г. Красногорск, бульвар Строителей, дом 4, корпус 1, помещение VII, тел. +7 495 645 83 38, факс +7 495 645 78 77.
- **Импортер** : Наименование, адрес импортера и информация для связи с ним указаны на этикетке* на упаковке продукции.
**Согласно ГОСТ 2.601-2013 «Единая система конструкторской документации. Эксплуатационные документы», пункт 5.1, подпункт 5.1.2, этикетка является видом эксплуатационных документов.*
- **Дата изготовления (месяц и год)** : Указана на этикетке* на упаковке продукции, в графе Date (дата указана в формате год-месяц-дата). Для получения более подробной информации посетите веб-сайт: <https://support.lenovo.com>

- **Единый знак обращения на рынке стран Таможенного союза** :



Brazil audio notice

Ouvir sons com mais de 85 decibéis por longos períodos pode provocar danos ao sistema auditivo.

Appendix C. Notices and trademarks

Notices

Lenovo may not offer the products, services, or features discussed in this document in all countries. Consult your local Lenovo representative for information on the products and services currently available in your area. Any reference to a Lenovo product, program, or service is not intended to state or imply that only that Lenovo product, program, or service may be used. Any functionally equivalent product, program, or service that does not infringe any Lenovo intellectual property right may be used instead. However, it is the user's responsibility to evaluate and verify the operation of any other product, program, or service.

Lenovo may have patents or pending patent programs covering subject matter described in this document. The furnishing of this document does not give you any license to these patents. You can send license inquiries, in writing, to:

*Lenovo (United States), Inc.
8001 Development Drive
Morrisville, NC 27560
U.S.A.
Attention: Lenovo Director of Licensing*

LENOVO PROVIDES THIS PUBLICATION "AS IS" WITHOUT WARRANTY OF ANY KIND, EITHER EXPRESS OR IMPLIED, INCLUDING, BUT NOT LIMITED TO, THE IMPLIED WARRANTIES OF NON-INFRINGEMENT, MERCHANTABILITY OR FITNESS FOR A PARTICULAR PURPOSE. Some jurisdictions do not allow disclaimer of express or implied warranties in certain transactions, therefore, this statement may not apply to you.

Changes are made periodically to the information herein; these changes will be incorporated in new editions of the publication. To provide better service, Lenovo reserves the right to improve and/or modify the products and software programs described in the manuals included with your computer, and the content of the manual, at any time without additional notice.

The software interface and function and hardware configuration described in the manuals included with your computer might not match exactly the actual configuration of the computer that you purchase. For the configuration of the product, refer to the related contract (if any) or product packing list, or consult the distributor for the product sales. Lenovo may use or distribute any of the information you supply in any way it believes appropriate without incurring any obligation to you.

The products described in this document are not intended for use in implantation or other life support applications where malfunction may result in injury or death to persons. The information contained in this document does not affect or change Lenovo product specifications or warranties. Nothing in this document shall operate as an express or implied license or indemnity under the intellectual property rights of Lenovo or third parties. All information contained in this document was obtained in specific environments and is presented as an illustration. The result obtained in other operating environments may vary.

Lenovo may use or distribute any of the information you supply in any way it believes appropriate without incurring any obligation to you.

Any references in this publication to non-Lenovo Web sites are provided for convenience only and do not in any manner serve as an endorsement of those Web sites. The materials at those Web sites are not part of the materials for this Lenovo product, and use of those Web sites is at your own risk.

Any performance data contained herein was determined in a controlled environment. Therefore, the result obtained in other operating environments may vary significantly. Some measurements may have been made on development-level systems and there is no guarantee that these measurements will be the same on generally available systems. Furthermore, some measurements may have been estimated through extrapolation. Actual results may vary. Users of this document should verify the applicable data for their specific environment.

This document is copyrighted by Lenovo and is not covered by any open source license, including any Linux agreement(s) which may accompany software included with this product. Lenovo may update this document at any time without notice.

For the latest information or any questions or comments, contact or visit the Lenovo Web site:
<https://smartsupport.lenovo.com/>

Trademarks

LENOVO, LENOVO logo, THINKSMART, and THINKSMART logo are trademarks of Lenovo. Intel, Thunderbolt is a trademark of Intel Corporation or its subsidiaries in the U.S. and/or other countries. Microsoft, Windows, and Cortana are trademarks of the Microsoft group of companies. The terms HDMI and HDMI High-Definition Multimedia Interface are trademarks or registered trademarks of HDMI Licensing LLC in the United States and other countries. Wi-Fi is a registered trademark of Wi-Fi Alliance. USB-C is a registered trademark of USB Implementers Forum. All other trademarks are the property of their respective owners.

Lenovo