

OptiPlex 7480 All-In-One

Service Manual



Notes, cautions, and warnings

 **NOTE:** A NOTE indicates important information that helps you make better use of your product.

 **CAUTION:** A CAUTION indicates either potential damage to hardware or loss of data and tells you how to avoid the problem.

 **WARNING:** A WARNING indicates a potential for property damage, personal injury, or death.

Chapter 1: Safety instructions.....	6
Before working inside your computer.....	6
Before you begin	6
Electrostatic discharge—ESD protection.....	7
ESD field service kit	7
Transporting sensitive components.....	8
After working inside your computer.....	9
Chapter 2: Removing and installing components.....	10
Recommended tools.....	10
Screw list.....	10
Stand.....	12
Removing the fixed stand.....	12
Installing the fixed stand.....	13
Removing the articulating stand.....	14
Installing the articulating stand.....	16
Removing the height adjustable stand.....	17
Installing the height adjustable stand.....	18
Cable cover—optional.....	19
Removing the cable cover.....	19
Installing the cable cover.....	21
Back cover.....	22
Removing the back cover.....	22
Installing the back cover.....	24
Hard drive.....	25
Removing the hard drive.....	25
Installing the hard drive.....	26
Memory modules.....	27
Removing the memory modules.....	27
Installing the memory modules.....	28
System-board shield.....	29
Removing the system-board shield.....	29
Installing the system-board shield.....	30
Solid-state drive.....	31
Removing the M.2 2230 solid-state drive.....	31
Installing the M.2 2230 solid-state drive.....	32
Removing the M.2 2280 solid-state drive/Intel Optane memory module.....	33
Installing the M.2 2280 solid-state drive/Intel Optane memory module.....	34
System fan.....	35
Removing the system fan.....	35
Installing the system fan.....	36
Coin-cell battery.....	37
Removing the coin-cell battery.....	37
Installing the coin-cell battery.....	38

Wireless card.....	39
Removing the wireless card.....	39
Installing the wireless card.....	40
Camera assembly.....	42
Removing the camera assembly.....	42
Installing the camera assembly.....	43
Bottom cover.....	44
Removing the bottom cover.....	44
Installing the bottom cover.....	45
Power-supply unit.....	46
Removing the power-supply unit (PSU).....	46
Installing the power-supply unit (PSU).....	48
Power-supply fan.....	50
Removing the PSU fan.....	50
Installing the PSU fan.....	51
Heat sink.....	52
Removing the heat sink—UMA.....	52
Installing the heat sink—UMA.....	53
Removing the heat sink—discrete.....	54
Installing the heat sink—discrete.....	55
Processor.....	56
Removing the processor.....	56
Installing the processor.....	57
Rear-I/O bracket.....	59
Removing the rear-I/O bracket.....	59
Installing the rear-I/O bracket.....	60
System board.....	62
Removing the system board.....	62
Installing the system board.....	66
Speakers.....	69
Removing the speakers.....	69
Installing the speakers.....	70
Power-button board.....	72
Removing the power-button board.....	72
Installing the power-button board.....	72
Microphones.....	73
Removing the microphones.....	73
Installing the microphones.....	74
Side I/O-board.....	75
Removing the side-I/O board.....	75
Installing the side-I/O board.....	77
Audio board.....	78
Removing the audio board.....	78
Installing the audio board.....	79
Antennas.....	80
Removing the antenna modules.....	80
Installing the antenna modules.....	81
Display panel.....	82
Removing the display panel.....	82
Installing the display panel.....	83

Middle frame.....	85
Removing the middle frame.....	85
Installing the middle frame.....	87
Chapter 3: Software.....	89
Operating system.....	89
Downloading the drivers.....	89
Chapter 4: System setup.....	90
BIOS overview.....	90
Entering BIOS setup program.....	90
Navigation keys.....	90
Boot Sequence.....	90
System setup options.....	91
System and setup password.....	97
Assigning a system setup password.....	98
Deleting or changing an existing system setup password.....	98
Chapter 5: Troubleshooting.....	99
Dell SupportAssist Pre-boot System Performance Check diagnostics.....	99
Running the SupportAssist Pre-Boot System Performance Check.....	99
Display built-in self test.....	100
Diagnostics.....	100
Recovering the operating system.....	101
Flashing BIOS (USB key).....	101
Flashing the BIOS.....	102
WiFi power cycle.....	102
Flea power release.....	102
Chapter 6: Getting help and contacting Dell.....	104

Safety instructions

Use the following safety guidelines to protect your computer from potential damage and to ensure your personal safety. Unless otherwise noted, each procedure included in this document assumes that you have read the safety information that shipped with your computer.

NOTE: Before working inside your computer, read the safety information that shipped with your computer. For more safety best practices, see the Regulatory Compliance home page at www.dell.com/regulatory_compliance.

NOTE: Disconnect all power sources before opening the computer cover or panels. After you finish working inside the computer, replace all covers, panels, and screws before connecting to the electrical outlet.

CAUTION: To avoid damaging the computer, ensure that the work surface is flat and clean.

CAUTION: Handle components and cards with care. Do not touch the components or contacts on a card. Hold a card by its edges or by its metal mounting bracket. Hold a component such as a processor by its edges, not by its pins.

CAUTION: You should only perform troubleshooting and repairs as authorized or directed by the Dell technical assistance team. Damage due to servicing that is not authorized by Dell is not covered by your warranty. See the safety instructions that shipped with the product or at www.dell.com/regulatory_compliance.

CAUTION: Before touching anything inside your computer, ground yourself by using a wrist grounding strap or by periodically touching an unpainted metal surface, such as the metal at the back of the computer. While you work, periodically touch an unpainted metal surface to dissipate static electricity, which could harm internal components.

CAUTION: When you disconnect a cable, pull on its connector or on its pull tab, not on the cable itself. Some cables have connectors with locking tabs or thumb-screws that you must disengage before disconnecting the cable. When disconnecting cables, keep them evenly aligned to avoid bending any connector pins. When connecting cables, ensure that the ports and connectors are correctly oriented and aligned.

CAUTION: Press and eject any installed card from the media-card reader.

NOTE: The color of your computer and certain components may appear differently than shown in this document.

Topics:

- [Before working inside your computer](#)
- [Electrostatic discharge—ESD protection](#)
- [ESD field service kit](#)
- [Transporting sensitive components](#)
- [After working inside your computer](#)

Before working inside your computer

NOTE: The images in this document may differ from your computer depending on the configuration you ordered.

Before you begin

Steps

1. Save and close all open files and exit all open applications.

2. Shut down your computer. Click **Start > Power > Shut down**.

 **NOTE:** If you are using a different operating system, see the documentation of your operating system for shut-down instructions.

3. Disconnect your computer and all attached devices from their electrical outlets.
4. Disconnect all attached network devices and peripherals, such as keyboard, mouse, and monitor from your computer.
5. Remove any media card and optical disc from your computer, if applicable.
6. After the computer is unplugged, press and hold the power button for 5 seconds to ground the system board.

 **CAUTION:** Place the computer on a flat, soft, and clean surface to avoid scratches on the display.

7. Place the computer face down.

Electrostatic discharge—ESD protection

ESD is a major concern when you handle electronic components, especially sensitive components such as expansion cards, processors, memory DIMMs, and system boards. Very slight charges can damage circuits in ways that may not be obvious, such as intermittent problems or a shortened product life span. As the industry pushes for lower power requirements and increased density, ESD protection is an increasing concern.

Due to the increased density of semiconductors used in recent Dell products, the sensitivity to static damage is now higher than in previous Dell products. For this reason, some previously approved methods of handling parts are no longer applicable.

Two recognized types of ESD damage are catastrophic and intermittent failures.

- **Catastrophic** – Catastrophic failures represent approximately 20 percent of ESD-related failures. The damage causes an immediate and complete loss of device functionality. An example of catastrophic failure is a memory DIMM that has received a static shock and immediately generates a "No POST/No Video" symptom with a beep code emitted for missing or nonfunctional memory.
- **Intermittent** – Intermittent failures represent approximately 80 percent of ESD-related failures. The high rate of intermittent failures means that most of the time when damage occurs, it is not immediately recognizable. The DIMM receives a static shock, but the tracing is merely weakened and does not immediately produce outward symptoms related to the damage. The weakened trace may take weeks or months to melt, and in the meantime may cause degradation of memory integrity, intermittent memory errors, etc.

The more difficult type of damage to recognize and troubleshoot is the intermittent (also called latent or "walking wounded") failure.

Perform the following steps to prevent ESD damage:

- Use a wired ESD wrist strap that is properly grounded. The use of wireless anti-static straps is no longer allowed; they do not provide adequate protection. Touching the chassis before handling parts does not ensure adequate ESD protection on parts with increased sensitivity to ESD damage.
- Handle all static-sensitive components in a static-safe area. If possible, use anti-static floor pads and workbench pads.
- When unpacking a static-sensitive component from its shipping carton, do not remove the component from the anti-static packing material until you are ready to install the component. Before unwrapping the anti-static packaging, ensure that you discharge static electricity from your body.
- Before transporting a static-sensitive component, place it in an anti-static container or packaging.

ESD field service kit

The unmonitored Field Service kit is the most commonly used service kit. Each Field Service kit includes three main components: anti-static mat, wrist strap, and bonding wire.

Components of an ESD field service kit

The components of an ESD field service kit are:

- **Anti-Static Mat** – The anti-static mat is dissipative and parts can be placed on it during service procedures. When using an anti-static mat, your wrist strap should be snug and the bonding wire should be connected to the mat and to any bare metal

on the system being worked on. Once deployed properly, service parts can be removed from the ESD bag and placed directly on the mat. ESD-sensitive items are safe in your hand, on the ESD mat, in the system, or inside a bag.

- **Wrist Strap and Bonding Wire** – The wrist strap and bonding wire can be either directly connected between your wrist and bare metal on the hardware if the ESD mat is not required, or connected to the anti-static mat to protect hardware that is temporarily placed on the mat. The physical connection of the wrist strap and bonding wire between your skin, the ESD mat, and the hardware is known as bonding. Use only Field Service kits with a wrist strap, mat, and bonding wire. Never use wireless wrist straps. Always be aware that the internal wires of a wrist strap are prone to damage from normal wear and tear, and must be checked regularly with a wrist strap tester in order to avoid accidental ESD hardware damage. It is recommended to test the wrist strap and bonding wire at least once per week.
- **ESD Wrist Strap Tester** – The wires inside of an ESD strap are prone to damage over time. When using an unmonitored kit, it is a best practice to regularly test the strap prior to each service call, and at a minimum, test once per week. A wrist strap tester is the best method for doing this test. If you do not have your own wrist strap tester, check with your regional office to find out if they have one. To perform the test, plug the wrist-strap's bonding-wire into the tester while it is strapped to your wrist and push the button to test. A green LED is lit if the test is successful; a red LED is lit and an alarm sounds if the test fails.
- **Insulator Elements** – It is critical to keep ESD sensitive devices, such as plastic heat sink casings, away from internal parts that are insulators and often highly charged.
- **Working Environment** – Before deploying the ESD Field Service kit, assess the situation at the customer location. For example, deploying the kit for a server environment is different than for a desktop or portable environment. Servers are typically installed in a rack within a data center; desktops or portables are typically placed on office desks or cubicles. Always look for a large open flat work area that is free of clutter and large enough to deploy the ESD kit with additional space to accommodate the type of system that is being repaired. The workspace should also be free of insulators that can cause an ESD event. On the work area, insulators such as Styrofoam and other plastics should always be moved at least 12 inches or 30 centimeters away from sensitive parts before physically handling any hardware components.
- **ESD Packaging** – All ESD-sensitive devices must be shipped and received in static-safe packaging. Metal, static-shielded bags are preferred. However, you should always return the damaged part using the same ESD bag and packaging that the new part arrived in. The ESD bag should be folded over and taped shut and all the same foam packing material should be used in the original box that the new part arrived in. ESD-sensitive devices should be removed from packaging only at an ESD-protected work surface, and parts should never be placed on top of the ESD bag because only the inside of the bag is shielded. Always place parts in your hand, on the ESD mat, in the system, or inside an anti-static bag.
- **Transporting Sensitive Components** – When transporting ESD sensitive components such as replacement parts or parts to be returned to Dell, it is critical to place these parts in anti-static bags for safe transport.

ESD protection summary

It is recommended that all field service technicians use the traditional wired ESD grounding wrist strap and protective anti-static mat at all times when servicing Dell products. In addition, it is critical that technicians keep sensitive parts separate from all insulator parts while performing service and that they use anti-static bags for transporting sensitive components.

Transporting sensitive components

When transporting ESD sensitive components such as replacement parts or parts to be returned to Dell, it is critical to place these parts in anti-static bags for safe transport.

Lifting equipment

Adhere to the following guidelines when lifting heavy weight equipment:

 **CAUTION: Do not lift greater than 50 pounds. Always obtain additional resources or use a mechanical lifting device.**

1. Get a firm balanced footing. Keep your feet apart for a stable base, and point your toes out.
2. Tighten stomach muscles. Abdominal muscles support your spine when you lift, offsetting the force of the load.
3. Lift with your legs, not your back.
4. Keep the load close. The closer it is to your spine, the less force it exerts on your back.
5. Keep your back upright, whether lifting or setting down the load. Do not add the weight of your body to the load. Avoid twisting your body and back.
6. Follow the same techniques in reverse to set the load down.

After working inside your computer

About this task

 **CAUTION:** Leaving stray or loose screws inside your computer may severely damage your computer.

Steps

1. Replace all screws and ensure that no stray screws remain inside your computer.
2. Connect any external devices, peripherals, or cables you removed before working on your computer.
3. Replace any media cards, discs, or any other parts that you removed before working on your computer.
4. Connect your computer and all attached devices to their electrical outlets.
5. Turn on your computer.

Removing and installing components

i **NOTE:** The images in this document may differ from your computer depending on the configuration you ordered.

Topics:

- Recommended tools
- Screw list
- Stand
- Cable cover—optional
- Back cover
- Hard drive
- Memory modules
- System-board shield
- Solid-state drive
- System fan
- Coin-cell battery
- Wireless card
- Camera assembly
- Bottom cover
- Power-supply unit
- Power-supply fan
- Heat sink
- Processor
- Rear-I/O bracket
- System board
- Speakers
- Power-button board
- Microphones
- Side I/O-board
- Audio board
- Antennas
- Display panel
- Middle frame

Recommended tools

The procedures in this document may require the following tools:

- Phillips screwdriver #1
- Plastic scribe

Screw list

i **NOTE:** When removing screws from a component, it is recommended to note the screw type, the quantity of screws, and then place them in a screw storage box. This is to ensure that the correct number of screws and correct screw type is restored when the component is replaced.







i **NOTE:** Some systems have magnetic surfaces. Ensure that the screws are not left attached to such surface when replacing a component.

NOTE: Screw color may vary with the configuration ordered.

Table 1. OptiPlex 7480 All-in-One screw list

Component	Screw type	Quantity	Screw image
Cable cover—optional	M3x9	1	
System-board shield	M3x5	5	
Bottom cover	M3x5	4	
M.2 2230 solid-state drive	M2x2.5	1	
M.2 2280 solid-state drive/ Intel Optane memory	M2x2.5	1	
System fan	M3x5	3	
Wireless-card shield	M2x2.5	2	
Wireless card	M2x2.5	1	
Camera assembly	M3x5	2	
Camera door	M3x5	2	
Heat sink—UMA	Captive screws	5	
Heat sink—Discrete	Captive screws	9	
Power-supply unit (PSU)	M3x5	2	
PSU fan	M3x5	2	
Rear-I/O bracket	M3x5	4	
System board	M3x5	9	
Speakers	M3 4+7.1xZN	6	
Power-button board	M3x5	1	

Table 1. OptiPlex 7480 All-in-One screw list (continued)

Component	Screw type	Quantity	Screw image
Microphones	M2x2.5	4	
Side I/O-board shield	M3x5	2	
Side-I/O board	M2.5x3.5	2	
Antenna modules	M2x2.5	2	
Display panel	M3x5	11	
Middle frame	M3x5	17	
Audio board	M3x5	1	

Stand

Removing the fixed stand

Prerequisites

1. Follow the procedure in [Before working inside your computer](#).

 **NOTE:** When servicing the system, place it on an elevated, clean, and flat surface. Dell recommends removing the stand to avoid accidental damage to the system display during servicing.

About this task

The following image provides a visual representation of the fixed stand removal procedure.

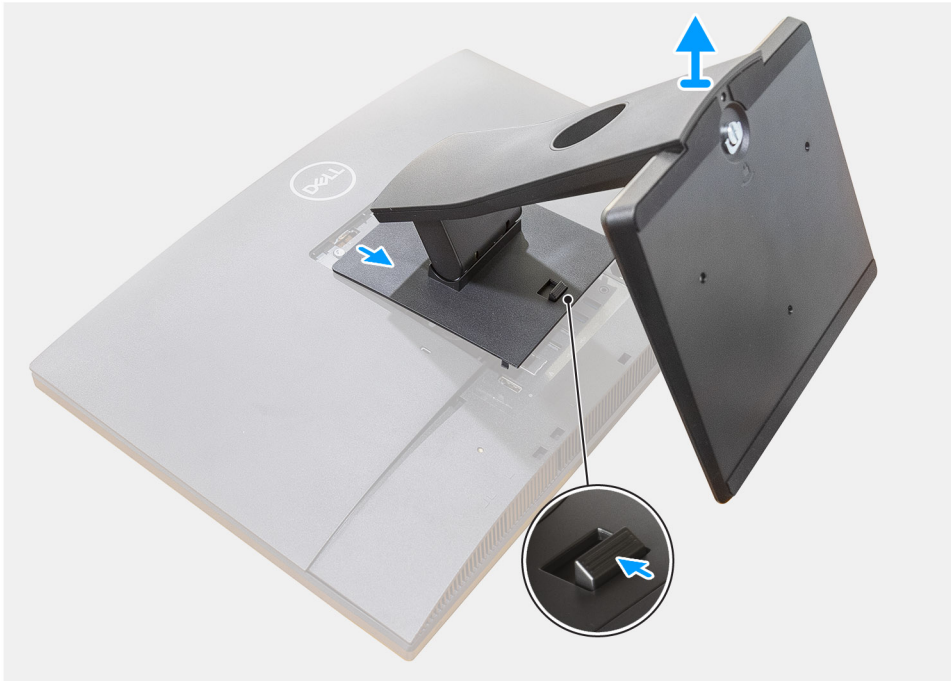

Steps

1. Press and slide the release button up.
2. Hold the button in the release position and lift the stand upward.
3. Slide the stand downward, to lift the stand off the back cover.

Installing the fixed stand

Prerequisites

If you are replacing a component, remove the existing component before performing the installation procedure.

About this task

The following image provides a visual representation of the fixed stand installation procedure.

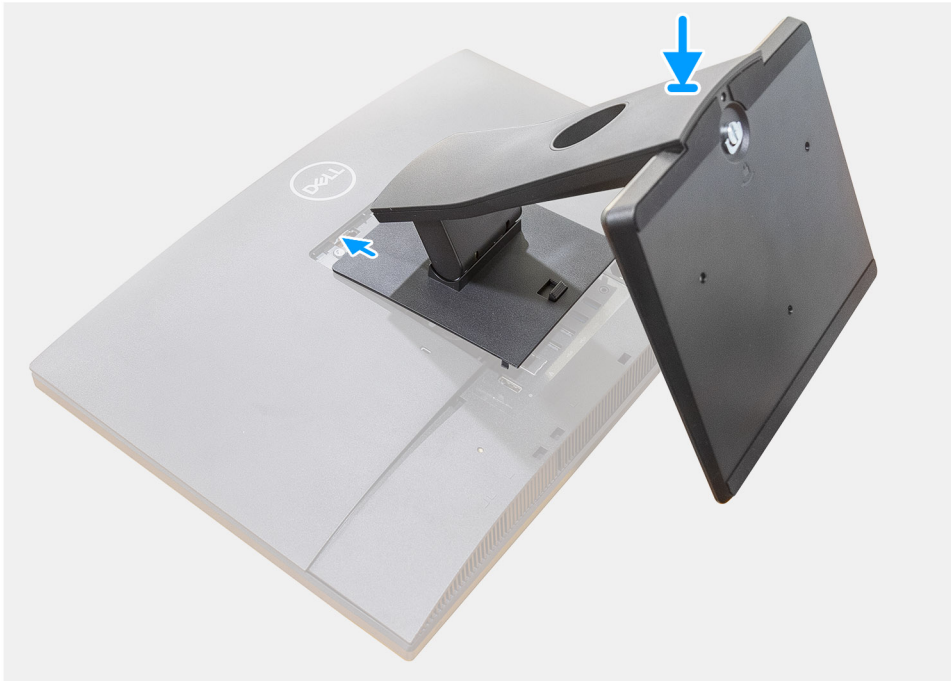

Steps

1. Align the tabs on the stand with the slots on the back cover.
2. Snap the stand until it clicks into place.

Next steps

1. Follow the procedure in [After working inside your computer](#).

Removing the articulating stand

Prerequisites

1. Follow the procedure in [Before working inside your computer](#).

CAUTION: When servicing the system, place it on an elevated, clean, and flat surface. It is recommended to remove the stand to avoid accidental damage to the system display during servicing.

About this task

The following image provides a visual representation of the articulating stand removal procedure.

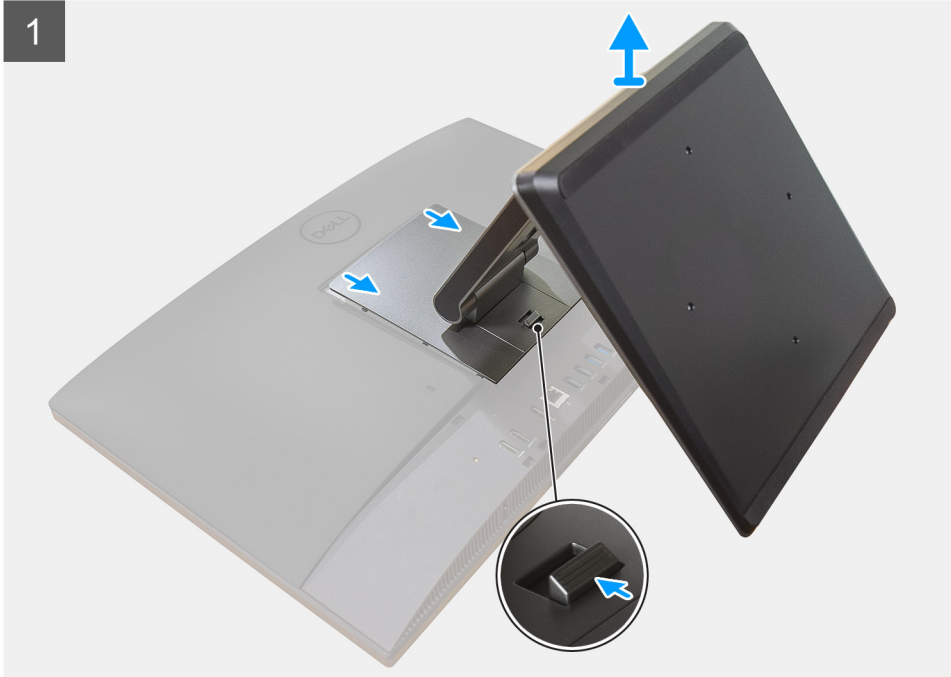

Steps

1. Press and slide the release button up.

2. Hold the button in the release position, and lift the stand upward.
3. Slide the stand downward, to lift the stand off the back cover.
4. Pry the rubber feet from the bottom cover and pull it out.

Installing the articulating stand

Prerequisites

If you are replacing a component, remove the existing component before performing the installation procedure.

About this task

The following image provides a visual representation of the articulating stand installation procedure.



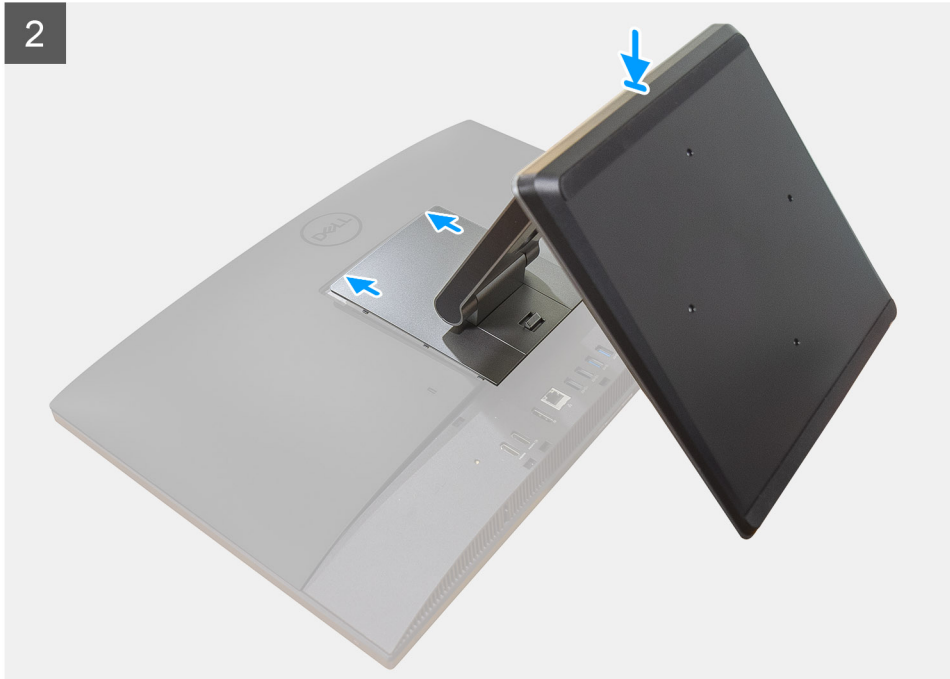

Steps

1. Align the rubber feet with the slots on the bottom cover and push it firmly in place.
2. Align the tabs on the stand with the slots on the back cover.
3. Snap the stand until it clicks into place.

Next steps

1. Follow the procedure in [After working inside your computer](#).

Removing the height adjustable stand

Prerequisites

NOTE: Follow the same procedure to remove the Height Adjustable Stand with Optical Disk Drive.

1. Follow the procedure in [Before working inside your computer](#).

CAUTION: When servicing the system, place it on an elevated, clean, and flat surface. Dell recommends removing the stand to avoid accidental damage to the system display during servicing.

About this task

The following image provides a visual representation of the height adjustable stand removal procedure.

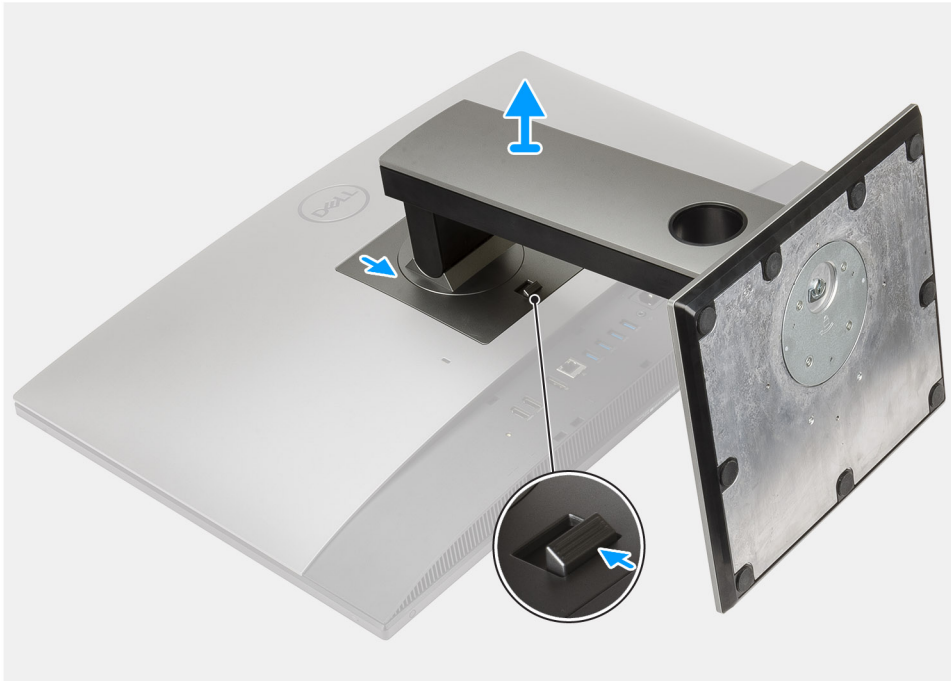

Steps

1. Press and slide the release button up.
2. Hold the button in the release position, and lift the stand upward.
3. Slide the stand downward, to lift the stand off the back cover.

Installing the height adjustable stand

Prerequisites

If you are replacing a component, remove the existing component before performing the installation procedure.

NOTE: Follow the same procedure to install the Height Adjustable Stand with Optical Disk Drive.

About this task

The following image provides a visual representation of the height adjustable stand installation procedure.

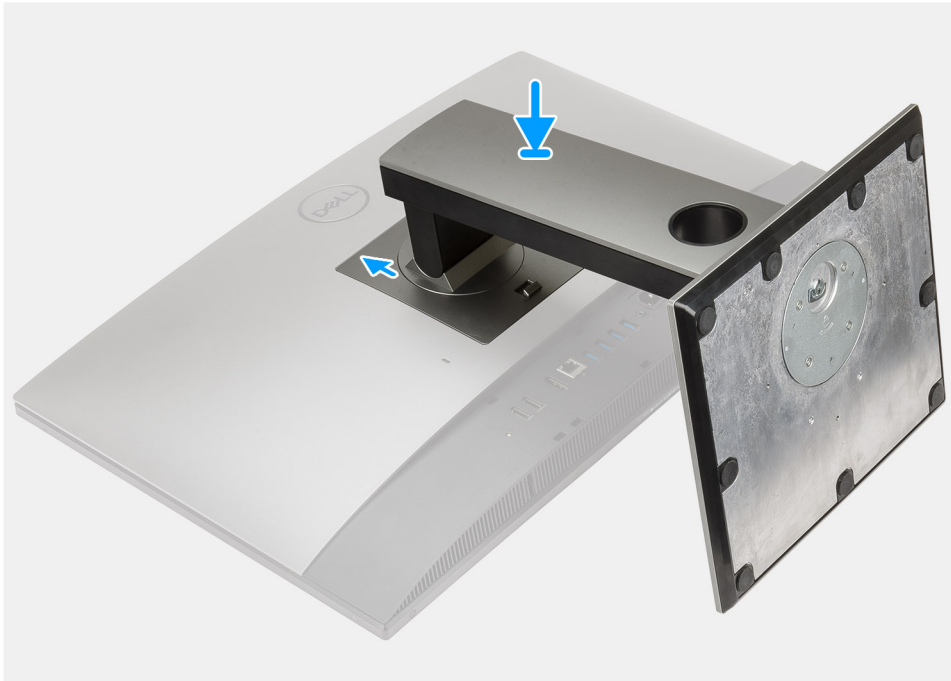

Steps

1. Align the tabs on the stand with the slots on the back cover.
2. Snap the stand until it clicks into place.

Next steps

1. Follow the procedure in [After working inside your computer](#).

Cable cover—optional

Removing the cable cover

Prerequisites

1. Follow the procedure in [Before working inside your computer](#).

 **CAUTION:** When servicing the system, place it on an elevated, clean, and flat surface. It is recommended to remove the stand to avoid accidental damage to the system display during servicing.

2. Remove the [stand](#).

About this task

The following image provides a visual representation of the cable cover removal procedure.



1x
M3x9

1

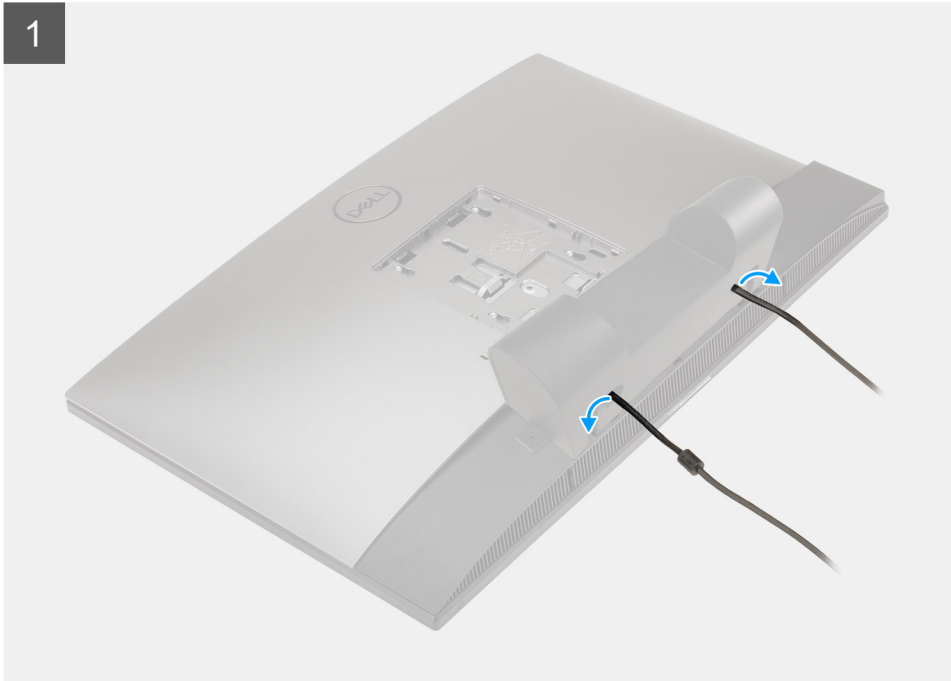

2

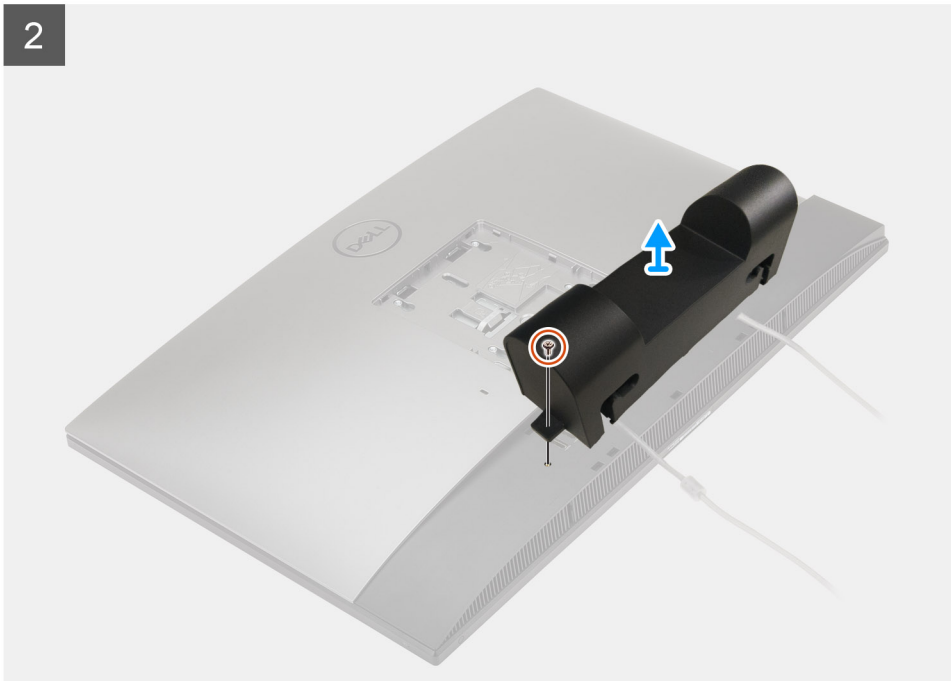

Steps

1. Unroute the power cable from the slots on the cable cover.
2. Remove the screw (M3x9) that secures the cable cover to the bottom cover.
3. Lift the cable cover from the bottom cover.

Installing the cable cover

Prerequisites

If you are replacing a component, remove the existing component before performing the installation procedure.

About this task

The following image provides a visual representation of the cable cover installation procedure.



1x
M3x9

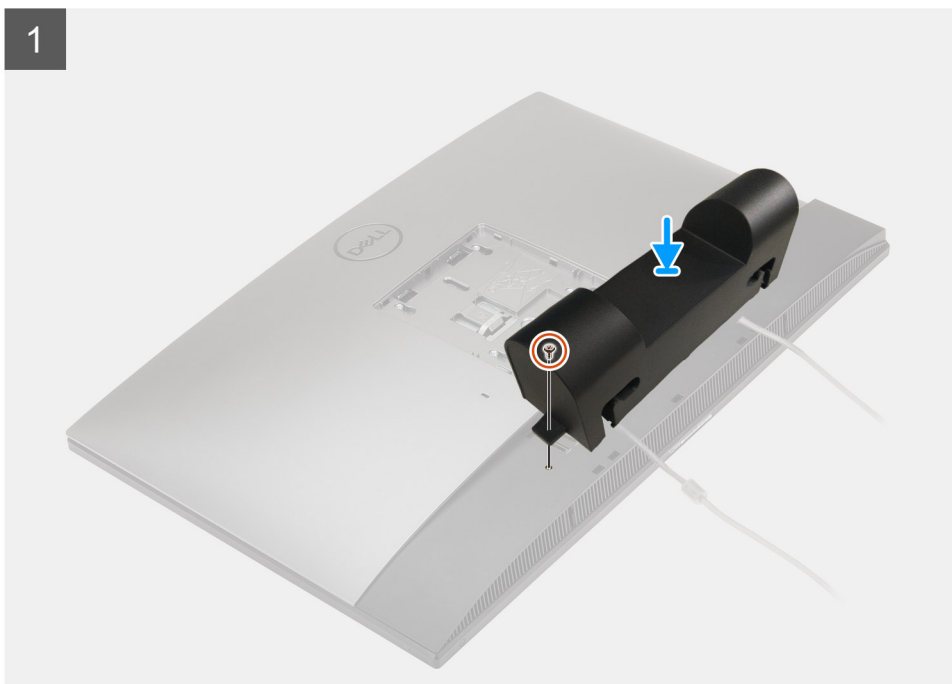

2

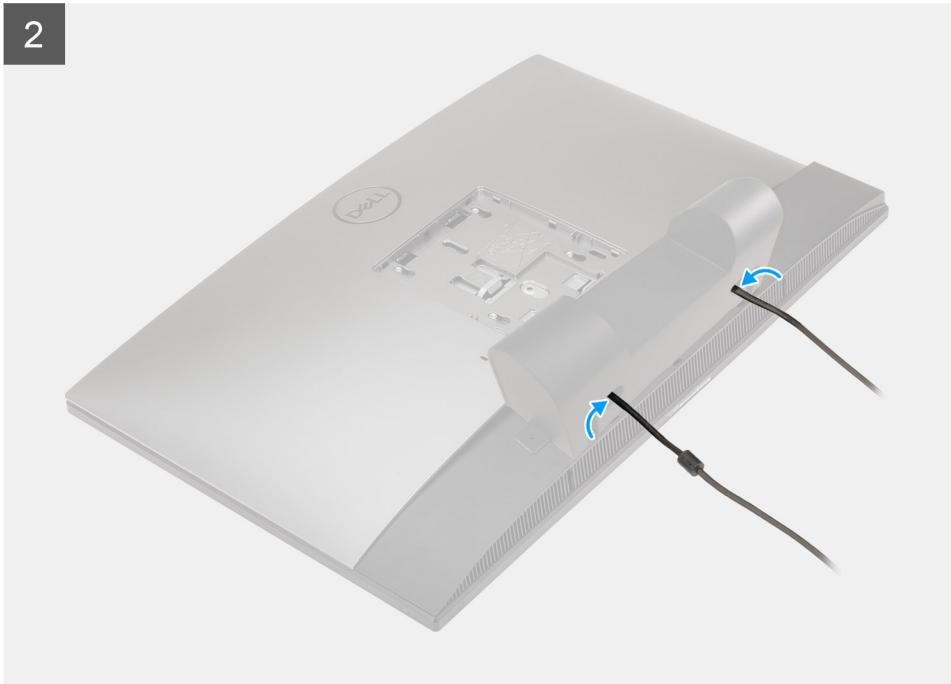

Steps

1. Route the power cable through the slots on the cable cover.
2. Align the screw hole on the cable cover with the screw hole on the bottom cover.
3. Replace the screw (M3x9) to secure the cable cover to the bottom cover.

Next steps

1. Install the [stand](#).
2. Follow the procedure in [After working inside your computer](#).

Back cover

Removing the back cover

Prerequisites

1. Follow the procedure in [Before working inside your computer](#).

CAUTION: When servicing the system, place it on an elevated, clean, and flat surface. It is recommended to remove the stand to avoid accidental damage to the system display during servicing.

2. Remove the [stand](#).
3. Remove the [cable cover](#) (optional).

About this task

The following image provides a visual representation of the back cover removal procedure.

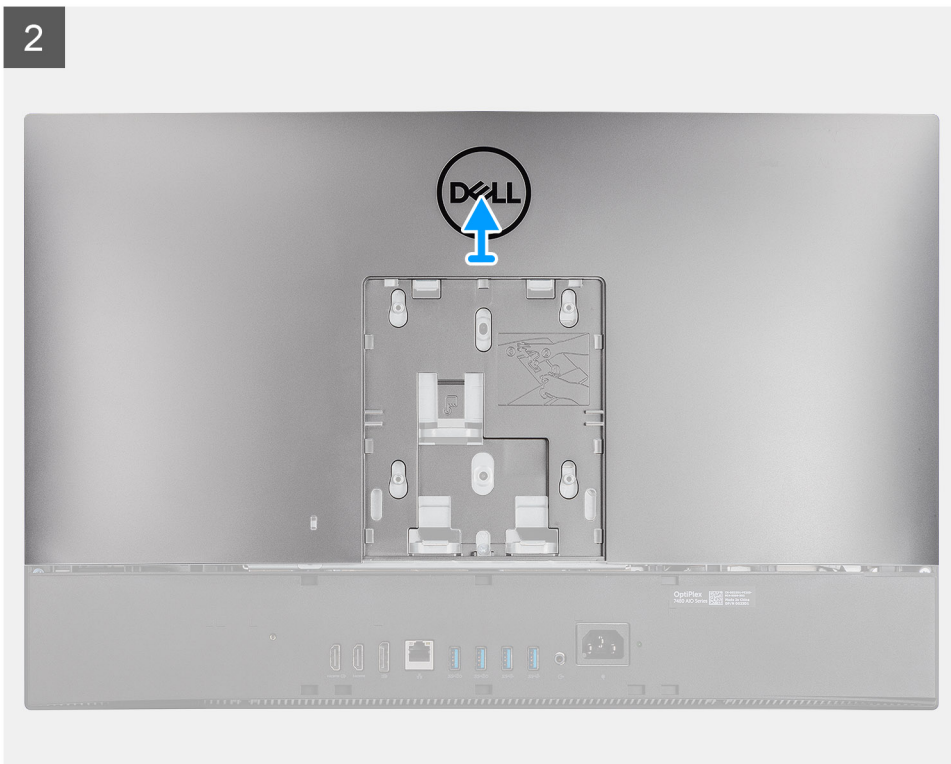
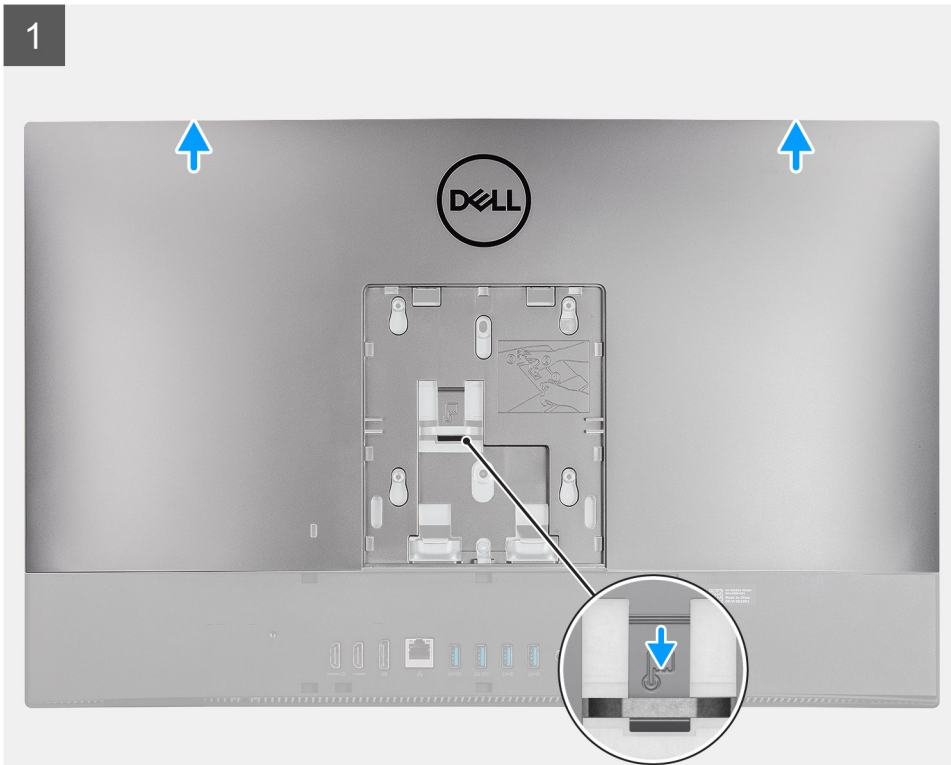

Steps

1. Press and hold the release tab on the back cover to release it from the latch on the system-board shield.
2. Slide the back cover up to release the tabs on the cover from the slots on the middle frame.
3. Lift the back cover and remove it from the system.

Installing the back cover

Prerequisites

If you are replacing a component, remove the existing component before performing the installation procedure.

About this task

The following image provides a visual representation of the back cover installation procedure.

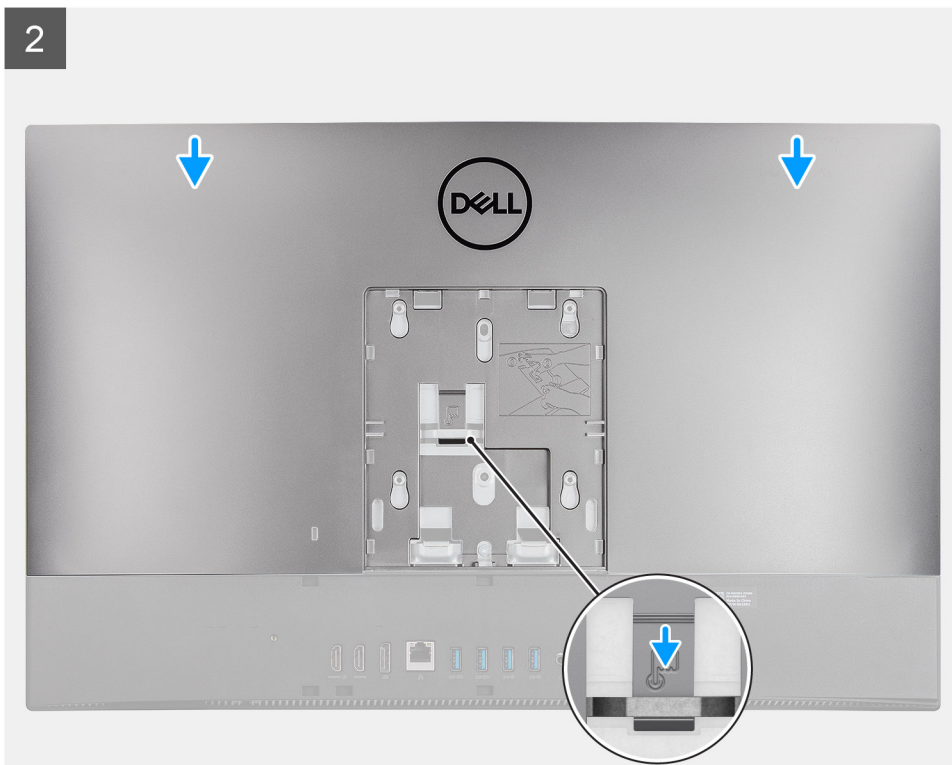
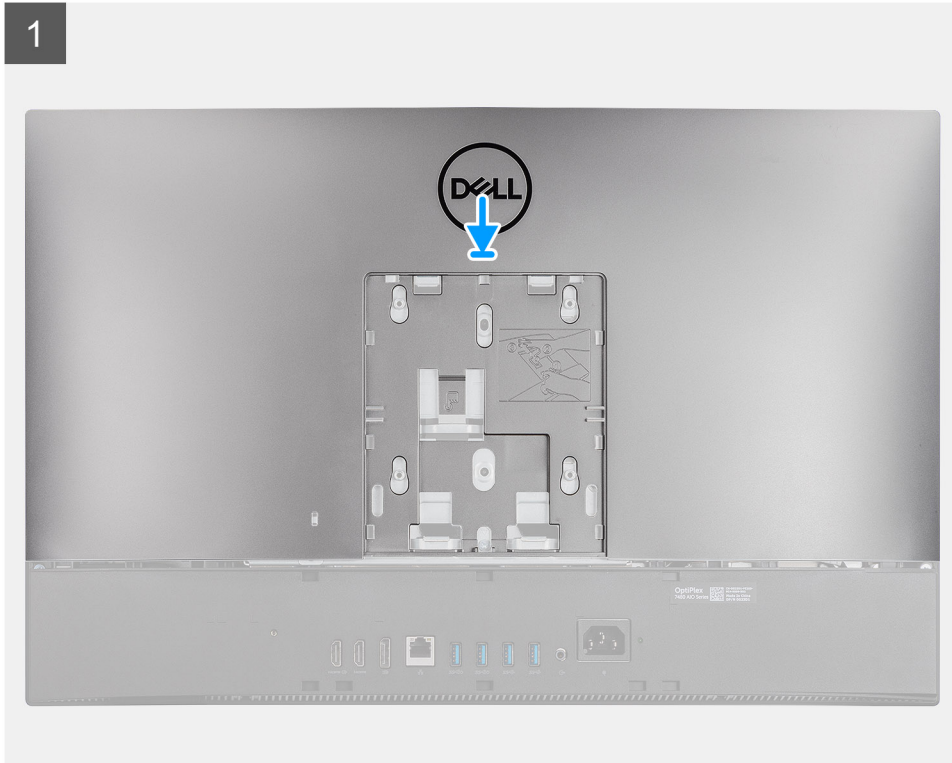

Steps

1. Place the back cover on the middle frame and system-board shield and align the tabs on the back cover with the slots on the middle frame.
2. Slide the back cover to lock the release tab under the latch on the system-board shield.

Next steps

1. Install the [cable cover](#) (optional).
2. Install the [stand](#).
3. Follow the procedure in [After working inside your computer](#).

Hard drive

Removing the hard drive

Prerequisites

1. Follow the procedure in [Before working inside your computer](#).
2. Remove the [stand](#).
3. Remove the [cable cover](#) (optional).
4. Remove the [back cover](#).

About this task

The following image indicates the location of the hard drive and provides a visual representation of the removal procedure.

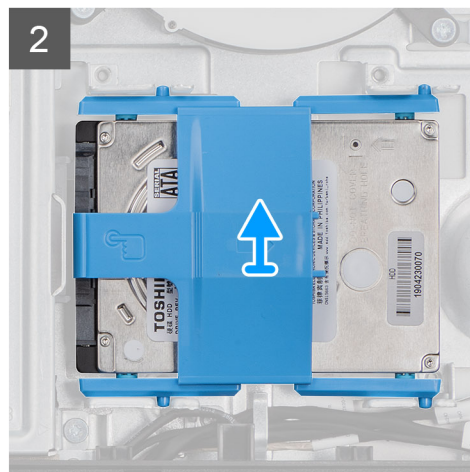
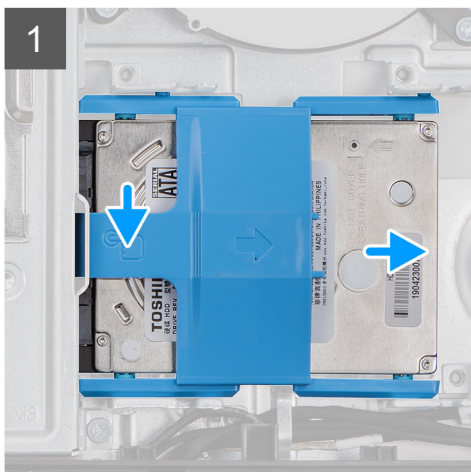
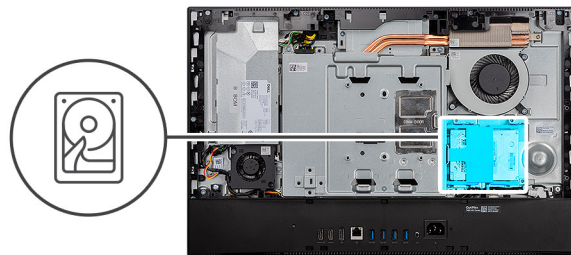



Steps

1. Press down the tab securing the hard-drive assembly to the system-board shield.
2. Slide and lift the hard-drive assembly from the slot on the display-assembly base.
3. Pry the tabs on hard-drive bracket from its slots on the hard drive.
4. Remove the hard drive from the hard-drive bracket.

Installing the hard drive

Prerequisites

If you are replacing a component, remove the existing component before performing the installation procedure.

About this task

The following image indicates the location of the hard drive and provides a visual representation of the installation procedure.

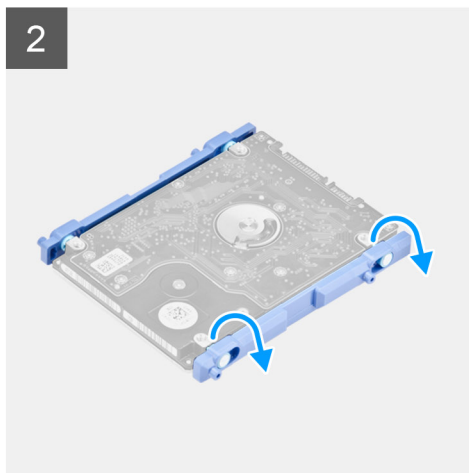
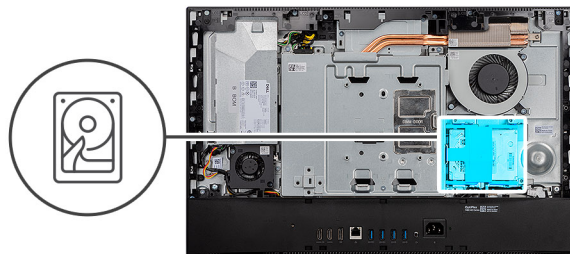

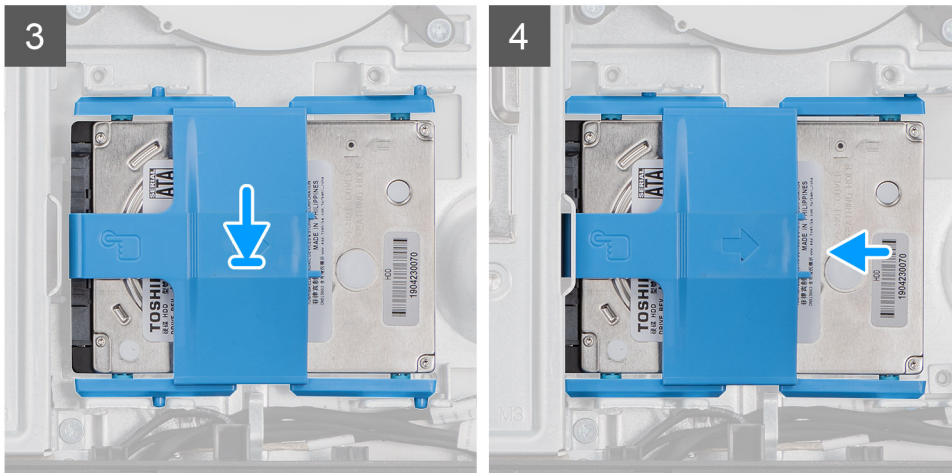

Steps

1. Align the tabs on the hard-drive bracket with the slots on the hard drive.
2. Flex the hard-drive bracket and replace the remaining tabs on the hard-drive bracket with the slots on the hard drive.
3. Place the hard-drive assembly into the slot and slide it to lock the hard-drive assembly on the display-assembly base.

Next steps

1. Install the [back cover](#).
2. Install the [cable cover](#) (optional).
3. Install the [stand](#).
4. Follow the procedure in [After working inside your computer](#).

Memory modules

Removing the memory modules

Prerequisites

1. Follow the procedure in [Before working inside your computer](#).
2. Remove the [stand](#).
3. Remove the [cable cover](#) (optional).
4. Remove the [back cover](#).

About this task

The following image indicates the location of the memory modules and provides a visual representation of the removal procedure.

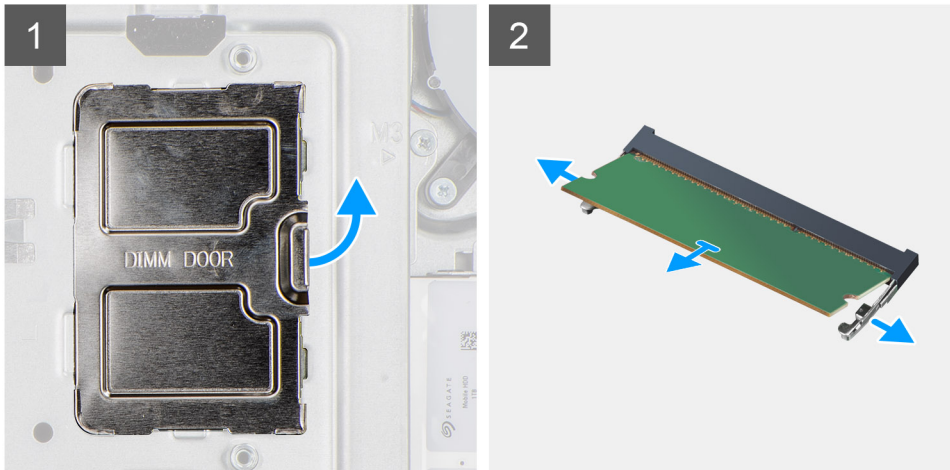
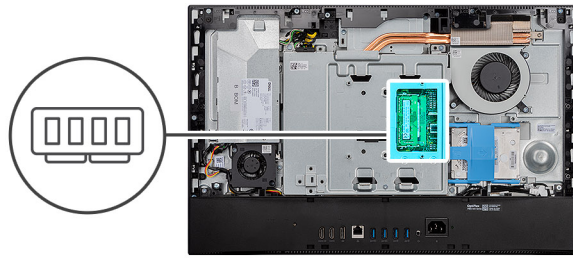

Steps

1. Pry and remove the DIMM door from the system-board shield.
2. Using your fingertips, spread apart the securing clips on the memory-module slot until the memory module pops up.
3. Slide and remove the memory module from the memory-module slot.

i **NOTE:** Repeat step 2 and 3 if there are two memory modules.

Installing the memory modules

Prerequisites

If you are replacing a component, remove the existing component before performing the installation procedure.

About this task

The following image indicates the location of the memory module and provides a visual representation of the installation procedure.

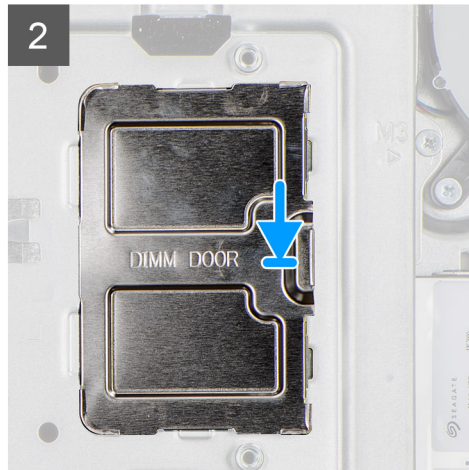
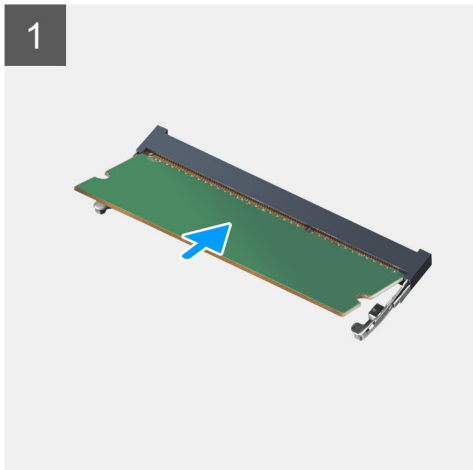
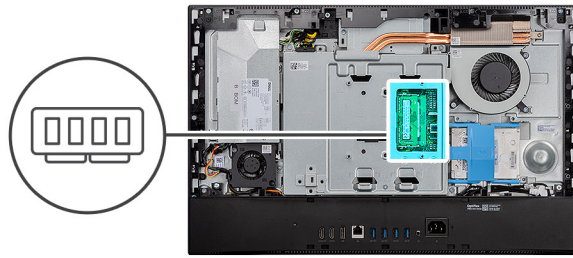

Steps

1. Align the notch on the memory module with the tab on the memory-module slot.
2. Slide the memory module firmly into the slot at an angle and press the memory module down until it clicks into place.
 - i** **NOTE:** If you do not hear the click, remove the memory module and reinstall it.
 - i** **NOTE:** Repeat step 1 and 2 if there are two memory modules.
3. Align the tabs on the DIMM door with the slots on the system-board shield and snap into place.

Next steps

1. Install the [back cover](#).
2. Install the [cable cover](#) (optional).
3. Install the [stand](#).
4. Follow the procedure in [After working inside your computer](#).

System-board shield

Removing the system-board shield

Prerequisites

1. Follow the procedure in [Before working inside your computer](#).
2. Remove the [stand](#).
3. Remove the [cable cover](#) (optional).
4. Remove the [back cover](#).

About this task

The following image indicates the location of the system-board shield and provides a visual representation of the removal procedure.



5x
M3x5

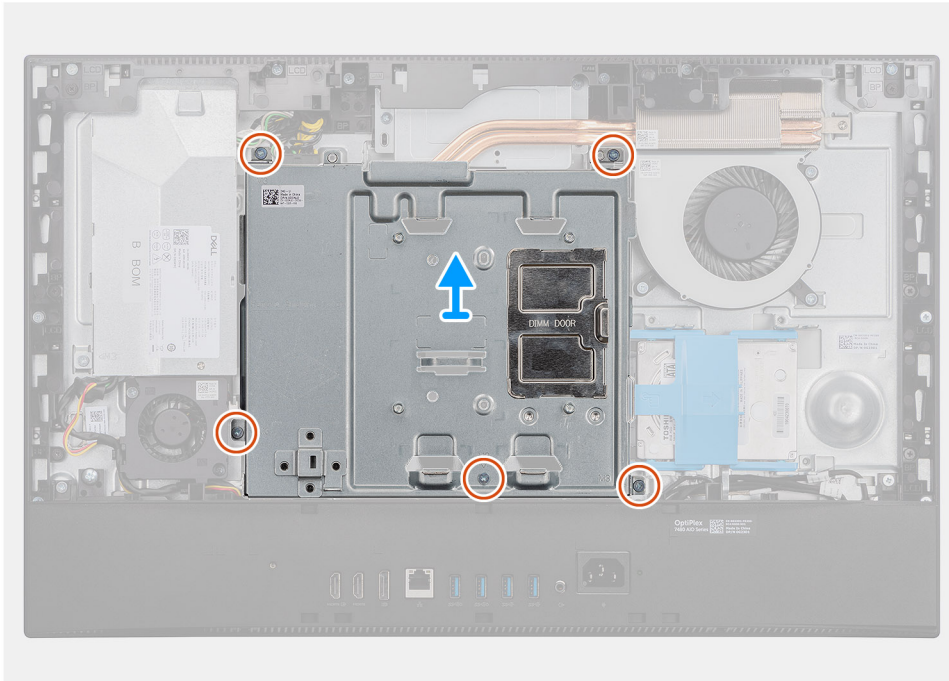
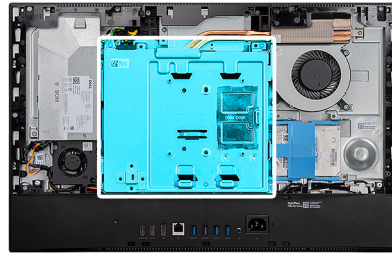

Steps

1. Remove the five screws (M3x5) that secure the system-board shield to the display-assembly base.
2. Lift the system-board shield off the display-assembly base.

Installing the system-board shield

Prerequisites

If you are replacing a component, remove the existing component before performing the installation procedure.

About this task

The following image indicates the location of the system-board shield and provides a visual representation of the installation procedure.



5x
M3x5

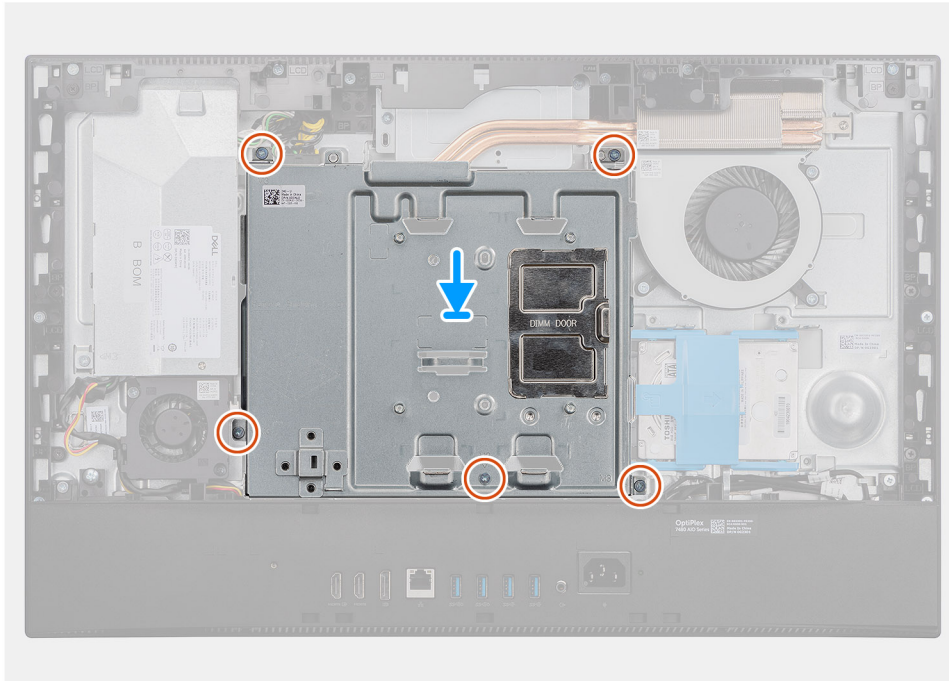
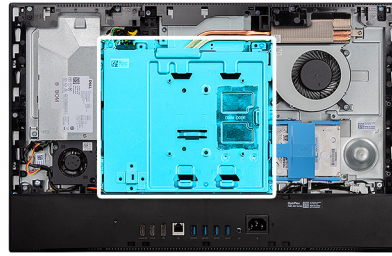

Steps

1. Align the screw holes on the system-board shield with the screw holes on the display-assembly base.
2. Replace the five screws (M3x5) to secure the system-board shield to the display-assembly base.

Next steps

1. Install the [back cover](#).
2. Install the [cable cover](#) (optional).
3. Install the [stand](#).
4. Follow the procedure in [After working inside your computer](#).

Solid-state drive

Removing the M.2 2230 solid-state drive

Prerequisites

1. Follow the procedure in [Before working inside your computer](#).
2. Remove the [stand](#).
3. Remove the [cable cover](#) (optional).
4. Remove the [back cover](#).
5. Remove the [system-board shield](#).

About this task

The following image indicates the location of the M.2 2230 solid-state drive and provides a visual representation of the removal procedure.



1x
M2x2.5

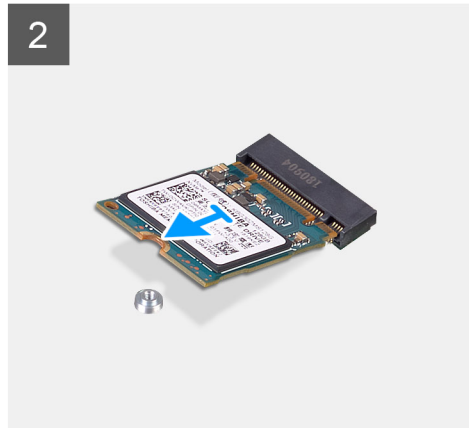
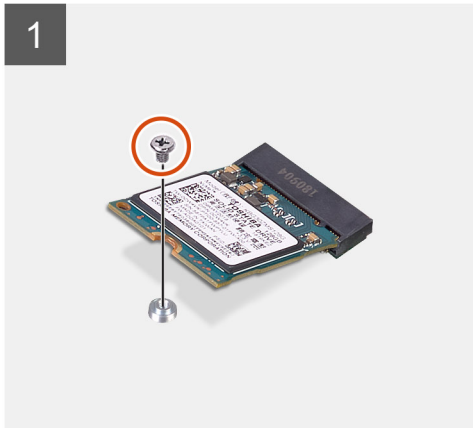
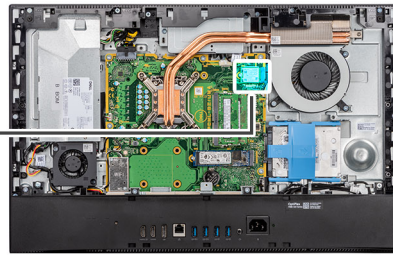

Steps

1. Remove the screw (M2x2.5) that secures the solid-state drive to the system board.
2. Slide and remove the solid-state drive from the M.2 card slot on the system board.

Installing the M.2 2230 solid-state drive

Prerequisites

CAUTION: Solid-state drives are fragile. Exercise care when handling the solid-state drive.

If you are replacing a component, remove the existing component before performing the installation procedure.

About this task

The following image indicates the location of the M.2 2230 solid-state drive and provides a visual representation of the installation procedure.



1x
M2x2.5

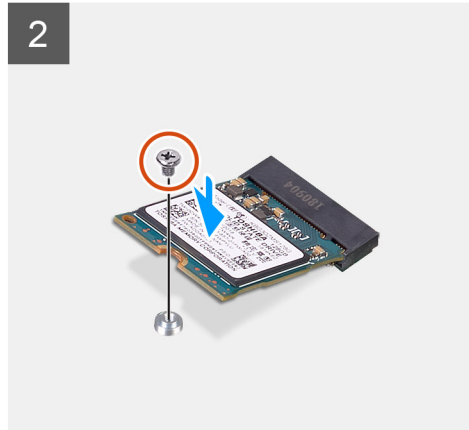
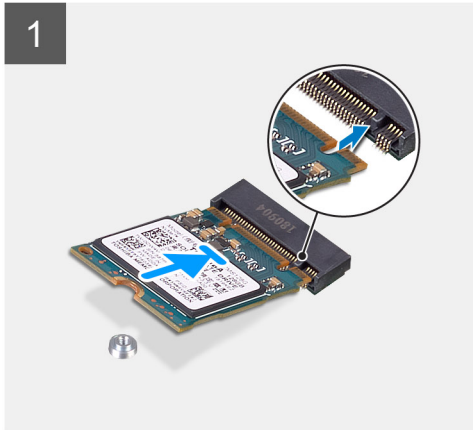
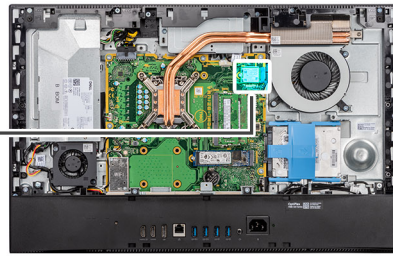

Steps

1. Align the notch on the solid-state drive with the tab on the M.2 card slot.
2. Slide the solid-state drive into the M.2 card slot on the system board.
3. Replace the screw (M2x2.5) to secure the solid-state drive to the system board.

Next steps

1. Install the [system-board shield](#).
2. Install the [back cover](#).
3. Install the [cable cover](#) (optional).
4. Install the [stand](#).
5. Follow the procedure in [After working inside your computer](#).

Removing the M.2 2280 solid-state drive/Intel Optane memory module

Prerequisites

1. Follow the procedure in [Before working inside your computer](#).
2. Remove the [stand](#).
3. Remove the [cable cover](#) (optional).
4. Remove the [back cover](#).
5. Remove the [system-board shield](#).

About this task

The following image indicates the location of the M.2 2280 solid-state drive/Intel Optane memory module and provides a visual representation of the removal procedure.



1x
M2x2.5

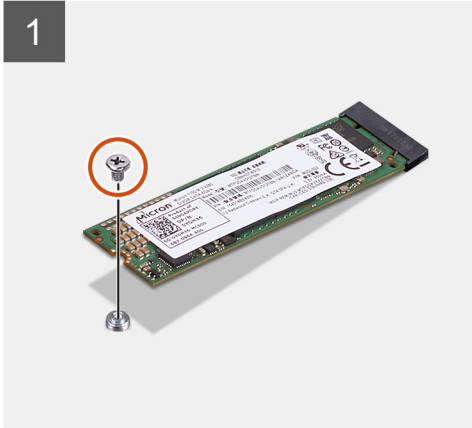
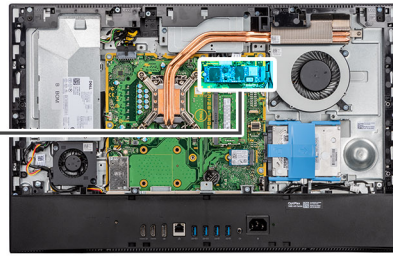

Steps

1. Remove the screw (M2x2.5) that secures the solid-state drive to the system board.
2. Slide and remove the solid-state drive from the M.2 card slot on the system board.

Installing the M.2 2280 solid-state drive/Intel Optane memory module

Prerequisites

CAUTION: Solid-state drives are fragile. Exercise care when handling the solid-state drive.

If you are replacing a component, remove the existing component before performing the installation procedure.

About this task

The following image indicates the location of the M.2 2280 solid-state drive/Intel Optane memory module and provides a visual representation of the installation procedure.



1x
M2x2.5

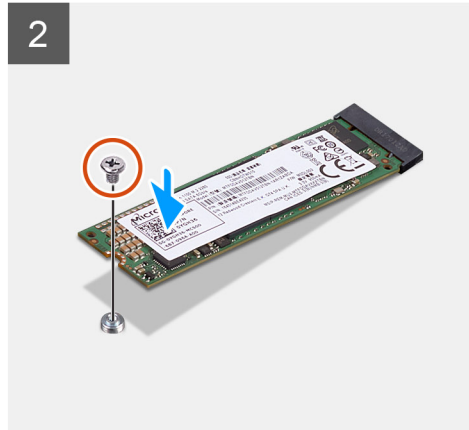
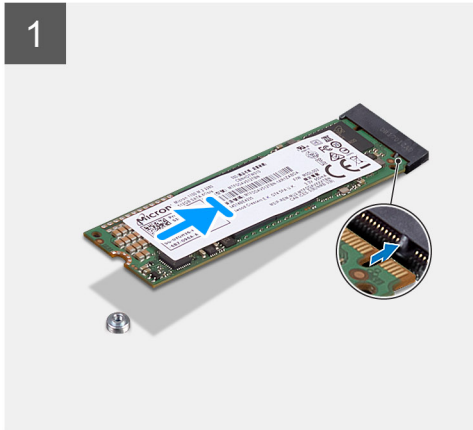
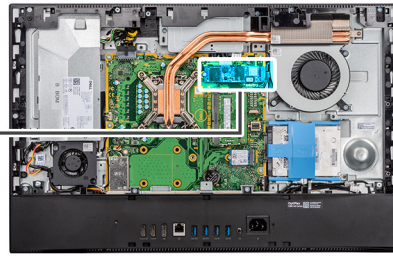

Steps

1. Align the notch on the solid-state drive with the tab on the M.2 card slot.
2. Slide the solid-state drive into the M.2 card slot on the system board.
3. Replace the screw (M2x2.5) to secure the solid-state drive to the system board.

Next steps

1. Install the [system-board shield](#).
2. Install the [back cover](#).
3. Install the [cable cover](#) (optional).
4. Install the [stand](#).
5. Follow the procedure in [After working inside your computer](#).

System fan

Removing the system fan

Prerequisites

1. Follow the procedure in [Before working inside your computer](#).
2. Remove the [stand](#).
3. Remove the [cable cover](#) (optional).
4. Remove the [back cover](#).
5. Remove the [system-board shield](#).

About this task

The following image indicates the location of the system fan and provides a visual representation of the removal procedure.



3x
M3x5

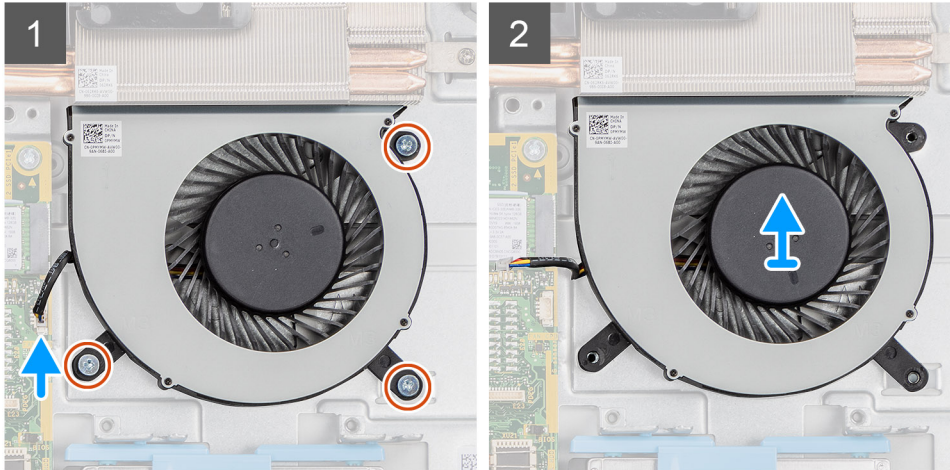
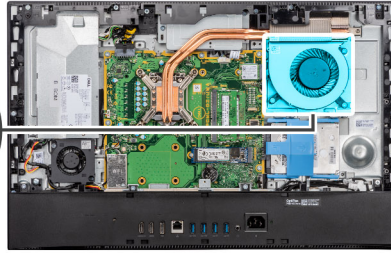
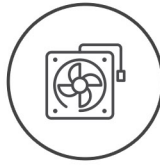

Steps

1. Disconnect the system-fan cable from the system board.
2. Remove the three screws (M3x5) that secure the system fan to the display-assembly base.
3. Lift the system fan, along with its cable, off the display-assembly base.

Installing the system fan

Prerequisites

If you are replacing a component, remove the existing component before performing the installation procedure.

About this task

The following image indicates the location of the system fan and provides a visual representation of the installation procedure.



3x
M3x5

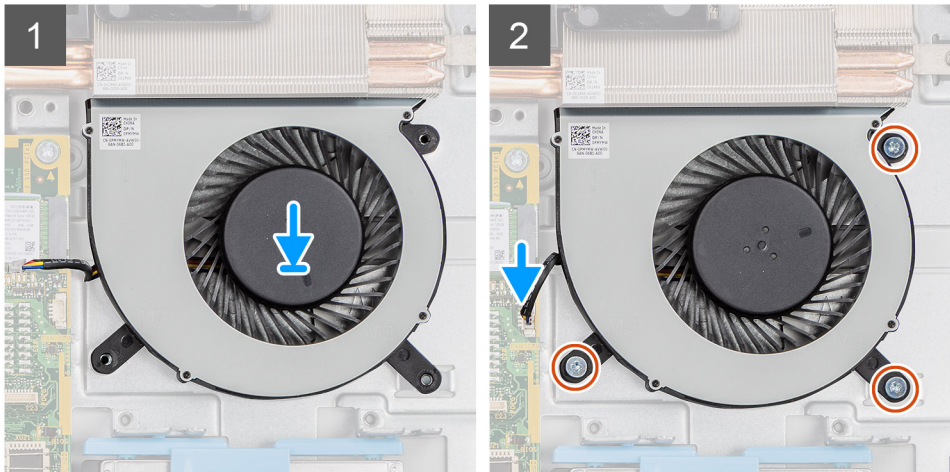
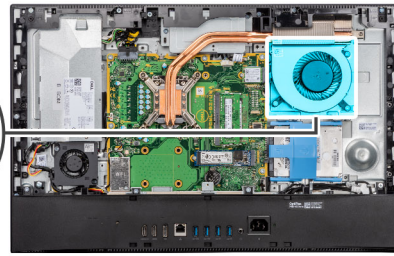
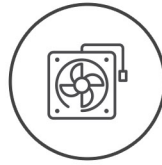

Steps

1. Align the screw holes on the system fan with the screw holes on the display-assembly base.
2. Replace the three screws (M3x5) to secure the system fan to the display-assembly base.
3. Connect the system-fan cable to the connector on the system board.

Next steps

1. Install the [system-board shield](#).
2. Install the [back cover](#).
3. Install the [cable cover](#) (optional).
4. Install the [stand](#).
5. Follow the procedure in [After working inside your computer](#).

Coin-cell battery

Removing the coin-cell battery

Prerequisites

1. Follow the procedure in [Before working inside your computer](#).
2. Remove the [stand](#).
3. Remove the [cable cover](#) (optional).
4. Remove the [back cover](#).
5. Remove the [system-board shield](#).

NOTE: Removing the coin-cell battery resets the CMOS and BIOS settings to default and results in data loss. It is recommended that you note the CMOS and BIOS settings before removing the coin-cell battery.

About this task

The following image indicates the location of the coin-cell battery and provides a visual representation of the removal procedure.

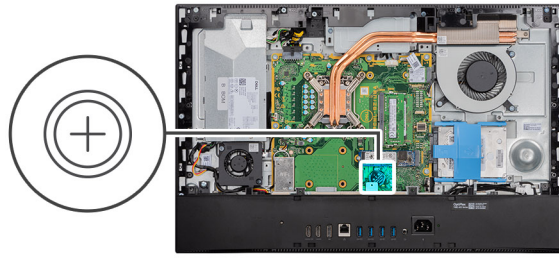

Steps

1. Using the plastic scribe, press on the metal clip to release the coin-cell battery from the coin-cell battery holder.
2. Lift the coin-cell battery from the coin-cell battery holder.

Installing the coin-cell battery

Prerequisites

If you are replacing a component, remove the existing component before performing the installation procedure.

About this task

The following image indicates the location of the coin-cell battery and provides a visual representation of the installation procedure.

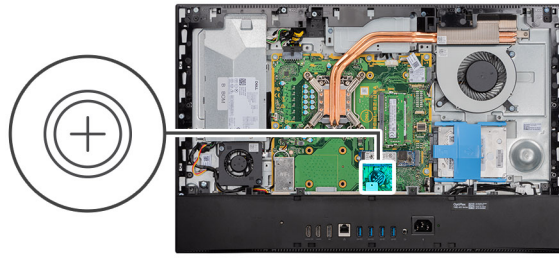

Steps

With the positive-side facing up, insert the coin-cell battery into the battery holder on the system board and gently press the battery until it snaps into place.

Next steps

1. Install the [system-board shield](#).
2. Install the [back cover](#).
3. Install the [cable cover](#) (optional).
4. Install the [stand](#).
5. Follow the procedure in [After working inside your computer](#).

Wireless card

Removing the wireless card

Prerequisites

1. Follow the procedure in [Before working inside your computer](#).
2. Remove the [stand](#).
3. Remove the [cable cover](#) (optional).
4. Remove the [back cover](#).
5. Remove the [system-board shield](#).

About this task

The following image indicates the location of the wireless card and provides a visual representation of the removal procedure.



3x
M2x2.5

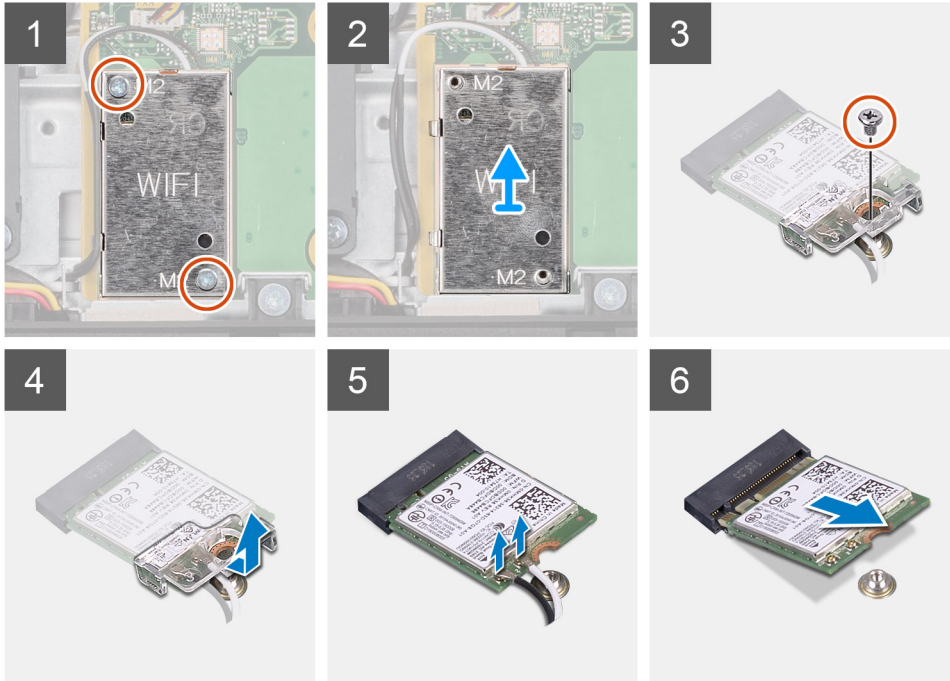
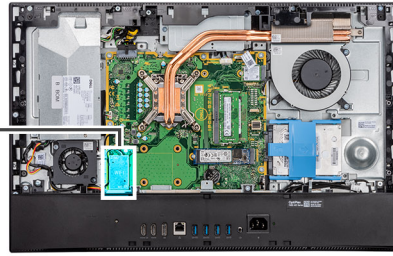

Steps

1. Remove the two screws (M2x2.5) that secure the wireless-card shield to the system board.
2. Unroute the antenna cables from the routing guides on the wireless-card shield.
3. Lift the wireless-card shield out of the system.
4. Remove the screw (M2x2.5) that secures the wireless-card bracket to the wireless card.
5. Slide and remove the wireless-card bracket off the wireless card.
6. Disconnect the antenna cables from the wireless card.
7. Slide and remove the wireless card from the wireless-card slot.

Installing the wireless card

Prerequisites

If you are replacing a component, remove the existing component before performing the installation procedure.

 **CAUTION:** To avoid damage to the wireless card, route the antenna cables accurately.

About this task

The following image indicates the location of the wireless card and provides a visual representation of the installation procedure.



3x
M2x2.5

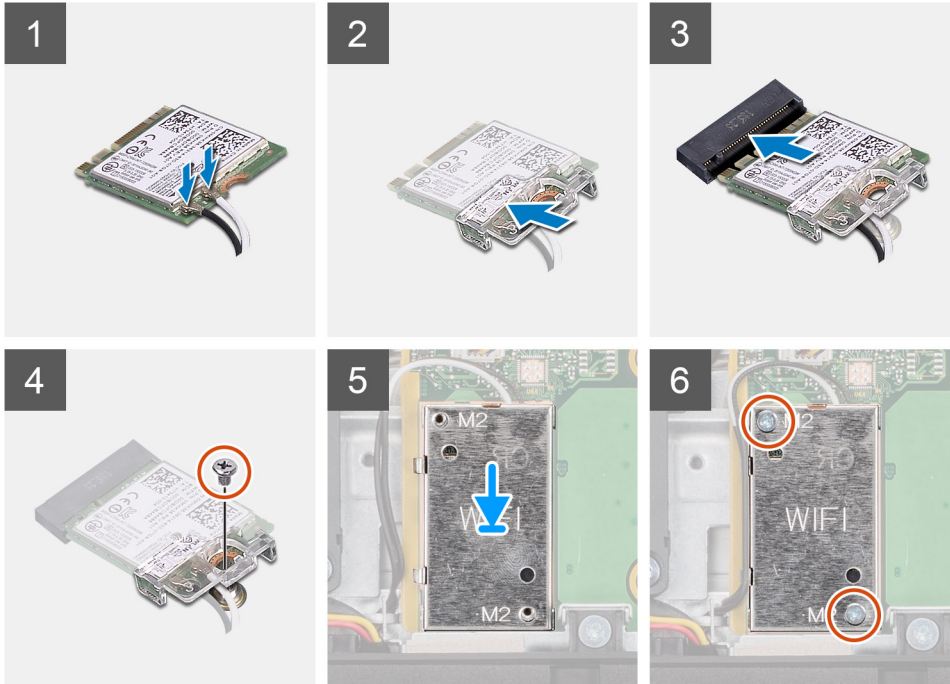
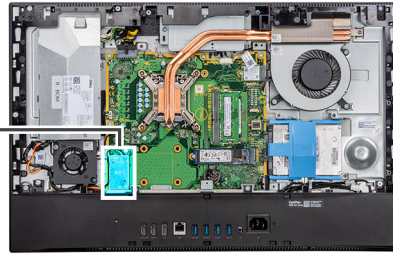

Steps

1. Connect the antenna cables to the wireless card.
The following table provides the antenna-cable color scheme:

Table 2. Antenna-cable color scheme

Connectors on the wireless card	Antenna-cable color
Main (white triangle)	White
Auxiliary (black triangle)	Black

2. Place the wireless-card bracket on the wireless card.
3. Align the notch on the wireless card with the tab on the wireless-card slot.
4. Slide the wireless card at an angle into the wireless-card slot.
5. Replace the screw (M2x2.5) to secure the wireless-card bracket to the wireless card.
6. Align and place the wireless-card shield on the system board and wireless card.
7. Replace the two screws (M2x2.5) to secure the wireless-card shield to the system board.
8. Route the antenna cables through the routing guides on the wireless-card shield.

Next steps

1. Install the [system-board shield](#).
2. Install the [back cover](#).
3. Install the [cable cover](#) (optional).
4. Install the [stand](#).
5. Follow the procedure in [After working inside your computer](#).

Camera assembly

Removing the camera assembly

Prerequisites

1. Follow the procedure in [Before working inside your computer](#).
2. Remove the [stand](#).
3. Remove the [cable cover](#) (optional).
4. Remove the [back cover](#).
5. Remove the [system-board shield](#).

About this task

The following image indicates the location of the camera assembly and provides a visual representation of the removal procedure.



4x
M3x5

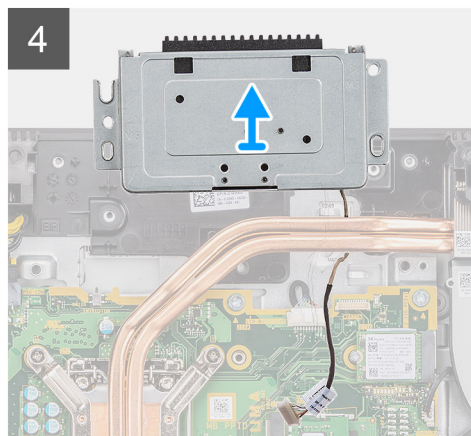
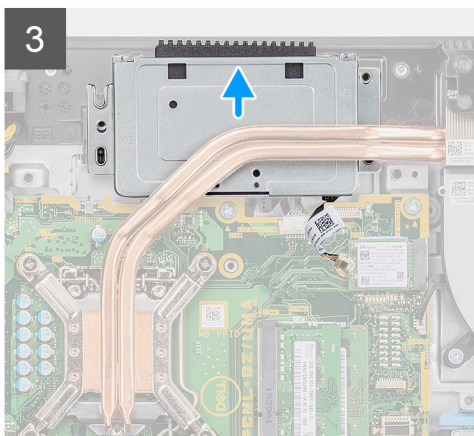
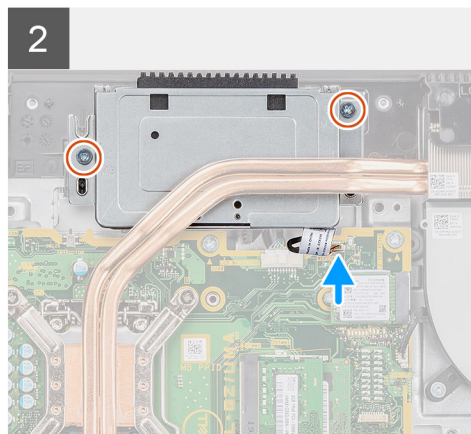
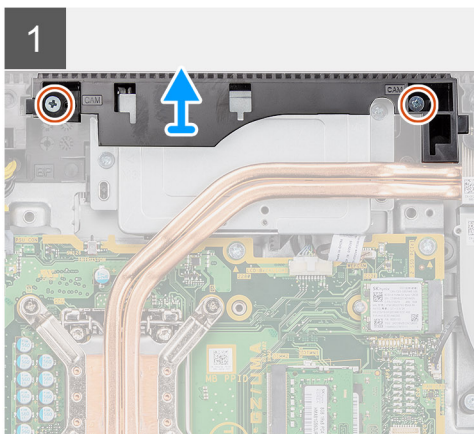
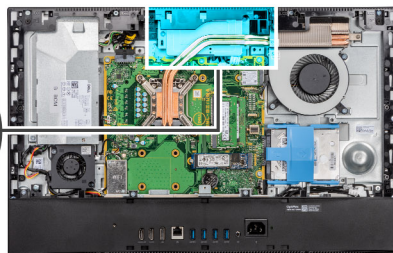
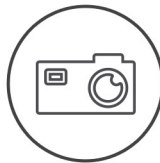

Steps

1. Remove the two screws (M3x5) that secure the camera-assembly door to the display-assembly base.
2. Disconnect the camera cable from the connector on the system board.

3. Unroute the camera cable from the routing guides on the display-assembly base.
4. Remove the two screws (M3x5) that secure the camera assembly to the middle frame.
5. Slide and remove the camera assembly from the middle frame.

Installing the camera assembly

Prerequisites

If you are replacing a component, remove the existing component before performing the installation procedure.

About this task

The following image indicates the location of the camera assembly and provides a visual representation of the installation procedure.



4x
M3x5

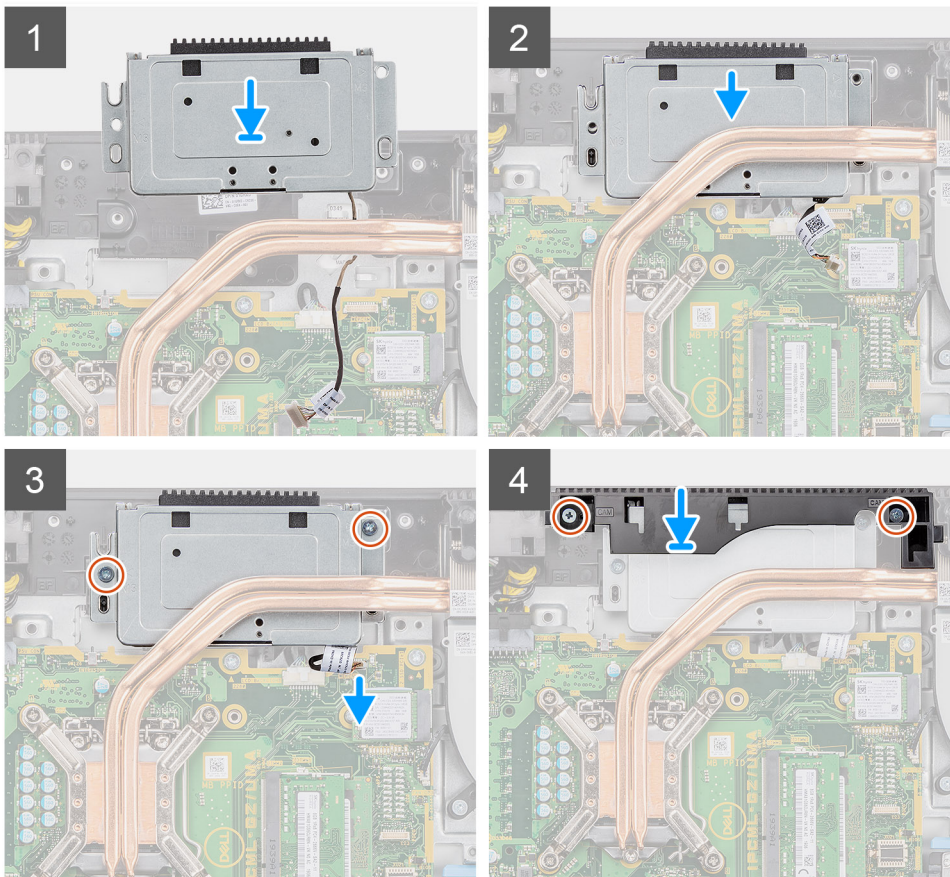
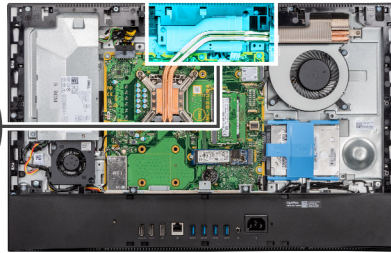

Steps

1. Slide the camera assembly on the middle frame, and align the screw holes on the camera assembly with the screw holes on the middle frame.
2. Replace the two screws (M3x5) to secure the camera assembly to the middle frame.
3. Route the camera cable through the routing guides on the display-assembly base.

4. Connect the camera cable to the system board.
5. Align the screw holes on the camera door with the screw holes on the display-assembly base.
6. Replace the two screws (M3x5) to secure the camera door to the display-assembly base.

Next steps

1. Install the [system-board shield](#).
2. Install the [back cover](#).
3. Install the [cable cover](#) (optional).
4. Install the [stand](#).
5. Follow the procedure in [After working inside your computer](#).

Bottom cover

Removing the bottom cover

Prerequisites

1. Follow the procedure in [Before working inside your computer](#).
2. Remove the [stand](#).
3. Remove the [cable cover](#) (optional).
4. Remove the [back cover](#).
5. Remove the [system-board shield](#).

About this task

The following image indicates the location of the bottom cover and provides a visual representation of the removal procedure.



4x
M3x5

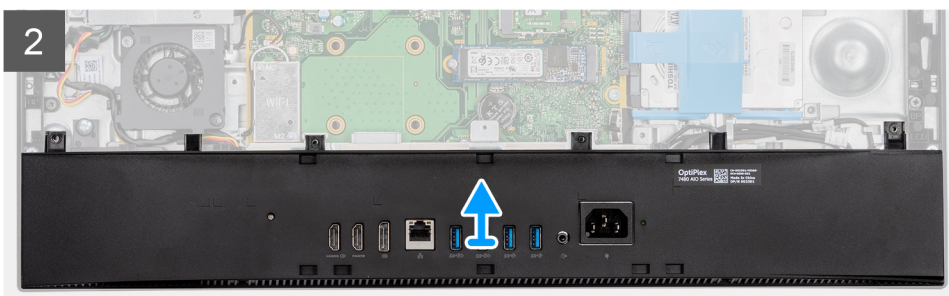
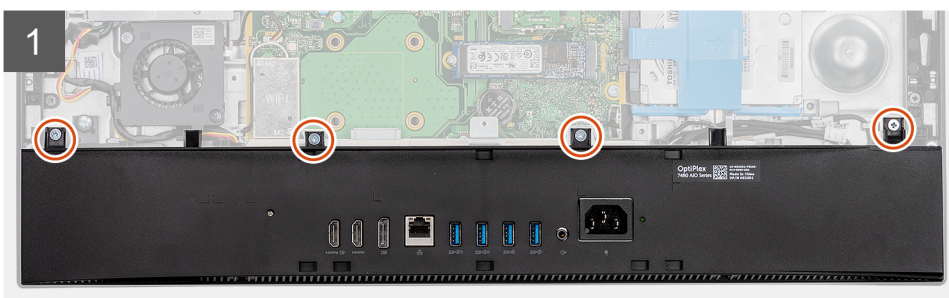
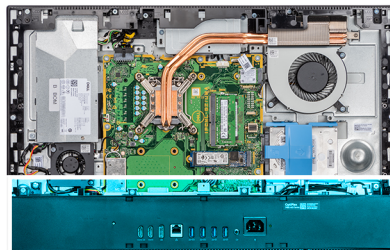

Steps

1. Remove the four screws (M3x5) that secure the bottom cover to the display-assembly base.
2. Lift the bottom cover off the display-assembly base.

Installing the bottom cover

Prerequisites

If you are replacing a component, remove the existing component before performing the installation procedure.

About this task

The following image indicates the location of the bottom cover and provides a visual representation of the installation procedure.



4x
M3x5

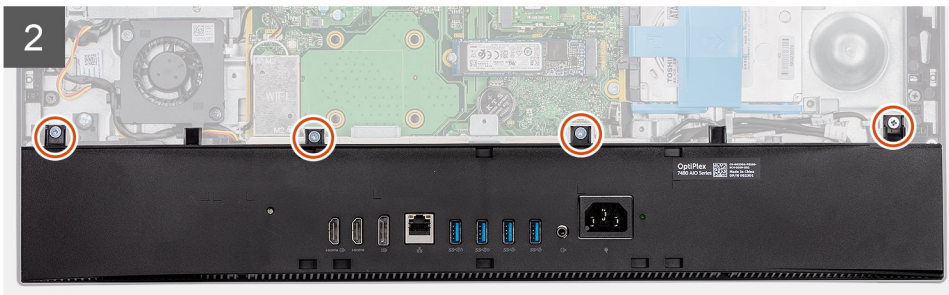
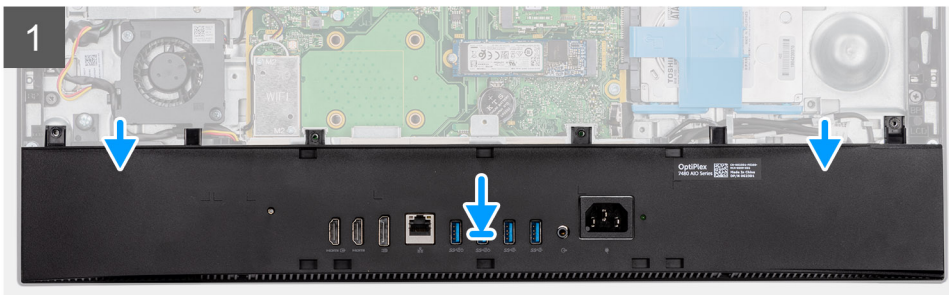
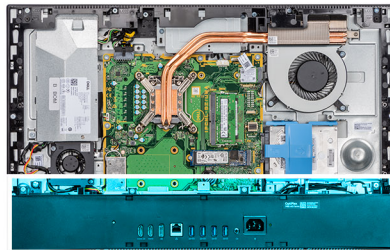

Steps

1. Align the screw holes on the bottom cover with the screw holes on the display-assembly base.
2. Replace the four screws (M3x5) to secure the bottom cover to the display-assembly base.

Next steps

1. Install the [system-board shield](#).
2. Install the [back cover](#).
3. Install the [cable cover](#) (optional).
4. Install the [stand](#).
5. Follow the procedure in [After working inside your computer](#).

Power-supply unit

Removing the power-supply unit (PSU)

Prerequisites

1. Follow the procedure in [Before working inside your computer](#).
2. Remove the [stand](#).
3. Remove the [cable cover](#) (optional).
4. Remove the [back cover](#).
5. Remove the [system-board shield](#).
6. Remove the [bottom cover](#).

About this task

The following image provides a visual representation of the PSU removal procedure.



2x
M3x5

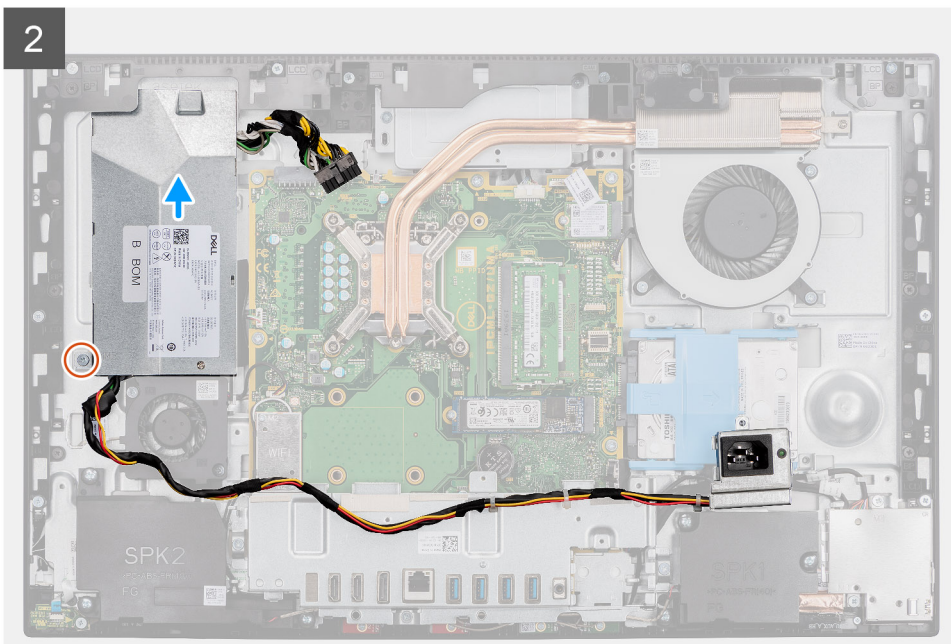
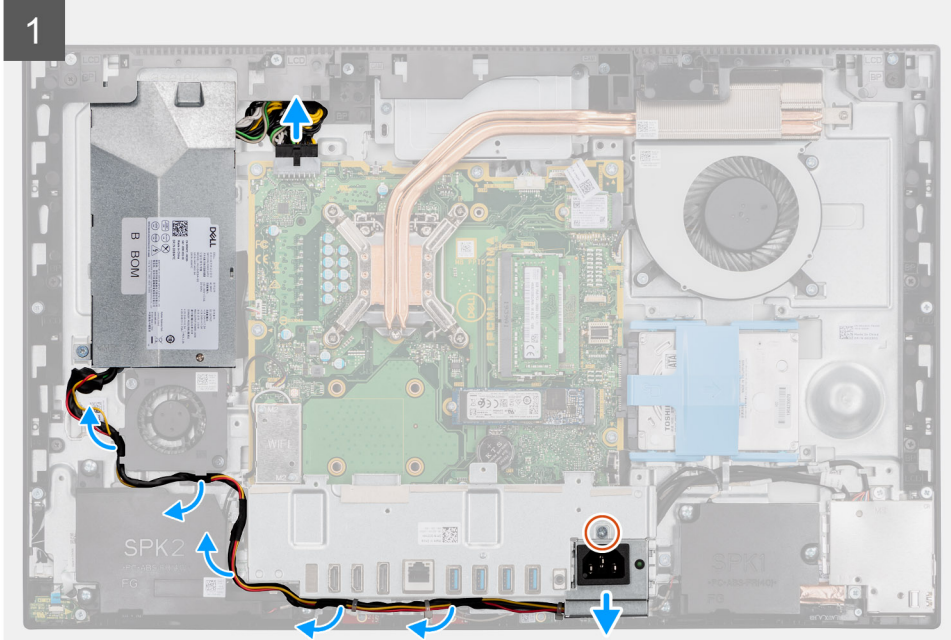

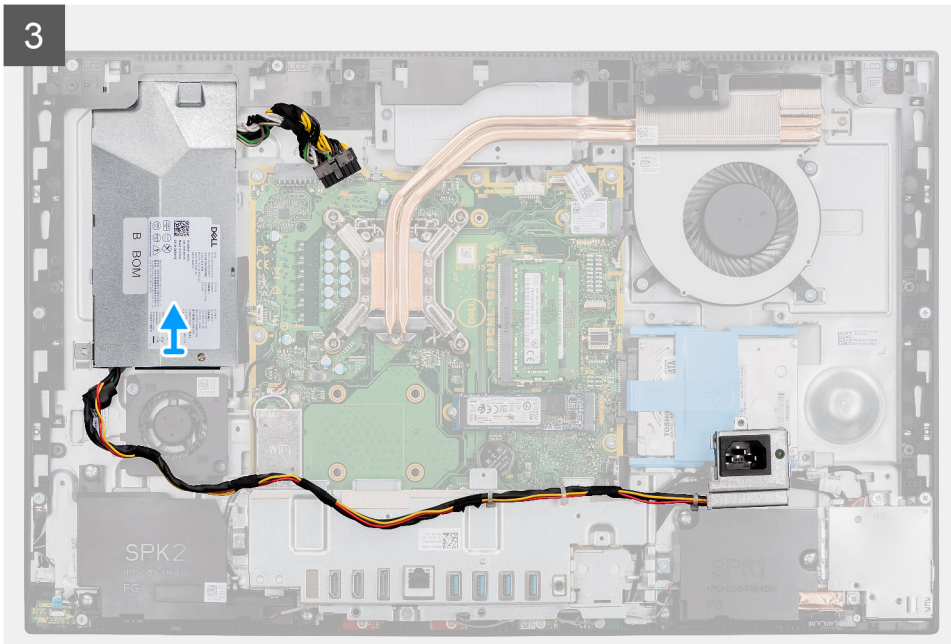

Steps

1. Remove the screw (M3x5) that secures the power-supply socket to the rear-I/O bracket.
2. Slide the power-supply socket out of the rear-I/O bracket.
3. Remove the power-supply cable from the routing guides on the rear-I/O bracket and PSU fan.
4. Disconnect the power-supply cable from the connector on the system board.
5. Remove the screw (M3x5) that secures the PSU to the display-assembly base.
6. Lift the PSU out of the system.

Installing the power-supply unit (PSU)

Prerequisites

If you are replacing a component, remove the existing component before performing the installation procedure.

About this task

The following image provides a visual representation of the PSU installation procedure.



2x
M3x5

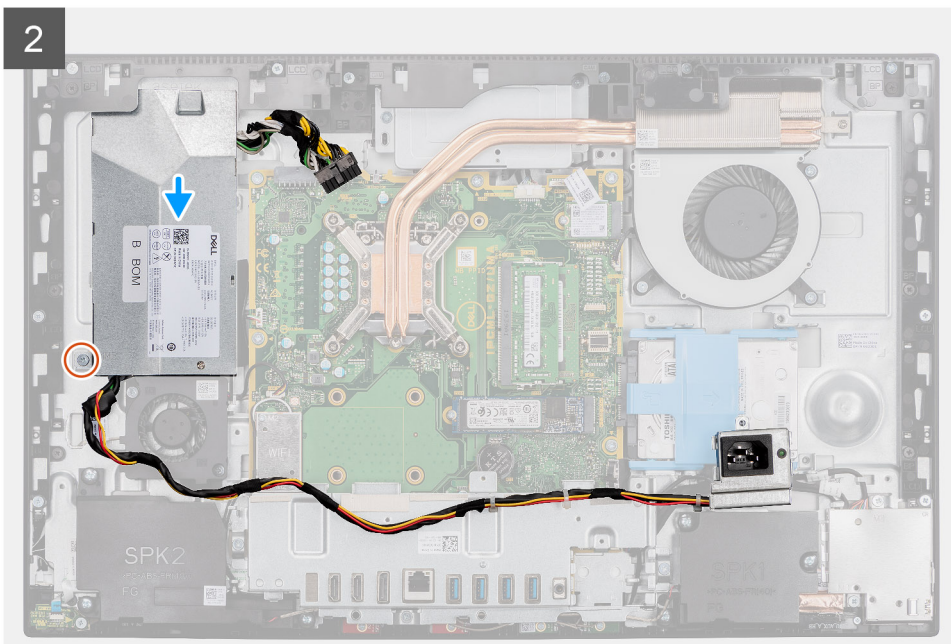
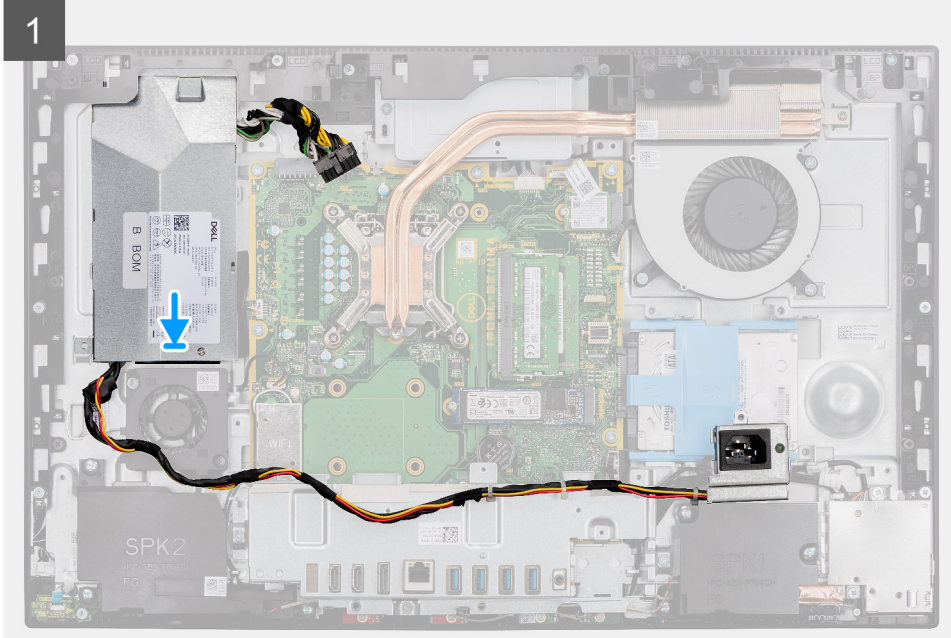

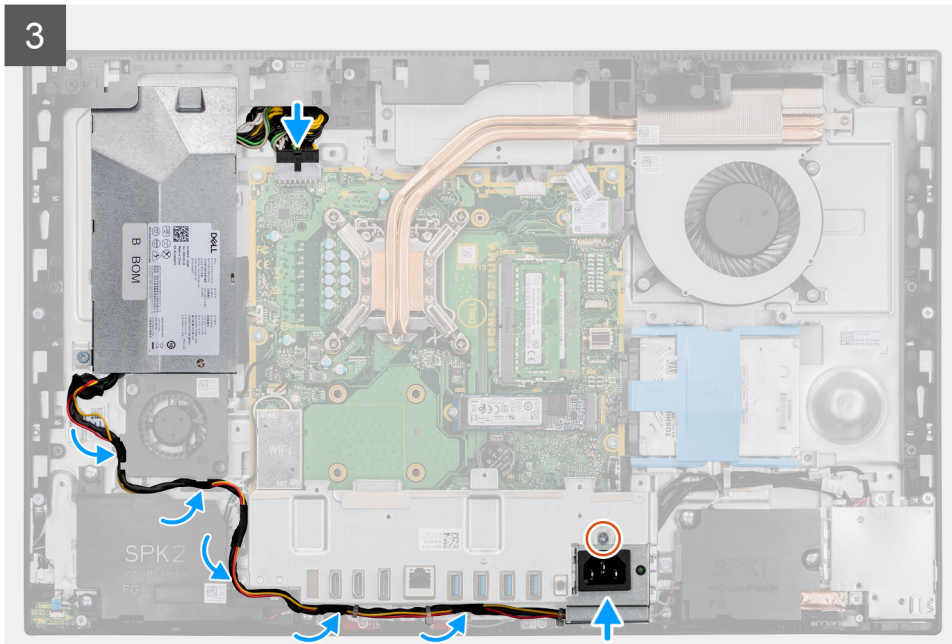

Steps

1. Align and place the PSU in the slot on the display-assembly base.
2. Replace the screw (M3x5) to secure the PSU to the display-assembly base.
3. Connect the power-supply cable to the connector on the system board.
4. Route the power-supply cable through the routing guides on the rear-I/O bracket and PSU fan.
5. Align the screw hole on the power-supply socket with the screw hole on the rear-I/O bracket, and place it in the slot on the rear-I/O bracket.
6. Replace the screw (M3x5) to secure the power-supply socket to the rear-I/O bracket.

Next steps

1. Install the [bottom cover](#).
2. Install the [system-board shield](#).
3. Install the [back cover](#).
4. Install the [cable cover](#) (optional).
5. Install the [stand](#).
6. Follow the procedure in [After working inside your computer](#).

Power-supply fan

Removing the PSU fan

Prerequisites

1. Follow the procedure in [Before working inside your computer](#).
2. Remove the [stand](#).
3. Remove the [cable cover](#) (optional).
4. Remove the [back cover](#).
5. Remove the [system-board shield](#).
6. Remove the [bottom cover](#).

About this task

The following image indicates the location of the PSU fan and provides a visual representation of the removal procedure.



2x
M3x5

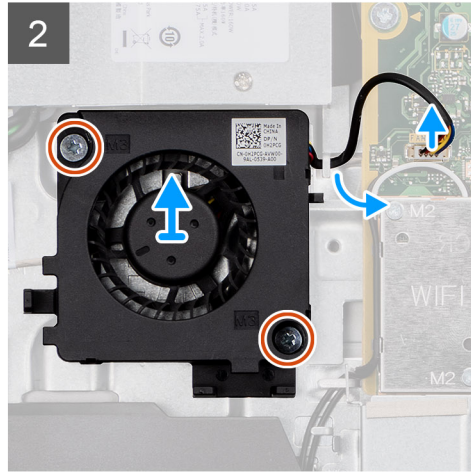
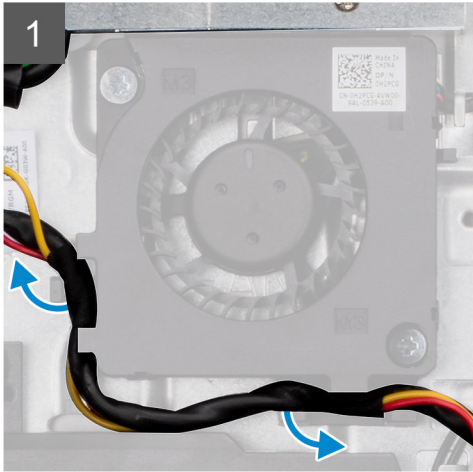
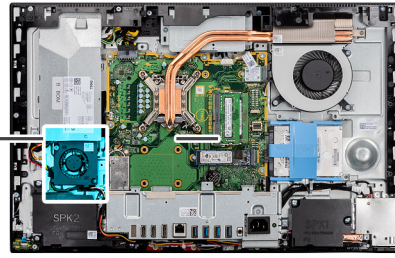
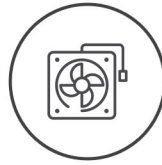

Steps

1. Remove the power-supply cable from the routing guides on the PSU fan.
2. Disconnect the PSU-fan cable from the system board.
3. Remove the two screws (M3x5) that secure the PSU fan to the display-assembly base.
4. Lift the PSU fan from the display-assembly base.

Installing the PSU fan

Prerequisites

If you are replacing a component, remove the existing component before performing the installation procedure.

About this task

The following image indicates the location of the PSU fan and provides a visual representation of the installation procedure.



2x
M3x5

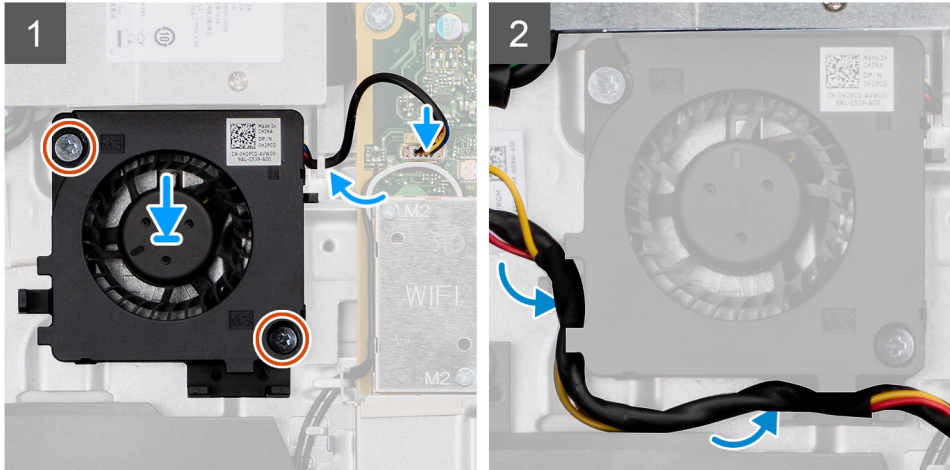
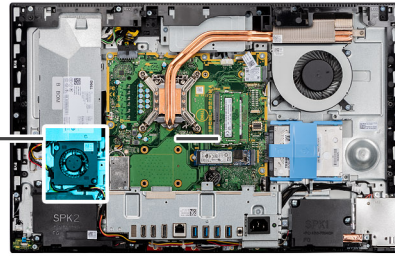
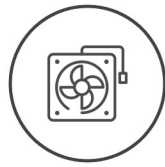

Steps

1. Align the screw holes on the PSU fan with the screw holes on the display-assembly base.
2. Replace the two screws (M3x5) to secure the PSU fan to the display-assembly base.
3. Connect the PSU-fan cable to the connector on the system board.
4. Route the power-supply cable through the routing guides on the PSU fan.

Next steps

1. Install the [bottom cover](#).
2. Install the [system-board shield](#).
3. Install the [back cover](#).
4. Install the [cable cover](#) (optional).
5. Install the [stand](#).
6. Follow the procedure in [After working inside your computer](#).

Heat sink

Removing the heat sink—UMA

Prerequisites

1. Follow the procedure in [Before working inside your computer](#).
2. Remove the [stand](#).
3. Remove the [cable cover](#) (optional).
4. Remove the [back cover](#).
5. Remove the [system-board shield](#).
6. Remove the [system fan](#).

About this task

The following image indicates the location of the heat sink and provides a visual representation of the removal procedure.



5x

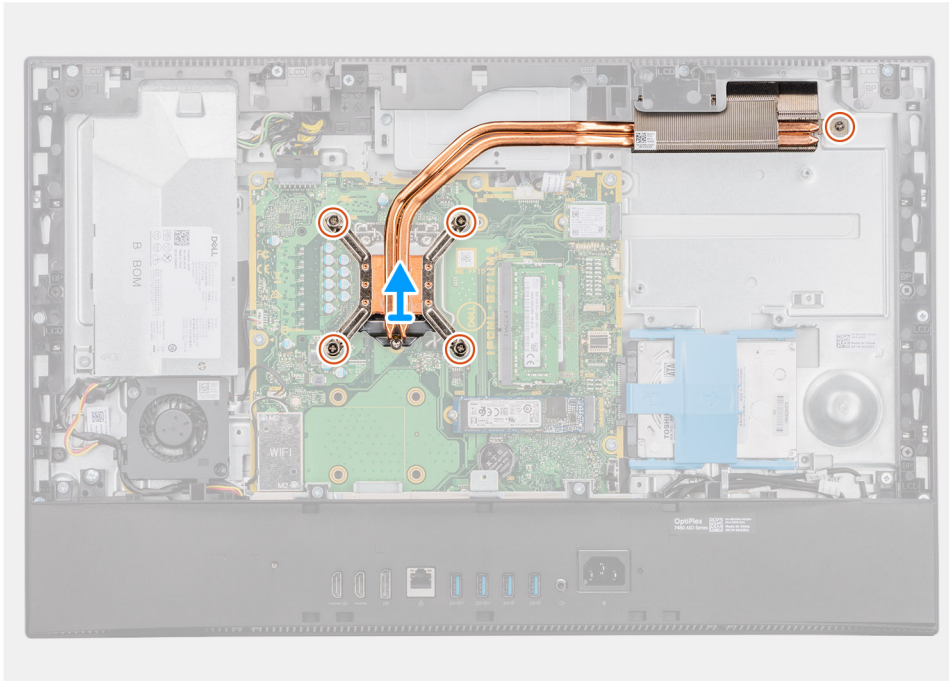
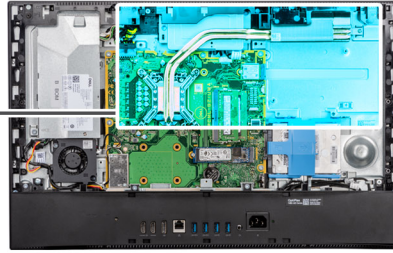

Steps

1. In reverse sequential order (as indicated on the heat sink), loosen the five captive screws that secure the heat sink to the system board and the display-assembly base.
2. Slide and lift the heat sink off the system board and display-assembly base.

Installing the heat sink—UMA

Prerequisites

If you are replacing a component, remove the existing component before performing the installation procedure.

 **NOTE:** If either the system board or the heat sink is replaced, use the thermal pad/paste provided in the kit to ensure that thermal conductivity is achieved.

About this task

The following image indicates the location of the heat sink and provides a visual representation of the installation procedure.



5x

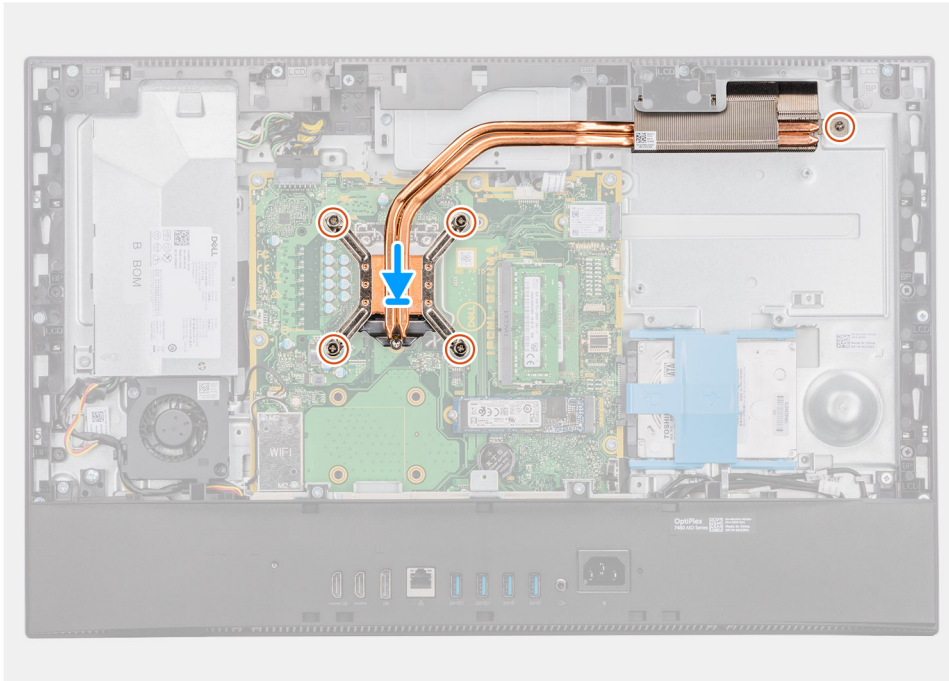
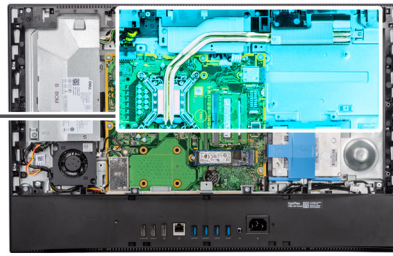

Steps

1. Align the screw holes on the heat sink with the screw holes on the system board and the display-assembly base.
2. In sequential order (as indicated on the heat sink), tighten the five captive screws that secure the heat sink to the system board and display-assembly base.

Next steps

1. Install the [system fan](#).
2. Install the [system-board shield](#).
3. Install the [back cover](#).
4. Install the [cable cover](#) (optional).
5. Install the [stand](#).
6. Follow the procedure in [After working inside your computer](#).

Removing the heat sink—discrete

Prerequisites

1. Follow the procedure in [Before working inside your computer](#).
2. Remove the [stand](#).
3. Remove the [cable cover](#) (optional).
4. Remove the [back cover](#).
5. Remove the [system-board shield](#).
6. Remove the [system fan](#).

About this task

The following image provides a visual representation of the heat sink removal procedure.



9x

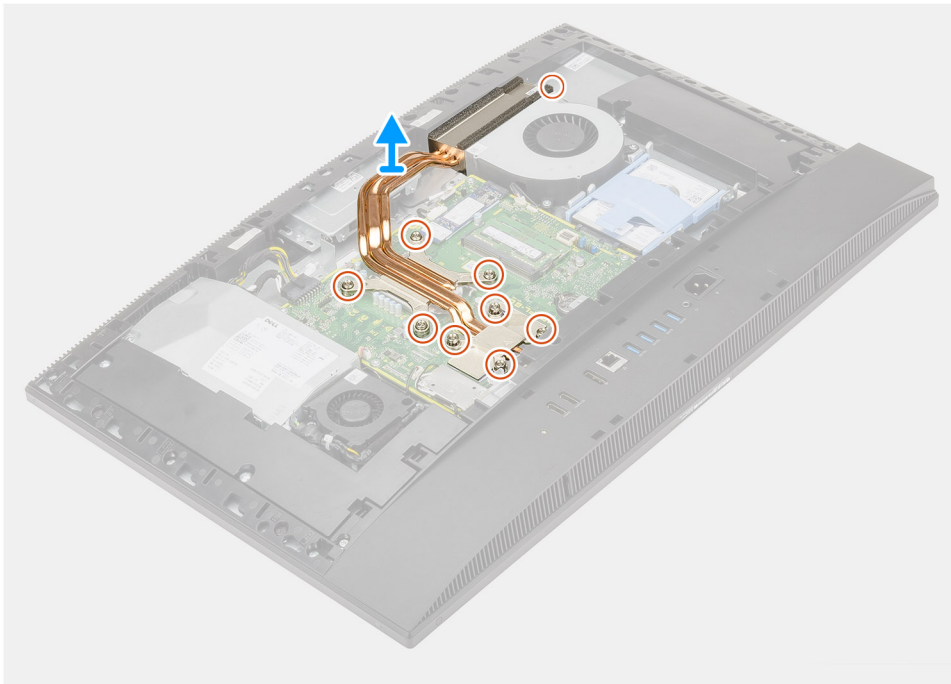

Steps

1. In reverse sequential order (as indicated on the heat sink), loosen the nine captive screws that secure the heat sink to the system board and the display-assembly base.
2. Slide and lift the heat sink off the system board and display-assembly base.

Installing the heat sink—discrete

Prerequisites

If you are replacing a component, remove the existing component before performing the installation procedure.

NOTE: If either the system board or the heat sink is replaced, use the thermal pad/paste provided in the kit to ensure that thermal conductivity is achieved.

About this task

The following image provides a visual representation of the heat sink installation procedure.



9x

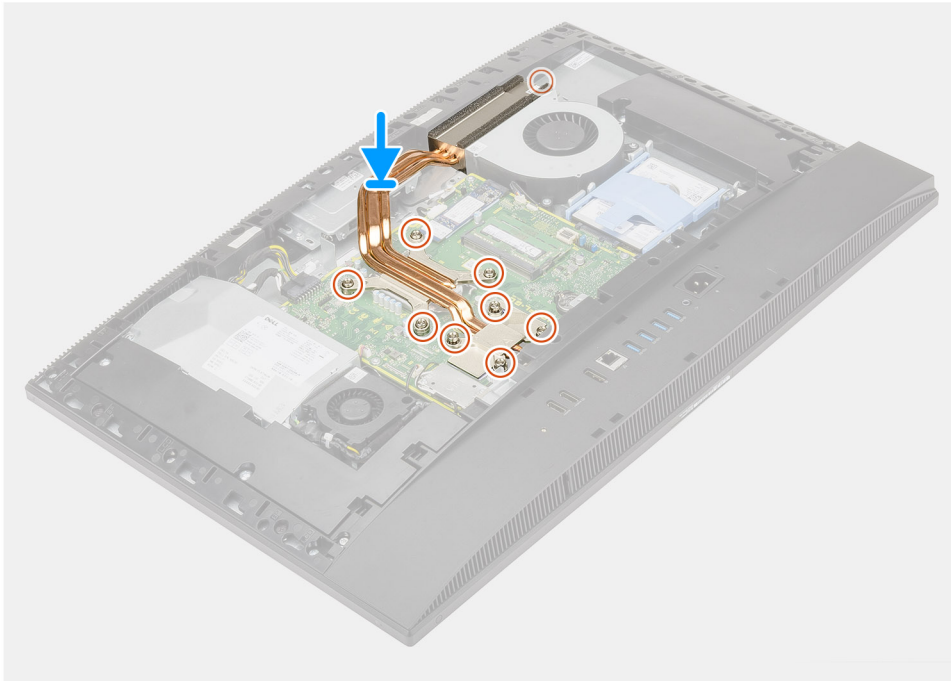

Steps

1. Align the screw holes on the heat sink with the screw holes on the system board and the display-assembly base.
2. In sequential order (as indicated on the heat sink), tighten the nine captive screws to secure the heat sink to the system board and display-assembly base.

Next steps

1. Install the [system fan](#).
2. Install the [system-board shield](#).
3. Install the [back cover](#).
4. Install the [cable cover](#) (optional).
5. Install the [stand](#).
6. Follow the procedure in [After working inside your computer](#).

Processor

Removing the processor

Prerequisites

1. Follow the procedure in [Before working inside your computer](#).
2. Remove the [stand](#).
3. Remove the [cable cover](#) (optional).
4. Remove the [back cover](#).
5. Remove the [system-board shield](#).

6. Remove the [heat sink](#).

About this task

The following image indicates the location of the processor and provides a visual representation of the removal procedure.

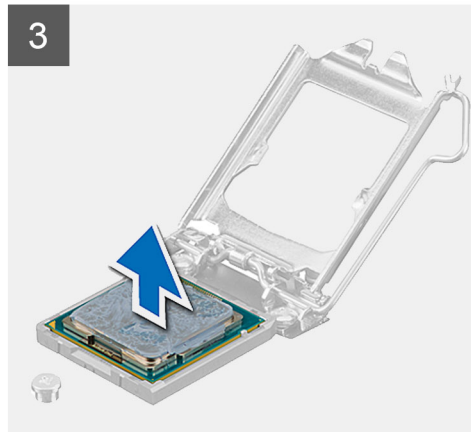
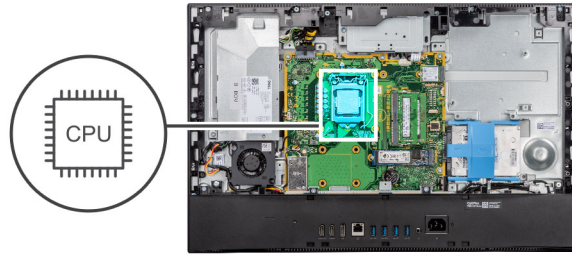

Steps

1. Press the release lever down and then push it away from the processor to release it from the securing tab.
2. Extend the release lever completely, and open the processor cover.

CAUTION: When removing the processor, do not touch any of the pins inside the socket or allow any objects to fall on the pins in the socket.

3. Gently lift the processor from the processor socket.

Installing the processor

Prerequisites

If you are replacing a component, remove the existing component before performing the installation procedure.

About this task

The following image indicates the location of the processor and provides a visual representation of the installation procedure.

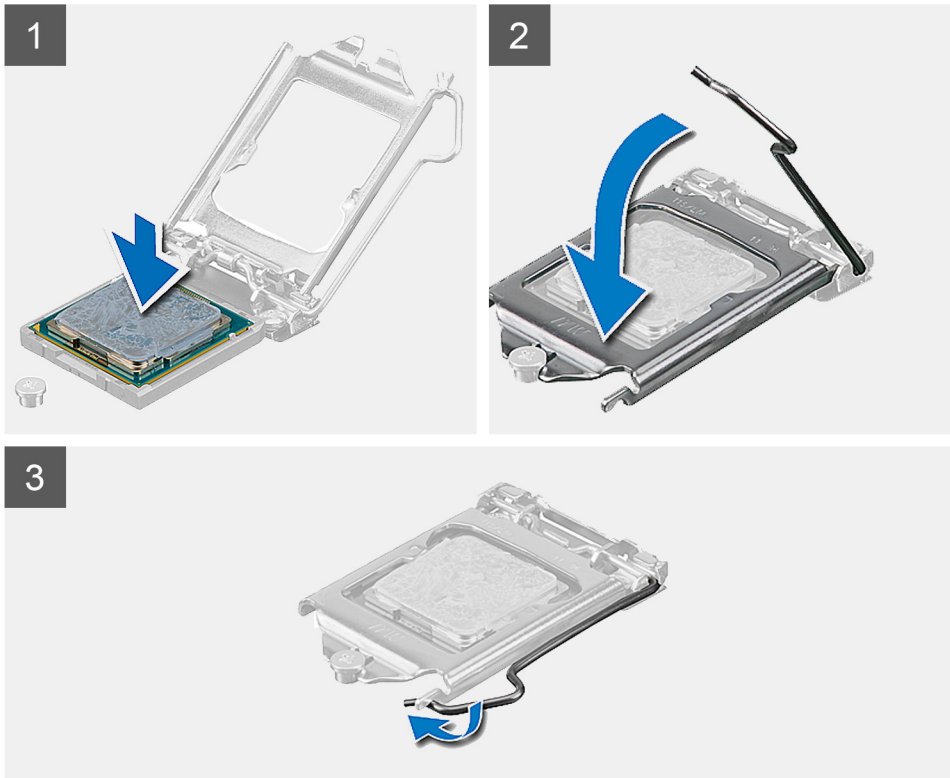
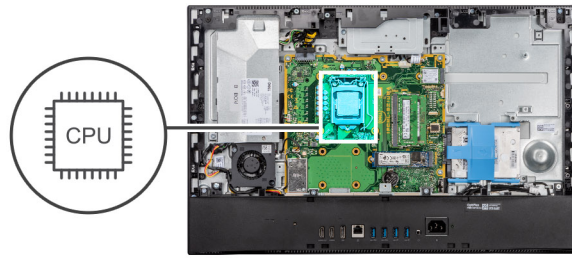

Steps

1. Ensure that the release lever on the processor socket is fully extended in the open position.

i **NOTE:** The pin-1 corner of the processor has a triangle that aligns with the triangle on the pin-1 corner on the processor socket. When the processor is properly seated, all four corners are aligned at the same height. If one or more corners of the processor are higher than the others, the processor is not seated properly.

2. Align the notches on the processor with the tabs on the processor socket and place the processor in the processor socket.

⚠ CAUTION: Ensure that the processor-cover notch is positioned underneath the alignment post.

3. When the processor is fully seated in the socket, pivot the release-lever down and place it under the tab on the processor cover.

Next steps

1. Install the [heat sink](#).
2. Install the [system-board shield](#).
3. Install the [back cover](#).
4. Install the [cable cover](#) (optional).
5. Install the [stand](#).
6. Follow the procedure in [After working inside your computer](#).

Rear-I/O bracket

Removing the rear-I/O bracket

Prerequisites

1. Follow the procedure in [Before working inside your computer](#).
2. Remove the [stand](#).
3. Remove the [cable cover](#) (optional).
4. Remove the [back cover](#).
5. Remove the [system-board shield](#).
6. Remove the [bottom cover](#).

About this task

The following image indicates the location of the rear-I/O bracket and provides a visual representation of the removal procedure.



4x
M3X5

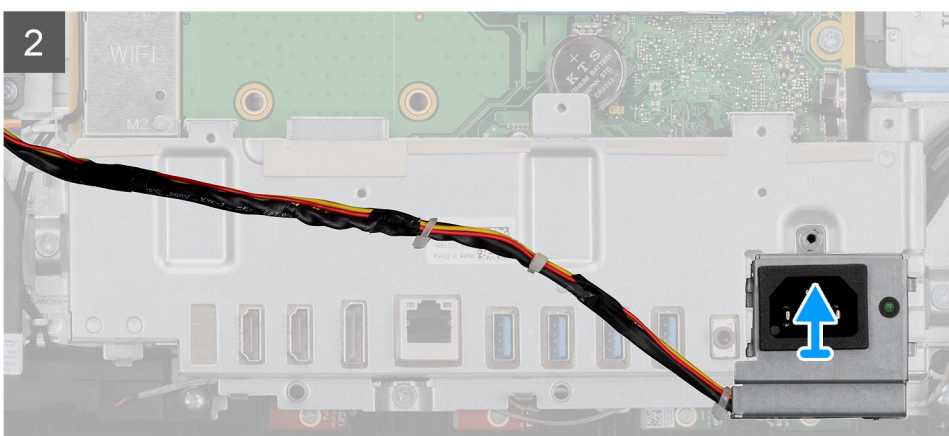
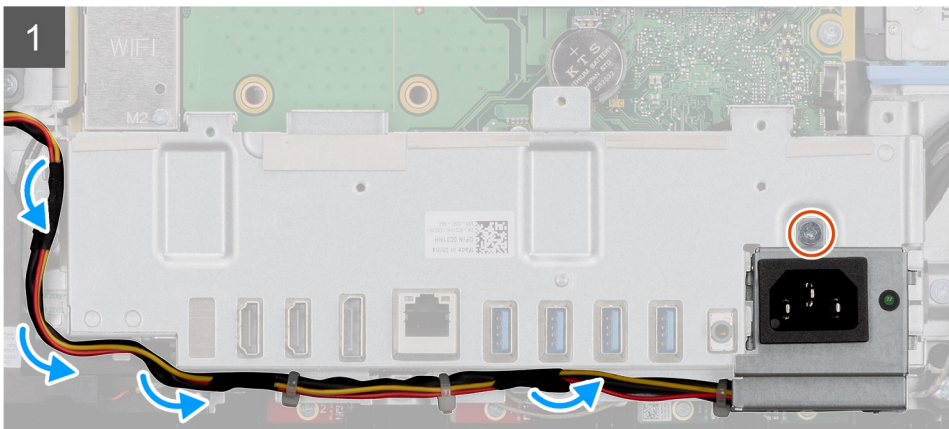
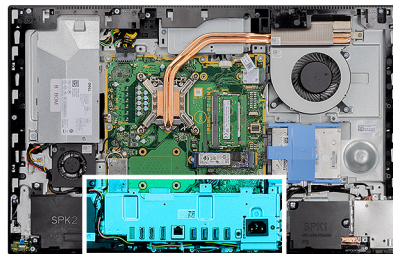

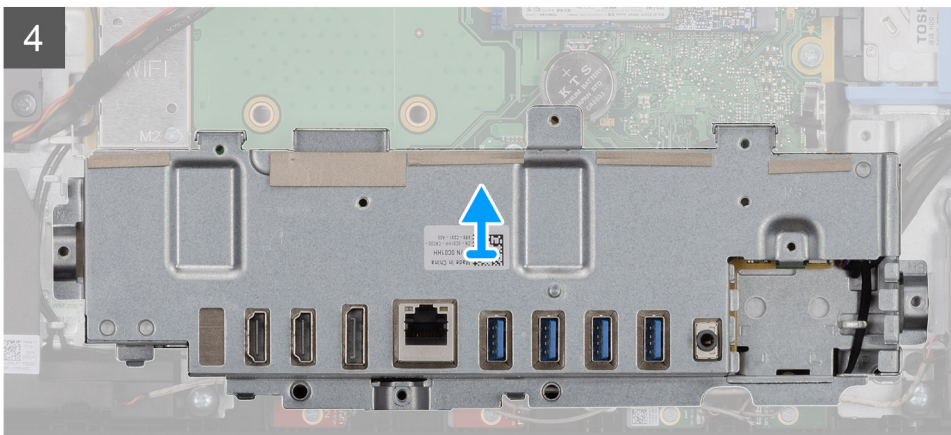
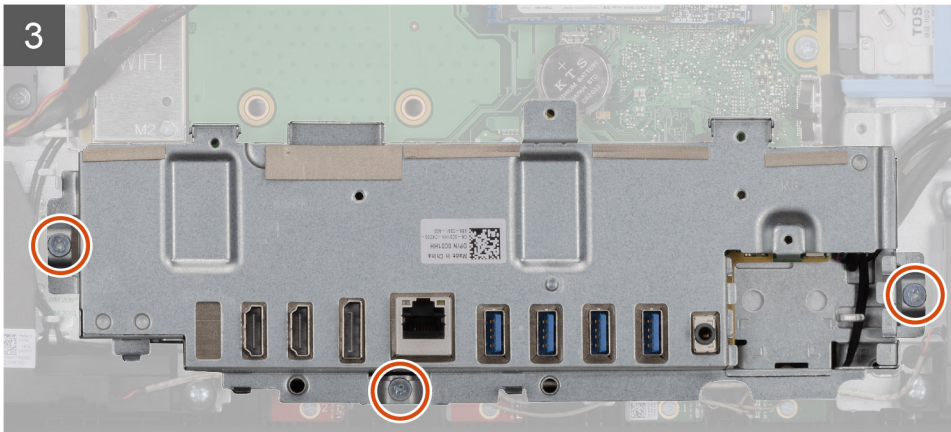

Steps

1. Remove the screw (M3x5) that secures the power-supply socket to the rear-I/O bracket.
2. Remove the power-supply cable from the routing guide on the rear-I/O bracket.
3. Slide and remove the power-supply socket away from the rear-I/O bracket.
4. Remove the three screws (M3x5) that secure the rear-I/O bracket to the display-assembly base.
5. Lift the rear-I/O bracket off the display-assembly base.

Installing the rear-I/O bracket

Prerequisites

If you are replacing a component, remove the existing component before performing the installation procedure.

About this task

The following image indicates the location of the rear-I/O bracket and provides a visual representation of the installation procedure.



4x
M3X5

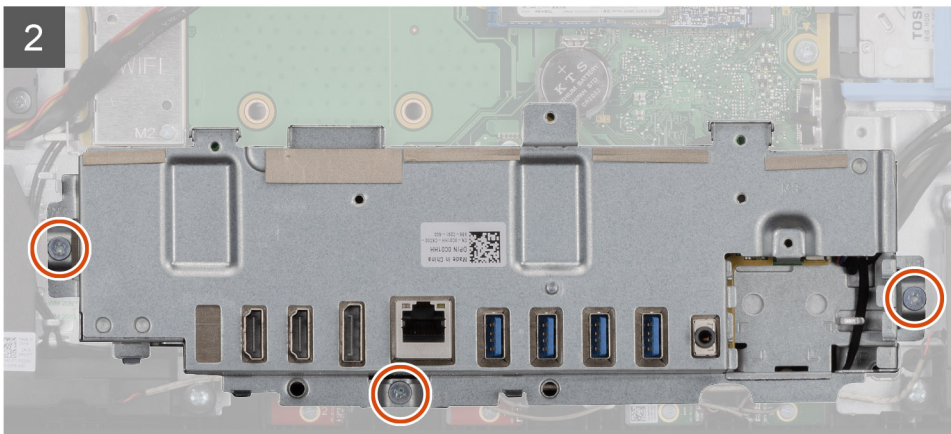
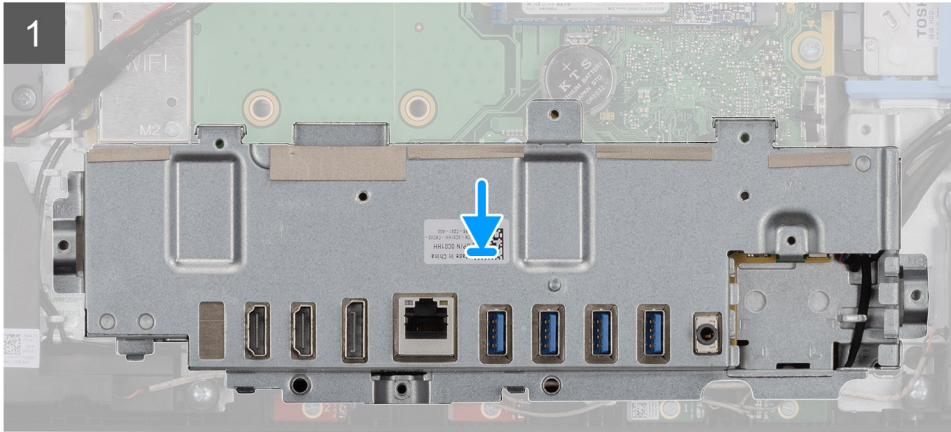
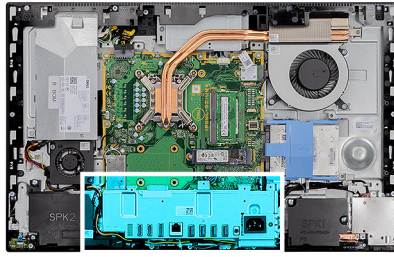

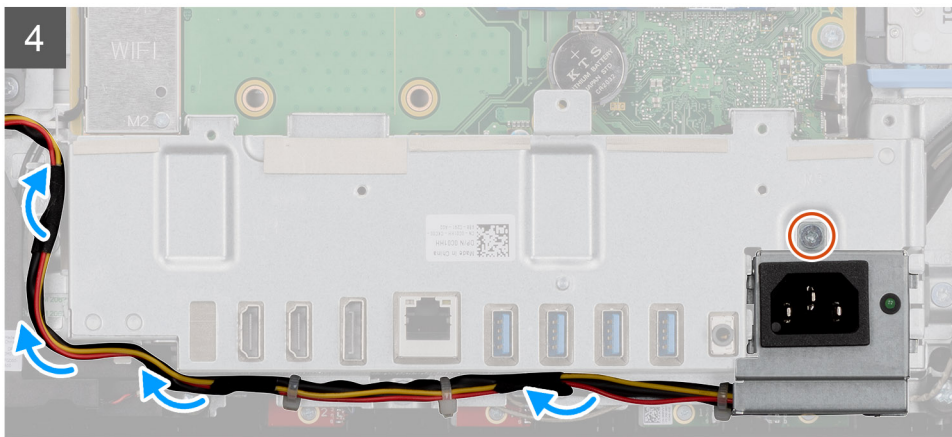
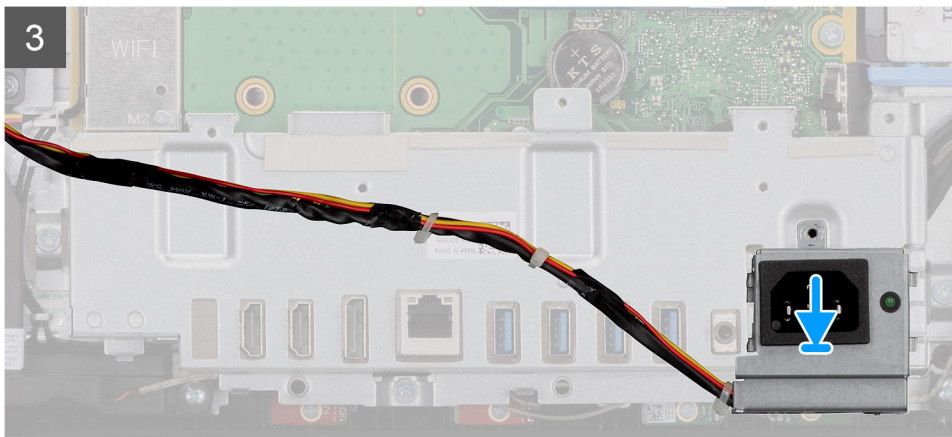

Steps

1. Align the screw holes on the rear-I/O bracket with the screw holes on the display-assembly base.
2. Replace the three screws (M3x5) to secure the rear-I/O bracket to the display-assembly base.
3. Route the power-supply cables through the routing guide on the rear-I/O bracket.
4. Align the screw hole on the power-supply socket with the screw hole on the rear-I/O bracket, and place it in the slot on the rear-I/O bracket.
5. Replace the screw (M3x5) to secure the power-supply socket to the rear-I/O bracket.

Next steps

1. Install the [bottom cover](#).
2. Install the [system-board shield](#).
3. Install the [back cover](#).
4. Install the [cable cover](#) (optional).
5. Install the [stand](#).
6. Follow the procedure in [After working inside your computer](#).

System board

Removing the system board

Prerequisites

1. Follow the procedure in [Before working inside your computer](#).

i **NOTE:** Your computer's Service Tag is stored in the system board. You must enter the Service Tag in the BIOS setup program after you replace the system board.

NOTE: Replacing the system board removes any changes you have made to the BIOS using the BIOS setup program. You must make the appropriate changes again after you replace the system board.

2. Remove the [stand](#).
3. Remove the [cable cover](#) (optional).
4. Remove the [back cover](#).
5. Remove the [hard drive](#).
6. Remove the [system-board shield](#).
7. Remove the [memory modules](#).
8. Remove the [wireless card](#).
9. Remove the [M.2 2230 solid-state drive](#).
10. Remove the [M.2 2280 solid-state drive/Intel Optane memory](#).
11. Remove the [heat sink](#).
12. Remove the [processor](#).
13. Remove the [coin-cell battery](#).
14. Remove the [bottom cover](#).
15. Remove the [rear-I/O bracket](#).

About this task

The following image indicates the connectors on your system board.

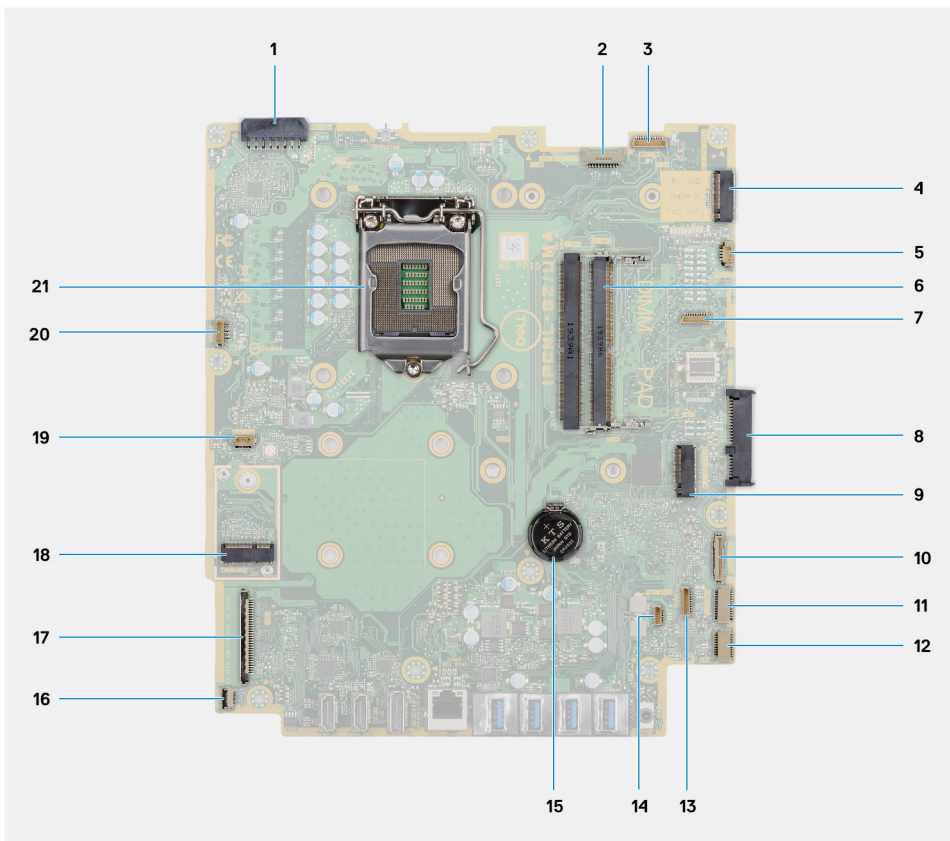

1. Power-supply unit (PSU) cable connector
2. Display back-light cable connector
3. Camera cable connector
4. M.2 2230/2280 solid-state drive/Intel Optane PCIe connector
5. System-fan cable connector
6. Memory modules
7. LPC debug card connector
8. Hard-drive connector
9. M.2 2230/2280 solid-state drive PCIe connector
10. SIO-signal cable connector

11. SIO-power cable connector
12. Audio-board cable connector
13. Microphone-module cable connector
14. Speaker cable connector
15. Coin-cell battery
16. Power-button cable connector
17. Display cable connector
18. M.2 WLAN connector
19. PSU-fan cable connector
20. Touchscreen cable connector
21. Processor

The following image indicates the location of the system board and provides a visual representation of the removal procedure.



9x
M3X5

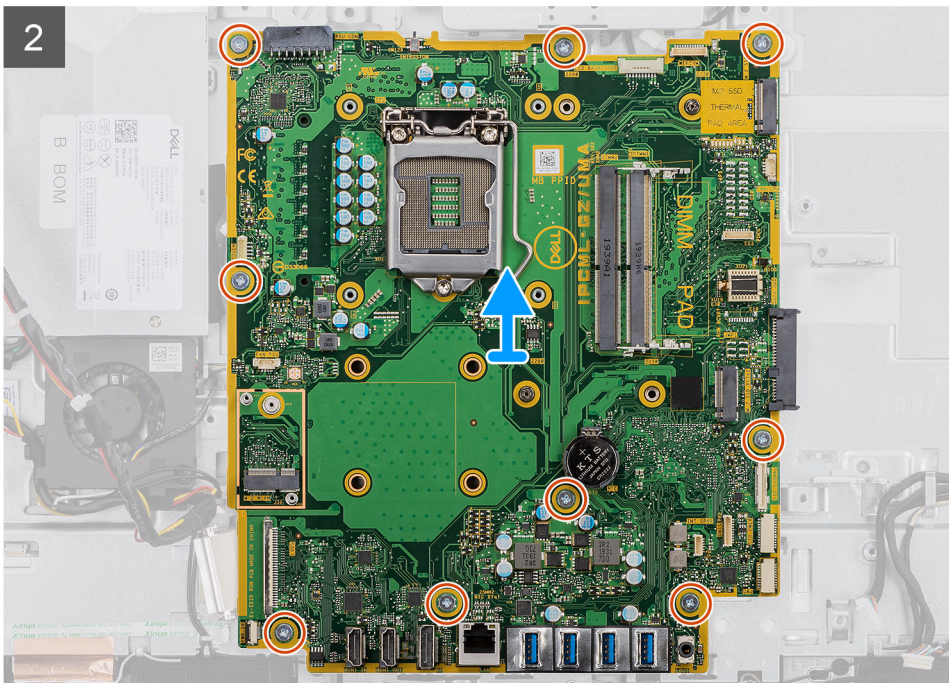
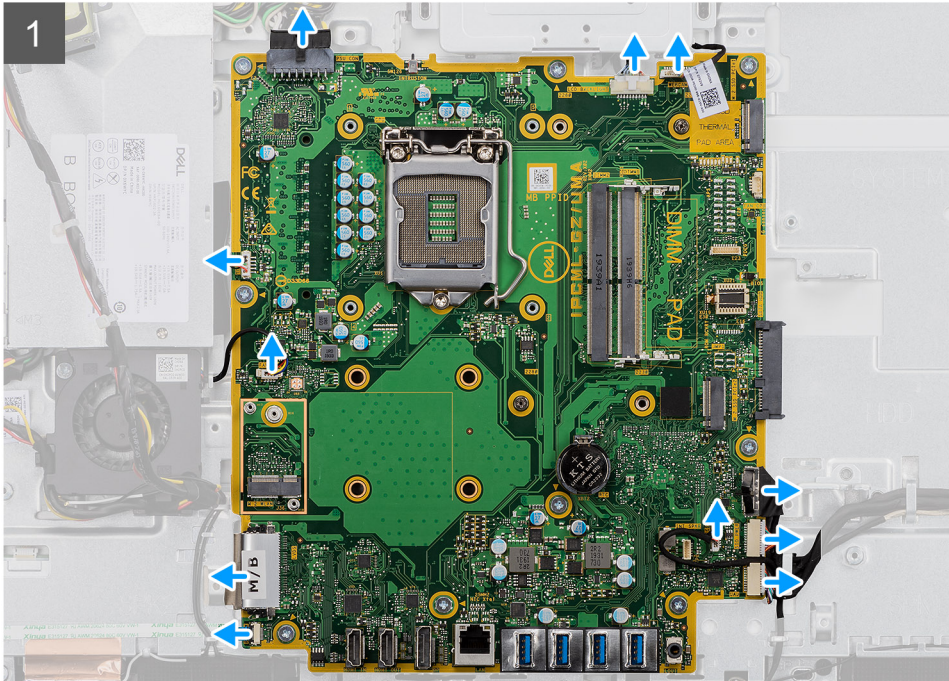
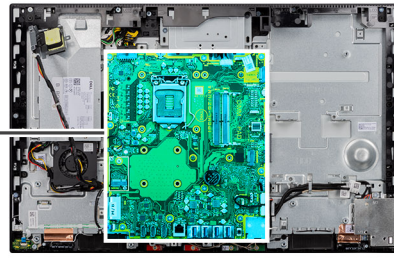
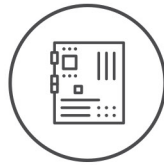

Steps

1. Disconnect the display back-light cable from the connector on the system board.
2. Disconnect the display cable from the connector on the system board.
3. Disconnect the PSU cable from the connector on the system board.

4. Disconnect the PSU fan cable from the connector on the system board.
5. Open the latch and disconnect the power-button board cable from the connector on the system board.
6. Disconnect the speaker cable from the connector on the system board.
7. Disconnect the microphone-module cable from the connector on the system board.
8. Disconnect the SIO-signal cable from the connector on the system board.
9. Disconnect the SIO-power cable from the connector on the system board.
10. Disconnect the audio-board cable from the connector on the system board.
11. Disconnect the system fan cable from the connector on the system board.
12. Disconnect the touchscreen cable from the connector on the system board.
13. Disconnect the camera cable from the connector on the system board.
14. Remove the nine screws (M3x5) that secure the system board to the display-assembly base.
15. Lift and remove the system board from the display-assembly base.

Installing the system board

Prerequisites

If you are replacing a component, remove the existing component before performing the installation procedure.

About this task

The following image indicates the connectors on your system board.

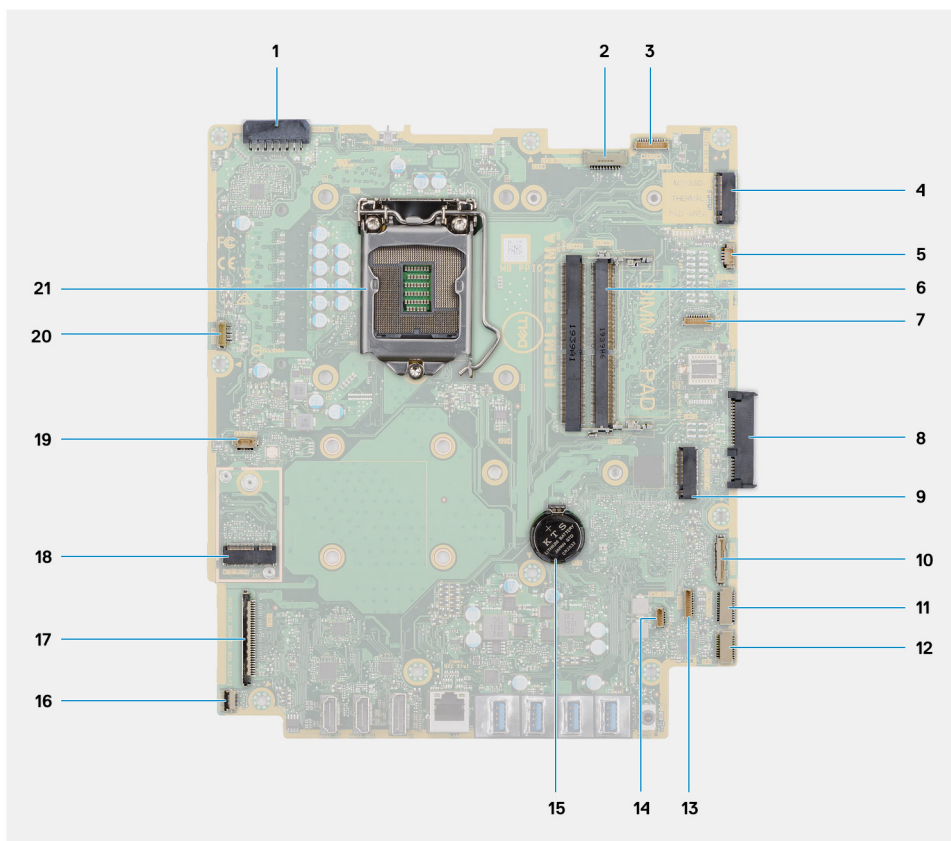

1. Power-supply unit (PSU) cable connector
2. Display back-light cable connector
3. Camera cable connector
4. M.2 2230/2280 solid-state drive/Intel Optane PCIe connector
5. System-fan cable connector
6. Memory modules
7. LPC debug card connector

- 8. Hard-drive connector
- 9. M.2 2230/2280 solid-state drive PCIe connector
- 10. SIO-signal cable connector
- 11. SIO-power cable connector
- 12. Audio-board cable connector
- 13. Microphone-module cable connector
- 14. Speaker cable connector
- 15. Coin-cell battery
- 16. Power-button cable connector
- 17. Display cable connector
- 18. M.2 WLAN connector
- 19. PSU-fan cable connector
- 20. Touchscreen cable connector
- 21. Processor

The following image indicates the location of the system board and provides a visual representation of the installation procedure.



9x
M3X5

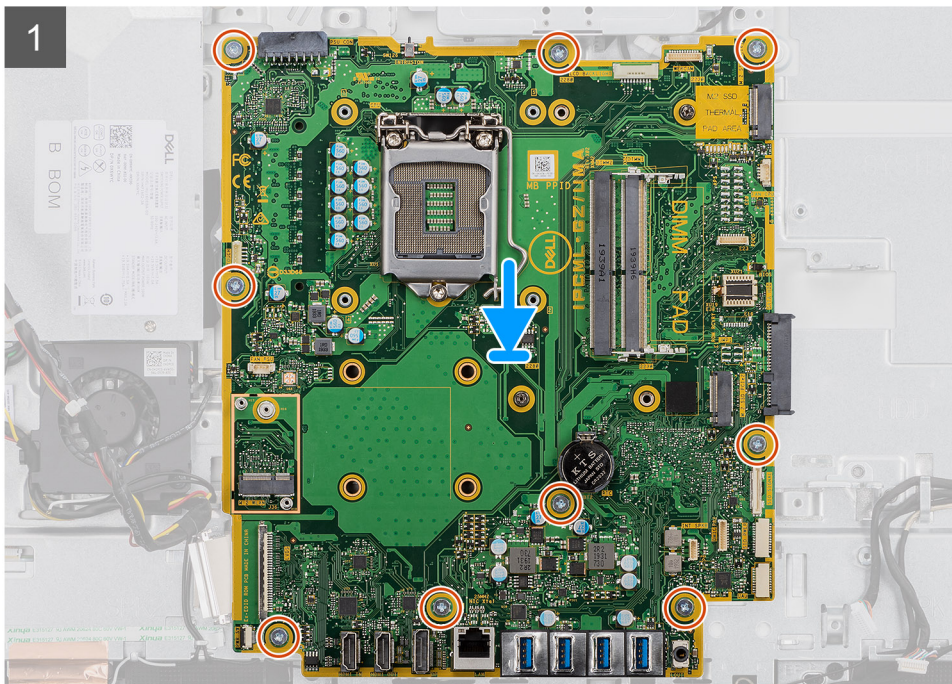
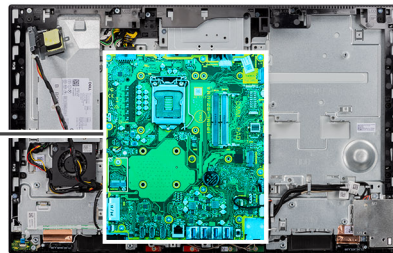

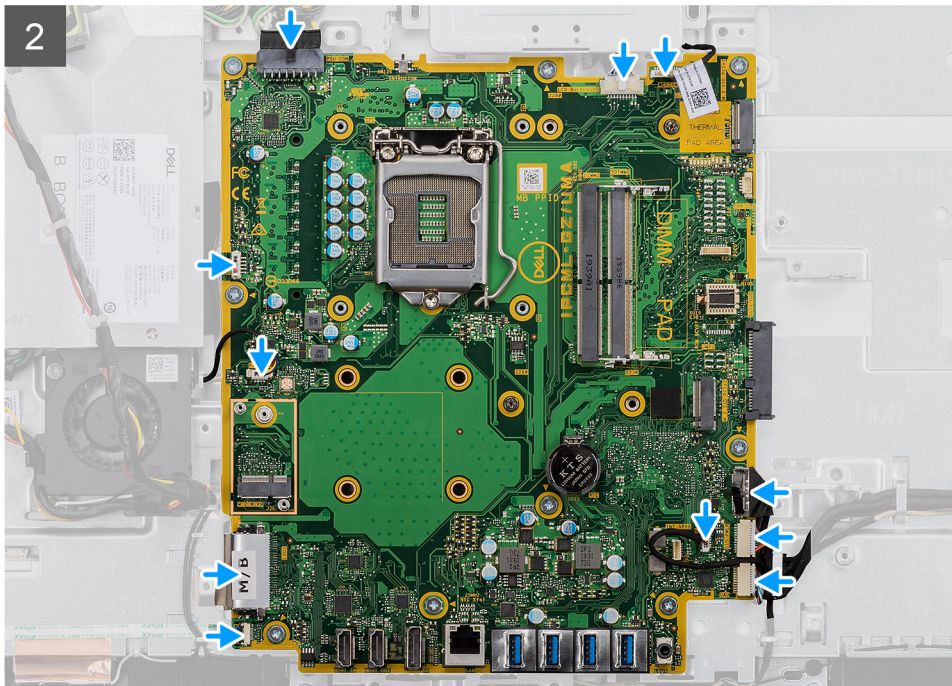

Steps

1. Align the screw holes on the system board with the screw holes on the display-assembly base.
2. Replace the nine screws (M3x5) to secure the system board to the display-assembly base.
3. Connect the camera cable to the connector system board.
4. Connect the touchscreen cable to the system board.
5. Connect the system fan cable to the system board.
6. Connect the audio-board cable to the system board.
7. Connect the SIO-power cable to the system board.
8. Connect the SIO-signal cable to the system board.
9. Connect the microphone-module cable to the system board.
10. Connect the speaker cable to the system board.
11. Connect the power-button board cable to the system board and close the latch to secure the cable.
12. Connect the PSU-fan cable to the system board.
13. Connect the PSU cable to the system board.
14. Connect the display cable to the system board.
15. Connect the display back-light cable to the system board.

Next steps

1. Install the [rear-I/O bracket](#).
2. Install the [bottom cover](#).
3. Install the [coin-cell battery](#).
4. Install the [processor](#).
5. Install the [heat sink](#).
6. Install the [M.2 2280 solid-state drive/Intel Optane memory](#).
7. Install the [M.2 2230 solid-state drive](#).
8. Install the [wireless card](#).
9. Install the [memory modules](#).
10. Install the [system-board shield](#).
11. Install the [hard drive](#).
12. Install the [back cover](#).
13. Install the [cable cover](#) (optional).
14. Install the [stand](#).

15. Follow the procedure in [After working inside your computer](#).

NOTE: Your computer's Service Tag is stored in the system board. You must enter the Service Tag in the BIOS setup program after you replace the system board.

NOTE: Replacing the system board removes any changes you have made to the BIOS using the BIOS setup program. You must make the appropriate changes again after you replace the system board.

Speakers

Removing the speakers

Prerequisites

1. Follow the procedure in [Before working inside your computer](#).
2. Remove the [stand](#).
3. Remove the [cable cover](#) (optional).
4. Remove the [back cover](#).
5. Remove the [system-board shield](#).
6. Remove the [bottom cover](#).
7. Remove the [rear-I/O bracket](#).

About this task

The following image indicates the location of the speakers and provides a visual representation of the removal procedure.



6x
M3 4+7.1xZN

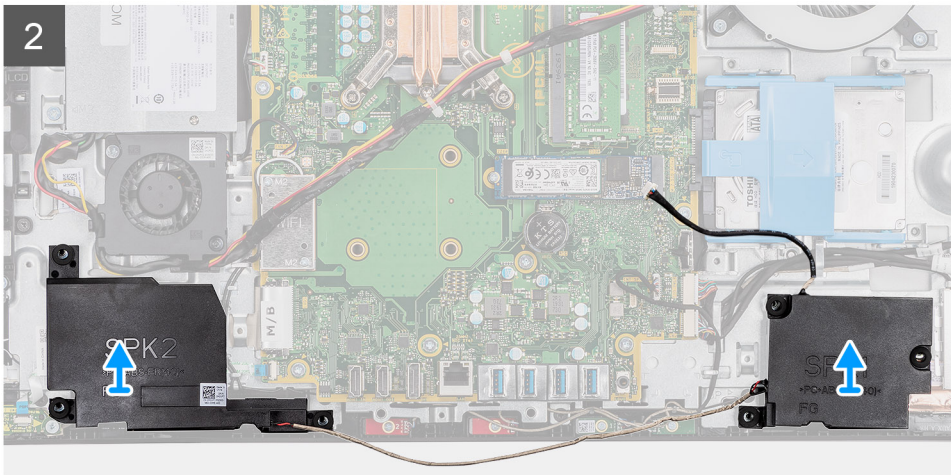
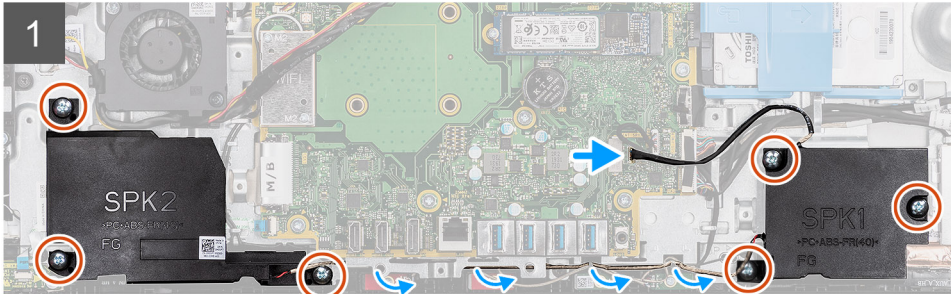
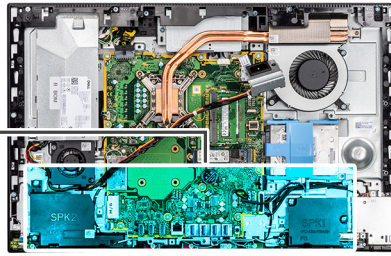
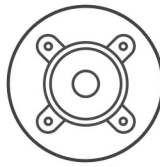

Steps

1. Disconnect the speaker cable from the connector on the system board.
2. Remove the six screws (M3 4+7.1xZN) that secure the speakers to the display-assembly base.
3. Remove the speaker cable from the routing guides on the display-assembly base.
4. Lift the speakers along with the cable off the display-assembly base.

Installing the speakers

Prerequisites

If you are replacing a component, remove the existing component before performing the installation procedure.

About this task

The following image indicates the location of the speakers and provides a visual representation of the installation procedure.



6x
M3 4+7.1xZN

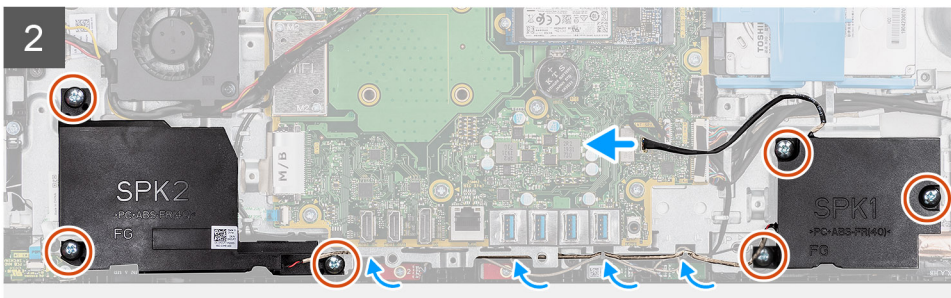
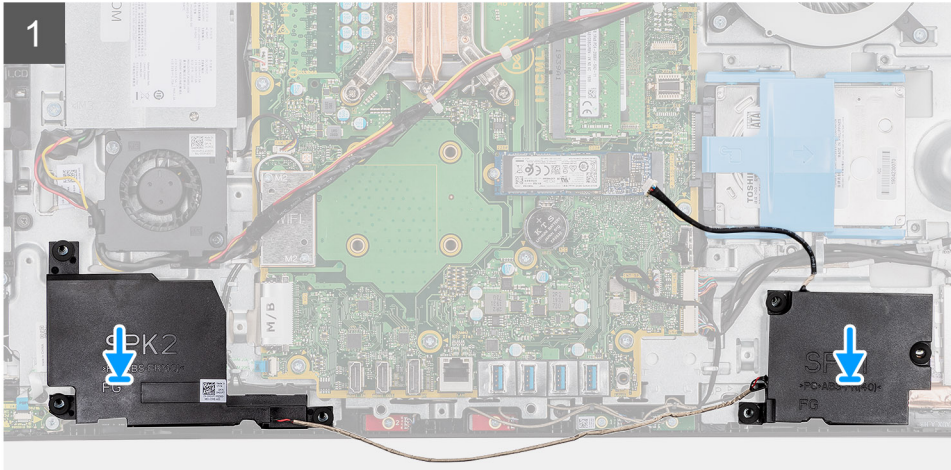
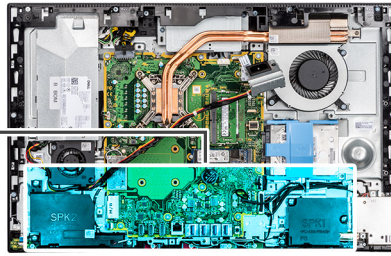
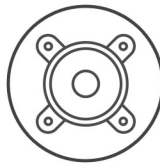

Steps

1. Align the screw holes on the speakers with the screw holes on the display-assembly base.
2. Replace the six screws (M3 4+7.1xZN) to secure the speakers to the display-assembly base.
3. Route the speaker cable through the routing guide on display-assembly base and connect the speaker cable to the system board.

Next steps

1. Install the [rear-I/O bracket](#).
2. Install the [bottom cover](#).
3. Install the [system-board shield](#).
4. Install the [back cover](#).
5. Install the [cable cover](#) (optional).
6. Install the [stand](#).
7. Follow the procedure in [After working inside your computer](#).

Power-button board

Removing the power-button board

Prerequisites

1. Follow the procedure in [Before working inside your computer](#).
2. Remove the [stand](#).
3. Remove the [cable cover](#) (optional).
4. Remove the [back cover](#).
5. Remove the [system-board shield](#).
6. Remove the [bottom cover](#).
7. Remove the [rear-I/O bracket](#).
8. Remove the [speakers](#).

About this task

The following image provides a visual representation of the power-button board removal procedure.



1x
M3x5

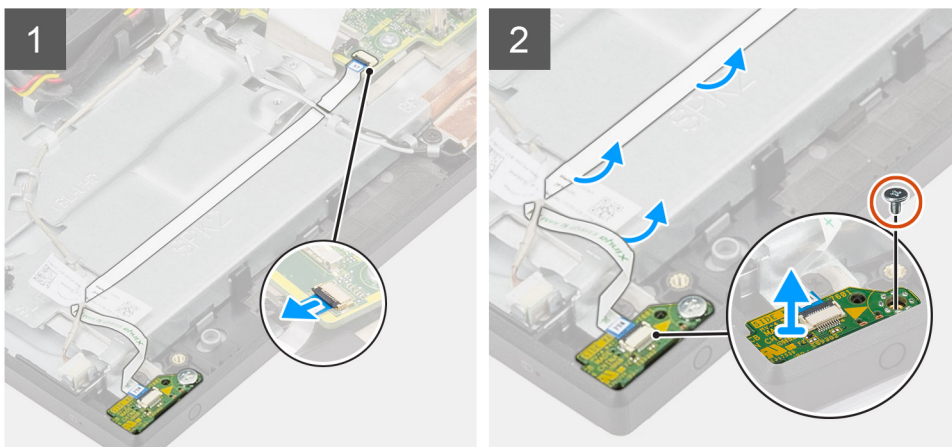

Steps

1. Open the latch and disconnect the power-button board cable from the connector on the system board.
2. Unroute the power-button board cable from the display-assembly base, then slide the power-button board cable out from under the antenna cables.
3. Remove the screw (M3x5) that secures the power-button board to the middle frame.
4. Lift the power-button board, along with its cable, off the middle frame.

Installing the power-button board

Prerequisites

If you are replacing a component, remove the existing component before performing the installation procedure.

About this task

The following image provides a visual representation of the power-button board installation procedure.



1x
M3x5

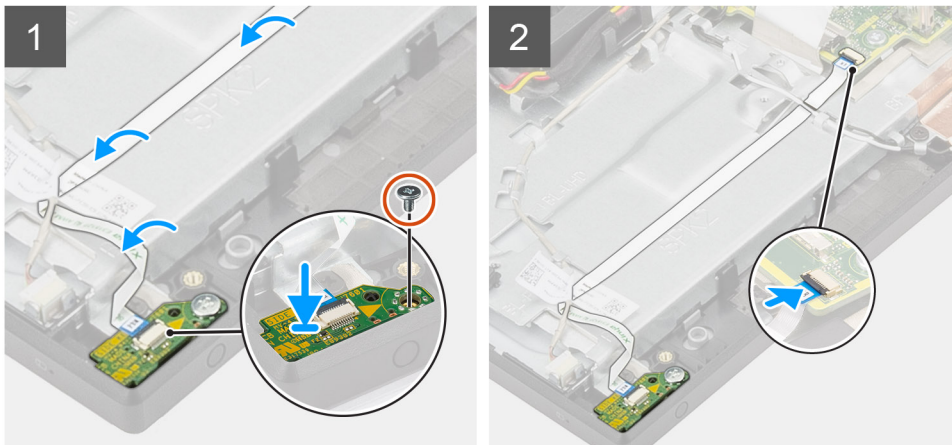

Steps

1. Align and place the power-button board in the slot on the middle frame.
2. Replace the screw (M3x5) to secure the power-button board to the middle frame.
3. Slide the power-button board cable under the antenna cables, then route the power-button board cable to the display-assembly base.
4. Slide the power-button board cable into the connector on the system board and close the latch to secure the cable.

Next steps

1. Install the [speakers](#).
2. Install the [rear-I/O bracket](#).
3. Install the [bottom cover](#).
4. Install the [system-board shield](#).
5. Install the [back cover](#).
6. Install the [cable cover](#) (optional).
7. Install the [stand](#).
8. Follow the procedure in [After working inside your computer](#).

Microphones

Removing the microphones

Prerequisites

1. Follow the procedure in [Before working inside your computer](#).
2. Remove the [stand](#).
3. Remove the [cable cover](#) (optional).
4. Remove the [back cover](#).
5. Remove the [system-board shield](#).

6. Remove the [bottom cover](#).
7. Remove the [rear-I/O bracket](#).
8. Remove the [speakers](#).

About this task

The following image indicates the location of the microphones and provides a visual representation of the removal procedure.

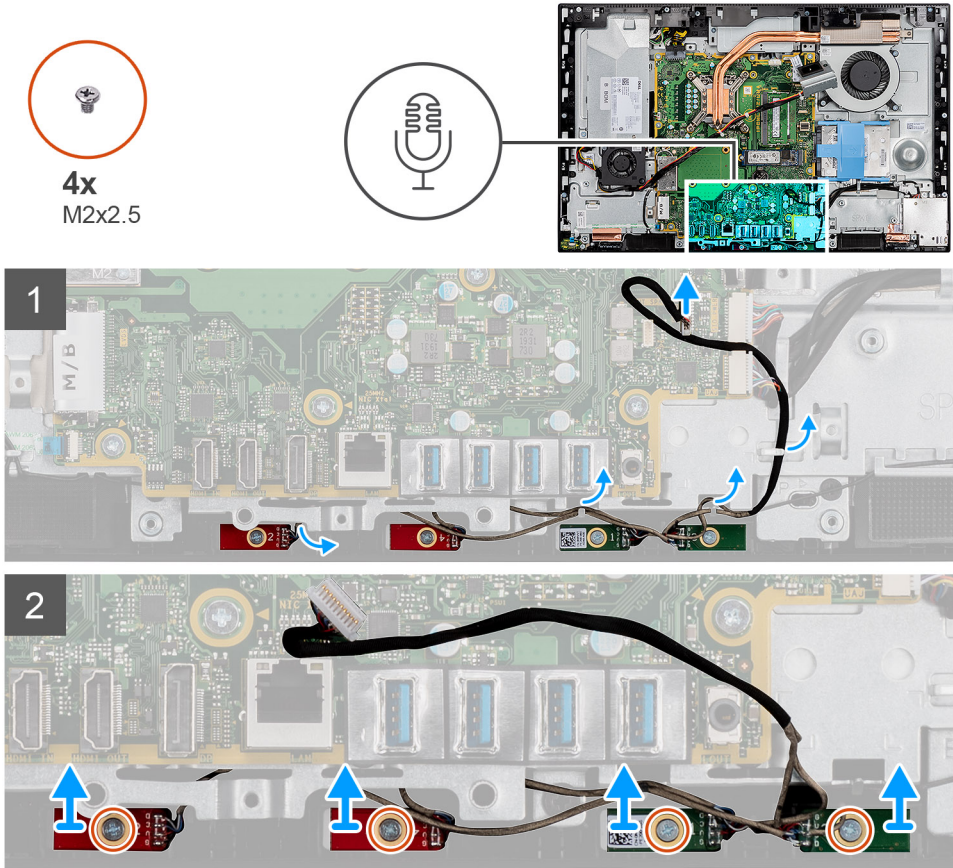

Steps

1. Disconnect the microphone cable from the system board, and unroute it from the routing guides on the display-assembly base.
2. Remove the four screws (M2x2.5) that secure the microphone modules to the middle frame.
3. Lift the microphone modules off the slots on the middle frame.

Installing the microphones

Prerequisites

If you are replacing a component, remove the existing component before performing the installation procedure.

About this task

The following image indicates the location of the microphones and provides a visual representation of the installation procedure.



4x
M2x2.5

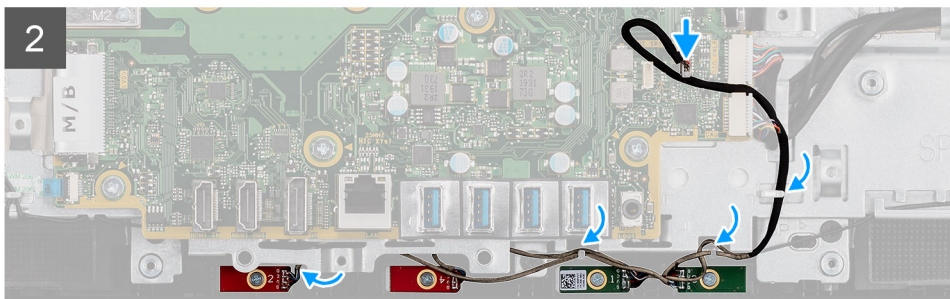
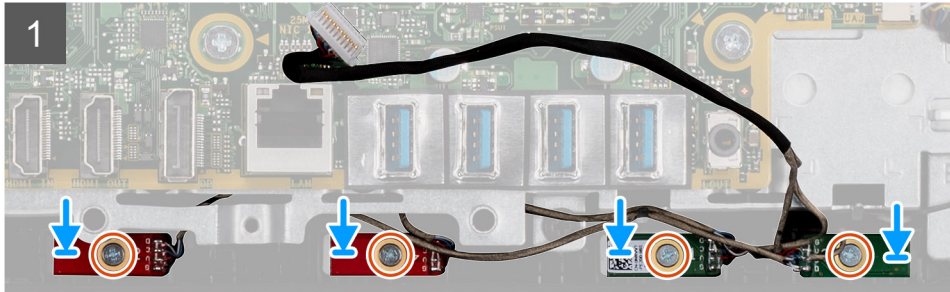
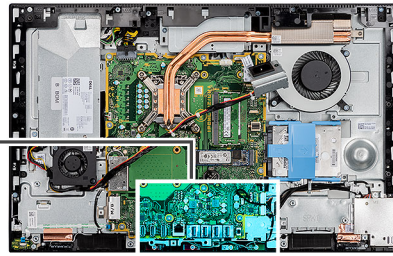

Steps

1. Align the screw holes on the microphone modules with the screw holes on the middle frame.
2. Replace the four screws (M2X2.5) to secure the microphone modules to the middle frame.
3. Route the microphone cable through the routing guides on the display-assembly base and connect the microphone cable to the system board.

Next steps

1. Install the [speakers](#).
2. Install the [rear-I/O bracket](#).
3. Install the [bottom cover](#).
4. Install the [system-board shield](#).
5. Install the [back cover](#).
6. Install the [cable cover](#) (optional).
7. Install the [stand](#).
8. Follow the procedure in [After working inside your computer](#).

Side I/O-board

Removing the side-I/O board

Prerequisites

1. Follow the procedure in [Before working inside your computer](#).
2. Remove the [stand](#).
3. Remove the [cable cover](#) (optional).
4. Remove the [back cover](#).

5. Remove the [hard drive](#).
6. Remove the [system-board shield](#).
7. Remove the [bottom cover](#).
8. Remove the [rear-I/O bracket](#).

About this task

The following image indicates the location of the side-I/O board and provides a visual representation of the removal procedure.

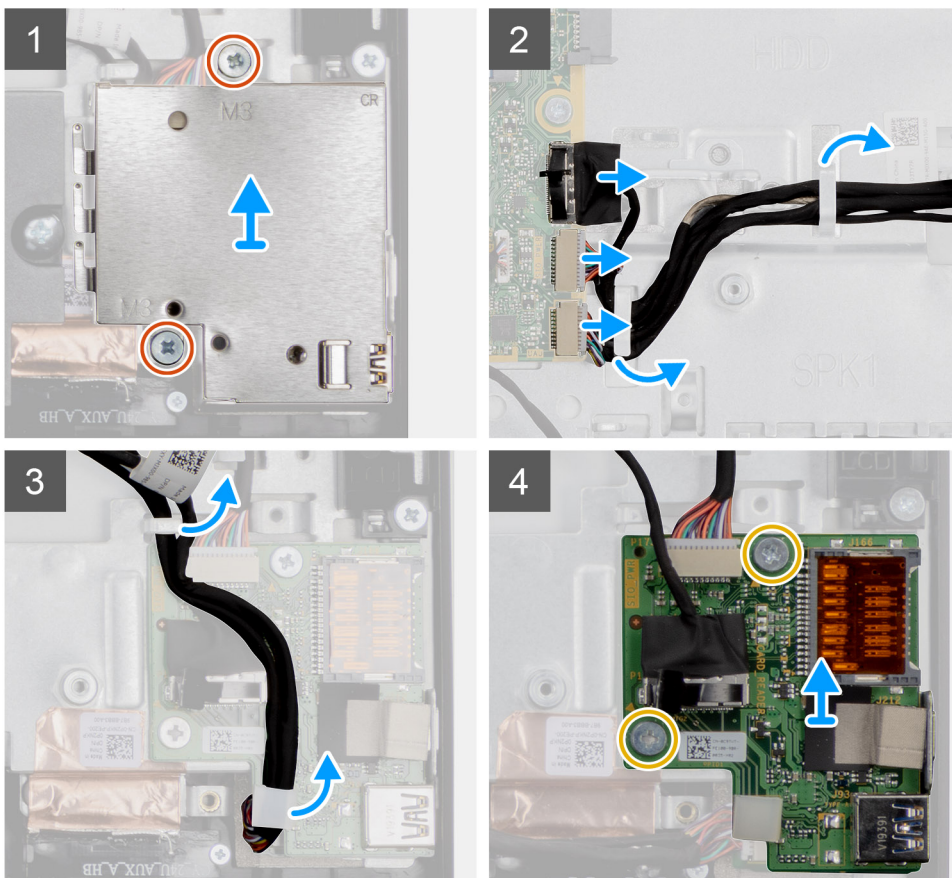
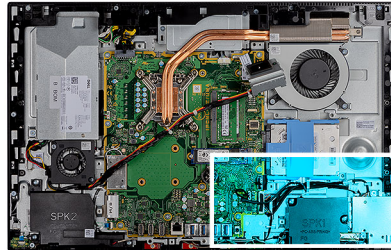
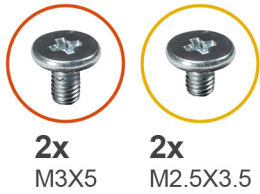

Steps

1. Remove the two screws (M3x5) that secure the side I/O-board shield to the display-assembly base.
2. Lift and remove the side I/O-board shield off the side-I/O board.
3. Disconnect the SIO-signal cable, SIO-power cable, and audio-board cable from the system board.
4. Remove the SIO-signal cable, SIO-power cable, and audio-board cable from the routing guides on the display-assembly base.
5. Remove the two screws (M2.5x3.5) that secure the side-I/O board to the display-assembly base.
6. Lift and remove the side-I/O board with cables off the display-assembly base.

Installing the side-I/O board

Prerequisites

If you are replacing a component, remove the existing component before performing the installation procedure.

About this task

The following image indicates the location of the side-I/O board and provides a visual representation of the installation procedure.

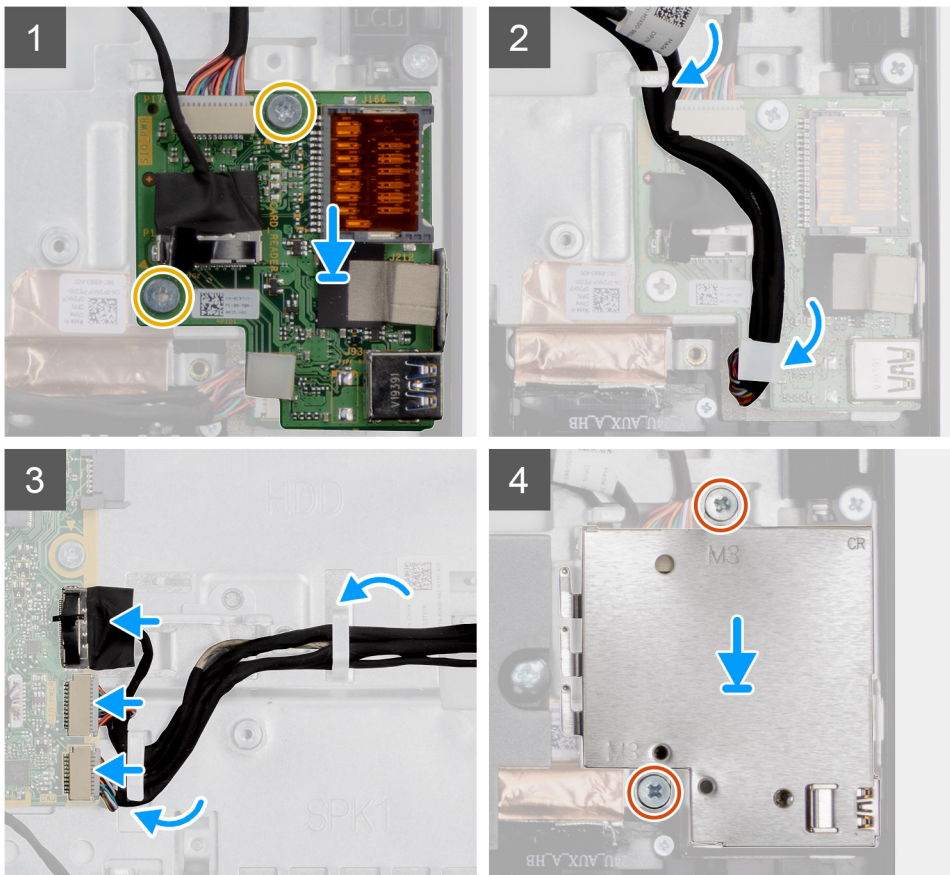
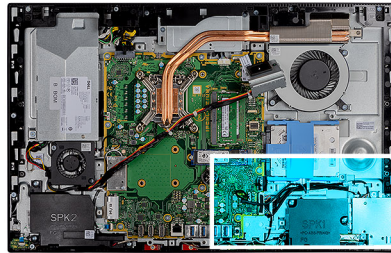

Steps

1. Align the screw holes on the side-I/O board with the screw holes on the display-assembly base.
2. Replace the two screws (M2.5x3.5) to secure the side-I/O board to the display-assembly base.
3. Route the SIO-signal cable, SIO-power cable, and audio-board cable through the routing guides on the display-assembly base.
4. Connect the SIO-signal cable, SIO-power cable, and audio-board cable to the connectors on the system board.
5. Align the screw holes on the side I/O-board shield with the screw holes on the display-assembly base.
6. Replace the two screws (M3x5) to secure the side I/O-board shield to the display-assembly base.

Next steps

1. Install the [speakers](#).
2. Install the [rear-I/O bracket](#).
3. Install the [bottom cover](#).
4. Install the [system-board shield](#).
5. Install the [hard drive](#).
6. Install the [back cover](#).
7. Install the [cable cover](#) (optional).
8. Install the [stand](#).
9. Follow the procedure in [After working inside your computer](#).

Audio board

Removing the audio board

Prerequisites

1. Follow the procedure in [Before working inside your computer](#).
2. Remove the [stand](#).
3. Remove the [cable cover](#) (optional).
4. Remove the [back cover](#).
5. Remove the [system-board shield](#).
6. Remove the [wireless card](#).
7. Remove the [bottom cover](#).
8. Remove the [rear-I/O bracket](#).
9. Remove the [speakers](#).
10. Remove the [side-I/O board](#).

About this task

The following image indicates the location of the audio board and provides a visual representation of the installation procedure.



1x
M3X5

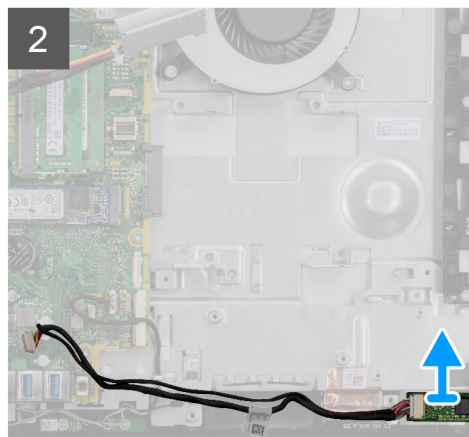
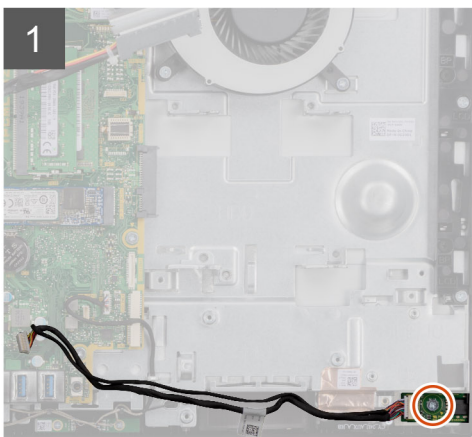
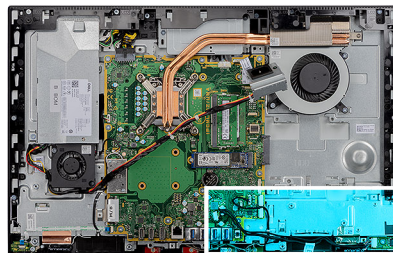

Steps

1. Disconnect the audio-board cable from the connector on the system board.
2. Remove the screw (M3x5) that secure the audio board to the display-assembly base.
3. Lift and remove the audio board with the cable off the display-assembly base.

Installing the audio board

Prerequisites

If you are replacing a component, remove the existing component before performing the installation procedure.

About this task

The following image indicates the location of the audio board and provides a visual representation of the removal procedure.



1x
M3X5

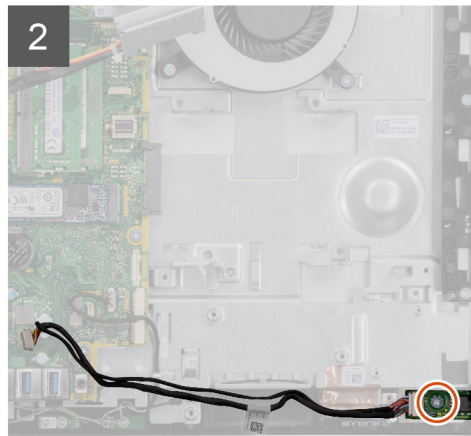
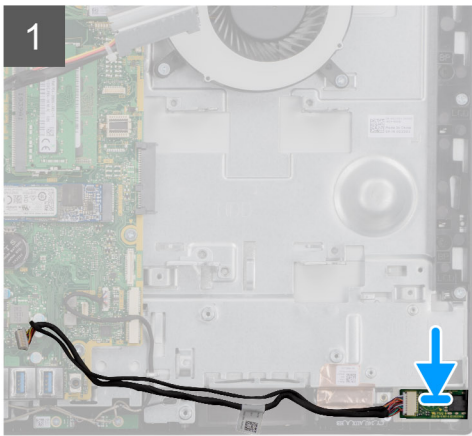
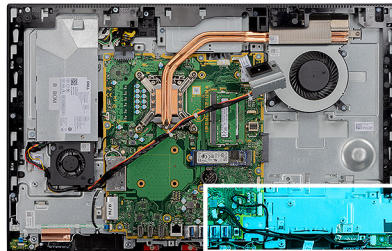

Steps

1. Align the screw hole on the audio board with the screw hole on the display-assembly base.
2. Replace the screw (M3x5) to secure the audio board to the display-assembly base.
3. Connect the audio-board cable to the system board.

Next steps

1. Install the [side-I/O board](#).
2. Install the [speakers](#).
3. Install the [rear-I/O bracket](#).
4. Install the [bottom cover](#).
5. Install the [wireless card](#).
6. Install the [system-board shield](#).
7. Install the [back cover](#).
8. Install the [cable cover](#) (optional).
9. Install the [stand](#).
10. Follow the procedure in [After working inside your computer](#).

Antennas

Removing the antenna modules

Prerequisites

1. Follow the procedure in [Before working inside your computer](#).
2. Remove the [stand](#).
3. Remove the [cable cover](#) (optional).
4. Remove the [back cover](#).
5. Remove the [system-board shield](#).
6. Remove the [wireless card](#).
7. Remove the [bottom cover](#).
8. Remove the [rear-I/O bracket](#).
9. Remove the [speakers](#).

About this task

The following image provides a visual representation of the antenna modules removal procedure.



2x
M2x2.5

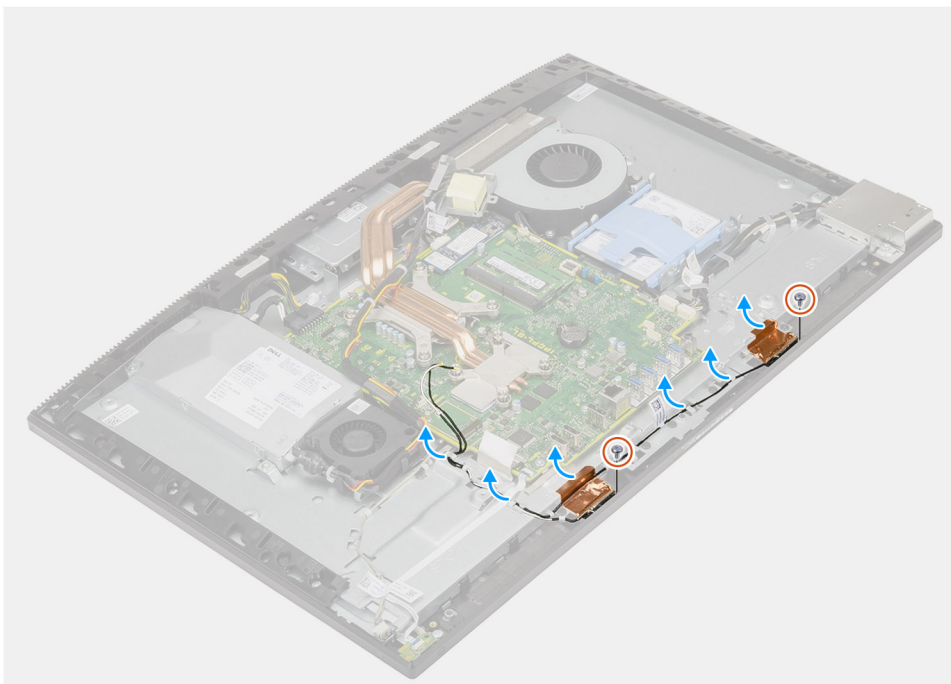

Steps

1. Remove the antenna cables from the routing guides on the display-assembly base.
2. Remove the two screws (M2x2.5) that secure the antenna modules to the middle frame.
3. Carefully peel the copper foil that secures the antenna cables to the middle frame.
4. Lift the antenna modules off the middle frame.

Installing the antenna modules

Prerequisites

If you are replacing a component, remove the existing component before performing the installation procedure.

About this task

The following image provides a visual representation of the antenna modules installation procedure.



2x
M2x2.5

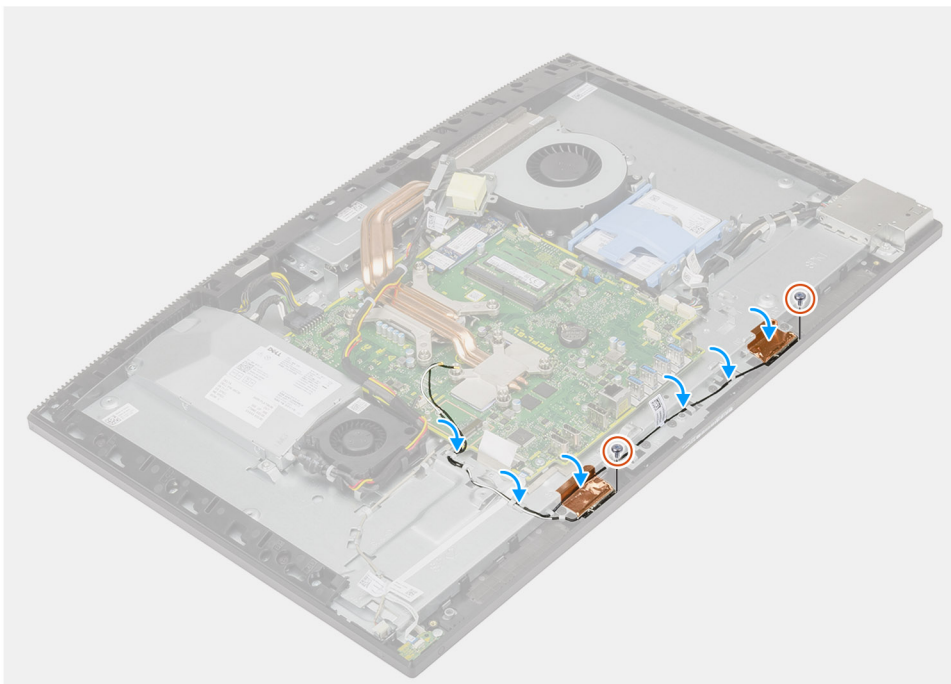

Steps

1. Align and place the antenna modules in the slots on the middle frame.
2. Adhere the copper foil that secures the antenna cables to the middle frame.
3. Replace the two screws (M2x2.5) to secure the antenna modules to the middle frame.
4. Route the antenna cables through the routing guides on the display-assembly base.

Next steps

1. Install the [speakers](#).
2. Install the [rear-I/O bracket](#).
3. Install the [bottom cover](#).
4. Install the [wireless card](#).
5. Install the [system-board shield](#).
6. Install the [back cover](#).
7. Install the [cable cover](#) (optional).
8. Install the [stand](#).
9. Follow the procedure in [After working inside your computer](#).

Display panel

Removing the display panel

Prerequisites

1. Follow the procedure in [Before working inside your computer](#).
2. Remove the [stand](#).
3. Remove the [cable cover](#) (optional).
4. Remove the [back cover](#).
5. Remove the [system-board shield](#).
6. Remove the [hard drive](#).
7. Remove the [bottom cover](#).
8. Remove the [rear-I/O bracket](#).
9. Remove the [speakers](#).
10. Remove the [camera assembly](#).
11. Remove the [system board](#).
12. Remove the [PSU](#).
13. Remove the [PSU fan](#).

About this task

The following image provides a visual representation of the display panel removal procedure.



11x
M3x5

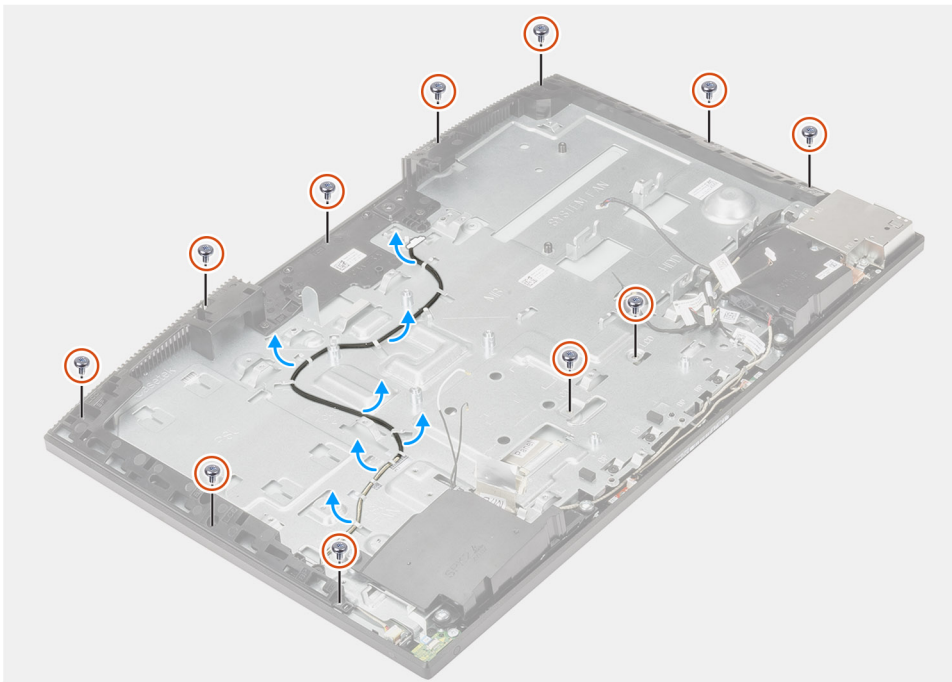

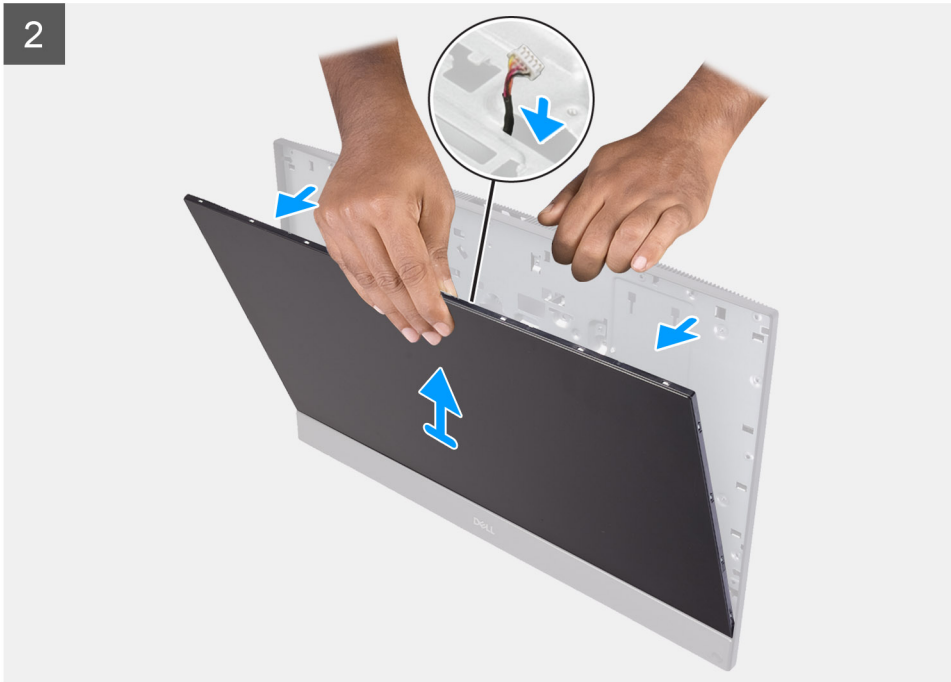

Steps

1. Remove the 11 screws (M3x5) that secure the display panel to the middle frame and display-assembly base.
2. Place the system in an upright position.
3. Holding the top corner, release the display panel away from the middle frame and display-assembly base.
4. Route the display back-light, touch screen, and display cable through the slots on the display-assembly base.
5. Lift the display panel up from the middle frame and display-assembly base.

Installing the display panel

Prerequisites

If you are replacing a component, remove the existing component before performing the installation procedure.

About this task

The following image provides a visual representation of the display panel installation procedure.



11x
M3x5

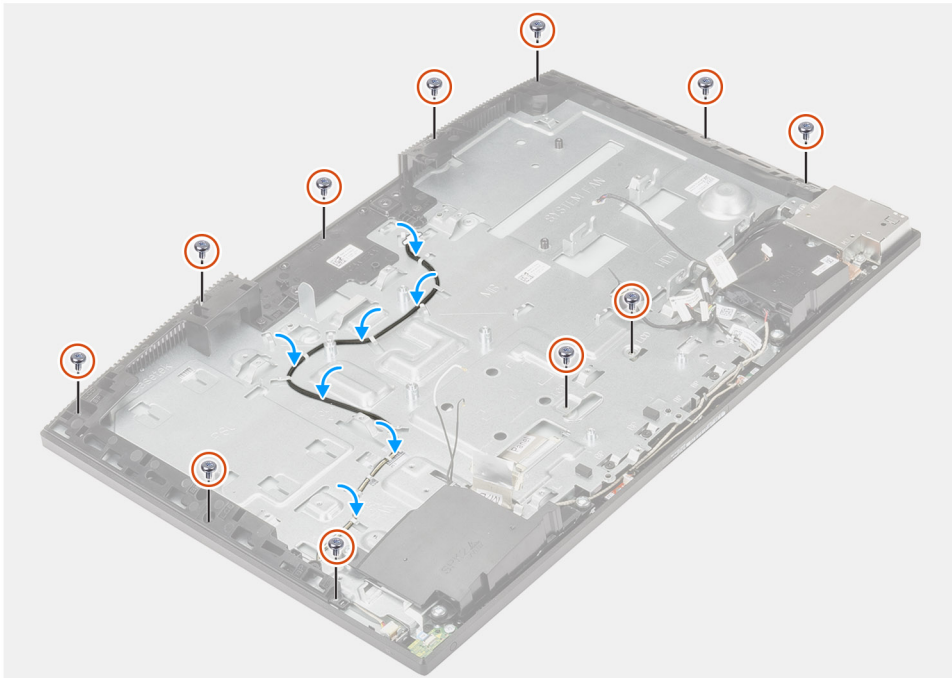
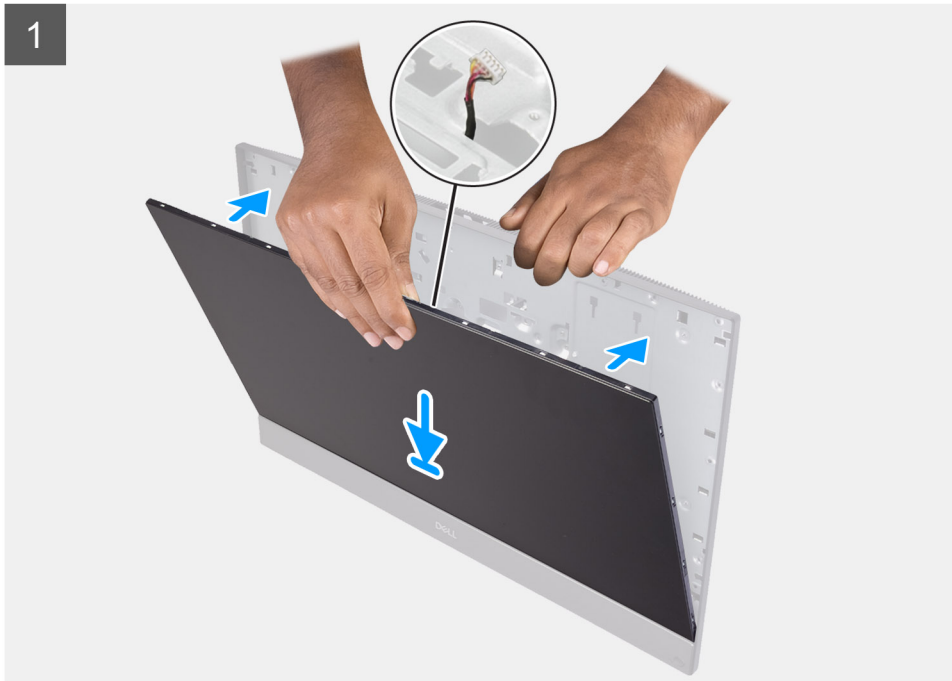

Steps

1. Place the system in an upright position, and slide the display panel on the slots of the display-assembly base.
2. Route the display-backlight, touch screen, and display cable through the slots on the display-assembly base.
3. Place the display-assembly base on a clean and flat surface with the display panel facing down.

4. Replace the 10 screws (M3x5) to secure the display panel to the middle frame and display-assembly base.
5. Remove the jig screw from the display panel and replace the screw (M3x5) to secure the display panel to the middle frame and display assembly base.

NOTE: The jig screw is shipped with the replacement display panel. It is used to align the display panel to the display-assembly base.

6. Route the display cable in the routing guides on the display-assembly base.

Next steps

1. Install the [PSU fan](#).
2. Install the [PSU](#).
3. Install the [system board](#).
4. Install the [camera assembly](#).
5. Install the [speakers](#).
6. Install the [rear-I/O bracket](#).
7. Install the [bottom cover](#).
8. Install the [hard drive](#).
9. Install the [system-board shield](#).
10. Install the [back cover](#).
11. Install the [cable cover](#) (optional).
12. Install the [stand](#).
13. Follow the procedure in [After working inside your computer](#).

Middle frame

Removing the middle frame

Prerequisites

1. Follow the procedure in [Before working inside your computer](#).
2. Remove the [stand](#).
3. Remove the [cable cover](#) (optional).
4. Remove the [back cover](#).
5. Remove the [system-board shield](#).
6. Remove the [hard drive](#).
7. Remove the [wireless card](#).
8. Remove the [bottom cover](#).
9. Remove the [rear-I/O bracket](#).
10. Remove the [speakers](#).
11. Remove the [camera assembly](#).
12. Remove the [system board](#).
13. Remove the [power-button board](#).
14. Remove the [microphones](#).
15. Remove the [PSU](#).
16. Remove the [PSU fan](#).
17. Remove the [side-I/O board](#).
18. Remove the [antenna modules](#).
19. Remove the [display panel](#).

About this task

The following image provides a visual representation of the middle frame removal procedure.



17x
M3x5



Steps

1. Remove the 17 screws (M3x5) that secure the middle frame to the display-assembly base.
2. Remove the middle frame and lift the middle frame off the display-assembly base.

Installing the middle frame

Prerequisites

If you are replacing a component, remove the existing component before performing the installation procedure.

About this task

The following image provides a visual representation of the middle frame installation procedure.



17x
M3x5





Steps

1. Slide and align the middle frame to the slots on the display-assembly base, then snap the middle frame into place on the display-assembly base.
2. Replace the 17 screws (M3x5) to secure the middle frame to the display-assembly base.

Next steps

1. Install the [display panel](#).
2. Install the [antenna modules](#).
3. Install the [side-I/O board](#).
4. Install the [PSU fan](#).
5. Install the [PSU](#).
6. Install the [microphones](#).
7. Install the [power-button board](#).
8. Install the [system board](#).
9. Install the [camera assembly](#).
10. Install the [speakers](#).
11. Install the [rear-I/O bracket](#).
12. Install the [bottom cover](#).
13. Install the [wireless card](#).
14. Install the [hard drive](#).
15. Install the [system-board shield](#).
16. Install the [back cover](#).
17. Install the [cable cover](#) (optional).
18. Install the [stand](#).
19. Follow the procedure in [After working inside your computer](#).

Software

This chapter details the supported operating systems along with instructions on how to install the drivers.

Topics:

- [Operating system](#)
- [Downloading the drivers](#)

Operating system

- Windows 10 Home (64-bit)
- Windows 10 IoT Enterprise 2019 LTSC (OEM Only)
- Windows 10 Professional (64-bit)
- Windows 10 Pro Education (64-bit)
- NeoKylin 7.0 (China only)
- Ubuntu 18.04 (64-bit)

Downloading the drivers

Steps

1. Turn on your computer.
2. Go to www.dell.com/support.
3. Enter the Service Tag of your computer, and then click **Submit**.
i **NOTE:** If you do not have the Service Tag, use the auto-detect feature or manually browse for your computer model.
4. Click **Drivers & downloads**.
5. Click the **Detect Drivers** button.
6. Review and agree to the Terms and Conditions to use **SupportAssist**, then click **Continue**.
7. If necessary, your computer starts to download and install **SupportAssist**.
i **NOTE:** Review on-screen instructions for browser-specific instructions.
8. Click **View Drivers for My System**.
9. Click **Download and Install** to download and install all driver updates detected for your computer.
10. Select a location to save the files.
11. If prompted, approve requests from **User Account Control** to make changes on the system.
12. The application installs all drivers and updates identified.
i **NOTE:** Not all files can be installed automatically. Review the installation summary to identify if manual installation is necessary.
13. For manual download and installation, click **Category**.
14. From the drop-down list, select the preferred driver.
15. Click **Download** to download the driver for your computer.
16. After the download is complete, navigate to the folder where you saved the driver file.
17. Double-click the driver file icon and follow the instructions on the screen to install the driver.

System setup

NOTE: Depending on the computer and its installed devices, the items listed in this section may or may not be displayed.

Topics:

- [BIOS overview](#)
- [Entering BIOS setup program](#)
- [Navigation keys](#)
- [Boot Sequence](#)
- [System setup options](#)
- [System and setup password](#)

BIOS overview

The BIOS manages data flow between the computer's operating system and attached devices such as hard disk, video adapter, keyboard, mouse, and printer.

Entering BIOS setup program

About this task

Turn on (or restart) your computer and press F2 immediately.

Navigation keys

NOTE: For most of the System Setup options, changes that you make are recorded but do not take effect until you restart the system.

Keys	Navigation
Up arrow	Moves to the previous field.
Down arrow	Moves to the next field.
Enter	Selects a value in the selected field (if applicable) or follow the link in the field.
Spacebar	Expands or collapses a drop-down list, if applicable.
Tab	Moves to the next focus area.
Esc	Moves to the previous page until you view the main screen. Pressing Esc in the main screen displays a message that prompts you to save any unsaved changes and restarts the system.

Boot Sequence

Boot Sequence allows you to bypass the System Setup–defined boot device order and boot directly to a specific device (for example: optical drive or hard drive). During the Power-on Self-Test (POST), when the Dell logo appears, you can:

- Access System Setup by pressing F2 key
- Bring up the one-time boot menu by pressing F12 key.

The one-time boot menu displays the devices that you can boot from including the diagnostic option. The boot menu options are:

- UEFI BOOT
 - Windows Boot Manager
 - Onboard NIC (IPV4)
 - Onboard NIC (IPV6)
- OTHER OPTIONS
 - BIOS Setup
 - Device Configuration
 - BIOS Flash Update
 - Diagnostics
 - SupportAssist OS Recovery
 - Change Boot Mode Settings
 - Exit Boot Menu and continue

System setup options

NOTE: Depending on this computer and its installed devices, the items listed in this section may or may not appear.

Table 3. System setup options—System information menu

General-System Information	
System Information	
BIOS Version	Displays the BIOS version number.
Service Tag	Displays the Service Tag of the computer.
Asset Tag	Displays the Asset Tag of the computer.
Ownership Tag	Displays the Ownership Tag of the computer.
Manufacture Date	Displays the manufacture date of the computer.
Ownership Date	Displays the ownership date of the computer.
Express Service Code	Displays the express service code of the computer.
Signed Firmware Update is enabled	Displays whether the Signed Firmware Update is enabled on your computer.
Memory Information	
Memory Installed	Displays the total computer memory installed.
Memory Available	Displays the total computer memory available.
Memory Speed	Displays the memory speed.
Memory Channel Mode	Displays single or dual channel mode.
Memory Technology	Displays the technology used for the memory.
DIMM 1 Size	Displays the DIMM A memory size.
DIMM 2 Size	Displays the DIMM B memory size.
PCI Information	
SLOT1	Displays the M.2 slot1 information.
SLOT2_M.2	Displays the M.2 slot2 information.
SLOT3_m.2	Displays the M.2 slot3 information.
Processor Information	
Processor Type	Displays the processor type.
Core Count	Displays the number of cores on the processor.

Table 3. System setup options—System information menu (continued)

General-System Information	
Processor ID	Displays the processor identification code.
Current Clock Speed	Displays the current processor clock speed.
Minimum Clock Speed	Displays the minimum processor clock speed.
Maximum Clock Speed	Displays the maximum processor clock speed.
Processor L2 Cache	Displays the processor L2 Cache size.
Processor L3 Cache	Displays the processor L3 Cache size.
HT Capable	Displays whether the processor is HyperThreading (HT) capable.
64-Bit Technology	Displays whether 64-bit technology is used.
Device Information	
SATA-0	Displays the SATA-0 device information of the computer.
M.2 PCIe SSD-0	Displays the M.2 PCIe SSD information of the computer.
M.2 PCIe SSD-1	Displays the M.2 PCIe SSD information of the computer.
LOM MAC Address	Displays the LAN On Motherboard (LOM) MAC address of the computer.
Video Controller	Displays the video controller type of the computer.
dGPU Video Controller	Displays the discrete graphics information of the computer.
Video BIOS Version	Displays the video BIOS version of the computer.
Video Memory	Displays the video memory information of the computer.
Panel Type	Displays the Panel Type of the computer.
Native Resolution	Displays the native resolution of the computer.
Audio Controller	Displays the audio controller information of the computer.
Wi-Fi Device	Displays the wireless device information of the computer.
Bluetooth Device	Displays the bluetooth device information of the computer.
Boot Sequence	
Boot Sequence	Displays the boot sequence.
Boot List Option	Displays the available boot options.
UEFI Boot Path Security	
	Displays the UEFI Boot options. By default, the Always Except Internal HDD option is enabled.
Date/Time	
	Displays the current date in MM/DD/YY format and current time in HH:MM:SS AM/PM format.

Table 4. System setup options—System Configuration menu

System Configuration	
Integrated NIC	
Enable UEFI Network Stack	Controls the on-board LAN controller. Enable or disable UEFI Network Stack. By default, the Enable UEFI Network Stack and Enabled w/PXE options are enabled.
SATA Operation	
	Configure operating mode of the integrated SATA hard drive controller. By default, the RAID On option is enabled.
Drives	
	Enable or disable various drives on board. By default, all the options are enabled.

Table 4. System setup options—System Configuration menu (continued)

System Configuration	
SMART Reporting	<p>Enable or disable Self-Monitoring, Analysis, and Reporting Technology (SMART) during system startup.</p> <p>By default, the Enable SMART Reporting option is not enabled.</p>
USB Configuration	
Enable USB Boot Support	<p>Enable or disable booting from USB mass storage devices such as external hard drive, optical drive, and USB drive.</p> <p>By default, the Enable USB Boot Support option is enabled.</p>
Enable Rear USB Ports	<p>Enable or disable booting from USB mass storage devices connected to rear USB port.</p> <p>By default, the Enable Rear USB Ports option is enabled.</p>
Enable Side USB Ports	<p>Enable or disable booting from USB mass storage devices connected to side USB port.</p> <p>By default, the Enable side USB Ports option is enabled.</p>
Rear USB Configuration	<p>Enable or disable rear USB configuration.</p> <p>By default, all the options are enabled.</p>
Side USB Configuration	<p>Enable or disable rear USB configuration.</p> <p>By default, all the options are enabled.</p>
USB PowerShare	<p>Enable or Disable USB PowerShare</p> <p>By default, the Enable USB PowerShare option is not enabled.</p>
Audio	<p>Enable or disable the integrated audio controller.</p> <p>By default, all the options are enabled.</p>
OSD Button Management	
Disable OSD button	<p>Enable or disable OSD button.</p> <p>By default, the Disable OSD Buttons option is not enabled.</p>
Touchscreen	
Touchscreen	<p>Enable or disable touchscreen (only for touchscreen computers).</p> <p>By default, the Touchscreen option is enabled.</p>
Miscellaneous Devices	
Enable Camera	<p>Enable or disable various onboard devices.</p> <p>Enable or disable the camera.</p> <p>By default, the Enable Camera option is enabled.</p>
Enable Secure Digital (SD) Card	<p>Enable or disable the SD card.</p> <p>By default, the Enable Secure Digital (SD) Card option is enabled.</p>
Secure Digital (SD) Card Boot	<p>Enable or disable the SD card read-only boot.</p> <p>By default, the Secure Digital (SD) Card Boot option is not enabled.</p>
Secure Digital (SD) Card Read-Only Mode	<p>Enable or disable the SD card read-only mode.</p> <p>By default, the Secure Digital (SD) Card Read-Only Mode option is not enabled.</p>

Table 5. System setup options—Security menu

Security	
Admin Password	Set, change, or delete the administrator password.
System Password	Set, change, or delete the system password.
Password Configuration	Control the minimum and maximum number of characters allowed for the Admin and System passwords.
Password Bypass	Bypass the System (Boot) Password and the internal HDD password prompts during a system restart. By default, the Disabled option is enabled.
Password Change	Enable or disable changes to the System and Hard Disk passwords when an administrator password is set. By default, the Allow Non-Admin Password Changes option is enabled.
UEFI Capsule Firmware Updates	Enable or disable BIOS updates through UEFI capsule update packages. By default, the option is enabled.
TPM 2.0 Security	Enable or disable TPM 2.0 security options.
Absolute	Enable or disable the BIOS module interface of the optional Absolute Persistence Module service from Absolute Software. By default, the option is enabled.
Chassis Intrusion	Enable or disable the chassis intrusion feature. By default, the option is not enabled.
OROM Keyboard Access	Enable or disable OROM keyboard access. By default, the option is enabled.
Admin Setup Lockout	Enable to prevent users from entering Setup when an Admin Password is set. By default, the option is not enabled.
Master Password Lockout	Enable to prevent users from entering Setup when a Master Password is set. By default, the option is not enabled.
HDD Protection Support	Enable or disable the HDD protection feature. By default, the option is not enabled.
SMM Security Mitigation	Enable or disable SMM Security Mitigation. By default, the option is enabled.

Table 6. System setup options—Secure Boot menu

Secure Boot	
Secure Boot Enable	Enable or disable the secure boot feature. By default, the option is not enabled.
Secure Boot Menu	Enable or disable to change the secure boot mode options. By default, the Deployed Mode is enabled.
Expert Key Management	
Enable Custom Mode	Enable or disable custom mode.
Expert Key Management	Enable or disable Expert Key Management.
Custom Mode Key Management	Select the custom values for expert key management.

Table 7. System setup options—Intel Software Guard Extensions menu

Intel Software Guard Extensions	
Intel SGX Enable	Enable or disable Intel Software Guard Extensions. By default, the Software Controlled option is enabled.
Enclave Memory Size	Set the Intel Software Guard Extensions Enclave Reserve Memory Size. By default, the 128 MB option is enabled.

Table 8. System setup options—Performance menu

Performance	
Multi Core Support	Enable multiple cores. By default, the option is enabled.
Intel SpeedStep	Enable or disable Intel Speedstep Technology. By default, the option is enabled.  NOTE: If enabled, the processor clock speed and core voltage are adjusted dynamically based on the processor load.
C-States Control	Enable or disable additional processor sleep states. By default, the option is enabled.
Intel TurboBoost	Enable or disable Intel TurboBoost mode of the processor. By default, the option is enabled.
HyperThread Control	Enable or disable HyperThreading in the processor. By default, the option is enabled.

Table 9. System setup options—Power Management menu

Power Management	
AC Recovery	Enables the system to turn on automatically, when AC is inserted. By default, the Power Off option is enabled.
Enable Intel Speed Shift technology	Enable/disable Intel Speed Shift Technology support . Setting this option to enable to allows the operating system to select the appropriate processor performance automatically. By default, the option is enabled.
Auto On Time	Enable to set the computer to turn on automatically every day or on a preselected date and time. This option can be configured only if the Auto On Time is set to Everyday, Weekdays, or Selected Days. By default, the option is disabled.
Deep Sleep Control	Enable or disable the Deep Sleep mode support. By default, the Enabled in S4 and S5 option is enabled.
Fan Control Override	Enable or disable the fan control override feature. By default, the option is disabled.
USB Wake Support	Enable the USB devices to wake the computer from Standby. By default, the option is enabled.
Wake on LAN/WLAN	Enable or disable the computer to be powered on by special LAN signals. By default, the option is disabled.

Table 9. System setup options—Power Management menu (continued)

Power Management	
Block Sleep	<p>Enable or disable block sleep.</p> <p>By default, the option is disabled.</p>

Table 10. System setup options—POST Behavior menu

POST Behavior	
Numlock LED	<p>Enable or disable Numlock LED.</p> <p>By default, the Enable Numlock LED option is enabled.</p>
Keyboard Error	<p>Enable or disable the keyboard error detection.</p> <p>By default, the option is enabled.</p>
Fastboot	<p>Enable to set the speed of the boot process.</p> <p>By default, the Thorough option is enabled.</p>
Extend BIOS POST Time	<p>Set the BIOS POST time.</p>
Full Screen Logo	<p>Enable or disable full screen logo.</p> <p>By default, the option is not enabled.</p>
Warning and Errors	<p>Enable or disable the action to be done when a warning or error is encountered.</p> <p>By default, the Prompt on Warnings and Errors option is enabled.</p>

Table 11. System setup options—Manageability menu

Manageability	
AC Recovery	<p>Enable or disable the Intel AMT capability.</p> <p>By default, the Restrict MEBx Access option is enabled.</p>
USB Provision	<p>Enable or disable USB provision.</p> <p>By default, the option is disabled.</p>
MEBx Hotkey	<p>Enable or disable the MEBx hotkey feature.</p> <p>By default, the option is disabled.</p>

Table 12. System setup options—Virtualization Support menu

Virtualization Support	
Virtualization	<p>Specify whether a Virtual Machine Monitor (VMM) can utilize the additional hardware capabilities provided by Intel Virtualization Technology.</p> <p>By default, the option is enabled.</p>
VT for Direct I/O	<p>Specify whether a Virtual Machine Monitor (VMM) can utilize the additional hardware capabilities provided by Intel Virtualization Technology for Direct I/O.</p> <p>By default, the option is enabled.</p>
Trusted Execution	<p>Specify whether a Measured Virtual Machine Monitor (MVMM) can utilize the additional hardware capabilities provided by Intel Trusted Execution Technology.</p> <p>By default, the option is disabled.</p>

Table 13. System setup options—Wireless menu

Wireless	
Wireless Device Enable	Enable or disable internal wireless devices. By default, all the options are enabled.

Table 14. System setup options—Maintenance menu

Maintenance	
Service Tag	Display the system's Service Tag.
Asset Tag	Create a system Asset Tag.
SERR Messages	Enable or disable SERR messages.
BIOS Downgrade	Control flashing of the system firmware to previous revisions.
Data Wipe	Enable to securely erase data from all internal storage devices.
BIOS Recovery	Enable the user to recover from certain corrupted BIOS conditions from a recovery file on the user primary hard drive or an external USB key.
First Power On Date	Set the ownership date.

Table 15. System setup options—System Logs menu

System Logs	
BIOS Events	Display BIOS events.

Table 16. System setup options—Advanced configurations menu

Advanced configurations	
ASPM	Enable or disable the Active State Power Management (ASPM) level. By default, the Auto option is enabled.

Table 17. System setup options—SupportAssist System Resolution menu

SupportAssist System Resolution	
Auto OS Recovery Threshold	Control the automatic boot flow for SupportAssist System Resolution Console and for the Dell OS Recovery tool.
SupportAssist OS Recovery	Enable or disable the boot flow for the SupportAssist OS Recovery tool when certain system errors. By default, the option is enabled.
BIOSConnect	Enable or disable the cloud service OS upon absence of local OS recovery. By default, the option is enabled.

System and setup password

Table 18. System and setup password

Password type	Description
System password	Password that you must enter to log on to your system.
Setup password	Password that you must enter to access and make changes to the BIOS settings of your computer.

You can create a system password and a setup password to secure your computer.

 **CAUTION:** The password features provide a basic level of security for the data on your computer.

 **CAUTION:** Anyone can access the data stored on your computer if it is not locked and left unattended.

 **NOTE:** System and setup password feature is disabled.

Assigning a system setup password

Prerequisites

You can assign a new **System or Admin Password** only when the status is in **Not Set**.

About this task

To enter the system setup, press F2 immediately after a power-on or reboot.

Steps

1. In the **System BIOS** or **System Setup** screen, select **Security** and press **Enter**.
The **Security** screen is displayed.
2. Select **System/Admin Password** and create a password in the **Enter the new password** field.
Use the following guidelines to assign the system password:
 - A password can have up to 32 characters.
 - The password can contain the numbers 0 through 9.
 - Only lower case letters are valid, upper case letters are not allowed.
 - Only the following special characters are allowed: space, ("), (+), (.), (-), (.), (/), (;), ([), (\), (]), (`).
3. Type the system password that you entered earlier in the **Confirm new password** field and click **OK**.
4. Press **Esc** and a message prompts you to save the changes.
5. Press **Y** to save the changes.
The computer reboots.

Deleting or changing an existing system setup password

Prerequisites

Ensure that the **Password Status** is Unlocked (in the System Setup) before attempting to delete or change the existing System and Setup password. You cannot delete or change an existing System or Setup password, if the **Password Status** is Locked.

About this task

To enter the System Setup, press **F2** immediately after a power-on or reboot.

Steps

1. In the **System BIOS** or **System Setup** screen, select **System Security** and press **Enter**.
The **System Security** screen is displayed.
2. In the **System Security** screen, verify that **Password Status** is **Unlocked**.
3. Select **System Password**, alter or delete the existing system password and press **Enter** or **Tab**.
4. Select **Setup Password**, alter or delete the existing setup password and press **Enter** or **Tab**.
 **NOTE:** If you change the System and/or Setup password, re enter the new password when prompted. If you delete the System and Setup password, confirm the deletion when prompted.
5. Press **Esc** and a message prompts you to save the changes.
6. Press **Y** to save the changes and exit from System Setup.
The computer restarts.

Troubleshooting

Topics:

- [Dell SupportAssist Pre-boot System Performance Check diagnostics](#)
- [Display built-in self test](#)
- [Diagnostics](#)
- [Recovering the operating system](#)
- [Flashing BIOS \(USB key\)](#)
- [Flashing the BIOS](#)
- [WiFi power cycle](#)
- [Flea power release](#)

Dell SupportAssist Pre-boot System Performance Check diagnostics

About this task

The SupportAssist diagnostics (also known as system diagnostics) performs a complete check of your hardware. The Dell SupportAssist Pre-boot System Performance Check diagnostics is embedded with the BIOS and is launched by the BIOS internally. The embedded system diagnostics provides a set of options for particular devices or device groups allowing you to:

- Run tests automatically or in an interactive mode
- Repeat tests
- Display or save test results
- Run thorough tests to introduce additional test options to provide extra information about the failed device(s)
- View status messages that inform you if tests are completed successfully
- View error messages that inform you of problems encountered during testing

 **NOTE:** Some tests for specific devices require user interaction. Always ensure that you are present at the computer terminal when the diagnostic tests are performed.

For more information, see [Resolve Hardware Issues With Built-in and Online Diagnostics \(SupportAssist ePSA, ePSA or PSA Error Codes\)](#).

Running the SupportAssist Pre-Boot System Performance Check

Steps

1. Turn on your computer.
2. As the computer boots, press the F12 key as the Dell logo appears.
3. On the boot menu screen, select the **Diagnostics** option.
4. Click the arrow at the bottom left corner.
Diagnostics front page is displayed.
5. Click the arrow in the lower-right corner to go to the page listing.
The items detected are listed.
6. To run a diagnostic test on a specific device, press Esc and click **Yes** to stop the diagnostic test.
7. Select the device from the left pane and click **Run Tests**.
8. If there are any issues, error codes are displayed.
Note the error code and validation number and contact Dell.

Display built-in self test

About this task

The following procedure provides the instructions on how to run the built-in self test for the display:

Steps

1. Turn off your computer.
2. Press and hold the display built-in self test button.
3. Press and hold the power button.
4. Release the power button.
5. Hold the display built-in self test button until the test starts.

Diagnostics

Power status indicator light: Indicates the power status.

Solid amber—The system is unable to boot to the operating system. This indicates that the power supply or another device in the system is failing.

Blinking white—The system is unable to boot to the operating system. This indicates that the power supply is normal but another device in the system is failing or not installed properly.

 **NOTE:** See the light patterns to determine if the device that is failing.

Off—System is in hibernation or turned off.

The power status indicator blinks amber along with beep codes indicating failures.

For example, the power status indicator blinks amber two times followed by a pause, and then blinks white three times followed by a pause. This 2,3 pattern continues until the system is turned off indicating the Recovery image is not found.

The following table shows different light patterns and what they indicate:

Table 19. Diagnostic LED behavior

Blinking pattern		Problem description	Suggested resolution
Amber	White		
1	1	MBIST: TPM Detection Failure	Replace the system board.
1	2	MBIST:SPI flash, Unrecoverable SPI flash failure	Replace the system board.
1	5	i-Fuse: Failure EC unable to program i-Fuse	Replace the system board.
1	6	EC internal: Failure Generic catch-all for ungraceful EC code flow errors	Disconnect all power source (AC, battery, coin-cell) and press and hold the power button to drain flea power.
2	1	Processor failure	Run the Intel CPU diagnostics tools. If problem continues, replace the system board.
2	2	System board: BIOS or ROM (Read-Only Memory) failure	Flash the latest BIOS version. If problem continues, replace the system board.
2	3	No memory or RAM (Random-Access Memory) detected	Check and confirm that the memory module is installed properly. If problem continues, replace the memory module.
2	4	Memory or RAM (Random-Access Memory) failure	Reset the memory module. If problem continues, replace the memory module.

Table 19. Diagnostic LED behavior (continued)

Blinking pattern		Problem description	Suggested resolution
Amber	White		
2	5	Invalid memory installed	Reset the memory module. If problem continues, replace the memory module.
2	6	System-board or chipset error	Flash the latest BIOS version. If problem continues, replace the system board.
2	7	Display failure	Flash the latest BIOS version. If problem continues, replace the LCD module.
2	8	LCD power rail failure	Replace the system board.
3	1	CMOS battery failure	Reset the CMOS battery connection. If problem continues, replace the RTS battery.
3	2	PCI, video card/chip failure	Replace the system board.
3	3	Recovery image not found	Flash the latest BIOS version. If problem continues, replace the system board.
3	4	Recovery image found but invalid	Flash the latest BIOS version. If problem continues, replace the system board.
3	5	Power-rail failure	EC ran into power sequencing failure. If problem continues, replace the system board.
3	6	System BIOS Flash incomplete	Flash corruption detected by BIOS. If problem continues, replace the system board.
3	7	Management Engine (ME) error	Timeout error displayed while waiting on ME to reply to HECI message. If problem continues, replace the system board.
4	1	Memory DIMM power rail failure	Replace the system board.
4	2	CPU power cable connection issue	Initiate PSU BIST. If problem persists, replace the system board.

Recovering the operating system

When your computer is unable to boot to the operating system even after repeated attempts, it automatically starts Dell SupportAssist OS Recovery.

Dell SupportAssist OS Recovery is a standalone tool that is preinstalled in all Dell computers installed with Windows 10 operating system. It consists of tools to diagnose and troubleshoot issues that may occur before your computer boots to the operating system. It enables you to diagnose hardware issues, repair your computer, back up your files, or restore your computer to its factory state.

You can also download it from the Dell Support website to troubleshoot and fix your computer when it fails to boot into their primary operating system due to software or hardware failures.

For more information about the Dell SupportAssist OS Recovery, see *Dell SupportAssist OS Recovery User's Guide* at www.dell.com/support.

Flashing BIOS (USB key)

Steps

1. Follow the procedure from step 1 to step 7 in "[Flashing the BIOS](#)" to download the latest BIOS setup program file.

2. Create a bootable USB drive. For more information see the knowledge base article [SLN143196](#) at www.dell.com/support.
3. Copy the BIOS setup program file to the bootable USB drive.
4. Connect the bootable USB drive to the computer that needs the BIOS update.
5. Restart the computer and press **F12** when the Dell logo is displayed on the screen.
6. Boot to the USB drive from the **One Time Boot Menu**.
7. Type the BIOS setup program filename and press **Enter**.
8. The **BIOS Update Utility** appears. Follow the instructions on the screen to complete the BIOS update.

Flashing the BIOS

About this task

You may need to flash (update) the BIOS when an update is available or when you replace the system board.

Follow these steps to flash the BIOS:

Steps

1. Turn on your computer.
2. Go to www.dell.com/support.
3. Click **Product support**, enter the Service Tag of your computer, and then click **Submit**.

 **NOTE:** If you do not have the Service Tag, use the auto-detect feature or manually browse for your computer model.

4. Click **Drivers & downloads > Find it myself**.
5. Select the operating system installed on your computer.
6. Scroll down the page and expand **BIOS**.
7. Click **Download** to download the latest version of the BIOS for your computer.
8. After the download is complete, navigate to the folder where you saved the BIOS update file.
9. Double-click the BIOS update file icon and follow the instructions on the screen.

WiFi power cycle

About this task

If your computer is unable to access the internet due to WiFi connectivity issues a WiFi power cycle procedure may be performed. The following procedure provides the instructions on how to conduct a WiFi power cycle:

 **NOTE:** Some ISPs (Internet Service Providers) provide a modem/router combo device.

Steps

1. Turn off your computer.
2. Turn off the modem.
3. Turn off the wireless router.
4. Wait for 30 seconds.
5. Turn on the wireless router.
6. Turn on the modem.
7. Turn on your computer.

Flea power release

About this task

Flea power is the residual static electricity that remains on the computer even after it has been powered off and the battery has been removed. The following procedure provides the instructions on how to conduct flea power release:

Steps

1. Turn off your computer.
2. Disconnect the power adapter from your computer.
3. Press and hold the power button for 15 seconds to drain the flea power.
4. Connect the power adapter to your computer.
5. Turn on your computer.

Getting help and contacting Dell

Self-help resources

You can get information and help on Dell products and services using these self-help resources:

Table 20. Self-help resources

Self-help resources	Resource location
Information about Dell products and services	www.dell.com
Tips	
Contact Support	In Windows search, type <code>Contact Support</code> , and press Enter.
Online help for operating system	www.dell.com/support/windows www.dell.com/support/linux
Troubleshooting information, user manuals, setup instructions, product specifications, technical help blogs, drivers, software updates, and so on.	www.dell.com/support
Dell knowledge base articles for a variety of computer concerns.	<ol style="list-style-type: none"> 1. Go to https://www.dell.com/support/home/?app=knowledgebase. 2. Type the subject or keyword in the Search box. 3. Click Search to retrieve the related articles.

Contacting Dell

To contact Dell for sales, technical support, or customer service issues, see www.dell.com/contactdell.

 **NOTE:** Availability varies by country and product, and some services may not be available in your country.

 **NOTE:** If you do not have an active internet connection, you can find contact information on your purchase invoice, packing slip, bill, or Dell product catalog.