

x530 Series

Stackable Gigabit Layer 3+ Ethernet Switches
AlliedWare Plus™ v5.5.1

- x530-10GHXm
- x530-18GHXm
- x530-28GTXm
- x530-28GPXm
- x530-52GTXm
- x530-52GPXm

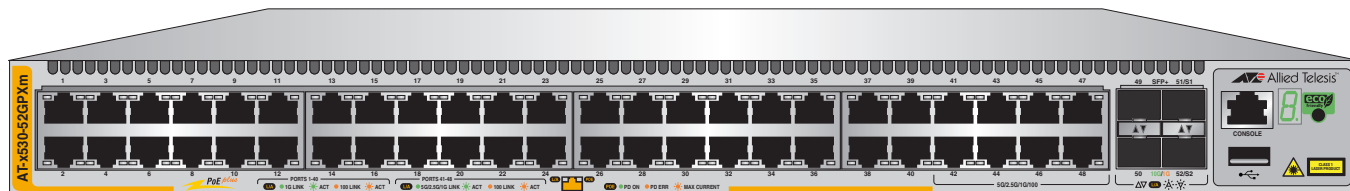
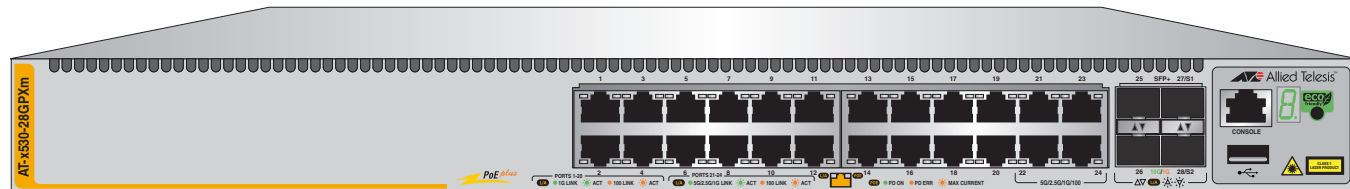
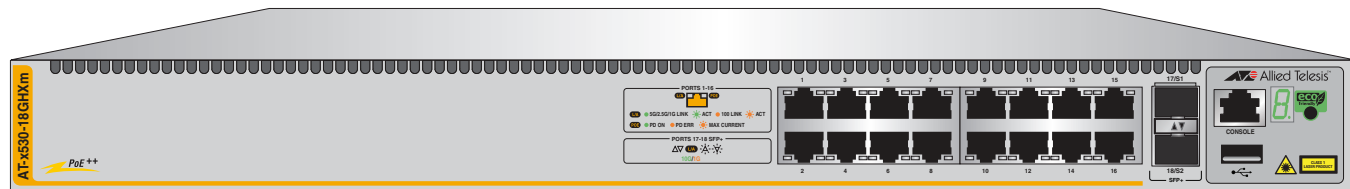
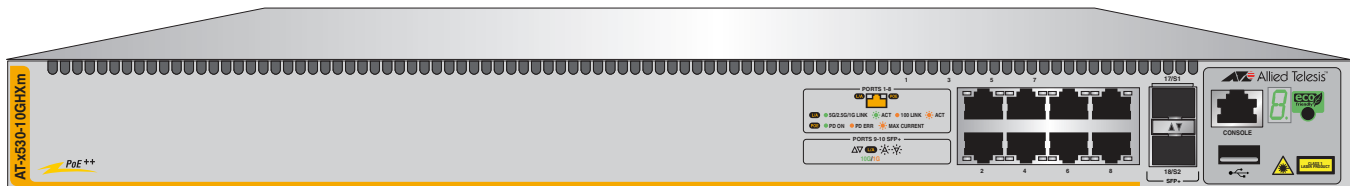

Installation Guide for Standalone Switches

Copyright © 2022 Allied Telesis, Inc.

All rights reserved. No part of this publication may be reproduced without prior written permission from Allied Telesis, Inc.

Allied Telesis, VCStack, and the Allied Telesis logo are trademarks of Allied Telesis, Incorporated. All other product names, company names, logos or other designations mentioned herein are trademarks or registered trademarks of their respective owners.

Allied Telesis, Inc. reserves the right to make changes in specifications and other information contained in this document without prior written notice. The information provided herein is subject to change without notice. In no event shall Allied Telesis, Inc. be liable for any incidental, special, indirect, or consequential damages whatsoever, including but not limited to lost profits, arising out of or related to this manual or the information contained herein, even if Allied Telesis, Inc. has been advised of, known, or should have known, the possibility of such damages.

Electrical Safety and Emissions Standards

This product meets the following standards.

U.S. Federal Communications Commission

Radiated Energy

Note: This equipment has been tested and found to comply with the limits for a Class A digital device pursuant to Part 15 of FCC Rules. These limits are designed to provide reasonable protection against harmful interference when the equipment is operated in a commercial environment. This equipment generates, uses, and can radiate radio frequency energy and, if not installed and used in accordance with this instruction manual, may cause harmful interference to radio communications. Operation of this equipment in a residential area is likely to cause harmful interference in which case the user will be required to correct the interference at his own expense.

Note: Modifications or changes not expressly approved of by the manufacturer or the FCC, can void your right to operate this equipment.

Industry Canada

This Class A digital apparatus complies with Canadian ICES-003.

Cet appareil numérique de la classe A est conforme à la norme NMB-003 du Canada.

RFI Emissions: FCC part15 Subpart B Class A, ICES-003 Class A, EN55032 Class A, CISPR 32 Class A, VCCI Class A, RCM AS/NZS CISPR 32 Class A

Warning: In a domestic environment this product may cause radio interference in which case the user may be required to take adequate measures.

EMC (Immunity): EN55035

Electrical Safety: UL 62368-1, CSA C22.2 No.62368-1, EN 62368-1, IEC62368-1, EN(IEC) 60825-1

Compliance Marks: CE, cUL_{US}, UL-EU, RCM



Laser Safety

EN(IEC) 60825-1

Translated Safety Statements

Important: Safety statements that have the  symbol are translated into multiple languages in the *Translated Safety Statements* document at www.alliedtelesis.com/translated-safety-statements.

Remarque: Les consignes de sécurité portant le symbole  sont traduites dans plusieurs langues dans le document *Translated Safety Statements*, disponible à l'adresse www.alliedtelesis.com/translated-safety-statements.

Contents

Preface:	11
Document Conventions	12
Contacting Allied Telesis	13
Chapter 1: Overview	15
Front and Rear Panels	16
Management Panel	19
Features	20
x530 Models	20
Twisted Pair Ports	21
Power Over Ethernet	22
SFP+ Transceiver Ports	23
LEDs	24
Installation Options	24
Management Software and Interfaces	24
Management Methods	24
Twisted Pair Ports	25
Duplex Mode	30
Wiring Configuration	31
Cable Requirements	31
Port Pinouts	31
LEDs	31
Power Over Ethernet	40
PoE Standards	40
Powered Device Classes	41
Power Budget	41
Port Prioritization	41
Wiring Implementation	43
SFP+ Transceiver Ports	44
1 Gbps SFP/10 Gbps SFP+ Transceivers	44
LEDs	44
eco-friendly Button	46
VCStack Feature	47
Switch ID LED	48
USB Port	50
Console Port	51
Power Supply	52
Software and Hardware Releases	53
Chapter 2: Beginning the Installation	55
Reviewing Safety Precautions	56
Choosing a Site for the Switch	61
Unpacking the Switch	62
Chapter 3: Installing the Switch on a Table	65
Chapter 4: Installing the Switch in an Equipment Rack	69
Beginning the Installation	70
Required Items	70
Switch Orientations in the Equipment Rack	70
Removing the Bumper Feet	72

Installing the Switch	73
Chapter 5: Installing the Switch on a Wall	75
Switch Orientations on a Wall	76
Installation Guidelines	78
Tools and Material	78
Plywood Base for a Wall with Wooden Studs	80
Installing a Plywood Base	81
Installing the Switch on a Plywood Base	82
Installing the Switch on a Concrete Wall	87
Chapter 6: Powering On the Switch	91
Powering On the Switch	92
Monitoring the Initialization Processes	95
Chapter 7: Configuring the Switch for Standalone Operations	99
Determining the Standalone or Stacking Status of the Switch	100
Starting a Local Management Session	101
Disabling the VCStack Feature	103
Saving Your Changes and Rebooting the Switch	105
Specifying Ports in the Command Line Interface for Standalone Switches	106
Chapter 8: Cabling the Networking Ports	107
Cabling Twisted Pair Ports	108
Guidelines to Handling SFP and SFP+ Transceivers	109
Installing SFP or SFP+ Transceivers in the Switch	110
Installing SP10TW Direct Connect Twinax Cables	112
Chapter 9: Troubleshooting	115
Technical Specifications	119
Physical Specifications	120
Dimensions	120
Weights	122
Ventilation	122
Environmental Specifications	123
Power Specifications	124
Maximum Power Consumption	124
Input Voltages	124
Heat Dissipation	125
RJ-45 Twisted Pair Port Pinouts	126
RJ-45 Style Serial Console Port Pinouts	127
USB Port	128

Figures

Figure 1: Front Panel of the x530-10GHXm Switch.....	16
Figure 2: Front Panel of the x530-18GHXm Switch.....	16
Figure 3: Front Panel of the x530-28GTXm Switch.....	16
Figure 4: Front Panel of the x530-28GPXm Switch.....	17
Figure 5: Front Panel of the x530-52GTXm Switch.....	17
Figure 6: Front Panel of the x530-52GPXm Switch.....	17
Figure 7: Back Panel of the x530-10GHXm, x530-18GHXm, AT-x530L-28GPXm, and AT-x530L-52GPXm PoE Switches.....	18
Figure 8: Back Panel of the x530-28GTXm and AT-x530L-52GTXm Non-PoE Switches.....	18
Figure 9: Management Panel.....	19
Figure 10: x530-10GHXm Twisted Pair Ports.....	32
Figure 11: x530-18GHXm Twisted Pair Ports.....	33
Figure 12: x530-28GTXm and x530-52GTXm Twisted Pair Ports LEDs.....	35
Figure 13: x530-28GPXm and x530-52GPXm Twisted Pair Ports LEDs.....	37
Figure 14: Link and Activity LEDs for the 1 Gbps/10 Gbps SFP+ Ports.....	44
Figure 15: Switch ID LED.....	48
Figure 16: Switch ID LED Description.....	49
Figure 17: Switch Shipping Box.....	62
Figure 18: Accessory Kit Items.....	63
Figure 19: Parts of the Bumper Feet.....	65
Figure 20: Holes for Bumper Feet.....	66
Figure 21: Inserting the Rivet Housing into the Bumper Foot.....	66
Figure 22: Placing the Bumper Foot on a Base Corner Hole.....	67
Figure 23: Inserting the Rivet into the Bumper Foot.....	67
Figure 24: Bracket Holes on the Switch.....	70
Figure 25: Switch Orientations in an Equipment Rack.....	71
Figure 26: Removing the Bumper Feet.....	72
Figure 27: Example of Attaching the Brackets to the Switch.....	73
Figure 28: Installing the Switch in an Equipment Rack.....	74
Figure 29: Positioning the x530-28GTXm Switch on the Wall.....	76
Figure 30: Positioning the x530-10GHXm, x530-18GHXm, x530-28GPXm, x530-52GTXm, or x530-52GPXm Switch on the Wall.....	77
Figure 31: Switch on the Wall with a Plywood Base.....	80
Figure 32: Installing the Plywood Base to the Wall.....	81
Figure 33: Installing Two Brackets on the x530-28GTXm Switch.....	83
Figure 34: Installing Four Brackets on the x530-10GHXm, x530-18GHXm, x530-28GPXm, x530-28GPXm or x530-28GTXm Switch.....	84
Figure 35: Securing the x530-28GTXm Switch to the Plywood Base.....	85
Figure 36: Securing the x530-10GHXm, x530-18GHXm, x530-28GPXm, x530-52GTXm or x530-52GPXm Switch to the Plywood Base.....	86
Figure 37: Marking the Locations of the Bracket Holes on a Concrete Wall.....	88
Figure 38: Installing the Switch on a Concrete Wall.....	89
Figure 39: Installing the Power Cord Retaining Clip.....	92
Figure 40: Connecting the AC Power Cords.....	93
Figure 41: Lowering the Power Cord Retaining Clips.....	93
Figure 42: Connecting the Power Cords to an AC Power Source.....	94
Figure 43: Switch Initialization Messages.....	95
Figure 44: Switch Initialization Messages (Continued).....	96
Figure 45: Switch Initialization Messages (Continued).....	97

Figures

Figure 46: Connecting the Management Cable to the Console Port 101

Figure 47: SHOW STACK Command 103

Figure 48: Moving to the Global Configuration Mode 104

Figure 49: Disabling VCStack 104

Figure 50: Returning to the Privileged Exec Mode 105

Figure 51: Saving the Changes with the WRITE Command 105

Figure 52: PORT Parameter in the Command Line Interface 106

Figure 53: Installing an SFP Transceiver 110

Figure 54: Positioning the SFP or SFP+ Handle in the Upright Position 111

Figure 55: Connecting a Fiber Optic Cable to an SFP or SFP+ Transceiver 111

Figure 56: Installing SP10TW Cables 113

Figure 57: x530-10GHXm Dimensions 120

Figure 58: x530-18GHXm Dimensions 121

Figure 59: x530-28GTXm Dimensions 121

Figure 60: x530-28GPXm Dimensions 121

Figure 61: x530-52GTXm Dimensions 121

Figure 62: x530-52GPXm Dimensions 122

Figure 63: RJ-45 Socket Pin Layout (Front View)..... 126

Tables

Table 1: Basic Features	20
Table 2: Twisted Pair Port Features	21
Table 3: x530-10GHXm Switch Twisted Pair Port Specifications	25
Table 4: x530-18GHXm Switch Twisted Pair Port Specifications	26
Table 5: x530-28GTXm Switch Twisted Pair Port Specifications	27
Table 6: x530-28GPXm Switch Twisted Pair Port Specifications	28
Table 7: x530-52GTXm Switch Twisted Pair Port Specifications	29
Table 8: x530-52GPXm Switch Twisted Pair Port Specifications	30
Table 9: x530-10GHXm Twisted Pair Ports 1 - 8 LED Functions	32
Table 10: x530-18GHXm Twisted Pair Ports 1 - 16 LED Functions	34
Table 11: x530-28GTXm Twisted Pair Ports 1 - 24 LED Functions	35
Table 12: x530-52GTXm Twisted Pair Ports 1 - 48 LED Functions	36
Table 13: x530-28GPXm Twisted Pair Ports 1 - 24 LED Functions	37
Table 14: x530-52GPXm Twisted Pair Ports 1 - 48 LED Functions	39
Table 15: IEEE Powered Device Classes	41
Table 16: Link and Activity Status LEDs for the 1 Gbps and 10 Gbps Ports	45
Table 17: Software and Hardware Releases	53
Table 18: Accessory Kit Items	64
Table 19: PORT Parameter Format	106
Table 20: Product Dimensions	120
Table 21: Product Weights	122
Table 22: Ventilation Requirements	122
Table 23: Environmental Specifications	123
Table 24: Maximum Power Consumptions	124
Table 25: Input Voltages	124
Table 26: Heat Dissipation	125
Table 27: Pin Signals for 100M/1G/2.5G/5G Base-T Connectors	126
Table 28: RJ-45 Style Serial Console Port Pin Signals	127
Table 29: USB Port Pin Signals	128

Preface

This guide contains the installation instructions for the x530 Series of stackable Gigabit, Layer 3+ Ethernet switches. This preface contains the following sections:

- “Document Conventions” on page 12
- “Contacting Allied Telesis” on page 13

Note

This guide explains how to install the switches as standalone units. For instructions on how to build a stack with Virtual Chassis Stacking (VCStack™), refer to the *x530 Series Installation Guide for Virtual Chassis Stacking*.

Document Conventions

This document uses the following conventions:

Note

Notes provide additional information.



Caution

Cautions inform you that performing or omitting a specific action may result in equipment damage or loss of data.



Warning

Warnings inform you that performing or omitting a specific action may result in bodily injury.

Contacting Allied Telesis

If you need assistance with this product, you may contact Allied Telesis technical support by going to the Services & Support section of the Allied Telesis web site at **www.alliedtelesis.com/support**. You can find links for the following services on this page:

- ❑ Helpdesk (Support Portal) - Log onto Allied Telesis interactive support center to search for answers to your questions in our knowledge database, check support tickets, learn about Return Merchandise Authorizations (RMAs), and contact Allied Telesis technical experts.
- ❑ Software Downloads - Download the latest software releases for your product.
- ❑ Licensing - Register and obtain your License key to activate your product.
- ❑ Product Documents - View the most recent installation guides, user guides, software release notes, white papers and data sheets for your product.
- ❑ Warranty - View a list of products to see if Allied Telesis warranty applies to the product you purchased and register your warranty.
- ❑ Allied Telesis Helpdesk - Contact a support representative.

To contact a sales representative or find Allied Telesis office locations, go to **www.alliedtelesis.com/contact**.

Chapter 1

Overview

This chapter contains the following sections:

- “Front and Rear Panels” on page 16
- “Management Panel” on page 19
- “Features” on page 20
- “Twisted Pair Ports” on page 25
- “Power Over Ethernet” on page 40
- “SFP+ Transceiver Ports” on page 44
- “eco-friendly Button” on page 46
- “VCStack Feature” on page 47
- “Switch ID LED” on page 48
- “USB Port” on page 50
- “Console Port” on page 51
- “Power Supply” on page 52
- “Software and Hardware Releases” on page 53

Note

This guide explains how to install the switches as standalone units. For instructions on how to build a stack with Virtual Chassis Stacking (VCStack™), refer to the *x530 Series Installation Guide for Virtual Chassis Stacking*.

Front and Rear Panels

The front panels on the x530 Series switches are shown in Figure 1 through Figure 6 on page 17.



Figure 1. Front Panel of the x530-10GHXm Switch

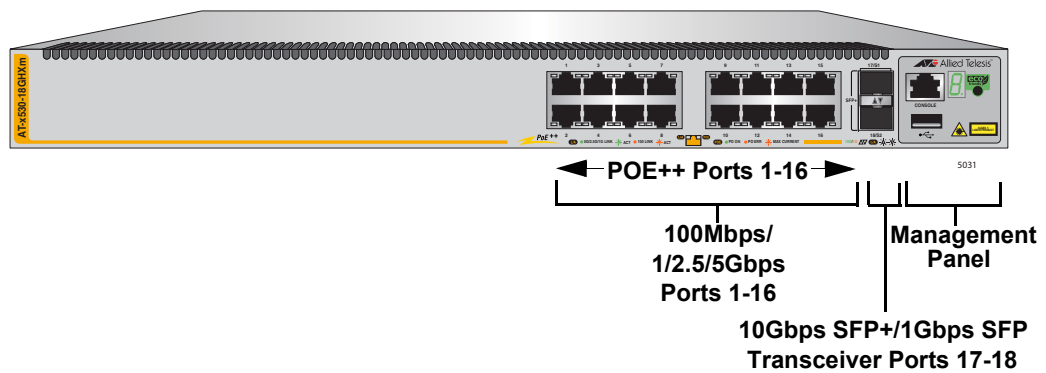

Figure 2. Front Panel of the x530-18GHXm Switch

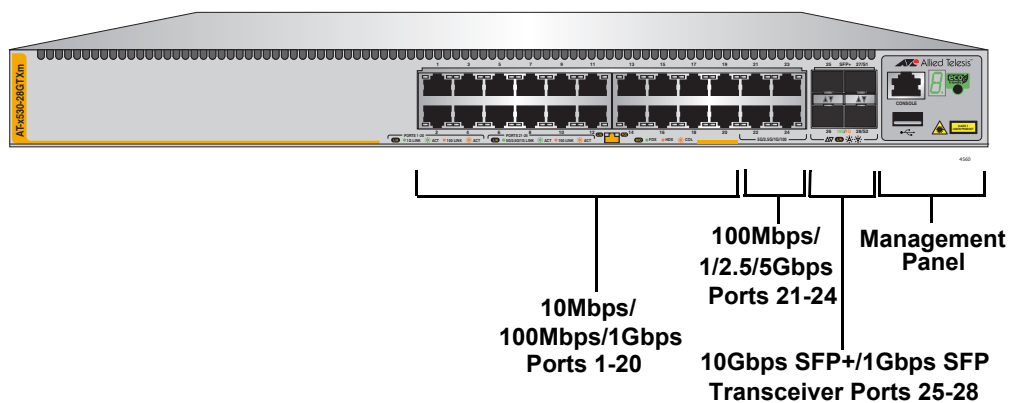

Figure 3. Front Panel of the x530-28GTXm Switch

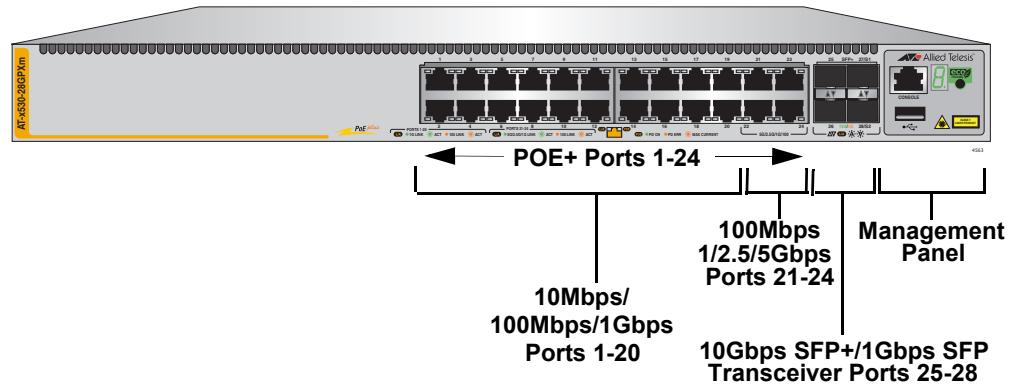

Figure 4. Front Panel of the x530-28GPXm Switch

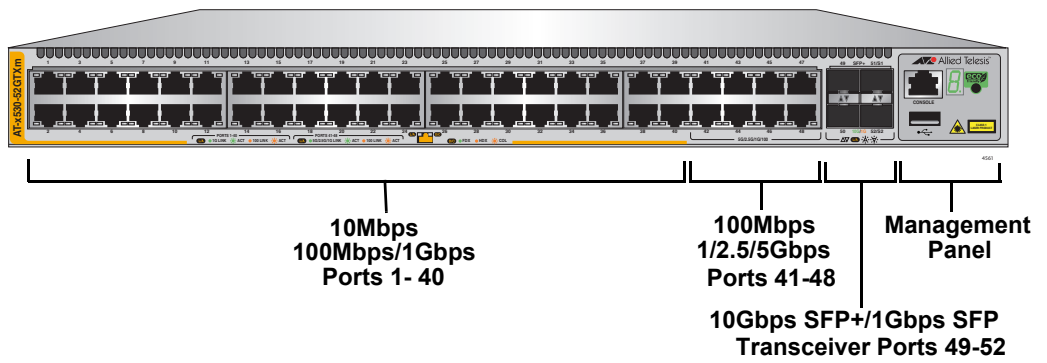

Figure 5. Front Panel of the x530-52GTXm Switch

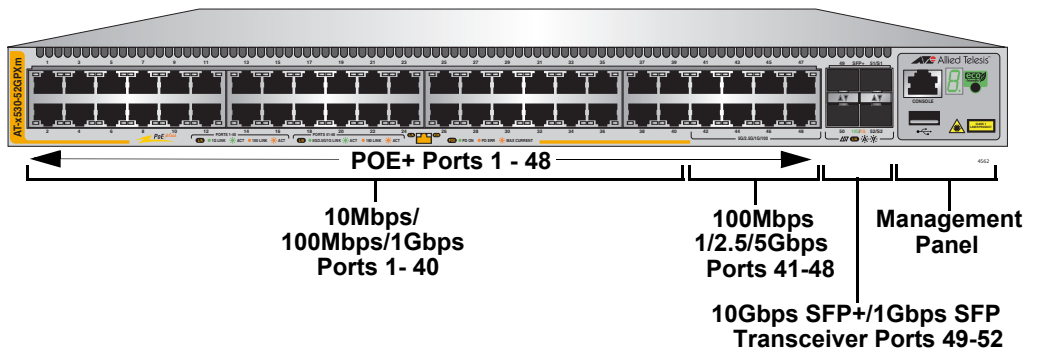

Figure 6. Front Panel of the x530-52GPXm Switch

The back panels of the x530 Series switches is shown in Figure 7 and Figure 8..

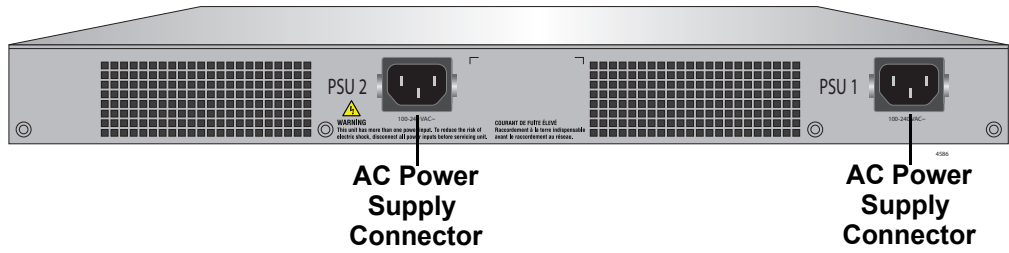

Figure 7. Back Panel of the x530-10GHXm, x530-18GHXm, AT-x530L-28GPXm, and AT-x530L-52GPXm PoE Switches

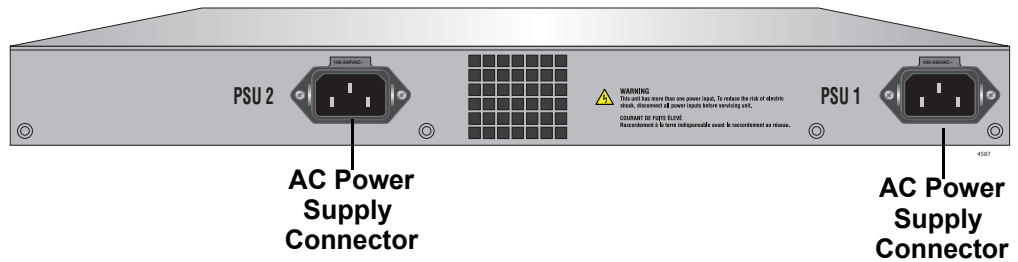

Figure 8. Back Panel of the x530-28GTXm and AT-x530L-52GTXm Non-PoE Switches

Management Panel

Figure 9 identifies the components on the management panel.

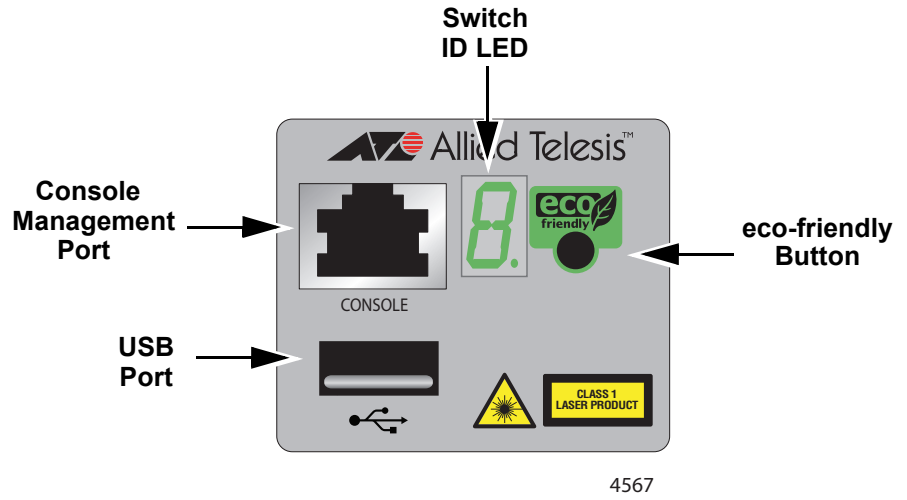

Figure 9. Management Panel

Features

The Allied Telesis x530 Series switches are stackable Gigabit, Layer 3+ Ethernet switches. The following sections list the features.

x530 Models Table 1 lists the basic features for each switch model.

Table 1. Basic Features

Feature	x530-10GHXm (PoE++)	x530-18GHXm (PoE++)	x530-28GTXm	x530-28GPXm (PoE+)	x530-52GTXm	x530-52GPXm (PoE+)
10Mbps, 100Mbps and 1Gbps Twisted Pair Ports (Non-PoE)	-	-	20	-	40	-
10Mbps, 100Mbps and 1Gbps PoE+ Twisted Pair Ports	-	-	-	20	-	40
100Mbps and 1/2.5/5Gbps Twisted Pair Ports (Non-PoE)	-	-	4	-	8	-
100 Mbps and 1/2.5/5 Gbps PoE+ Twisted Pair Ports	-	-	-	4	-	8
100 Mbps and 1/2.5/5 Gbps PoE++ Twisted Pair Ports	8	16	-	-	-	-
1 Gbps SFP and 10 Gbps SFP+ Transceiver Ports	2	2	4	4	4	4
VCStack	Yes	Yes	Yes	Yes	Yes	Yes
Pre-installed Power Supply (Not Field Replaceable)	2	2	2	2	2	2

Twisted Pair Ports

Table 2 lists the twisted pair ports features for each switch model.

Table 2. Twisted Pair Port Features

Feature	x530-10GHXm (PoE++)	x530-18GHXm (PoE++)	x530-28GTXm	x530-28GPXm (PoE+)	x530-52GTXm	x530-52GPXm (PoE+)
Ports 1 to 8 support 100 Mbps and 1/2.5/5 Gbps operation	Yes	-	-	-	-	-
Ports 1 to 16 support 100 Mbps and 1/2.5/5 Gbps operation	-	Yes	-	-	-	-
Ports 1 to 20 support 10 Mbps, 100 Mbps and 1 Gbps operation	-	-	Yes	Yes	-	-
Ports 21 to 24 support 100 Mbps and 1/2.5/5 Gbps operation	-	-	Yes	Yes	-	-
Ports 1 to 40 support 10 Mbps, 100 Mbps and 1 Gbps operation	-	-	-	-	Yes	Yes
Ports 41 to 48 support 100 Mbps and 1/2.5/5 Gbps operation	-	-	-	-	Yes	Yes
100 meters (328 feet) maximum operating distance per port	Yes	Yes	Yes	Yes	Yes	Yes
Auto-Negotiation for speed	Yes	Yes	Yes	Yes	Yes	Yes
Full-duplex mode only	Yes	Yes	Yes	Yes	Yes	Yes
MDI/MDI-X at 10 Mbps and 100 Mbps	Yes	Yes	Yes	Yes	Yes	Yes
Port Link/Activity (L/A) and Duplex/Collision (D/C) LEDs	-	-	Yes	-	Yes	-
Power over Ethernet (PoE++) supported on all ports	Yes	Yes	-	-	-	-
Power over Ethernet (PoE+) supported on all ports	Yes	Yes	-	Yes	-	Yes
Port Link/Activity (L/A) and Power over Ethernet (PoE) LEDs	Yes	Yes	-	Yes	-	Yes

Power Over Ethernet

The basic features of PoE+ on the twisted pair ports on the x530-28GPXm and x530-52GPXm switches are:

- Supported on all ports.
- Supports PoE (15.4W maximum) and PoE+ (30W maximum) powered devices
- 740W maximum power budget (370W per power supply)
- Supports powered device classes 0 to 4
- Port prioritization
- Mode A wiring
- IEEE802.3af/at compliant

The basic features of PoE++ on the twisted pair ports on the x530-10GHXm switch are:

- Supported on all ports
- 720W maximum power budget (90W x 8 = 720W) (500W per power supply):
 - PoE (15.4W maximum) for 8 powered devices
 - PoE+ (30W maximum) for 8 powered devices
 - PoE++ (60W maximum) for 8 powered devices
 - PoE++ (90W maximum) for 8 powered devices
- Supports powered device classes 0 to 8
- Port prioritization
- Mode A and Mode B wiring
- IEEE802.3af/at/bt compliant

The basic features of PoE++ on the twisted pair ports on the x530-18GHXm switch are:

- Supported on all ports
- 1,000W maximum power budget (500W per power supply):
 - PoE (15.4W maximum) for 16 powered devices
 - PoE+ (30W maximum) for 16 powered devices
 - PoE++ (60W maximum) for 16 powered devices
 - PoE++ (90W maximum) for 11 powered devices
- Supports powered device classes 0 to 8
- Port prioritization
- Mode A and Mode B wiring
- IEEE802.3af/at/bt compliant

SFP+ Transceiver Ports

The SFP+ transceiver ports support the following types of transceivers:

Examples of SFP 1Gbps transceivers include:

- ❑ SPSX and LR short and long distance transceivers using multi-mode or single mode fiber optic cable.
- ❑ SPEX transceivers with a maximum distance of two kilometers with multi-mode fiber optic cable.
- ❑ SP10BD bidirectional transceivers for single mode fiber optic cable with a maximum distance of 10 kilometers.

Examples of SFP+ 10Gbps transceivers include:

- ❑ SP10SR, LR, ER and ZR series of short or long distance transceivers using multi-mode or single mode fiber optic cable.
- ❑ SP10TW series of direct attach cables in lengths of 1 meter and 3 meters.
- ❑ SP10T transceiver with RJ-45 connector for links up to 20 meters at 10Gbps with Category 6a or better twisted pair cable, or 100 meters at 1Gbps.
- ❑ AT-SP10LRM Long Reach Multimode transceiver for OM1 multi-mode fiber optic links up to 220 meters.

Note

Industrial (-40 to 85° C) and extended (-40 to 105° C) temperature transceivers are available.

Note

For a current list of supported transceiver modules refer to the *x530 Series Datasheet*.

The following restrictions on SFP+ transceivers apply:

- ❑ 100 Mbps transceivers are not supported
- ❑ Supports full-duplex mode only

SFP and SFP+ transceivers must be purchased separately.

LEDs

The port LEDs are:

- Link/activity LEDs for the twisted pair ports
- Link/activity LEDs for the SFP and SFP+ transceiver ports
- Full/Half/Collision LEDs for the twisted pair ports on the x530-28GTXm and x530-52GTXm switches
- PoE+ LEDs for the twisted pair ports on the x530-28GPXm and x530-52GPXm switches
- PoE++ LEDs for the twisted pair ports on the x530-10GHXm and x530-18GHXm switches
- Switch ID number LED

Installation Options

The installation options are:

- Desk or tabletop
- 19-inch equipment rack
- Wood or concrete wall

Management Software and Interfaces

The management software and interfaces are:

- AlliedWare Plus Management Software
- Command line interface (CLI)

Management Methods

The following methods are used for managing the switches:

- Local management through the Console port
- Remote Telnet or Secure Shell management
- Vista Manager mini
- Autonomous Management Framework (AMF) with Vista Manager EX
- Autonomous Wave Control for wireless networks
- SNMPv1, v2c, and v3

Twisted Pair Ports

The specifications of the twisted pair ports are listed in:

- ❑ Table 3 for the x530-10GHXm switch, next
- ❑ Table 4 on page 26 for the x530-18GHXm switch
- ❑ Table 5 on page 27 for the x530-28GTXm switch
- ❑ Table 6 on page 28 for the x530-28GPXm switch
- ❑ Table 7 on page 29 for the x530-52GTXm switch
- ❑ Table 8 on page 30 for the x530-52GPXm switch.

Table 3. x530-10GHXm Switch Twisted Pair Port Specifications

Specification	Description
Port Speed	Ports 1 - 8: 100Mbps or 1/2.5/5Gbps. 100Mbps: Set the port speed manually or with Auto-Negotiation. 1/2.5/5Gbps: The port speed is set with Auto-Negotiation only. The default is Auto-Negotiation for all ports.
Duplex Mode	Ports 1 - 8: 100Mbps: Full- or half-duplex mode. 1/2.5/5Gbps: Full-duplex mode only. Supports Auto-Negotiation at 100Mbps.
Maximum Distance	100 meters (328 feet)
Power over Ethernet	<ul style="list-style-type: none"> ❑ PoE (15.4W maximum per port) / 8 PDs ❑ PoE+ (30W maximum per port) / 8 PDs ❑ PoE++(60W maximum per port) / 8 PDs ❑ PoE++(90W maximum per port) / 8 PDs
Maximum Power Budget	720W maximum power budget (90W x 8 = 720W) (500W per power supply):
PoE Mode	Classes 0 to 8: Mode A and B (all eight strands)
Connector	8-pin RJ-45

Table 4. x530-18GHXm Switch Twisted Pair Port Specifications

Specification	Description
Port Speed	Ports 1 - 16: 100Mbps or 1/2.5/5Gbps. 100Mbps: Set the port speed manually or with Auto-Negotiation. 1/2.5/5Gbps: The port speed is set with Auto-Negotiation only. The default is Auto-Negotiation for all ports.
Duplex Mode	Ports 1 - 16: 100Mbps: Full- or half-duplex mode. 1/2.5/5Gbps: Full-duplex mode only. Supports Auto-Negotiation at 100Mbps.
Maximum Distance	100 meters (328 feet)
Power over Ethernet	<input type="checkbox"/> PoE (15.4W maximum per port) / 16 PDs <input type="checkbox"/> PoE+ (30W maximum per port) / 16 PDs <input type="checkbox"/> PoE++(60W maximum per port) / 16 PDs <input type="checkbox"/> PoE++(90W maximum per port) / 11 PDs
Maximum Power Budget	1,000W (500W per power supply)
PoE Mode	Classes 0 to 8: Mode A and B (all eight strands)
Connector	8-pin RJ-45

Table 5. x530-28GTXm Switch Twisted Pair Port Specifications

Specification	Description
Port Speed	<p>Ports 1 - 20: 10Mbps, 100Mbps or 1Gbps. Ports 21 - 24: 100Mbps or 1/2.5/5Gbps</p> <p>Ports 1 - 20: Set the port speed manually or with Auto-Negotiation at 10Mbps and 100Mbps.</p> <p>Ports 21 - 24: The port speed is set with Auto-Negotiation only, at 1Gbps and higher.</p> <p>The default is Auto-Negotiation for all ports.</p>
Duplex Mode	<p>Ports 1 - 20: Full- or half-duplex mode at 10Mbps and 100Mbps. Full-duplex only at 1Gbps. Supports Auto-Negotiation at 10Mbps and 100Mbps.</p> <p>Ports 21- 24: Full-duplex only at all speeds.</p>
Maximum Distance	100 meters (328 feet).
Connector	8-pin RJ-45.

Table 6. x530-28GPXm Switch Twisted Pair Port Specifications

Specification	Description
Port Speed	<p>Ports 1 - 20: 10Mbps, 100Mbps or 1 Gbps. Ports 21 - 24: 100Mbps or 1/2.5/5Gbps</p> <p>Ports 1 - 20: Set the port speed manually or with Auto-Negotiation at 10Mbps and 100Mbps.</p> <p>Ports 21 - 24: The port speed is set with Auto-Negotiation only, at 1Gbps and higher.</p> <p>The default is Auto-Negotiation for all ports.</p>
Duplex Mode	<p>Ports 1 - 20: Full- or half-duplex mode at 10Mbps and 100Mbps. Full-duplex only at 1Gbps. Supports Auto-Negotiation at 10Mbps and 100Mbps.</p> <p>Ports 21- 24: Full-duplex only at all speeds.</p>
Maximum Distance	100 meters (328 feet).
Power over Ethernet	PoE (15.4W maximum per port) and PoE+ (30W maximum per port).
Maximum Power Budget	740W (370W per power supply).
PoE Mode	Mode A.
Connector	8-pin RJ-45.

Table 7. x530-52GTXm Switch Twisted Pair Port Specifications

Specification	Description
Port Speed	<p>Ports 1 - 40: 10Mbps, 100Mbps or 1 Gbps. Ports 41 - 48: 100Mbps or 1/2.5/5Gbps</p> <p>Ports 1 - 40: Set the port speed manually or with Auto-Negotiation at 10Mbps, and 100Mbps.</p> <p>Ports 41 - 48: The port speed is set with Auto-Negotiation only, at 1Gbps and higher.</p> <p>The default is Auto-Negotiation for all ports.</p>
Duplex Mode	<p>Ports 1 - 40: Full- or half-duplex mode at 10Mbps or 100Mbps. Full-duplex only at 1Gbps. Supports Auto-Negotiation at 10Mbps and 100Mbps.</p> <p>Ports 41- 48: Full-duplex only at all speeds.</p>
Maximum Distance	100 meters (328 feet).
Connector	8-pin RJ-45.

Table 8. x530-52GPXm Switch Twisted Pair Port Specifications

Specification	Description
Port Speed	<p>Ports 1 - 40: 10Mbps, 100Mbps or 1 Gbps. Ports 41 - 48: 100Mbps or 1/2.5/5Gbps</p> <p>Ports 1 - 40: Set the port speed manually or with Auto-Negotiation at 10Mbps, and 100Mbps.</p> <p>Ports 41 - 48: The port speed is set with Auto-Negotiation only, at 1Gbps and higher.</p> <p>The default is Auto-Negotiation for all ports.</p>
Duplex Mode	<p>Ports 1 - 40: Full- or half-duplex mode at 10Mbps and 100Mbps. Full-duplex only at 1Gbps. Supports Auto-Negotiation at 10Mbps and 100Mbps.</p> <p>Ports 41- 48: Full-duplex only at all speeds.</p>
Maximum Distance	100 meters (328 feet).
Power over Ethernet	PoE (15.4W maximum per port) and PoE+ (30W maximum per port).
Maximum Power Budget	740W (370W per power supply).
PoE Mode	Mode A.
Connector	8-pin RJ-45.

Duplex Mode

The twisted pair ports can operate in either half- or full-duplex mode at 10 Mbps or 100 Mbps and full-duplex only at higher speeds.

The duplex mode of a port operating at 10 Mbps or 100 Mbps, like port speed, can be set manually using the management software or automatically with Auto-Negotiation (IEEE 802.3u), the default setting.

The speed and duplex mode settings of a port can be set independently of each other. For example in the case of a 10 Mbps or 100 Mbps port, it can be configured such that its speed is set manually while its duplex mode is established through Auto-Negotiation.

Note

Switch ports default to half-duplex mode when connected to 10 Mbps or 100 Mbps network devices that do not support Auto-Negotiation. If a network device supports full-duplex only, a duplex mode mismatch can occur, resulting in poor network performance. To prevent this, disable Auto-Negotiation and set the duplex mode manually on ports connected to 10 Mbps or 100 Mbps devices that support full-duplex only.

Wiring Configuration

The wiring configuration of a port operating at 10 Mbps or 100 Mbps can be MDI or MDI-X. The wiring configurations of a switch port and a network device connected with straight-through twisted pair cabling must be opposite, such that one device is using MDI and the other MDI-X. For example, a switch port must be set to MDI-X if it is connected to a network device set to MDI.

The wiring configurations of the ports can be set manually or automatically by the switch with auto-MDI/MDI-X (IEEE 802.3ab-compliant). This feature enables the switch to automatically negotiate with network devices to establish their proper settings.

The MDI and MDI-X settings do not apply when ports are operating at a speed of 1 Gbps or higher.

Cable Requirements

The minimum twisted pair cable requirements are as follows:

- ❑ 10/100 Mbps ports: Standard TIA/EIA 568-B-compliant Category 3 unshielded cabling
- ❑ 1 Gbps ports: Standard TIA/EIA 568-A-compliant Category 5 or TIA/EIA 568-B-compliant Enhanced Category 5 (Cat 5e)
- ❑ 2.5/5 Gbps ports: Standard TIA/EIA 568-A-compliant Category 6 or TIA/EIA 568-B-compliant Category 6A (Cat 6A) unshielded cabling

Port Pinouts

Refer to Table 27 on page 126 for the port pinouts of the 100 Mbps and 1/2.5/5 Gbps twisted pair ports.

LEDs

Each twisted pair port has two LEDs that display the port status.

x530-10GHXm

The LEDs indicate Link/Activity (L/A) and PoE (PD ON/PD ERR/MAX CURRENT) information. These LEDs are shown in Figure 10.

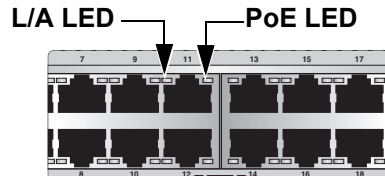

Figure 10. x530-10GHXm Twisted Pair Ports

The states of the x530-10GHXm LEDs are described in Table 9.

Table 9. x530-10GHXm Twisted Pair Ports 1 - 8 LED Functions

LED	Ports	State	Description
L/A	1 - 8	Solid Green	The port has established a 1/2.5/5 Gbps link to a network device.
		Flashing Green	The port is transmitting or receiving data at 1/2.5/5 Gbps.
		Solid Amber	The port has established a 100 Mbps link to a network device.
		Flashing Amber	The port is transmitting or receiving data at 100 Mbps.
		Off	Possible causes of this state are: - The port has not established a link with another network device. - The LEDs are turned off. To turn on the LEDs, use the eco-friendly button.

Table 9. x530-10GHXm Twisted Pair Ports 1 - 8 LED Functions (Continued)

LED	Ports	State	Description
PoE++	1-8	Solid Green	PD On - The switch is delivering power to a powered device connected to the port.
		Solid Amber	PD Error - The switch has shut down PoE on the port because of a fault condition.
		Flashing Amber	PD Max Current - The switch has detected a powered device on the port but is not delivering power to it because doing so would exceed its available power budget.
		Off	No PD - This LED state can result from the following conditions: <ul style="list-style-type: none"> - The port is not connected to a powered device or the device is powered off. - The port is disabled in the management software. - PoE is disabled on the port. - The LEDs are turned off. To turn on the LEDs, use the eco-friendly button.

x530-18GHXm

The LEDs indicate Link/Activity (L/A) and PoE (PD ON/PD ERR/MAX CURRENT) information. These LEDs are shown in Figure 10.

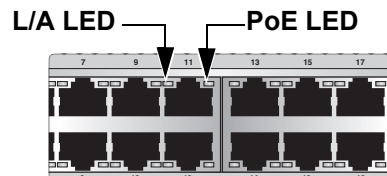

Figure 11. x530-18GHXm Twisted Pair Ports

The states of the x530-18GHXm LEDs are described in Table 9.

Table 10. x530-18GHXm Twisted Pair Ports 1 - 16 LED Functions

LED	Ports	State	Description
L/A	1 - 16	Solid Green	The port has established a 1/2.5/5 Gbps link to a network device.
		Flashing Green	The port is transmitting or receiving data at 1/2.5/5 Gbps.
		Solid Amber	The port has established a 100 Mbps link to a network device.
		Flashing Amber	The port is transmitting or receiving data at 100 Mbps.
		Off	Possible causes of this state are: - The port has not established a link with another network device. - The LEDs are turned off. To turn on the LEDs, use the eco-friendly button.
PoE++	1-16	Solid Green	PD On - The switch is delivering power to a powered device connected to the port.
		Solid Amber	PD Error - The switch has shut down PoE on the port because of a fault condition.
		Flashing Amber	PD Max Current - The switch has detected a powered device on the port but is not delivering power to it because doing so would exceed its available power budget.
		Off	No PD - This LED state can result from the following conditions: - The port is not connected to a powered device or the device is powered off. - The port is disabled in the management software. - PoE is disabled on the port. - The LEDs are turned off. To turn on the LEDs, use the eco-friendly button.

x530-28GTXm and x530-52GTXm

The x530-28GTXm and x530-52GTXm LEDs indicate Link/Activity (L/A) and Duplex/Collision (FDX/HDX/COL) information. These LEDs are shown in Figure 12.

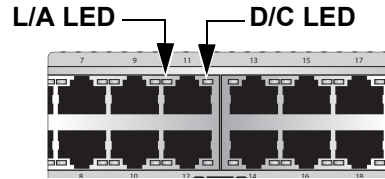

Figure 12. x530-28GTXm and x530-52GTXm Twisted Pair Ports LEDs

The states of the x530-28GTXm LEDs are described in Table 11.

Table 11. x530-28GTXm Twisted Pair Ports 1 - 24 LED Functions

LED	Ports	State	Description
L/A	1 - 20	Solid Green	The port has established a 1 Gbps link to a network device.
		Flashing Green	The port is transmitting or receiving data at 1 Gbps.
	21 - 24	Solid Green	The port has established a 1/2.5/5 Gbps link to a network device.
		Flashing Green	The port is transmitting or receiving data at 1/2.5/5 Gbps.
	1 - 24	Solid Amber	The port has established a 10 Mbps or 100 Mbps link to a network device.
		Flashing Amber	The port is transmitting or receiving data at 10 Mbps or 100 Mbps.
		Off	Possible causes of this state are: - The port has not established a link with another network device. - The LEDs are turned off. To turn on the LEDs, use the eco-friendly button.

Table 11. x530-28GTXm Twisted Pair Ports 1 - 24 LED Functions (Continued)

LED	Ports	State	Description
D/C	1 - 24	Solid Green	The port is operating in full-duplex mode.
		Solid Amber	The port is operating in half-duplex mode.
		Flashing Amber	The port is operating in half-duplex mode with collisions.

The states of the x530-52GTXm LEDs are described in Table 12.

Table 12. x530-52GTXm Twisted Pair Ports 1 - 48 LED Functions

LED	Ports	State	Description	
L/A	1 - 40	Solid Green	The port has established a 1 Gbps link to a network device.	
		Flashing Green	The port is transmitting or receiving data at 1 Gbps.	
	41 - 48	Solid Green	The port has established a 1/2.5/5 Gbps link to a network device.	
		Flashing Green	The port is transmitting or receiving data at 1/2.5/5 Gbps.	
	1 - 48	Solid Amber	The port has established a 10 Mbps or 100 Mbps link to a network device.	
		Flashing Amber	The port is transmitting or receiving data at 10 Mbps or 100 Mbps.	
		Off	Possible causes of this state are: - The port has not established a link with another network device. - The LEDs are turned off. To turn on the LEDs, use the eco-friendly button.	
	D/C	1 - 48	Solid Green	The port is operating in full-duplex mode.
			Solid Amber	The port is operating in half-duplex mode.
Flashing Amber			The port is operating in half-duplex mode with collisions.	

Note

See “SFP+ Transceiver Ports” on page 44 for a description of the LEDs for ports 25 to 28.

x530-28GPXm and x530-52GPXm

The x530-28GPXm and x530-52GPXm LEDs indicate Link/Activity (L/A) and PoE (PD ON/PD ERR/MAX CURRENT) information. These LEDs are shown in Figure 13.

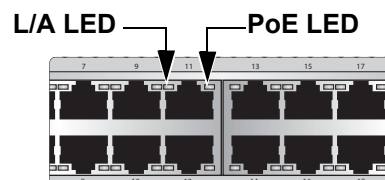

Figure 13. x530-28GPXm and x530-52GPXm Twisted Pair Ports LEDs

The states of the x530-28GPXm LEDs are described in Table 13.

Table 13. x530-28GPXm Twisted Pair Ports 1 - 24 LED Functions

LED	Ports	State	Description
L/A	1 - 20	Solid Green	The port has established a 1 Gbps link to a network device.
		Flashing Green	The port is transmitting or receiving data at 1 Gbps.
	21 - 24	Solid Green	The port has established a 1/2.5/5 Gbps link to a network device.
		Flashing Green	The port is transmitting or receiving data at 1/2.5/5 Gbps.
	1 - 24	Solid Amber	The port has established a 10 Mbps or 100 Mbps link to a network device.
		Flashing Amber	The port is transmitting or receiving data at 10 Mbps or 100 Mbps.
Off		Possible causes of this state are: <ul style="list-style-type: none"> - The port has not established a link with another network device. - The LEDs are turned off. To turn on the LEDs, use the eco-friendly button. 	

Table 13. x530-28GPXm Twisted Pair Ports 1 - 24 LED Functions (Continued)

LED	Ports	State	Description
PoE	1 - 24	Solid Green	PD On - The switch is delivering power to a powered device connected to the port.
		Solid Amber	PD Error - The switch has shut down PoE on the port because of a fault condition.
		Flashing Amber	PD Max Current - The switch has detected a powered device on the port but is not delivering power to it because doing so would exceed its available power budget.
		OFF	<p>No PD - This LED state can result from the following conditions:</p> <ul style="list-style-type: none"> - The port is not connected to a powered device or the device is powered off. - The port is disabled in the management software. - PoE is disabled on the port. - The LEDs are turned off. To turn on the LEDs, use the eco-friendly button.

Table 14. x530-52GPXm Twisted Pair Ports 1 - 48 LED Functions

LED	Ports	State	Description
L/A	1 - 40	Solid Green	The port has established a 1 Gbps link to a network device.
		Flashing Green	The port is transmitting or receiving data at 1 Gbps.
	41 - 48	Solid Green	The port has established a 1/2.5/5 Gbps link to a network device.
		Flashing Green	The port is transmitting or receiving data at 1/2.5/5 Gbps.
	1 - 48	Solid Amber	The port has established a 10 Mbps or 100 Mbps link to a network device.
		Flashing Amber	The port is transmitting or receiving data at 10 Mbps or 100 Mbps.
Off		Possible causes of this state are: <ul style="list-style-type: none"> - The port has not established a link with another network device. - The LEDs are turned off. To turn on the LEDs, use the eco-friendly button. 	
PoE	1 - 48	Solid Green	PD On - The switch is delivering power to a powered device connected to the port.
		Solid Amber	PD Error - The switch has shut down PoE on the port because of a fault condition.
		Flashing Amber	PD Max Current - The switch has detected a powered device on the port but is not delivering power to it because doing so would exceed its available power budget.
		Off	No PD - This LED state can result from the following conditions: <ul style="list-style-type: none"> - The port is not connected to a powered device or the device is powered off. - The port is disabled in the management software. - PoE is disabled on the port. - The LEDs are turned off. To turn on the LEDs, use the eco-friendly button.

Power Over Ethernet

The x530-10GHXm, x530-18GHXm, x530-28GPXm and x530-52GPXm switches feature PoE on twisted pair ports. With PoE, the switch supplies DC power to network devices over the same twisted pair cables that carry the network traffic.

PoE can make it easier to install networks. The selection of a location for a network device can be limited by whether there is a power source nearby. This often limits equipment placement or requires the added time and cost of having additional electrical sources installed. With PoE, you can install PoE-compatible devices wherever they are needed without having to worry about whether there are power sources nearby.

A device that provides PoE to network devices is referred to as *power sourcing equipment* (PSE). It functions as a central power source for other network devices.

Devices that receive their power from a PSE are called *powered devices* (PD). Examples include wireless access points, IP telephones, webcams, and even other Ethernet switches.

The x530-10GHXm, x530-18GHXm, x530-28GPXm and x530-52GPXm switches automatically determine whether devices connected to their ports are powered devices. Ports that are connected to network nodes that are not powered devices (that is, devices that receive their power from another power source) function as regular Ethernet ports, without PoE. The PoE feature remains activated on the ports but no power is delivered to the devices.

PoE Standards

The x530-10GHXm, x530-18GHXm, x530-28GPXm and x530-52GPXm switches support these PoE standards:

- ❑ PoE (IEEE 802.3af): This standard provides up to 15.4 watts at the switch port for powered devices that require up to 13.0 watts.
- ❑ PoE+ (IEEE 802.3at): This standard provides up to 30.0 watts at the switch port for powered devices that require up to 25.5 watts.

The x530-10GHXm and x530-18GHXm switches support this additional PoE standard:

- ❑ PoE++ (IEEE 802.3bt): This standard provides up to 90.0 watts at the switch port for powered devices that require up to 71.0 watts.

Powered Device Classes

Powered devices are grouped into the nine classes listed in Table 15. The classes are based on the amount of power the devices require. The x530-28GPXm and x530-52GPXm switches support classes 0 to 4. The x530-10GHXm and x530-18GHXm switches support classes 0 to 8.

Table 15. IEEE Powered Device Classes

Class	Maximum Power Output from a Switch Port	PD Power Range
0	15.4W	0.44W to 13.0W
1	4.0W	0.44W to 3.84W
2	7.0W	3.84W to 6.49W
3	15.4W	6.49W to 13.0W
4	30.0W	13.0W to 25.5W
5	45.0W	40.0W (4-pair)
6	60.0W	51.3W (4-pair)
7	75.0W	62.0W (4-pair)
8	90.0W	71.3W (4-pair)



Caution

When hot-swapping PoE PD Classes 5-8, the IC device can be damaged when the Ethernet cable is removed while supplying PoE power. To avoid damage, disable the port with the CLI or power off the unit before removing the cable. *⚡* **E133**

Power Budget

The x530-28GPXm and x530-52GPXm switches have two power supplies. Each power supply provides 370W for a total PoE of 740W. This is the total maximum amount of power that the switch can supply to powered devices on the PoE+ twisted pair ports. The number of powered devices that the switches can support at one time will depend on their power requirements. For instance, under normal operating conditions, the switches can support up to 24 Class 4 powered devices with the maximum 25.5W.

The x530-10GHXm and x530-18GHXm switches have two power supplies. Each power supply provides 500W for a total PoE of 1,000W. This is the total maximum amount of power that the switch can supply to powered devices on the PoE++ twisted pair ports. The number of powered devices that the switches can support at one time will depend on their power requirements. For instance, under normal operating conditions, the

x530-10GHXm switch can support Class 8 power devices on all eight of its twisted pair ports, while the x530-18GHXm switch can support up to eleven Class 8 devices.

Port Prioritization

The power requirements of the PoE devices determine the maximum number of devices the switch can support at one time. So long as the total power requirements of the power devices are less than the power budget of the switch, the switch can supply power to all the devices. But if the total power requirements exceed the power budget, the switch denies power to one or more ports using a mechanism referred to as port prioritization.

To determine whether the power requirements of the PoE devices you plan to connect to the switch exceed its power budget, refer to their documentation for their power requirements and add the requirements together. The switch should be able to power all the devices simultaneously as long as the total is below its power budget. If the total exceeds the available power budget, you should consider reducing the number of PoE devices so that all of the devices receive power. Otherwise, the switch powers a subset of the devices, based on port prioritization.

There are three priority levels:

- Critical
- High
- Low

Ports set to the Critical level, the highest priority level, are guaranteed power before any of the ports assigned to the other two priority levels. Ports assigned to the other priority levels receive power only if all the Critical ports are receiving power. Ports that are connected to your most critical powered devices must be assigned to this level. If there is not enough power to support all the ports set to the Critical priority level, power is provided to the ports based on port number, in ascending order.

The High level is the second highest level. Ports set to this level receive power only if all the ports set to the Critical level are already receiving power. If there is not enough power to support all of the ports set to the High priority level, power is provided to the ports based on port number, in ascending order.

The lowest priority level is Low. This is the default setting. Ports set to this level only receive power if all of the ports assigned to the other two levels are already receiving power. As with the other levels, if there is not enough power to support all of the ports set to the Low priority level, power is provided to the ports based on port number, in ascending order.

Power allocation is dynamic. Ports supplying power to powered devices can cease power transmission if the switch power budget is at maximum usage and new powered devices, connected to ports with higher priorities become active.

Wiring Implementation

The IEEE 802.3af standard defines two methods for delivering DC power over twisted pair cable by a switch to powered devices. These methods are known as Modes A and B, and identify the individual wires that carry the DC power within the cable from the switch to powered devices.

Twisted pair cabling typically consists of eight wires. With 100Base-TX devices, the wires connected to pins 1, 2, 3, and 6 on the RJ-45 connectors carry the network traffic while the wires connected to pins 4, 5, 7, and 8 are unused. At higher speeds, all eight wires are used to carry network data.

It takes four wires to deliver DC power to a powered device. With Mode A, power is delivered on pins 1, 2, 3, and 6. These are the same pins in 10Base-T and 100Base-TX devices that carry the network data. With Mode B, power is provided over the spare wires.

The ports deliver power for device classes:

- ❑ 0 to 4: Mode A – x530-28GPXm and x530-52GPXm
- ❑ 0 to 8: Modes A and B – x530-10GHXm and x530-18GHXm

Powered devices that comply with the IEEE 802.3af standard are required to support both Modes A and B. Classes 0 to 4 legacy devices that do not comply with the standard will work with the switch if they are powered on pins 1, 2, 3, and 6.



Caution

Disable PoE on ports before connecting or disconnecting twisted pair cables to prevent damaging the switch. Disconnecting Ethernet twisted pair network cables while the switch is providing power to powered devices (PDs) can damage the switch. *⚠* **E131**

SFP+ Transceiver Ports

1 Gbps SFP/ 10 Gbps SFP+ Transceivers

The following ports support 1 Gbps SFP/10 Gbps SFP+ transceivers:

- ❑ x530-10GHXm switch has two ports (ports 9 - 10)
- ❑ x530-18GHXm switch has two ports (ports 17 - 18)
- ❑ x530-28GPXm and x530-28GTXm switches have four ports (ports 25 to 28)
- ❑ x530-52GPXm and x530-52GTXm switches have four ports (ports 49 to 52)

See “SFP+ Transceiver Ports” on page 23 for a description and guidelines of the SFP+ transceivers.

Note

SFP or SFP+ transceivers must be purchased separately. For a list of supported transceivers, refer to the product data sheet on the Allied Telesis web site.

LEDs

Each transceiver port has one LED. The LEDs are located between the ports. Refer to Figure 14.

Top Transceiver Port LED **Bottom Transceiver Port LED**

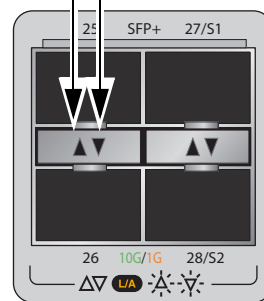

4566

Figure 14. Link and Activity LEDs for the 1 Gbps/10 Gbps SFP+ Ports

The LEDs display link status and activity. The possible LED states are described in Table 16.

Table 16. Link and Activity Status LEDs for the 1 Gbps and 10 Gbps Ports

State	Description
Solid Green	The transceiver has established a 10 Gbps link to a network device.
Flashing Green	The transceiver is transmitting or receiving data in 10 Gbps.
Solid Amber	The transceiver has established a 1 Gbps link to a network device.
Flashing Amber	The transceiver is transmitting or receiving data in 1 Gbps.
Off	Possible causes of this state are: <ul style="list-style-type: none"> - The port is empty. - The transceiver has not established a link to a network device. - A non-supported module is installed. - The LEDs are turned off. To turn on the LEDs, use the eco-friendly button.

eco-friendly Button

The eco-friendly button on the front panel of the switch is used to toggle the port LEDs on or off. You can turn off the LEDs to conserve electricity when you are not monitoring the device. You can also toggle the LEDs with the ECOFRIENDLY LED and NO ECOFRIENDLY LED commands in the Global Configuration mode of the command line interface of the AlliedWare Plus management software.

The switch is operating in a low power mode when the LEDs are turned off. Operating the switch in the low power mode does not interfere with the network operations of the device.

The management software on the switch has a command that blinks the LEDs so that you can quickly and easily identify a specific unit among the devices in an equipment rack. It is the FINDME command. The command works on the switch even if you turned off the LEDs with the eco-friendly button or NO ECOFRIENDLY LED command.

Note

Before checking or troubleshooting the network connections to the ports on the switch, you must always check to be sure that the LEDs are on by either pressing the eco-friendly button or issuing the ECOFRIENDLY LED and NO ECOFRIENDLY LED commands in the Global Configuration mode in the command line interface.

VCStack Feature

You can use the switches as standalone units or join up to eight units with the VCStack feature. The switches of a VCStack act as a single virtual unit. They synchronize their actions so that switching operations (such as spanning tree protocols, virtual LANs, and static port trunks) span across all of the units and ports. Two advantages of stacks are:

- ❑ You can manage multiple units simultaneously, which can simplify network management.
- ❑ You have more flexibility in how you configure some of the features. For instance, a static port trunk on a standalone switch can consist of ports from the same switch. In contrast, a static trunk on a stack can have ports from different switches in the same stack.

Note

This guide explains how to install the devices as standalone units. For instructions on VCStack, refer to the *x530 Series Installation Guide for Virtual Chassis Stacking*.

Switch ID LED

The switch ID LED, shown in Figure 15, displays the ID number of the switch. A standalone switch has the ID number 0. Switches in a VCStack have the numbers 1 to 8.

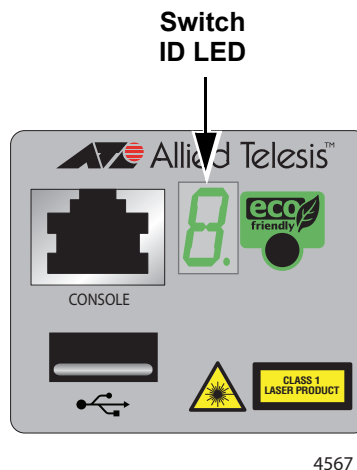

Figure 15. Switch ID LED

The states of the LED when the switch is not operating in the low power mode are shown in Figure 16.

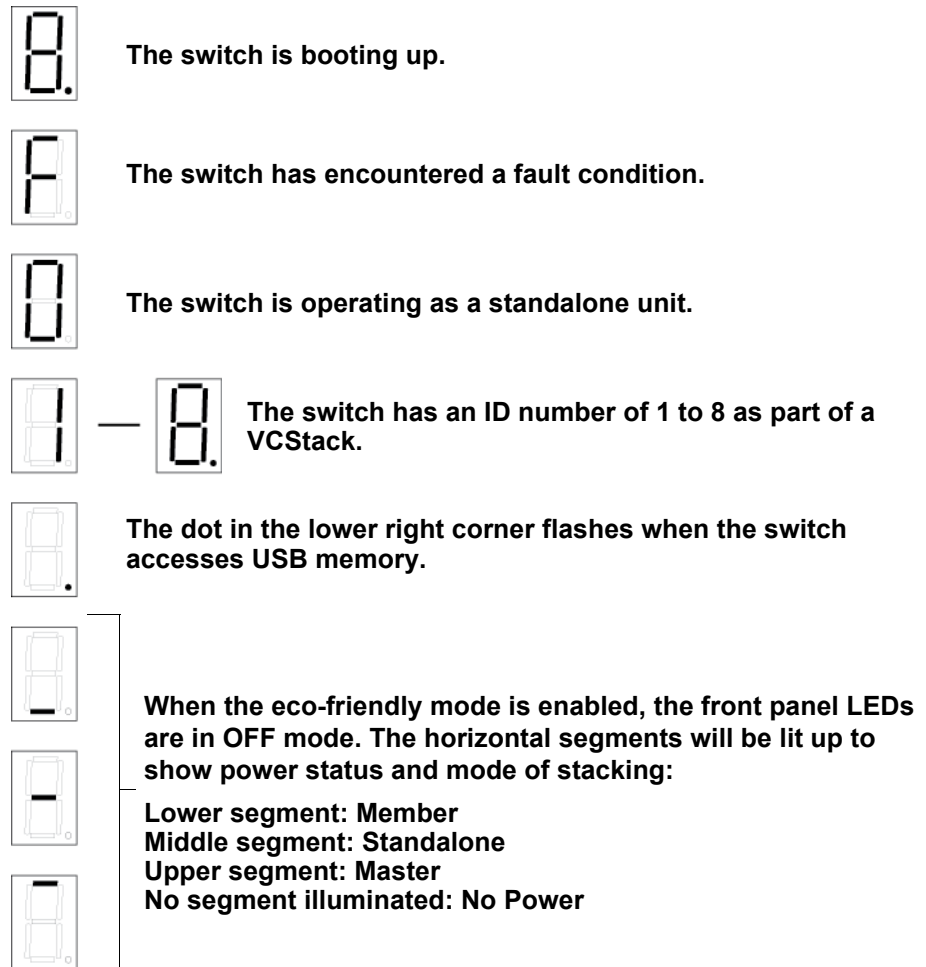

Figure 16. Switch ID LED Description

The switch displays the letter “F” for fault on the ID LED if it detects one of the following problems:

- A cooling fan has failed.
- The internal temperature of the switch has exceeded the normal operating range and the switch may shut down.

Note

You can use the Simple Network Management Protocol (SNMP) or the command line management interface to determine the type of fault or faults.

USB Port

The USB port on the management panel is used for the following functions:

- Store configuration files on flash drives.
- Restore configuration files to switches that have lost or corrupted settings.
- Configure replacement units by downloading configuration files from a flash drive.
- Update the management firmware.

The port is USB 2.0-compatible.

Console Port

The Console port is an RS232 serial management port. You use the port to access the AlliedWare Plus management software on the switch to configure the feature settings or monitor status or statistics. This type of management is commonly referred to as local management because you have to be at the physical location of the switch and use the management cable included with the unit. The switch does not have to have an IP address for local management.

To establish a local management session with the switch, use the provided management cable to connect a terminal or a computer with a terminal emulation program to the Console port, which has an RJ-45 style (8P8C) connector. The cable has RJ-45 style (8P8C) and DB-9 (D-sub 9-pin) connectors.

The Console port has the following settings:

- Default baud rate: 9,600 bps (range is 9,600 to 115,200 bps)
- Data bits: 8
- Parity: None
- Stop bits: 1
- Flow control: None

Note

These settings are for a DEC VT100 or ANSI terminal, or an equivalent terminal emulation program.

Power Supply

The x530 Series switches come with dual pre-installed AC power supplies. Refer to “Power Specifications” on page 124 for the input voltage ranges.



Warning

The power cord is used as a disconnection device. To de-energize equipment, disconnect the power cord. *⚡* E3

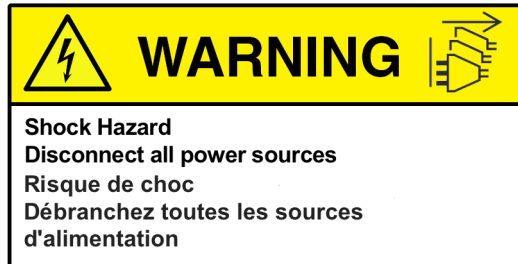

Note

Power supplies are not field-replaceable.

Software and Hardware Releases

Software and hardware releases for the AlliedWare Plus operating software and x530 Series switches are listed in Table 17.

Table 17. Software and Hardware Releases

Software Version	Hardware	VCStack
v5.4.8-2	x530-28GPXm switch x530-28GTXm switch	Allows stacks of up to four switches using the SFP/SFP+ transceiver ports for the stack trunk.
v5.4.9-2	Adds the following switches: x530-52GPXm switch x530-52GTXm switch	Allows stacks of up to eight switches using the SFP/SFP+ transceiver ports or the 1/2.5/5 Gbps ports for the stack trunk.
v5.5.1	Adds the following switches: x530-10GHXm switch x530-18GHXm switch	Allows stacks of up to eight switches using the SFP/SFP+ transceiver ports or the 1/2.5/5Gbps ports for the stack trunk.

Chapter 2

Beginning the Installation

The chapter contains the following sections:

- “Reviewing Safety Precautions” on page 56
- “Choosing a Site for the Switch” on page 61
- “Unpacking the Switch” on page 62

Reviewing Safety Precautions

Please review the following safety precautions before you begin to install the access point.

Important: Safety statements that have the  symbol are translated into multiple languages in the *Translated Safety Statements* document, which is available at www.alliedtelesis.com/library.

Remarque: Les consignes de sécurité portant le symbole  sont traduites dans plusieurs langues dans le document *Translated Safety Statements*, disponible à l'adresse www.alliedtelesis.com/library.



Warning

Class 1 Laser product.  L1



Warning

Laser Radiation.
Class 1M Laser product.



Warning

Do not stare into the laser beam.  L2



Warning

Do not look directly at the fiber optic ends or inspect the cable ends with an optical lens.  L6



Warning

To prevent electric shock, do not remove the cover. No user-serviceable parts inside. This unit contains hazardous voltages and should only be opened by a trained and qualified technician. To avoid the possibility of electric shock, disconnect electric power to the product before connecting or disconnecting the LAN cables.  E1



Warning

Do not work on equipment or cables during periods of lightning activity.  E2

**Warning**

Power cord is used as a disconnection device. To de-energize equipment, disconnect the power cord. ⚡ E3

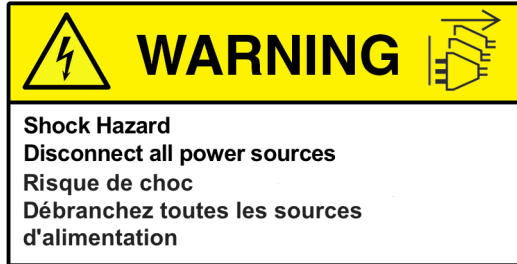
**Warning**

Class I Equipment. This equipment must be earthed. The power plug must be connected to a properly wired earth ground socket outlet. An improperly wired socket outlet could place hazardous voltages on accessible metal parts. ⚡ E4

Note

Pluggable Equipment. The socket outlet shall be installed near the equipment and shall be easily accessible. ⚡ E5

**Caution**

Air vents must not be blocked and must have free access to the room ambient air for cooling. ⚡ E6

**Warning**

Operating Temperatures. This product is designed for a maximum ambient temperature of 50° C. ⚡ E52

Note

All Countries: Install product in accordance with local and National Electrical Codes. ⚡ E8

**Warning**

Only trained and qualified personnel are allowed to install or replace this equipment. ⚡ E14



Caution

Circuit Overloading: Consideration should be given to the connection of the equipment to the supply circuit and the effect that overloading of circuits might have on overcurrent protection and supply wiring. Appropriate consideration of equipment nameplate ratings should be used when addressing this concern. *↪* E21



Caution

Risk of explosion if battery is replaced by an incorrect type. Replace only with the same or equivalent type recommended by the manufacturer. Dispose of used batteries according to the manufacturer's instructions.

Attention: Le remplacement de la batterie par une batterie de type incorrect peut provoquer un danger d'explosion. La remplacer uniquement par une batterie du même type ou de type équivalent recommandée par le constructeur. Les batteries doivent être éliminées conformément aux instructions du constructeur. *↪* E22



Warning

Mounting of the equipment in the rack should be such that a hazardous condition is not created due to uneven mechanical loading. *↪* E25



Warning

The chassis may be heavy and awkward to lift. Allied Telesis recommends that you get assistance when mounting the chassis in an equipment rack. *↪* E28

Note

Use dedicated power circuits or power conditioners to supply reliable electrical power to the device. *↪* E27



Warning

This unit might have more than one power cord. To reduce the risk of electric shock, disconnect all power cords before servicing the unit. *↪* E30

Note

If installed in a closed or multi-unit rack assembly, the operating ambient temperature of the rack environment may be greater than the room ambient temperature. Therefore, consideration should be given to installing the equipment in an environment compatible with the manufacturer's maximum rated ambient temperature (Tmra).

 E35



Caution

Installation of the equipment in a rack should be such that the amount of air flow required for safe operation of the equipment is not compromised.  E36



Warning

Reliable earthing of rack-mounted equipment must be maintained. Particular attention must be given to supply connections other than direct connections to the branch circuits (e.g., use of power strips).

 E37



Warning

To reduce the risk of electric shock, the PoE ports on this product must not connect to cabling that is routed outside the building where this device is located.  E40



Warning

This product may have multiple AC power cords installed. To de-energize this equipment, disconnect all power cords from the device.

 E41



Caution

The unit does not contain serviceable components. Please return damaged units for servicing.  E42



Warning

The temperature of an operational SFP or SFP+ transceiver may exceed 70° C (158° F). Exercise caution when removing or handling a transceiver with unprotected hands.  E43



Caution

An Energy Hazard exists inside this equipment. Do not insert hands or tools into open chassis ports or plugs. ⚡ E44

Choosing a Site for the Switch

Observe these requirements when planning the installation of the switch.

- ❑ Before installing the switch in an equipment rack, check that the rack is safely secured so that it will not tip over. Devices in a rack should be installed starting at the bottom, with the heavier devices near the bottom of the rack.
- ❑ Before installing the switch on a table, check that the table is level and stable.
- ❑ The power outlets should be located near the switch and be easily accessible.
- ❑ The site should allow for easy access to the ports on the front of the switch, so that you can easily connect and disconnect cables, and view the port LEDs.
- ❑ The site should allow for adequate air flow around the unit and through the cooling vents on the front and rear panels. (The ventilation direction is from front to back.)
- ❑ The site must not expose the switch to moisture or water.
- ❑ The site must be a dust-free environment.
- ❑ The site must have dedicated power circuits or power conditioners to supply reliable electrical power to the network devices.
- ❑ Do not install the switch in a wiring or utility box because it might overheat and fail from inadequate air flow.



Warning

Switches should not be stacked on a table or desktop. They could present a physical safety hazard if you need to move or replace switches. *↻* E91

Unpacking the Switch

The main items provided in the shipping box are:

- ❑ x530 Series switch
- ❑ Accessory kit (refer to Figure 18 on page 63)

Note

Retain the original packaging material in case you need to return the unit to Allied Telesis.

Figure 17 shows the items provided in the shipping box for the switch.

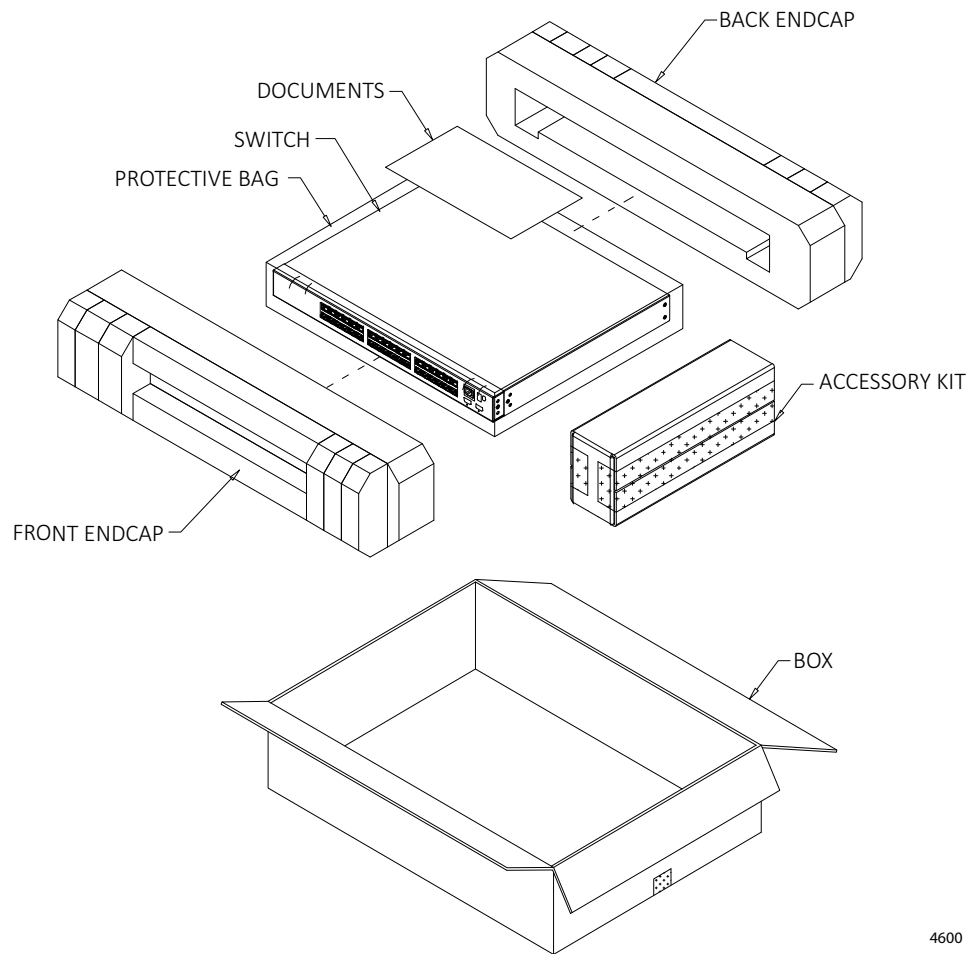

Figure 17. Switch Shipping Box

4600

Figure 18 lists the items that are included in the accessory kit. Contact your Allied Telesis sales representative for assistance if any item is missing or damaged.

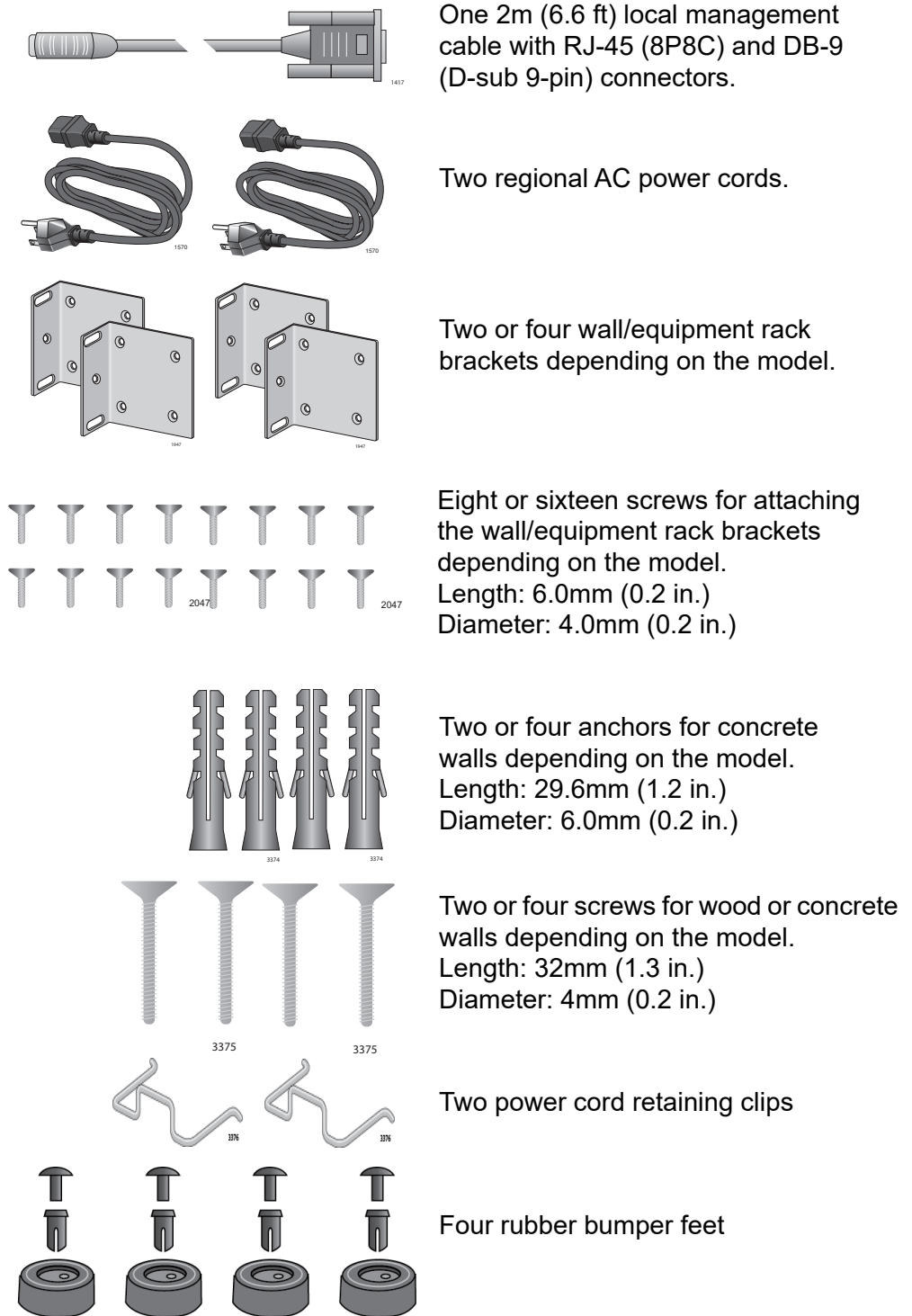

Figure 18. Accessory Kit Items

Table 18 lists the items that come in the accessory kit for each switch.

Table 18. Accessory Kit Items

Accessory Kit Item	x530-10GHXm (PoE++)	x530-18GHXm (PoE++)	x530-28GTXm	x530-28GPXm (PoE+)	x530-52GTXm	x530-52GPXm (PoE+)
Management cable	1	1	1	1	1	1
Power cords	2	2	2	2	2	2
Wall/equipment rack brackets	4	4	2	2	4	4
Wall/equipment rack bracket screws	16	16	8	8	16	16
Wall anchors	4	4	2	2	4	4
Wall screws	4	4	2	2	4	4
Power cord retaining clips	2	2	2	2	2	2
Bumper feet	4	4	4	4	4	4

Chapter 3

Installing the Switch on a Table

This chapter contains the instructions for installing the switch on a table or desktop.



Warning

Switches should not be stacked on a table or desktop. They could present a physical safety hazard if you need to move or replace switches. ⚡ E91



Warning

The switch is heavy. Always ask for assistance when moving or lifting the device so as to avoid injuring yourself or damaging the equipment.

The switch comes with four bumper feet in the accessory kit. The feet, which are reusable, are used when installing the switch on a table. If they are already assembled, disassemble them by removing the rivets and rivet housings from the bumper feet. Refer to Figure 19.

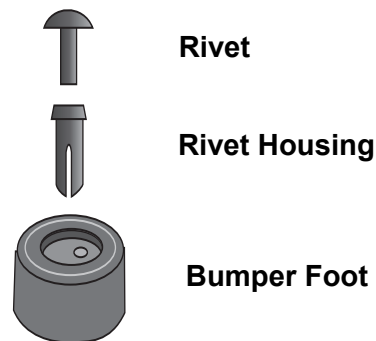

Figure 19. Parts of the Bumper Feet

The holes in the base of the switch for the bumper feet are shown in Figure 20 on page 66.

Note

Although you cannot stack the switches on top of each other, they can be placed next to each other.

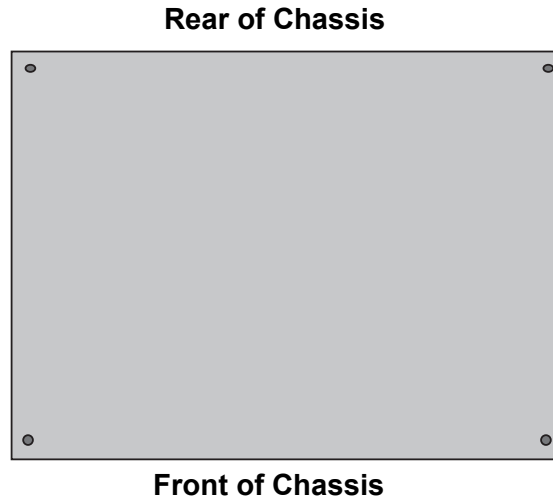

Figure 20. Holes for Bumper Feet

Note

The following procedure assumes that you have already reviewed the information and performed the procedures in Chapter 2, "Beginning the Installation" on page 55.

To install the switch on a table, perform the following procedure:

1. Place the switch upside down on a table.
2. Inset a rivet housing into a bumper foot. Refer to Figure 21.

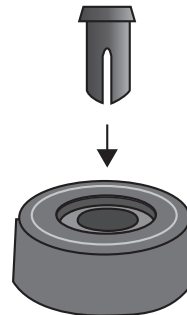

Figure 21. Inserting the Rivet Housing into the Bumper Foot

3. Place the bumper foot with rivet housing onto one of the holes in the base of the switch. Refer to Figure 22.

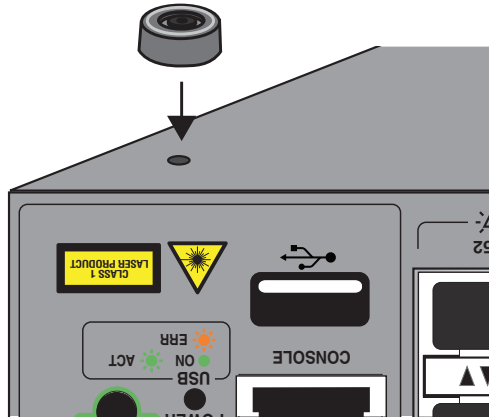

Figure 22. Placing the Bumper Foot on a Base Corner Hole

4. Insert the rivet to secure the bumper foot to the base. Refer to Figure 23.

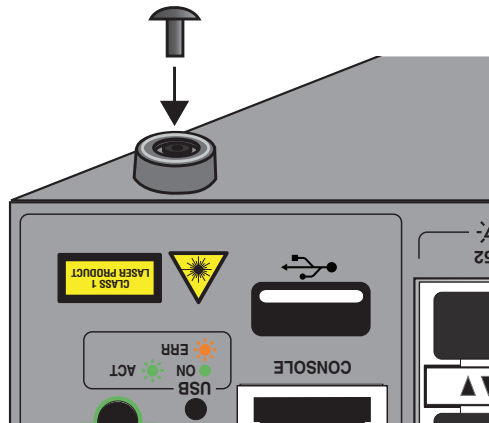

Figure 23. Inserting the Rivet into the Bumper Foot

5. Repeat steps 2 to 4 to install the remaining bumper feet.
6. Turn the switch over and place it on a flat, secure desk or table, leaving ample space around it for ventilation.
7. After placing the switch on the table or desktop, go to Chapter 6, "Powering On the Switch" on page 91.

Chapter 4

Installing the Switch in an Equipment Rack

This chapter provides instructions for installing the switch in an equipment rack. This chapter contains the following sections:

- “Beginning the Installation” on page 70
- “Removing the Bumper Feet” on page 72
- “Installing the Switch” on page 73

Beginning the Installation

This section contains the procedure for installing the switch in a standard 19-inch equipment rack using the brackets supplied with the unit.

Required Items

The following items are required to install the switch in an equipment rack:

- Two equipment rack brackets (included with the switch)
- Eight M4x6mm bracket screws (included with the switch)
- Cross-head screwdriver (not provided)
- Four standard equipment rack screws (not provided)

Switch Orientations in the Equipment Rack

The switch has two sets of four screw holes on the left and right sides, for attaching the brackets. Refer to Figure 24.

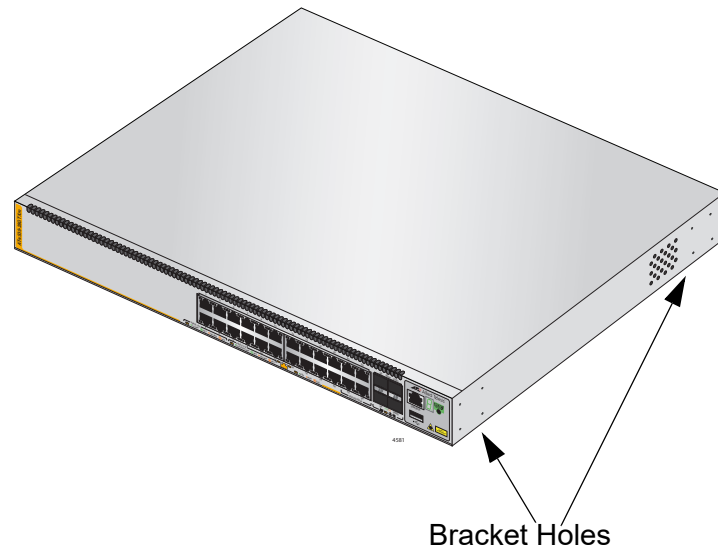

Figure 24. Bracket Holes on the Switch

You can use the different sets of holes on the switch to install the switch in the equipment rack in a variety of orientations. You can install it with the front panel flush with, extending in front of, or recessed behind the front of the equipment rack. Refer to Figure 25.



Figure 25. Switch Orientations in an Equipment Rack

Removing the Bumper Feet

The bumper feet included with the switch should not be used when installing the device in an equipment rack. If they are already installed, perform the following procedure to remove them:

1. Place the switch upside down on a level, secure surface.
2. Use a small flat-head screwdriver to pry the feet from the bottom of the switch. Refer to Figure 26.

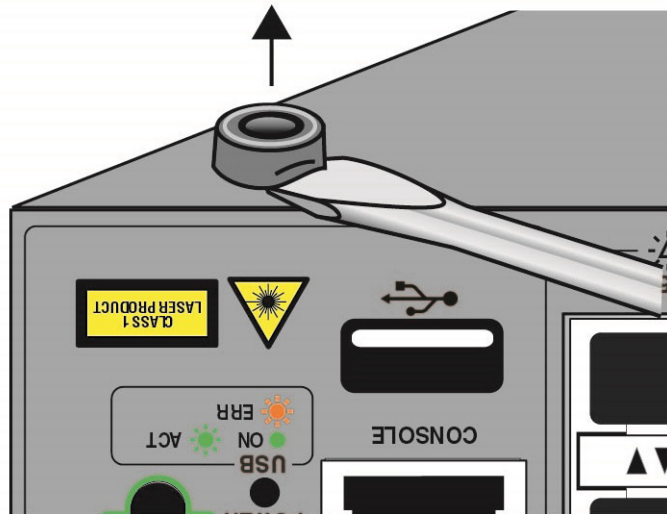

Figure 26. Removing the Bumper Feet

3. Turn the switch back over.
4. Go to “Installing the Switch” on page 73.

Installing the Switch

If you have not chosen an orientation for the switch in the equipment rack, review “Switch Orientations in the Equipment Rack” on page 70.

Please review the installation guidelines in “Choosing a Site for the Switch” on page 61 before installing the switch in an equipment rack.



Caution

The chassis can be heavy and awkward to lift. Allied Telesis recommends that you get assistance when mounting the chassis in an equipment rack. *GE* E28

To install the switch in a 19-inch equipment rack, perform the following procedure:

1. Place the switch on a level, secure surface.
2. Attach the two brackets to the sides of the switch in the selected position, using the eight M4x6mm screws supplied with the unit. The illustration in Figure 27 shows the installation of the brackets such that the front panel of the switch is even with the front of the equipment rack.

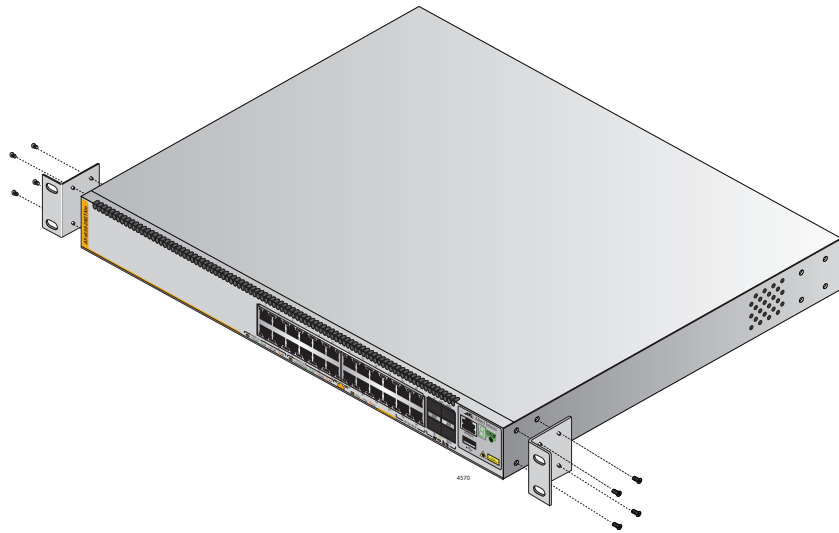

Figure 27. Example of Attaching the Brackets to the Switch

3. Have another person hold the switch at the desired location in the equipment rack while you secure it using four standard equipment rack screws (not provided). Refer to Figure 28.

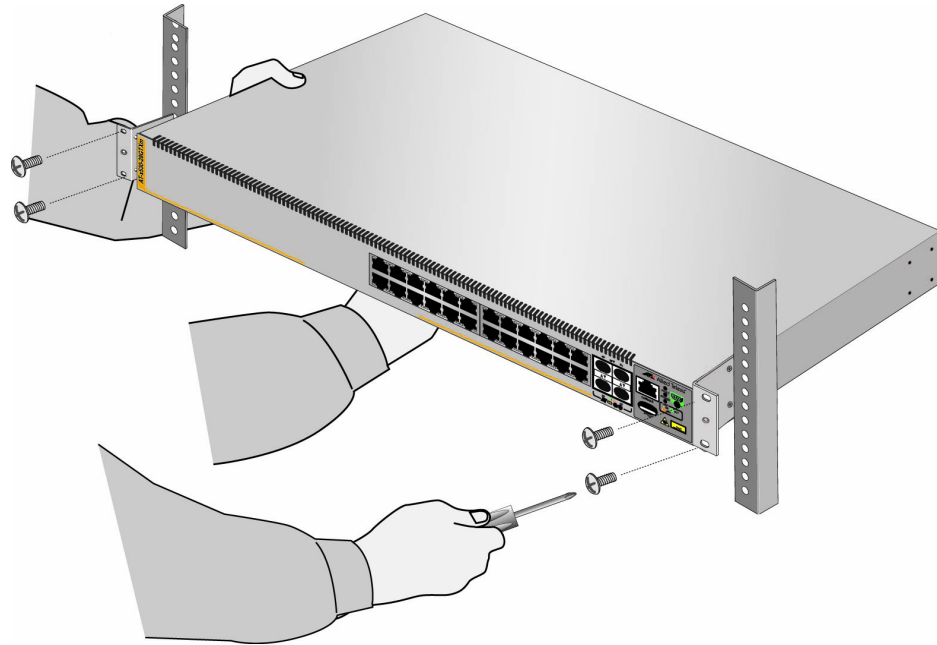

Figure 28. Installing the Switch in an Equipment Rack

4. Install the other switches of the stack.
5. After installing the switches, go to Chapter 7, “Configuring the Switch for Standalone Operations” on page 99 or Chapter 8, “Cabling the Networking Ports” on page 107.

Chapter 5

Installing the Switch on a Wall

The procedures in this chapter are listed here:

- “Switch Orientations on a Wall” on page 76
- “Installation Guidelines” on page 78
- “Plywood Base for a Wall with Wooden Studs” on page 80
- “Installing a Plywood Base” on page 81
- “Installing the Switch on a Plywood Base” on page 82
- “Installing the Switch on a Concrete Wall” on page 87

Switch Orientations on a Wall

Follow these guidelines for positioning the switch on a wall:

- ❑ Install the x530-28GTXm switch on a wall with the front panel facing up, left or right, as shown in Figure 29. Do not install the switch with the front panel facing down.
- ❑ Install the x530-10GHXm, x530-18GHXm, x530-28GPXm, x530-52GTXm, or x530-52GPXm switch on a wall with the front panel facing left or right, as shown in Figure 30. Do not install the switch with the front panel facing up or down.

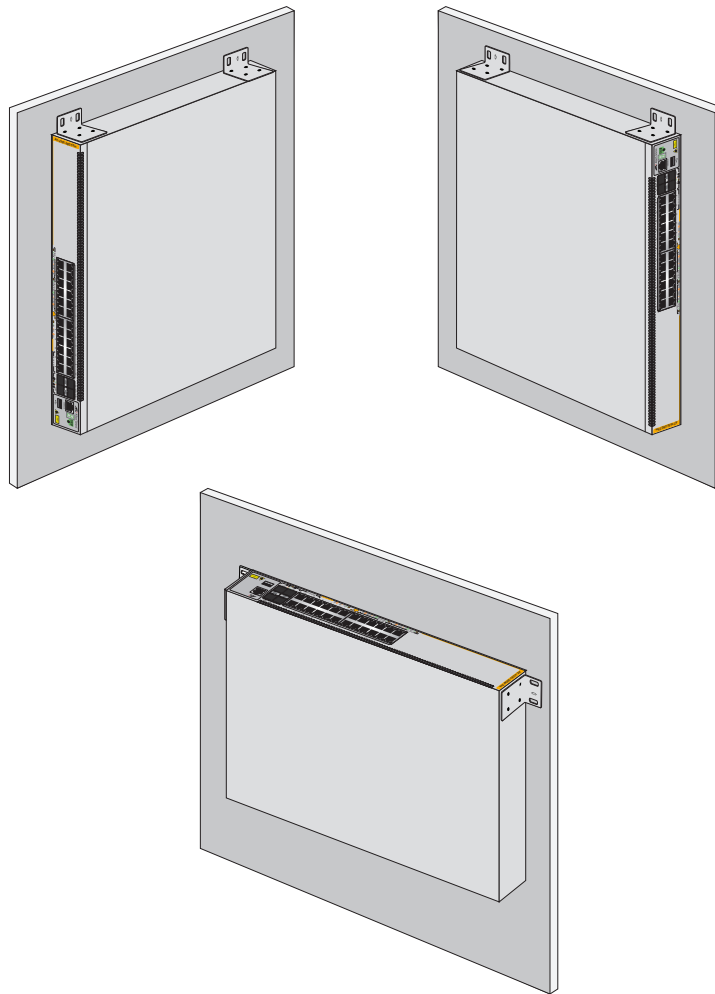

Figure 29. Positioning the x530-28GTXm Switch on the Wall

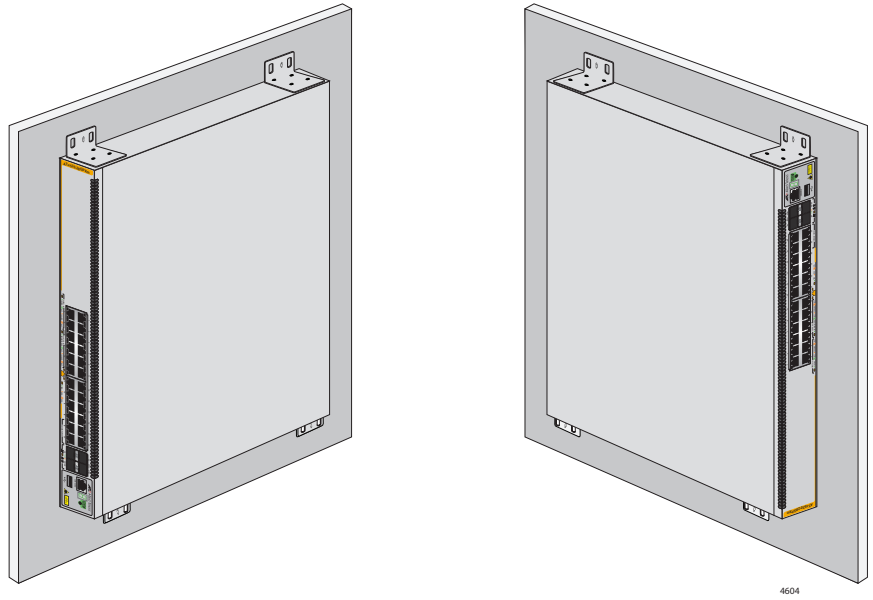

Figure 30. Positioning the x530-10GHXm, x530-18GHXm, x530-28GPXm, x530-52GTXm, or x530-52GPXm Switch on the Wall

Installation Guidelines

Here are the guidelines for installing the switch on a wall:

- ❑ Install the switch on a wall that has wooden studs or on a concrete wall.
- ❑ If you are installing the switch on a wall with wooden studs, use a plywood base to support the switch. For more information, refer to “Plywood Base for a Wall with Wooden Studs” on page 80. A plywood base is not required for a concrete wall.
- ❑ Do not install the switch on a wall that has metal studs. Metal studs may not be strong enough to safely support the device.
- ❑ Do not install the switch on sheetrock or similar material. Sheetrock is not strong enough to safely support the device.



Warning

The device is heavy. Always ask for assistance before moving or lifting it to avoid injuring yourself or damaging the equipment.



Warning

The device should be installed on a wall by a qualified building contractor. Serious injury to yourself or others or damage to the equipment can result if it is not properly fastened to the wall. ⚡
E105

Tools and Material

The following tools and material are required for installing the switch on a wall.

Included with switch:

- ❑ Wall/equipment rack brackets:
 - Two for the x530-28GTXm
 - Four for the x530-10GHXm, x530-18GHXm, x530-28GPXm, x530-52GTXm or x530-52GPXm
- ❑ Screws for attaching the wall/equipment rack brackets to the switch:
 - Eight for the x530-28GTXm
 - Sixteen for the x530-10GHXm, x530-18GHXm, x530-28GPXm, x530-52GTXm or x530-52GPXm

Length: 6 mm (0.2 in.) Diameter: 4 mm (0.2 in.)

- ❑ Anchors for concrete walls
 - Two for the x530-28GTXm
 - Four for the x530-10GHXm, x530-18GHXm, x530-28GPXm, x530-52GTXm or x530-52GPXm

Length: 29.6 mm (1.2 in.) Diameter: 6 mm (0.2 in.)

- ❑ Screws for wood or concrete walls:
 - Two for the x530-28GTXm
 - Four for the x530-10GHXm, x530-18GHXm, x530-28GPXm, x530-52GTXm or x530-52GPXm

Length: 32 mm (1.3 in.) Diameter: 4 mm (0.2 in.)

- ❑ Two power cord retaining clips
- ❑ Four rubber bumper feet

Not included with switch:

- ❑ Cross-head screwdriver.
- ❑ Stud finder for a wooden wall, capable of identifying the middle of wall studs and hot electrical wiring.
- ❑ Drill and 1/4-inch carbide drill bit (for a concrete wall). Refer to “Installing the Switch on a Concrete Wall” on page 87.
- ❑ Plywood base (if you are installing the switch on a wall with wooden studs). Refer to “Plywood Base for a Wall with Wooden Studs” on page 80 for illustrations.
- ❑ Four screws for attaching the plywood base to the wall.



Caution

The supplied screws and anchors might not be appropriate for all walls. A qualified building contractor can determine the hardware requirements for your wall prior to installing the switch. *E88*

Plywood Base for a Wall with Wooden Studs

If you are installing the switch on a wall that has wooden studs, use a plywood base for the device. (A plywood base is not required for a concrete wall.) Refer to Figure 31.

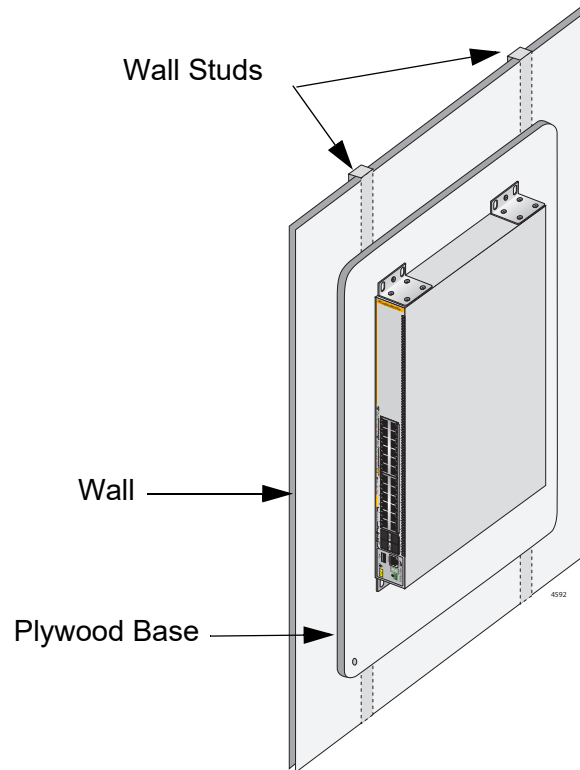

Figure 31. Switch on the Wall with a Plywood Base

Mount the plywood base to two studs in the wall. The recommended minimum dimensions of the plywood base for the switch are:

- ❑ Width: 55.9 centimeters (22 inches)
- ❑ Height: 61.0 centimeters (24 inches)
- ❑ Thickness: 2.5 centimeters (1 inch)

The dimensions assume the wall studs are 41 centimeters (16 inches) apart. You might need to adjust the width of the base if the distance between the studs in your wall is different than the industry standard.

Installing a Plywood Base

A plywood base is recommended when installing the switch on a wall that has wooden studs. Refer to “Plywood Base for a Wall with Wooden Studs” on page 80. Consult a qualified building contractor for installation instructions for the plywood base. The installation guidelines are listed here:

- ❑ Use a stud finder to identify the middle of studs and hot electrical wiring in the wall.
- ❑ Attach the base to two wall studs with a minimum of four screws.
- ❑ The selected wall location for the base must provide sufficient space from other devices or walls so that you can access the front and back panels, and for adequate air flow for ventilation.

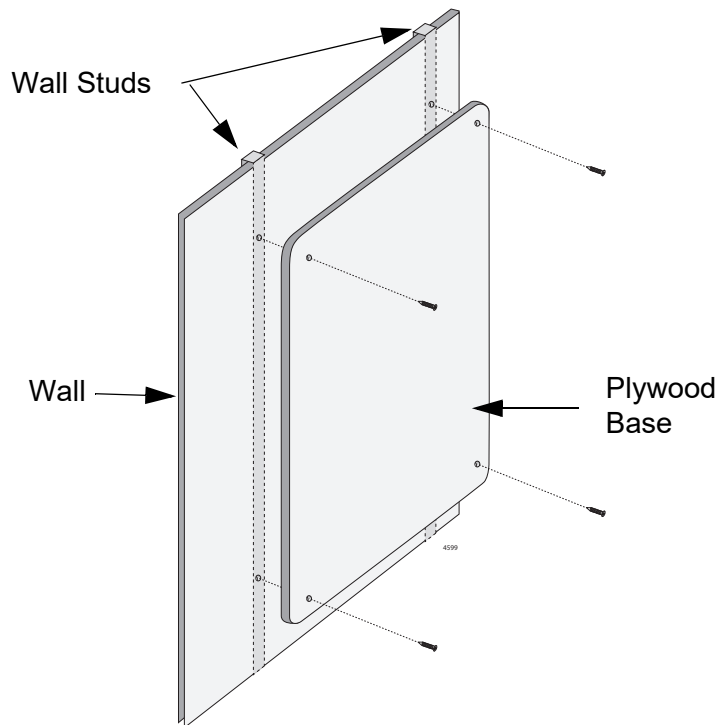

Figure 32. Installing the Plywood Base to the Wall

Installing the Switch on a Plywood Base

After the plywood base for the switch has been installed on the wall, install the switch. See “Reviewing Safety Precautions” on page 56 and “Choosing a Site for the Switch” on page 61 before performing this procedure. Allied Telesis recommends a minimum of two people for this procedure.



Warning

The device is heavy. Always ask for assistance before moving or lifting it to avoid injuring yourself or damaging the equipment.



Warning

The device should be installed on the wall by a qualified building contractor. Serious injury to yourself or others or damage to the equipment can result if it is not properly fastened to the wall. *ES*
E105

To install the switch on the plywood base, perform the following procedure:

1. Place the switch on a table.
2. For the x530-28GTXm switch, install two wall/equipment rack brackets to the sides of the unit with the eight M4x6mm screws included with the switch. Refer to Figure 33 on page 83. For the x530-10GHXm, x530-18GHXm, x530-28GPXm, x530-52GPXm or x530-52GTXm switch, install four wall/equipment rack brackets to the sides of the unit with the 16 M4x6mm screws included with the switch. Refer to Figure 34 on page 84.

Note

The x530-10GHXm, x530-18GHXm, x530-28GPXm, x530-52GPXm or x530-52GTXm switch requires four brackets to be installed due to its weight. Whereas, the x530-28GPXm switch only requires two brackets because it is lighter.

Brackets positions
to install the switch with
the front panel on the left.

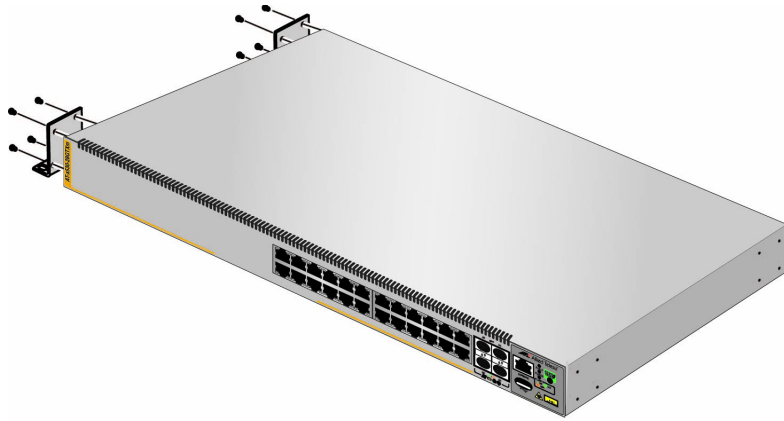

Brackets positions
to install the switch with
the front panel on the right.

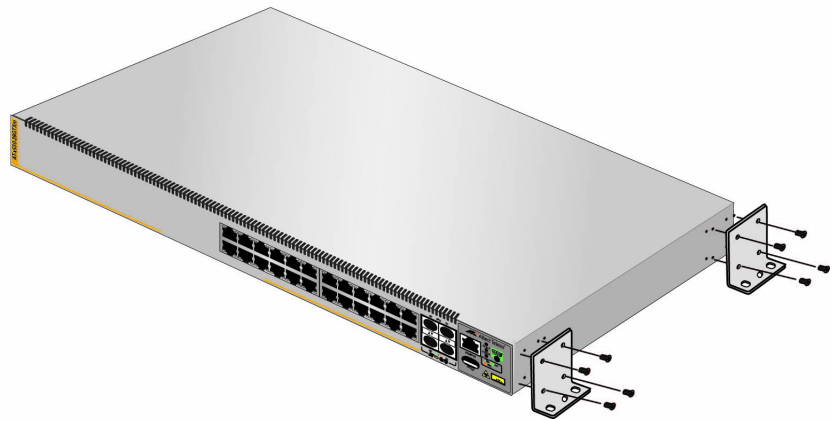

Figure 33. Installing Two Brackets on the x530-28GTXm Switch

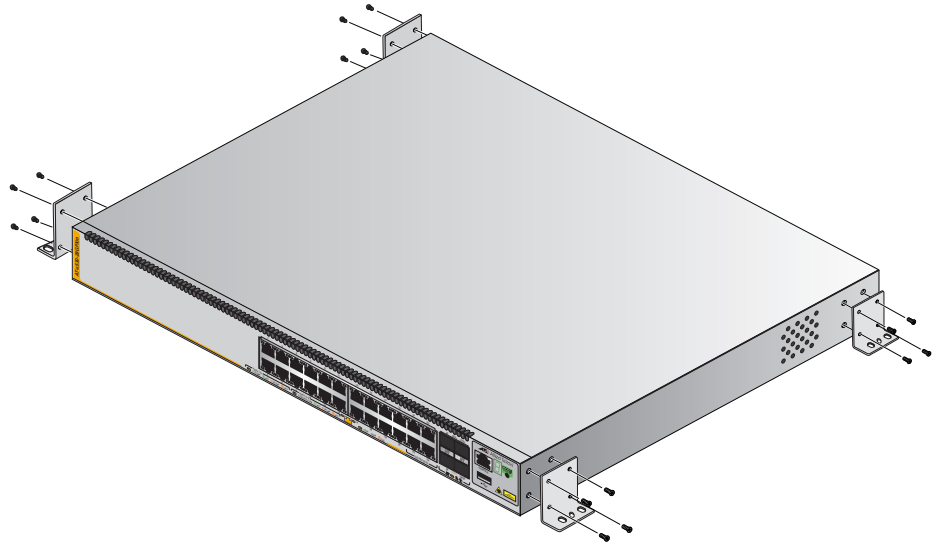

Figure 34. Installing Four Brackets on the x530-10GHXm, x530-18GHXm, x530-28GPXm, x530-28GPXm or x530-28GTXm Switch

3. After attaching the brackets, have another person hold the switch on the plywood base on the wall while you secure it with the M4x32.3mm screws included with the switch. Refer to Figure 35 on page 85 for the x530-28GTXm switch. Refer to Figure 36 on page 86 for the x530-10GHXm, x530-18GHXm, x530-28GPXm, x530-52GTXm or x530-52GPXm switch.

Follow these guidelines as you position the switch on the wall:

- Position it so that the front panel is facing up, left or right. Refer to Figure 29 on page 76. Do not install it with the front panel facing down.
- Provide sufficient space from other devices or walls so that you can access the front and back panels, and for adequate air flow for ventilation.

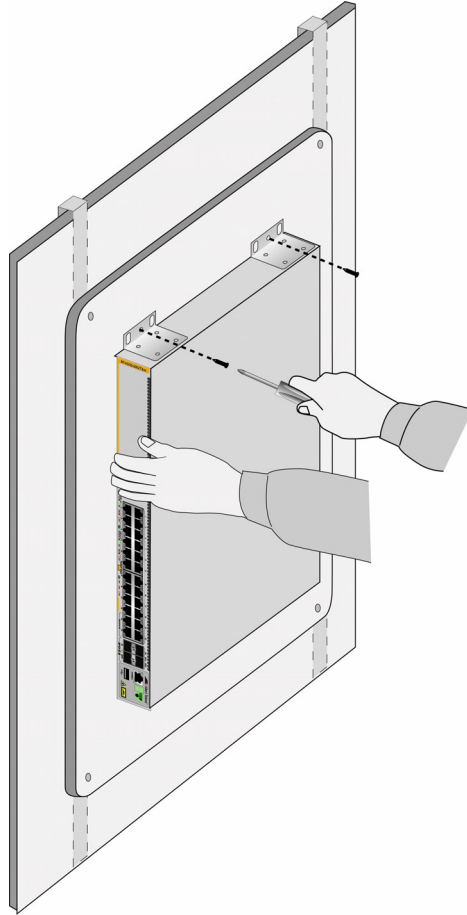

Figure 35. Securing the x530-28GTXm Switch to the Plywood Base

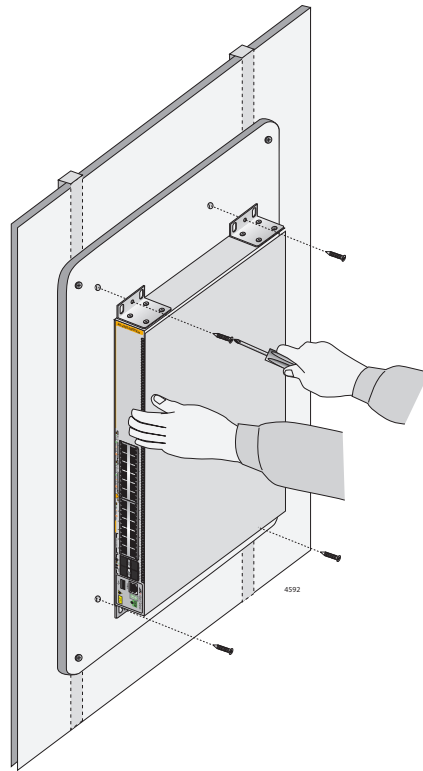

Figure 36. Securing the x530-10GHXm, x530-18GHXm, x530-28GPXm, x530-52GTXm or x530-52GPXm Switch to the Plywood Base

4. Go to Chapter 6, “Powering On the Switch” on page 91.

Installing the Switch on a Concrete Wall

This section contains the instructions for installing the switch on a concrete wall. Please review the information in the following sections before performing the procedure:

- ❑ “Switch Orientations on a Wall” on page 76
- ❑ “Installation Guidelines” on page 78



Warning

The device is heavy. Always ask for assistance before moving or lifting it to avoid injuring yourself or damaging the equipment.



Warning

The device should be installed on the wall by a qualified building contractor. Serious injury to yourself or others or damage to the equipment can result if it is not properly fastened to the wall. *ES*
E105

To install the switch on a concrete wall, perform the following procedure:

1. Place the switch on a table.
2. For the x530-28GTXm switch, install two wall/equipment rack brackets to the sides of the unit with the eight M4x6mm screws included with the switch. Refer to Figure 33 on page 83. For the x530-10GHXm, x530-18GHXm, x530-28GPXm, x530-52GTXm or x530-52GPXm switch, install four wall/equipment rack brackets to the sides of the unit with the 16 M4x6mm screws included with the switch. Refer to Figure 34 on page 84. Refer to Figure 34 on page 84.
3. After attaching the brackets, have another person hold the switch on the concrete wall at the selected location for the device while you use a pencil or pen to mark the wall with the locations of the four screw holes in the four brackets (one screw per bracket). Refer to Figure 37 on page 88.

Please follow these guidelines as you position the switch on the wall:

- ❑ Position it so that the front panel is facing up, left or right. Refer to Figure 29 on page 76. Do not install the switch with the front panel facing down.
- ❑ Provide sufficient space from other devices or walls so that you can access the front and back panels, and for adequate air flow and ventilation.

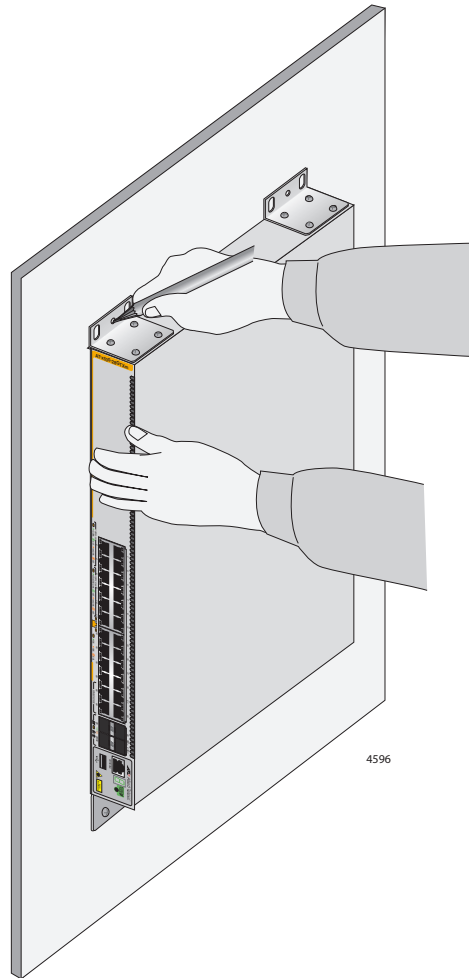

Figure 37. Marking the Locations of the Bracket Holes on a Concrete Wall

4. Place the switch on a table.
5. Use a drill and a 1/4-inch carbide drill bit to pre-drill the holes you marked in step 3. Please review the following guidelines:
 - Prior to drilling, set the drill to hammer and rotation mode. The modes break up the concrete and clean out the hole.
 - Clean out the holes with a brush or compressed air.
6. Insert the anchors into the holes.

7. Have another person hold the switch at the selected wall location while you secure it to the wall with the M4x32mm screws provided. Refer to Figure 38.

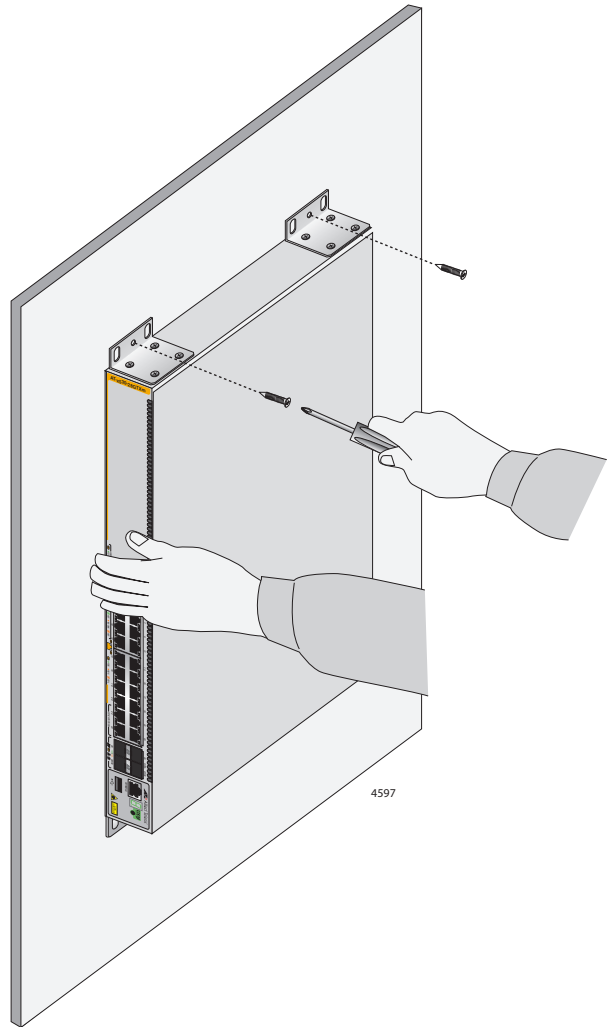

Figure 38. Installing the Switch on a Concrete Wall

8. Go to Chapter 6, “Powering On the Switch” on page 91.

Chapter 6

Powering On the Switch

This chapter contains the following procedures:

- “Powering On the Switch” on page 92
- “Monitoring the Initialization Processes” on page 95

Powering On the Switch

Before powering on the switch, review the information in “Power Specifications” on page 124 for the power specifications.



Warning

The power cord is used as a disconnection device. To de-energize equipment, disconnect the power cord. ⚡ E3

Note

Pluggable Equipment. The socket outlet shall be installed near the equipment and shall be easily accessible. ⚡ E5

To power on the switch, perform the following procedure:

1. Install the power cord retaining clip on the AC power connector on the rear panel of the switch. Refer to Figure 39.

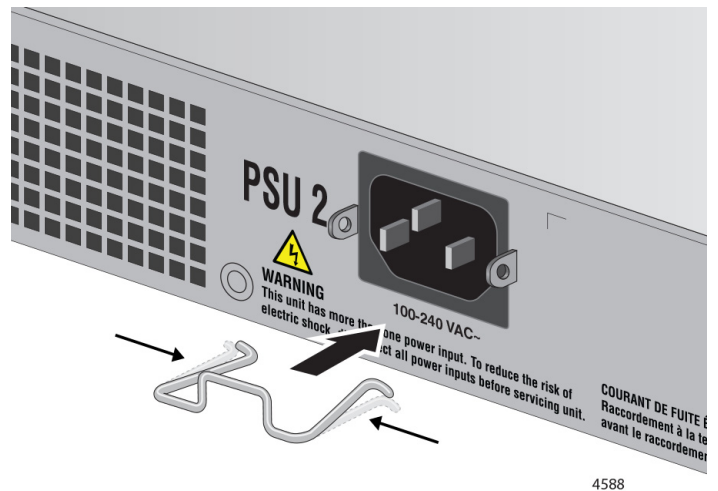

Figure 39. Installing the Power Cord Retaining Clip

2. Connect the AC power cord to the AC power connector on the rear panel. Refer to Figure 40 on page 93.

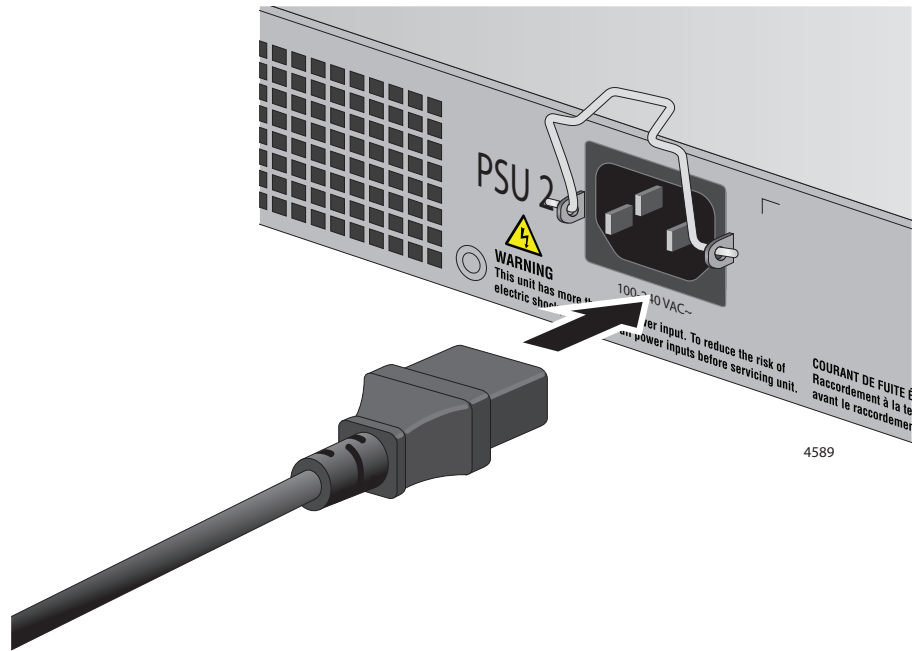

Figure 40. Connecting the AC Power Cords

3. Lower the power cord retaining clips to secure the cords to the switch. Refer to Figure 41.

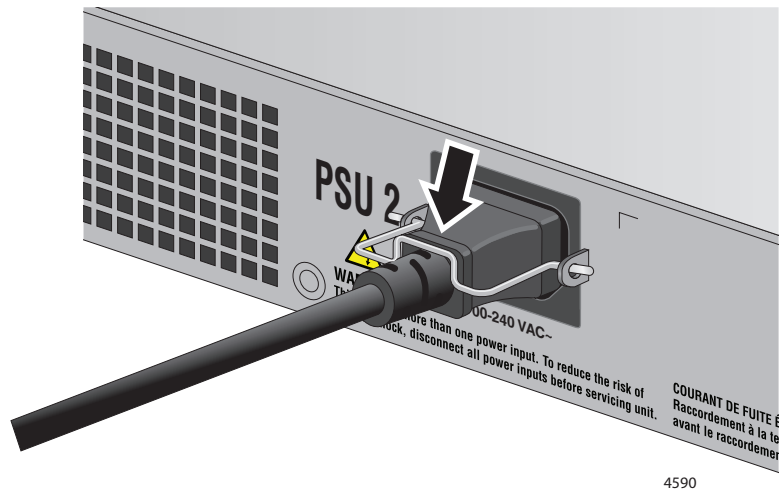

Figure 41. Lowering the Power Cord Retaining Clips

4. Repeat steps 1 to 3 to connect a power cord to the second power supply.

5. Connect the power cords to an appropriate AC power source. Refer to Figure 42 on page 94.

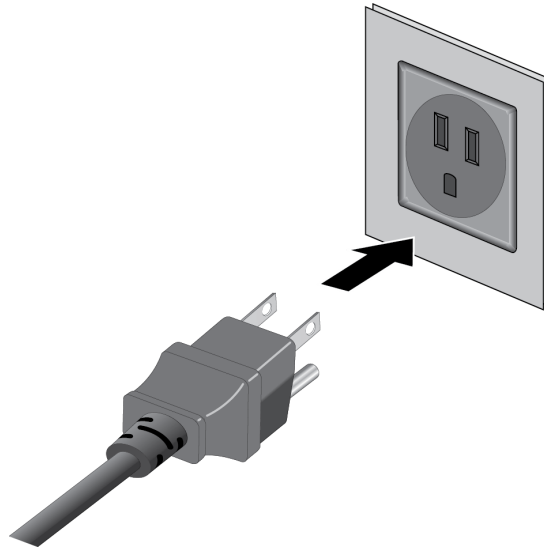

Figure 42. Connecting the Power Cords to an AC Power Source

Note

The illustration shows a North American power cord. Your power cords may be different.

6. Do one of the following:
 - To monitor the switch as it initializes the management software, go to “Monitoring the Initialization Processes” on page 95.
 - Wait two minutes for the switch to initialize its management software and then go to Chapter 7, “Configuring the Switch for Standalone Operations” on page 99.

Monitoring the Initialization Processes

It takes about two minutes for the switch to initialize its management software programs and features, and load the default configuration. You can monitor the bootup sequence by connecting a terminal or computer with a terminal emulator program to the Console port. (The Console port settings are provided in “Starting a Local Management Session” on page 101.) The switch displays the messages in Figure 43 through Figure 45 on the Console port as it initializes the management software.

```

Bootloader 6.2.12 loaded
Press <Ctrl+B> for the Boot Menu
Reading flash:x530-5.4.9-2.2-rc1.rel...

Verifying release... OK
Booting...
Starting base/first...           [ OK ]
Mounting virtual filesystems...  [ OK ]

      _____
     / \          / / \ \
    /   \        / /   \ \
   /     \      / /     \ \
  /       \    / /       \ \
 /         \  / /         \ \
/           \ / /           \ \
/_____ \ / /_____ \ /

Allied Telesis Inc.
AlliedWare Plus (TM) v5.4.9
Current release filename: x530-5.4.9-2.2-rc1.rel...
Built: Mon Sep 23 01:57:50 UTC 2019
Mounting static filesystems...   [ OK ]
Attaching to /dev/mtd0...        [ OK ]
Mounting file system...          [ OK ]
Checking for last gasp debug output... [ OK ]
Checking NVS filesystem...       [ OK ]
Mounting NVS filesystem...       [ OK ]
Initializing random number generator... [ OK ]
Starting base/hwrandom...        [ OK ]
Starting base/jitterentropy-rngd... [ OK ]
Starting base/dbus...            [ OK ]
Starting base/linux...          [ OK ]

```

Figure 43. Switch Initialization Messages

```

Starting base/loopback... [ OK ]
Starting base/poe_done... [ OK ]
Starting base/portmapper... [ OK ]
Received event syslog.done
Starting base/modules... [ OK ]
Received event modules.done
Starting base/reboot-stability... [ OK ]
Checking system reboot stability... [ OK ]
Starting base/apteryx... [ OK ]
Starting base/crond... [ OK ]
Starting base/appmond... [ OK ]
Starting base/clockcheck... [ OK ]
Starting network/execd... [ OK ]
Starting base/inet... [ OK ]
Received event apteryx.done
Starting hardware/early_host_info... [ OK ]
Starting base/alfred... [ OK ]
Starting base/kernond... [ OK ]
Starting base/apteryx-sync... [ OK ]
Starting base/logconf... [ OK ]
Received event apteryx-sync.done
Starting hardware/platformd... [ OK ]
Starting hardware/plugman... [ OK ]
Starting hardware/timeout... [ OK ]
Starting hardware/hardware-done... [ OK ]
Received event board.inserted
Received event hardware.done
Starting base/external-media... [ OK ]
Starting network/startup... [ OK ]
Starting network/hostcfg... [ OK ]
Received event hostcfg.done
Starting network/cmplplatformd... [ OK ]
Starting base/eventwatch... [ OK ]
Starting network/startup... [ OK ]
Starting hardware platform_eventd... [ OK ]
Starting network/licd... [ OK ]
Starting network/stackd... [ OK ]
Starting network/election.timeout... [ OK ]
Starting network/corosync... [ OK ]
Received event network.enabled

```

Figure 44. Switch Initialization Messages (Continued)

```
Initializing HA processes:  
atmf_agentd, execd, exfx, hostd, atmfd, auth, epsr  
hsl, imi, imiproxyd, lldpd, loopprot, mstp, nsm  
pim6d, ripngd, rmon, sflowd, vrrpd, bgpd, irdpd  
lacp, ospf6d, ospfd, pdmd, pimd, ripd, udldd
```

```
Received event network.initialized
```

```
Assigning Active workload to HA processes:  
hsl, irdpd, lacpd, loopprot, mstpd, nsm, ospfd  
ripd, rmond, sflowd, vrrpd, authd, epsrd, imi  
imiproxyd, lldpd
```

```
Received event network.activated
```

```
Loading default configuration
```

```
..
```

```
done!
```

```
Received event network.configured
```

Figure 45. Switch Initialization Messages (Continued)

After the switch has initialized its management software, go to Chapter 7, “Configuring the Switch for Standalone Operations” on page 99.

Chapter 7

Configuring the Switch for Standalone Operations

This chapter contains the following procedures:

- ❑ “Determining the Standalone or Stacking Status of the Switch” on page 100
- ❑ “Starting a Local Management Session” on page 101
- ❑ “Disabling the VCStack Feature” on page 103
- ❑ “Saving Your Changes and Rebooting the Switch” on page 105
- ❑ “Specifying Ports in the Command Line Interface for Standalone Switches” on page 106

Determining the Standalone or Stacking Status of the Switch

After powering on the switch and waiting two minutes for it to initialize the management software, examine the switch ID LED on the front panel. If the LED is displaying the number “1” or higher, the VCStack feature is enabled on the unit. You need to disable it to use the switch in standalone mode. For instructions, start with “Starting a Local Management Session” on page 101. The VCStack feature is enabled by default.

If the LED is displaying “0”, the VCStack feature is already disabled and the switch is operating as a standalone unit. Go to Chapter 8, “Cabling the Networking Ports” on page 107.



Caution

You must reset the switch to disable the VCStack feature. Some network traffic can be lost if the device is already connected to a live network.  E89

Note

The initial management session of the switch must be from the Console port.

Starting a Local Management Session

This procedure requires a VT100 terminal or a VT100 terminal emulator program and the management cable that comes with the switch. To start a local management session on the switch, perform the following procedure:

1. Connect the RJ-45 connector of the management cable to the console port on the front panel of the switch, as shown in Figure 46.

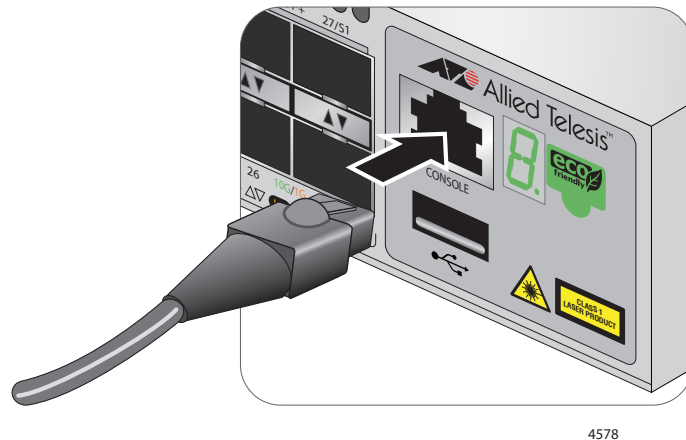

Figure 46. Connecting the Management Cable to the Console Port

2. Connect the other end of the cable to an RS-232 port on a terminal or computer with a terminal emulator program.
3. Configure the terminal or terminal emulator program as follows:
 - Default baud rate: 9,600 bps (range is 9,600 to 115,200 bps)
 - Data bits: 8
 - Parity: None
 - Stop bits: 1
 - Flow control: None

Note

The port settings are for a DEC VT100 or ANSI terminal, or an equivalent terminal emulator program.

4. Press Enter.

You are prompted for a user name and password.

5. When prompted, type a user name and password to log on the switch. If this is the initial management session, enter “manager” as the user name and “friend” as the password. The user name and password are case sensitive.

The local management session starts when the User Exec mode prompts.

```
awp1us>
```

Note

The User Exec mode is the first level in the command mode interface. For complete information on the modes and commands, refer to the *Command Reference: x530 Series Switches Running AlliedWare Plus Version 5.5.0* at www.alliedtelesis.com/library.

6. If you need to disable the VCStack feature, perform the procedure in “Disabling the VCStack Feature” on page 103.

Disabling the VCStack Feature

The following procedures explain how to disable the VCStack feature to use the switch as a standalone unit.



Caution

Disabling the VCStack feature requires resetting the switch. Some network traffic can be lost if the switch is connected to a live network. *E89*

To disable the VCStack feature, perform the following procedure:

1. Start a local management session on the switch. For instructions, refer to “Starting a Local Management Session” on page 101.
2. To display the status of the VCStack feature on the switch, at the User Exec mode prompt, type the command SHOW STACK.

```
awplus> show stack
Virtual Chassis Stacking summary information
ID      Pending ID  MAC address      Priority  Status  Role
1       -            eccd:6dd1:64a2  128     Ready   Active Master
Operational Status      Standalone Unit
Stack MAC address       eccd:6dd1:64a2
awplus>
```

Figure 47. SHOW STACK Command

3. If the Operational Status of the switch is “Stacking Hardware Disabled,” the VCStack feature is already disabled on the unit. If this is the case, go to Chapter 8, “Cabling the Networking Ports” on page 107.

However, if the Operational Status is “Standalone Unit” as shown in Figure 47, the VCStack feature is active on the unit. (The “Standalone Unit” status means the switch is functioning as a stack of one switch.) You must disable the feature to use the switch as a standalone unit. Continue with the next step.

4. To move to the Global Configuration mode, type the commands ENABLE and CONFIGURE TERMINAL.

```
awplus> enable
awplus# configure terminal
Enter configuration commands, one per line. End with CNTL/Z
awplus(config)#
```

Figure 48. Moving to the Global Configuration Mode

5. To disable the VCStack feature, type the command NO STACK <id> ENABLE in the following format:

```
no stack <id> enable
```

The *id* parameter is the ID number of the switch, displayed on the ID LED. Replace the *id* parameter with the number on the ID LED. For example, if the ID number of the switch is 1, the default value, enter the command as follows:

```
awplus(config)# no stack 1 enable
```

```
Warning; This will disable the stacking hardware on member-1.
Are you sure you want to continue? (y/n):
```

6. To disable VCStack on the switch type Y, or type N to cancel the procedure.

```
awplus(config)#18:04:12 awplus vcs[2119]: Deactivating
Stacking Ports on stack member 1.
```

Figure 49. Disabling VCStack

7. Press the Enter key to re-display the Global Configuration mode prompt.
8. Go to “Saving Your Changes and Rebooting the Switch” on page 105.

Saving Your Changes and Rebooting the Switch

After disabling the VCStack feature, save your configuration changes and reboot the switch. Changes to the status of the VCStack feature do not take affect until after you reboot the unit.

To save your configuration changes and reboot the switch, perform the following procedure:

1. To return to the Privileged Exec mode, from the Global Configuration mode, type the command EXIT.

```
awplus(config)# exit
awplus#
```

Figure 50. Returning to the Privileged Exec Mode

2. To save your change in the configuration file, type the command WRITE.

```
awplus# write
Building configuration ...
[OK]
awplus#
```

Figure 51. Saving the Changes with the WRITE Command

If this is the initial management session, the switch automatically creates the Default.cfg configuration file and stores the change in the file.

3. To reboot the switch, type the command REBOOT.
4. To confirm, type “Y” for yes.
5. Wait two minutes for the switch to initialize the management software and then examine the Switch ID LED again. The switch is ready for normal network operation as a standalone unit if its ID number is “0.” If the number is not “0,” repeat the procedures in this chapter, being sure to save your configuration changes with the WRITE command.
6. Go to Chapter 8, “Cabling the Networking Ports” on page 107.

Specifying Ports in the Command Line Interface for Standalone Switches

The individual ports on the switches are specified in the command line interface with the PORT parameter. The format of the parameter is shown in Figure 52.

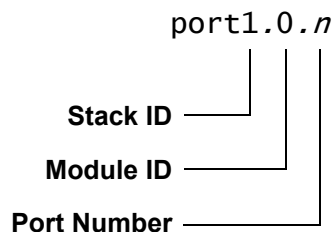

Figure 52. PORT Parameter in the Command Line Interface

The three parts of the PORT parameter are described in Table 19.

Table 19. PORT Parameter Format

Number	Description
Stack ID	Designates the switch's ID number. The correct value is "1" for a standalone switch. Do not enter 0, the value displayed on the Switch ID LED.
Module ID	Designates the module number of a port. The x530 Series switches do not have modules, consequently, this value is always 0 (zero).
Port Number	Designates a port number.

The following is an example of the PORT parameter on a standalone switch. It uses the INTERFACE command to enter the Port Interface mode for ports 15 and 17:

```
awplus> enable
awplus# configure terminal
awplus(config)# interface port1.0.15,port1.0.17
```

For instructions on the command line interface and the PORT parameter, refer to the *Command Reference: x530 Series Switches Running AlliedWare Plus Version 5.5.0* at www.alliedtelesis.com/library.

Chapter 8

Cabling the Networking Ports

This chapter contains the following procedures:

- ❑ “Cabling Twisted Pair Ports” on page 108
- ❑ “Guidelines to Handling SFP and SFP+ Transceivers” on page 109
- ❑ “Installing SFP or SFP+ Transceivers in the Switch” on page 110
- ❑ “Installing SP10TW Direct Connect Twinax Cables” on page 112

Cabling Twisted Pair Ports

Here are the guidelines to cabling the twisted pair ports on the switches:

- ❑ The minimum twisted pair cable requirements are as follows:
 - 10/100 Mbps ports: Standard TIA/EIA 568-B-compliant Category 3 unshielded cabling.
 - 1/2.5/5 Gbps ports: Standard TIA/EIA 568-A-compliant Category 5 or TIA/EIA 568-B-compliant Enhanced Category 5 (Cat 5e) unshielded cabling.
 - 10 Gbps ports: Standard TIA/EIA 568-C-compliant Category 6a unshielded cabling.
- ❑ PoE is enabled by default on the x530-10GHXm, x530-18GHXm, x530-28GPXm and x530-52GPXm switch ports.
- ❑ The connectors on the cables must fit snugly into the ports, and the tabs must lock the connectors into place.
- ❑ The default speed setting for the ports is Auto-Negotiation. This setting is appropriate for ports connected to network devices that also support Auto-Negotiation.
- ❑ The ports must be set to the default setting of Auto-Negotiation to operate at 1 Gbps and higher.
- ❑ The twisted pair ports can operate in either half- or full-duplex mode when operating at 10/100 Mbps. However, if any of the twisted pair ports operate at 1 Gbps or higher, then the duplex mode is always full-duplex.
- ❑ Do not attach cables to ports of static or Link Aggregation Control Protocol (LACP) port trunks until after you configure the trunks on the switch. Otherwise, the ports will form network loops that can adversely affect network performance.



Caution

Disable PoE on ports before connecting or disconnecting twisted pair cables to prevent damaging the switch. Disconnecting Ethernet twisted pair network cables while the switch is providing power to powered devices (PDs) can damage the switch. *↪* **E131**

Guidelines to Handling SFP and SFP+ Transceivers

Review the following guidelines before installing SFP or SFP+ transceivers in the switches:

- ❑ The transceivers are hot-swappable. You can install them while the switch is powered on.
- ❑ For a list of supported transceivers, refer to the product data sheet on the Allied Telesis web site.
- ❑ The operational specifications and fiber optic cable requirements of the transceivers are provided in the documents included with the devices.
- ❑ Install a transceiver before connecting the fiber optic cable.
- ❑ Fiber optic transceivers are dust sensitive. Always keep the plug in the optical bores when a fiber optic cable is not installed, or when you store the transceiver. When you do remove the plug, keep it for future use.
- ❑ Unnecessary removal and insertion of a transceiver can lead to premature failure.



Caution

Transceivers can be damaged by static electricity. Be sure to observe all standard electrostatic discharge (ESD) precautions, such as wearing an antistatic wrist strap, to avoid damaging the devices. ⚡ E92

Installing SFP or SFP+ Transceivers in the Switch

This section contains installation instructions for SFP or SFP+ transceivers in the switches:

- ❑ Ports 9 and 10 of the x530-10GHXm
- ❑ Ports 17 and 18 of the x530-18GHXm
- ❑ Ports 25 to 28 of the x530-28GTXm and x530-28GPXm
- ❑ Ports 49 to 52 of the x530-52GTXm and x530-52GPXm

The following illustrations show a transceiver with a duplex LC connector. The connectors on your transceivers may be different.

To install transceivers, perform the following procedure:

1. Select a port for the transceiver.
2. Remove the transceiver from its shipping container and store the packaging material in a safe location.
3. If you are installing the transceiver in a top port, position the transceiver with the Allied Telesis label facing up. If you are installing the transceiver in a bottom port, position the transceiver with the label facing down. Refer to Figure 53.

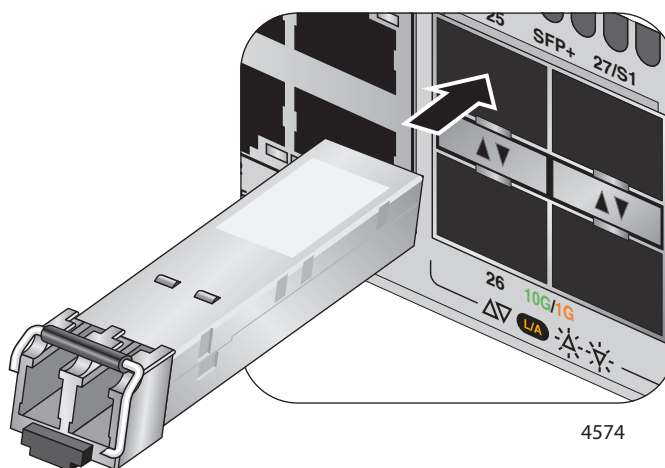

Figure 53. Installing an SFP Transceiver

4. Slide the transceiver into the port until it clicks into place.

Note

If you are ready to attach the fiber optic cable to the transceiver, continue with the next step. Otherwise, repeat steps 1 through 4 to install the remaining transceivers in the switch.

5. Verify the position of the handle on the transceiver. If the transceiver is in a top port, the handle must be in the upright position, as shown in Figure 54. If the transceiver is in a bottom port, the handle must be in the down position.

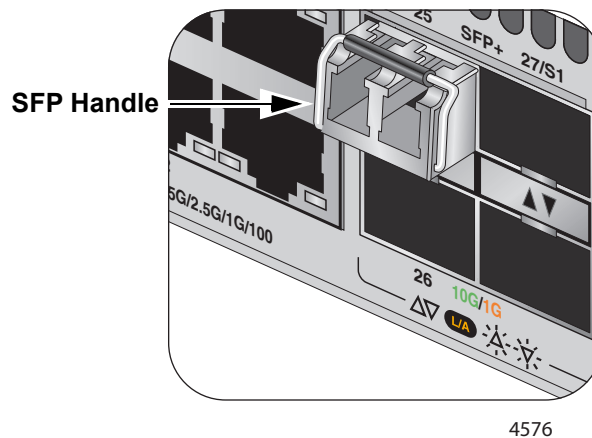

Figure 54. Positioning the SFP or SFP+ Handle in the Upright Position

6. Connect the fiber optic cable to the transceiver, as shown in Figure 55. The connector on the cable must fit snugly into the port, and the tab must lock the connector into place.

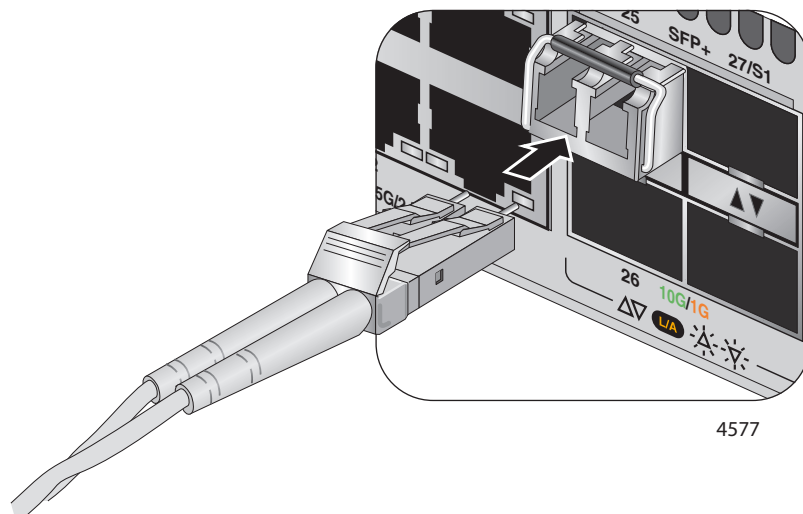

Figure 55. Connecting a Fiber Optic Cable to an SFP or SFP+ Transceiver

7. Repeat this procedure to install additional transceivers.

Installing SP10TW Direct Connect Twinax Cables

The following SFP and SFP+ transceiver ports of the switches support SP10TW direct connect twinax cables:

- ❑ Ports 9 and 10 of the x530-10GHXm
- ❑ Ports 17 and 18 of the x530-18GHXm
- ❑ Ports 25 to 28 of the x530-28GTXm and x530-28GPXm
- ❑ Ports 49 to 52 of the x530-52GTXm and x530-52GPXm

The cables are an economical way to add 10 Gbps connections over short distances. They have SFP+ transceivers on both ends and come in lengths of 1 and 3 meters.

To install SP10TW cables in the switch, perform the following procedure:

1. Select a port for the transceiver.
2. Remove the transceiver from its shipping container and store the packaging material in a safe location.
3. To install the transceiver in a port in the top row, position the transceiver with the Allied Telesis label facing up. To install the transceiver in a port in the bottom row, position the transceiver with the label facing down. Refer to Figure 56.

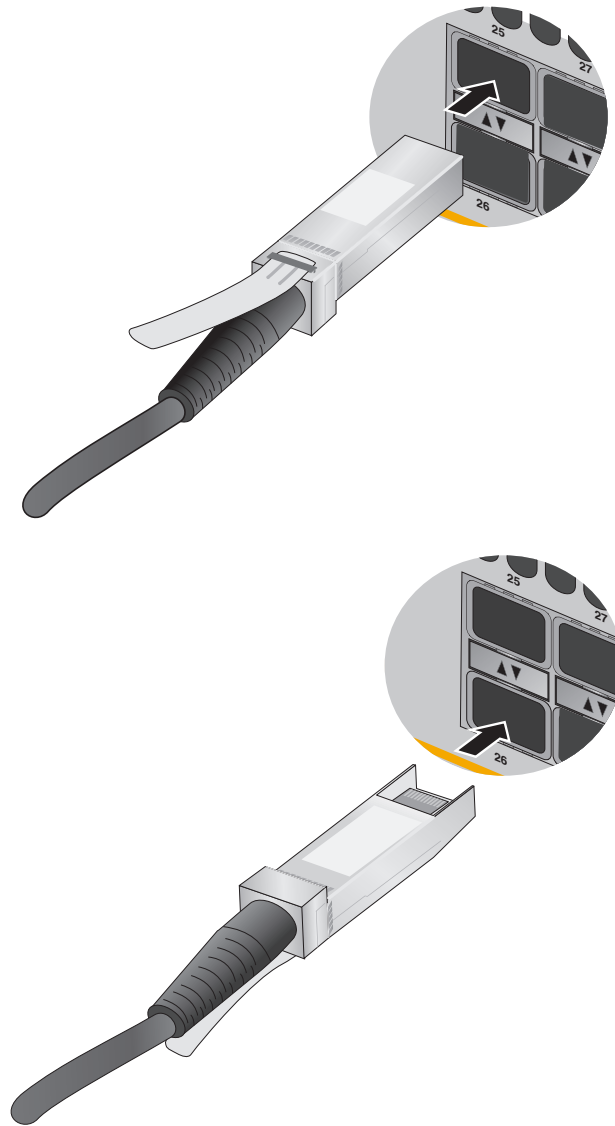

Figure 56. Installing SP10TW Cables

4. Slide the transceiver into the port until it clicks into place.
5. Connect the other end of the cable into an SFP+ port on another network device.
6. Repeat this procedure to install additional transceivers.

Note

To remove the connector and cable from the port, gently push on the connector, pull on the release tab, and slide the connector from the port.

Chapter 9

Troubleshooting

This chapter contains suggestions on how to troubleshoot problems with the switch.

Note

For further assistance, please contact Allied Telesis Technical Support at www.alliedtelesis.com/support.

Problem 1: All the port LEDs and Switch ID LED are off, and the fans are not operating.

Solutions: The unit is not receiving power. Try the following:

- Verify that the power cord is securely connected to the power source and the AC connector on the back panel of the switch.
- Verify that the power outlet has power by connecting another device to it.
- Try connecting the unit to another power source.
- Try a different power cord.
- Verify that the voltage from the power source is within the required levels for your region. The power requirements for the switch are listed in “Power Specifications” on page 124.

Problem 2: All of the port LEDs are off even though the ports are connected to active network devices.

Solution: The switch might be operating in the low power mode. To toggle on the LEDs, press the eco-friendly button on the front panel of the switch. You can also toggle the LEDs off and on with the ECOFRIENDLY LED and NO ECOFRIENDLY LED commands in the command line interface.

Problem 3: A twisted pair port on the switch is connected to an active network device but the port's LINK/ACT LED is off.

Solutions: The port is unable to establish a link to a network device. Try the following:

- ❑ Verify that the network device connected to the twisted pair port is powered on and is operating properly.
- ❑ Try connecting another network device to the twisted pair port with a different cable. If the twisted pair port is able to establish a link, then the problem is with the cable or the other network device.
- ❑ Verify that the twisted pair cable does not exceed 100 meters (328 feet).
- ❑ Verify that you are using the appropriate category of twisted pair cable. Refer to "Cable Requirements" on page 31.
- ❑ Verify that the port is connected to the correct twisted pair cable.

Note

Twisted pair ports may require five to ten seconds to establish a link.

Problem 4: The LINK/ACT LED for an SFP or SFP+ transceiver is off.

Solutions: The fiber optic port on the transceiver is unable to establish a link to a network device. Try the following:

- ❑ Verify that the remote network device connected to the fiber optic port is operating properly.
- ❑ Verify that the fiber optic cable is securely connected to the port on the transceiver and to the port on the remote network device.
- ❑ Check that the transceiver is fully inserted in the port.
- ❑ Verify that the operating specifications of the fiber optic ports on the transceiver and remote network device are compatible.
- ❑ Verify that the correct type of fiber optic cabling is being used.
- ❑ Verify that the port is connected to the correct fiber optic cable.
- ❑ Try connecting another network device to the fiber optic port using a different cable. If the port is able to establish a link, then the problem is with the cable or with the other network device.
- ❑ Use the switch's management software to verify that the port is enabled.
- ❑ If the remote network device is a managed device, use its management firmware to determine whether its port is enabled.
- ❑ Test the attenuation of both directions on the fiber optic cable with a fiber optic tester to determine whether the optical signal is too weak (sensitivity) or too strong (maximum input power).

- ❑ If the problem is with two BiDi (bi-directional) transceivers, refer to their data sheets to verify that their transmission and reception frequencies are opposite each other. For instance, a BiDi transceiver that transmits and receives at 1310nm and 1550nm, respectively, has to be connected to a transceiver that transmits and receives at 1550nm and 1310nm, respectively. Two BiDi transceivers will not establish a link if they transmit and receive at the same frequencies.

Problem 5: An x530 PoE switch is not providing power to a powered device or suddenly stopped providing power to a powered device.

Solutions: Try the following:

- ❑ Check the port's PoE LED. If the LED is flashing amber, the switch has reached its maximum power budget and cannot support any additional PoE devices. Enter the `SHOW POWER-INLINE` command to display PoE status on the switch. The x530-28GPXm and x530-52GPXm switches have a power budget of 740W (370W per power supply). The x530-10GHXm and x530-18GHXm switches have a power budget of 1000W (500W per power supply).
- ❑ For PoE or PoE+ device, review the powered device documentation to confirm that the device supports Mode A of the IEEE 802.3at standard. Mode A is one of two modes that define the connector pins that deliver the power from the port in the switch to the powered device. In Mode A, the power is carried on pins 1, 2, 3, and 6 on the RJ-45 port, the same pins that carry the network traffic. The second mode, Mode B, defines pins 4, 5, 7, and 8 as the power carriers. The x530 PoE switches support Mode A, but not Mode B. Most powered devices are designed to accept power by either mode, but some legacy devices may only support one mode. This can be verified by reviewing the device's documentation or data sheet. Legacy PoE or PoE+ devices that only support Mode B will not work with the switch.
- ❑ For a PoE++ device (Class 5 or higher) connected to the x530-10GHXm or x530-18GHXm switch, review its documentation to confirm that it uses all eight stands (four wire pair-sets) of the network cable for power.
- ❑ Use the `SHOW SYSTEM ENVIRONMENT` command to confirm that both power supplies are operating normally.
- ❑ Verify that you are using the appropriate category of twisted-pair cable. Refer to "Cable Requirements" on page 31.
- ❑ Use the management software on the switch to determine whether PoE is enabled on the port. The default setting for PoE is enabled.
- ❑ Use the `SHOW POWER-INLINE` command to determine whether the PoE power setting for the port has been reduced to a value below the power requirements of the device.

- ❑ Try connecting the device to a different port on the switch.
- ❑ A power supply was powered off.
- ❑ A power supply or the AC power source has failed.
- ❑ The switch is overheating.

Problem 6: The switch functions intermittently.

Solutions: Check the system hardware status through the management software:

- ❑ Use the SHOW SYSTEM ENVIRONMENT command in the Privileged Exec mode to verify that the input voltage from the power source to the switch is stable and within the approved operating range. The unit will shut down if the input voltage fluctuates above or below the approved operating range.
- ❑ Use the SHOW SYSTEM ENVIRONMENT command in the Privileged Exec mode to verify that the fan is operating correctly.
- ❑ Verify that the location of the switch allows for adequate airflow. The unit will shut down if it is overheating.

Problem 7: The Switch ID LED on the front of the switch is flashing the letter “F.”

Solutions: One or more of the following problems has occurred:

- ❑ A cooling fan has failed.
- ❑ The switch might be overheating and may have to shut down.

Contact your Allied Telesis sales representative for assistance.

Appendix A

Technical Specifications

This appendix contains the following sections:

- "Physical Specifications" on page 120
- "Environmental Specifications" on page 123
- "Power Specifications" on page 124
- "RJ-45 Twisted Pair Port Pinouts" on page 126
- "RJ-45 Style Serial Console Port Pinouts" on page 127
- "USB Port" on page 128

Physical Specifications

Dimensions

Table 20 lists the dimensions of the switches. The dimensions are shown in Figure 57 through Figure 62 on page 122.

Table 20. Product Dimensions

Model	Dimension (W x D x H)
x530-10GHXm	44.05 cm x 42.06 cm x 4.37 cm (17.35 in. x 16.56 in. x 1.72 in.)
x530-18GHXm	44.05 cm x 42.06 cm x 4.37 cm (17.35 in. x 16.56 in. x 1.72 in.)
x530-28GTXm	44.05 cm x 32.26 cm x 4.37 cm (17.344 in. x 12.7 in. x 1.72 in.)
x530-28GPXm	44.05 cm x 42.06cm x 4.37 cm (17.344 in. x 16.56 in. x 1.72 in.)
x530-52GTXm	44.05 cm x 32.26 cm x 4.37 cm (17.344 in. x 12.7 in. x 1.72 in.)
x530-52GPXm	44.05 cm x 42.06 cm x 4.37 cm (17.344 in. x 16.56 in. x 1.72 in.)

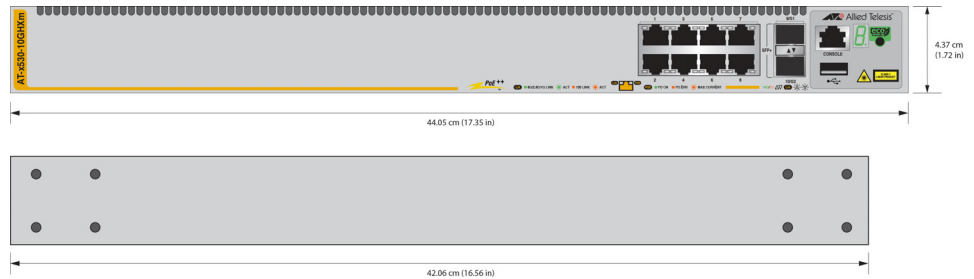

Figure 57. x530-10GHXm Dimensions

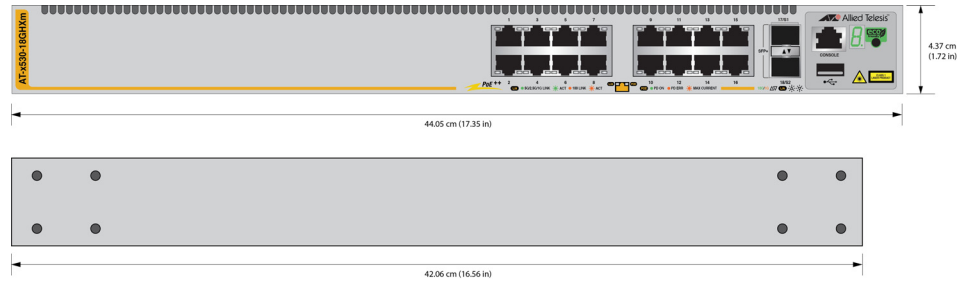

Figure 58. x530-18GHXm Dimensions

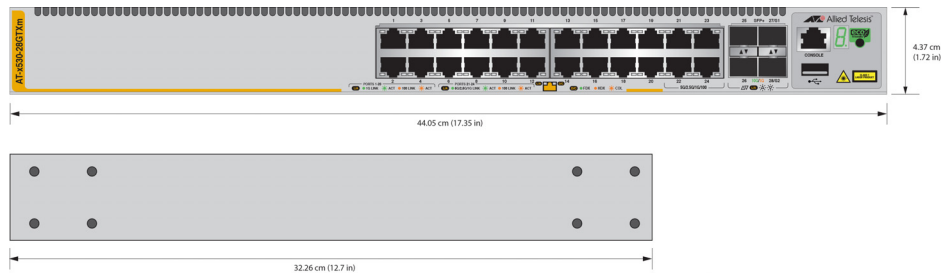

Figure 59. x530-28GTXm Dimensions

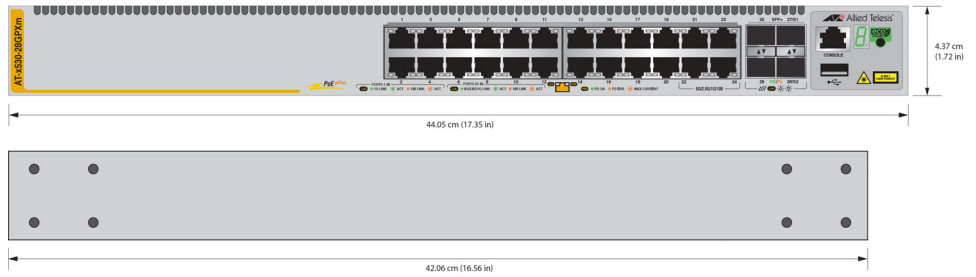

Figure 60. x530-28GPXm Dimensions

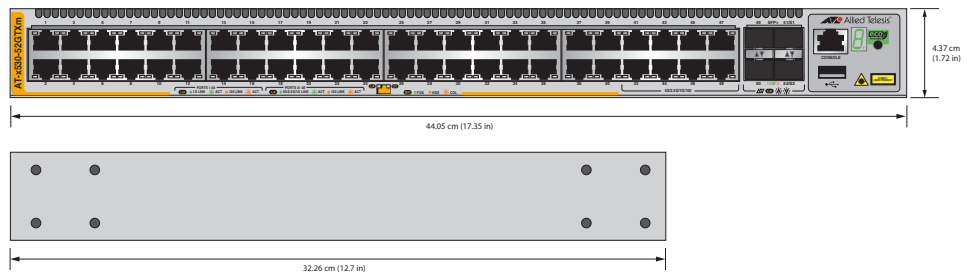

Figure 61. x530-52GTXm Dimensions

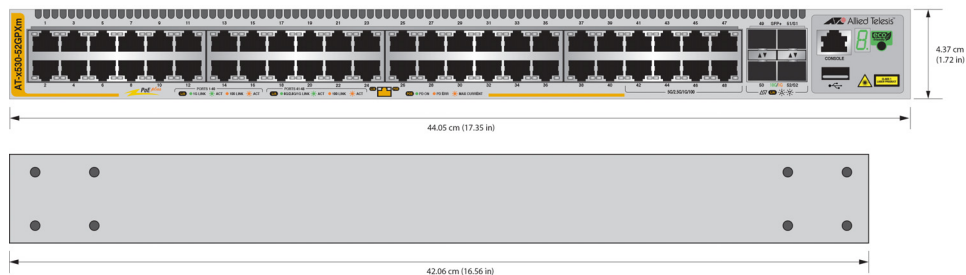

Figure 62. x530-52GPXm Dimensions

Weights

Table 21 lists the weights of the switches.

Table 21. Product Weights

x530-10GHXm	6.6 kg (14.55 lb)
x530-18GHXm	6.7 kg (14.77 lb)
x530-28GTXm	4.42 kg (9.75 lb)
x530-28GPXm	6.31 kg (13.90 lb)
x530-52GTXm	4.67 kg (10.5 lb)
x530-52GPXm	6.09 kg (13.7 lb)

Ventilation

Table 22 lists the ventilation requirements.

Table 22. Ventilation Requirements

Recommended Minimum Ventilation on All Sides	10 cm (4.0 in)
--	----------------

Environmental Specifications

Table 23 lists the environmental specifications of the switches.

Table 23. Environmental Specifications

Operating Temperature	0° C to 50° C (32° F to 122° F)
Storage Temperature	-25° C to 70° C (-13° F to 158° F)
Operating Humidity	5% to 90% noncondensing
Storage Humidity	5% to 95% noncondensing
Maximum Operating Altitude	3,000 m (9,842 ft)
Maximum Nonoperating Altitude	4,000 m (13,100 ft)
Product Noise Level	More than 42 dB @ 30C or less
Installation Requirement	Tabletop, wall or rack mount

Power Specifications

This section contains the maximum power consumption values, input voltages, and heat dissipation values.

Maximum Power Consumption

Table 24 lists the maximum power consumptions for the switches.

Table 24. Maximum Power Consumptions

x530-10GHXm	970 watts
x530-18GHXm	1400 watts
x530-28GTXm	55 watts
x530-28GPXm	900 watts
x530-52GTXm	88 watts
x530-52GPXm	970 watts

Input Voltages

Table 25 lists the input voltages for the switches.

Table 25. Input Voltages¹

x530-10GHXm	100-240 VAC~, 7.6A per input (x2) maximum, 50/60 Hz
x530-18GHXm	100-240 VAC~, 7.6A per input (x2) maximum, 50/60 Hz
x530-28GTXm	100-240 VAC~, 1.0A per input (x2) maximum, 50/60 Hz
x530-28GPXm	100-240 VAC~, 6.0A per input (x2) maximum, 50/60 Hz
x530-52GTXm	100-240 VAC~, 1.0A per input (x2) maximum, 50/60 Hz
x530-52GPXm	100-240 VAC~, 6.0A per input (x2) maximum, 50/60 Hz

1. This information can be found on the rating label. The rating label is put on the bottom of the product.

Heat Dissipation

Table 26 lists the heat dissipation for the switches.

Table 26. Heat Dissipation

x530-10GHXm	3300 BTU/hr
x530-18GHXm	4700 BTU/hr
x530-28GTXm	190 BTU/hr
x530-28GPXm	614 BTU/hr
x530-52GTXm	300 BTU/hr
x530-52GPXm	661 BTU/hr

RJ-45 Twisted Pair Port Pinouts

Figure 63 illustrates the pin layout of the RJ-45 connectors on the front panel of the switch.

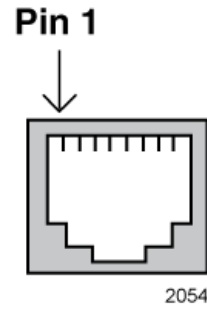

Figure 63. RJ-45 Socket Pin Layout (Front View)

Table 27 lists the pin signals.

Table 27. Pin Signals for 100M/1G/2.5G/5G Base-T Connectors

Pin	100 Mbps MDI Signal	100 Mbps MDI-X Signal	1G/2.5G/5G Signal
1	TX+	RX+	Bi-directional pair A+
2	TX-	RX-	Bi-directional pair A-
3	RX+	TX+	Bi-directional pair B+
4	Not used	Not used	Bi-directional pair C+
5	Not used	Not used	Bi-directional pair C-
6	RX-	TX-	Bi-directional pair B-
7	Not used	Not used	Bi-directional pair D+
8	Not used	Not used	Bi-directional pair D-

RJ-45 Style Serial Console Port Pinouts

Table 28 lists the pin signals of the RJ-45 style serial console port.

Table 28. RJ-45 Style Serial Console Port Pin Signals

Pin	Signal
1	RTS#
2	Not used
3	Transmit Data
4	Ground
5	Ground
6	Receive Data
7	Not used
8	CTS

USB Port

Table 29 lists the pin signals of the USB port.

Table 29. USB Port Pin Signals

Pin	Signal
1	+5V
2	DATA-
3	DATA+
X	NC
4	GND