

## Deployment Guide

### 1. Physical Description

The figure below shows the RXV81 Microsoft Teams Rooms (MTR) on Android Video Collaboration Bar.

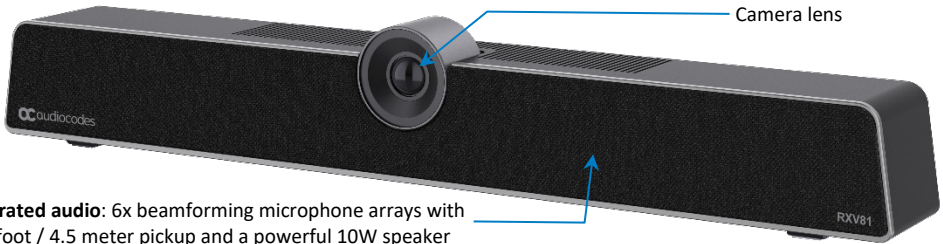

**Integrated audio:** 6x beamforming microphone arrays with 14.7 foot / 4.5 meter pickup and a powerful 10W speaker

### 2. Checklist: Shipped Items

Make sure you received the following items in the shipped box:

- ✓ Power adapter
- ✓ Remote Control (RC) and battery
- ✓ USB Type C cable
- ✓ Wall mount and screws
- ✓ HDMI Out

### 3. Positioning

The RXV81 is suitable for small-to-mid-size rooms. Position the RXV81 below the TV screen and 10 cm / 4 inches above the table (recommended) (see also [here](#)). Use these figures as reference.



**Note:** The camera's wide-angle (110 degrees) horizontal FoV can be adjusted; the camera's vertical position can also be adjusted / fine-tuned.

## 4. Mounting the RXV81 on Top of a TV Screen

The RXV81 can optionally be mounted *on top of a TV screen* using a camera bracket though mounting the device *on the wall below the TV screen* as described [here](#) is recommended.



**Note:** The bracket is an optional accessory. Customers need to purchase it separately.

The figure below shows the bracket.

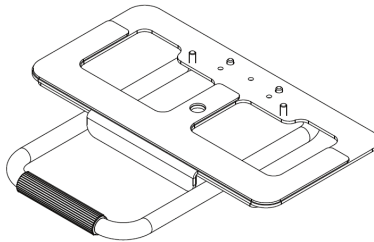

### To install the bracket on a TV screen:

1. Remove the bracket from its box and use the supplied screw to attach it to the bottom of the RXV81.

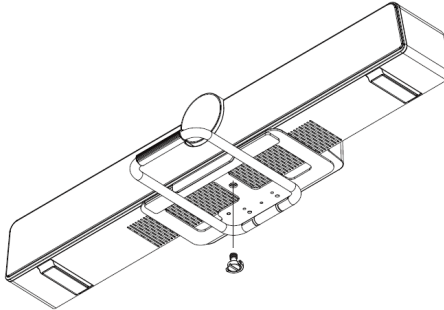

2. Rotate the bracket to adjust the camera's angle.

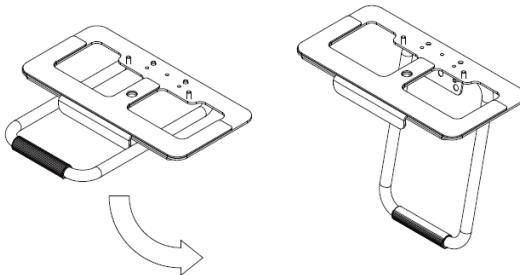

- Place the RXV81 and the bracket on top of the TV screen and clamp the bracket to the TV screen.

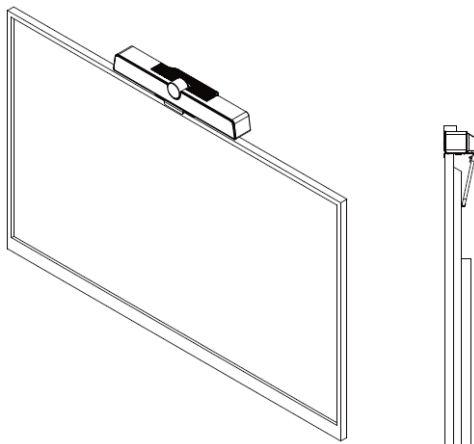

**Note:**

- If you move the TV screen, first take the RXV81 off to prevent it from *falling off*.
- Don't push the RXV81 from back to front; it may fall off.
- Make sure the bracket clamps the TV screen tightly.

## 5. Mounting the RXV81 on the Wall below the TV Screen

The RXV81 can optionally be mounted *on the wall below the TV screen (recommended)*.

🔧 **To mount the RXV81 on the wall below the TV screen:**

- Use the supplied screws and dowels (3 + 1 spare) to fix the bracket (supplied) to the wall. Make sure the bracket's two hooks are *facing upwards*.



2. Position the RXV81 on the shelf (supplied) and then fasten the device to the shelf using the single screw (supplied):

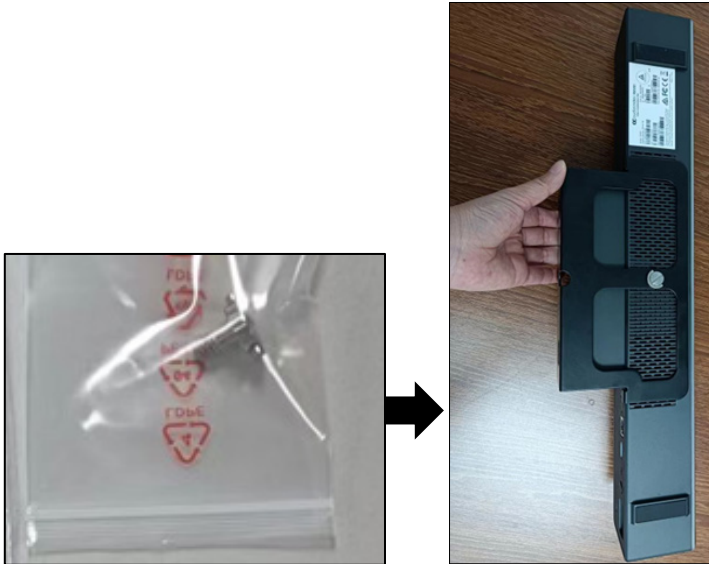

3. Hook the shelf onto the wall bracket; it's hooked onto the bracket's two hooks as shown in the next figure without the RXV81.









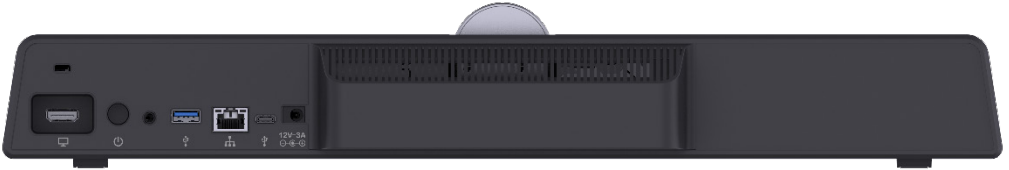

4. View the RXV81 mounted on the shelf hooked onto the bracket on the wall:



## 6. Cabling

The figure below shows the RXV81 rear panel's connector ports.













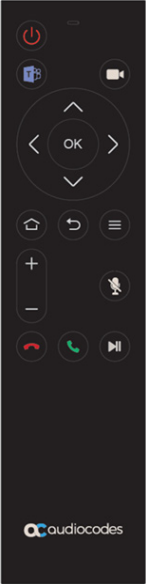

L-R	Description
	Use the supplied HDMI Out cable to connect this port to a TV screen (standalone mode). Applies to RXV81 as a standalone device (default). Video and sharing are displayed on the TV screen. Meetings are controlled via the RC.
	Power on / Reset button.
-	Not applicable
	USB Type A port for touch LCD.
	Ethernet LAN GbE port to connect RJ-45 terminals.
	USB Type C to connect to a BYOD (Bring Your Own Device) (PC/laptop) running a UC client for ad hoc or full peripheral mode. In peripheral mode, the BYOD displays meeting video and content. Meetings are controlled via the BYOD (join, accept, manage participants). Audio/video (camera ePTZ, mic mute) can be controlled via the UC client or the RC (camera on / off, mute, volume). See figure below:
	
 12V-3A	DC power input port for the 12V power supply.

## 7. Powering up

Press the power button  or use the smart Bluetooth Remote Control (see next).

## 8. Smart Bluetooth Remote Control

Use the following figure and the table following it as reference.

 A black, vertical smart Bluetooth remote control with various buttons including a power button, a Teams icon, a camera icon, a directional pad with an OK button, home, back, and menu buttons, volume +/- buttons, a mute button with a microphone icon, call answer/end/hold buttons, and the AudioCodes logo at the bottom.	Press  to switch on; press and hold for at least 2 seconds to reboot the device.
	Press  to return you to Teams.
	Press  to switch the camera on or off; long-press to open Camera Settings.
	Press the direction buttons < > ^ or v to move the camera or the selection.
	Press <b>OK</b> to confirm a selection. After zooming in/out, press OK to restore the default view.
	Press  to return to the home page.
	Press  +  to initially connect the RC to the RXV81.
	Press  to return to the previous menu or to quit.
	Press  to open Device Settings.
	Press + to increase the volume or – to decrease it.
	Press the mute button  to turn the microphone on or off.
	Press  to answer an incoming call.
	Press  to end a call.
Press  to put a call on hold.	

## 9. Management

The RXV81 (as a standalone device *and* as a USB audio / video peripheral device) is fully managed by AudioCodes' One Voice Operations Center Device Manager ). Management includes:

- ✓ Firmware management / upgrade
- ✓ Alarm management (if the Remote Control is missing or if it reaches a low battery level)
- ✓ Upgrade the MTR APK.

## 10. Getting Started

### To get started:

1. After connecting the cables, remove the RC from its packaging and insert the batteries supplied into it.
2. View in the display the message:  
**Remote is not connected. Hold below buttons while holding the remote near the box.**

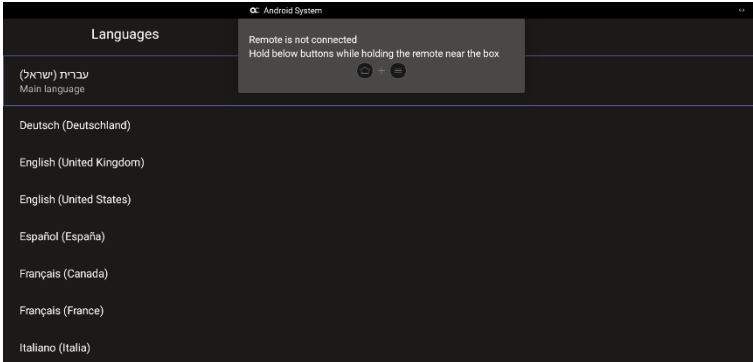

3. On the RC, simultaneously press and hold  +  until RC and RXV81 are successfully connected.

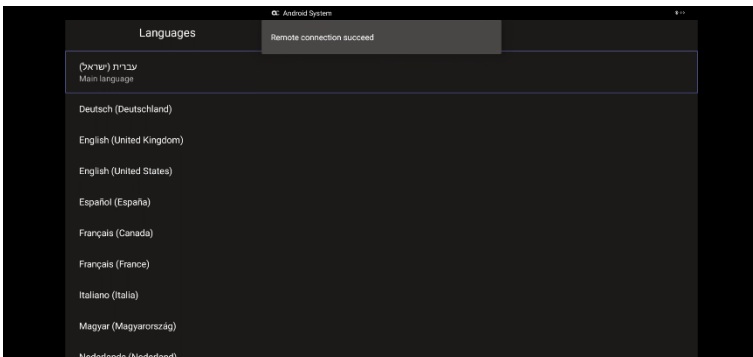
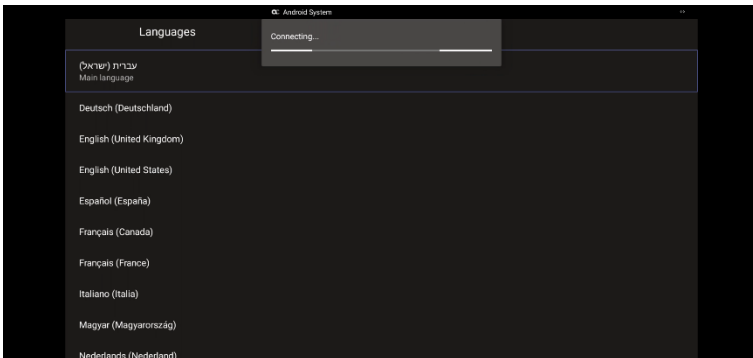

- After successfully connecting, use the remote control to navigate to and select a language as shown in the preceding figure.

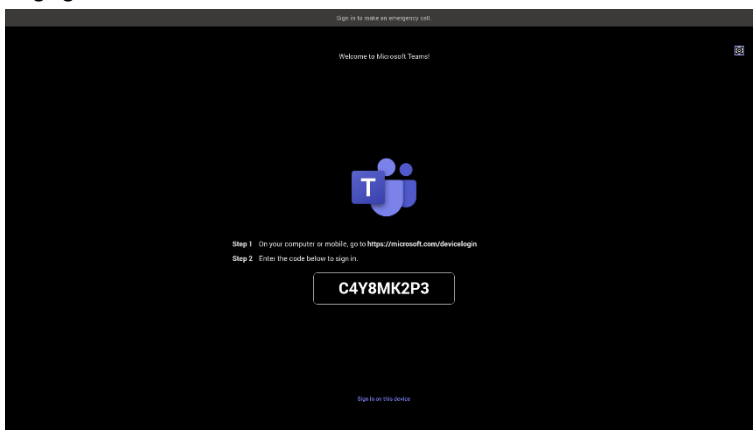

- Go to the [next section](#) to see how to use this code for registering on the Microsoft Teams Portal and signing in.

## 11. Signing in



### Note:

- User licenses won't be supported for use with Microsoft Teams Rooms devices after July 1, 2023. User licenses that were assigned prior to this date to Teams Rooms devices will need to be replaced by a Teams Rooms Basic or Teams Rooms Pro license. Meeting Rooms devices that have a user license after July 1, 2023, will be blocked from signing in until a Teams Rooms license is assigned.
- Microsoft Teams Shared Devices licenses won't be supported on and won't work with Teams Rooms devices. Teams Rooms devices should only be assigned Teams Rooms Basic or Teams Rooms Pro licenses.



🔗 **To sign in:**

1. On your pc | laptop, point the browser to <https://microsoft.com/devicelogin> as instructed.

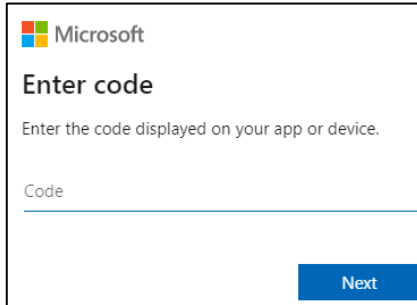

2. Enter the code shown in the last figure in the previous section, e.g., **C4Y8MK2P3**, and then select **Next**.

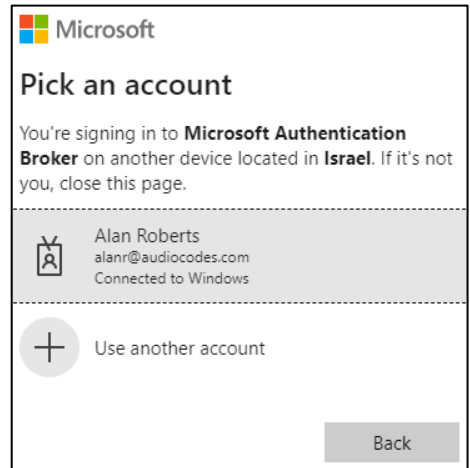
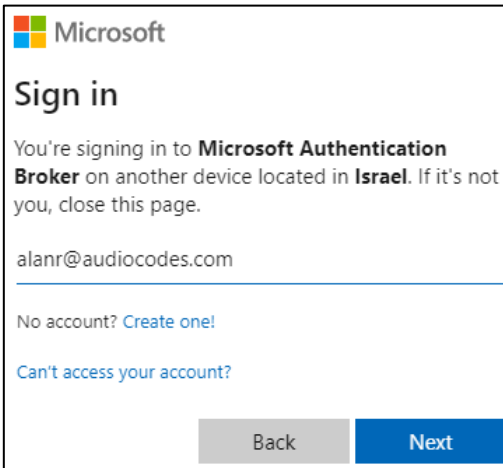

3. Enter email, phone or Skype and then select **Next** -OR- click the account to sign in with.
4. Exit the browser screen and then view the following in the RXV81 display.



5. View after a few moments the RXV81 home page.



## 12. Viewing LEDs to Determine Status



●	Red / white / red & white
White on	Device is powered on, signed in to Teams
White flashing	Device is in booting phase
Red on	Device is in Mute (Highest priority state)
Red flashing	Network connectivity lost / Device is in upgrade mode / RCU connectivity lost
Red + white on	Device is powered on, network is connected, but not signed into Teams
●	Blue
Blue on	In a call (active call or meeting)
Blue flashing	Incoming call
○	Camera on/off
White on	Camera on
White off	Camera off

### International Headquarters

1 Hayarden Street,  
Airport City  
Lod 7019900, Israel  
Tel: +972-3-976-4000  
Fax: +972-3-976-4040

### AudioCodes Inc.

80 Kingsbridge Rd  
Piscataway, NJ 08854, USA  
Tel: +1-732-469-0880  
Fax: +1-732-469-2298

**Contact us:** <https://www.audiocodes.com/corporate/offices-worldwide>

**Website:** <https://www.audiocodes.com/>

©2023 AudioCodes Ltd. All rights reserved. AudioCodes, AC, HD VoIP, HD VoIP Sounds Better, IPmedia, Mediant, MediaPack, What's Inside Matters, OSN, SmartTAP, User Management Pack, VMAS, VolPerfect, VolPerfectHD, Your Gateway To VoIP, 3GX, VocaNom, AudioCodes One Voice, AudioCodes Meeting Insights and AudioCodes Room Experience are trademarks or registered trademarks of AudioCodes Limited. All other products or trademarks are property of their respective owners. Product specifications are subject to change without notice



#### **FCC WARNING**

Prior to operating this device, refer to the device's [Regulatory Information and FCC warnings](#).

### Notice Information

Information contained in this document is believed to be accurate and reliable at the time of printing. However, due to ongoing product improvements and revisions, AudioCodes cannot guarantee accuracy of printed material after the Date Published nor can it accept responsibility for errors or omissions. Updates to this document can be downloaded from <https://www.audiocodes.com/library/technical-documents>.

This document is subject to change without notice.

Date Published: June-20-2023

Document #: LTRT-18112

