

# TEST REPORT

**This laboratory is accredited by National Radio Research Agency Laboratory and National Voluntary Laboratory Accreditation Program.**

The tests reported herein have been performed in accordance with its terms of accreditation.

**Test Report No. : LR500112101A**  
**Issue Date : January 05, 2021**  
**Applied Standard : FCC Part 15, Subpart B and ICES-003**  
**Trade Name : Hanwha Techwin Co., Ltd.**  
**Equipment Name : NVR**  
**Model Name : XRN-6410RB2**  
**Model name : XRN-3210RB2**  
**Serial Number : Identification**

**This test result only responds to the tested sample. It is not allowed to copy this report even partly without the allowance of the test laboratory. The report must not be used by the client to claim product certification, approval, or endorsement by NVLAP, NIST, or any agency of the Federal Government.**



### Revision history

Revision	Date of issue	Test report No.	Description
0	05.01.2021	LR500112101A	Initial

## &gt;&gt;TABLE OF CONTENTS&lt;&lt;

LTA Certification .....	4
General information's.....	6
1- Brief Information.....	7
2- Test Site Description .....	10
3- Test Procedure .....	12
4- List of Equipment Used For the Tests.....	15
5- EMISSION .....	16
5-1 Conducted Emissions .....	16
5-2 Radiated Emissions .....	18
Conclusions .....	22
Photograph of the measurements.....	23
Photograph of the EUT .....	28

## LTA Certification

### Applicant / Manufacturer

Company name : Hanwha Techwin Co., Ltd.  
Address : 6, Pangyo-ro 319 Beon-gil, Bundang-gu, Seongnam-si, Gyeonggi-do, 13488, KOREA  
Telephone / Facsimile : +82-70-7147-8753(<http://hanhwa-security.com>)

### Factory #1

Company name : Hanwha Techwin(Tianjin) Co., Ltd.  
Address : No.11 Weiliu Rd, Micro-Electronic Industrial Park, TEDA, Tianjin, 300385, People's Republic of China

### Factory #2

Company name : HANWHA TECHWIN SECURITY VIETNAM CO.,LTD.  
Address : Lot O-2, Que Vo Industrial Zone extended area ,Nam Son commune, Bac Ninh city, Bac Ninh province, Vietnam

### Factory #3

Company name : D-TECH CO.,LTD.  
Address : 173-25, Saneop-ro, Gwonseon-gu, Suwon-si, Gyeonggi-do, Korea (Suwon Industrial Complex)

### Equipment Under Test (EUT)

Equipment Name : NVR  
Model name : XRN-6410RB2  
Additional Model name : XRN-3210RB2  
Additional Model is different number of channels.  
Serial number : Identification  
Intended environment : Residential area  
Date of receipt : December 21, 2020  
EUT condition : Pre-production, not damaged  
Interface Ports : AC IN, LAN #1 ~ #3, USB #1 ~ #4, HDMI #1 ~ #2, Audio OUT, Alarm IN / OUT  
Power rating : AC 120 V, 60 Hz  
Test Mode : Operating mode  
Test Voltage : AC 120 V, 60 Hz

### Model Description

- NONE

### Model Specification

- NONE

\*\*\* To be continued next page \*\*\*

**LTA Certification –cont.-****Test Performed**

Test started & completed : December 23 - 28, 2020  
Location : LTA Co., Ltd.

**Test Specification**

Purpose of the test : Compliance test to the following standard  
Applied standard : FCC Part 15, Subpart B and ICES-003  
Classification : Class A  
Deviations from Standard Test Method : N/A

**Test Results**

Measurement	Results*	Test method
Conducted Emissions	Complies	ANSI C 63.4-2014
Radiated Emissions	Complies	ANSI C 63.4-2014

\* : The compliance statement is based on nominal value only.

**Modification performed by the lab.:**

- N.A

**Laboratory's Certificate**

Report number : LR500112101A  
Issue date : January 05, 2021

This test report is issued under the authority of:

The test was supervised by:



Young Kyu Shin, Technical Manager



Chan Bum Kim, Test Engineer

The results in this report apply only to the sample(s) tested.

It is not allowed to copy this report even partly without the allowance of the test laboratory.

## General information's

### Purpose

This document is based on the Electromagnetic Interference (EMI) tests performed on the “XRN-6410RB2”. The measurements were performed according to the measurement procedure described in ANSI C 63.4-2014. The tests were carried out in order to confirm whether the electromagnetic emissions from the EUT( Equipment Under Test), are within the Class A limits defined in FCC Part 15, Subpart B- “Section 15.107- Conducted limits” and “Section 15.109-Radiated emission limits”.

### Test Performed

Company name : **LTA Co., Ltd**  
 Address : 4, Songju-ro 236beon-gil, Yangji-myeon, Cheoin-gu, Yongin-si, Gyeonggi-do, 17159, Korea  
 Telephone : +82-31-323-6008  
 Facsimile : +82-31-323-6010

### Measurement uncertainty

Conducted Emissions (0.15 to 30 MHz) : ±2.80 [dB] (k=2)  
 Radiated Emissions (30 to 1,000 MHz) : H : ±4.28 [dB] (k=2) V : ±4.73 [dB] (k=2)  
 (1 GHz to 6 GHz) : H : ±5.89 [dB] (k=2) V : ±5.89 [dB] (k=2)  
 (6 GHz to 18 GHz) : H : ±5.94 [dB] (k=2) V : ±5.98 [dB] (k=2)

The coverage factor k=2 yields approx. a 95% level of confidence for near-normal distribution typical of most measurement results.

### Accredited agencies

LTA Co., Ltd. is approved to perform EMC testing by the following agencies:

Agency	Country	Accreditation No.	Validity	Reference
NVLAP	U.S.A	200723-0	2021-09-30	ECT accredited Lab.
RRA	KOREA		-	RRA accredited Lab.
	U.S.A	KR0049	2021-04-11	
	CANADA		2021-06-16	
	VIETNAM		2021-04-12	
VCCI	JAPAN	C-14948	2023-09-10	VCCI registration
		T-12416	2023-09-10	
		R-14483	2023-10-15	
		G-10847	2021-12-13	
KOLAS	KOREA	KT551	2021-08-20	KOLAS accredited Lab.

## 1- Brief Information

### 1-1 Test Summary

Parameter	Applied Standard	Status (note 1)
<b>I. Emission</b>		
Conducted Emissions	FCC Part 15.107 / ICES-003 Clause 6.1	C
Radiated Emissions	FCC Part 15.109 / ICES-003 Clause 6.2	C
Note 1: C=Complies NC=Not Complies NT=Not Tested NA=Not Applicable * The data in this test report are traceable to the national or international standards.		

#### Frequency range to be scanned:

0.15 MHz - 30 MHz as conducted measurement

30 MHz to 5<sup>th</sup> harmonic of the highest frequency or 40 GHz, whichever is lower as radiated measurement.

#### Bandwidth:

Measured by the CISPR quasi-peak function Bandwidth is 9 kHz in the frequency 0.15 MHz to 30 MHz and 120 kHz in the frequency 30 MHz to 1,000 MHz.

Measured by the Peak function Bandwidth is 1 MHz in the frequency 1 GHz to 40 GHz.

#### A sample calculation:

COR. F (correction factor)= Antenna factor + Cable loss- Amp.gain- Distance correction

Emission Level= meter reading + COR.F

### 1-2 Test mode of the EUT

The tests have been conducted with the following operational mode(s) of the EUT.

Operating mode

### 1-3 Modification

- NONE

**1-4 List of EUT and ACCESSORY**

<b>EUT</b>				
<b>Equipment Name</b>	<b>Model Name</b>	<b>Serial No.</b>	<b>Manufacturer</b>	<b>Remarks</b>
NVR	XRN-6410RB2	N/A	Hanwha Techwin(Tianjin) Co., Ltd. HANWHA TECHWIN SECURITY VIETNAM CO.,LTD. D-TECH CO.,LTD.	-
Mouse	MOKJUO	N/A	N/A	-
<b>ACCESSORY</b>				
<b>Equipment Name</b>	<b>Model Name</b>	<b>Serial No.</b>	<b>Manufacturer</b>	<b>Remarks</b>
Keyboard	KUB-1407	N/A	SHANGHAI RONGTENG ELECTRON TECHNOLOGICAL CO.,LTD	-
Network Camera	QNV-6083R	N/A	Hanwha Techwin Co., Ltd.	-
PoE Injector	SFC501G	N/A	N/A	-
Monitor	24BK550Y	N/A	LG Electronics Nanjing New Technology Co.,Ltd	2 EA
Smart Phone	G4	N/A	LG	-
Notebook	P56	NKW650RB 0006B02606	HANSUNG	-
HUB	SW1600-mini	N/A	IpTIME	-
Earphone	N/A	N/A	N/A	-
Alarm	N/A	N/A	N/A	-
USB Memory Stick	N/A	N/A	N/A	2 EA
HDD #1	WD40PURX-64NN96Y0	N/A	Western Digital	3 EA
HDD #2	WD20PURX-64P6ZY0	N/A	Western Digital	-



**1-5 Cable List**

Cable List						
From		To		Length (m)	Shielding	
Type	I/O Port	Type	I/O Port		Cable	backshell
EUT	AC IN	AC Power Source	3 Pin AC Line	1.6	NO	Plastic
	LAN #1	PoE Injector	LAN	3.0	NO	Plastic
	LAN #2	HUB	LAN	3.0	NO	Plastic
	LAN #3	HUB	LAN	3.0	NO	Plastic
	USB #1	Mouse	USB	1.5	NO	Plastic
	USB #2	Keyboard	USB	1.5	NO	Plastic
	USB #3	USB Memory Stick #1	USB	-	-	-
	USB #4	USB Memory Stick #2	USB	-	-	-
	HDMI #1	Monitor #1	HDMI	1.4	NO	Plastic
	HDMI #2	Monitor #2	HDMI	1.4	NO	Plastic
	Audio OUT	Earphone	-	1.5	NO	Plastic
	Alarm IN / OUT	Alarm	Alarm IN / OUT	1.0	NO	Plastic
	HDD Slot #1	HDD #1	-	-	-	-
	HDD Slot #2	HDD #1	-	-	-	-
	HDD Slot #3	HDD #1	-	-	-	-
	HDD Slot #4	HDD #2	-	-	-	-
PoE Injector	LAN	Network Camera	LAN	3.0	NO	Plastic
	AC IN	AC Power Source	3 Pin AC Line	1.2	NO	Plastic
HUB	LAN	Notebook	LAN	1.0	NO	Plastic
Network Camera	Audio IN	Smart Phone	-	1.4	NO	Plastic
Notebook	DC IN	Battery	DC OUT	-	-	-
HUB	AC IN	AC Power Source	3 Pin AC Line	1.6	NO	Plastic
Monitor#1	AC IN	AC Power Source	3 Pin AC Line	1.5	NO	Plastic
Monitor#2	AC IN	AC Power Source	3 Pin AC Line	1.5	NO	Plastic

## 2- Test Site Description

### 1-Facility

All the testing facilities are periodically serviced as a daily check for equipment and cables systems, an every 6 months facility check for the facilities and a monthly check and annual calibration for testing equipment according to ISO/IEC 17025. All the testing facilities are used as the same specifications shown below. There are descriptions both for radiated disturbance measurement and conducted disturbance measurement conformed by ANSI C 63.4-2014.

The NSA measurement of the 10 m chamber was performed on January 18, 2020 according to ANSI C 63.4:2014

The SVSWR measurement of the 10 m chamber was performed on January 18, 2020 according to ANSI C 63.4:2014

### 2-1 Conducted Emissions

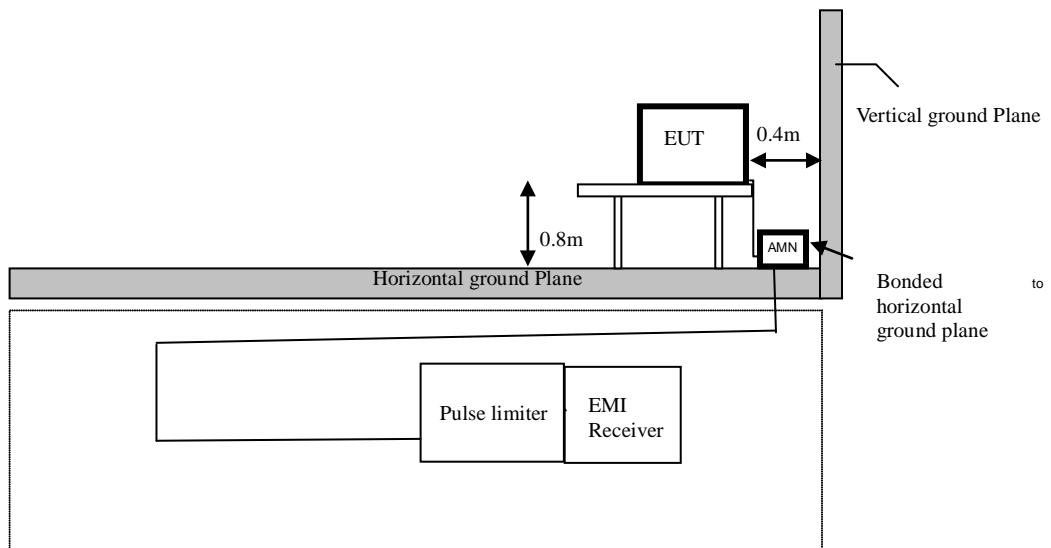

### 2-2 Radiated Emissions – Below 1 GHz

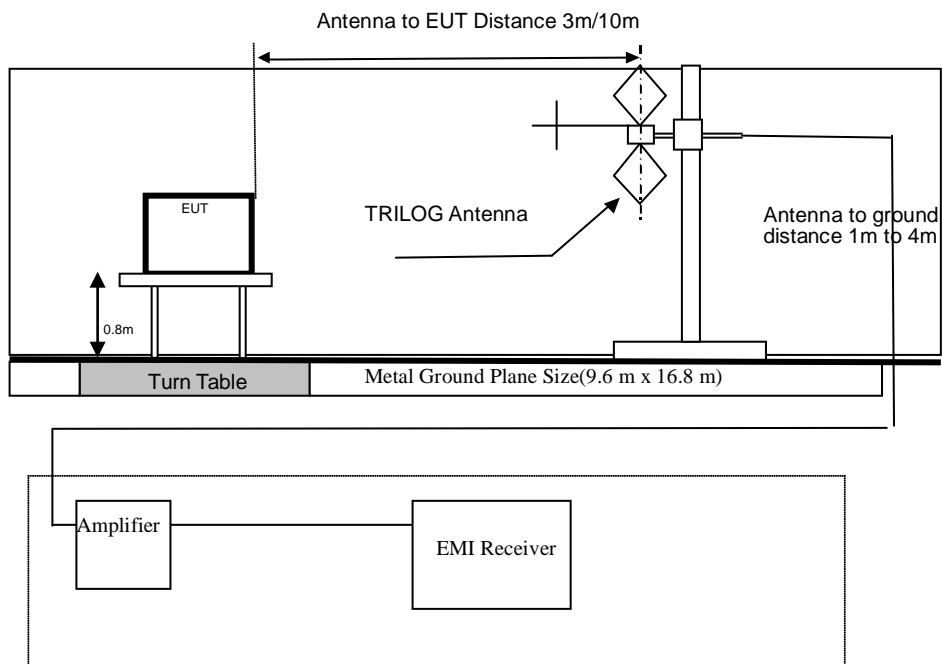

2-3 Radiated Emissions – Above 1 GHz

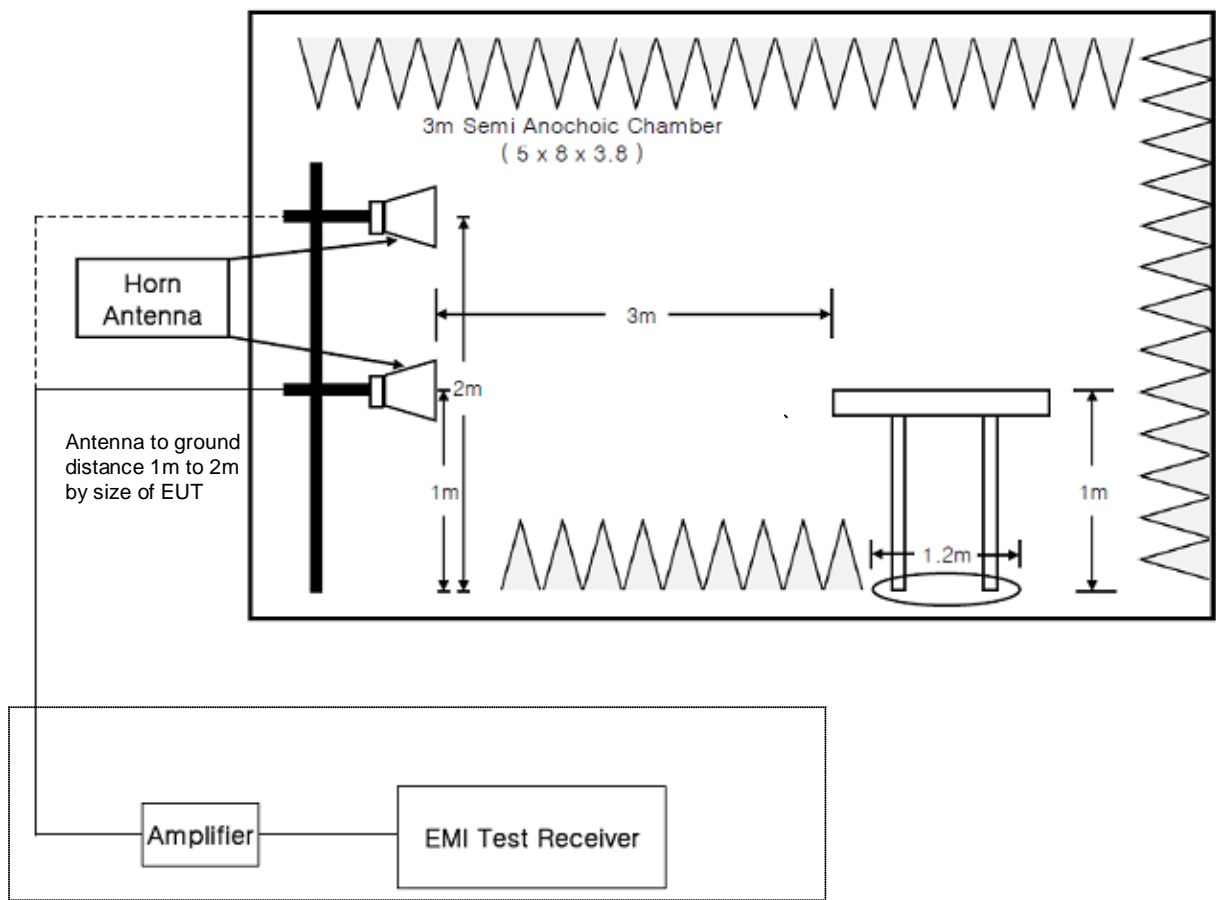

### 3- Test Procedure

#### 3-1 Conducted Emissions

- The measurement is carried out on an open site with horizontal and metallic ground plane.
- An AMN(Artificial Mains Network) with a nominal impedance ( $50 \Omega / 50 \mu\text{H}$ ) as defined in ANSI C 63.4-2014., shall be utilized.
- The AMN is grounded on a horizontal metal ground plane.
- Measurement is carried out using an EMI receiver with quasi-peak detectors and average detector.  
(Refer to the List of test equipment used for the test.)
- The shortest distance between the EUT and the AMN is 0.8 m.
- The EUT is placed on the non-conducting table with 0.8 m height.
- Refer to "Brief Information"(page 7-9) about details of the EUT and configuration of the cables.
- Measurement is carried out as manual operation.
  - searching the maximum frequency point of the disturbance wave in each frequency range.
  - reading the disturbance level of quasi-peak, average and Line (L) and Neutral (N) in 9 kHz bandwidth by the EMI receiver.
  - calculating the measurement result with the following formula or equation.  
(Result = Reading + Cor.F.(LISN Factor + Cable Loss + Pulse Limiter)  
(ex) =  $13.23 \text{ dB}\mu\text{V} + (9.63 \text{ dB} + 0.01 \text{ dB} + 9.86 \text{ dB})$   
=  $32.73 \text{ dB}\mu\text{V}$

### 3-2 Radiated Emissions – Below 1 GHz

- Test site is met the requirements of ANSI C 63.4-2014 and the distance between the EUT and the antenna is adjusted 3 m or 10 m.
  - The turntable can be rotated 360 degrees.
  - The antenna can be adjusted between 1 m and 4 m in height above the ground.
  - The EUT is placed on the non-conducting table with 0.8 m height on the turntable.
  - Measurements are carried out using an EMI receiver with quasi-peak detectors (120 kHz bandwidth).
  - Refer to the list of test equipment used for the test.
  - The TRILOG antenna are used as wideband antenna.
  - The TRILOG antenna is used in the frequency range of 30 MHz to 1 000 MHz.
  - A variable attenuator is used for verifying amplifier's linearity.
  - Rotating the turntable and adjusting the height of the antenna are carried out by control buttons on the console.
  - Refer to "Brief Information"(page 7-9) about details of the EUT and configuration of the cables.
  - Measurement is carried out by a LTA operator as manual operation.
- searching the worst direction with the maximum level of the disturbance wave in rotating the turntable 360 degrees at each searched frequency point.
- setting the height of the antenna with the maximum level of the disturbance wave from 1 m to 4 m.
- reading the disturbance level by the EMI receiver with quasi-peak detectors (120 kHz bandwidth) according to ANSI C 63.4-2014.
- measuring to vertical and horizontal polarization.
- calculating the measurement result with the following formula or equation:  
(Result = Reading + Cor.F (antenna factor + cable loss – PreAmp Gain)
- (ex) = 50.6 dB $\mu$ V/m + (11.08 dB(1/m) + 1.31 dB - 27.32 dB)  
= 35.67 dB $\mu$ V/m

### 3-3 Radiated Emissions – Above 1 GHz

- Test site is met the requirements of ANSI C 63.4-2014 and the distance between the EUT and the antenna is adjusted 3 m.
- The turntable can be rotated 360 degrees.
- The antenna can be adjusted between 1 m and 4 m in height above the ground.
- The EUT is placed on the non-conducting table with 1 m height on the turntable.
- Measurements are carried out using an EMI receiver with peak and average detectors(1 MHz bandwidth).
- Refer to the list of test equipment used for the test.
- The HORN antenna are used as wideband antenna.
- The HORN antenna is used in the frequency range of 1 GHz to 18 GHz.
- A variable attenuator is used for verifying amplifier's linearity.
- Rotating the turntable and adjusting the height of the antenna are carried out by control buttons on the console.
- Refer to "Brief Information"(page 7-9) about details of the EUT and configuration of the cables.
- Measurement is carried out by a LTA operator as manual operation.
  - searching the worst direction with the maximum level of the disturbance wave in rotating the turntable 360 degrees at each searched frequency point.
  - setting the height of the antenna with the maximum level of the disturbance wave from 1 m to 4 m
  - reading the disturbance level by the EMI receiver with peak and average detectors (1 MHz bandwidth) according to ANSI C 63.4-2014.
  - measuring to vertical and horizontal polarization.
  - calculating the measurement result with the following formula or equation:  
(Result = Reading + Cor.F (antenna factor + cable loss – PreAmp Gain)  
(ex) = 35.9 dB $\mu$ V/m + (23.92 dB(1/m) + 7.01 dB - 38.33 dB)  
= 28.5 dB $\mu$ V/m

#### 4- List of Equipment Used For the Tests

##### Conducted Emissions

	Item	Model Name	Manufacturer	Serial No.	Next Cal.	Interval
<input checked="" type="checkbox"/>	EMI TEST Receiver	ESR	Rohde & Schwarz	101499	2021.07.02	1 year
<input checked="" type="checkbox"/>	Pulse Limiter	ESH3-Z2	Rohde & Schwarz	100710	2021.03.16	1 year
<input type="checkbox"/>	LISN	ESH3-Z6	Rohde & Schwarz	100378	2021.09.03	1 year
<input type="checkbox"/>	LISN	ESH3-Z6	Rohde & Schwarz	101468	2021.09.03	1 year
<input checked="" type="checkbox"/>	LISN(main)	ENV216	Rohde & Schwarz	100408	2021.09.04	1 year
<input checked="" type="checkbox"/>	LISN(sub)	LT32C/10	AFJ	32031518210	2021.09.03	1 year
<input checked="" type="checkbox"/>	TEST PROGRAM	e3_ce 20181212a (V9)	AUDIX	-	-	-

##### Radiated Emissions – Below 1 GHz

	Item	Model Name	Manufacturer	Serial No.	Next Cal.	Interval
<input checked="" type="checkbox"/>	EMI TEST Receiver	ESU	Rohde & Schwarz	100092	2021.09.03	1 year
<input checked="" type="checkbox"/>	Amplifier (25 dB)	8447D	HP	2944A07684	2021.11.10	1 year
<input type="checkbox"/>	BILOG Antenna	VULB 9168	SCHWARZBECK	775	2021.03.26 (KOLAS)	2 year
<input checked="" type="checkbox"/>	BILOG Antenna	VULB 9168	SCHWARZBECK	775	2021.11.12 (RRA)	2 year
<input checked="" type="checkbox"/>	TEST PROGRAM	e3 20181212a (V9)	AUDIX	-	-	-

##### Radiated Emissions – Above 1 GHz

	Item	Model Name	Manufacturer	Serial No.	Next Cal.	Interval
<input checked="" type="checkbox"/>	EMI TEST Receiver	ESU	Rohde & Schwarz	100092	2021.09.03	1 year
<input checked="" type="checkbox"/>	Amplifier	8449B	Agilent	3008A02126	2021.03.17	1 year
<input checked="" type="checkbox"/>	Amplifier	PAM-840A	COM-POWER	461314	2021.03.16	1 year
<input checked="" type="checkbox"/>	HORN ANTENNA	3116B	ETS	133350	2022.05.12	1 year
<input type="checkbox"/>	HORN ANTENNA	3116B	ETS	81109	2022.05.12	1 year
<input type="checkbox"/>	HORN ANTENNA	3115	ETS	114105	2021.09.17 (KOLAS)	2 year
<input checked="" type="checkbox"/>	HORN ANTENNA	3115	ETS	114105	2021.11.11 (RRA)	2 year
<input checked="" type="checkbox"/>	TEST PROGRAM	e3 20181212a (V9)	AUDIX	-	-	-

## 5- EMISSION

### 5-1 Conducted Emissions

(LINE)



4, Songjuro 236 Beon-gil, Yangji-myeon  
Cheoin-gu, Youngin-si, Gyeonggi-do  
449-822 Korea  
Tel:+82-31-3236008,9  
Fax:+82-31-3236010

EUT /Model No. : XRN-6410RB2	Phase : Line
Test Mode : Operating mode	Test Power : 120 V / 60 Hz
Temp./ Humi. : 21 'C / 38 % R.H.	Test Engineer : KIM C B

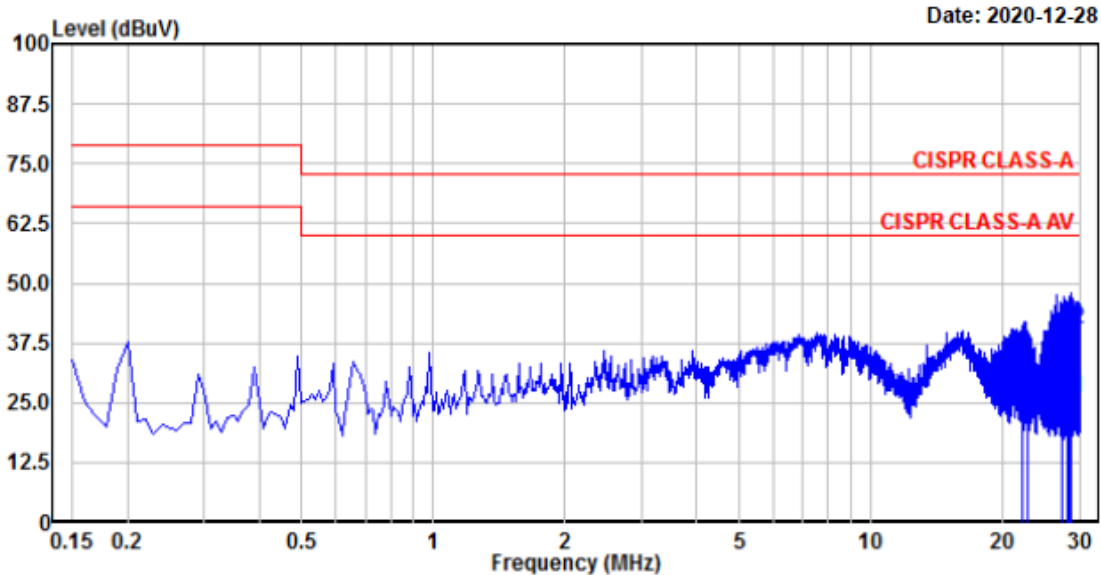

No.	Freq MHz	RD QP dBuV	RD AV dBuV	C.F dB	Result QP dBuV	Result AV dBuV	Limit QP dBuV	Limit AV dBuV	Margin QP dB	Margin AV dB	Phase
2.	22.089	14.75	1.45	20.01	34.76	21.46	73.00	60.00	38.24	38.54	Line
4.	22.911	13.29	0.78	20.02	33.31	20.80	73.00	60.00	39.69	39.20	Line
6.	27.387	19.68	4.80	20.09	39.77	24.89	73.00	60.00	33.23	35.11	Line
8.	28.154	20.85	6.43	20.10	40.95	26.53	73.00	60.00	32.05	33.47	Line
10.	28.426	21.53	6.78	20.11	41.64	26.89	73.00	60.00	31.36	33.11	Line
12.	28.787	20.19	6.02	20.11	40.30	26.13	73.00	60.00	32.70	33.87	Line

Remarks: C.F (Correction Factor) = Insertion loss + Cable loss + Pulse Limiter



(NEUTRAL)



4, Songjuro 236 Beon-gil, Yangji-myeon  
 Cheoin-gu, Youngin-si, Gyeonggi-do  
 449-822 Korea  
 Tel:+82-31-3236008,9  
 Fax:+82-31-3236010

EUT /Model No. : XRN-6410RB2	Phase : Neutral
Test Mode : Operating mode	Test Power : 120 V / 60 Hz
Temp./ Humi. : 21 'C / 38 % R.H.	Test Engineer : KIM C B

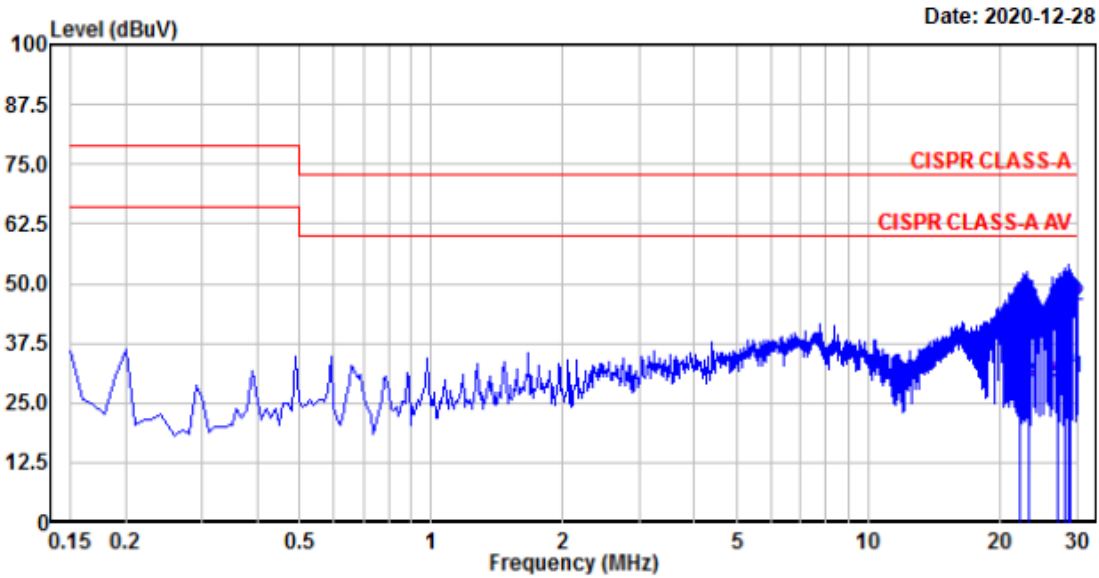

No.	Freq MHz	RD QP dBuV	RD AV dBuV	C.F dB	Result QP dBuV	Result AV dBuV	Limit QP dBuV	Limit AV dBuV	Margin QP dB	Margin AV dB	Phase
2.	22.281	25.16	9.50	20.07	45.23	29.57	73.00	60.00	27.77	30.43	neutral
4.	23.331	24.74	8.91	20.09	44.83	29.00	73.00	60.00	28.17	31.00	neutral
6.	26.986	23.42	8.99	20.16	43.58	29.15	73.00	60.00	29.42	30.85	neutral
8.	27.995	26.40	11.16	20.17	46.57	31.33	73.00	60.00	26.43	28.67	neutral
10.	28.715	25.83	11.12	20.20	46.03	31.32	73.00	60.00	26.97	28.68	neutral
12.	29.005	25.21	10.12	20.20	45.41	30.32	73.00	60.00	27.59	29.68	neutral

Remarks: C.F (Correction Factor) = Insertion loss + Cable loss + Pulse Limiter

### 5-2 Radiated Emissions

(Below 1GHz) / V



4, Songjuro 236Beon-gil, yanggi-myeon,  
Yongin-si, Gyeonggi-do, Korea  
Tel : +82-31-3236008,9  
Fax : +82-31-3236010  
www.ltalab.com

EUT/Model No.:	XRN-6410RB2	Temp/Humi:	21 'C / 35 % R.H.
Test Mode	: Operating mode	Tested by:	KIM C B
Power	: 120 V / 60 Hz		

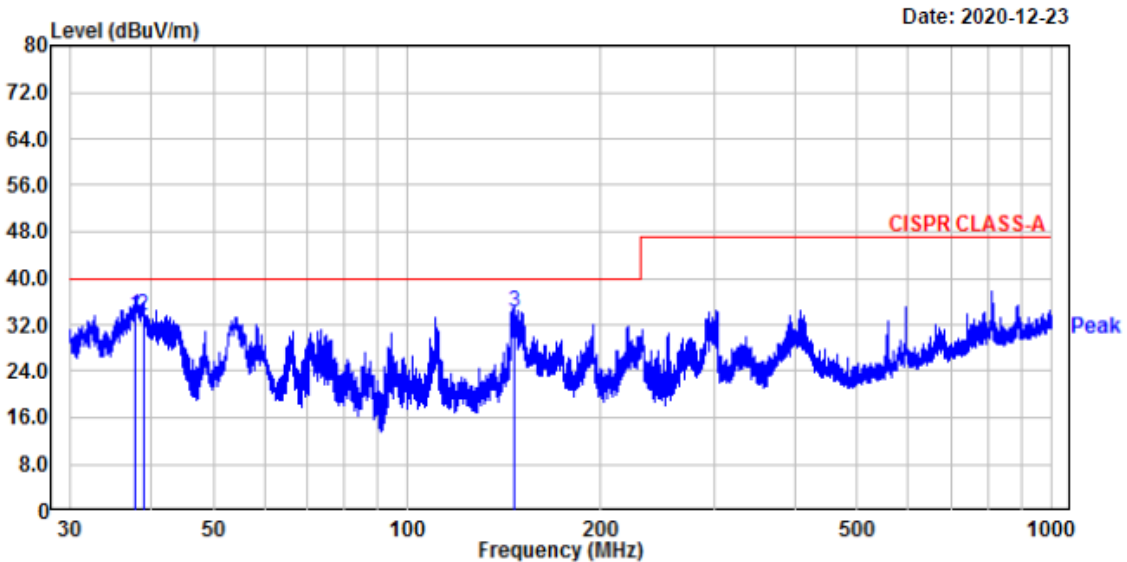

No.	Freq MHz	Reading dBμV	C.F dB	Result QP dBμV/m	Limit dBμV/m	Margin dB	Height cm	Angle deg	Polarity
1.	37.88	48.70	-15.18	33.52	40.00	6.48	126	165	vertical
2.	38.89	48.60	-15.00	33.60	40.00	6.40	122	301	vertical
3.	146.69	47.59	-13.44	34.15	40.00	5.85	138	244	vertical

Remarks: C.F (Correction Factor) = Antenna factor + Cable loss - Preamp gain

(Below 1 GHz) / H



4, Songjuro 236Beon-gil, yanggi-myeon,  
Yongin-si, Gyeonggi-do, Korea  
Tel : +82-31-3236008,9  
Fax : +82-31-3236010  
www.ltalab.com

EUT/Model No.: XRN-6410RB2                      Temp/Humi: 21 'C / 35 % R.H.  
-----  
Test Mode : Operating mode                      Tested by: KIM C B  
-----  
Power : 120 V / 60 Hz  
-----

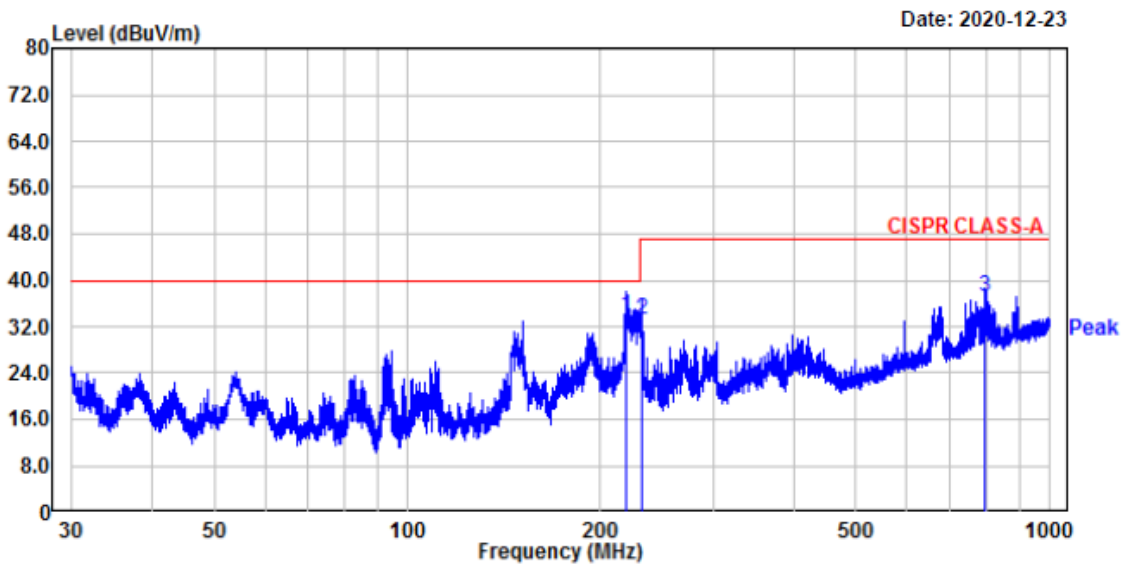

No.	Freq MHz	Reading dBμV	C.F dB	Result QP dBμV/m	Limit dBμV/m	Margin dB	Height cm	Angle deg	Polarity
1.	219.27	48.70	-14.87	33.83	40.00	6.17	327	39	horizontal
2.	232.12	47.51	-14.18	33.33	47.00	13.67	378	285	horizontal
3.	795.49	37.40	-0.25	37.15	47.00	9.85	325	236	horizontal

Remarks: C.F (Correction Factor) = Antenna factor + Cable loss - Preamp gain

(Above 1 GHz) / V\_ 1 GHz ~ 18 GHz

EUT/Model No. : XRN-6410RB2 Temp/Humi: 20 °C / 34 % R.H.  
 -----  
 Test Mode : Operating mode Tested by: KIM C B  
 -----  
 Power : 120 V / 60 Hz  
 -----

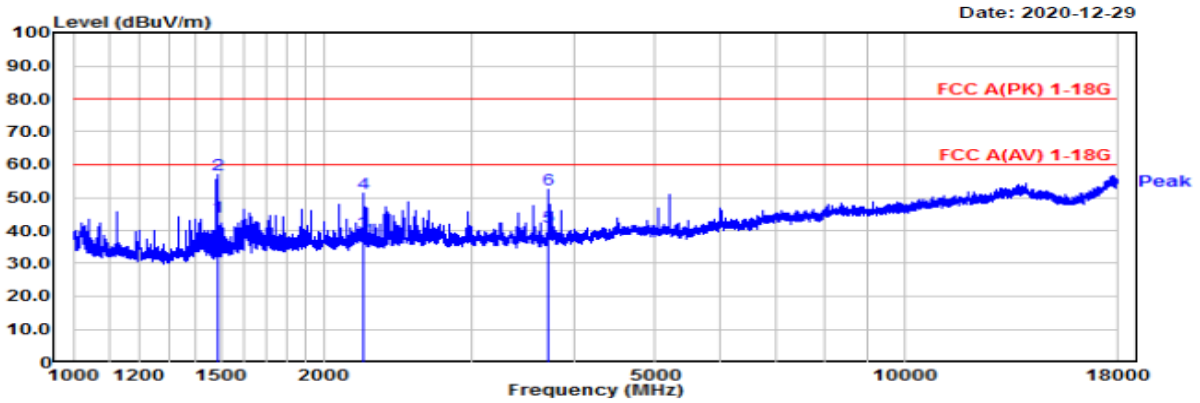

(Above 1 GHz) / H\_ 1 GHz ~ 18 GHz

EUT/Model No. : XRN-6410RB2 Temp/Humi: 20 °C / 34 % R.H.  
 -----  
 Test Mode : Operating mode Tested by: KIM C B  
 -----  
 Power : 120 V / 60 Hz  
 -----

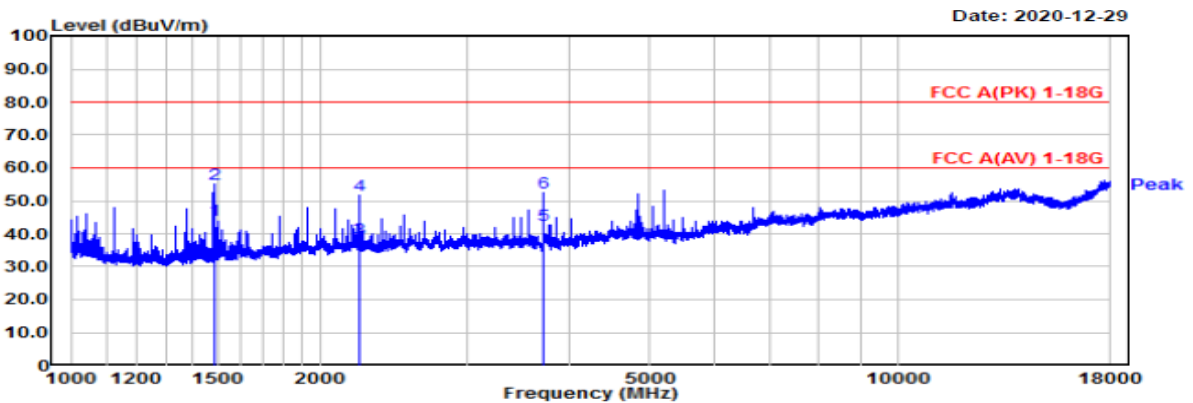

Manufacture : HANWHA TECHWIN SECURITY VIETNAM CO.,LTD. Test Date 2020-12-23 Temp.: 21 °C Humidity: 35 % Distance (m) 3.8  
 Model : XRN-6410RB2  
 TEST mode : Operating mode

Frequency MHz	Reading(PK) dBuV	Reading(AV) dBuV	C.F dB	Result(PK) dBuV/m	Result(AV) dBuV/m	Limit(PK) dBuV/m	Limit(AV) dBuV/m	Margin(PK) dB	Margin(AV) dB	Height cm	Angle deg	Polarity H/V
1484.77	66.34	55.42	-9.30	57.04	46.12	80.00	60.00	22.96	13.88	100	156	H
2227.76	58.71	45.73	-5.13	53.58	40.60	80.00	60.00	26.42	19.40	100	131	H
3711.76	56.26	46.33	-1.75	54.51	44.58	80.00	60.00	25.49	15.42	100	98	H
1484.77	68.47	55.37	-9.30	59.17	46.07	80.00	60.00	20.83	13.93	100	218	V
2227.76	58.46	46.37	-5.13	53.33	41.24	80.00	60.00	26.67	18.76	100	23	V
3711.76	56.08	45.00	-1.75	54.33	43.25	80.00	60.00	25.67	16.75	100	126	V



## Conclusions

Product models "**XRN-6410RB2**" meets all of the Class A requirements of the FCC Part 15, Subpart B. Limits of radio disturbance characteristics of ITE).

(Refer to Test Specification and Test Results in the "LTA certification", page 4 and 5)

- The highest internal source of an EUT is higher than 108 MHz, the measurement shall be made up to 21 GHz.

(The highest internal source of an EUT : 4.1 GHz)

## Photograph of the measurements

Conducted Emissions





Radiated Emissions (Below 1 GHz)

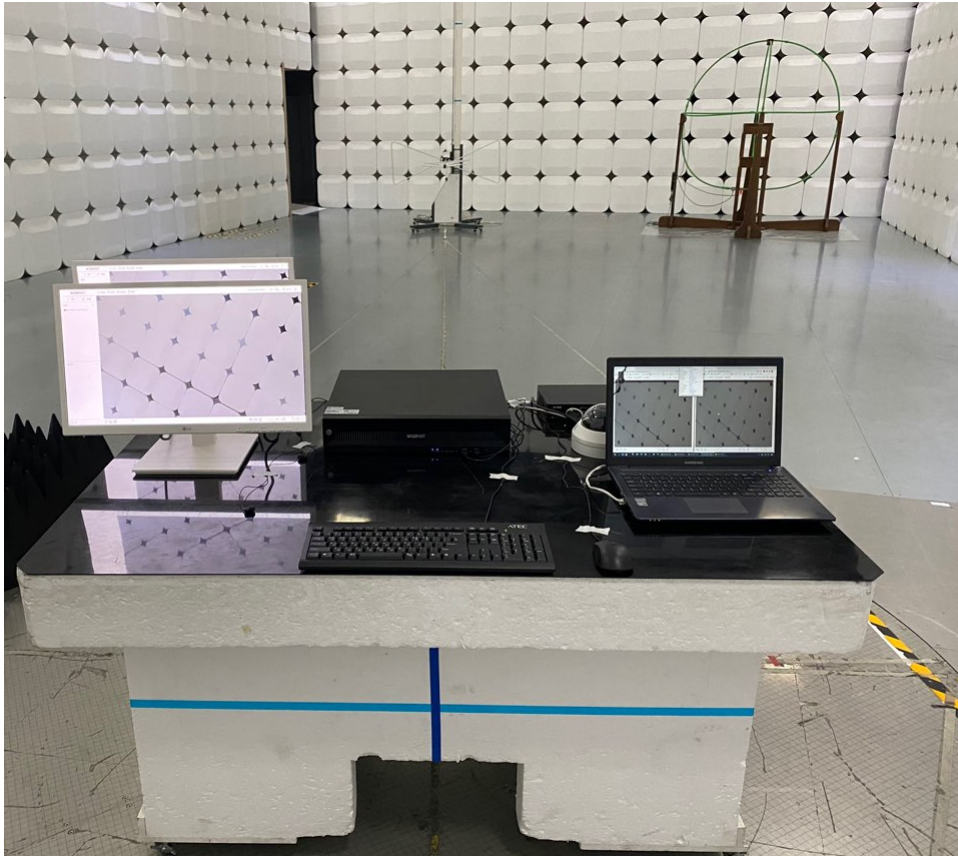

Radiated Emissions (Above 1 GHz) / 1 GHz ~ 18 GHz

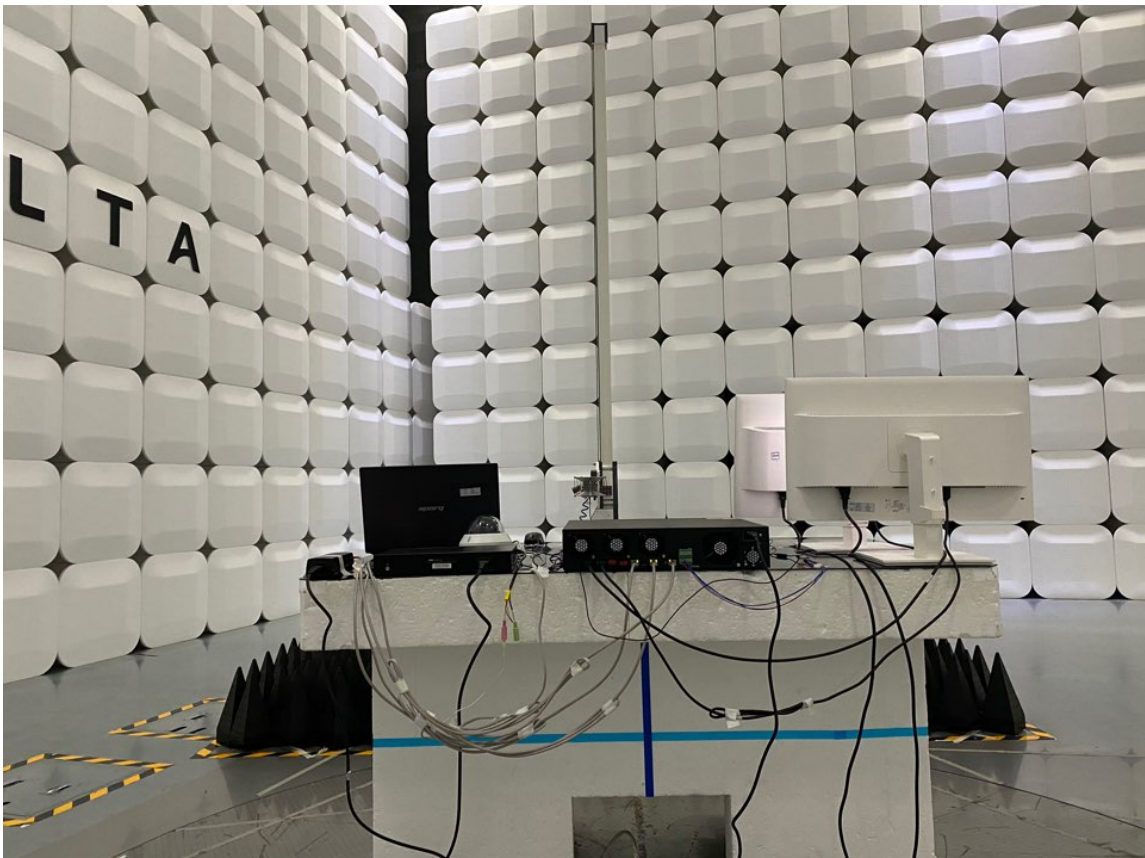
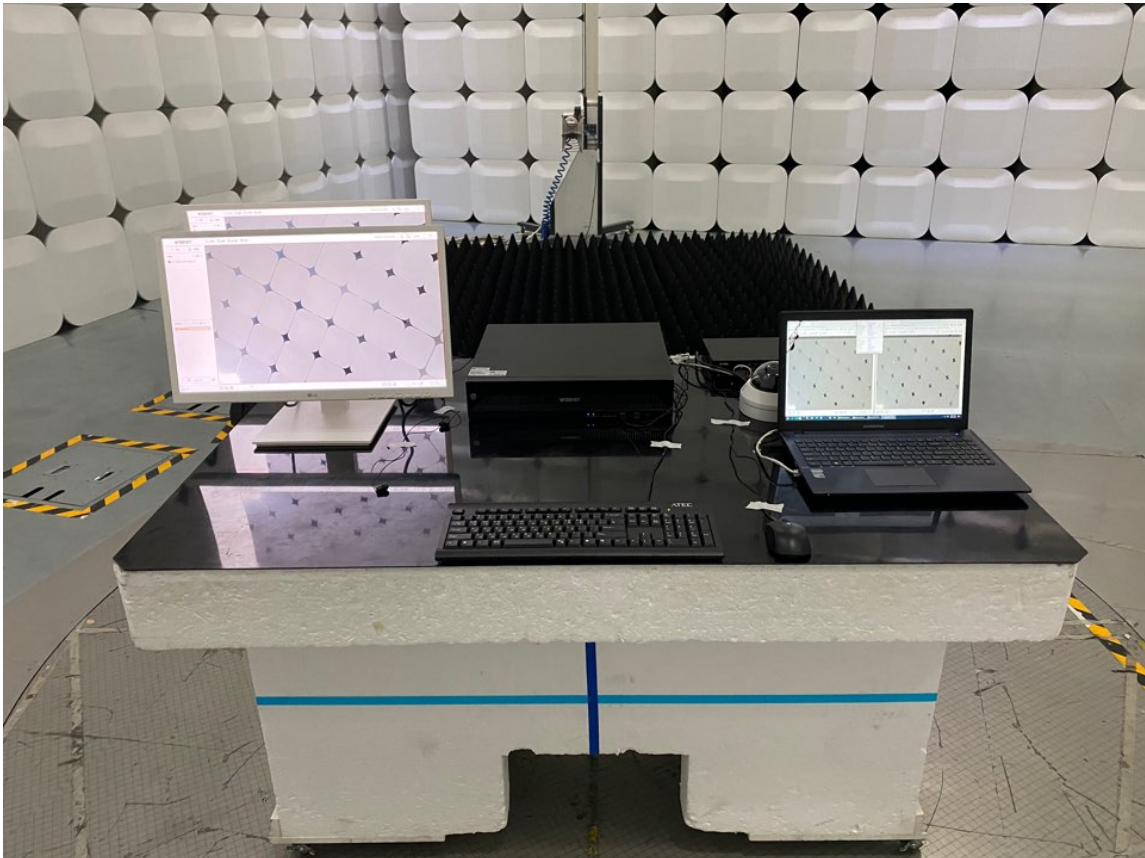

Radiated Emissions (Above 1 GHz) / 18 GHz ~ 21 GHz

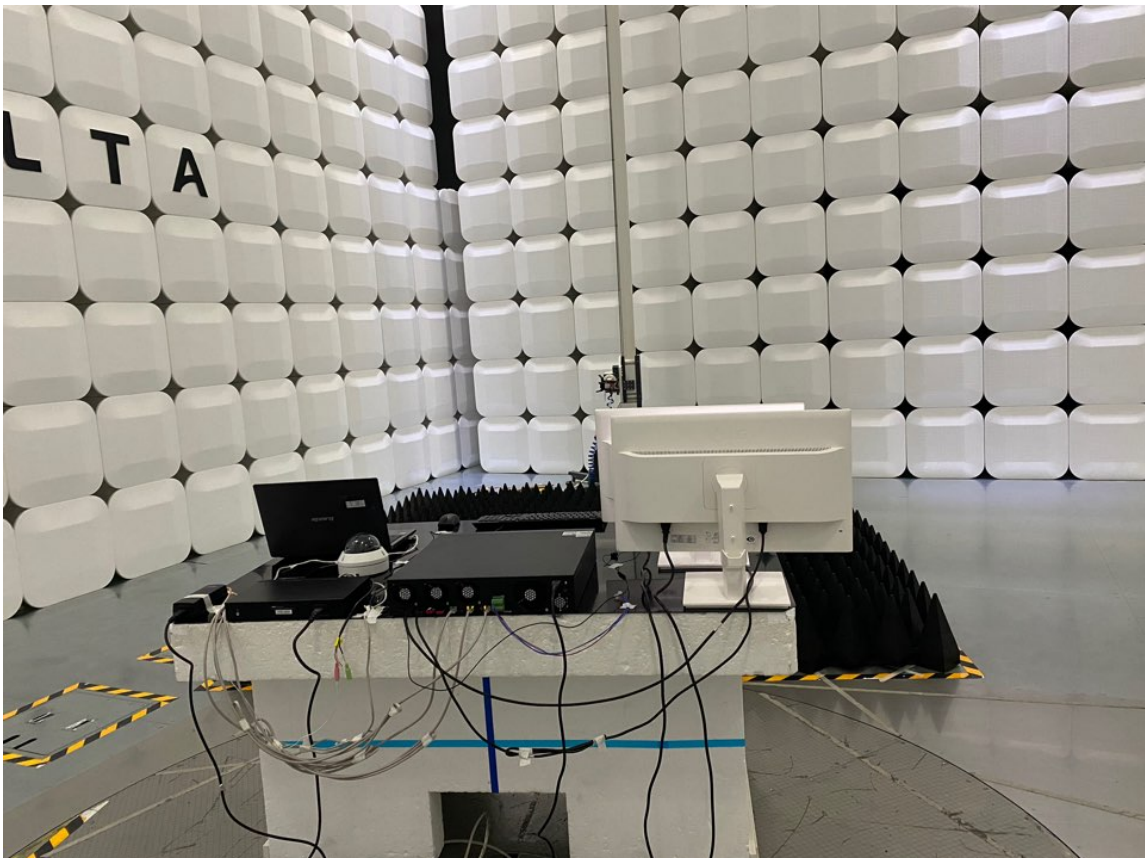
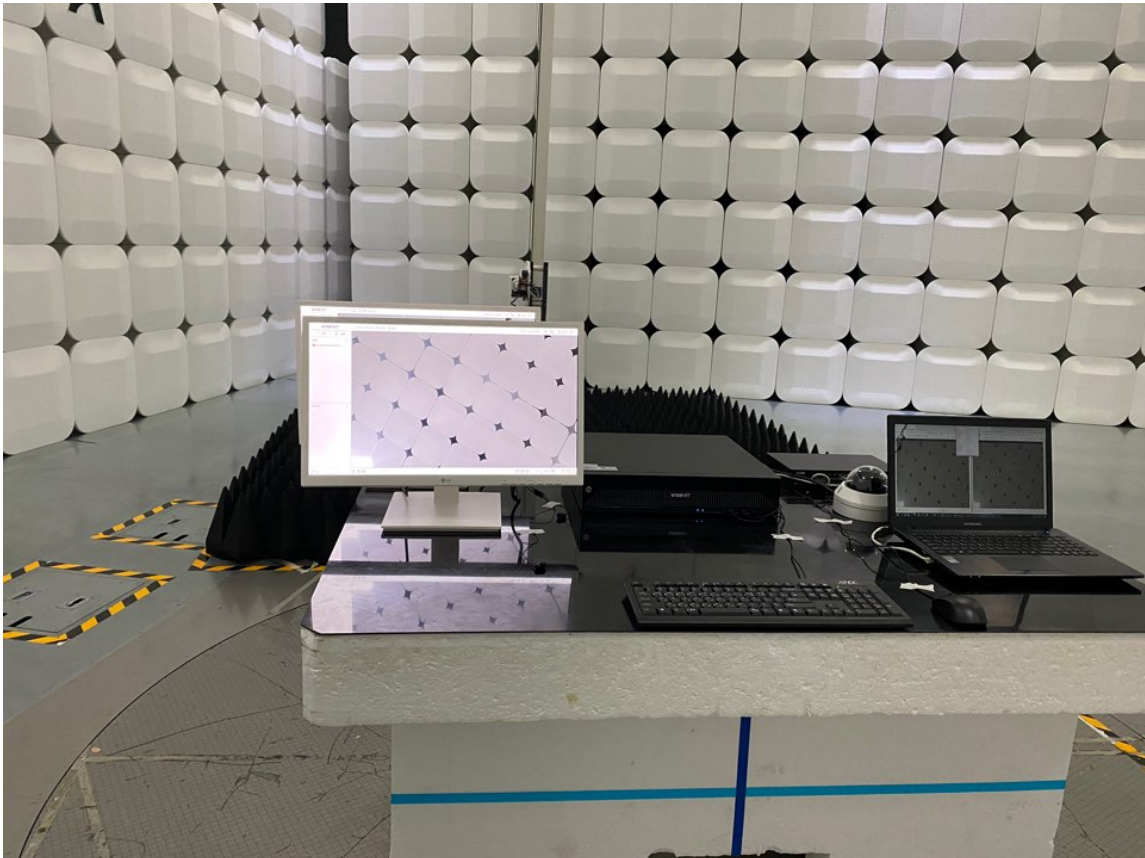

## Photograph of the EUT

EUT



EUT

