

PRODUCT CATALOG



● DIGITAL MATRIX & SOFTWARE



● WIRELESS INTERCOM SYSTEMS



● PARTYLINE SYSTEMS



● INTERCOM HEADSETS



INNOVATION HAPPENS HERE

RTS is the industry leader in professional intercom systems, providing solutions that combine forward-thinking functionality, real-world reliability and superior sound quality.

RTS helps professionals communicate clearly with ease and efficiency, so they can focus on content instead of hardware. Whether for applications large or small, we demonstrate our commitment to our users by Innovating the Future of Global Communications.

Our customer focus and industry expertise is reinforced on a global scale as part of the Bosch Group, which counted 410,000 associates and 440 manufacturing sites, ensuring continuity, innovation and the highest quality standards.



DIGITAL MATRIX & SOFTWARE

Intercom matrices, interface cards, keypanels, software & peripherals
[page 10](#)



PARTYLINE SYSTEMS

Base stations, beltpacks, accessories
[page 38](#)



WIRELESS INTERCOM SYSTEMS

DECT, UHF, and VHF
[page 30](#)



INTERCOM HEADSETS

Headsets, headphones, earsets & accessories
[page 50](#)

THE EVOLUTION OF INNOVATION

At the forefront of broadcast intercom technology for over forty years, we are the brand most-trusted by the biggest names in the business. Our family of digital matrices is the most complete and widely used line of intercoms in the world, proven in the most critical and demanding applications.

1980s

Stan Hubler (L) and Douglas Leighton (R) RTS founders

NAB 1980

magazine

RTS SYSTEMS INCORPORATED

THE PERFECT CONNECTION

SIMPLY REMARKABLE.

THE RESULT OF SEVEN YEARS OF INNOVATION AND EXPERIENCE.

THE ESSENTIAL INGREDIENT

Model 802 Master Station

2000s

Acquired by Bosch in 2006

RTS

RTS

RVON VoIP Technology

Zeus

KP 32 CLD

KP-32/16

2020s

CLOUD-BASED COMMUNICATION

LET'S TALK IP

VLink

1970s

The garage where it all started in 1975

Compact Video Systems

rtS SYSTEMS

BP102

1990s

THE ART OF CONVERSATION

RTS SYSTEMS

RTS SYSTEMS

RTS SYSTEMS

Advanced Digital Audio Matrix (ADAM)

2010s

40 YEARS OF RTS

ONE CABLE. UNLIMITED POSSIBILITIES.

KP-Series

ADAM-M

ROAMEO

OMNEO onboard



RTS DIGITAL PARTYLINE

OMS

DBP

ENTERTAINMENT
& LIVE EVENTS

CRITICAL

APPLICATION BREADTH

RTS systems are scalable for a wide range of applications. From broadcasting to in-house production communications for houses of worship and live entertainment. RTS also has field-proven failsafe communications solutions for mission critical communications like emergency response centers, aerospace control, and power plants.

RTS helps professionals communicate clearly with ease and efficiency, so they can focus on content instead of hardware. Whether for applications large or small, we demonstrate our commitment to our users by innovating the future of global communications.

“People kept commenting on how crystal clear the comm system was and how well it worked.”

- Jim Barton, ME Pro Video

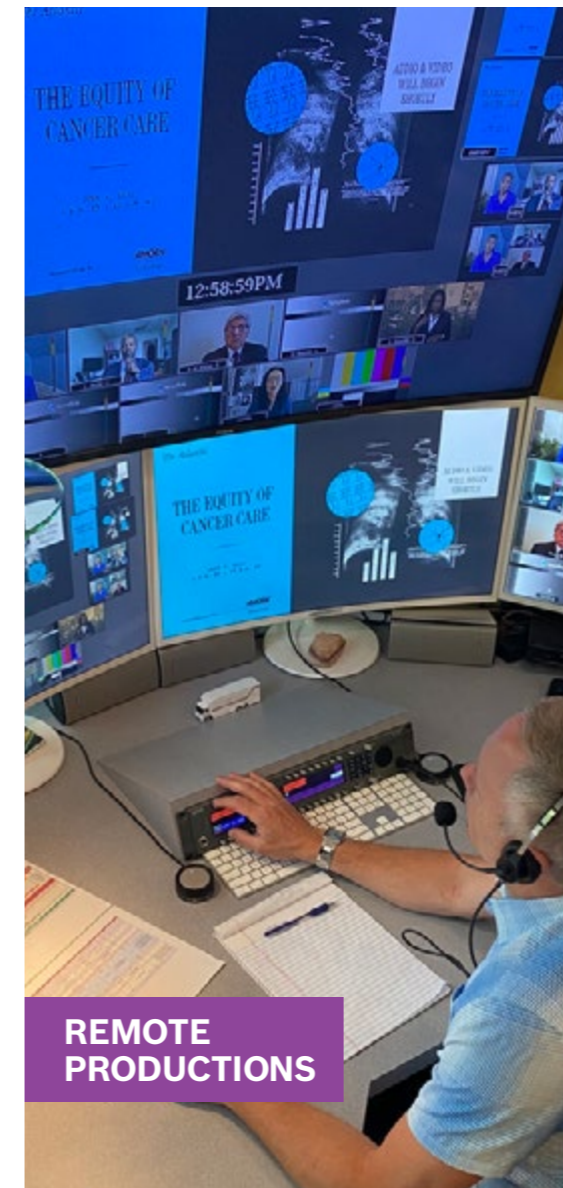
REMOTE
PRODUCTIONS

BROADCAST NETWORKS

RTS is the most-trusted name in intercom for the world's largest TV networks, an essential element of successfully broadcasting the biggest events on the planet, including the Olympics, FIFA World Cup and many other international sports tournaments.

Redundancy and reliability are perhaps the most important factors when it comes to broadcast intercom. Failsafe, glitch-free comms that connect team members in different locations, and often in different countries, systems that remain stable and online in the most challenging environments and working conditions.

As the only brand to offer intelligent trunking and the robust RVON codec, RTS is the go-to for ensuring that behind the scenes people are communicating clearly so the job gets done, from OB vans and remote productions, to local stations and major networks.



STUDIOS



OB TRUCKS

“With the complication that COVID safety brings to Olympics planning and deployment, RTS comes through with products like VLink, RVON and Trunking, giving us the freedom and comfort to work outside of that box.”

- John Pastore, NBC Sports”

IP TECHNOLOGIES

SMPTE-2110 + Internal Local Network Communication + Long Distance Network Communication

Today, our latest generation of advanced digital audio matrix and keypanel products is based upon the uniquely powerful and flexible OMNEO IP technology for media transmission and system control. The OMNEO media networking architecture has full support for Dante+OCA, ST 2110, AES67, AES70, as well as the broadly available Dante™ from Audinate. This easy to use approach provides users with the interoperability to interface with other devices throughout their network.

A top priority for us is the backwards compatibility of our new products, so they can integrate seamlessly with legacy systems to extend the value of the initial investment. RTS offers the widest variety of matrix interfaces in the market: RVON (VoIP), MADi and OMNEO (Dante+OCA, ST 2110, AES67, AES70), connecting via Ethernet, fiber, and copper analog.



SMPTE ST 2110

The OMNEO media networking architecture has full support for ST 2110, AES67, as well as the broadly available Dante™ from Audinate.

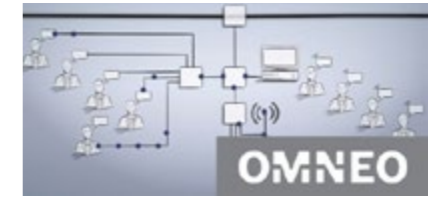

INTERNAL LOCAL NETWORK COMMUNICATION

OMNEO is an evolutionary solution for connecting devices over IP to exchange information including control and audio content for use in applications such as pro audio, public address, intercom, and conferencing.



LONG DISTANCE PUBLIC NETWORK COMMUNICATION

RVON (RTS Voice Over Network) is a way of getting audio across long distances over the Internet, without the need for dedicated infrastructure.



CLOUD-BASED COMMUNICATION

Your private matrix communications cloud and interoperability solution is ideal for interfacing communications systems from disparate locations.

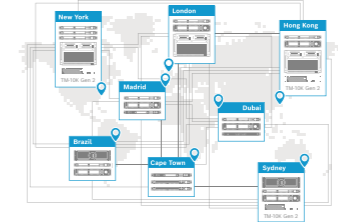

GLOBAL DECENTRALIZED COMMUNICATIONS (TRUNKING)

The TM-10K Gen 2 trunkmaster supports configurations from 2 to 255 intercom systems with 10,000 assignable trunk lines.

“With its OMNEO ability, I can use ODIN on any Dante network without having to add cards or build adapters. RTS has always been reliable.”
- John Steigerwald, Broadcast Management Group

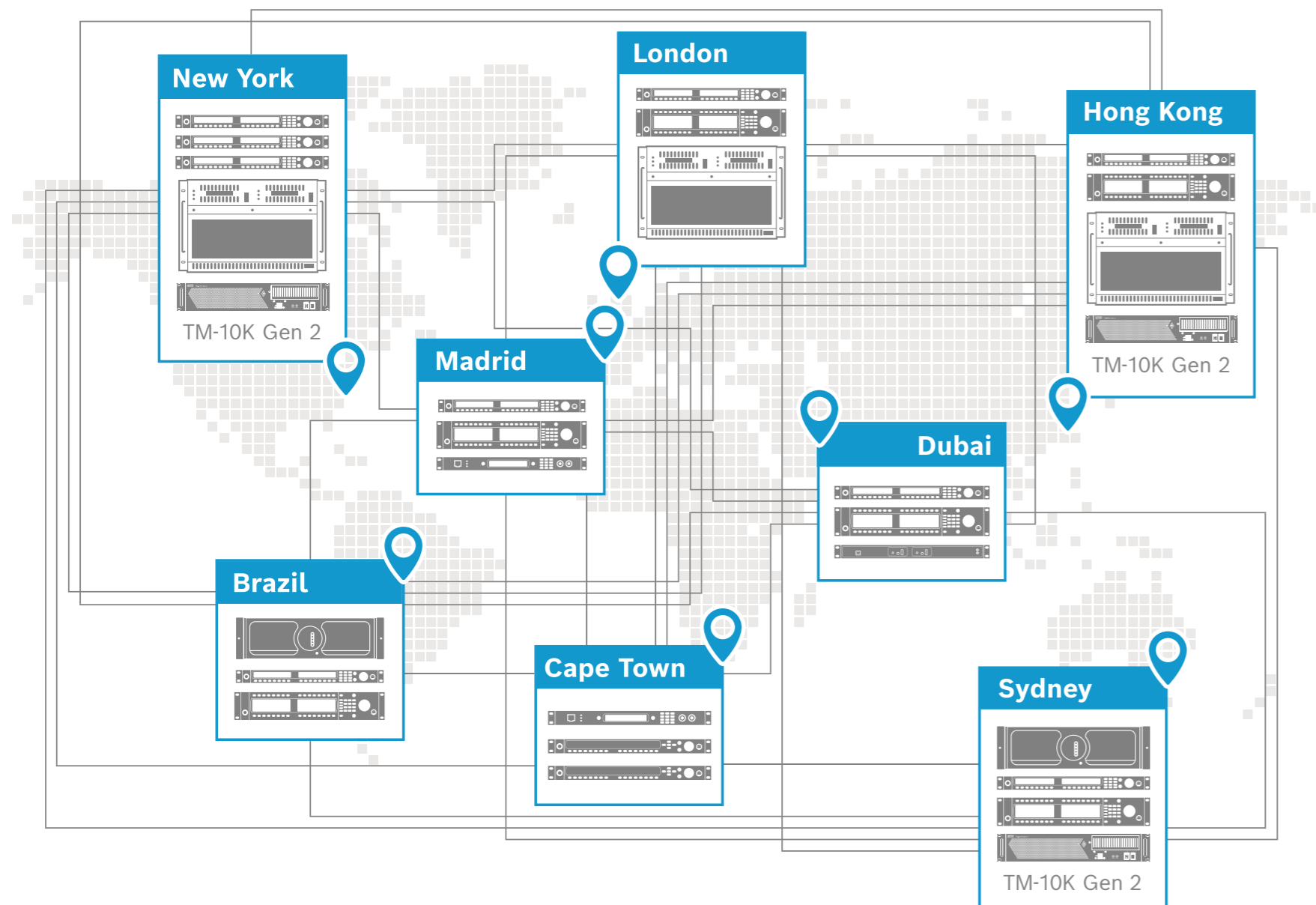

TM-10K GEN2 TRUNKMASTER

- ▶ Supports configurations from 2 to 255 intercom systems with 10,000 assignable trunk lines.
- ▶ Includes dual AC power supplies for full redundancy in mission critical applications.
- ▶ Supports dual 100/1000 Mbps Ethernet connections for redundant or segregated network topologies.
- ▶ Supports geographically separated Trunkmasters for disaster recovery planning.

TM-10K GAIN SW TM-10K GAIN CONTROL MANAGEMENT

- ▶ Users are able to adjust listen volumes for remote Point to Point and Party Line assignments as if they were local assignments.
- ▶ Available as software license package.
- ▶ RTS intercoms allow the user to adjust listen levels for local point-to-point and party line assignments, e.g. to adjust the individual component volumes when listening to a mix of sources. Trunking Gain Control Management extends this, allowing the user to adjust the listen volumes for remote assignments.

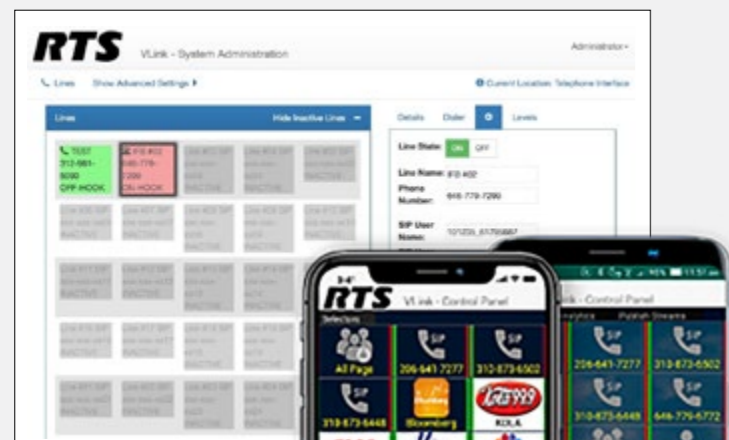
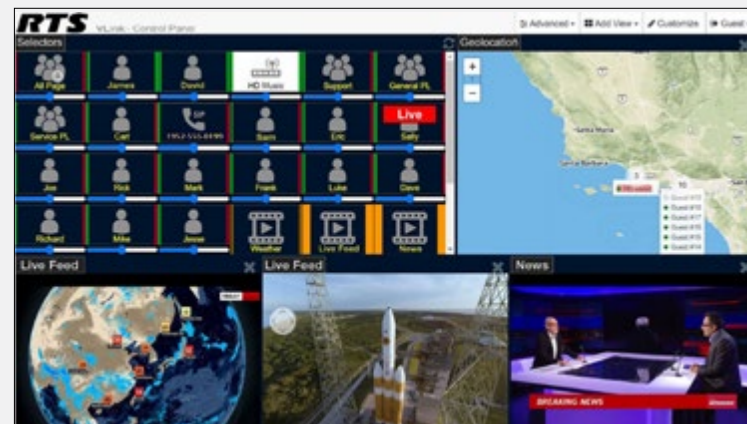

VLINK VIRTUAL INTERCOM

VLink™ is an IP-software multi-channel / multi-access communications solution that intelligently connects to RTS intercoms, creating the optimal fusion of hardware and software capabilities. VLink is highly scalable to thousands of soft keypanel users, supports virtually an unlimited number of point-to-points and PLs, SNMP traps, AES encryption, and recording.

VLink consists of the following core components:

- ▶ **Link Virtual Matrix / Server:** multi-threaded, server-side summing/mixing engine with integrated SIP support
- ▶ **VLink User Interface:** client-side GUI for non-blocking, multi-channel, multi-access critical communications
- ▶ **VLink Device Interface:** software interface to easily bridge disparate communication systems including hardware intercoms, two-way radios, and public/private telephone networks
- ▶ **System Administration Application:** administrative user control for dynamic configuration and monitoring of VLink from any workstation on the network

Additional VLink Options:

- ▶ **VLink Redundancy:** Add redundant ports to your VLink intercom or SIP interface
- ▶ **VLink-Lite:** Simplistic “wireless intercom” system limited to 8 PL’s and 64 users
- ▶ **VLink-Recording:** Audio Recording: Enables audio recording on a per-client basis
- ▶ **VLink-Encryption:** Adds AES 256-bit encryption to system

MOBILE IP INTERCOM FOR iOS & ANDROID

VLink turns the familiar Apple iOS, or Android device into the ultimate wireless intercom system. While traditional systems use the increasingly congested RF (Radio Frequency) and distance limited wireless spectrum, VLink allows communications over standard WiFi, 3G, 4G with no distance limitations between devices and no complicated RF antenna set-up.

VLink allows for a virtually unlimited number of users and channels, and with flexible button programmability can meet the most demanding wireless communications requirements.

WebRTC

The WebRTC Control Panel supports high fidelity 48Khz audio and adds exciting new functionality including the ability to monitor video streams. All accessible using your browser or one of our dedicated WebRTC apps with V6 and newer.

Monitor Video

Video Streaming & Output: enables live video capture and streaming from WebRTC clients as well as output to third party video routers (video must be enabled for all system ports).

Connect to RTS Hardware

VLink enables seamless integration between virtual intercoms, phone systems, and RTS Matrix hardware. The solution is ideal for use in broadcast studios and mobile units to provide IFB, camera operators, and partylines. Configuration, monitoring, and establishing calls is handled through an intuitive web interface complete with VU meters.

Available Anywhere

VLink works over Wifi, cellular, or satellite, and with flexible button programmability can meet the most demanding wireless communications requirements.

VLink Communications system

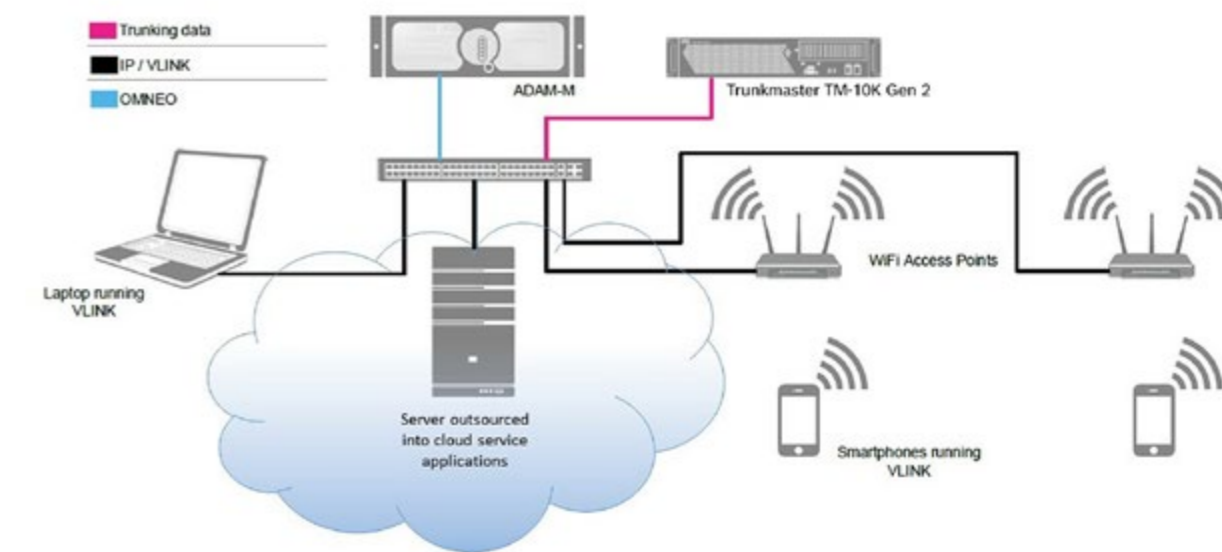

VLINK CLOUD UNLEASH THE POWER OF THE INTERNET

Your private matrix communications cloud and interoperability solution is ideal for interfacing communications systems from disparate locations. The possibilities are limitless.

VLink truly ignites the imagination with all the potential of new age communications, coexisting with traditional matrix intercom frames, supplementing traditional hardware intercom panels, and operating locally or thru Internet-based cloud services.

“What’s great is that the app itself is free. You just buy or rent a license seat for every person who needs to hear the IFB or program feed, for every round trip from the analog to the VoIP side of the audio circuit.

It also works seamlessly with traditional RTS gear.”

- Jim Fay, ATK Versacom

VLink SIP

The VLink Telephone Interface solution enables seamless integration between phone systems with SIP support and RTS ADAM or ODIN intercoms. The solution is ideal for use in broadcast studios and mobile units to provide IFB, camera operators, and conferences. Configuration, monitoring, and establishing calls is handled through a single web page.

Features include:

- ▶ Intuitive GUI that displays all phone lines color coded by status: on-hook (gray), connecting (green flash), off-hook (green), disconnecting (red flash)
- ▶ Individual phone line configuration menus
- ▶ On-screen dialer
- ▶ Audio input and output gain level adjustments in +/- 6db intervals
- ▶ VLink SIP supports analog, MADI, and Dante connections to interconnect audio between phone systems with SIP support and RTS ADAM Keypanels. If Dante is selected, Audinate’s Dante virtual sound card is loaded on the VLink server and a RTS OMNEO Dante matrix card is inserted in the ADAM frame.

Demo VLink at: rtsintercoms.com/vlink

Unleash the power of VLink SIP communication

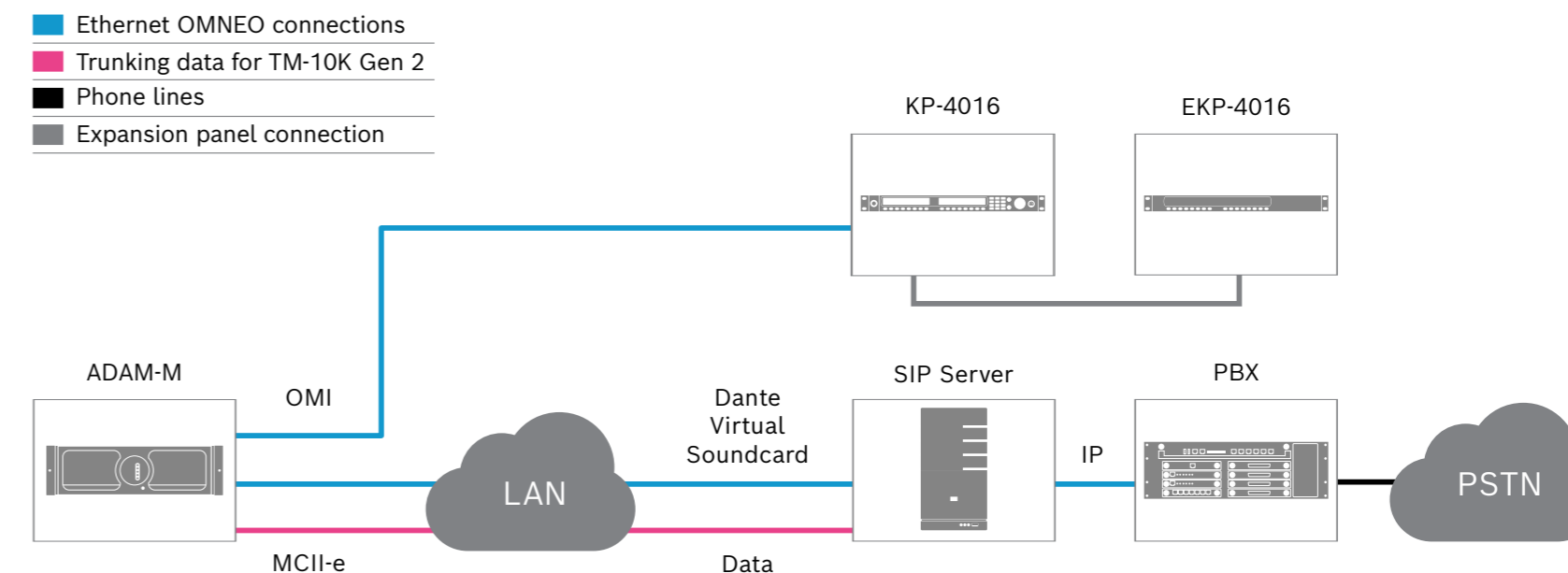

VLink for SIP-Connectivity

VLink Redundancy

Add redundant ports to your VLink intercom or SIP interface



INTERCOM MATRICES

The RTS family of digital intercom matrices is the most extensive, widely used line of intercoms in the world. From the top-of-the-line ADAM matrix, available in sizes from 16 to 880 users. RTS matrices are the standard for reliable, mission-critical communications in aerospace, broadcast, entertainment applications, industrial, and sports.

“Previously, the team used a two-channel party line intercom, which is all they thought they needed. But once they learned how powerful a digital matrix can be – how it could do things that they knew were possible, but hadn’t considered for their operation – they were sold.”

- Kevin Henneman, KMH Integration for the Pittsburgh Steelers



ADAM 2 FULL-SIZE MODULAR MATRIX INTERCOM

The high-end ADAM 2 Matrix supports 8 to 880 users per system; 512 ports possible in one frame. Utilizing a patented TDM (Time Division Multiplex) technique, the ADAM 2 grows linearly as users are added. The system comes standard with redundant universal power supplies (100-240 VAC), and supports redundant controllers, allowing for automatic change-over in the event of failure.



ADAM-M MID-SIZE MODULAR MATRIX INTERCOM

The 3RU matrix frame supports eight interface cards, in addition to redundant master controller cards. In keeping with the RTS principle of backward compatibility, forward thinking, the ADAM-M is fully compatible with all current ADAM cards, including the MADI-2 and OMNEO 16-64 interface. Users now have the option of configuring a very compact frame with RVON, MADI, OMNEO and analog with full redundancy.



ODIN OMNEO IP DIGITAL INTERCOM

The ODIN Digital Intercom is a highly scalable intercom system in a 1RU (Rack Unit) package. As your capacity needs to evolve, a single ODIN can grow from 16 ports to a maximum of 128 ports. A maximum of eight ODIN units can be interconnected via an optical Inter-Frame Link creating a single matrix with up to 1024 ports. Three flexible redundancy options are available for multi-frame ODIN systems: BackupandRestore, FrameSwapandRedundant Frame Operation.

VLINK. Virtual Intercom Matrix.

VLink Virtual Intercom matrix is a multi-threaded, server-side summing/mixing engine with integrated SIP support. Learn more on Page 12.

SCALABLE INTERFACE CARDS FOR ADAM

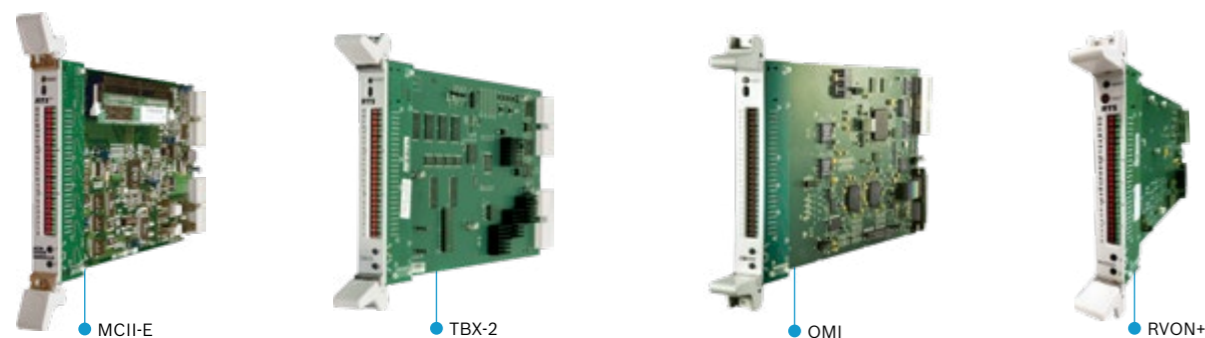

TBX-2 TRIPLE BUS EXPANDER CARD KIT

A single TBX-2 fiber card can link up to four (4) ADAM/ADAM-M frames, while multiple Tribus cards can link up to nine (9) frames. This makes it possible to increase the number of available users on a system by transparently integrating additional frames.

OMI OMNEO MATRIX INTERFACE CARD

This card fits into the standard slots of the RTS ADAM or ADAM-M frames and provides a gateway to the world of OMNEO IP-compatible networking. The card consists of the traditional ADAM front and back card components and enhances ADAM systems.

MCII-E ETHERNET MASTER CONTROLLER CARD KIT FOR ADAM

The RTS MCII-e system controller card is the latest generation controller for the ADAM intercom system. The Ethernet connectivity enables multiple AZedit sessions and remote peripherals such as the GPIO-16.

RVON+ 16- OR 32-PORT VOIP CARD FOR ADAM SERIES

The RVON+ provides VoIP communications for the RTS ADAM Intercom product family. The RVON+ is an integrated solution for connecting keypanels to the intercom matrix or matrix to matrix tie lines over standard IP networks by supporting 16 and 32 channels of bi-directional audio, as well as keypanel data.

AIO-16A 16CH INPUT/OUTPUT CARD

The AIO-16A replaces the AIO-16 card with improved performance characteristics. It co-exists with legacy I/O cards allowing current systems the capability to upgrade to the new AIO-16A. It is fully compatible with the AIO-16 using the same back card and cabling. This means the AIO-16A can replace the AIO-16 card without replacing the back cards, cables or breakout panels.

MADI-2 MULTI-CHANNEL AUDIO DIGITAL INTERFACE CARD

The MADI-2 card expands the ADAM system configuration capabilities by utilizing MADI (Multi-channel Audio Digital Interface) technology to connect any AES-10 compliant device over coaxial or fiber connections at sampling rates of 44.1kHz and 48kHz.

The MADI-2 is fully scalable, allowing 16 to 64 channels of audio in and out. It supports hot-swapping and can be configured through the RTS AZedit configuration software.

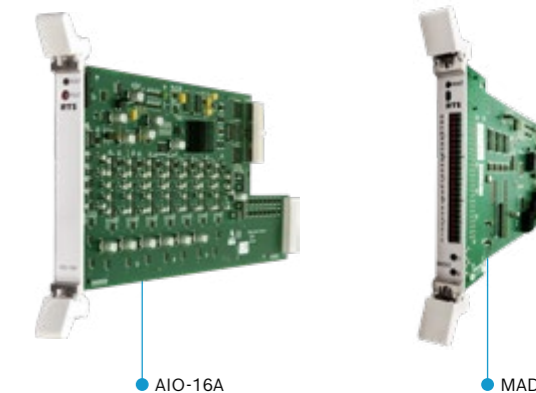

XCP-48-RJ45-E BREAKOUT PANEL

The XCP-48-RJ45-E is the newly created 48-port RJ-45 breakout panel with MDR connector for the AIO-16. It allows you to expand the number of RJ-45 ports on the Intercom system. The XCP-48-RJ45-E supports both 568B and USOC wiring conventions.



Panel	Back card	Connectors
XCP-955	Telco	(25x) RJ-12
XCP-954-48	Telco	(48x) DB-9
XCP-32-DB9	MDR	(48x) DB-9
XCP-16-DB9-T	MDR	(16x) DB-9
XCP-48-RJ45-E	MDR	(48x) RJ-45
XCP-48-Telco	MDR/Telco	(6x) Telco
XCP-40-DB9	SCSI	(40x) DB-9
XCP-40-RJ11	SCSI	(40x) RJ-12
XCP-40-RJ11	SCSI	(3x) Telco
XCP-ADAM-MC	SCSI	(10x) DB-9, (1x) DB25



Scalable



Versatile



User-friendly



Efficient



Flexible



ODIN DIGITAL INTERCOM MATRIX

Condensing decades of experience and our latest IP-based innovations into a compact single rack unit package, ODIN is designed to truly revolutionize intercom connectivity, scalability and performance – making a professional matrix solution more accessible and easier to use than ever before, for a wide range of applications and users of all levels.

“REMI (REMOte Integration) production was already a working concept. Using RTS ODIN as the core of our communications systems played a key role in helping us make that pivot.”

-John Steigerwald, Broadcast Management Group

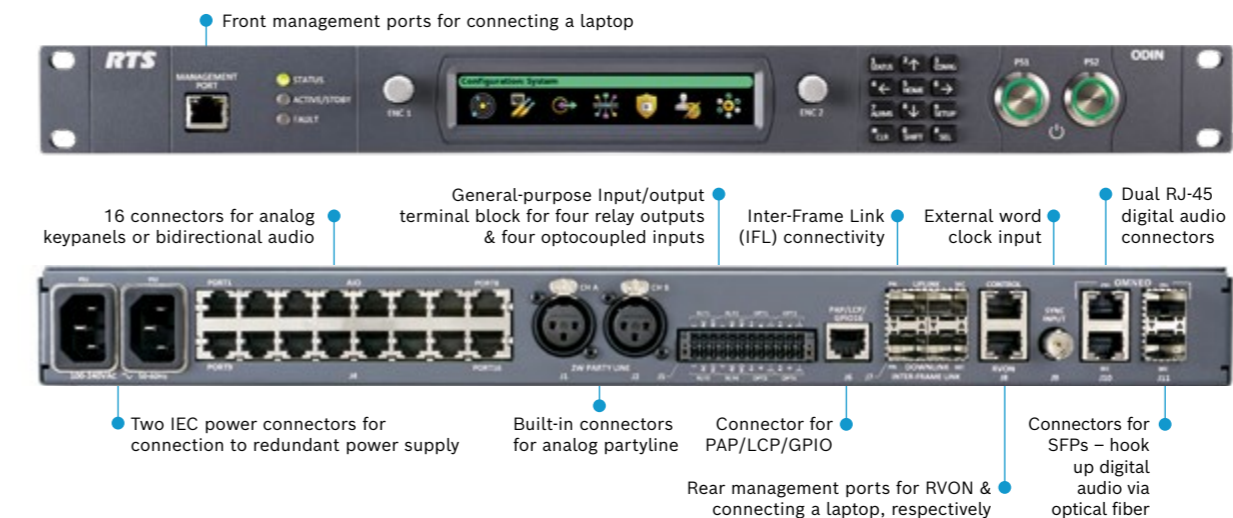

- ▶ Glitch-free available for the most clear and reliable communication
- ▶ Compact 1RU form factor makes ODIN perfect for OB vans and other applications where space is at a premium
- ▶ Built-in Dante-enabled, AES67 / AES70-compatible OMNEO* technology makes the transition to IP easy
- ▶ 16 analog keypanel connectors
- ▶ Single unit scalable from 16 to 128 ports
- ▶ Port expansion via software upgrade – no additional hardware required
- ▶ Up to eight units can be optically interconnected for a total of 1024 ports
- ▶ Color display with intuitive graphical user interface based on icons
- ▶ Redundant power supplies
- ▶ Two XLR connectors for wired partyline in one of three user-selectable formats
- ▶ Less than 50 watts of power, reducing the need for cooling
- ▶ 16 RVON channels per unit
- ▶ Dante-enabled OMNEO is standard on RJ-45 connectors or is available using optional optical fiber SFP connectors. Users can flexibly define ports to use any of the available connector types

FLEXIBLE REDUNDANCY OPTIONS

Three flexible redundancy options are available for multi-frame ODIN systems: Backup and Restore, Frame Swap and Redundant Frame Operation.

The Backup and Restore function in RTS AZedit software can be used to upload and save the complete configuration of an ODIN frame to a file, from where it can be applied to another frame. This option is useful when, for example, two frames in two separate OB trucks need to be linked together for a production; afterwards, each can be easily restored to their previous settings.

Frame Swap is used to replace a single frame in a multi-frame ODIN intercom system. It is similar to Backup and Restore, but it is performed via the front control panel and does not involve AZedit.

Redundant Frame Operation supports two modes: One-to-One Redundancy and Intelligent Redundancy. In either mode the system can be configured for automatic transfer of control or manual transfer.

SOFTWARE

RTS software provides complete control over your intercom system from any standard Windows computer. Configure keypanel settings, assign user rights and even link matrices together that are thousands of miles away.

“It’s all software based, so all I have to do is tell the system what I want to redefine it. And it’s still all done with AZedit software, so there’s almost no learning curve for our people. It’s amazing.”

- John Steigerwald,
Broadcast Management Group

MATRIX AZEDIT

Intercom system configuration has never been easier with the advent of AZedit matrix control software. AZedit is a Windows-based, full-featured configuration software, providing online and offline configuration capabilities. It gives you the ability to manage multiple intercom systems, assign and reassign users to different ports, as well as dynamically add intercom hardware to your system setup without jumper changes, rewiring or taking the system offline. AZedit has the capability to load pre-set configuration files, which means saved configurations can be uploaded to the live application at anytime without interruption. AZedit can be used as a monitor tool to observe the status of features, such as gain and crosspoint settings, keypanel keys activated and other aspects of the system. AZedit can run in multiple sessions using the MCII-E ADAM master controller to allow for remote system configuration. AZedit is updated regularly to provide users with the latest features and innovations available.

IPEDIT

IPedit is a Windows-based GUI application for configuring and displaying RVON and OMNEO devices connected to your matrix system. IPedit is to IP products as AZedit is to ADAM, ADAM-M and ODIN. An enhanced version of IPedit is available, which can configure multiple network devices simultaneously.

KEYPANEL CONTROL & AUDIO SOFTWARE



Configuration upload/download: remotely configure any keypanel and edit/save keypanel configurations in AZedit software



Supervisor mode (keypanel mirroring): remotely configure any keypanel, adjust volumes and other parameters in real-time on target panel from a supervisor panel



Real-time volume control via AZedit software: ensures that users can always hear verbal instructions, even if their volume is turned to zero



Downloadable screensaver: download a screen saver that is specific to you or your organization



Downloadable chimes: download a set of chimes that is specific to you or your organization

AUDIO SOFTWARE PACKAGE



Five-band equalizer: adjust volume level within five pre-defined frequency bands; users can fine-tune audio to their individual preferences



Noise gate: adjust as required to reduce fatigue-causing line noise



OMNEO AUX Input: The Audio Software Package also provides six OMNEO AUX inputs in addition to the two standard inputs, giving you more configuration options for your matrix environment.



Voice mail: leave messages for other users



Additional compression ratios: offer more flexibility. In noisy environments, audio quality can be improved by the amount of compression. This option adds additional compression ratios of 4, 5, and 6 to the standard 1:1, 2:1, and 3:1.

RVON G.722 CODEC SOFTWARE



RVON Codec: The field-proven RVON (RTS Voice Over Network) technology for VoIP enables communication between users across long distances, using G.711, G.729 or high quality audio G.722 codec, users can select based on their application.

KP-Series users may now connect to matrices equipped with a suitable RVON interface, such as the RVON+ for ADAM/ADAM-M, or an ODIN via G.722 high quality audio codec (requires optional G.722 software license for KP-Series) in addition to the standard G.711 and G.729 codecs.

ODIN and/or ADAM/ADAM-M equipped with RVON+ have all three codecs on board right away, allowing for high quality audio long distance tie-lines between matrices, which is often used for trunking applications.

**The G.722 Audio and Control Software Packages are optional and can be installed on all KP-5032, KP-4016 and DKP-4016 keypanel models.

VLINK. VLink is an IP-software multi-channel / multi-access communications solution that intelligently connects to RTS intercoms, creating the optimal fusion of hardware and software capabilities. [Learn more on Page 12.](#)



RTS KEYPANELS

RTS keypanels represent the ultimate in compact, fully-programmable user stations. KP-Series keypanels deliver superior digital audio using the Bosch-developed OMNEO which includes Audinate's Dante audio over IP technology, via either copper or fiber. The KP-Series provides high-quality audio, free of noise, delay and other artifacts present in older technologies. The family includes a rich set of connectors as standard, including GPIO and RC. As with other RTS products, emphasis has been placed on backward compatibility with previous generations of matrices including analog technology.

KP-Series keypanels utilize the latest generation of wide angle TFT displays, providing superior clarity, resolution and longer display life, along with high-quality readability under a variety of lighting conditions.

The RTS OMNEO suite now fully supports Open Control Architecture (OCA) also known as AES70.



Dante™

OMNEO
onboard

OCA
OPEN CONTROL ARCHITECTURE

KP-SERIES

- ▶ OMNEO Open Media Networking Standard – the new KP-Series is future-proof and so is your communication. The unparalleled flexibility features automatic hardware recognition plus the technology of OMNEO, so you get full backward compatibility and easy scalability.
- ▶ Out with the old, and in with the more intuitive. The new design and an enhanced user interface enable easier understanding and improved operation. The software provides simple and intuitive navigation of menus, with the most commonly used features easily accessible.
- ▶ Advanced Signal Processing and AD/DA – get high-quality audio transmission every time. The new keypanel family features two echo cancellation modes, plus quick AD/ DA conversion – ensuring ultra-low latency and reducing noise, echo, delay and other artifacts present found in older technologies.
- ▶ Full IP Connectivity and TCP-IP Layer 2 & 3 Compatibility.
- ▶ User-Friendly, High-Res Color Display – get high quality, inside and out. The new KP-Series keypanels feature a unified design, with better color, contrast, resolution and viewing angle for an improved visual experience. Plus, multiple controls through ergonomically-designed levers. Pushbutton versions are also available.
- ▶ Backward compatibility – all KP-Series keypanels are compatible with older technologies such as analog audio in USOC and 568-B connector formats.
- ▶ Standardized connectors – all previous hardware connector options (RC, GPIO, and ancillary items) are now standard on the 4000 and 5000 series of KP-Series products.
- ▶ Enhanced navigation menus – optimized for ease of use.
- ▶ High-performance Audio and Control Software Packages for KP-5032 and KP-4016 keypanel models including the DKP-4016 desktop keypanel. The software packages new features like keypanel mirroring, voicemail, customization, and more.
- ▶ RTS offers two firmware updates that allow your keypanels to speak either OMNEO or RVON, the tried-and-tested RTS Voice over Network codec for VoIP (Voice over IP).
- ▶ Reduced power consumption – the power utilization of the KP-Series keypanels is reduced to almost fifty percent compared to older keypanels and are the most environmentally friendly keypanels RTS has to offer.

KP-SERIES KEYPANELS



DKP-4016
16-POSITION HD COLOR DISPLAY
DESKTOP/WALL-MOUNT KEYPANEL



KP-3016
ONE RACK UNIT KEYPANEL,
16 OPERATION KEYS WITH ANALOG
AND IP (OMNEO/DANTE OR RVON)
MATRIX INTERFACE



KP-3016A
ONE RACK UNIT KEYPANEL,
16 OPERATION KEYS WITH ANALOG
MATRIX INTERFACE ONLY. DOES
NOT SUPPORT RVON OR OMNEO.



EKP-3016
ONE RACK UNIT EXPANSION
KEYPANEL, 16 OPERATION KEYS
FOR KP-3016 AND KP-3016A



DKP-3016
16-POSITION HD COLOR DISPLAY
DESKTOP/WALL-MOUNT KEYPANEL

Also available as a wall mount version, the DKP-3016W.



KP-5032*
32-POSITION HD COLOR
DISPLAY KEYPANEL



KP-4016*
16-POSITION HD COLOR
DISPLAY KEYPANEL



EKP-4016*
16-POSITION HD COLOR
DISPLAY EXPANSION PANEL

Connect up to 6 (KP-5032) or up to 7 (KP-4016) expansion panels for a maximum of 128 talk and 128 listen keys.

*Available in lever key or pushbutton

KEYPANEL COMPARISON

Family	KP-3016A	KP-3016	DKP-3016	DKP-4016	KP-4016	KP-5032	KP-4016 PB	KP-5032 PB
Form factor	1RU		DKP/WM		1RU	2RU	1RU	2RU
Input device	Lever						Pushbutton	
Talk	Lever	Lever	Lever	Lever	Lever	Lever	Pushbutton	
Listen	Lever	Lever	Lever	Lever	Lever	Lever	LSTN + Pushbutton	
Keys (KP / DP)	14		16		14	32	14	32
Keys (Exp)	16		Not applicable		16			
Cross Point Vol.	Knob		Lever		Lever	Lever	Pushbutton + Aux knob	
Anti-glare lens	No		Yes		Yes			
Dialing pad	No		Yes					
TCP/IP Layer 3 Dante compatible	No	Yes, OMNEO						
Redundant IP conn.	No		Yes, RSTP					
Front self-sensing hdst inp.	Yes							
Power (W), nominal	8	11	25		12	13	12	13
Aux inputs	No		1		2			
Ext mic input	No		Yes					
Hdst connector	1	2		2				
Line out / mic out GPIO-connector	No		Yes					
Power supply	External		Internal		External			
Output for ext. speaker	No		Yes				Yes	
OMNEO (RJ-45)	No	1		2				
OMNEO (for SFP)	No		1					
Backward compatible					Yes			
Firmware can be upgraded					Yes			
Accepts RVON codec firmware	No	Yes						
Enhanced feature licensing	No		Yes					

DIGITAL BELTPACK KEYPANEL MODE.

Digital Beltpack (DBP) also has a Keypanel Mode within the RTS ecosystem. Learn more on Page 38.

UPGRADES

- High-performance Audio and Control Software Packages for KP-5032 and KP-4016 keypanel models including the DKP-4016 desktop keypanel. The software packages add features like keypanel mirroring, voicemail, customization, RVON G.722 via firmware license, and more.
- RTS offers two firmware updates that allow your keypanels to speak either OMNEO or RVON, the tried-and-tested RTS Voice Over Network codec for VoIP (Voice over IP).

ACCESSORIES

MCP-90-X ELECTRET GOOSENECK MICS

The MCP-90-x gooseneck mics are the standard gooseneck intercom mic for all RTS keypanels. Available in various length from 0" to 18". All versions use a electret mic element.

- MCP-90-0 (0")
- MCP-90-8 (8")
- MCP-90-12 (12")
- MCP-90-18 (18")

WKP-1* WALL-MOUNT KEYPANEL

WKP-1 offers simplified operation and integrates seamlessly with RTS digital intercom systems. The physical size and weather-resistant design provides a flexible and robust intercom system. WKP-1 fits a standard US dual gang electrical box.



*NOT AVAILABLE IN ALL REGIONS. Contact RTS for more information.

DIGITAL MATRIX PERIPHERALS

RTS offers a full line of peripheral products to complete your communications system, including interfaces to party-line intercoms, telephone lines, and relays. Accessories also include control panels for IFB levels and assignments, panels for adjusting system audio levels, and microphones.



TIF-PRO2



OEI-2



PAP5032

Peripherals

TIF-PRO2 VOIP TELEPHONE INTERFACE

A replacement for the successful SIP-ISDN, the TIF-PRO2 provides increased IP/digital/analog connection density in a compact half-rack-unit form factor. The device offers seamless interoperability with the latest RTS IP/digital keypanels and matrices, along with legacy IP/digital/analog RTS intercom hardware. It comes equipped with two SIP IP lines, each with a 64 kbps data rate (with overhead 100 kbps).

OEI-2 OMNEO IP EXTERNAL INTERFACE

The OEI-2 enables connectivity between analog audio sources and legacy RTS keypanels and an OMNEO network. This allows users to maintain existing infrastructure and the equity of their original equipment investment while updating to high-performance OMNEO media networking architecture. Utilizing standard IP Ethernet infrastructure, OMNEO-equipped products can be assembled into networks of 2 to 10,000 cooperating devices that share common control systems. OMNEO sets new industry standards for audio communications by offering unparalleled scalability and future-proof expandability; studio-quality synchronized multichannel audio; the most robust, reliable, and secure control protocol suite available; ultra-low latency; and the support of DHCP protocols. The compact, mountable OEI-2 is designed for quick installation and easy operation, and supports all RTS analog keypanels.

PAP-5032 OMNEO-CAPABLE PROGRAM ASSIGN PANEL

The PAP-5032 provides the user with the ability to assign multiple program sources to over 16 different IFB destinations. The PAP-5032 can be extended to up to 64 program sources and 64 IFB destinations via standard EKP expansion panels. The PAP-5032 works with ADAM, ADAM-M, and ODIN matrix systems.

Software options:

- ▶ TIF-PRO2 2-channels PSTN upgrade. ISDN is also enabled with this upgrade (subject to change).
- ▶ 2 x RX and 2 x TX AES67 channels (DANTE/RAVENNA compatible via SAP)
- ▶ Software for configuration & operation for additional workplaces (one license is already included in the system delivery).

Audio routing panels, assignment panels, mixing panels, and more...

Model name	Description
ARNI E & ARNI S	Audio routed network interface
DSI2008	Digital system-to-system adapter
FMI-4	Multiplexer with 4 RTS four-wire intercom ports
FMI-8	Multiplexer with 8 RTS four-wire intercom ports
GPIO-16	General purpose input/output interface
OKI-2	OMNEO keypanel interface card-2
RVON-I/O	VoIP interface for post-2004 KP-32 classic keypanels
TIF2000A	Single-line digital telephone interface
TIF4000	Multi-line telephone interface



WIRELESS KEYPANEL

The ROAMEO wireless intercom system from RTS is a professional, easy-to-use and future-proof solution based on the license-free DECT (Digital Enhanced Cordless Telecommunications) standard. ROAMEO provides high-quality audio and a large number of simultaneous users across wide areas over a seamlessly integrated digital wireless beltpack and associated access points. ROAMEO can solve a series of communication challenges by operating like a wireless keypad in the field which is easy to use and easy to expand. Additionally, wireless beltpacks can be directly addressed as part of a wired RTS matrix intercom system.

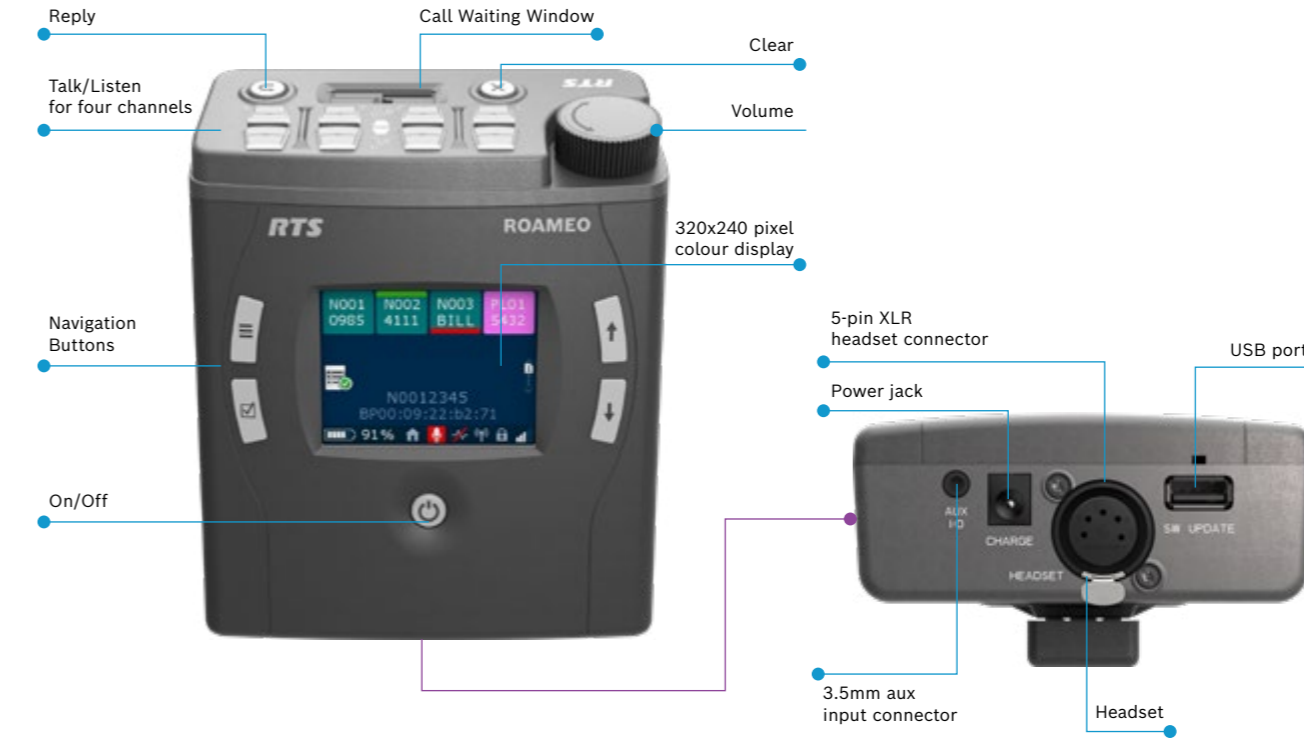

ROAMEO TR-1800 & AP-1800

ROAMEO provides a superior user experience – the system can be easily configured in a multi-language set-up via scroll lists on the TR-1800 beltpacks or using the control software AZedit, which allows users to configure the complete intercom system on one screen.

Thanks to its large color LED-display and intuitive icon-based menu structure, the TR-1800 beltpack is very easy to set up and operate. With its lightweight, durable housing, the beltpack features the smallest enclosure in its class and is protected against dust and light rain.

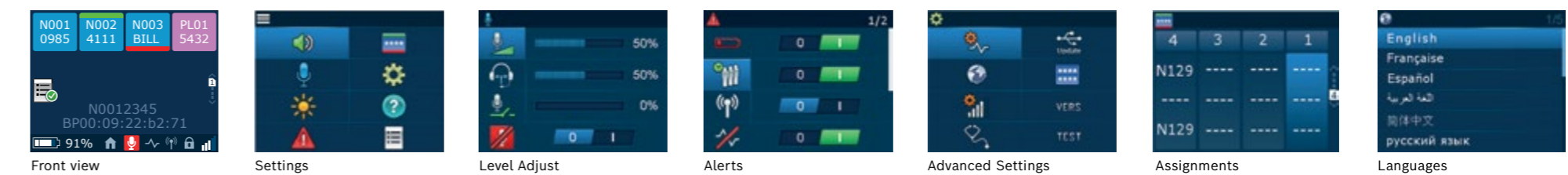



AP-1800 5/10CH DEVICE

Connection to a digital matrix is easily established via a single Ethernet cable; the access points can be daisy-chained. The AP-1800 access point is protected by a durable aluminum enclosure and designed for a minimum of spatial requirements on

vertical or horizontal wall surfaces. The AP-1800 access points convert the DECT signals into Dante-compatible OMNEO IP-technology, thereby providing the highest interoperability, flexibility, reliability and resilience.

Model name	Description
AP-1800	Access point 1.92 – 1.93 GHz
AP-1800 EU	Access point 1.88 – 1.90 GHz
TR-1800	Beltpack 1.92 – 1.93 GHz
TR-1800 EU	Beltpack 1.88 – 1.90 GHz
TR-1800 Holster	Holster for TR-1800 & TR-1800 EU
24-PSE	Spare power supply for TR-1800 & TR-1800 EU
ANT1800	Spare antenna (qty 1) for AP-1800 & AP-1800 EU
AP1800 MT BRKT	Pole mount kit for AP-1800 & AP-1800 EU
BP-240	Spare Lithium battery for TR-1800 & TR-1800 EU

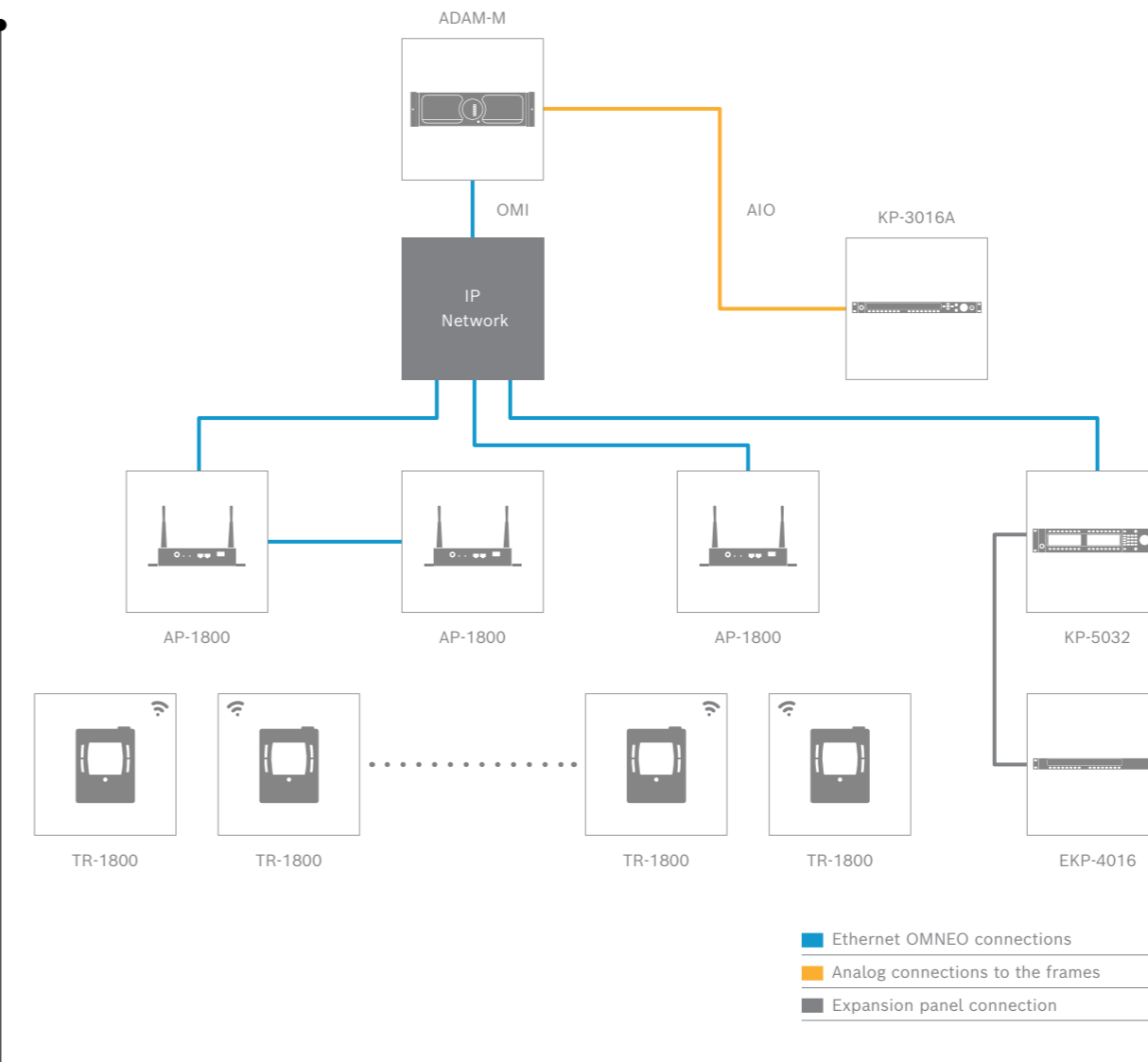

EXPANDING THE SYSTEM

ROAMEO's cellular structure can cover a wide area with superior audio and seamless roaming between the individual cells. Each cell requires an AP-1800 access point and covers a specified area and number of beltpacks, depending on the audio codec used. Each AP-1800 has a built-in IP switch that adds multiple streams together in the same cable and will configure itself automatically. Users can easily expand the coverage area by adding additional access points, while additional wireless beltpacks can be directly addressed as part of a wired RTS matrix intercom system.

Users can easily expand the coverage area by adding additional access points, while additional wireless beltpacks can be directly addressed as part of a wired RTS matrix intercom system. Depending on the audio codec used, users can select between a higher emphasis on voice quality (G.722 full bandwidth) or a more efficient use of the radio spectrum with a higher number of beltpacks (G.726 narrow-band).

The ROAMEO system is an environmentally friendly system without any dangerous emissions at low radiation. It is compliant with the US environmental regulation N33.6.



UHF WIRELESS INTERCOMS*

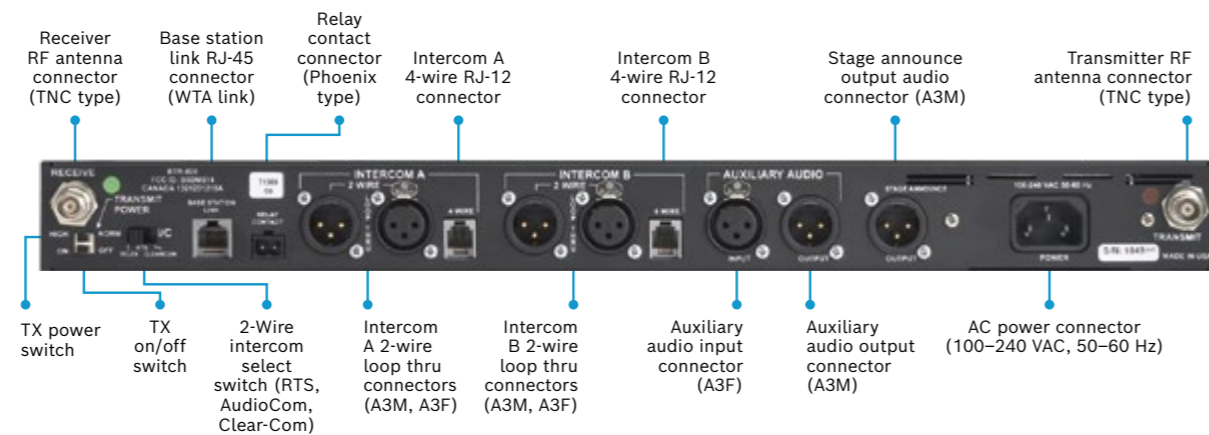

Rear view of BTR-800



BTR-800* UHF SYNTHESIZED WIRELESS INTERCOM 2CH BASE STATION

The RadioCom BTR-800 UHF-synthesized wireless intercom systems offer the ultimate in reliable, high-performance, high fidelity full-duplex communications. The BTR-800 system includes the BTR-800 frequency-agile base station, working with up to four TR-800 or TR-825 frequency-agile beltpacks. The BTR-800 base station provides full-duplex communications with the beltpacks.

***NOT AVAILABLE IN ALL REGIONS.**

BTR-800/TR-800/TR-825: 470-608 MHz, 614-722 MHz in 18 MHz TX and RX bands. Licensing of this equipment is the user's responsibility and ability to license depends on the user's classification, user's application and frequency selected. Contact RTS for more information.



TR-800* UHF WIRELESS INTERCOM 2CH BELTPACK

Individual volume controls also allow for easy level adjustment. The TR-800 has an all metal cast magnesium case, an LCD based graphical user interface, stage announce activation, wireless talk around (ISO) activation, enhanced ClearScan, detachable antennas and an auto-sensing headset connector that automatically switches between electret and dynamic headset mics.



TR-825* UHF WIRELESS BINAURAL INTERCOM 2CH BELTPACK

The RTS TR-825 is a Two-channel UHF frequency-agile wireless beltpack for use with the BTR-800. The TR-825 is a dual listen and dual talk beltpack, allowing you to listen to "Tech" in one ear and "Production" in the other. Individual volume controls also allow for easy level adjustment. The TR-800 has an all metal cast magnesium case, an LCD based graphical user interface, stage announce activation, wireless talk around (ISO) activation, enhanced ClearScan, detachable antennas and an auto-sensing headset connector that automatically switches between electret and dynamic headset mics.



BTR-30N*
VHF/UHF NARROW
BAND SYNTHESIZED
WIRELESS 2CH
INTERCOM SYSTEM

The RTS BTR-30N Narrow Band 2-Channel VHF/UHF Synthesized Wireless Intercom System is a revolutionary product offered in today's ever-changing and shrinking RF environment. Providing a 25kHz of modulated bandwidth, the BTR-30N narrow band system allows more users per channel in the relatively unused VHF spectrum and a reduced footprint in the cramped UHF band.

***NOT AVAILABLE IN ALL REGIONS.**

BTR-30N/TR-30N/TR-32N: Base TX 482-572 MHz in 18 MHz bands, Base RX 174-216 MHz in two 24 MHz bands. **BTR-80N/TR-80N/TR-82N:** 482-722 MHz (TV 16 to TV 36 and TV 38 to TV 52). Licensing of this equipment is the user's responsibility and ability to license depends on the user's classification, user's application and frequency selected. Contact RTS for more information.



BTR-80N*
UHF NARROW BAND
SYNTHESIZED
WIRELESS INTERCOM
2CH BASE STATION

The RTS BTR-80N Narrow Band 2-Channel UHF Synthesized Wireless Intercom System is a revolutionary product offered in today's ever-changing and shrinking RF environment. Providing an unprecedented 25 kHz of modulated band width, the BTR-80N narrow band system will allow more users per channel in the cramped UHF spectrum. The BTR-80N provides excellent audio performance and provides all of the standard features of the award winning RTS BTR-800 system, such as DSP digital processing and Intelligent Power Control.

Model name*	Description
TR-30N	Narrow band VHF/UHF 2CH belt-pack
TR-32N	Narrow band VHF/UHF 2CH stereo belt-pack
TR-80N	UHF narrow band synthesized wireless intercom 2CH portable belt-pack
TR-82N	UHF narrow band binaural synthesized wireless intercom portable 2CH belt-pack
AB-2	Universal bracket for ¼ wave antenna with 10' coax cable
ACS-101	Broadband antenna combiner-splitter
ALP 600M	ALP-600 telescoping antenna mast
ALP-450	UHF directional antenna
ALP-600	UHF bi-directional antenna
ALP-600B	ALP-600 antenna bracket kit
ALP-700	Bi-directional log periodic antenna. Covers 470-760 MHz.
APS1 COMB_SPLT	Broadband antenna combiner-splitter
BC800NM4	Four-bay charger with NiMH battery packs
BP800NM	NiMH battery pack

**WIRELESS
IFB***

The TT-16 is designed to provide a convenient wireless link to on-air talent in the studio or in the field at remote locations. Operating in the low band VHF 64-68 MHz range (TV CH3 and 4), the units operate reliably at distances of over 750 feet. In unoccupied television channels, up to five TT-16 transmitters will operate simultaneously within the same location.

***NOT AVAILABLE IN ALL REGIONS.**

Contact RTS for more information.



TR-16*
16CH BROADCAST WIRELESS
IFB TRANSMITTER

The TR-16 is designed with a 3.5mm earphone connector, to be used with standard IFB earpieces such as the RTS Telethin announcers earpiece systems or any other 8-500 earphone. The TR-16 receiver features a selectable high frequency boost control to equalize the high frequency loss associated with the use of behind the collar acoustic tubes and earphone drivers.



TT-16*
16CH BROADCAST WIRELESS
IFB TRANSMITTER

A backlit LCD display allows the user to select the RF channel used, change Hi-Low RF transmit power, select intercom input source and adjust the input levels. A new feature, Enhanced Dynamic Range (EDR), greatly improves the signal to noise ratio, and works with the TR-16 talent receiver to provide clearer, more dynamic audio.



RTS DIGITAL PARTYLINE

DBP is a four-channel/four-button wired beltpack that runs on PoE (Power over Ethernet 802.3af and 802.3at) and connects using OMNEO IP technology (Dante, AES70 and more).

OMS is a communications multi-tool for a wide range of customers, including theaters, houses of worship, broadcast, AV rental, industrial facilities and entertainment/event venues.

HYBRID FUNCTIONALITY



Operate DBP in partyline mode with OMS (OMNEO Main Station) or in portable keypad mode with an RTS matrix (ODIN/ADAM) – one device covers it all.

DAISY CHAINING



Connect DBP to a PoE switch via OMS/ODIN/ADAM and up to six DBPs can be daisy chained together.

USER FRIENDLY



Lightweight and ergonomic design with full-color icon-based menu navigation for quick setup and intuitive operation.

A BRIDGE FROM ANALOG TO DIGITAL AND IP



Analog partyline users can enter the world of IP communications while extending the working life of their legacy equipment.

SCALABLE

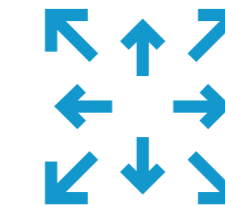

Available in five configurations to grow with the user's needs – upgrade via software license updates.

VERSATILE



Converts between up to four different formats: OMNEO (Dante, AES70 and more), RVON, four-wire AIO and two-wire.

CLEAR. COMPACT. COMPATIBLE.

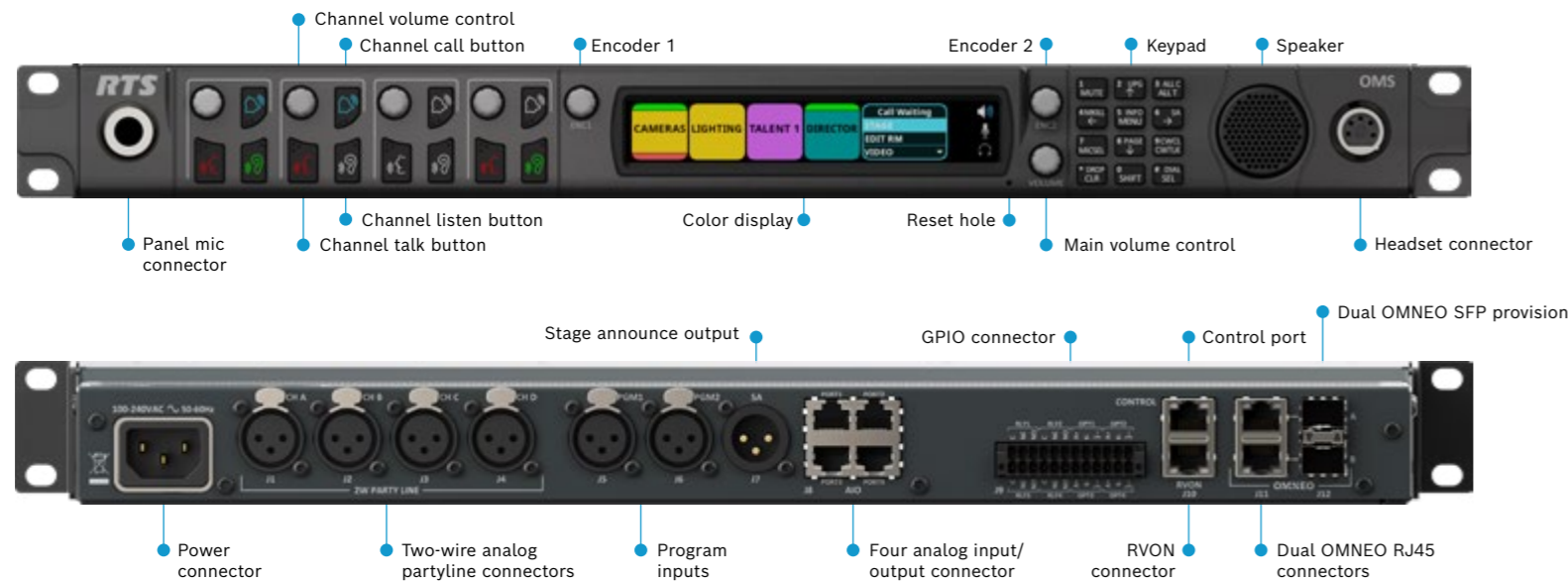

OMS OMNEO MAIN STATION

OMS is a communications multi-tool for a wide range of customers, including theaters, houses of worship, broadcast, AV rental, industrial facilities and entertainment/event venues. It is available in five licensed configurations to suit the user's budget and application requirements: Advanced, Intermediate and Basic digital (each with OMNEO); Analog Plus and Analog (main station options for analog-only partyline systems).

Presented in a compact 1RU enclosure, OMS is a uniquely versatile and cost-effective solution capable of interconnecting both wired/wireless and IP/digital/analog devices. Full TCP/IP connectivity is supported. Whereas current systems on the market offer analog-only, digital-only, proprietary or non-Dante-compatible products, OMS encapsulates the RTS philosophy of bridging all standards and formats.



DBP DIGITAL BELTPACK

The DBP provides TALK and LISTEN capability for up to four configurable audio conferences. It runs on PoE (Power over Ethernet 802.3af and 802.3at) and connects using OMNEO IP technology (Dante, AES70 and more). Its unique hybrid design supports both digital partyline and matrix keypanel modes: for use as a digital partyline device, DBP connects to an OMS; for

use as a portable keypanel, including functionality like point-to-point communication, DBP can be connected to any RTS digital/IP matrix product using OMNEO – including OMI cards in ADAM/ADAM-M frames or OMNEO ports on ODIN frames. DBP automatically selects the correct mode of operation (digital partyline/OMS or keypanel/matrix) when connected and switched on.

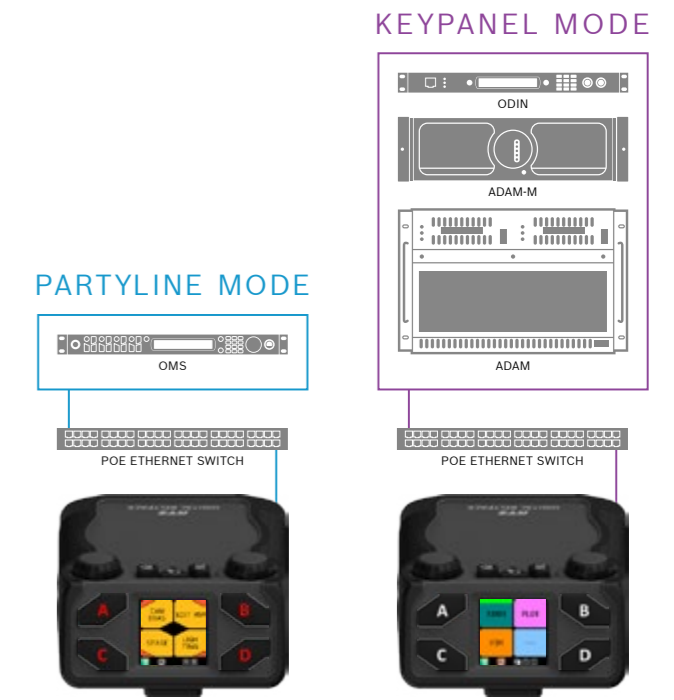

RTS TWO-WIRE

RTS TW's innovative intercom systems have been the industry standard "can't fail" communications system for over 30 years. Our 2-channel on standard microphone cable technology offers users a distinct competitive advantage. With countless installations in studio broadcast, remote production, board rooms, theaters, arenas, stadiums, training facilities and many venues, we have the time proven technology that professionals rely on to stay connected.

POWER SUPPLIES

The power supplies are the heart of the partyline system, providing operating voltage to belt packs and user stations. RTS' unique, short-circuit reset feature and unparalleled mechanical engineering ensure reliable, trouble-free operation.

INTERFACES

Two-wire/four-wire interfaces connect two-wire intercom lines to four-wire systems.

USER STATIONS

Rugged and dependable RTS two-wire intercom user stations form the widest variety of stationary communications stations in the industry. RTS two-wire intercom user stations are the perfect choice for a wide range of applications regardless of what physical profile is required.



PS-20 POWER SUPPLY

The RTS PS-20 is the RTS Two-Wire Intercom power supply. The PS-20 features two- and four-channel operation, RTS monitoring, two-channel program input, audio linking, and three-mode operation: RTS 2-channel, RTS 4-channel and Clear-Com mode.

It also has high power output, which will increase the number of user stations and belt packs which can be connected substantially.



Analog system-to-system adapter



2CH user station

SYSTEM COMPONENTS

Model name*	Description
PS-20	Power supply
4025A	1x4 25 pair, 50-pin passive splitter
BOP-1000	19" blank mounting frame
BOP220	Breakout panel
LMS-325	5-watt modular amplified loudspeaker
MCS-325	5-watt passive modular loudspeaker
SAP612	Source assignment panel
TW-5W	1x5 2CH 3-pin XLR-type passive splitter
TW-7W	1 female XLR-3 into 7 male XLR-3 out
MCP-1, MPC-2, MPC-3, & more	Various rack mount kits for rack mounting of devices

***NOT AVAILABLE IN ALL REGIONS.**
Contact RTS for more information.

TWO-WIRE BELTPACKS

RTS Two-Wire Intercom beltpacks are mechanically engineered to be rugged and dependable and provide maximum voice intelligibility.

SYSTEM COMPONENTS

Model name	Description
4030	2CH IFB beltpack
4030M	1CH IFB beltpack "passive device" adapter
BP-325	2CH binaural programmable beltpack with wired intercom ports
BP-4000	1CH portable universal beltpack headset station for mobile users
BP-5000	2CH portable universal beltpack headset station for mobile users
IFB-325	1CH IFB beltpack



BP-325 2CH BINAURAL PROGRAMMABLE BELTPACK

The BP-325 is a portable beltpack for use with RTS Two-Wire intercom systems. The BP-325 is a binaural (stereo) programmable two-channel beltpack with program-input capability. The BP-325 is for use with a dynamic microphone only.



BP-4000 1CH PORTABLE UNIVERSAL BELTPACK HEADSET STATION FOR MOBILE USERS

The BP-4000 universal beltpack is a 1-channel portable user station compatible with RTS, Audiocom, and Clear-Com party line systems. The BP-4000 has a mode-sensing system configuration, meaning the beltpack can determine what type of system it is installed into and configure itself according to that system. The BP-4000 can be ordered with either a 4-pin male, 4-pin female, or a 5-pin female XLR connector providing, a wide-range of headset options.



BP-5000 2CH PORTABLE UNIVERSAL BELTPACK HEADSET STATION FOR MOBILE USERS

The BP-5000 universal beltpack is a 2-channel portable user station compatible with RTS, Audiocom, and Clear-Com party line systems. The BP-5000 has a mode-sensing system configuration, meaning the beltpack can determine what type of system it is installed into and configure itself according to that system. The BP-5000 can be ordered with either a 4-pin male, 4-pin female, or a 5-pin female XLR connector providing, a wide-range of headset options.

AUDIOCOM BALANCED INTERCOM*

Audio balanced intercom systems, utilizing industry-leading balanced audio system structure and highly configurable and expandable modular designs, are utilized in virtually every kind of application and venue throughout the world.

***NOT AVAILABLE IN ALL REGIONS.**

Audiocom products may not be available for purchase in your particular country or locality. Check with your local RTS authorized dealer, distributor or other representative for the availability of specific products and services in your area.



MS-2002*

**1CH USER/MAIN STATION WITH
2.0 AMP POWER SUPPLY**

The MS-2002 is a complete two-channel master station and system power supply (24 VDC, 2 amps total power) in a single unit. You simply plug it into any AC power outlet from 100 to 240 volts, add a microphone or headset, connect intercom stations to the back panel, and you are ready to communicate. It even has both single-channel and two-channel connectors, so you do not have to add a separate breakout box if you want to mix single-channel and two-channel intercom stations. The MS-2002 fits in a standard 19" equipment rack and is 1 rack unit high. The basic MS-2002 can communicate with two intercom channels. Connecting optional EMS-4001 expansion stations can increase this number. Each EMS-4001 adds four additional channels, and up to four of these expansion stations can be connected for a total of eighteen channels.

MS-4002*

4CH MASTER STATION

The MS-4002 is a complete four-channel, balanced audio master station and 4 amp system power supply in a single unit. You simply plug it into any AC power outlet from 100 to 240 volts, add a microphone or headset, connect intercom stations to the back panel, and you are ready to communicate. The MS-4002 is now equipped with an advanced programming mode on the front panel, eliminating the need for internal DIP switches. It also has a feature that automatically senses the type of headset attached to the unit, either dynamic or electret. The MS-4002 fits in a standard 19" equipment rack and is 1 rack unit high. The MS-4002 is Clear-Com compatible, with the ability to run in unbalanced mode.



PS-4001*

4CH POWER SUPPLY

The PS4001 power supply supplies four isolated channels of intercom system phantom power to down line components. The PS4001 may be combined with an ES4000A expansion station to create additional intercom channels when using a US2002/PS2001L or US2000A/SPS2001 master station configuration. The PS4001 can also be used as a standalone power supply to provide power to four independent partyline channels. Rack mountable in a variety of modular configurations with one of several optional rack mount kits. Clear-Com compatible.



BP-4000 A4M

1CH PORTABLE UNIVERSAL
BELTPACK HEADSET STATION
FOR MOBILE USERS

The BP-4000 universal beltpack is a 1-channel portable user station compatible with RTS, Audiocom, and Clear-Com party line systems. The BP-4000 has a mode-sensing system configuration, meaning the beltpack can determine what type of system it is installed into and configure itself according to that system. Multiple programming options are available. To simplify programming, voice prompts guide the user through the menus.



BP-6000

UNIVERSAL BELTPACK

The BP-6000 is a portable user stations compatible with Audiocom and Clear-Com party line systems. The BP-6000 is a 2-channel beltpack equipped with a mode-sensing system configuration, meaning the beltpack determines what type of system it is installed into and configures itself according to the system. Dynamic and electret headset microphones are supported. The loop and line connection both use 6-pin Switchcraft connectors.



IFB-1000

1CH BELTPACK

Portable, single-channel, listen-only beltpack. High-quality audio receive circuit. Rugged low-profile metal case with sturdy belt clip. Recessed volume control. Power on indicator. One 3-pin XLR connector for partyline connection. 1/4" phone jack for earphone or earset. Uses same cables and wall plates as BP-4000 and BP-6000. Powered from partyline.



ICW-6*

WINDOW INTERCOM

The ICW-6 represents the ultimate in reliable, rugged, and flexible security and ticket booth communications equipment. Unique audio-shaping circuitry and enhanced VOX (Voice Threshold Level Activation) operation ensure maximum voice intelligibility is achieved. Installation is quick and easy with out 2-piece, super rugged, maintenance-free polycarbonate enclosure.

***NOT AVAILABLE IN ALL REGIONS.**
Contact RTS for more information.



INTERCOM HEADSETS & EARSETS



LIGHTWEIGHT HEADSETS

The RTS lightweight headsets provide users with an ideal combination of functionality and comfort. The double-sided PH-44 and single-sided PH-88 models offer users an efficient and durable standard headset, one that has become an industry standard. The LH-300 single-sided and LH-302 double-sided models add a headband pad and leatherette ear cushions for additional comfort.



FULL-CUSHION HEADSETS

The PH Series full-cushion intercom headsets have moderate noise isolation and an easily-positioned mic adjusting ball joint. The HR Series features a moleskin covered headband and clamping force adjustment feature designed to distribute pressure evenly over each ear. Both the PH and HR series are durable and offer the ultimate in day-long comfort. They are popular with users in a wide variety of applications.



MONITOR HEADPHONES

The HR-1L & HR-2L are medium-weight, noise reduction headphones with a noise reduction rating of 21 dB. The headsets effectively reduce noise and are suitable for use in moderately noisy environments. All models feature a unique, soft padded headband design that distributes ear cushion pressure evenly over each ear.



ANNOUNCER EARSETS

The popular RTS earsets are precisely designed for inconspicuous listening while on camera. Used by nearly all major television networks and stations, we have surpassed industry standards. The extremely efficient miniature driver element requires only nominal operating power and enables the announcer to hear program cues while working with a live microphone. The units are also suitable for many other applications such as live theater script prompting.



HS-6A PTT HANDSET

The HS-6A is a telephone-style handset that offers a push-to-talk switch, dynamic earphone and dynamic microphone. It is supplied with a metal hanger bracket for vertical storage and is compatible with most user stations. The HS-6A is terminated with an A4F plug. Available in white or black.

HEADQUARTER ADDRESSES

NORTH AMERICA GLOBAL HQ

Bosch Security Systems, LLC
Burnsville, MN 55337 USA
Phone: +1 952 8 84 4051

LATIN AMERICA REGIONAL HQ

Robert Bosch Limitada
Security Systems
Campinas, SP, Brasil
Phone: +55 19 2103-4282
RTS.Intercom.LA@br.bosch.com

EUROPE REGIONAL HQ

Bosch Sicherheitssysteme GmbH
(EVI Audio GmbH)
Straubing, Germany
Phone: +49 9421 706-0
info@rtsintercoms.com

ASIA-PACIFIC REGIONAL HQ

Robert Bosch (SEA) Pte Ltd
Singapore
Phone: +65 6571 2808

CHINA REGIONAL HQ

Bosch (Shanghai)
Security Systems Ltd.
IBP, Changning District
Shanghai, P.R.China
Phone: +86 400 8310 669
rts@cn.bosch.com



Flexible, reliable, and scalable IP intercom.

That's
#theRTSdifference

For information on any of the products featured in this catalog, you can reach us at info@rtsintercoms.com
Please visit the RTS website at: www.rtsintercoms.com



@rtsintercoms



@rtsintercomsystems



@rtsintercoms



@rtsintercoms

04/2022, © Bosch Security Systems, LLC
Information in this document is subject to change without notice.
All trademarks are the copyrights of their respective owners.

RTS