



# Maintenance and Service Guide

## HP Engage Flex Pro-C G2 Retail System

### **SUMMARY**

This guide provides maintenance information about such topics as spare parts, removal and replacement of parts, security, and backing up.

# Legal information

© Copyright 2023, 2024 HP Development Company, L.P.

AMD is a trademark of Advanced Micro Devices, Inc. Bluetooth is a trademark owned by its proprietor and used by HP Inc. under license. The terms HDMI, HDMI High-Definition Multimedia Interface, and the HDMI Logo are trademarks or registered trademarks of HDMI Licensing Administrator, Inc. Intel, Celeron, Core, Optane, and Pentium are trademarks of Intel Corporation or its subsidiaries in the U.S. and/or other countries. Microsoft and Windows are either registered trademarks or trademarks of Microsoft Corporation in the United States and/or other countries. NVIDIA and NVIDIA RTX are trademarks and/or registered trademark of NVIDIA Corporation in the U.S. and other countries. NVMe is a registered trademark of NVM Express. PCIe is a US registered trademark of PCI-SIG. USB Type-C and USB-C are registered trademarks of USB Implementers Forum. DisplayPort and the DisplayPort logo are trademarks owned by the Video Electronics Standards Association (VESA) in the United States and other countries. Wi-Fi is a registered trademark of the Wi-Fi Alliance®.

The information contained herein is subject to change without notice. The only warranties for HP products and services are set forth in the express warranty statements accompanying such products and services. Nothing herein should be construed as constituting an additional warranty. HP shall not be liable for technical or editorial errors or omissions contained herein.

Second Edition: December 2024

First Edition: July 2023

Document Part Number: N55469-002

## Product notice

This guide describes features that are common to most models. Some features may not be available on your computer.

Not all features are available in all editions or versions of Windows. Systems may require upgraded and/or separately purchased hardware, drivers, software or BIOS update to take full advantage of Windows functionality. Windows is automatically updated, which is always enabled. High-speed internet and Microsoft account required. ISP fees may apply and additional requirements may apply over time for updates. See <http://www.windows.com>.

### If your product ships with Windows in S

**Mode:** Windows in S Mode works exclusively with apps from the Microsoft Store within Windows. Certain default settings, features, and apps cannot be changed. Some accessories and apps that are compatible with Windows may not work (including some antivirus, PDF writers, driver utilities, and accessibility apps), and performance may vary, even if you switch out of S Mode. If you switch to Windows, you cannot switch back to S Mode. Learn more at [Windows.com/SmodeFAQ](http://Windows.com/SmodeFAQ).

To access the latest user guides, go to <http://www.hp.com/support>, and follow the instructions to find your product. Then select **Manuals**.

## Software terms

By installing, copying, downloading, or otherwise using any software product preinstalled on this computer, you agree to be bound by the terms of the HP End User License Agreement (EULA). If you do not accept these license terms, your sole remedy is to return the entire unused product (hardware and software) within 14 days for a full refund subject to the refund policy of your seller.

For any further information or to request a full refund of the price of the computer, please contact your seller.

## Safety warning notice

Reduce the possibility of heat-related injuries or of overheating the computer by following the practices described.

---

**⚠ WARNING!** To reduce the possibility of heat-related injuries or of overheating the computer, do not place the computer directly on your lap or obstruct the computer air vents. Use the computer only on a hard, flat surface. Do not allow another hard surface, such as an adjoining optional printer, or a soft surface, such as pillows or rugs or clothing, to block airflow. Also, do not allow the AC adapter to come into contact with the skin or a soft surface, such as pillows or rugs or clothing, during operation. The computer and the AC adapter comply with the user-accessible surface temperature limits defined by applicable safety standards.

---

---

# Table of contents

<b>1 Computer features</b>	<b>1</b>
Standard configuration features	1
HP Engage Flex Pro-C G2	1
Front panel components	1
Rear panel components	2
Serial number location	4
Changing from desktop to tower orientation	4
Connecting external Wi-Fi antennas	5
<b>2 Illustrated parts catalog</b>	<b>6</b>
Computer major components	6
Miscellaneous parts	8
<b>3 Routine care, drive guidelines, and disassembly preparation</b>	<b>10</b>
Electrostatic discharge information	10
Generating static electricity	10
Preventing electrostatic damage to equipment	11
Personal grounding methods and equipment	11
Grounding the work area	12
Recommended materials and equipment	12
Operating guidelines	13
Routine care	13
General cleaning safety precautions	13
Cleaning the computer case	14
Cleaning the keyboard	14
Cleaning the monitor	15
Cleaning the mouse	15
Service considerations	15
Tools and software requirements	15
Screws	15
Cables and connectors	15
Hard drives	16
Lithium coin cell battery	16
SATA hard drives	16
Cable management	17
<b>4 Removal and replacement procedures</b>	<b>18</b>
Preparation for disassembly	18
Dust filter	18
Access panel	19

Solid-state drive .....	19
Hard drive .....	21
Expansion cards .....	22
Expansion cards .....	23
Battery .....	25
Front bezel .....	26
Fan and duct assembly .....	28
Memory modules (DIMMs) .....	28
Heat sink .....	31
Processor .....	32
Front I/O assembly .....	33
Speaker .....	34
Powered serial ports .....	35
Serial port A .....	36
Serial port C/D .....	37
Cash drawer card .....	38
WLAN module .....	38
Flex card .....	39
Rear expansion card .....	40
Audio board .....	41
Power supply .....	42
WLAN antennas and external connectors .....	43
System board .....	44
<b>5 Computer Setup (F10) Utility .....</b>	<b>47</b>
Using Computer Setup (F10) Utilities .....	47
Computer Setup Main .....	48
Computer Setup Security .....	52
Computer Setup Advanced .....	58
<b>6 POST error messages .....</b>	<b>68</b>
POST numeric codes and text messages .....	68
Interpreting POST diagnostic front panel lights and audible codes .....	74
<b>7 Password security and resetting CMOS .....</b>	<b>77</b>
Changing a setup or power-on password .....	77
Deleting a setup or power-on password .....	77
<b>8 Backing up, restoring, and recovering .....</b>	<b>79</b>
Backing up information and creating recovery media .....	79
Using Windows tools for backing up .....	79
Using the HP Cloud Recovery Download Tool to create recovery media (select products only) .....	79

Restoring and recovering your system.....	80
Creating a system restore .....	80
Restoring and recovery methods .....	80
Recovering using HP Recovery media.....	80
Changing the computer boot order .....	81
Using HP Sure Recover (select products only).....	81
<b>9 Using HP PC Hardware Diagnostics .....</b>	<b>82</b>
Using HP PC Hardware Diagnostics Windows (select products only).....	82
Using an HP PC Hardware Diagnostics Windows hardware failure ID code.....	82
Accessing HP PC Hardware Diagnostics Windows.....	82
Accessing HP PC Hardware Diagnostics Windows from HP Support Assistant.....	82
Accessing HP PC Hardware Diagnostics Windows from the Start menu (select products only).....	83
Downloading HP PC Hardware Diagnostics Windows.....	83
Downloading the latest HP PC Hardware Diagnostics Windows version from HP .....	83
Downloading the HP PC Hardware Diagnostics Windows from the Microsoft Store .....	83
Downloading HP Hardware Diagnostics Windows by product name or number (select products only) .....	83
Installing HP PC Hardware Diagnostics Windows.....	84
Using HP PC Hardware Diagnostics UEFI .....	84
Using an HP PC Hardware Diagnostics UEFI hardware failure ID code.....	84
Starting HP PC Hardware Diagnostics UEFI .....	84
Starting HP PC Hardware Diagnostics UEFI through HP Hotkey Support software (select products only).....	85
Downloading HP PC Hardware Diagnostics UEFI to a USB flash drive.....	85
Downloading the latest HP PC Hardware Diagnostics UEFI version .....	86
Downloading HP PC Hardware Diagnostics UEFI by product name or number (select products only) .....	86
Using Remote HP PC Hardware Diagnostics UEFI settings (select products only).....	86
Downloading Remote HP PC Hardware Diagnostics UEFI .....	86
Downloading the latest Remote HP PC Hardware Diagnostics UEFI version.....	86
Downloading Remote HP PC Hardware Diagnostics UEFI by product name or number .....	86
Customizing Remote HP PC Hardware Diagnostics UEFI settings.....	87
<b>10 Statement of memory volatility.....</b>	<b>88</b>
Current BIOS steps .....	88
Nonvolatile memory usage .....	90
Questions and answers .....	90
Using HP Sure Start (select products only).....	92
<b>11 Power cord set requirements.....</b>	<b>93</b>
General requirements .....	93
Japanese power cord requirements .....	93
Country-specific requirements .....	93
<b>12 Specifications .....</b>	<b>95</b>
<b>Index.....</b>	<b>96</b>

---

# 1 Computer features

This chapter provides you with an overview of your computer's features.

## Standard configuration features

Features vary depending on the model. For support assistance and to learn more about the hardware and software installed on your computer model, run the HP Support Assistant utility.

---

 **NOTE:** You can use this computer model in a tower orientation or a desktop orientation.

See [Changing from desktop to tower orientation on page 4](#).

---



## HP Engage Flex Pro-C G2

This section provides you with an overview of your computer's features.

### Front panel components

To identify the front panel components, use this illustration and table.



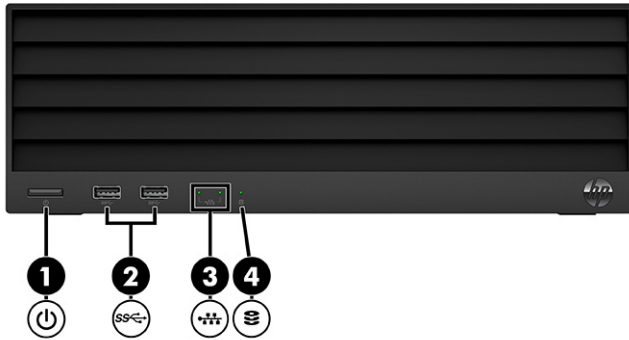

---

 **NOTE:** Drive configuration varies by model. Some models have a bezel blank that covers one or more drive bays.

---



**Table 1-1** Identifying the front panel components

Front panel components			
1		Power button	
2		USB 5 Gbps ports (2)	
3		Network interface card activity lights (2)	
4		Drive light	







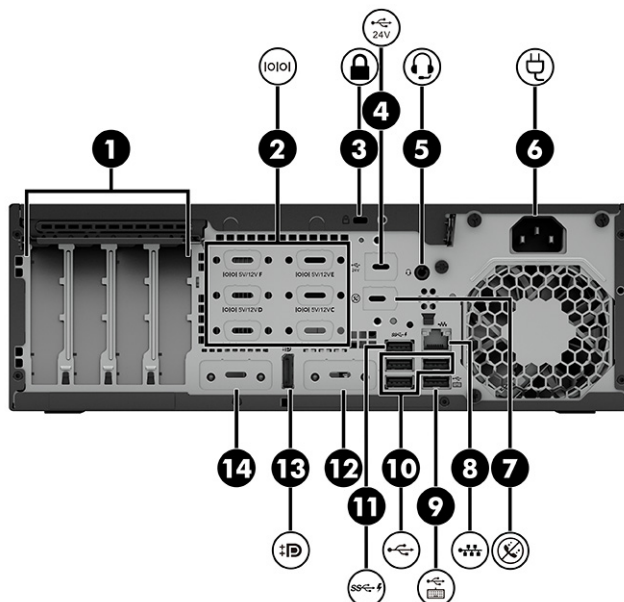





**NOTE:** The light on the power button is normally white when the power is on. If the light blinks red, the computer displays a diagnostic code to indicate a problem.

## Rear panel components

To identify the rear panel components, use this illustration and table.



**Table 1-2 Identifying the rear panel components**

Rear panel components			
1		PCIe® expansion slots (4)*	8  RJ-45 (network) jack
2		Serial ports (optional)	9  USB keyboard port
3		Security cable slot	10  USB 5 Gbps ports (3)
4		USB port, 24 V (optional)	11  USB 5 Gbps port with HP Sleep and Charge
5		Audio-out (headphone)/Audio-in (microphone) combo jack	12 Flex Port 2 <ul style="list-style-type: none"> <li>• USB Type-C® 65 W power delivery port (shown)</li> <li>• Serial port</li> <li>• DisplayPort™ connector</li> <li>• High-Definition Multimedia Interface® (HDMI®)</li> <li>• 2nd network port</li> <li>• VGA port</li> </ul>
6		Power connector	13  DisplayPort connector
7		USB standard duty (cash drawer) port (optional)	14 Flex Port 1 <ul style="list-style-type: none"> <li>• USB Type-C 27 W power delivery port (shown)</li> <li>• Serial port</li> <li>• DisplayPort connector</li> <li>• HDMI port</li> <li>• 2nd network port</li> <li>• VGA port</li> </ul>

\* If you received an external antenna with your configuration, connect it to the rear panel ports. The recommended distance is 40 cm from the computer.

**NOTE:** The combo jack supports headphones, line output devices, microphones, line input devices, or CTIA-style headsets.

**NOTE:** Your model might have additional optional ports available from HP.

When a graphics card is installed in one of the system board slots, you can use the video connectors on the graphics card or the integrated graphics on the system board. The specific graphics card installed and software configuration determine the behavior.

You can disable the system board graphics by changing settings in the Computer Setup (F10) Utility.

**NOTE:** To access the Computer Setup (F10) Utility, restart the computer and press the F10 key as soon as the HP logo screen is displayed, before the computer boots to the operating system.

## Serial number location

Each computer has a unique serial number and a product ID number that are located on the exterior of the computer. Keep these numbers available when contacting customer service for assistance.

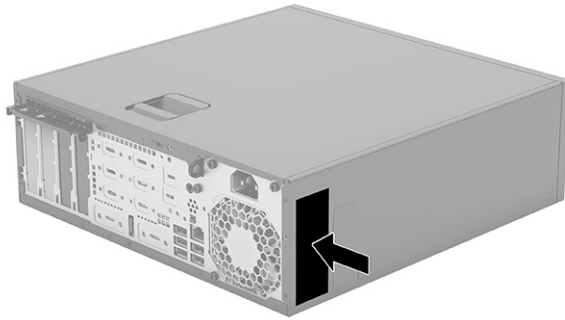

## Changing from desktop to tower orientation

You can use the computer in a tower orientation with an optional tower stand that you can purchase from HP.



---

**NOTE:** To stabilize the computer in a tower orientation, HP recommends the use of the optional tower stand.

---

1. Remove or disengage any security devices that prohibit opening the computer.
2. Remove all removable media, such as compact discs and USB flash drives, from the computer.
3. Turn off the computer properly through the operating system, and turn off any external devices.
4. Disconnect the power cord from the AC outlet and disconnect any external devices.

5. Position the computer so that its right side faces up, and place the computer in the optional stand.

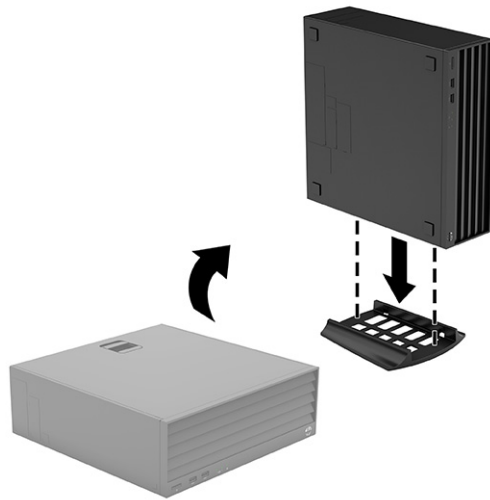

6. Reconnect the power cord and any external devices, and then turn on the computer.

 **NOTE:** Be sure that at least 10.2 centimeters (4 inches) of space on all sides of the computer remains clear and free of obstructions.

7. Lock any security devices that you disengaged before you moved the computer.

## Connecting external Wi-Fi antennas

Read this section to learn how to connect external Wi-Fi antennas to your computer.

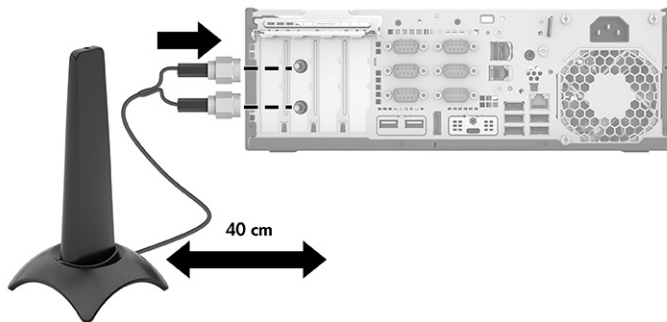

For best performance, place the antenna on the side of the computer that offers the clearest line-of-sight to the access point or router. The recommended distance is more than 40 cm (15.8 in) from the computer. Avoid placing the antenna in front of, behind, or on top of the computer because of the risk of noise interference.

## 2 Illustrated parts catalog

Use this information to determine the spare parts that are available for the computer.

 **NOTE:** HP continually improves and changes product parts. For complete and current information about supported parts for your computer, go to <https://partsurfer.hp.com/partsurfer/>, select your country or region, and then follow the on-screen instructions.

### Computer major components

To identify the computer major components, use this illustration and table.

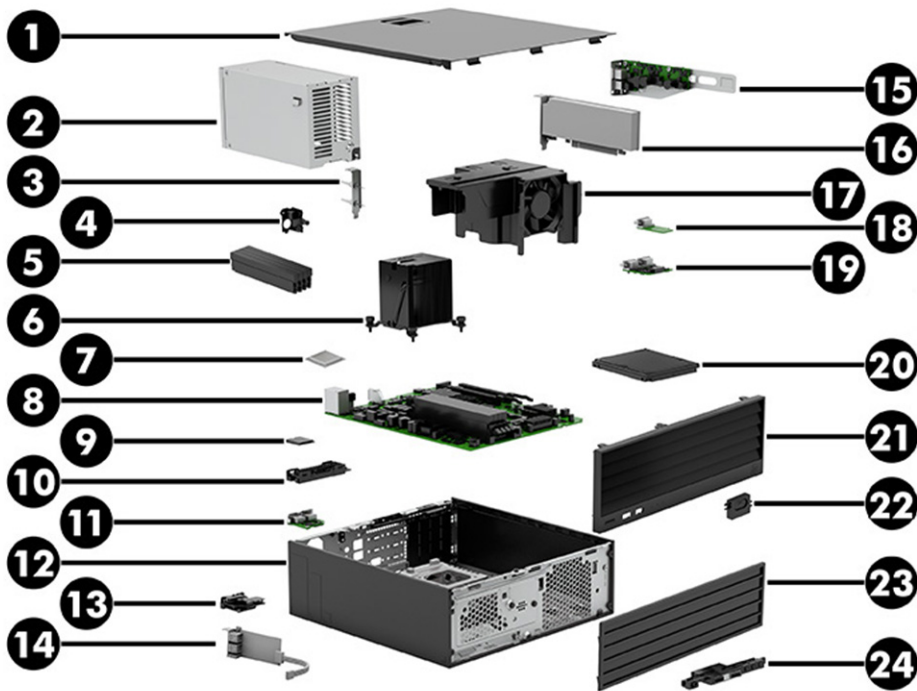

**Table 2-1** Computer major components and their descriptions

Item	Description
(1)	Access panel
(2)	Power supply (250 W)
(3)	WLAN antennas and external connectors
(4)	Audio board
(5)	Memory module (UDIMM, DDR5-4800, NECC, 1.1 V)
	32 GB
	16 GB

**Table 2-1 Computer major components and their descriptions (continued)**

<b>Item</b>	<b>Description</b>
	8 GB
<b>(6)</b>	<b>Heat sink</b>
<b>(7)</b>	<b>Processor</b>
	Intel® Core® i9-13900TE processor
	Intel Core i7-13700TE processor
	Intel Core i5-13500TE processor
	Intel Core i5-13500E processor
	Intel Core i3-13100TE processor
	Intel Core i3-13100E processor
	Intel Pentium® Gold G7400E processor
	Intel Celeron® G6900TE processor
	Intel Celeron G6900E processor
<b>(8)</b>	<b>System board</b>
	<b>NOTE:</b> System boards are available for computers with a non-Windows® operating system, Windows IoT, and Windows.
<b>(9)</b>	<b>WLAN module</b>
	Intel Wi-Fi® 5 AX211 + Bluetooth® 5.2 (vPro)
	Intel Wi-Fi 5 AX211 + Bluetooth 5.2 (non-vPro)
	Realtek 8852CE Wi-Fi 6E Bluetooth 5.3 WLAN
<b>(10)</b>	<b>Solid-state drive with heat sink (M.2 2280, PCIe-4×4)</b>
	2 TB, TLC
	1 TB, TLC
	1 TB
	512 GB, TLC
	512 GB
	512 GB, self-encrypting drive (SED)
	256 GB
	256 GB, self-encrypting drive (SED)
<b>(11)</b>	<b>Rear expansion port</b>
<b>(12)</b>	<b>Computer chassis</b>
<b>(13)</b>	<b>Rear flex card</b>
	Dual USB Type-A ports
	USB Type-C with DisplayPort (15 W output)
	USB Type-C with DisplayPort (27 W and 65 W output)

**Table 2-1 Computer major components and their descriptions (continued)**

Item	Description
	DisplayPort 1.4a
	VGA
	HDMI2.0b with HDR + HDCP 2.3
	NIC 2.5 G
<b>(14)</b>	<b>Rear option card</b>
	Line out connector
	3× 12 V USB ports
	Power serial adapter
	Dual-powered USB-to-serial port
<b>(15)</b>	<b>Cash drawer 24 V power flex card</b>
<b>(16)</b>	<b>Graphics card</b>
	NVIDIA® T1000
	NVIDIA RTX® A2000
<b>(17)</b>	<b>Fan and duct assembly</b>
<b>(18)</b>	<b>Single serial port</b>
<b>(19)</b>	<b>Dual serial port</b>
<b>(20)</b>	<b>Hard drive</b>
	2 TB, 5400 rpm
	1 TB, 7200 rpm
	500 GB, 7200 rpm
<b>(21)</b>	<b>Front bezel</b>
<b>(22)</b>	<b>Speaker</b>
<b>(23)</b>	<b>Dust filter</b>
<b>(24)</b>	<b>Front I/O assembly</b>
*	<b>Parallel port (PCIe x1)</b>
* not illustrated	

## Miscellaneous parts

To identify the various computer parts, use this table.

**Table 2-2 Miscellaneous parts and their descriptions**

Description
<b>Cables</b>
SATA cable, 46 cm (18 in), one straight end, one right angle end

**Table 2-2** Miscellaneous parts and their descriptions (continued)

<b>Description</b>
SATA cable, 46 cm (18 in), two straight ends, RF
SATA power cable, RF
SATA power cable
Audio line out flex pro cable, 340 mm (13.4 in)
RPOS RF switch
DisplayPort cable
<b>Adapters</b>
HDMI-to-HDMI 1.4/2.0, 1.8 m (6 ft)
USB-C®-to-USB 3.0
Mini DisplayPort-to-DisplayPort
DisplayPort-to-VGA
USB-to-serial port
USB-C-to-DisplayPort
DisplayPort-to-HDMI 2.0
<b>Mouse</b>
USB
HP 125 antimicrobial wired mouse
HP 125 wired mouse
HP 128 laser wired mouse
<b>Keyboard</b>
USB keyboard
HP 125 wired keyboard
HP 125 wired keyboard, antimicrobial
<b>Hard drive grommet screws</b>
<b>Low profile bracket for P600/P1000 graphics cards</b>
<b>External wireless antenna</b>
<b>Plastic WLAN cover</b>
<b>Access panel latch, plastic</b>
<b>Computer stand</b>
<b>Power cord (C13, 1.83 m [6 ft])</b>

---

## 3 Routine care, drive guidelines, and disassembly preparation

This information provides general service information for the computer. Adherence to the procedures and precautions is essential for proper service.

 **IMPORTANT:** When the computer is plugged into an AC power source, DC voltage is always applied to the system board. You must disconnect the power cord from the power source before opening the computer to prevent electric shock, system board, or component damage.

---

### Electrostatic discharge information

A sudden discharge of static electricity from your finger or other conductor can destroy static-sensitive devices or microcircuitry. Often the spark is neither felt nor heard, but damage occurs.

An electronic device exposed to electrostatic discharge (ESD) might not appear to be affected at all and can work perfectly throughout a normal cycle. The device might function normally for a while, but it has been degraded in the internal layers, reducing its life expectancy.

Networks built into many integrated circuits provide some protection, but in many cases, the discharge contains enough power to alter device parameters or melt silicon junctions.

 **IMPORTANT:** To prevent damage to the device when you are removing or installing internal components, observe these precautions:

- Keep components in their electrostatic-safe containers until you are ready to install them.
  - Before touching an electronic component, discharge static electricity by using the guidelines described in this section.
  - Avoid touching pins, leads, and circuitry. Handle electronic components as little as possible.
  - If you remove a component, place it in an electrostatic-safe container.
- 

### Generating static electricity

This table shows how humidity affects the electrostatic voltage levels generated by different activities. A product can be degraded by 700 V of static electricity.

- Different activities generate different amounts of static electricity.
- Static electricity increases as humidity decreases.

**Table 3-1 Static electricity occurrence based on activity and humidity**

Event	Relative humidity		
	55%	40%	10%

---

**Table 3-1 Static electricity occurrence based on activity and humidity (continued)**

	Relative humidity		
Walking across carpet	7,500 V	15,000 V	35,000 V
Walking across vinyl floor	3,000 V	5,000 V	12,000 V
Motions of bench worker	400 V	800 V	6,000 V
Removing DIPs (dual in-line packages) from plastic tube	400 V	700 V	2,000 V
Removing DIPs from vinyl tray	2,000 V	4,000 V	11,500 V
Removing DIPs from polystyrene foam	3,500 V	5,000 V	14,500 V
Removing bubble pack from PCB (printed circuit board)	7,000 V	20,000 V	26,500 V
Packing PCBs in foam-lined box	5,000 V	11,000 V	21,000 V
Multiple electric components can be packaged in plastic tubes, trays, or polystyrene foam.			

## Preventing electrostatic damage to equipment

Many electronic components are sensitive to ESD. Circuitry design and structure determine the degree of sensitivity. The following packaging and grounding precautions are necessary to prevent static electricity damage to electronic components.

- To avoid hand contact, transport products in static-safe containers such as tubes, bags, or boxes.
- Protect all electrostatic parts and assemblies with conductive or approved containers or packaging.
- Keep electrostatic-sensitive parts in their containers until they arrive at static-free stations.
- Place items on a grounded surface before removing them from their container.
- Always be properly grounded when touching a sensitive component or assembly.
- Avoid contact with pins, leads, or circuitry.
- Place reusable electrostatic-sensitive parts from assemblies in protective packaging or conductive foam.

## Personal grounding methods and equipment

Use this equipment to prevent static electricity damage to electronic components.

- **Wrist straps** are flexible straps with a maximum of  $1\text{ M}\Omega \pm 10\%$  resistance in the ground cords. To provide proper ground, a strap must be worn snug against bare skin. The ground cord must be connected and fit snugly into the banana plug connector on the grounding mat or workstation.
- **Heel straps/Toe straps/Boot straps** can be used at standing workstations and are compatible with most types of shoes or boots. On conductive floors or dissipative floor mats, use them on both feet with a maximum of  $1\text{ M}\Omega \pm 10\%$  resistance between the operator and ground.

**Table 3-2 Static shielding protection levels**

Static shielding protection levels	
Method	Voltage

**Table 3-2 Static shielding protection levels (continued)**

Static shielding protection levels	
Antistatic plastic	1,500 V
Carbon-loaded plastic	7,500 V
Metallized laminate	15,000 V

## Grounding the work area

To prevent static damage at the work area, use these precautions.

- Cover the work surface with approved static-dissipative material. Provide a wrist strap connected to the work surface and properly grounded tools and equipment.
- Use static-dissipative mats, foot straps, or air ionizers to give added protection.
- Handle electrostatic sensitive components, parts, and assemblies by the case or PCB laminate. Handle them only at static-free work areas.
- Turn off power and input signals before inserting and removing connectors or test equipment.
- Use fixtures made of static-safe materials when fixtures must directly contact dissipative surfaces.
- Keep work area free of nonconductive materials such as ordinary plastic assembly aids and polystyrene foam.
- Use field service tools, such as cutters, screwdrivers, and vacuums, that are conductive.

## Recommended materials and equipment

HP recommends these materials and equipment to prevent static electricity.

- Antistatic tape
- Antistatic smocks, aprons, or sleeve protectors
- Conductive bins and other assembly or soldering aids
- Conductive foam
- Conductive tabletop workstations with ground cord of  $1\text{ M}\Omega \pm 10\%$  resistance
- Static-dissipative table or floor mats with hard tie to ground
- Field service kits
- Static awareness labels
- Wrist straps and footwear straps providing  $1\text{ M}\Omega \pm 10\%$  resistance
- Material handling packages
- Conductive plastic bags
- Conductive plastic tubes
- Conductive tote boxes

- Opaque shielding bags
- Transparent metallized shielding bags
- Transparent shielding tubes

## Operating guidelines

This information details how to prevent overheating and to help prolong the life of the computer.

- Keep the computer away from excessive moisture, direct sunlight, and extremes of heat and cold.
- Operate the computer on a sturdy, level surface. Leave a 10.2 cm (4 inch) clearance on all vented sides of the computer and above the monitor to permit the required airflow.
- Never restrict the airflow into the computer by blocking any vents or air intakes. Do not place the keyboard, with the keyboard feet down, directly against the front of the desktop unit as this also restricts airflow.
- Occasionally clean the air vents on all vented sides of the computer. Lint, dust, and other foreign matter can block the vents and limit the airflow. Be sure to unplug the computer before cleaning the air vents.
- Never operate the computer with the cover or side panel removed.
- Do not stack computers on top of each other or place computers so near each other that they are subject to each other's recirculated or preheated air.
- If the computer is to be operated within a separate enclosure, intake and exhaust ventilation must be provided on the enclosure, and the same operating guidelines listed previously still apply.
- Keep liquids away from the computer and keyboard.
- Never cover the ventilation slots on the monitor with any type of material.
- Install or enable power management functions of the operating system or other software, including Sleep states.

## Routine care

Use this information to properly care for your computer.

## General cleaning safety precautions

Use this information to safely clean your computer.

---

**⚠ CAUTION:** To prevent electric shock or damage to components, never clean a product while it is turned on or plugged in.

---

- Never use solvents or flammable solutions to clean the computer.
- Never immerse any parts in water or cleaning solutions; apply any liquids to a clean cloth and then use the cloth on the component.
- Always unplug the computer when cleaning with liquids or damp cloths.
- Always unplug the computer before cleaning the keyboard, mouse, or air vents.

- Disconnect the keyboard before cleaning it.
- Wear safety glasses equipped with side shields when cleaning the keyboard.

## Cleaning the computer case

Follow all safety precautions before cleaning the computer case.

To clean the computer case, follow these procedures:



---

**NOTE:** You can also use these procedures to clean the tops of the keys, keyboard body, monitor body, or mouse body.

---

- To remove light stains or dirt, use plain water with a clean, lint-free cloth or swab.
- For stronger stains, use a mild dishwashing liquid diluted with water. Rinse well by wiping it with a cloth or swab dampened with clear water.
- For stubborn stains, use isopropyl (rubbing) alcohol. No rinsing is needed because the alcohol evaporates quickly and does not leave a residue.
- After cleaning, always wipe the unit with a clean, lint-free cloth.
- Occasionally clean the air vents on the computer. Lint and other foreign matter can block the vents and limit the airflow.

## Cleaning the keyboard

Use this information to properly clean the keyboard. Follow all safety precautions before cleaning the keyboard.

To clean the tops of the keys or the keyboard body, follow the procedures described in [Cleaning the computer case on page 14](#).

When cleaning debris from under the keys, review all rules in [General cleaning safety precautions on page 13](#) before following these procedures.



---

**CAUTION:** Use safety glasses equipped with side shields before attempting to clean debris from under the keys.

---

- You can remove visible debris underneath or between the keys by vacuuming or shaking.
- You can use canned, pressurized air to clean debris from under the keys. Use caution because too much air pressure can dislodge lubricants applied under the wide keys.
- If you remove a key, use a specially designed key puller to prevent damage to the keys. This tool is available through many electronic supply outlets.



---

**IMPORTANT:** Never remove a wide leveled key (like the space bar) from the keyboard. If these keys are improperly removed or installed, the keyboard might not function properly.

---

- You can clean under a key with a swab moistened with isopropyl alcohol and squeezed out. Be careful not to wipe away lubricants necessary for proper key functions. Use tweezers to remove any fibers or dirt in confined areas. Allow the parts to air dry before reassembly.

## Cleaning the monitor

Follow all safety precautions before cleaning dirt and debris from your computer. Use this information to properly clean the monitor.

- Wipe the monitor screen with a clean cloth moistened with water or with a towelette designed for cleaning monitors. Do not use sprays or aerosols directly on the screen; the liquid can seep into the housing and damage a component. Never use solvents or flammable liquids on the monitor.
- To clean the monitor body, follow the procedures in [Cleaning the computer case on page 14](#).

## Cleaning the mouse

Follow all safety precautions before cleaning your mouse. Use this information to properly clean the mouse.

To clean the mouse body, follow the procedures in [Cleaning the computer case on page 14](#).

## Service considerations

Keep these considerations in mind during the disassembly and assembly of the computer.

## Tools and software requirements

Servicing the computer requires these tools.

- Torx T-15 screwdriver
- Flat-bladed screwdriver (can sometimes be used in place of the Torx screwdriver)
- Phillips P1 screwdriver
- Nonconductive, nonmarking pry tool
- Diagnostics software

## Screws

The screws used in the computer are not interchangeable. They could have standard or metric threads and might be of different lengths.

If you use an incorrect screw during the reassembly process, it can damage the unit. HP strongly recommends that you keep all screws that you remove during disassembly with the removed part and then return them to their proper locations.



---

**IMPORTANT:** As you remove each subassembly from the computer, place it away from the work area to prevent damage.

---

## Cables and connectors

Use this information to properly handle cables.

Apply only the tension required to seat or unseat the cables during insertion or removal from the connector. Handle cables by the connector whenever possible. In all cases, avoid bending or twisting

the cables, and route the cables so that they cannot be caught or snagged by parts being removed or replaced.

---

 **IMPORTANT:** When servicing this computer, be sure to place cables in their proper location during the reassembly process. Improper cable placement can damage the computer.

---

## Hard drives

Handle hard drives as delicate, precision components, and avoid all physical shock and vibration. This advice applies to failed drives as well as replacement spares.

- If a drive must be mailed, place the drive in a bubble-pack mailer or other suitable protective packaging and label the package “Fragile: Handle With Care.”
- Do not remove hard drives from the shipping package for storage. Keep hard drives in their protective packaging until they are actually mounted in the computer.
- Avoid dropping drives from any height onto any surface.
- If you are inserting or removing a hard drive, turn off the computer. Do not remove a hard drive while the computer is on or in standby mode.
- Before handling a drive, ensure that you are discharged of static electricity. While handling a drive, avoid touching the connector.
- Do not use excessive force when inserting a drive.
- Avoid exposing a hard drive to liquids, temperature extremes, or products that have magnetic fields such as monitors or speakers.

## Lithium coin cell battery

The battery that comes with the computer provides power to the real-time clock and has a minimum lifetime of approximately three years.

See the removal and replacement chapter for replacement instructions.

---

 **WARNING!** This computer contains a lithium battery. There is a risk of fire and chemical burn if the battery is handled improperly. Do not disassemble, crush, puncture, short external contacts, dispose of in water or fire, or expose it to temperatures higher than 140°F (60°C). Do not attempt to recharge the battery.

 **NOTE:** Do not dispose of batteries, battery packs, and accumulators with general household waste. To forward them to recycling centers or proper disposal, use the public collection system or return them to HP, their authorized partners, or their agents.

---

## SATA hard drives

The Self Monitoring Analysis and Recording Technology (SMART) ATA drives for the HP Personal Computers have built-in drive failure prediction that warns the user or network administrator of an impending failure or crash of the hard drive.

The SMART drive tracks fault prediction and failure indication parameters such as reallocated sector count, spin retry count, and calibration retry count. If the drive determines that a failure is imminent, it generates a fault alert.

**Table 3-3 SATA hard drive characteristics**

Serial ATA hard drive characteristics	
Number of pins/conductors in data cable	7/7
Number of pins in power cable	15
Maximum data cable length	100 cm (39.37 in)
Data interface voltage differential	400 mV-700 mV
Drive voltages	3.3 V, 5 V, 12 V
Jumpers for configuring drive	N/A
Data transfer rate	6.0 Gbps

Always use an HP-approved SATA 6.0 Gbps cable because it is fully backwards compatible with the SATA 1.5 Gbps drives. Current HP desktop products ship with SATA 6.0 Gbps hard drives.

SATA data cables are susceptible to damage if overflexed. Never crease a SATA data cable and never bend it tighter than a 30 mm (1.18 in) radius.

The SATA data cable is a thin, seven-pin cable designed to transmit data for only a single drive.

## Cable management

Always follow good cable management practices when working inside the computer.

- Keep cables away from major heat sources like the heat sink.
- Keep cables clear of sliding or moveable parts to prevent them from being cut or crimped when the parts are moved.
- When folding a flat ribbon cable, never fold to a sharp crease. Sharp creases can damage the wires.
- Do not bend any cable sharply. A sharp bend can break the internal wires.
- Never bend a SATA data cable tighter than a 30 mm (1.18 in) radius.
- Never crease a SATA data cable.

---

## 4 Removal and replacement procedures

Adherence to these procedures and precautions is essential for proper service. After completing all necessary removal and replacement procedures, run the Diagnostics utility to verify that all components operate properly.

---

 **NOTE:** Not all features listed in this guide are available on all computers.

 **NOTE:** HP continually improves and changes product parts. For complete and current information about supported parts for your computer, go to <https://partsurfer.hp.com/partsurfer/>, select your country or region, and then follow the on-screen instructions.

---

### Preparation for disassembly

Use this information to properly prepare to disassemble and reassemble the computer.

See [Routine care, SATA drive guidelines, and disassembly preparation on page 10](#) for initial safety procedures.

1. Turn off the computer. If you are unsure whether the computer is off or in Hibernation, turn the computer on, and then shut it down through the operating system.

---

 **IMPORTANT:** Turn off the computer before disconnecting any cables.

Regardless of the power state, voltage is always present on the system board as long as the system is plugged into an active AC outlet. In some systems, the cooling fan is on even when the computer is in the Standby or Suspend modes. Always disconnect the power cord before servicing a unit.

---

2. Disconnect the power from the computer by unplugging the power cord from the computer.
3. Disconnect all external devices from the computer
4. (Select products only) If the computer is on a stand, remove the computer from the stand.

---

 **CAUTION:** Beware of sharp edges inside the chassis.

 **NOTE:** During disassembly, label each cable as you remove it, and note its position and routing. Keep all screws with the removed components.

---

### Dust filter

To remove the dust filter, use this procedure and illustration.

Before removing the dust filter, prepare the computer for disassembly (see [Preparation for disassembly on page 18](#)).

Remove the dust filter:

- Pull the dust filter straight off the outside of the front bezel.



To install the dust filter, reverse the removal procedure.

## Access panel

To remove the access panel, use this procedure and illustration.

Before removing the access panel, prepare the computer for disassembly (see [Preparation for disassembly on page 18](#)).

Remove the access panel:

- Slide the release latch **(1)**, and then lift the panel **(2)** up and away from the computer.

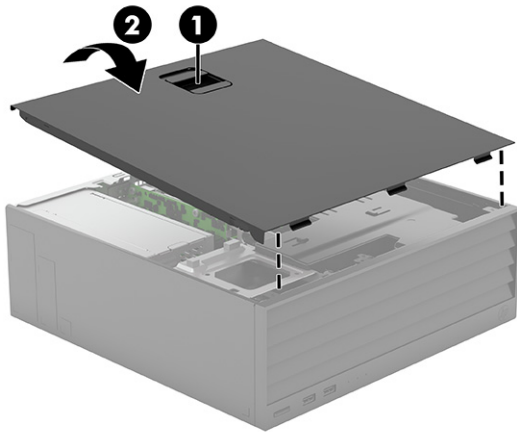

To install the access panel, reverse the removal procedure.

## Solid-state drive

To remove the solid-state drive, use this procedure and illustration.

For a list of available solid-states drives, see [Computer major components on page 6](#).

Before removing the solid-state drive, follow these steps:

1. Prepare the computer for disassembly (see [Preparation for disassembly on page 18](#)).
2. Remove the access panel (see [Access panel on page 19](#)).

3. Remove any expansion cards that block access to the drive (see [Expansion cards on page 22](#)).

Remove the solid-state drive:

1. Use the following illustration to determine drive locations.  
(1) Primary solid-state drive  
(2) Secondary solid-state drive

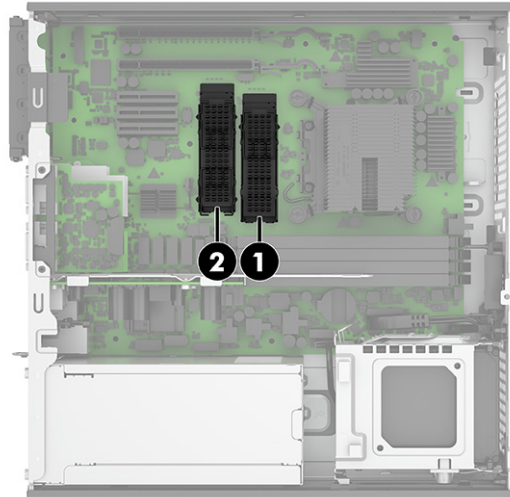

2. Remove the Phillips screw (1) that secures the drive.
3. Rotate the drive upward (2), and then pull the drive (3) out of the socket.

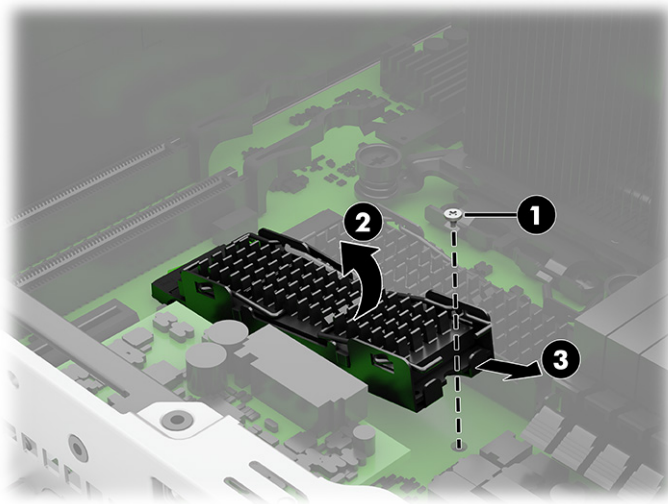

4. To remove the heat sink from the drive, pull all four heat sink arms (1) down slightly, and then pull the arms out of the slots (2) in the bracket.

5. Lift the heat sink (3) off the top of the drive, and then remove the drive (4) from the bracket.

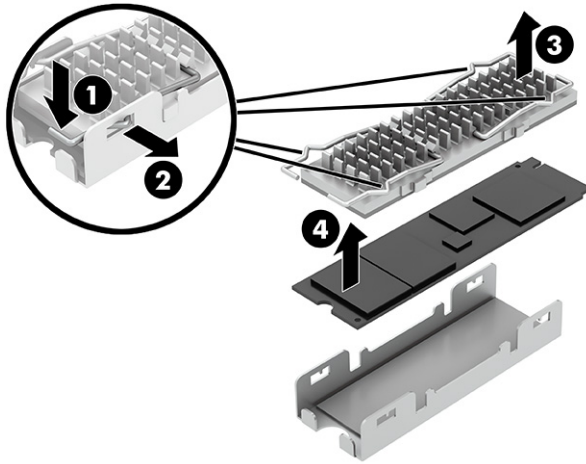

6. When installing a solid-state drive, be sure thermal pads are installed on the inside of the bracket (1) and the bottom of the heat sink (2).

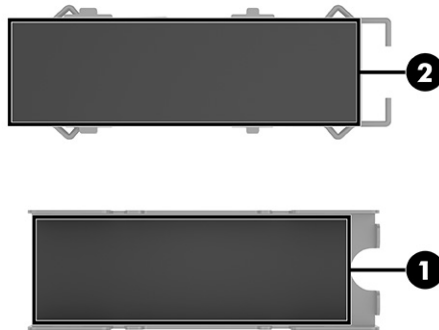

To install the solid-state drive, reverse the removal procedure.

## Hard drive

To remove a hard drive, use these procedures and illustrations.

Before removing the hard drive, follow these steps:

1. Prepare the computer for disassembly (see [Preparation for disassembly on page 18](#)).
2. Remove the access panel (see [Access panel on page 19](#)).

Remove the hard drive:

1. Lift the tab on the back of the drive cage to rotate it to the upright position.

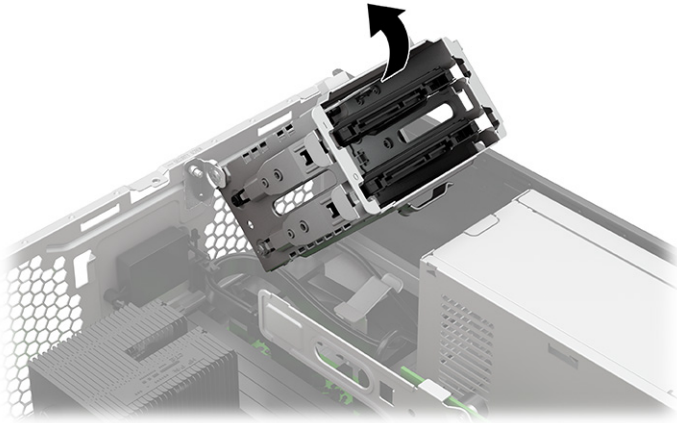

2. Disconnect the power and data cables (1) from the back of the drive.
3. Pull the release lever (2) away from the drive, and then pull the drive up and out of the drive cage (3).

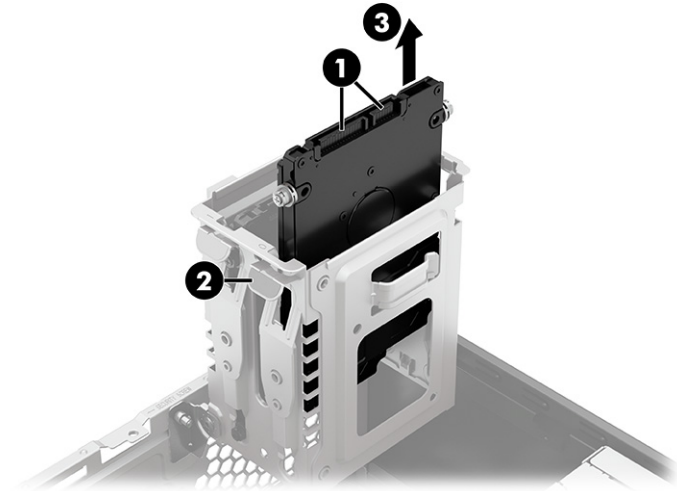

To install the hard drives, reverse the removal procedure.

## Expansion cards

To remove expansion cards, use these procedures and illustrations.

The computer system board has a PCI Express  $\times 16$  expansion slot, a PCI Express  $\times 16$  expansion slot that is downshifted to a  $\times 4$  slot, and two PCI Express  $\times 2$  expansion slots.



**NOTE:** You can install a PCI Express  $\times 1$ ,  $\times 4$ ,  $\times 8$ , or  $\times 16$  expansion card in the PCI Express  $\times 16$  slot.

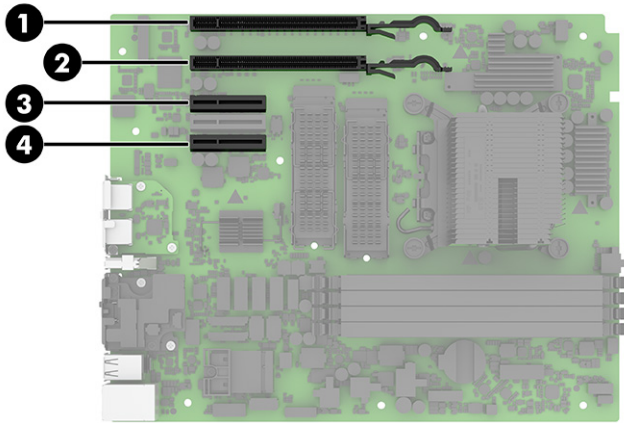

**Table 4-1** Expansion slot locations

Item	Expansion slot
(1)	PCI Express ×16
(2)	PCI Express ×4
(3)	PCI Express ×2
(4)	PCI Express ×2

## Expansion cards

To remove expansion cards, use these procedures and images.

Before removing the expansion cards, follow these steps:

1. Prepare the computer for disassembly (see [Preparation for disassembly on page 18](#)).
2. Remove the access panel (see [Access panel on page 19](#)).

Remove the expansion cards:

1. Release the slot cover retention latch that secures the slot covers by lifting the green tab on the latch and rotating the latch to the open position.

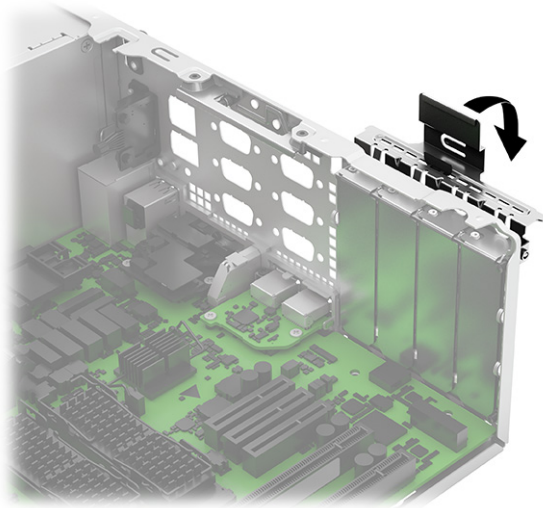

 **NOTE:** Before removing an installed expansion card, disconnect any cables that may be attached to the expansion card.

2. To remove a PCIe card, pull the release arm (1), and then pull the expansion card (2) straight up and then away from the inside of the chassis to release it from the chassis frame. Be sure not to scrape the card against other components.

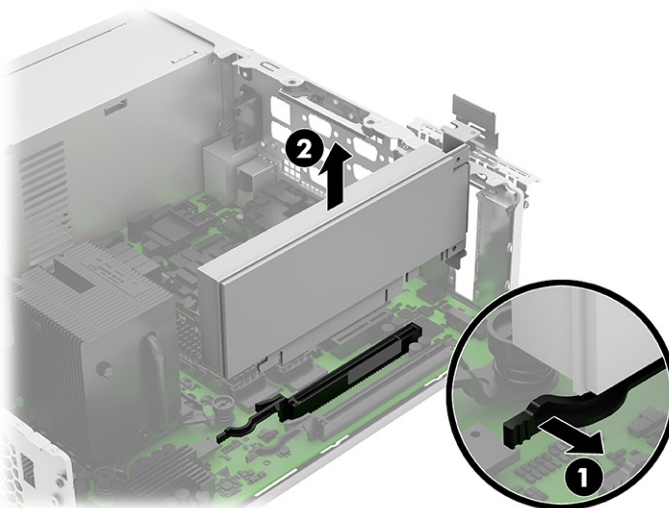

3. To remove a PCI card, pull the expansion card straight up and then away from the inside of the chassis to release it from the chassis frame. Be sure not to scrape the card against other components.

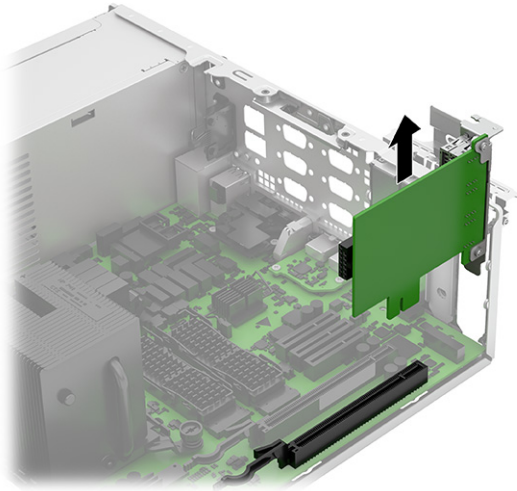

---

**CAUTION:** After removing an expansion card, you must replace it with a new card or expansion slot cover for proper cooling of internal components during operation.

**NOTE:** Store the removed card in antistatic packaging.

---

To install expansion cards, reverse the removal procedure.

## Battery

To remove the battery, use these procedures. The battery that comes with the computer provides power to the real-time clock. When replacing the battery, use a battery equivalent to the battery originally installed in the computer. The computer comes with a 3 V lithium coin cell battery.

---

**WARNING!** The computer contains an internal lithium manganese dioxide battery. There is a risk of fire and burns if the battery is not handled properly. To reduce the risk of personal injury:

- Do not attempt to recharge the battery.
- Do not expose to temperatures higher than 60°C (149°F).
- Do not disassemble, crush, puncture, short external contacts, or dispose of in fire or water.
- Replace the battery only with the HP spare part that is designated for this product.

**IMPORTANT:** Before replacing the battery, back up the computer CMOS settings. When the battery is removed or replaced, the CMOS settings are cleared.

Static electricity can damage the electronic components of the computer or optional equipment. Before beginning these procedures, be sure that you are discharged of static electricity by briefly touching a grounded metal object.

**NOTE:** You can extend the lifetime of the lithium battery by plugging the computer into an AC outlet. The lithium battery is used only when the computer is not connected to AC power.

HP encourages customers to recycle used electronic hardware, HP original print cartridges, and rechargeable batteries. For more information about recycling programs, go to <http://www.hp.com/recycle>.

---

Before removing the battery, follow these steps:

1. Prepare the computer for disassembly (see [Preparation for disassembly on page 18](#)).
2. Remove the access panel (see [Access panel on page 19](#)).

Remove the battery:

1. Press the release lever **(1)**, and then remove the battery **(2)**.

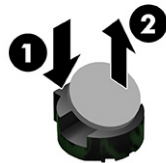

2. Slide the replacement battery into position, positive side up. The battery holder automatically secures the battery in the proper position.

## Front bezel

To remove the front bezel, use this procedure and illustration.

Before removing the front bezel, follow these steps:

1. Prepare the computer for disassembly (see [Preparation for disassembly on page 18](#)).
2. Remove the access panel (see [Access panel on page 19](#)).

Remove the front bezel:

1. If the bezel is locked with a security screw, remove the screw from the top of the bezel.

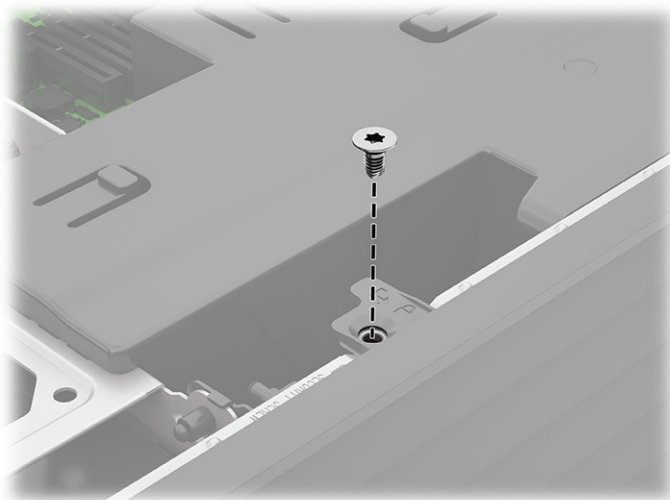

2. If a USB cap is installed, pull the cap off the bezel.

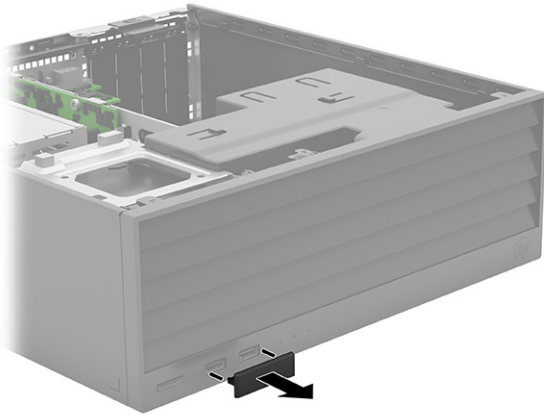

3. Lift the three tabs (1) at the top of the bezel.
4. Rotate the top of the bezel outward (2) and remove it from the computer.

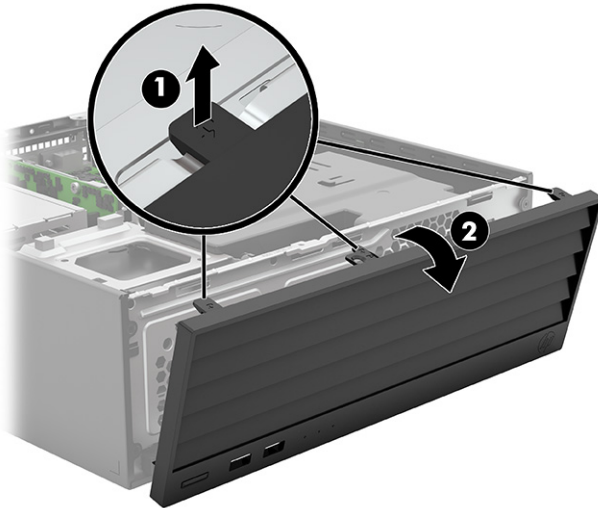

To install the front bezel, reverse the removal procedure.

A security screw is installed under the front bezel in the location shown in the following illustration.

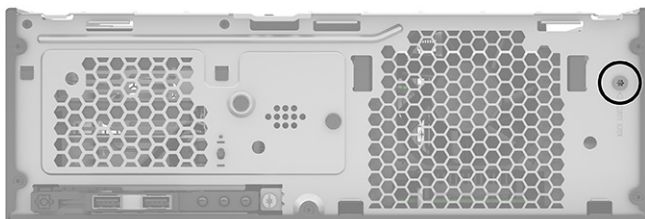

## Fan and duct assembly

To remove the fan with duct, use this procedure and illustration.

Before removing the fan and duct assembly, follow these steps:

1. Prepare the computer for disassembly (see [Preparation for disassembly on page 18](#)).
2. Remove the access panel (see [Access panel on page 19](#)).

Remove the fan and duct assembly:

1. Lift the duct (1) straight up and out of the computer.
2. Disconnect the fan cable from the system board connector labeled CHFAN (2).

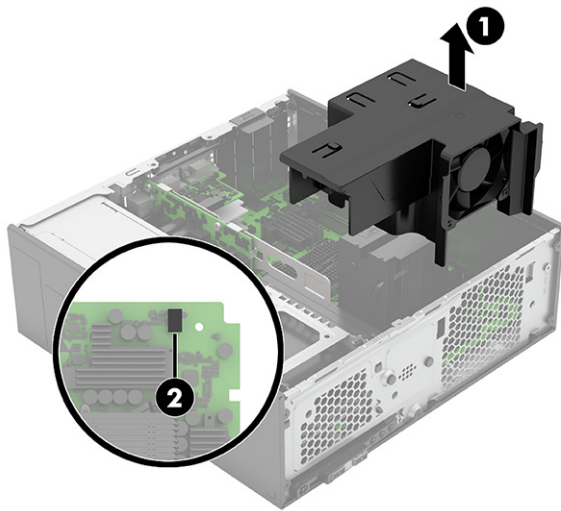

To install the fan and duct assembly, reverse the removal procedure.

When installing the assembly, be sure to slide the tabs on the front of the assembly into the clips on the inside front of the computer chassis.

## Memory modules (DIMMs)

To remove the memory modules, use this information and procedures.

The memory sockets on the system board are populated with at least one preinstalled memory module. To achieve the maximum memory support, you can populate the system board with up to 128 GB of memory configured in a high-performing dual-channel mode.

Supported memory includes:

- 8 GB and 16 GB PC5-4800U, single ranked, 4800 Mbps DDR5, unbuffered, non-ECC DIMMs
- 32 GB PC5-4800U, dual ranked, 4800 Mbps DDR5, unbuffered, non-ECC DIMMs
- 16 GB PC5-4800E, single ranked, 4800 Mbps DDR5, unbuffered, ECC DIMMs
- 32 GB PC5-4800E, dual ranked, 4800 Mbps DDR5, unbuffered, ECC DIMMs
- Single and dual rank, 16 GB based DIMMs

- System ECC is supported on unbuffered ECC DIMMs

 **NOTE:** The system might not operate properly if you install unsupported memory modules.

There are four memory sockets on the system board, with two channels per CPU, two sockets per channel. The sockets are labeled DIMM1, DIMM2, DIMM3, and DIMM4.

For maximum memory performance, evenly distribute total desired memory capacity across all operational channels. Proper individual DIMM capacity selection is essential to maximizing performance.

### Platform capabilities

Although the memory modules can run up to 4800 Mbps, the current platform supports a maximum memory speed of 4400 Mbps.

System speed is determined by several factors.

**Table 4-2 System speed factors**

Module configuration	Description of configuration	Maximum memory speed*
Single DIMM per channel	Configurations with only 1 or 2 DIMM modules installed only in black slots	4400 Mbps
Two single-ranked DIMMs in a channel	Configurations with 3 or 4 single ranked DIMMs (8 GB and 16 GB) installed	4000 Mbps
Two dual-ranked DIMMs in a channel	Configurations with 3 or 4 dual-ranked DIMMs (32 GB) installed	3600 Mbps

\* Actual memory speed is dependent on the processor.

### Recommendations for upgrading memory

To make sure that the system can run at maximum speed:

- Use the same capacity memory that is already installed in the computer.
- Buy modules in pairs.
- Move similar modules into the same channel (memory slots 1 and 2) and install new modules together in the second channel (slots 3 and 4).

### Memory features

- Single-bit errors are automatically corrected.
- Detected multi-bit errors cause the system to immediately reboot and halt with an F1 prompt error message.

 **NOTE:** Although HP does support non-ECC memory on this platform, non-ECC memory does not fully detect or correct single-bit or multi-bit errors, which can cause instability or corruption of data in the platform.

### Loading rules

- Each channel includes two sockets. Load DIMM slots 1 and 3 first, then 2 and 4. Do not load slot 2 unless slot 1 is loaded. Do not load slot 4 unless slot 3 is loaded.

- If mixing dual-ranked and single-ranked DIMMs, load the dual-ranked DIMMs in slots 1 and 2 and load single-ranked DIMMs in slots 3 and 4.

 **NOTE:** Single-channel and unbalanced dual-channel memory configurations results in inferior graphics performance.

 **IMPORTANT:** You must disconnect the power cord and wait approximately 30 seconds for the power to drain before adding or removing memory modules. Regardless of the power state, voltage is always supplied to the memory modules as long as the computer is plugged into an active AC outlet. Adding or removing memory modules while voltage is present can cause irreparable damage to the memory modules or system board.

The memory module sockets have gold-plated metal contacts. When upgrading the memory, it is important to use memory modules with gold-plated metal contacts to prevent corrosion, oxidation, or both resulting from having incompatible metals in contact with each other.

Static electricity can damage the electronic components of the computer or optional cards. Before beginning these procedures, be sure that you are discharged of static electricity by briefly touching a grounded metal object. For more information, see [Electrostatic discharge information on page 10](#).

When handling a memory module, be careful not to touch any of the contacts. Doing so can damage the module.

Before replacing the memory modules, follow these steps:

1. Prepare the computer for disassembly (see [Preparation for disassembly on page 18](#)).
2. Remove the access panel (see [Access panel on page 19](#)).
3. Remove the fan and duct assembly (see [Fan and duct assembly on page 28](#)).

Replace a memory module:

1. To remove a memory module, open both latches (1) of the memory module socket, and then remove the memory module (2) from the socket.

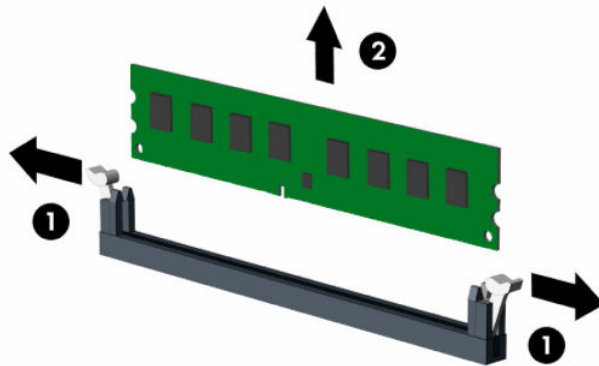

2. To install a memory module, open both latches (1) of the memory module socket, and insert the memory module into the socket (2). Press the module down into the socket so that the module is fully inserted and properly seated. Be sure that the latches (3) are in the closed position.

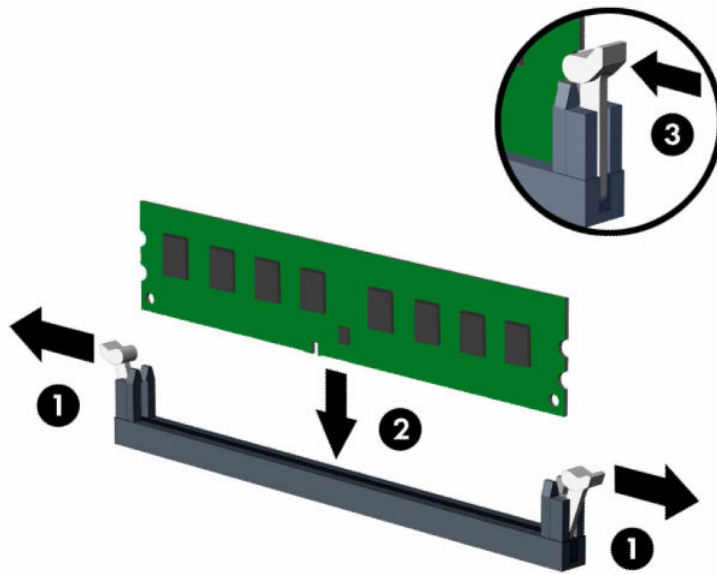

 **NOTE:** A memory module can be installed in only one way. Match the notch on the module with the tab on the memory socket.

The computer automatically recognizes the additional memory when you turn on the computer.

## Heat sink

To remove the heat sink, use this procedure and illustration.

Before removing the heat sink, follow these steps:

1. Prepare the computer for disassembly (see [Preparation for disassembly on page 18](#)).
2. Remove the access panel (see [Access panel on page 19](#)).
3. Remove the fan and duct assembly (see [Fan and duct assembly on page 28](#)).

Remove the heat sink:

1. Loosen the four Torx screws (1) that secure the heat sink to the system board.

2. Remove the heat sink **(2)** from the computer.

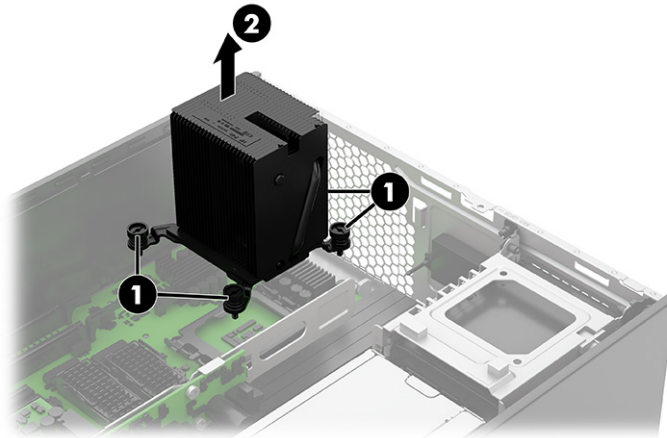

3. Thoroughly clean and replace the thermal grease from the surfaces on the system board and heat sink each time the heat sink is removed. Be sure that thermal grease is installed on the heat sink as shown in the following illustration.

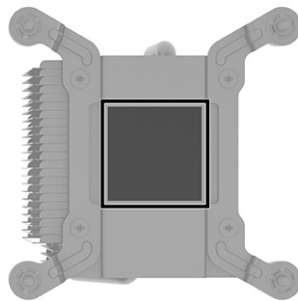

To install the heat sink, reverse the removal procedures.

## Processor

To remove the processor, use these procedures.

Before removing the processor, follow these steps:

1. Prepare the computer for disassembly (see [Preparation for disassembly on page 18](#)).
2. Remove the access panel (see [Access panel on page 19](#)).
3. Remove the fan and duct assembly (see [Fan and duct assembly on page 28](#)).
4. Remove the heat sink (see [Heat sink on page 31](#)).

Remove the processor:

1. Pull the locking lever **(1)** away from the processor, and then rotate the lever to its full open position.
2. Raise and rotate the microprocessor retainer **(2)** to its fully open position.

- Carefully lift the processor **(3)** from the socket.

 **IMPORTANT:** Do not handle the pins in the processor socket. These pins are fragile, and handling them could cause irreparable damage. If pins are damaged, you might have to replace the system board.

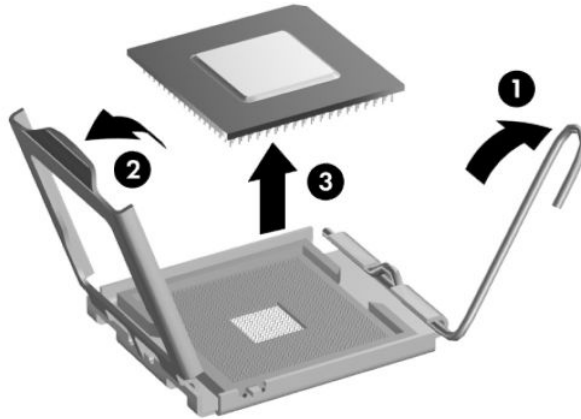

To install the processor, reverse the removal procedures.

 **NOTE:** After installing a new processor onto the system board, update the system ROM to ensure that the computer is using the latest version of the BIOS.

## Front I/O assembly

To remove the front I/O assembly, use this procedure and illustration.

Before removing the front I/O assembly, follow these steps:

- Prepare the computer for disassembly (see [Preparation for disassembly on page 18](#)).
- Remove the access panel (see [Access panel on page 19](#)).
- Rotate the drive cage to the upright position (see [Hard drive on page 21](#)).
- Remove the front bezel (see [Front bezel on page 26](#)).

Remove the front I/O assembly:

- Disconnect the cable from the PB/LED connector **(1)** on system board.
- Disconnect the cable from the FRONT USB3 connector **(2)** on system board.

3. From the front of the computer, remove the Torx screw **(3)** from the front I/O assembly.

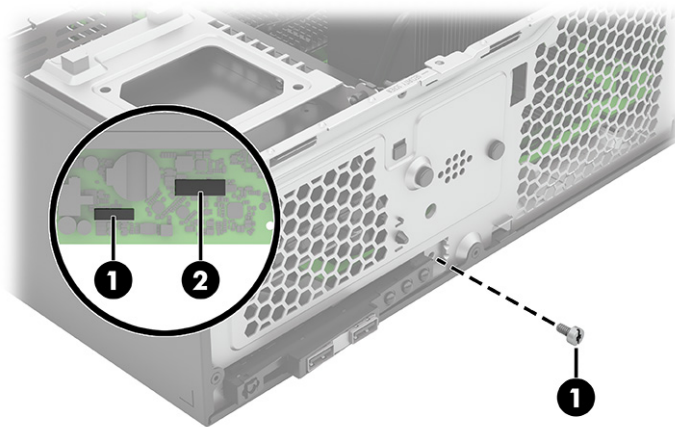

4. Pull the right side of the assembly **(1)** out slightly.
5. Slide the assembly **(2)** toward the right.
6. Pull the assembly and cables **(3)** out of the front of the computer.

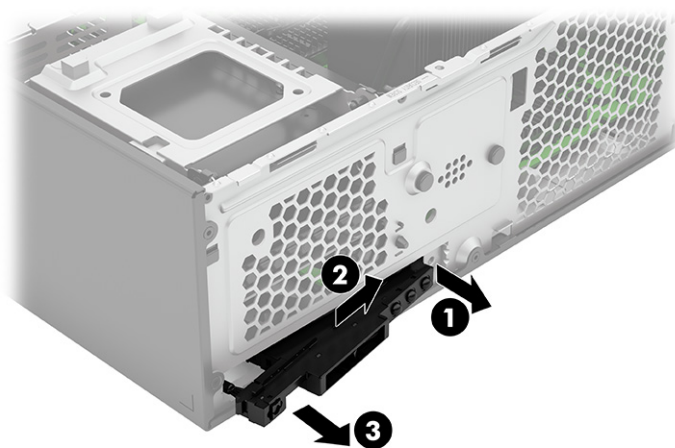

To install the front I/O assembly, reverse the removal procedure.

## Speaker

To remove the speaker, use this procedure and illustration.

Before removing the speaker, follow these steps:

1. Prepare the computer for disassembly (see [Preparation for disassembly on page 18](#)).
2. Remove the access panel (see [Access panel on page 19](#)).
3. Rotate the drive cage to the upright position (see [Hard drive on page 21](#)).

Remove the speaker:

1. Disconnect the speaker cable from the SPKR connector **(1)** on the system board.

2. Under the drive cage, pull the rubber speaker connectors (2) away from each other to release the speaker.
3. Remove the speaker from the connectors (3).

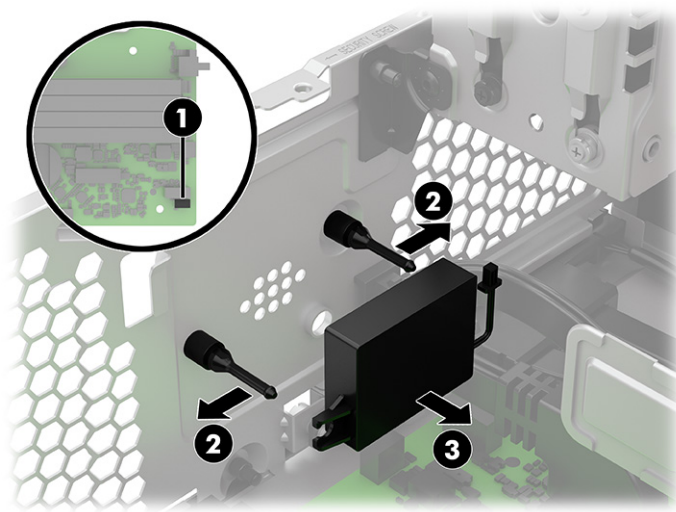

To install the speaker, reverse the removal procedure.

## Powered serial ports

To identify the locations of the powered serial ports, use this illustration and table.

Six powered serial ports are optional on the computer. If your computer is not configured with a powered serial port expansion card, you may purchase one from HP.

The serial ports can be configured as standard (not powered) serial ports or powered serial ports. Some devices use a powered serial port. If the serial port is configured as a powered port, devices that support a powered serial interface do not require an external power source.

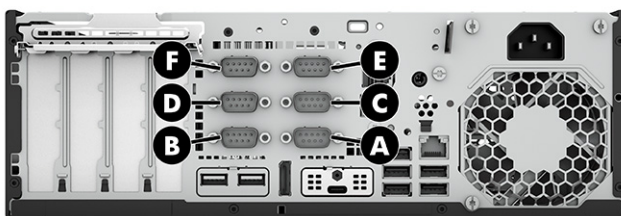

**NOTE:** The computer ships with all serial ports configured in standard serial mode by default unless the powered serial port AV numbers are ordered.

**Table 4-3** Powered serial ports

Item	Powered serial ports		
		+5 V	+12 V
(A)	COM 1	Yes	Yes

**Table 4-3** Powered serial ports (continued)

Item	Powered serial ports		
(B)	COM 2	Yes	Yes
(C)	COM 3	Yes	Yes
(D)	COM 4	Yes	Yes
(E)	COM 5	Yes	Yes
(F)	COM 6	Yes	Yes

The serial ports can be configured using the Computer F10 Setup utility. Under the Onboard Devices menu, you are given the option to select the following three settings for each individual serial port (port A, B, if available C, and D):

- Standard
- 5 V on pins 1 and 9
- 12 V on pins 1 and 9



**NOTE:** To access the Computer Setup (F10) Utility, restart the computer and press the **F10** key as soon as the HP logo screen is displayed (before the computer boots to the operating system).

## Serial port A

To remove serial port A, use this procedure and illustration.

Before removing serial port A, follow these steps:

1. Prepare the computer for disassembly (see [Preparation for disassembly on page 18](#)).
2. Remove the access panel (see [Access panel on page 19](#)).

Remove serial port A:

1. Remove the two hex screws **(1)** from the back of the computer.
2. Disconnect the cable from the COMA connector **(2)** on the system board.

3. Remove the port and cable assembly **(3)** from the computer.

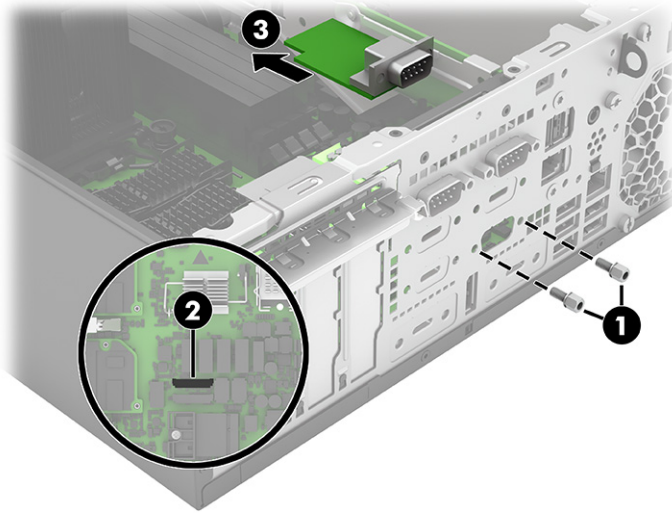

To replace the serial port, reverse this procedure.

## Serial port C/D

To remove the serial port assembly, use this procedure and illustration.

Before removing the serial port assembly, follow these steps:

1. Prepare the computer for disassembly (see [Preparation for disassembly on page 18](#)).
2. Remove the access panel (see [Access panel on page 19](#)).

Remove the serial port assembly:

1. Remove the four hex screws **(1)** from the back of the computer.
2. Disconnect the cable from the COMB connector **(2)** on the system board.
3. Remove the serial port and cable assembly **(3)** from the computer.

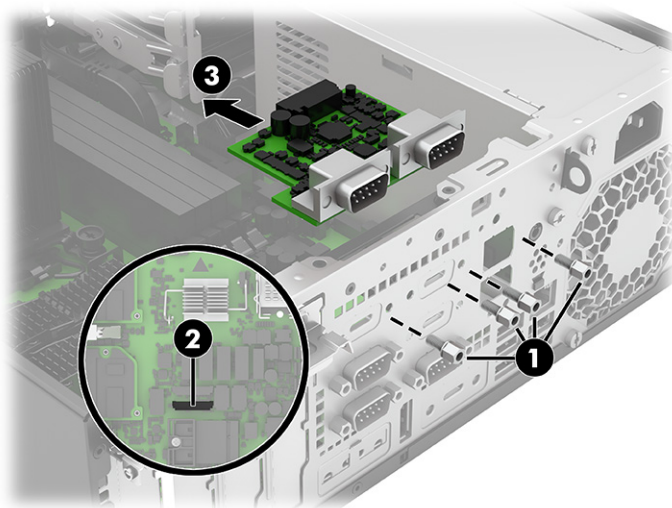

To install the serial port, reverse the removal procedure.

## Cash drawer card

To remove the cash drawer card, use this procedure and illustration.

Before removing the cash drawer card, follow these steps:

1. Prepare the computer for disassembly (see [Preparation for disassembly on page 18](#)).
2. Remove the access panel (see [Access panel on page 19](#)).

Rotate the cash drawer card:

1. Remove the two Torx screws **(1)** from the back of the computer.
2. Disconnect the cable from the +24VUSB/CASHDWR connector **(2)** on the system board.
3. Disconnect the cable from the CASHDWR connector **(3)** on the system board.
4. Remove the assembly **(4)** from the computer.

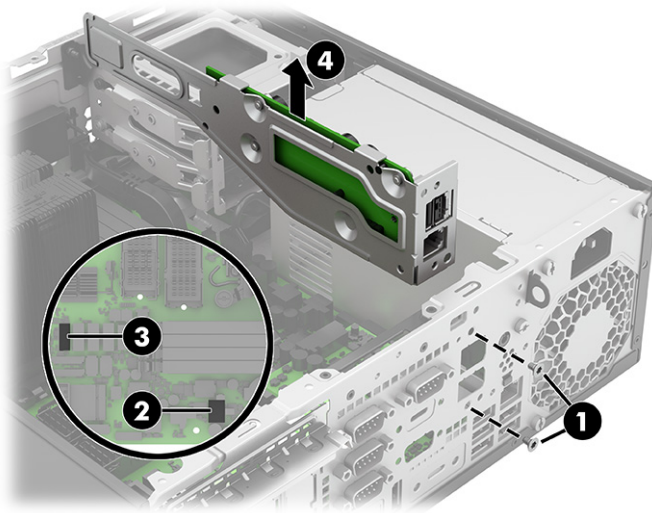

## WLAN module

To remove the WLAN module, use these procedures.

Before removing the WLAN module, follow these steps:

1. Prepare the computer for disassembly (see [Preparation for disassembly on page 18](#)).
2. Remove the access panel (see [Access panel on page 19](#)).
3. Remove the cash drawer card (see [Cash drawer card on page 38](#)).

Remove the WLAN module:

1. Remove the screw **(1)** that secures the module to the computer.
2. Remove the plastic shield **(2)** that covers the antennas.

3. Disconnect the antenna cables (3) from the module.

---

 **NOTE:** The WLAN antenna cable labeled 1/AUX connects to the WLAN module AUX terminal. The WLAN antenna cable labeled 2/MAIN connects to the WLAN module MAIN terminal.

---

4. Pull the module (4) out of the socket.

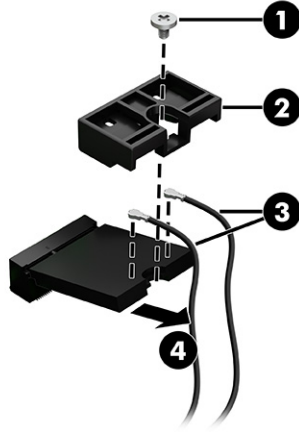

5. If the WLAN antenna is not connected to the terminal on the WLAN module, a protective sleeve must be installed on the antenna connector, as shown in the following illustration.

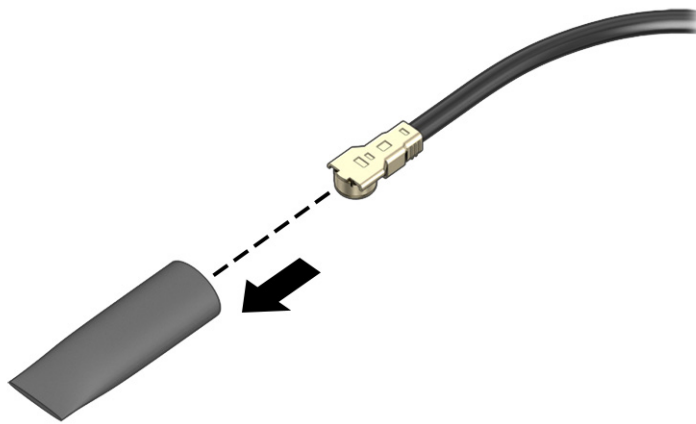

To install the WLAN module, reverse the removal procedure.

---

 **NOTE:** WLAN modules are designed with a notch to prevent incorrect insertion.

---

## Flex card

To remove the flex card, use this procedure and illustration.

Before removing the flex card, follow these steps:

1. Prepare the computer for disassembly (see [Preparation for disassembly on page 18](#)).

2. Remove the access panel (see [Access panel on page 19](#)).

Remove the flex card:

1. Remove two Torx screws **(1)** that secure the card to the rear of the computer.
2. Lift the flex card **(2)** to disconnect it from the system board connector.

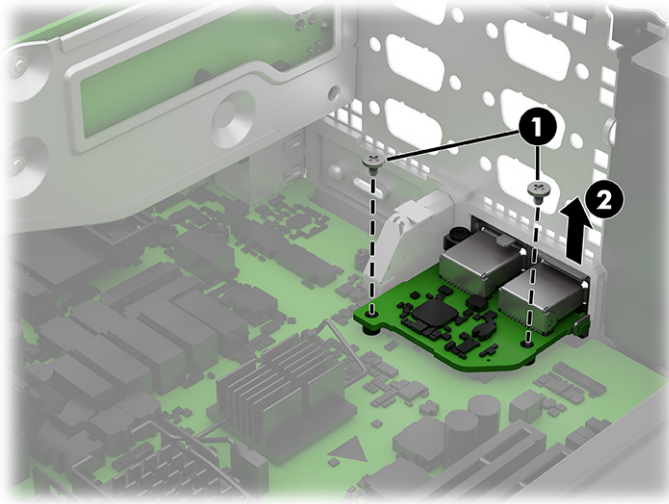

To install the flex card, reverse the removal procedure.

## Rear expansion card

To remove the rear expansion card, use this procedure and illustration.

Before removing the rear expansion card, follow these steps:

1. Prepare the computer for disassembly (see [Preparation for disassembly on page 18](#)).
2. Remove the access panel (see [Access panel on page 19](#)).
3. If installed, remove the serial port (see [Powered serial ports on page 35](#)).

Remove the rear expansion card:

1. Remove the two Phillips screws **(1)** from the card.

2. Lift the card **(2)** up to disconnect it from the connector on the system board.

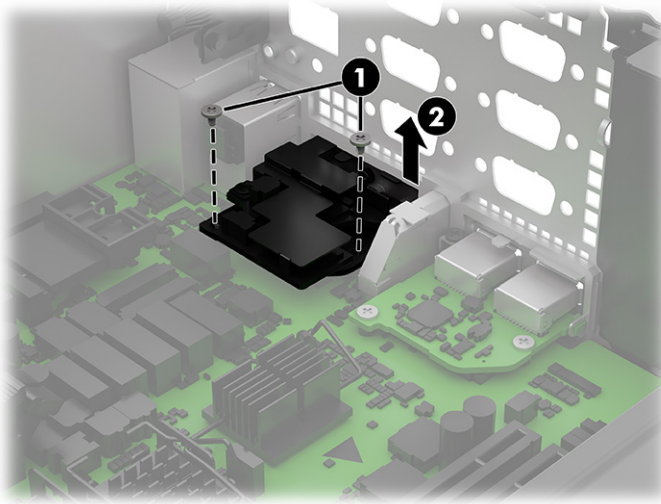

To install the rear expansion card, reverse this procedure.

## Audio board

To remove the audio board, use this procedure and illustration.

Before removing the audio board, follow these steps:

1. Prepare the computer for disassembly (see [Preparation for disassembly on page 18](#)).
2. Remove the access panel (see [Access panel on page 19](#)).

Remove the audio board:

1. Remove Torx screw **(1)** that secures the board to the rear of the computer.
2. Disconnect the audio board cable from the system board connector labeled HDSET **(2)**.
3. Remove the audio board and cable **(3)** from the computer.

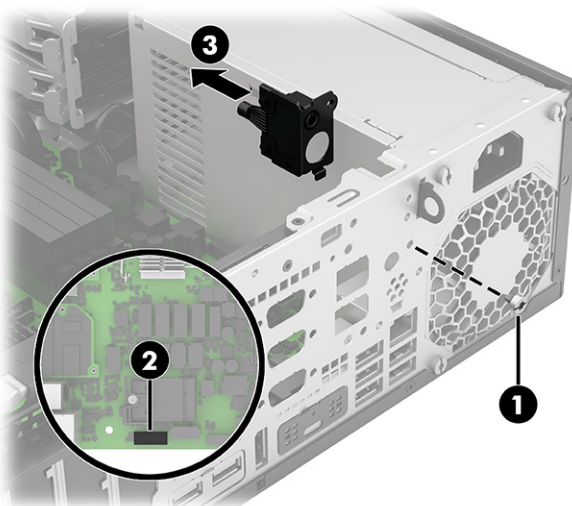

To install the audio board, reverse the removal procedure.

## Power supply

To remove the power supply, use these procedures.

Before removing the power supply, follow these steps:

1. Prepare the computer for disassembly (see [Preparation for disassembly on page 18](#)).
2. Remove the access panel (see [Access panel on page 19](#)).
3. Rotate the drive cage to the upright position (see [Hard drive on page 21](#)).

Remove the power supply:

1. Disconnect the power supply cables from the following system board connectors:  
PWR (1)  
PWRCMD (2)  
PWRCPU (3)

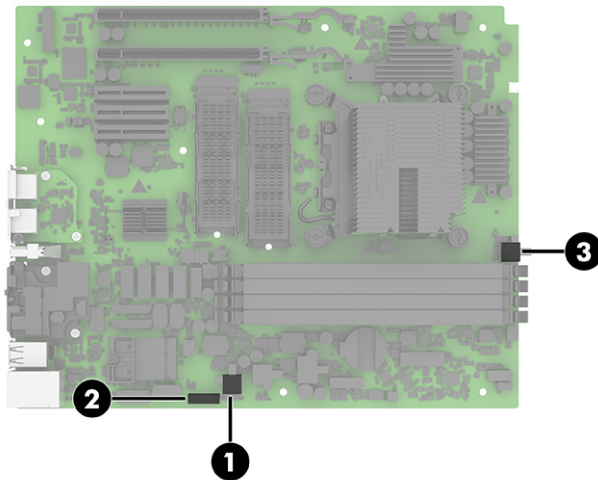

2. Remove the three Torx screws (1) from the back of the computer.
3. Press the release button (2) at the front of the power supply.

4. Slide the power supply forward **(3)**, and then lift it up and out of the computer **(4)**.

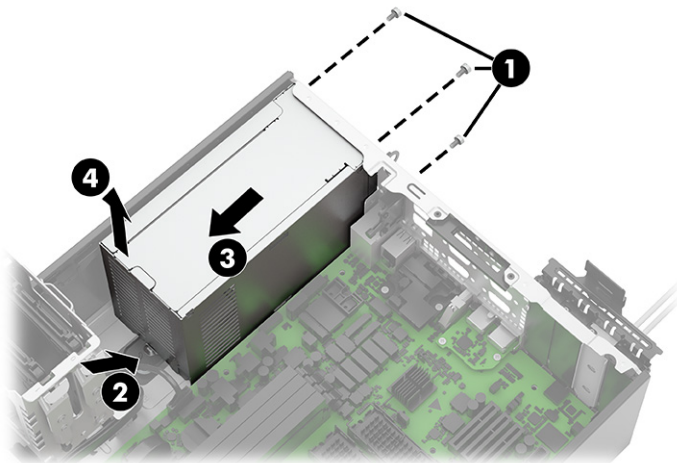

To install the power supply, reverse the removal procedures.

## WLAN antennas and external connectors

To remove the WLAN antennas and external connectors, use this procedure and illustration.

Before removing the WLAN antennas and external connectors, follow these steps:

1. Prepare the computer for disassembly (see [Preparation for disassembly on page 18](#)).
2. Remove the access panel (see [Access panel on page 19](#)).

Remove the WLAN antennas and external connectors:

1. Lift the retainer latch **(1)** on the back of the computer.
2. Lift the antenna connector assembly **(2)** up and out of the slot.
3. Disconnect the antenna cables **(3)** from the WLAN module.
4. Remove the antenna cables from the clip **(4)** on the back of the computer.

5. Remove the connector assembly and cables (5) from the computer.

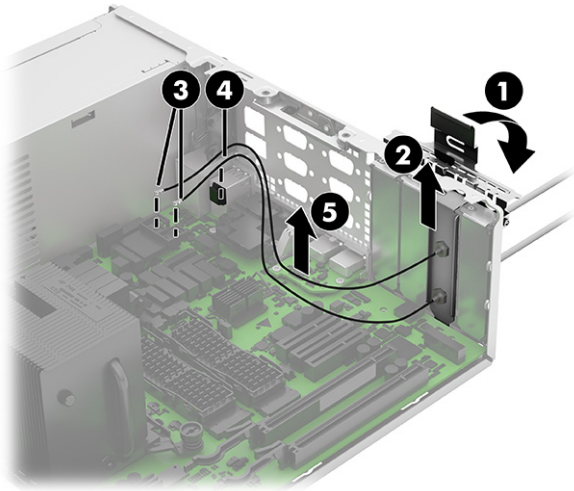

To install the WLAN antennas and external connectors, reverse the removal procedure.

## System board

To remove the system board, use this procedure and illustration.

 **NOTE:** All system board spare part kits include replacement thermal material.

Before removing the system board, follow these steps:

1. Prepare the computer for disassembly (see [Preparation for disassembly on page 18](#)).
2. Remove the access panel (see [Access panel on page 19](#)).
3. Rotate the drive cage to the upright position (see [Hard drive on page 21](#)).
4. Remove the front bezel (see [Front bezel on page 26](#)).
5. Remove the fan and duct assembly (see [Fan and duct assembly on page 28](#)).

When you replace the system board, be sure to remove the following components (as applicable) from the defective system board and install them on the replacement system board:

- Solid-state drive (see [Solid-state drive on page 19](#)).
- Expansion cards (see [Expansion cards on page 22](#)).
- Memory modules (see [Memory modules \(DIMMs\) on page 28](#)).
- Heat sink (see [Heat sink on page 31](#)).
- Processor (see [Processor on page 32](#)).
- WLAN module (see [WLAN module on page 38](#)).
- Rear expansion card (see [Rear expansion card on page 40](#)).

Remove the system board:

1. Disconnect the cables from the following system board connectors:

 **NOTE:** Connected cables might vary.

- (1) CHFAN
- (2) PWRCPU
- (3) LINE OUT2
- (4) SPKR
- (5) FRONT USB3
- (6) PB/LED
- (7) SATA\_PWR1
- (8) PWR
- (9) PWRCMD
- (10) HDSET
- (11) COMB
- (12) COMA
- (13) SATA connectors
- (14) CASH DWR

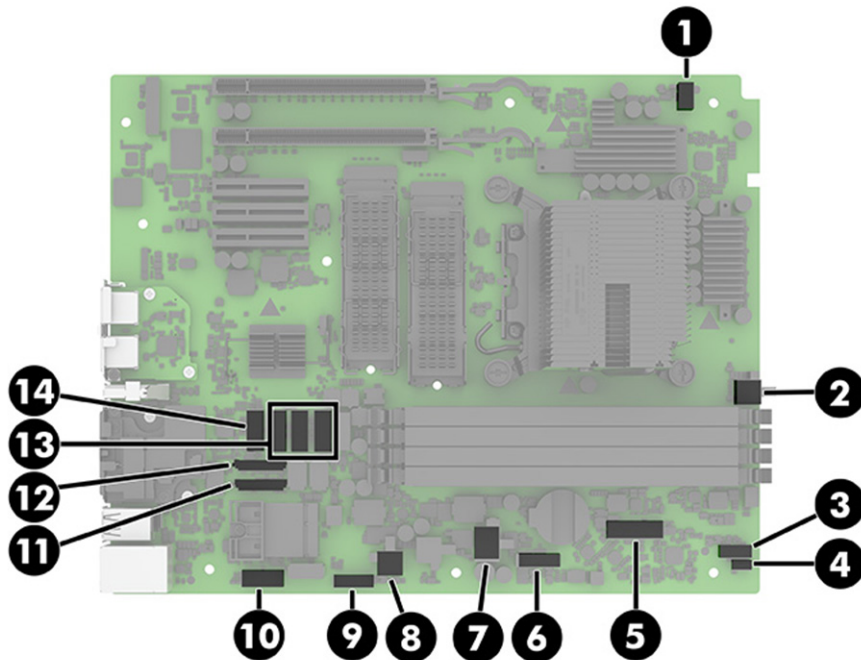

2. Remove the eight Torx screws from the board.

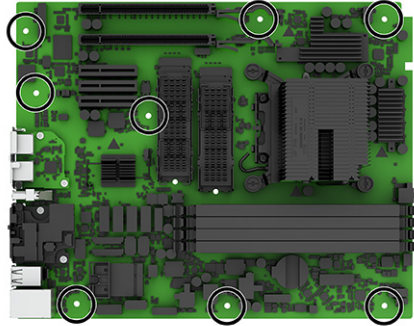

3. Lift the front of the system board (1) up, and then lift the system board out of the computer (2).

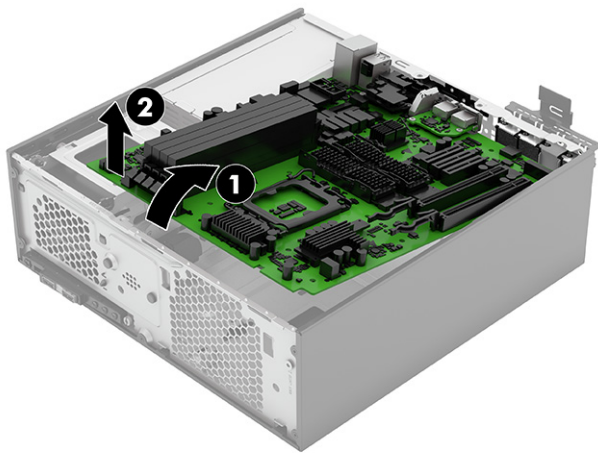

To install the system board, reverse the removal procedure.



**NOTE:** When replacing the system board, you must change the chassis serial number in the BIOS.

When replacing the system board, you must reprogram the SMBIOS information about the affected computer. Failure to reprogram the board will result in eventual failure, such as an activation failure (when you would have to reactivate the computer) or a system recovery failure.

Update the SMBIOS information in Computer Setup.

---

# 5 Computer Setup (F10) Utility

This information provides details of the Computer Setup Utility.

- Change settings from the defaults or restore the settings to default values.
- View the system configuration, including settings for processor, graphics, memory, audio, storage, communications, and input devices.
- Modify the boot order of bootable devices such as hard drives or USB flash media devices.
- Enter the Asset Tag or property identification number assigned by the company to this computer.
- Enable the power-on password prompt during system restarts (warm boots) as well as during startup.
- Establish an administrator password that controls access to the Computer Setup (F10) Utility and the settings described in this section.
- Establish minimum requirements for valid passwords, including length and required types of characters.
- Secure integrated I/O functionality, including the serial, USB, or audio, or embedded NIC, so that they cannot be used until they are unsecured.
- Enable or disable different types of boot sources.
- Configure features such as Secure Boot, power management, virtualization support, and language and keyboard type used in Setup and POST.
- Replicate the system setup by saving system configuration information about a USB device and restoring it on one or more computers.
- Enable or disable DriveLock security or securely erase a hard drive.

## Using Computer Setup (F10) Utilities

You can access Computer Setup only by turning the computer on or restarting the system.

To access the Computer Setup Utilities menu, complete these steps:

1. Turn on or restart the computer.
2. Repeatedly press **f10** when the power button light turns white to access the utility.

You can also press **esc** to see a menu that allows you to access different options available at startup, including the Computer Setup utility.

A choice of four headings appears in the Computer Setup Utilities menu: Main, Security, Advanced, and UEFI Drivers.

---

 **NOTE:** If you do not press **f10** at the appropriate time, you must restart the computer and again repeatedly press **f10** when the power button light turns white to access the utility.

 **NOTE:** Selecting UEFI Drivers restarts the computer into the third-party option ROM management application. You can access this application directly by pressing **f3** during startup.

---

3. Use the arrow (left and right) keys to select the appropriate heading. Use the arrow (up and down) keys to select the option you want, and then press **enter**. To return to the Computer Setup Utilities menu, press **esc**.
4. To apply and save changes, select **Main > Save Changes and Exit**.
  - If you have made changes that you do not want applied, select **Ignore Changes and Exit**.
  - To restore settings from the Advanced and Main menus to original values, select **Apply Factory Defaults and Exit**.
  - To restore settings from the Advanced and Main menus to those previously saved by **Save Custom Defaults**, select **Apply Custom Defaults and Exit**. If no custom defaults have been saved, factory defaults are used.

---

 **NOTE:** You cannot modify settings in the Security menu by selecting **Apply Defaults**. You reset those values by selecting **Restore Security Settings to Factory Defaults** at the bottom of the **Security** menu.

 **NOTE:** Not all settings shown in the following sections are available for all models.

---

 **IMPORTANT:** Do not turn computer power off while the BIOS is saving the Computer Setup (F10) changes because the settings could become corrupted. It is safe to turn off the computer only after exiting the F10 Setup screen.

---

## Computer Setup Main

This table provides information about the Computer Setup Main menu.

---

 **NOTE:** Support for specific Computer Setup options can vary, depending on the hardware configuration.

---

**Table 5-1 Computer Setup Main**

Option	Description
<b>System Information</b>	Lists all information in following list if <b>Advanced System Information</b> is selected. Lists smaller subset if <b>Basic System Information</b> is selected. <ul data-bbox="528 331 954 1682" style="list-style-type: none"><li data-bbox="528 331 708 357">• Product name</li><li data-bbox="528 382 783 407">• Installed memory size</li><li data-bbox="528 432 722 457">• Processor type</li><li data-bbox="528 483 871 508">• Processor cache size (L1/L2/L3)</li><li data-bbox="528 533 740 558">• Processor speed</li><li data-bbox="528 583 762 609">• MicroCode revision</li><li data-bbox="528 634 762 659">• Processor stepping</li><li data-bbox="528 684 719 709">• Memory speed</li><li data-bbox="528 735 927 760">• DIMM size (for each installed module)</li><li data-bbox="528 785 775 810">• System BIOS version</li><li data-bbox="528 835 871 861">• ME Firmware version (Intel only)</li><li data-bbox="528 886 759 911">• Video BIOS version</li><li data-bbox="528 936 804 961">• Reference code revision</li><li data-bbox="528 987 828 1012">• Super I/O firmware version</li><li data-bbox="528 1037 954 1062">• USB Type-C® controller firmware version</li><li data-bbox="528 1087 699 1113">• Born on date</li><li data-bbox="528 1138 708 1163">• Serial number</li><li data-bbox="528 1188 695 1213">• SKU number</li><li data-bbox="528 1239 903 1264">• UUID (Universally Unique Identifier)</li><li data-bbox="528 1289 791 1314">• Asset tracking number</li><li data-bbox="528 1339 699 1365">• Feature byte</li><li data-bbox="528 1390 651 1415">• Build ID</li><li data-bbox="528 1440 715 1465">• Product family</li><li data-bbox="528 1491 730 1516">• System board ID</li><li data-bbox="528 1541 815 1566">• System board CT number</li><li data-bbox="528 1591 676 1617">• Panel type</li><li data-bbox="528 1642 762 1667">• Panel serial number</li><li data-bbox="528 1692 810 1717">• Integrated MAC Address</li></ul>

**Table 5-1 Computer Setup Main (continued)**

Option	Description
<b>System Diagnostics</b>	<p>If the hard drive has the HP Advanced Diagnostics installed, the application launches. If HP Advanced Diagnostics is not installed, a basic version that is built into the BIOS provides the capability to perform the following functions:</p> <ul style="list-style-type: none"><li data-bbox="507 359 676 384">• Memory Test</li><li data-bbox="507 407 719 432">• Hard Drive Check</li><li data-bbox="507 455 647 480">• Language</li></ul>
<b>BIOS Event Log</b>	<p><b>View BIOS Event Log</b></p> <p>Displays a list of events, alerts, or warnings that have been logged since the log was last cleared.</p> <p><b>Export to USB Key</b></p> <p>Saves a file named BiosEventLog.txt containing the log entries to an inserted USB storage device.</p> <p><b>Clear BIOS Event Log on Next Boot</b></p> <p>When selected, the BIOS clears the event log when the user saves and exits. Default is disabled.</p>

**Table 5-1 Computer Setup Main (continued)**

Option	Description
<b>Update System BIOS</b>	<p>Lets you update the system BIOS from <a href="http://www.hp.com">www.hp.com</a> or another network server, from a removable USB drive, or from a file located on the hard drive.</p>
	<p><b>Check [current selection] for BIOS Updates</b></p>
	<p>The string that appears here depends on the setting in <b>BIOS Update Preferences</b>.</p>
	<p><b>Lock BIOS Version</b></p>
	<p>If this option is selected, the system is locked to the current BIOS version, and updates are not allowed.</p>
	<p><b>Native OS Firmware Update Service</b></p>
	<p>Allows the operating system to drive firmware updates (for example, Windows Update).</p>
	<p><b>BIOS Rollback Policy</b></p>
	<ul style="list-style-type: none"><li>• Unrestricted Rollback to older BIOS: Lets you roll back to any previous version of BIOS.</li><li>• Restricted Rollback to older BIOS: If selected, <b>Minimum BIOS Version</b> becomes active, which lets you manually enter the minimum BIOS version that you can roll back to.</li></ul>
	<p><b>Minimum BIOS Version</b></p>
	<p>Defaults to current version. Read-only unless restricted rollback is selected.</p>
	<p><b>Allow BIOS Updates Using a Network</b></p>
	<p>Lets you configure scheduled, automatic BIOS updates through the network.</p>
	<p><b>BIOS Update Preferences</b></p>
	<ul style="list-style-type: none"><li>• Check for Update on Next Reboot: Default is disabled.</li><li>• BIOS Source: Lets you select either HP.com or a custom URL. If <b>Custom URL</b> is selected, <b>Edit Custom URL</b> becomes active. HP recommends using a custom URL only for a managed IT environment.</li></ul>
	<p><b>Automatic BIOS Update Setting</b></p>
	<p>Allows configuration of a periodic check for updates:</p>
	<p><b>NOTE:</b> If Windows BitLocker Drive Encryption (BDE) is enabled, it must be temporarily suspended before the BIOS is flashed.</p>
	<ul style="list-style-type: none"><li>• Do not update</li><li>• Checking for updates and prompt the user to accept or reject the update at that time</li><li>• Checking for updates and install all new versions</li><li>• Checking for updates and install only new versions marked important</li></ul>
	<p><b>BIOS Update Frequency</b></p>
	<ul style="list-style-type: none"><li>• Daily</li><li>• Weekly</li><li>• Monthly (default)</li></ul>

**Table 5-1 Computer Setup Main (continued)**

Option	Description
<b>Update System BIOS</b>	<b>Network Configuration Settings</b>  Lets you configure the network connection to the server that is the host for system firmware updates.  <b>Update BIOS Using Local Media</b>  Lets you access files on either USB storage or the hard drive. The HP BIOS Update and Recovery application included in BIOS Softpaqs at <a href="http://www.hp.com">www.hp.com</a> copies the BIOS file to the correct location on the hard drive or USB device.
<b>Change date and time</b>	Lets you update system date and time.
<b>System IDs</b>	Let you set the following values: <ul style="list-style-type: none"><li>• Asset Tracking Number</li><li>• Ownership Tag</li></ul>
<b>Replicated Setup</b>	<b>Back up current settings to USB device</b>  Saves system configuration to a formatted USB flash media device.  <b>Restore current settings from USB device</b>  Restores system configuration from a USB flash media device.
<b>Save Custom Defaults</b>	Saves the current system configuration settings as the custom default set.
<b>Apply Custom Defaults and Exit</b>	Applies the custom default settings to the computer after rebooting. Does not apply to options in the <b>Security</b> menu.
<b>Apply Factory Defaults and Exit</b>	Restores the factory system configuration settings to the computer after rebooting. Does not apply to options in the <b>Security</b> menu.
<b>Ignore Changes and Exit</b>	Exits Computer Setup without applying or saving any changes.
<b>Save Changes and Exit</b>	Saves changes to current system configuration, exits Computer Setup, and reboots.

## Computer Setup Security

This table provides information about the Computer Setup Security menu.



**NOTE:** Support for specific Computer Setup options can vary, depending on the hardware configuration.

**Table 5-2 Computer Setup Security**

Option	Description
<b>Create BIOS Administrator Password</b>	<p>Lets you set and enable a BIOS administrator password, which controls access to the following features:</p> <ul style="list-style-type: none"><li>• Setup Menu (F10)</li><li>• Third-Party Option ROM Management (F3)</li><li>• Update system ROM</li><li>• WMI commands that change system settings</li><li>• BIOS Configuration Utility (BCU)</li><li>• Alternative power-on password</li></ul> <p><b>NOTE:</b> Creating a BIOS user disables the Fast Boot option.</p>
<b>Change BIOS Administrator Password</b> (This selection is active only if a BIOS administrator password is set.)	<p>Lets you change the BIOS administrator password.</p> <p>You must know the current password to be able to change it.</p>
<b>Create POST Power-On Password</b>	<p>Lets you change or delete power-on password. The power-on password prompt appears after a power cycle or reboot. If the user does not enter the correct power-on password, the unit will not boot.</p>
<b>Change POST Power-On Password</b> (This selection is active only if a BIOS administrator password is set.)	<p>Lets you change the POST power-on password.</p> <p>You must know the current password to be able to change it.</p>
<b>Password Policies</b>	<p>Let you set the guidelines for a valid password. Options include:</p> <ul style="list-style-type: none"><li>• Password minimum length</li><li>• Requires at least one symbol</li><li>• Requires at least one number</li><li>• Requires at least one uppercase character</li><li>• Requires at least one lowercase character</li><li>• Allow spaces</li></ul>
<b>Administrator Authentication Policies</b>	<p>Let you set limitations on some boot features restricting them to admin only, including:</p> <ul style="list-style-type: none"><li>• Prompt for administrator authorization to access:<ul style="list-style-type: none"><li>– Boot menu in POST</li><li>– System Recovery</li><li>– Network boot</li><li>– BIOS update</li></ul></li><li>• Allow the use of administrator credentials to modify the power-on password.</li></ul>

**Table 5-2 Computer Setup Security (continued)**

Option	Description
<b>Security Configuration</b>	<b>TPM Embedded Security</b>
	<ul style="list-style-type: none"> <li data-bbox="507 310 1406 384">● <b>TPM Specification Version</b> Displays the current Trusted Platform Module (TPM) version.</li> <li data-bbox="507 411 1406 485">● <b>TPM Device</b> Lets you set the TPM as available or hidden. Default is available.</li> <li data-bbox="507 512 1406 585">● <b>TPM State</b> Select to enable the TPM. Default is disabled.</li> <li data-bbox="507 613 1406 779">● <b>Clear TPM</b> Select to reset the TPM to an unowned state. After the TPM is cleared, it is also turned off. To temporarily suspend TPM operations, turn the TPM off instead of clearing it. Default is no. <b>IMPORTANT:</b> Clearing the TPM resets it to factory defaults and turns it off. You will lose all created keys and data protected by those keys.</li> <li data-bbox="507 806 1406 978">● <b>TPM Activation Policy</b> <ul style="list-style-type: none"> <li data-bbox="555 856 692 877">○ F1 to boot</li> <li data-bbox="555 905 863 926">○ Allow user to reject (default)</li> <li data-bbox="555 953 715 974">○ No prompts</li> </ul> </li> </ul>
	<b>BIOS Sure Start</b>
	<ul style="list-style-type: none"> <li data-bbox="507 1056 1321 1077">● Verify Boot Block on every boot: Select to enable HP Sure Start. Default is disabled.</li> <li data-bbox="507 1104 1437 1230">● BIOS Data Recovery Policy: Select Automatic or Manual to determine data recovery process. Manual recovery is intended only for situations when you want forensic analysis before HP Sure Start recovery. When this policy is set to manual, HP Sure Start will not correct any issues that are found until the local user enters the manual recovery key sequence. This can result in a computer that cannot boot until the manual recovery key sequence is entered.</li> <li data-bbox="507 1257 1437 1331">● Network Controller Configuration Restore: Select to restore the network controller parameters to the factory state saved in the HP Sure Start Private nonvolatile (flash) memory. This setting is available only on computers with built-in NIC. <b>NOTE:</b> This process can take up to 30 seconds. You need to restore this only when the Network Controller Configuration mismatch warning is set.</li> <li data-bbox="507 1430 1414 1482">● Dynamic Runtime Scanning of Boot Block: Verifies the integrity of the BIOS boot block region several times each hour while the computer is running. Default is enabled.</li> <li data-bbox="507 1509 1437 1583">● Sure Start BIOS Settings Protection: When enabled, HP Sure Start locks all critical BIOS settings and provides enhanced protection for these settings using nonvolatile (flash) memory. Default is off. <b>NOTE:</b> An administrator password must be set to activate this setting.</li> <li data-bbox="507 1656 1437 1709">● Sure Start Secure Boot Keys Protection: Saves a backup copy of Secure Boot Keys so that they can be recovered if someone attempts to alter them in an unauthorized manner.</li> <li data-bbox="507 1736 1430 1829">● Enhanced HP Firmware Runtime Intrusion Prevention and Detection: Enables monitoring of HP system firmware executing out of main memory while the operating system is running. Any anomalies detected in HP system firmware that is active while the operating system is running will result in a Sure Start security event being generated.</li> </ul>

**Table 5-2 Computer Setup Security (continued)**

Option	Description
<b>Security Configuration</b>	<ul style="list-style-type: none"> <li>• Sure Start Security Event Policy. Controls HP Sure Start behavior upon identifying a critical security event, such as any modification to HP firmware, while the operating system is running.               <ul style="list-style-type: none"> <li>– Log Event Only: HP Sure Start will log all critical security events in the HP Sure Start audio log within the HP Sure Start nonvolatile (flash) memory.</li> <li>– Log Event and notify user: In addition to logging all critical security events, HP Sure Start will notify the user within the operating system that a critical event has occurred.</li> <li>– Log Event and power off system: In addition to logging all critical security events, HP Sure Start turns off the computer upon detecting a HP Sure Start Security Event. Because of the potential for data loss, HP recommends this setting only in situations where security integrity of the system is a higher priority than the risk of potential data loss.</li> </ul> </li> <li>• Sure Start Security Event Boot Notification: Lets you enable a warning message on the startup screen if a Sure Start event, such as BIOS recovery or Memory intrusion, occurs.</li> </ul>
	<p><b>Secure Boot Configuration.</b></p>
	<p>Lets you be sure that an operating system is legitimate before booting to it, making Windows resistant to malicious modification from preboot to full operating system booting, preventing firmware attacks. UEFI and Windows Secure Boot only allow code signed by preapproved digital certificates to run during the firmware and OS boot process.</p>
	<p><b>NOTE:</b> An administrator password must be set to activate this setting. Secure Boot must also be enabled.</p>
	<ul style="list-style-type: none"> <li>• Secure Boot: Default is disabled.</li> <li>• Secure Boot Key Management: Lets you manage the custom key settings.</li> </ul>
	<p><b>NOTE:</b> Access to these settings requires Sure Start Secure Boot Keys Protection to be disabled.</p>
	<ul style="list-style-type: none"> <li>– Import Custom Secure Boot Keys: Default is disabled.</li> <li>– Clear Secure Boot keys: Lets you delete any previously loaded custom boot keys. Clearing keys will disable secure boot. Default is disabled.</li> <li>– Reset Secure Boot keys to factory defaults: Default is disabled.</li> <li>– Enable MS UEFI CA key: Disabling this setting alters the Secure Boot key list to further restrict the allowed software components. Set this option to disable to support Device Guard. Default is enabled.</li> <li>– Ready BIOS for Device Guard Use: Requires BIOS Administrator password to be configured and Secure Boot to be enabled.</li> </ul>

**Table 5-2 Computer Setup Security (continued)**

Option	Description
<b>Security Configuration</b>	<p data-bbox="507 262 847 283"><b>Secure Platform Management (SPM)</b></p> <ul style="list-style-type: none"> <li data-bbox="507 310 1270 331">• SPM Current State: Displays the current state. Also lets you change the state.</li> <li data-bbox="507 359 1422 411">• Unprovision SPM: Deprovisions SPM, which causes HP Sure Run to revert to the inactive state and return HP Sure Recover to default settings.</li> <li data-bbox="507 438 1342 459">• HP Sure Run Current State: Displays the current state. Also lets you change the state.</li> </ul> <p data-bbox="552 487 1289 508">Deactivate HP Sure Run: Deactivates HP Sure Run without deprovisioning SPM.</p> <ul style="list-style-type: none"> <li data-bbox="507 535 746 556">• Smart Health Enable</li> <li data-bbox="507 583 1283 604">• EBAM Current State: Displays the current state. Also lets you change the state.</li> </ul> <p data-bbox="552 632 1203 653">Disable EBAM: Disables Enhanced BIOS Authentication Mode (EBAM).</p> <ul style="list-style-type: none"> <li data-bbox="507 680 1310 701">• Deactivate HP Sure Run: Requires BIOS Administrator password to be configured.</li> <li data-bbox="507 728 1390 749">• Local Access Key: Indicates that the key is present. Also lets you clear the keys and reboot.</li> </ul> <p data-bbox="552 777 1433 829">Clear EBAM Local Access Keys and Reboot: Deletes all currently established local access keys created for Enhanced BIOS Authentication Mode (EBAM).</p> <p data-bbox="507 856 1436 930"><b>Physical Presence Interface:</b> When set to enabled, the user is notified at system power up when changes are made to system security policy. The user must manually agree to those changes before the change is confirmed. Default is enabled.</p> <p data-bbox="507 957 1414 1010"><b>Smart Cover:</b> The Smart Cover Lock (select products only) is a software-controllable solenoid lock that restricts unauthorized access to the system's internal components.</p> <ul style="list-style-type: none"> <li data-bbox="507 1037 826 1058">• Cover Lock: Default is unlock.</li> <li data-bbox="507 1085 1414 1138">• Cover Removal Sensor: Lets you disable the cover sensor or configure what action is taken if the computer cover is removed. Default is disabled.</li> </ul> <p data-bbox="552 1165 1436 1218"><b>NOTE:</b> <b>Notify user</b> alerts the user with a POST error on the first boot after the sensor detects removal of the cover. If the password is set, <b>Administrator Password</b> requires that the password be entered to boot the computer if the sensor detects that the cover has been removed.</p> <p data-bbox="507 1245 836 1266"><b>Trusted Execution Technology (TXT)</b></p> <p data-bbox="507 1293 1329 1314">Enables Trusted Execution Technology on select Intel-based systems. Default is disabled.</p> <p data-bbox="507 1341 1377 1394"><b>NOTE:</b> Enabling this feature disables OS management of the Trusted Platform Module (TPM), prevents a reset of the TPM, and constrains the configuration of VTx, VTd, and TPM.</p> <p data-bbox="507 1421 863 1442"><b>Intel Software Guard Extensions (SGX)</b></p> <p data-bbox="507 1470 1394 1543">Intel SGX is a set of processor code instructions that allows user-level code to allocate private regions of memory. Unlike normal process memory, SGX protects these private memory regions from processes running at higher privilege levels.</p> <ul style="list-style-type: none"> <li data-bbox="507 1570 711 1591">• Software control</li> <li data-bbox="507 1619 624 1640">• Disable</li> <li data-bbox="507 1667 619 1688">• Enable</li> </ul> <p data-bbox="507 1715 1078 1736"><b>Full encryption of main memory (DRAM) (select products only)</b></p> <p data-bbox="507 1764 1225 1785">When selected, the computer stores all data to DRAM in an encrypted format.</p>

**Table 5-2 Computer Setup Security (continued)**

Option	Description
<b>Utilities</b>	<p><b>Hard Drive Utilities</b></p> <ul style="list-style-type: none"> <li> <p><b>Save/Restore GPT of System Hard Drive</b></p> <p>Enabling this feature saves the GUID Partition Table (GPT) of the system hard drive. If the GPT is subsequently changed, the user is prompted to choose whether to restore GPT. Default is disabled.</p> </li> <li> <p><b>Boot Sector (GPT) Recovery Policy</b></p> <p>Allows selection of the default action when a GPT event occurs.</p> </li> <li> <p><b>DriveLock/Automatic DriveLock</b></p> <p>Allows you to assign or modify a master or user password for hard drives. When this feature is enabled, the user is prompted to provide one of the DriveLock passwords during POST. If neither is successfully entered, the hard drive remains inaccessible until one of the passwords is successfully provided during a subsequent cold-boot sequence.</p> <p><b>NOTE:</b> This selection appears only when at least one drive that supports the DriveLock feature is attached to the system.</p> <p><b>IMPORTANT:</b> Be aware that these settings take place immediately. It is not necessary to save.</p> <p><b>IMPORTANT:</b> Be sure to document the DriveLock password. Losing a DriveLock password will render a drive permanently locked.</p> <p><b>NOTE:</b> Disable DriveLock on NVMe® drives before using applications for hardware-based encryption. After you select a drive, the following options are available:</p> <ul style="list-style-type: none"> <li>– Set DriveLock Master Password. Sets the drive's master password but does not enable DriveLock.</li> <li>– Enable DriveLock. Sets the drive's user password and enables DriveLock.</li> </ul> </li> <li> <p><b>Secure Erase</b></p> <p>Lets you select a hard drive to completely erase.</p> <p>After you erase a hard drive with a program that uses Secure Erase firmware commands, no file recovery program, partition recovery program, or other data recovery method can extract data from the drive.</p> </li> <li> <p><b>Allow OPAL Hard Drive SID Authentication</b></p> <p>BIOS supports drive encryption using the DriveLock feature by creating the storage device's ownership key. If BIOS creates the key, any third-party applications (including other encryption software) are not allowed to perform certain drive operations such as establishing their own key using SID. Encryption software applications may or may not be limited by SID authentication lockout depending on how they are designed. Default is disabled.</p> </li> </ul>
<b>Absolute Persistence Module Current State</b>	<p>Shows the current state of the Absolute Persistence module.</p> <p>Yes: Disabled</p> <p>No: Available</p>
<b>System Management Command</b>	<p>Allows authorized personnel to reset security settings during a service event. Default is enabled.</p>
<b>Restore Security Settings to Factory Default</b>	<p>This action resets security devices, clears BIOS passwords (not including DriveLock), and restores settings in the <b>Security menu</b> to factory defaults.</p>

# Computer Setup Advanced

This table provides information about the Computer Setup Advanced menu.



**NOTE:** Support for specific Computer Setup options can vary, depending on the hardware configuration.

**Table 5-3 Computer Setup Advanced (for advanced users)**

Option	Heading
Display Language	Lets you select the language of the menus in F10 Setup and the keyboard layout.
Scheduled Power-On	This feature wakes the system when it is off at a specified date and time.
Boot Options	Select the devices that the computer can boot from, as well as other options, including: <ul style="list-style-type: none"><li>• Startup Delay (sec): Enabling this feature adds a user-specified delay to the POST process. One purpose for the delay is to provide additional time to activate hotkeys such as <b>esc</b> for the Startup Menu or <b>f10</b> for Computer Setup.</li><li>• Fast Boot: Default is enabled.</li><li>• CD-ROM Boot (select products only): Default is enabled.</li><li>• USB Storage Boot: Default is enabled.</li><li>• Network (PXE) Boot: Default is enabled.</li><li>• After Power Loss: Default is Power Off.<ul style="list-style-type: none"><li>■ Power off: Causes the computer to remain off when power is restored.</li><li>■ Power on: Causes the computer to turn on automatically as soon as power is restored.</li><li>■ Previous state: Causes the computer to turn on automatically as soon as power is restored, if it was on when power was lost.</li></ul></li></ul> <p><b>NOTE:</b> If the system is configured to Power On from Keyboard Ports (see Power Management Options), this setting is forced to Power On.</p> <ul style="list-style-type: none"><li>• Prompt on Memory Size Change: Default is enabled.</li><li>• Prompt on Fixed Storage Change: Default is disabled.</li><li>• Audio Alerts During Boot: Default is enabled. When disabled, most audible beeps from errors, warnings, and password prompts during boot up are suppressed.</li><li>• Numlock on at boot: Default is disabled.</li><li>• UEFI Boot Order: Specify the order in which UEFI boot sources are checked for a bootable operating system image. The default boot order is:<ol style="list-style-type: none"><li>1. USB</li><li>2. SATA DVD</li><li>3. SATA hard drives</li><li>4. M.2 devices</li><li>5. Network boot</li></ol></li></ul>

**Table 5-3 Computer Setup Advanced (for advanced users) (continued)**

Option	Heading
<b>Boot Options</b>	<b>NOTE:</b> Use the UP and DOWN arrows to highlight an item. Press <b>enter</b> to select. Use the UP and DOWN arrows to move a selected item. Press <b>f5</b> to enable or disable. Press <b>esc</b> to exit.
	<b>NOTE:</b> MS-DOS drive lettering assignments might not apply after a non-MS-DOS operating system has started.
	<b>Shortcut to Temporarily Override Boot Order</b>  To boot <b>one time</b> from a device other than the default device specified in Boot Order, restart the computer and press <b>esc</b> (to access the Startup menu) and then <b>f9</b> (Boot Menu), or only <b>f9</b> (skipping the Startup menu) when the power button light turns white. After POST is completed, a list of bootable devices is displayed. Use the arrow keys to select the preferred bootable device and press <b>enter</b> . The computer then boots from the selected non-default device for this one time.
<b>HP Sure Recover</b>	<b>HP Sure Recover</b>
	If enabled and HP Sure Recover is launched, the system firmware honors local and remote requests to reinstall the operating system. If it is disabled, all requests to reinstall the operating system are ignored. Default is enabled.
	<b>Recover from Network</b>
	Allows system firmware to retrieve the recovery agent from the network. If disabled, system firmware retrieves the recovery agent from a local drive. Default is enabled.
	<b>Recover after Boot Failure</b>
	If enabled and no bootable UEFI operating system is found, system firmware launches HP Sure Recover. Default is disabled.
	<b>Recover before Boot Failure Recovery</b>
	If enabled and HP Sure Recover is launched because of a boot failure, the user is notified of the boot failure and asked to choose whether to start or cancel HP Sure Recover. This setting is displayed only if <b>Recover after Boot Failure</b> is selected.
	<b>Recovery Agent</b>
	Displays recovery agent information. This information is displayed only if <b>Recover from Network</b> is selected.
<b>Recovery Image</b>	
Displays recovery image information. This information is displayed only if <b>Recover from Network</b> is selected.	
<b>OS Recovery Image Version.</b>	
Display the version of the recovery image stored in the embedded secure storage device. This information is displayed only if an embedded secure storage device is installed.	
<b>OS Recovery Driver Version</b>	
Display the version of the recovery driver stored in the embedded secure storage device. This information is displayed only if an embedded secure storage device is installed.	

**Table 5-3 Computer Setup Advanced (for advanced users) (continued)**

Option	Heading
<b>System Options</b>	<b>Configure storage controller for Intel Optane™</b> (Intel products only)
	Enables the Intel Optane™ memory module.
	<b>Configure storage controller for RAID</b>
	Enables RAID. Default is enabled.
	<b>Limit PCIe Speed</b> (workstation models only)
	Lets you restrict the maximum speed of the PCI Express devices to previous generations. The following settings are possible:
	- Auto
	- Gen 1 (2.5 Gbps)
	- Gen 2 (5 Gbps)
	- Gen 3 (8 Gbps)
	<b>Turbo-boost</b> (Intel products only)
	Allows Intel Turbo Boost Technology to improve performance when operation conditions allow. Default is enabled.
	<b>Hyperthreading</b> (Intel products only)
	Lets you control processor capability. Default is enabled.
	<b>Virtualization Technology (VTx)</b> (Intel only)
	Controls the virtualization features of the processor. Changing this setting requires turning the computer off and then back on. Default is disabled.
<b>Virtualization Technology for Directed I/O (VTd)</b> (Intel only)	
Controls virtualization DMA remapping features of the chipset. Changing this setting requires turning the computer off and then back on. Default is disabled.	
<b>SVM CPU Virtualization</b> (AMD® products only)	
Enables AMD-V and AMD-Vi virtualization features on AMD-based systems	
<b>Enhanced Hello Sign-in</b> (systems with supporting hardware for biometric identification only)	
Allows for secure logon using the Windows Hello feature.	
<b>DMA Protection</b>	
Enables DMA redirection using IOMMU for enhanced security. Default is enabled.	
<b>NOTE:</b> Requires that VTd is enabled.	
<b>Pre-boot DMA protection</b>	
Secures memory access through DMA to allowed regions prior to operating system startup.	
<b>Full encryption of main memory (DRAM)</b> (select products only)	
Stores all data to DRAM in an encrypted format. Default is enabled.	
<b>PCI slots</b> (vary by product)	
Lets you enable or display PCI slots. Default is enabled.	

**Table 5-3 Computer Setup Advanced (for advanced users) (continued)**

Option	Heading
<b>System Options</b>	<p data-bbox="528 260 772 281"><b>M.2 slots</b> (vary by product)</p> <p data-bbox="528 310 1038 331">Lets you enable or display M.2 slots. Default is enabled.</p> <p data-bbox="528 361 1275 382"><b>Performance Control</b> (High Performance Mode/Performance Mode/Quiet Mode)</p> <p data-bbox="528 411 1382 457">Select <b>Quiet Mode</b> to prioritize acoustics. Select <b>Performance Mode</b> for a balance between, performance and acoustics. Select <b>High Performance Mode</b> to prioritize performance.</p> <p data-bbox="528 487 1018 508"><b>Power Button Override</b> (disable/4 sec/15 sec/30 sec)</p> <p data-bbox="528 537 1445 583">Lets you enable and select the number of seconds you have to hold down the power button for it to force the system to turn off. Default is 4 sec.</p> <p data-bbox="528 613 1267 634"><b>USB Type-C Connector System Software Interface (UCSI)</b> (select products only)</p> <p data-bbox="528 663 1118 684">Allows UCSI to be exposed to the operating system (ACPI table).</p> <p data-bbox="528 714 730 735"><b>HP Application Driver</b></p> <p data-bbox="528 764 1386 810">Provides ACPI structure to enable HP common software application framework. The driver is provided in the latest HP support software that you can download from the web.</p> <p data-bbox="528 835 1437 882"><b>NOTE:</b> Device Manager shows an alert if this setting is enabled without the HP application driver installed.</p> <p data-bbox="528 911 639 932"><b>AMD DASH</b></p> <p data-bbox="528 961 1286 982">Lets you enable AMD Remote system management capability. Default is disabled.</p> <p data-bbox="528 1012 967 1033"><b>Hardware enabled Spectre Variant 2 Mitigation</b></p> <p data-bbox="528 1062 1445 1108">Enables Single Thread Indirect Branch Predictor (STIBP) functionality in AMD processors. Default is disabled.</p>

**Table 5-3 Computer Setup Advanced (for advanced users) (continued)**

Option	Heading
<b>Built-In Device Options</b>	<p data-bbox="504 260 954 281"><b>Embedded LAN Controller</b> (select products only)</p> <p data-bbox="504 310 1147 331">Select to show the device in the operating system. Default is enabled.</p> <p data-bbox="504 361 635 382"><b>Wake On LAN</b></p> <p data-bbox="504 411 1417 457">Lets you either disable the Wake On LAN feature or configure where the computer boots, including the network or hard drive. Default is boot to network.</p> <p data-bbox="504 487 959 508"><b>LAN Controller Option (1)(2)</b> (select products only)</p> <p data-bbox="504 537 1206 558">Enables the integrated network controller in the designated rear option slot.</p> <p data-bbox="504 588 807 609"><b>Dust Filter</b> (select products only)</p> <p data-bbox="504 638 683 659">Default is disabled.</p> <p data-bbox="504 688 963 709"><b>Dust Filter Reminder (Days)</b> (select products only)</p> <p data-bbox="504 739 628 760">Default is 60.</p> <p data-bbox="504 789 1107 810"><b>Allow No Panel configuration</b> (All-in-One 1000 series models only)</p> <p data-bbox="504 837 1315 858">Allows operation of the base unit without a boot warning when the panel is not installed.</p> <p data-bbox="504 888 954 909"><b>Integrated Video</b> (models with discrete graphics)</p> <p data-bbox="504 938 1441 984">Disables the integrated video device. When not using integrated video, disabling the integrated video will free some system memory.</p> <p data-bbox="504 1014 959 1035"><b>VGA Boot Device</b> (models with discrete graphics)</p> <p data-bbox="504 1064 1390 1110">Selects the graphics controller to use as the primary VGA device during boot-up when there are multiple graphics devices. The firmware can use only one graphics device when booting up.</p> <p data-bbox="504 1140 687 1161"><b>Video Memory Size</b></p> <p data-bbox="504 1190 1398 1236">Lets you manage graphics memory allocation. The value you choose is allocated permanently to graphics and is unavailable to the operating system.</p> <p data-bbox="504 1266 683 1287"><b>Integrated Camera</b></p> <p data-bbox="504 1316 1046 1337">Lets you disable the integrated camera. Default is enabled.</p> <p data-bbox="504 1367 632 1388"><b>Audio Device</b></p> <p data-bbox="504 1417 1390 1509">Select to show audio devices in the operating system, including integrated microphone, internal speakers, and headphone out. When selected, operating system visibility of each audio device is controlled independently. When this setting is cleared, all audio devices are hidden from the operating system. Individual audio device settings are also disabled. Default is enabled.</p> <p data-bbox="504 1539 619 1560"><b>Microphone</b></p> <p data-bbox="504 1589 1409 1661">Clear to disable the integrated microphone. This does not affect devices plugged into audio jacks. The disable and lock setting prevents other audio ports from being remapped to the microphone function in the operating system. Default is enabled.</p> <p data-bbox="504 1690 999 1711"><b>Internal Speakers</b> (does not affect external speakers)</p> <p data-bbox="504 1740 1362 1812">Clear to disable the chassis speaker or speakers. This function is applicable to normal audio playback in the operating system and does not affect the error or warning beeps during POST. Default is enabled.</p> <p data-bbox="504 1841 687 1862"><b>Headphone Output</b></p> <p data-bbox="504 1892 1023 1913">Clear to disable the headphone jack. Default is enabled.</p>

**Table 5-3 Computer Setup Advanced (for advanced users) (continued)**

Option	Heading
<b>Built-In Device Options</b>	<b>Collaboration Buttons</b> (select products only)
	Clear to disable the collaboration buttons. Default is enabled.
	<b>Button Sensitivity</b> (select products only)
	Controls touch sensitivity of collaboration buttons. Select from low, medium, or high.
	<b>LAN/WLAN auto switching</b>
	Select to enable auto switching between a wired and wireless connection. Default is disabled.
	<b>Wake on WLAN</b>
	Select to enable wake on WLAN. Default is disabled.
	<b>M.2 USB/Bluetooth*</b>
Select to enable the M.2 controller. Default is enabled.	
<b>Increase Idle Fan Speed (%)</b>	
Increases the minimum fan speeds over the normal settings while still enabling normal control using the internal thermal sensors.	
<b>Force enable HP Sure View</b>	
Enables the HP Sure View privacy panel by changing the screen brightness.	

**Table 5-3 Computer Setup Advanced (for advanced users) (continued)**

Option	Heading
<b>Port Options</b>	<p data-bbox="507 260 766 281"><b>USB ports</b> (varies by model)</p> <p data-bbox="507 310 1011 331">Lets you enable specific USB ports. Default is enabled.</p> <p data-bbox="507 361 753 382"><b>USB Legacy Port Charging</b></p> <p data-bbox="507 411 1426 457">Lets you enable USB charging port capability when the computer is in hibernate or shutdown mode. Default is enabled.</p> <p data-bbox="507 487 831 508"><b>USB Type-C Downstream Charging</b></p> <p data-bbox="507 537 1430 583">Lets you enable USB charging port capability when the computer is in hibernate, on, or off. Default is enabled.</p> <p data-bbox="507 613 817 634"><b>Media Card Reader/SD_RDR USB</b></p> <p data-bbox="507 663 1366 684">Enables the media card reader connector (labeled SD_RDR) on a desktop. Default is enabled.</p> <p data-bbox="507 714 718 735"><b>SATA</b> (varies by model)</p> <p data-bbox="507 764 1283 785">Lets you hide SATA ports from the operating system. Default is enabled (not hidden).</p> <p data-bbox="507 814 766 835"><b>Serial Port</b> (varies by model)</p> <p data-bbox="507 865 1021 886">Lets you enable specific serial ports. Default is enabled.</p> <p data-bbox="507 915 1181 936"><b>Serial Port Voltage</b> (Retail Point-of-Sale models only; ports vary by model)</p> <p data-bbox="507 966 1398 1012">Lets you configure powered serial port voltage selection on RPOS units that include this feature. Default is 0 Volts.</p> <ul data-bbox="507 1041 625 1155" style="list-style-type: none"><li data-bbox="507 1041 625 1062">• 0 Volts</li><li data-bbox="507 1079 625 1100">• 5 Volts</li><li data-bbox="507 1129 625 1150">• 12 Volts</li></ul> <p data-bbox="507 1184 979 1205"><b>Cash Drawer Port</b> (Retail Point-of-Sale models only)</p> <p data-bbox="507 1234 1209 1255">Controls whether the cash drawer port can be activated. Default is enabled.</p> <p data-bbox="507 1285 705 1306"><b>Restrict USB Devices</b></p> <p data-bbox="507 1335 1046 1356">Specify the following categories of USB devices to enable:</p> <ul data-bbox="507 1386 912 1499" style="list-style-type: none"><li data-bbox="507 1386 833 1407">• Allow all USB devices (default)</li><li data-bbox="507 1436 849 1457">• Allow only keyboard and mouse</li><li data-bbox="507 1486 912 1507">• Allow all but storage devices and hubs</li></ul> <p data-bbox="507 1537 1426 1619">When some devices are restricted, the system will disable USB ports that do not meet the allowed criteria. This feature is usually combined with similar policies within the operating system because USB devices can be moved to different ports. The ports disabled by the BIOS remain disabled until the system is restarted.</p>

**Table 5-3 Computer Setup Advanced (for advanced users) (continued)**

Option	Heading
<b>Power Management Options</b>	<b>Runtime Power Management</b>
	Allows certain operating systems to reduce processor voltage and frequency when the current software load does not require the full capabilities of the processor. Default is enabled.
	<b>Extended Idle Power States</b>
	Allows certain operating systems to decrease the processors power consumption when the processor is idle. Default is enabled.
	<b>S5 Maximum Power Savings</b>
	Enabling this feature reduces the power of the system as much as possible in the S5 state. Power is removed from the wake up circuitry, the expansion slots, and any management features while in S5. Default is disabled.
	<b>SATA Power Management</b>
	Enables or disables SATA bus, device power management, or both. Default is enabled.
	<b>PCI Express Power Management</b>
	Enabling this option permits the PCI Express links to use Active Power State Management (ASPM) to enter lower power states while not in use. Default is enabled.
<b>Power On from Keyboard Ports</b>	
When enabled, this feature allows a key press to turn on the system when it is off (S5 state). If using a USB keyboard, you must plug it into one of the rear ports labeled with the keyboard icon. Default is disabled.	
<b>Unique Sleep State Blink Rates</b>	
This feature is designed to provide a visual indication of what Sleep state the system is in. Each Sleep state has a unique blink pattern. Default is disabled.	
<b>NOTE:</b> A normal shutdown goes to the S4 state for Windows 8 or later.	
S0 (On) = solid white light.	
S3 (Stand By) = 3 blinks at 1 Hz (50% duty cycle) followed by a pause of 2 seconds (white light), repeated cycles of 3 blinks and a pause.	
S4 (Hibernation) = 4 blinks at 1 Hz (50% duty cycle) followed by a pause of 2 seconds (white light), repeated cycles of 4 blinks and a pause.	
S5 (Soft Off) = Light is off.	

**Table 5-3 Computer Setup Advanced (for advanced users) (continued)**

Option	Heading
<b>Remote Management Options</b> (Intel only)	<b>Active Management Technology (AMT)</b>
	Allows you to discover, repair, and protect networked computing devices. Default is enabled.
	<b>USB Key Provisioning Support</b>
	Enables AMT provisioning using a USB storage device. Default is disabled.
	<b>USB Redirection Support</b>
	USB redirection allows USB devices plugged into a client computer to be transparently redirected to the guest operating system. Default is enabled.
	<b>Unconfigure AMT on next boot.</b> Resets AMT configuration options on next boot. Default is Do Not Apply.
	<b>SOL Terminal Emulation Mode</b>
	SOL (serial-over-LAN) terminal emulation mode is only activated during remote AMT (Active Management Technology) redirection operations. The emulation options allow administrators to select which mode works best with their console. Default is ANSI.
	<b>Show Unconfigure ME Confirmation Prompt</b>
Requires user confirmation when unconfiguring the Intel Management Engine. Default is enabled.	
<b>Verbose Boot Messages</b>	
Verbose boot shows additional logging information during startup, which is mainly for debugging if something goes wrong during bootup. Default is enabled.	
<b>Watchdog Timer</b>	
Allows you to set the amount of time for an operating system and BIOS watchdog alert to be sent if the timers are not deactivated. BIOS watchdog is deactivated by BIOS and would indicate that a halt occurred during execution if the alert is sent to the management console. An operating system alert is deactivated by the operating system image and would indicate that a hang occurred during its initialization. Default is enabled.	
<ul style="list-style-type: none"><li data-bbox="504 1224 951 1251">• OS Watchdog Timer (min.). Default is 5 min.</li><li data-bbox="504 1272 970 1297">• BIOS Watchdog Timer (min.). Default is 5 min.</li></ul>	<b>CIRA Timeout (min.)</b>
	CIRA is Customer Initiated Remote Assistance, an Intel service to help users employing Active Management Technology (AMT). Default is 1.

**Table 5-3 Computer Setup Advanced (for advanced users) (continued)**

Option	Heading
<b>Thunderbolt Options</b> (select products only)	<b>Thunderbolt Mode</b>  Enables Thunderbolt™ connections on the Type-C port. When cleared, disables Thunderbolt connections on the Type-C port and disables PCIe tunneling on USB4 connections.  <b>Require BIOS PW to change Thunderbolt Security Level</b>  When selected, <b>Thunderbolt Security Level</b> cannot be changed unless a BIOS administrator password has been created. This setting cannot be disabled if DMA Protection (System Options) is enabled.  <b>Thunderbolt Security Level</b> <ul style="list-style-type: none"><li>• PCIe and DisplayPort - No Security: Any Thunderbolt device detected that requests a PCI-express connection is connected to the system PCI-express bus without approval by the local user.</li><li>• PCIe and DisplayPort - User Authorization (default): Each Thunderbolt peripheral includes a unique identifier used to determine if the device has been previously connected. If the user previously selected <b>Always Connect</b> for a device, it is automatically connected to the PCI-Express bus when attached.</li><li>• PCIe and DisplayPort - Secure Connect: Offers enhanced protection for authenticating a previously connected Thunderbolt device beyond relying on its identifier. The device is provisioned with a key when initially connected, and on subsequent connections a challenge-response is implemented to verify the device before it is connected to the PCI-express bus.</li><li>• DisplayPort™ only: Permits only USB and DisplayPort functionality to be available via the Type-C Thunderbolt port. PCI-Express will not be connected from the Thunderbolt device to the internal PCI-express interface, thus any Thunderbolt device that requires PCI-Express will not function correctly.</li></ul> <b>Native PCIe Hot Plug</b>  Enables hot plug support to the system PCI-Express bus.
<b>Remote HP PC Hardware Diagnostics</b>	<b>Settings</b>  Sets the configuration for Remote HP PC Hardware Diagnostics, including the URLs used for download and upload and scheduled execution frequency.  <b>Execute Remote HP PC Hardware Diagnostics</b>  Select to immediately execute Remote HP PC Hardware Diagnostics based on the how settings are configured. Any unsaved BIOS settings will be lost.

## 6 POST error messages

This section lists the error codes, error messages, and the various indicator light and audible sequences that you may encounter during Power-On Self-Test (POST) or computer restart, the probable source of the problem, and steps you can take to resolve the error condition.

POST Message Disabled suppresses most system messages during POST, such as memory count and non-error text messages. If a POST error occurs, the screen will display the error message. To manually switch to the POST Messages Enabled mode during POST, press any key except **f10**, **f11**, or **f12**. The default mode is POST Message Disabled.

The POST mode selection determines the speed at which the computer loads the operating system and the extent to which it is tested.

Quick Boot is a fast startup process that does not run all of the system level tests, such as the memory test. Full Boot runs all of the ROM-based system tests and takes longer to complete.

You can enable Full Boot to run every 1 to 30 days on a regularly scheduled basis. To establish the schedule, reconfigure the computer to the Full Boot Every x Days mode, using Computer Setup.



**NOTE:** For more information about Computer Setup, see [Computer Setup \(F10\) Utility on page 47](#).

### POST numeric codes and text messages

This section identifies those POST errors that have numeric codes associated with them. The section also includes some text messages that you might encounter during POST.



**NOTE:** The computer beeps once after a POST text message is displayed on the screen.

**Table 6-1** POST numeric codes and text messages

Control panel message	Description	Recommended action
002-Option ROM Checksum Error	System ROM or expansion board option ROM checksum.	<ol style="list-style-type: none"><li>1. Verify the correct ROM.</li><li>2. Flash the ROM if needed.</li><li>3. If an expansion board was recently added, remove it to see if the problem remains.</li><li>4. Clear CMOS.</li><li>5. If the message disappears, there might be a problem with the expansion card.</li><li>6. Replace the system board.</li></ol>
003-System Board Failure	DMA or timers.	<ol style="list-style-type: none"><li>1. Clear CMOS.</li><li>2. Replace the system board.</li></ol>

**Table 6-1 POST numeric codes and text messages (continued)**

Control panel message	Description	Recommended action
005-Real-Time Clock Power Loss	Invalid time or date in configuration memory. RTC (real-time clock) battery might need to be replaced.	Reset the date and time under Control Panel (Computer Setup can also be used). If the problem persists, replace the RTC battery. See <a href="#">Removal and replacement procedures on page 18</a> for instructions about installing a new battery.
008-Microcode Patch Error	Processor is not supported by the BIOS.	<ol style="list-style-type: none"><li>1. Upgrade BIOS to proper version.</li><li>2. Change the processor.</li></ol>
009-PMM Allocation Error during MEBx Download	Memory error during POST execution of the Management Engine (ME) BIOS Extensions option ROM.	<ol style="list-style-type: none"><li>1. Reboot the computer.</li><li>2. Unplug the power cord, reseal the memory modules, and reboot the computer.</li><li>3. If the memory configuration was recently changed, unplug the power cord, restore the original memory configuration, and reboot the computer.</li><li>4. If the error persists, replace the system board.</li></ol>
00A-Product Information Not Valid	The product information programmed into the system board is missing or invalid.	Use <a href="#">Computer Setup (F10) Utility on page 47</a> to update this information.
00B-MEBx Module did not checksum correctly	Memory error during POST execution of the Management Engine (ME) BIOS Extensions option ROM.	<ol style="list-style-type: none"><li>1. Reboot the computer.</li><li>2. Unplug the power cord, reseal the memory modules, and reboot the computer.</li><li>3. If the memory configuration was recently changed, unplug the power cord, restore the original memory configuration, and reboot the computer.</li><li>4. If the error persists, replace the system board.</li></ol>
00C-PMM Deallocation Error during MEBx Cleanup	Memory error during POST execution of the Management Engine (ME) BIOS Extensions option ROM.	<ol style="list-style-type: none"><li>1. Reboot the computer.</li><li>2. Unplug the power cord, reseal the memory modules, and reboot the computer.</li><li>3. If the memory configuration was recently changed, unplug the power cord, restore the original memory configuration, and reboot the computer.</li><li>4. If the error persists, replace the system board.</li></ol>

**Table 6-1 POST numeric codes and text messages (continued)**

Control panel message	Description	Recommended action
00D-Setup Error during MEBx Execution	MEBx selection or exit resulted in a setup failure.	<ol style="list-style-type: none"> <li>1. Reboot the computer.</li> <li>2. Unplug the power cord, reseal the memory modules, and reboot the computer.</li> <li>3. If the memory configuration was recently changed, unplug the power cord, restore the original memory configuration, and reboot the computer.</li> <li>4. If the error persists, replace the system board.</li> </ol>
00E-Inventory Error during MEBx Execution	BIOS information passed to the MEBx resulted in a failure.	<ol style="list-style-type: none"> <li>1. Reboot the computer.</li> <li>2. If the error persists, update to the latest BIOS version.</li> <li>3. If the error still persists, replace the system board.</li> </ol>
00F-Interface Error during MEBx Execution	MEBx operation experienced a hardware error during communication with the ME.	<ol style="list-style-type: none"> <li>1. Reboot the computer.</li> <li>2. If the error persists, update to the latest BIOS version.</li> <li>3. If the error still persists, replace the system board.</li> </ol>
100-Front Audio Not Connected	Front audio cable has been detached or unseated from system board.	Reconnect or replace front audio cable.
2E1-MemorySize Error	Memory amount has changed since the last boot (memory added or removed).	The system memory size is different from the last startup. The most common reason is the removal of memory from the system board. Press the <b>f1</b> key to save the memory changes.
2E2-Memory Error	Memory module configuration failed during boot-up.	<ol style="list-style-type: none"> <li>1. Be sure that memory modules are correctly installed.</li> <li>2. Verify proper memory module type.</li> <li>3. Remove and replace the identified faulty memory modules.</li> <li>4. If the error persists after replacing memory modules, replace the system board.</li> </ol>
2E3-Incompatible Memory Module in Memory Socket(s) X, X, ...	A memory module in memory socket identified in the error message is missing critical SPD information, or is incompatible with the chipset.	<ol style="list-style-type: none"> <li>1. Verify proper memory module type.</li> <li>2. Try another memory socket.</li> <li>3. Replace with a supported module.</li> </ol>
2E4-DIMM Configuration Warning	Populated DIMM Configuration is not optimized.	Rearrange the DIMMs so that each channel has the same amount of memory.

**Table 6-1 POST numeric codes and text messages (continued)**

Control panel message	Description	Recommended action
2E5-ECC Memory Module Detected on Unsupported Platform	Recently added memory modules support ECC memory error correction.	<ol style="list-style-type: none"> <li>1. If additional memory was recently added, remove it to see if the problem remains.</li> <li>2. Check product documentation for memory support information.</li> </ol>
2E6-Memory Not Configured Correctly for Proper MEBx Execution	DIMM1 is not installed.	Be sure that a memory module is in the DIMM1 socket and that it is properly seated.
300-Configuration Change Warning	A change in storage configuration has been detected (see the <b>Boot Options</b> menu in BIOS Setup to enable this feature). Either the installed hardware has changed, storage or firmware mode might have been changed, or a storage device might have failed to respond.	If no changes were made before this warning, check that the drives are connected properly to power cables and system board. User Diagnostics (f2 during boot-up) might help identify any problem with specific devices.
301-Hard Disk 1: SMART Hard Drive Detects Imminent Failure	Hard drive will soon fail. (Some hard drives have a hard drive firmware patch that will fix an erroneous error message.)	<ol style="list-style-type: none"> <li>1. Determine whether hard drive is giving correct error message. Run the Drive Protection System test under using F2 Diagnostics when booting the computer.</li> <li>2. Apply hard drive firmware patch if applicable. (Available at <a href="http://www.hp.com/support">http://www.hp.com/support</a>.)</li> <li>3. Back up contents and replace hard drive.</li> </ol>
302-Hard Disk 2: SMART Hard Drive Detects Imminent Failure	Hard drive will soon fail. (Some hard drives have a hard drive firmware patch that will fix an erroneous error message.)	<ol style="list-style-type: none"> <li>1. Determine whether hard drive is giving correct error message. Run the Drive Protection System test under using F2 Diagnostics when booting the computer.</li> <li>2. Apply hard drive firmware patch if applicable. (Available at <a href="http://www.hp.com/support">http://www.hp.com/support</a>.)</li> <li>3. Back up contents and replace hard drive.</li> </ol>
309 - 30C: Hard Disk 3-6: SMART Hard Drive Detects Imminent Failure	Hard drive will soon fail. (Some hard drives have a hard drive firmware patch that will fix an erroneous error message.)	<ol style="list-style-type: none"> <li>1. Determine whether hard drive is giving correct error message. Run the Drive Protection System test under using F2 Diagnostics when booting the computer.</li> <li>2. Apply hard drive firmware patch if applicable. (Available at <a href="http://www.hp.com/support">http://www.hp.com/support</a>.)</li> <li>3. Back up contents and replace hard drive.</li> </ol>
3F0-Boot Device Not Found	Boot device not found.	Insert boot device or load operating system.

**Table 6-1 POST numeric codes and text messages (continued)**

Control panel message	Description	Recommended action
3F1-Hard Disk 1 Error	Hard disk 1 error.	<ol style="list-style-type: none"> <li>1. Check and/or replace cables.</li> <li>2. Clear CMOS.</li> <li>3. Replace the hard disk drive.</li> </ol>
3F2-Hard Disk 2 Error	Hard disk 2 error.	<ol style="list-style-type: none"> <li>1. Check and/or replace cables.</li> <li>2. Clear CMOS.</li> <li>3. Replace the hard disk drive.</li> </ol>
400-Serial Port A Address Conflict Detected	Both external and internal serial ports are assigned to the same resources.	<ol style="list-style-type: none"> <li>1. Remove any serial port expansion cards.</li> <li>2. Clear CMOS.</li> <li>3. Reconfigure card resources and/or run Computer Setup or Windows utilities.</li> </ol>
401-Serial Port B Address Conflict Detected	Both external and internal serial ports are assigned to the same resources.	<ol style="list-style-type: none"> <li>1. Remove any serial port expansion cards.</li> <li>2. Clear CMOS.</li> <li>3. Reconfigure card resources and/or run Computer Setup or Windows utilities.</li> </ol>
402-Serial Port C Address Conflict Detected	Both external and internal serial ports are assigned to the same resources.	<ol style="list-style-type: none"> <li>1. Remove any serial port expansion cards.</li> <li>2. Clear CMOS.</li> <li>3. Reconfigure card resources and/or run Computer Setup or Windows utilities.</li> </ol>
403-Serial Port D Address Conflict Detected	Both external and internal serial ports are assigned to the same resources.	<ol style="list-style-type: none"> <li>1. Remove any serial port expansion cards.</li> <li>2. Clear CMOS.</li> <li>3. Reconfigure card resources and/or run Computer Setup or Windows utilities.</li> </ol>
419-Out of Memory Space for Option ROMs	Recently added PCI expansion card contains an option ROM too large to download during POST.	If a PCI expansion card was recently added, remove it to see if the problem remains.
41A-Front USB1/USB2 Not Connected	Front USB cable has been detached or unseated from system board.	Reconnect or replace front USB cable.
41B-Device in PCI Express Slot Failed To Initialize	There is an incompatibility or problem with a PCIe device and the system or PCIe link could not be configured to a valid bus width or speed.	Try rebooting the system. If the error reoccurs, the device might not work with this system
43A-USB Type-C I2C Not Connected	Cable is required between I2C on card and USB-C® on the system board.	Install cable between I2C on card and USB-C on the system board.
43B-More Than One USB type-C Cards Are Installed	More than one USB Type-C card is installed.	Remove USB Type-C card so only one is installed.

**Table 6-1 POST numeric codes and text messages (continued)**

Control panel message	Description	Recommended action
500-BIOS Recovery	A system BIOS recovery has occurred.	Not applicable.
70x-Wireless Mode Not Supported	The system has detected a wireless module installed in the system that is not supported and has been disabled.	Replace with a supported module.
800-Keyboard Error	Keyboard failure.	<ol style="list-style-type: none"><li>1. Reconnect keyboard with computer turned off.</li><li>2. Check connector for bent or missing pins.</li><li>3. Be sure that none of the keys are pressed.</li><li>4. Replace keyboard.</li></ol>
801-Keyboard or System Unit Error	Keyboard failure.	<ol style="list-style-type: none"><li>1. Reconnect the keyboard with computer turned off.</li><li>2. Be sure that none of the keys are pressed.</li><li>3. Replace the keyboard.</li><li>4. Replace the system board.</li></ol>
900-CPU Fan Not Detected	CPU fan is not connected or might have malfunctioned.	<ol style="list-style-type: none"><li>1. Reseat fan.</li><li>2. Reseat fan cable.</li><li>3. Replace fan.</li></ol>
901-Chassis, Rear Chassis, Front Chassis, or PCIe blower Fan not Detected	Fan is not connected or might have malfunctioned.	<ol style="list-style-type: none"><li>1. Reseat fan.</li><li>2. Reseat fan cable.</li><li>3. Replace fan.</li></ol>
904-SATA Cabling Error	One or more SATA devices are improperly attached. For optimal performance, the SATA0, SATA1, and SATA2 ports should be used for hard drives before other ports.	Be sure that SATA connectors are used in ascending order. For one device, use SATA0. For two devices, use SATA0 and SATA1. For three devices, use SATA0, SATA1, and SATA2.
90B-Fan Failure	The system has detected that a cooling fan is not operating correctly.	<ol style="list-style-type: none"><li>1. Reseat fan.</li><li>2. Reseat fan cable.</li><li>3. Replace fan.</li></ol>
90D-System Temperature	Thermal shutdown occurred. The system BIOS has detected that your machine was previously shut down to avoid overheating. Overheating might occur if the cooling vents are blocked or the operating temperature exceeds the system specifications. The machine should return to normal operation once the situation is resolved.	Be sure system has proper airflow.
90E-Power Supply Fan Not detected	Power supply fan is not connected or might have malfunctioned.	<ol style="list-style-type: none"><li>1. Reseat power supply fan.</li><li>2. Reseat fan cable.</li><li>3. Replace power supply fan.</li></ol>

**Table 6-1** POST numeric codes and text messages (continued)

Control panel message	Description	Recommended action
910-Filter Warning	Airflow filter is dirty.	Replace the airflow filter.
911-Graphics Module Fan Not Detected	Graphics card fan is not connected or might have malfunctioned.	<ol style="list-style-type: none"><li>1. Reseat graphics card fan.</li><li>2. Reseat fan cable.</li><li>3. Replace graphics card fan.</li></ol>
912-Incorrect CPU cooler installed for this configuration	The processor cooler/heat sink does not match processor power requirement.	Replace the cooler/heat sink to match the processor power requirement.

## Interpreting POST diagnostic front panel lights and audible codes

This section identifies the front panel light codes as well as the audible codes that can occur before or during POST that might not have an error code or text message associated with them.

**⚠ CAUTION:** When the computer is plugged into an AC power source, voltage is always applied to the system board. To reduce the risk of personal injury from electrical shock and/or hot surfaces, be sure to disconnect the power cord from the AC outlet and allow the internal system components to cool before touching.

During the system validation phase that occurs at system startup, the BIOS validates the functionality of the following subsystems and conditions:

- AC adapter
- System board power
- Processor failure
- BIOS corruption
- Memory failure
- Graphics failure
- System board failure
- BIOS authentication failure

If an error is detected, specific patterns of long and short blinks, accompanied by long and short beeps (where applicable) are used to identify the error. These patterns make up a two-part code:

- Major: The category of the error
- Minor: The specific error within the category

**📄 NOTE:** Single beep and blink codes are not used.

**Table 6-2** Beep pattern error identification

Number of long beeps/blinks	Error category
1	Not used
2	BIOS
3	Hardware
4	Thermal
5	System board

Patterns of blink/beep codes are determined by using the following parameters:

- 1 second pause occurs after the last major blink.
- 2 second pause occurs after the last minor blink.
- Beep error code sequences occur for the first five iterations of the pattern and then stop.
- Blink error code sequences continue until the computer is unplugged or the power button is pressed.



**NOTE:** Not all diagnostic lights and audible codes are available on all models.

The red LED blinks to represent the major error category (long blinks). The white LED blinks to represent the minor error category (short blinks). For example, '3.5' indicates 3 long red blinks and 5 short white blinks to communicate the processor is not detected.

**Table 6-3** Interpreting POST diagnostic front panel lights and audible codes

Category	Major/minor code	Description
BIOS	2.2	The main area (DXE) of BIOS has become corrupted, and there is no recovery binary image available.
	2.3	The embedded controller policy requires the user to enter a key sequence.
	2.4	The embedded controller is checking or recovering the boot block.
Hardware	3.2	The embedded controller has timed out waiting for BIOS to return from memory initialization.
	3.3	The embedded controller has timed out waiting for BIOS to return from graphics initialization.
	3.4	The system board displays a power failure (crowbar).*
	3.5	The processor is not detected.*
	3.6	The processor does not support an enabled feature.
	3.7	A removable side panel is not installed.

**NOTE:** On workstations, the computer will not turn on if a removable side panel is not installed.

**Table 6-3** Interpreting POST diagnostic front panel lights and audible codes (continued)

Category	Major/minor code	Description
Thermal	4.2	A processor over temperature condition has been detected.*
	4.3	An ambient temperature over temperature condition has been detected.
	4.4	An MXM over temperature condition has been detected.
System board	5.2	The embedded controller cannot find valid firmware.
	5.3	The embedded controller has timed out waiting for the BIOS.
	5.4	The embedded controller has timed out waiting for BIOS to return from system board initialization.
	5.5	The embedded controller rebooted the system after a possible lockup condition had been detected through the use of a System Health Timer, Automated System Recovery Timer, or other mechanism.

\* Indicates a hardware-triggered event; BIOS controls all other events.

# 7 Password security and resetting CMOS

This computer supports two security password features that you can establish through the Computer Setup Utilities menu: administrator password and power-on password.

When you establish only an administrator password, any user can access all the information on the computer except Computer Setup. When you establish only a power-on password, the power-on password is required to access Computer Setup and any other information on the computer. When you establish both passwords, only the administrator password will give you access to Computer Setup.

When both passwords are set, you can use the administrator password in place of the power-on password as an override to log in to the computer. This feature is useful for a network administrator.

 **IMPORTANT:** Back up the BIOS settings or save them as custom defaults in case you need them later. You can back up in Computer Setup or with the BiosConfigUtility tool available from [www.hp.com](http://www.hp.com). See [Computer Setup \(F10\) Utility on page 47](#) for information about backing up the BIOS settings.

## Changing a setup or power-on password

Use this procedure to change a password.

To change the power-on or setup password, complete the following steps:

1. Turn on or restart the computer.  
To change the setup password, go to step 2.  
To change the power-on password, go to step 3.
2. To change the setup password, as soon as the computer turns on:
  - Press **esc** while the “Press the ESC key for Startup Menu” message is displayed.
  - Press **f10** to enter Computer Setup.
3. When the key icon appears, type your current password, a slash (/) or alternate delimiter character, your new password, another slash (/) or alternate delimiter character, and your new password again as shown:

*current password/new password/new password*

 **NOTE:** Type the new password carefully because the characters do not appear on the screen.

4. Press **enter**.

The new password will take effect the next time the computer is restarted.

## Deleting a setup or power-on password

Use this procedure to delete a password.

To delete the power-on or setup password, complete the following steps:

1. Turn on or restart the computer.

To delete the Setup password, go to step 2.

To delete the Power-on password, go to step 3.

2. To delete the Setup password, as soon as the computer turns on:

- Press **esc** while the "Press the ESC key for Startup Menu" message is displayed.

- Press **f10** to enter Computer Setup.

3. When the key icon appears, type your current password, a slash (/) or alternate delimiter character, your new password, another slash (/) or alternate delimiter character, and your new password again as shown:

*current password/new password/new password*

4. Press **enter**.

---

## 8 Backing up, restoring, and recovering

You can use Windows tools or HP software to back up your information, create a restore point, reset your computer, create recovery media, or restore your computer to its factory state. Performing these standard procedures can return your computer to a working state faster.

---

 **IMPORTANT:** If you are performing recovery procedures on a tablet, the tablet battery must be at least 70% charged before you start the recovery process.

 **IMPORTANT:** For a tablet with a detachable keyboard, connect the tablet to the keyboard base before beginning any recovery process.

---

### Backing up information and creating recovery media

These methods of creating recovery media and backups are available on select products only.

#### Using Windows tools for backing up

HP recommends that you back up your information immediately after initial setup. You can do this task either using Windows Backup locally with an external USB drive or using online tools.

---

 **IMPORTANT:** Windows is the only option that allows you to back up your personal information. Schedule regular backups to avoid information loss.

 **NOTE:** If computer storage is 32 GB or less, Microsoft® System Restore is disabled by default.

---

#### Using the HP Cloud Recovery Download Tool to create recovery media (select products only)

You can use the HP Cloud Recovery Download Tool to create HP Recovery media on a bootable USB flash drive.

For details:

- Go to <http://www.hp.com>, search for HP Cloud Recovery, and then select the result that matches the type of computer that you have.

---

 **NOTE:** If you cannot create recovery media yourself, contact support to obtain recovery discs. Go to <http://www.hp.com/support>, select your country or region, and then follow the on-screen instructions.

 **IMPORTANT:** HP recommends that you follow the [Restoring and recovery methods on page 80](#) to restore your computer before you obtain and use the HP recovery discs. Using a recent backup can return your machine to a working state sooner than using the HP recovery discs. After the system is restored, reinstalling all the operating system software released since your initial purchase can be a lengthy process.

---

# Restoring and recovering your system

You have several tools available to recover your system both within and outside of Windows if the desktop cannot load.

HP recommends that you attempt to restore your system using the [Restoring and recovery methods on page 80](#).

## Creating a system restore

System Restore is available in Windows. The System Restore software can automatically or manually create restore points, or snapshots, of the system files and settings on the computer at a particular point.

When you use System Restore, it returns your computer to its state at the time you made the restore point. Your personal files and documents should not be affected.

## Restoring and recovery methods

After you run the first method, test to see whether the issue still exists before you proceed to the next method, which might now be unnecessary.

1. Run a Microsoft System Restore.
2. Run Reset this PC.



---

**NOTE:** The options **Remove everything** and then **Fully clean the drive** can take several hours to complete and leave no information on your computer. It is the safest way to reset your computer before you recycle it.

---

3. Recover using HP Recovery media. For more information, see [Recovering using HP Recovery media on page 80](#).

For more information about the first two methods, see the Get Help app:

Select the **Start** button, select the **Get Help** app, and then enter the task you want to perform.



---

**NOTE:** You must be connected to the internet to access the Get Help app.

---

## Recovering using HP Recovery media

You can use HP Recovery media to recover the original operating system and software programs that were installed at the factory. On select products, it can be created on a bootable USB flash drive using the HP Cloud Recovery Download Tool.

For details, see [Using the HP Cloud Recovery Download Tool to create recovery media \(select products only\) on page 79](#).



---

**NOTE:** If you cannot create recovery media yourself, contact support to obtain recovery discs. Go to <http://www.hp.com/support>, select your country or region, and then follow the on-screen instructions.

---

To recover your system:

- Insert the HP Recovery media, and then restart the computer.



---

**NOTE:** HP recommends that you follow the [Restoring and recovery methods on page 80](#) to restore your computer before you obtain and use the HP recovery discs. Using a recent backup can return your

machine to a working state sooner than using the HP recovery discs. After the system is restored, reinstalling all the operating system software released since your initial purchase can be a lengthy process.

---

## Changing the computer boot order

If your computer does not restart using the HP Recovery media, you can change the computer boot order, which is the order of devices listed in BIOS for startup information. You can select an optical drive or a USB flash drive, depending on the location of your HP Recovery media.

---

 **IMPORTANT:** For a tablet with a detachable keyboard, connect the tablet to the keyboard base before beginning these steps.

---

To change the boot order:

1. Insert the HP Recovery media.
2. Access the system **Startup** menu.
  - For computers or tablets with keyboards attached, turn on or restart the computer or tablet, quickly press **esc**, and then press **f9** for boot options.
  - For tablets without keyboards, turn on or restart the tablet, quickly press and hold the volume up button, and then select **f9**.

– or –

Turn on or restart the tablet, quickly press and hold the volume down button, and then select **f9**.
3. Select the optical drive or USB flash drive from which you want to boot, and then follow the on-screen instructions.

## Using HP Sure Recover (select products only)

Select computer models are configured with HP Sure Recover, a PC operating system (OS) recovery solution built into the hardware and software. HP Sure Recover can fully restore the HP OS image without installed recovery software.

Using HP Sure Recover, an administrator or user can restore the system and install:

- Latest version of the operating system
- Platform-specific device drivers
- Software applications, in the case of a custom image

To access the latest documentation for HP Sure Recover, go to <http://www.hp.com/support>. Follow the on-screen instructions to find your product and locate your documentation.

---

## 9 Using HP PC Hardware Diagnostics

You can use the HP PC Hardware Diagnostics utility to determine whether your computer hardware is running properly. The three versions are HP PC Hardware Diagnostics Windows, HP PC Hardware Diagnostics UEFI (Unified Extensible Firmware Interface), and (for select products only) Remote HP PC Hardware Diagnostics UEFI, a firmware feature.

### Using HP PC Hardware Diagnostics Windows (select products only)

HP PC Hardware Diagnostics Windows is a Windows-based utility that allows you to run diagnostic tests to determine whether the computer hardware is functioning properly. The tool runs within the Windows operating system to diagnose hardware failures.

If HP PC Hardware Diagnostics Windows is not installed on your computer, you must download and install it. To download HP PC Hardware Diagnostics Windows, see [Downloading HP PC Hardware Diagnostics Windows on page 83](#).

### Using an HP PC Hardware Diagnostics Windows hardware failure ID code

When HP PC Hardware Diagnostics Windows detects a failure that requires hardware replacement, a 24-digit failure ID code is generated for select component tests. For interactive tests, such as keyboard, mouse, or audio and video palette, you must perform troubleshooting steps before you can receive a failure ID.

- You have several options after you receive a failure ID:
  - Select **Next** to open the Event Automation Service (EAS) page, where you can log the case.
  - Scan the QR code with your mobile device, which takes you to the EAS page, where you can log the case.
  - Select the box next to the 24-digit failure ID to copy your failure code and send it to support.

### Accessing HP PC Hardware Diagnostics Windows

After HP PC Hardware Diagnostics Windows is installed, you can access it from HP Support Assistant or the Start menu.

#### Accessing HP PC Hardware Diagnostics Windows from HP Support Assistant

After HP PC Hardware Diagnostics Windows is installed, follow these steps to access it from HP Support Assistant:

1. Complete one of the following tasks:
  - Select the **Search** icon in the taskbar, type `support` in the search box, and then select the **HP Support Assistant** app.
  - Select the question mark icon in the taskbar.
2. Select **Fixes & Diagnostics**.

3. Select **Run hardware diagnostics**, and then select **Launch**.
4. When the tool opens, select the type of diagnostic test that you want to run, and then follow the on-screen instructions.

---

 **NOTE:** To stop a diagnostic test, select **Cancel**.

---

## Accessing HP PC Hardware Diagnostics Windows from the Start menu (select products only)

After HP PC Hardware Diagnostics Windows is installed, follow these steps to access it from the Start menu:

1. Select the **Start** button, and then select **All apps**.
2. Select **HP PC Hardware Diagnostics Windows**.
3. When the tool opens, select the type of diagnostic test that you want to run, and then follow the on-screen instructions.

---

 **NOTE:** To stop a diagnostic test, select **Cancel**.

---

## Downloading HP PC Hardware Diagnostics Windows

The HP PC Hardware Diagnostics Windows downloading instructions are provided in English only. You must use a Windows computer to download this tool because only .exe files are provided.

### Downloading the latest HP PC Hardware Diagnostics Windows version from HP

To download HP PC Hardware Diagnostics Windows from HP, follow these steps:

1. Go to <http://www.hp.com/go/techcenter/pcdiags>. The HP PC Diagnostics home page is displayed.
2. Select **Download HP Diagnostics Windows**, and then select the specific Windows diagnostics version to download to your computer or a USB flash drive.

The tool downloads to the selected location.

### Downloading the HP PC Hardware Diagnostics Windows from the Microsoft Store

You can download the HP PC Hardware Diagnostics Windows from the Microsoft Store:

1. Select the Microsoft Store app on your desktop or select the **Search** icon in the taskbar, and then type `Microsoft Store` in the search box.
2. Type `HP PC Hardware Diagnostics Windows` in the **Microsoft Store** search box.
3. Follow the on-screen directions.

The tool downloads to the selected location.

### Downloading HP Hardware Diagnostics Windows by product name or number (select products only)

You can download HP PC Hardware Diagnostics Windows by product name or number.

---

 **NOTE:** For some products, you might have to download the software to a USB flash drive by using the product name or number.

---

1. Go to <http://www.hp.com/support>.
2. Select **Software and Drivers**, select your type of product, and then enter the product name or number in the search box that is displayed.
3. In the **Diagnostics** section, select **Download**, and then follow the on-screen instructions to select the specific Windows diagnostics version to be downloaded to your computer or USB flash drive.

The tool downloads to the selected location.

## Installing HP PC Hardware Diagnostics Windows

To install HP PC Hardware Diagnostics Windows, navigate to the folder on your computer or the USB flash drive where the .exe file downloaded, double-click the .exe file, and then follow the on-screen instructions.

## Using HP PC Hardware Diagnostics UEFI

HP PC Hardware Diagnostics Unified Extensible Firmware Interface (UEFI) allows you to run diagnostic tests to determine whether the computer hardware is functioning properly. The tool runs outside the operating system so that it can isolate hardware failures from issues that are caused by the operating system or other software components.



**NOTE:** For some products, you must use a Windows computer and a USB flash drive to download and create the HP UEFI support environment because only .exe files are provided. For more information, see [Downloading HP PC Hardware Diagnostics UEFI to a USB flash drive on page 85](#).

If your PC does not start in Windows, you can use HP PC Hardware Diagnostics UEFI to diagnose hardware issues.

## Using an HP PC Hardware Diagnostics UEFI hardware failure ID code

When HP PC Hardware Diagnostics UEFI detects a failure that requires hardware replacement, a 24-digit failure ID code is generated.

For assistance in solving the problem, complete one of these tasks:

- Select **Contact HP**, accept the HP privacy disclaimer, and then use a mobile device to scan the failure ID code that appears on the next screen. The HP Customer Support - Service Center page appears with your failure ID and product number automatically filled in. Follow the on-screen instructions.
- Contact support, and provide the failure ID code.

## Starting HP PC Hardware Diagnostics UEFI

To start HP PC Hardware Diagnostics UEFI, follow this procedure.

1. Turn on or restart the computer, and quickly press **esc**.
2. Press **f2**.

The BIOS searches three places for the diagnostic tools, in the following order:

- a. Connected USB flash drive



**NOTE:** To download the HP PC Hardware Diagnostics UEFI tool to a USB flash drive, see [Downloading the latest HP PC Hardware Diagnostics UEFI version on page 86.](#)

- b. Hard drive
  - c. BIOS
3. When the diagnostic tool opens, select the type of diagnostic test that you want to run, and then follow the on-screen instructions.

## Starting HP PC Hardware Diagnostics UEFI through HP Hotkey Support software (select products only)

This section describes how to start HP PC Hardware Diagnostics UEFI through HP Hotkey Support software.



**NOTE:** You must disable fast boot to access HP PC Hardware Diagnostics UEFI from the HP System Information application.

To disable fast boot:

1. Turn on or restart the computer, and when the HP logo appears, press **f10** to enter Computer Setup.
2. Select **Advanced**, and then select **Boot Options**.
3. Clear **Fast Boot**.
4. Select **Save Changes and Exit**, and then select **Yes**.

To start HP PC Hardware Diagnostics UEFI through HP Hotkey Support software, follow this procedure.:

1. From the **Start** menu, open the HP System Information Application or press **fn+esc**.
2. In HP System Information screen, select **Run System Diagnostics**, select **Yes** to run the application, and then select **Restart**.



**IMPORTANT:** To prevent loss of data, save your work in all open apps before restarting your computer.



**NOTE:** When the restart is complete, the computer opens the HP PC Hardware Diagnostics UEFI Application. Proceed with the troubleshooting tests.

## Downloading HP PC Hardware Diagnostics UEFI to a USB flash drive

Downloading HP PC Hardware Diagnostics UEFI to a USB flash drive can be useful in some situations.

- HP PC Hardware Diagnostics UEFI is not included in the preinstallation image.
- HP PC Hardware Diagnostics UEFI is not included in the HP Tool partition.
- The hard drive is damaged.



**NOTE:** The HP PC Hardware Diagnostics UEFI downloading instructions are provided in English only, and you must use a Windows computer to download and create the HP UEFI support environment because only .exe files are provided.

## Downloading the latest HP PC Hardware Diagnostics UEFI version

To download the latest HP PC Hardware Diagnostics UEFI version to a USB flash drive, follow this procedure:

1. Go to <http://www.hp.com/go/techcenter/pcdiags>. The HP PC Diagnostics home page is displayed.
2. Select **Download HP Diagnostics UEFI**, and then select **Run**.

## Downloading HP PC Hardware Diagnostics UEFI by product name or number (select products only)

You can download HP PC Hardware Diagnostics UEFI by product name or number (select products only) to a USB flash drive.



---

**NOTE:** For some products, you might have to download the software to a USB flash drive by using the product name or number.

---

1. Go to <http://www.hp.com/support>.
2. Enter the product name or number, select your computer, and then select your operating system.
3. In the **Diagnostics** section, follow the on-screen instructions to select and download the specific UEFI Diagnostics version for your computer.

## Using Remote HP PC Hardware Diagnostics UEFI settings (select products only)

Remote HP PC Hardware Diagnostics UEFI is a firmware (BIOS) feature that downloads HP PC Hardware Diagnostics UEFI to your computer. It can then run the diagnostics on your computer, and it might upload results to a preconfigured server.

For more information about Remote HP PC Hardware Diagnostics UEFI, go to <http://www.hp.com/go/techcenter/pcdiags>, and then select **Find out more**.

## Downloading Remote HP PC Hardware Diagnostics UEFI

Remote HP PC Hardware Diagnostics UEFI is also available as a SoftPaq that you can download to a server.

## Downloading the latest Remote HP PC Hardware Diagnostics UEFI version

You can download the latest Remote HP PC Hardware Diagnostics UEFI version to a USB flash drive.

1. Go to <http://www.hp.com/go/techcenter/pcdiags>. The HP PC Diagnostics home page is displayed.
2. Select **Download Remote Diagnostics**, and then select **Run**.

## Downloading Remote HP PC Hardware Diagnostics UEFI by product name or number

You can download Remote HP PC Hardware Diagnostics UEFI by product name or number.



---

**NOTE:** For some products, you might have to download the software by using the product name or number.

---

1. Go to <http://www.hp.com/support>.

2. Select **Software and Drivers**, select your type of product, enter the product name or number in the search box that is displayed, select your computer, and then select your operating system.
3. In the **Diagnostics** section, follow the on-screen instructions to select and download the **Remote UEFI** version for the product.

## Customizing Remote HP PC Hardware Diagnostics UEFI settings

Using the Remote HP PC Hardware Diagnostics setting in Computer Setup (BIOS), you can perform several customizations.

- Set a schedule for running diagnostics unattended. You can also start diagnostics immediately in interactive mode by selecting **Execute Remote HP PC Hardware Diagnostics UEFI**.
- Set the location for downloading the diagnostic tools. This feature provides access to the tools from the HP website or from a server that has been preconfigured for use. Your computer does not require the traditional local storage, such as a hard drive or USB flash drive, to run remote diagnostics.
- Set a location for storing the test results. You can also set the user name and password that you use for uploads.
- Display status information about the diagnostics run previously.

To customize Remote HP PC Hardware Diagnostics UEFI settings, follow these steps:

1. Turn on or restart the computer, and when the HP logo appears, press **f10** to enter Computer Setup.
2. Select **Advanced**, and then select **Settings**.
3. Make your customization selections.
4. Select **Main**, then select **Save Changes and Exit** to save your settings.

Your changes take effect when the computer restarts.

---

# 10 Statement of memory volatility

For general information regarding nonvolatile memory in HP business computers, and to restore nonvolatile memory that can contain personal data after the system has been turned off and the hard drive has been removed, use these instructions.

HP business computer products that use Intel®-based or AMD®-based system boards contain volatile DDR memory. The amount of nonvolatile memory present in the system depends upon the system configuration. Intel-based and AMD-based system boards contain nonvolatile memory subcomponents as originally shipped from HP, with the following assumptions:

- No subsequent modifications were made to the system.
- No applications, features, or functionality were added to or installed on the system.

Following system shutdown and removal of all power sources from an HP business computer system, personal data can remain on volatile system memory (DIMMs) for a finite period of time and also remains in nonvolatile memory. Use the following steps to remove personal data from the computer, including the nonvolatile memory found in Intel-based and AMD-based system boards.

---

 **NOTE:** If your tablet has a keyboard base, connect to the keyboard base before beginning steps in this chapter.

---

## Current BIOS steps

Use these instructions to restore nonvolatile memory.

1. Follow these steps to restore the nonvolatile memory that can contain personal data. Restoring or reprogramming nonvolatile memory that does not store personal data is neither necessary nor recommended.
  - a. Turn on or restart the computer, and then quickly press **esc**.

---

 **NOTE:** If the system has a BIOS administrator password, type the password at the prompt.

---

- b. Select **Main**, select **Apply Factory Defaults and Exit**, and then select **Yes** to load defaults. The computer restarts.
- c. During the restart, press **esc** while the "Press the ESC key for Startup Menu" message is displayed at the bottom of the screen.

---

 **NOTE:** If the system has a BIOS administrator password, type the password at the prompt.

---

- d. Select the **Security** menu, select **Restore Security Settings to Factory Defaults**, and then select **Yes** to restore security level defaults. The computer restarts.
- e. During the restart, press **esc** while the "Press the ESC key for Startup Menu" message is displayed at the bottom of the screen.

---

 **NOTE:** If the system has a BIOS administrator password, type the password at the prompt.

---

- f. If an asset or ownership tag is set, select the **Security** menu and scroll down to the **Utilities** menu. Select **System IDs**, and then select **Asset Tracking Number**. Clear the tag, and then make the selection to return to the prior menu.
- g. If a DriveLock password is set, select the **Security** menu, and scroll down to **Hard Drive Utilities** under the **Utilities** menu. Select **Hard Drive Utilities**, select **DriveLock**, and then clear the check box for **DriveLock password on restart**. Select **OK** to proceed.
- h. Select the **Main** menu, and then select **Reset BIOS Security to factory default**. Select **Yes** at the warning message. The computer restarts.
- i. During the restart, press **esc** while the "Press the ESC key for Startup Menu" message is displayed at the bottom of the screen.



---

**NOTE:** If the system has a BIOS administrator password, type the password at the prompt.

---

- j. Select the **Main** menu, select **Apply Factory Defaults and Exit**, select **Yes** to save changes and exit, and then select **Shutdown**.
  - k. Restart the system. If the system has a Trusted Platform Module (TPM), fingerprint reader, or both, one or two prompts will appear—one to clear the TPM and the other to Reset Fingerprint Sensor. Press or tap **f1** to accept or **f2** to reject.
  - l. Remove all power and system batteries for at least 24 hours.
2. Complete one of the following:
- Remove and retain the storage drive.  
- or -
  - Clear the drive contents by using a third-party utility designed to erase data from an SSD.  
- or -
  - Clear the contents of the drive by using the following BIOS Setup Secure Erase command option steps:



---

**NOTE:** If you clear data using Secure Erase, you cannot recover it.

---

- a. Turn on or restart the computer, and then quickly press **esc**.
- b. Select the **Security** menu and scroll down to the **esc** menu.
- c. Select **Hard Drive Utilities**.
- d. Under **Utilities**, select **Secure Erase**, select the hard drive storing the data you want to clear, and then follow the on-screen instructions to continue.

- or -

Clear the contents of the drive using the following Disk Sanitizer commands steps:

- i. Turn on or restart the computer, and then quickly press **esc**.
- ii. Select the **Security** menu and scroll down to the **Utilities** menu.
- iii. Select **Hard Drive Utilities**.

- iv. Under **Utilities**, select **Disk Sanitizer**, select the hard drive with the data that you want to clear, and then follow the on-screen instructions to continue.

 **NOTE:** The amount of time it takes for Disk Sanitizer to run can take several hours. Plug the computer into an AC outlet before starting.

## Nonvolatile memory usage

Use this table to troubleshoot nonvolatile memory usage.

**Table 10-1** Troubleshooting steps for nonvolatile memory usage

Description	Volatility description	Storage user data	How to erase
Primary storage device, holds the OS, applications, and application settings	Non-volatile, 8-256 GB of eMMC or NVMe SSD storage, removable	Yes <sup>1</sup>	Follow instructions below under “Erase the Primary Storage Device”
System memory (RAM), holds transient data during system operation	Volatile, SODIMM socket. Removable (4 GB/8 GB/16 GB)	Yes	Unplug unit from power
Permanent system BIOS settings	Non-volatile; 16 KB; stored	No <sup>2</sup>	Follow instructions below under “Clearing BIOS Settings”
System boot ROM (BIOS)	Non-volatile memory, 128 Mbit (16 MB) socketed, removable	No	Download the latest BIOS for your model from the HP website and follow the instructions to flash the BIOS that are on the website
RTC (CMOS) RAM	Volatile memory, 256 bytes located in AMD embedded System on Chip (SoC)	No	Unplug unit from main power, remove top cover and press <b>Clear CMOS</b> button
Keyboard/mouse (ROM)	Non-volatile, 2 KB embedded in the super I/O controller (SIO2)	Yes	N/A
Keyboard/mouse (RAM)	Volatile, 256 bytes embedded in the super I/O controller (SIO2)	No	Unplug unit from main power
LOM EEPROM	Non-volatile, 2 MB embedded in LAN controller	No	N/A
Trusted Platform Module (TPM)	Non-volatile; 51 KB ROM for firmware and 38 KB system parametric data	No <sup>3</sup>	Follow instructions below under “Clearing TPM”

<sup>1</sup> Under typical operation, the only user data stored on the primary storage device are preferences for device configuration and settings for connections. However, the administrator can configure the system to allow users to store data locally.

<sup>2</sup> Only user data potentially stored in BIOS Settings are the ownership and asset tags, administrator password, and startup password.

<sup>3</sup> The Trusted Platform Module may contain encrypted passwords or certificates generated from user or administrator input.

## Questions and answers

Use this section to answer your questions about nonvolatile memory.

## 1. How can the BIOS settings be restored (returned to factory settings)?



**IMPORTANT:** The restore defaults feature does not securely erase any information on your hard drive. See question and answer 6 for steps to securely erase information.

The restore defaults feature does not reset the Custom Secure Boot keys. See question and answer 7 for information about resetting the keys.

- a. Turn on or restart the computer, and then quickly press **esc**.
- b. Select **Main**, and then select **Apply Factory Defaults and Exit**.
- c. Follow the on-screen instructions.
- d. Select **Main**, select **Save Changes and Exit**, and then follow the on-screen instructions.

## 2. What is a UEFI BIOS, and how is it different from a legacy BIOS?

The Unified Extensible Firmware Interface (UEFI) BIOS is an industry-standard software interface between the platform firmware and an operating system (OS). It replaces the older BIOS architecture but supports much of the legacy BIOS functionality.

Like the legacy BIOS, the UEFI BIOS provides an interface to display the system information and configuration settings and to change the configuration of your computer before an OS is loaded. BIOS provides a secure runtime environment that supports a Graphic User Interface (GUI). In this environment, you can use either a pointing device (touch screen, touchpad, pointing stick, or USB mouse) or the keyboard to navigate and make menu and configuration selections. The UEFI BIOS also contains basic system diagnostics.

The UEFI BIOS provides functionality beyond that of the legacy BIOS. In addition, the UEFI BIOS works to initialize the computer's hardware before loading and executing the OS; the runtime environment allows the loading and execution of software programs from storage devices to provide more functionality, such as advanced hardware diagnostics (with the ability to display more detailed system information) and advanced firmware management and recovery software.

HP has provided options in Computer Setup (BIOS) to allow you to run in legacy BIOS, if required by the operating system. Examples of this requirement would be if you upgrade or downgrade the OS.

## 3. Where is the UEFI BIOS located?

The UEFI BIOS is located on a flash memory chip. You must use a utility to write to the chip.

## 4. What kind of configuration data is stored on the DIMM Serial Presence Detect (SPD) memory module? How would this data be written?

The DIMM SPD memory contains information about the memory module, such as size, serial number, data width, speed and timing, voltage, and thermal information. This information is written by the module manufacturer and stored on an EEPROM. You cannot write to this EEPROM when the memory module is installed in a computer. Third-party tools do exist that can write to the EEPROM when the memory module is not installed in a computer. Various third-party tools are available to read SPD memory.

## 5. What is meant by "Restore the nonvolatile memory found in Intel-based system boards"?

This message relates to clearing the Real Time Clock (RTC) CMOS memory that contains computer configuration data.

## 6. How can the BIOS security be reset to factory defaults and erase the data?



**IMPORTANT:** Resetting results in the loss of information.

These steps do not reset Custom Secure Boot Keys. See question and answer 7 for information about resetting the keys.

- a. Turn on or restart the computer, and then quickly press **esc**.
- b. Select **Main**, and then select **Reset Security to Factory Defaults**.
- c. Follow the on-screen instructions.
- d. Select **Main**, select **Save Changes and Exit**, and then follow the on-screen instructions.

## 7. How can the Custom Secure Boot Keys be reset?

Secure Boot is a feature to ensure that only authenticated code can start on a platform. If you enabled Secure Boot and created Custom Secure Boot Keys, disabling Secure Boot does not clear the keys. You must also select to clear the Custom Secure Boot Keys. Use the same Secure Boot access procedure that you used to create the Custom Secure Boot Keys, but select to clear or delete all Secure Boot Keys.

- a. Turn on or restart the computer, and then quickly press **esc**.
- b. Select the **Security** menu, select **Secure Boot Configuration**, and then follow the on-screen instructions.
- c. At the **Secure Boot Configuration** window, select **Secure Boot**, select **Clear Secure Boot Keys**, and then follow the on-screen instructions to continue.

## Using HP Sure Start (select products only)

Select computer models are configured with HP Sure Start, a technology that continuously monitors your computer's BIOS for attacks or corruption.

If the BIOS becomes corrupted or is attacked, HP Sure Start restores the BIOS to its previously safe state, without user intervention. Those select computer models ship with HP Sure Start configured and enabled. HP Sure Start is configured and already enabled so that most users can use the HP Sure Start default configuration. Advanced users can customize the default configuration.

To access the latest documentation on HP Sure Start, go to <http://www.hp.com/support>.

---

# 11 Power cord set requirements

The power supplies on some computers have external power switches.

The voltage select switch feature on the computer permits it to operate from any line voltage of 100 V AC to 120 V AC or 220 V AC to 240 V AC. Power supplies on those computers that do not have external power switches are equipped with internal switches that sense the incoming voltage and automatically switch to the proper voltage.

The power cord set received with the computer meets the requirements for use in the country where you purchased the equipment.

Power cord sets for use in other countries must meet the requirements of the country where you use the computer.

## General requirements

These requirements are applicable to all countries.

1. The power cord must be approved by an acceptable accredited agency responsible for evaluation in the country where the power cord set will be installed.
2. The power cord set must have a minimum current capacity of 10A (7A Japan only) and a nominal voltage rating of 125 V AC or 250 V AC, as required by each country's power system.
3. The diameter of the wire must be a minimum of 0.75 mm<sup>2</sup> or 18AWG, and the length of the cord must be between 1.8 m (6 ft) and 3.6 m (12 ft).

The power cord should be routed so that it is not likely to be walked on or pinched by items placed upon it or against it. Particular attention should be paid to the plug, electrical outlet, and the point where the cord exits from the product.

---

 **WARNING!** Do not operate this product with a damaged power cord set. If the power cord set is damaged in any manner, replace it immediately.

---

## Japanese power cord requirements

For use in Japan, use only the power cord received with this product.

---

 **IMPORTANT:** Do not use the power cord received with this product on any other products.

---

## Country-specific requirements

This information provides additional requirements specific to a country.

**Table 11-1 Power cord country-specific requirements**

Country	Accrediting Agency	Country	Accrediting Agency
Australia (1)	EANSW	Italy (1)	IMQ
Austria (1)	OVE	Japan (3)	METI
Belgium (1)	CEBC	Norway (1)	NEMKO
Canada (2)	CSA	Sweden (1)	SEMKO
Denmark (1)	DEMKO	Switzerland (1)	SEV
Finland (1)	SETI	United Kingdom (1)	BSI
France (1)	UTE	United States (2)	UL
Germany (1)	VDE		

1. The flexible cord must be Type HO5VV-F, 3-conductor, 0.75mm<sup>2</sup> conductor size. Power cord set fittings (appliance coupler and plug) must bear the certification mark of the agency responsible for evaluation in the country where it will be used.
2. The flexible cord must be Type SVT or equivalent, No. 18 AWG, 3 conductor. The plug must be a 2-pole grounding type with a NEMA 5-15P (15 A, 125 V) or NEMA 6-15P (15 A, 250 V) configuration.
3. Appliance coupler, flexible cord, and plug must bear a T mark and registration number in accordance with the Japanese Dentori Law. Flexible cord must be Type VCT or VCTF, 3-conductor, 0.75 mm<sup>2</sup> conductor size. Plug must be a 2-pole grounding type with a Japanese Industrial Standard C8303 (7 A, 125 V) configuration.

# 12 Specifications

This section provides specifications for your computer.

**Table 12-1 Specifications**

	<b>Metric</b>	<b>U.S.</b>
<b>Dimensions</b>		
Height	100 mm	3.9 in
Width	300 mm	11.8 in
Depth	302 mm	11.9 in
<b>Approximate weight</b>	3.9 kg	8.6 lb
<b>Temperature range</b>		
Operating	10°C to 40°C	50°F to 104°F
Nonoperating	-30°C to 65°C	-22°F to 149°F
<b>Maximum altitude (unpressurized)</b>		
Operating	3,048 m	10,000 ft
Nonoperating	9,144 m	30,000 ft
<b>Relative humidity (noncondensing)</b>		
Operating	20% to 85%	
Nonoperating (38.7°C max wet bulb)	0% to 95%	
<b>Power supply</b>		
	250 W	
Operating voltage range	90 V AC to 264 V AC	
Rated voltage range <sup>1</sup>	100 V AC to 240 V AC	
Rated line frequency	50 Hz to 60 Hz	
Operating line frequency	47 Hz to 63 Hz	

<sup>1</sup> This system uses an active power factor-corrected power supply. This allows the system to pass the CE mark requirements for use in the countries of the European Union. The active power factor-corrected power supply also has the added benefit of not requiring an input-voltage range select switch.

 **NOTE:** Operating temperature is derated 1.0°C per 300 m (1000 ft) to 3000 m (10,000 ft) above sea level; no direct sustained sunlight. Maximum rate of change is 10°C/Hr. The upper limit might be limited by the type and number of options installed.

---

# Index

- A**
  - access panel
    - illustrated 6
    - removal and replacement 19
  - Advanced menu, Computer Setup 58
  - antennas
    - external 5
  - audible codes 74
  - audio board
    - illustrated 6
    - removal and replacement 41
- B**
  - backup, creating 79
  - backups 79
  - battery
    - disposal 10, 15, 16
  - battery replacement 25
  - beep codes 74
  - blinking lights 74
  - boot order, changing 81
  - booting options
    - Full Boot 68
    - Quick Boot 68
- C**
  - cable management 10, 16, 17
  - cable pinouts, SATA data 16
  - camera assembly
    - illustrated 8
  - cash drawer 24 V power flex card
    - illustrated 8
  - cash drawer card
    - rotating 38
  - changing a Power-On password 77
  - changing a Setup password 77
  - cleaning
    - computer 10, 13, 14
    - mouse 10, 13, 15
    - safety precautions 10, 13
  - CMOS
    - clearing and resetting 77
  - computer cleaning 10, 13, 14
  - Computer Setup
    - Advanced menu 58
    - Main menu 48
    - Security menu 52
  - Computer Setup Utility 47
  - country power cord set requirements 93
- D**
  - deleting a Power-On password 77
  - deleting a Setup password 77
  - dust filter
    - illustrated 8
    - removal and replacement 18
- E**
  - electrostatic discharge (ESD) 10
    - preventing damage 10, 11
  - error
    - codes 68, 74
  - error messages 68
  - expansion cards 22
    - removal and replacement 23
- F**
  - F10 Setup 47
  - fan and duct assembly
    - illustrated 8
    - removal and replacement 28
  - flex card
    - illustrated 7
    - removal and replacement 39
  - front bezel
    - removal and replacement 26
  - front I/O assembly
    - illustrated 8
    - removal and replacement 33
  - front panel components 1
- G**
  - graphics card
    - illustrated 8
  - grounding methods 10, 11
- H**
  - hard drive
    - proper handling 10, 15, 16
    - removal and replacement 21
  - SATA characteristics 16
  - heat sink
    - illustrated 7
    - removal and replacement 31
  - HP PC Hardware Diagnostics UEFI
    - downloading 85
    - failure ID code 84
    - HP Hotkey Support software 85
    - starting 84, 85
    - using 84
  - HP PC Hardware Diagnostics Windows
    - accessing 82, 83
    - downloading 83
    - failure ID code 82
    - installing 84
    - using 82
  - HP Recovery media
    - recovery 80
  - HP Sure Recover 81
  - HP Sure Start 88, 92
- I**
  - illustrated parts catalog 6
  - installing
    - battery 25
    - memory 28
- K**
  - keyboard
    - cleaning 10, 13, 14
- L**
  - lights
    - blinking PS/2 keyboard 74
- M**
  - Main menu, Computer Setup 48
  - major components
    - illustrated 6
  - memory
    - installation 28
    - nonvolatile 88
    - socket population 28
    - volatile 88

- memory module
  - illustrated 6
- miscellaneous parts 8
- mouse
  - cleaning 10, 13, 15
- N**
- nonvolatile memory 88
- numeric error codes 68
- O**
- operating guidelines 10, 13
- overheating, prevention 10, 13
- P**
- parallel port
  - illustrated 8
- password
  - Power-On 77
  - security 77
  - Setup 77
- POST error messages 68
- power cord set requirements
  - country specific 93
- power supply
  - illustrated 6
  - operating voltage range 95
  - removal and replacement 42
- Power-On password 77
- powered serial ports 35
- processor
  - removal and replacement 32
- product ID location 4
- R**
- rear expansion card
  - removal 40
  - spare part numbers 40
- rear expansion port
  - illustrated 7
- rear panel components 2
- recovery 79, 80
  - discs 80
  - media 80
  - USB flash drive 80
- recovery media 79
  - creating using HP Cloud Recovery Download Tool 79
  - creating using Windows tools 79
- Remote HP PC Hardware
  - Diagnostics UEFI settings
    - customizing 87
    - using 86
- removal and replacement
  - access panel 19
  - audio board 41
  - dust filter 18
  - expansion cards 23
  - fan and duct assembly 28
  - flex card 39
  - front bezel 26
  - front I/O assembly 33
  - hard drive 21
  - heat sink 31
  - power supply 42
  - processor 32
  - serial port A 36
  - serial port C/D 37
  - solid-state drive 19
  - speaker 34
  - system board 44
  - WLAN antennas 43
  - WLAN module 38
- removing
  - battery 25
- removing personal data from
  - volatile system memory 88
- restoring 79
- restoring and recovery
  - methods 80
- rotating the cash drawer card 38
- S**
- safety precautions
  - cleaning 10, 13
- SATA
  - connectors on system board 16
  - data cable pinouts 16
  - hard drive characteristics 16
- screws, correct size 10, 15
- Security menu, Computer Setup 52
- serial number location 4
- serial port A
  - removal and replacement 36
- serial port C/D
  - removal and replacement 37
- service considerations 10, 15
- Setup password 77
- software
  - servicing computer 10, 15
- solid-state drive
  - illustrated 7
  - removal and replacement 19
- speaker
  - illustrated 8
  - removal and replacement 34
- specifications
  - computer 95
- static electricity 10
- system board
  - illustrated 7
  - removal and replacement 44
  - SATA connectors 16
- system memory, removing
  - personal data from volatile 88
- system restore 80
- system restore point, creating 79
- T**
- temperature control 10, 13
- tools, servicing 10, 15
- Torx T15 screwdriver 10, 15
- tower conversion 4
- U**
- using Computer Setup Utilities 47
- V**
- ventilation, proper 10, 13
- W**
- Windows
  - backup 79
  - recovery media 79
  - system restore point 79
- Windows tools, using 79
- WLAN antennas
  - removal and replacement 43
- WLAN module
  - illustrated 7
  - removal and replacement 38