



# Poly Partner Mode User Guide 4.4.0

## **SUMMARY**

This guide provides the end-user with task-based user information for the featured product.

## Legal information

### Copyright and license

© 2021, 2024, HP Development Company, L.P. The information contained herein is subject to change without notice. The only warranties for HP products and services are set forth in the express warranty statements accompanying such products and services. Nothing herein should be construed as constituting an additional warranty. HP shall not be liable for technical or editorial errors or omissions contained herein.

### Trademark credits

All third-party trademarks are the property of their respective owners. Google and the Google Logo are registered trademarks of Google LLC.

### Privacy policy

HP complies with applicable data privacy and protection laws and regulations. HP products and services process customer data in a manner consistent with the HP Privacy Policy. Please refer to [HP Privacy Statement](#).

### Open source software used in this product

This product contains open source software. You may receive the open source software from HP up to three (3) years after the distribution date of the applicable product or software at a charge not greater than the cost to HP of shipping or distributing the software to you. To receive software information, as well as the open source software code used in this product, contact HP by email at [ipgoopensourceinfo@hp.com](mailto:ipgoopensourceinfo@hp.com).

---

# Table of contents

<b>1 About this guide</b>	<b>1</b>
Audience, purpose, and required skills	1
Icons used in Poly documentation	1
<b>2 Getting Started</b>	<b>2</b>
Poly Partner Mode Overview	2
Navigating Your System	3
Poly IR Remote Control Button Functions	3
Bluetooth Remote Control Button Functions	4
Enable TalkBack in Microsoft Teams Rooms	5
Navigating Talkback in Microsoft Teams Rooms	5
Using a Connected Trio in a Microsoft Teams Rooms Environment	6
Product Overview of Poly Video Systems	7
Poly G7500 System Features and Capabilities	7
Poly Studio X72 features and capabilities	7
Poly Studio X70 Features and Capabilities	8
Poly Studio X52 Features and Capabilities	8
Poly Studio X50 Features and Capabilities	9
Poly Studio X30 Features and Capabilities	9
Poly Studio E70 Camera Overview	10
Administrator Features and Capabilities	10
Overview of system hardware	11
Poly G7500 Hardware	11
Poly G7500 System Ports	11
Poly Studio X72 hardware	12
Poly Studio X72 privacy shutter behavior	13
Poly Studio X72 hardware ports	13
Poly Studio X70 Hardware	14
Poly Studio X70 System Hardware Ports	15
Poly Studio X70 and Poly Studio X72 Privacy Shutter Behavior	15
Poly Studio X52 Hardware	16
Poly Studio X52 System Ports	16
Poly Studio X52 Privacy Cover	17
Poly Studio X50 Hardware	17
Poly Studio X50 System Ports	18
Poly Studio X50 Privacy Cover	19

Poly Studio X30 Hardware.....	19
Poly Studio X30 System Ports.....	20
Poly Studio X30 Privacy Cover.....	20
Poly Studio E70 Camera Hardware.....	21
Poly Studio E70 Ports.....	21
Poly Studio E70 Privacy Shutter Behavior.....	22
LED Status Indicators.....	23
LED Status Indicators for the Poly G7500 System.....	23
LED status indicators for the Poly Studio X72 and Poly Studio X70 systems.....	23
LED Status Indicators for Poly Studio X50 and Poly Studio X30 Systems.....	24
LED Status Indicators for the Poly Studio E70 Camera.....	25
Powering the System On and Off.....	25
Wake the System.....	25
Accessibility Features.....	26
Users Who Are Deaf or Hard of Hearing.....	26
Users Who Are Blind, Have Low Vision, or Have Limited Vision.....	26
Users with Limited Mobility.....	26
<b>3 Sharing Content.....</b>	<b>28</b>
Share Content Using an HDMI Connection.....	28
<b>4 Using device mode.....</b>	<b>29</b>
Computer and cable requirements for Device Mode.....	29
Access Device Mode.....	30
Use your system as a computer accessory.....	30
Adjust the system audio and camera settings in Device Mode.....	30
Managing incoming calls when in Device Mode.....	31
Exit Device Mode and disconnect your computer.....	31
<b>5 Settings.....</b>	<b>32</b>
Cameras.....	33
Adjust an In-Room Camera.....	33
Turn Camera Tracking On or Off.....	33
Audio Adjustments.....	34
Adjust the Volume.....	34
<b>6 Troubleshooting.....</b>	<b>35</b>
Poly Device Mode.....	36
Audio Levels are Too High or Low.....	36
Conferencing Application Doesn't Use System Camera or Audio.....	36
Can't Use System's Camera or Audio.....	36
Improve Audio Quality.....	37
Improve Laptop Screen Mirroring.....	37
<b>7 Getting help.....</b>	<b>38</b>
HP Inc. addresses.....	38



---

# 1 About this guide





This section provides clarifying information about this guide.

## Audience, purpose, and required skills

This guide is intended for beginning users, as well as intermediate and advanced users, who want to learn how to use the features available with Poly G7500, Poly Studio G62, and Poly Studio X series .

## Icons used in Poly documentation

This section describes the icons used in Poly documentation and what they mean.

- 
-  **WARNING!** Indicates a hazardous situation that, if not avoided, **could** result in serious injury or death.
  -  **CAUTION:** Indicates a hazardous situation that, if not avoided, **could** result in minor or moderate injury.
  -  **IMPORTANT:** Indicates information considered important but not hazard-related (for example, messages related to property damage). Warns the user that failure to follow a procedure exactly as described could result in loss of data or in damage to hardware or software. Also contains essential information to explain a concept or to complete a task.
  -  **NOTE:** Contains additional information to emphasize or supplement important points of the main text.
  -  **TIP:** Provides helpful hints for completing a task.
-

---

## 2 Getting Started

Before you use your system, familiarize yourself with its features and local interface.

### Poly Partner Mode Overview

Poly Partner Mode allows you to run third-party conferencing applications on supported Poly video systems. For example, after powering on your system for the first time, you can select Zoom Rooms to place Zoom calls.



---

**NOTE:** Observe the following when using your system in partner mode:

- Not all providers are supported on all systems. For the latest information on partner applications supported on each system, see the *Poly VideoOS Release Notes*.
- Dialpad and Google Meet aren't supported on Poly G7500 systems.
- As of Poly VideoOS 4.2.0, BlueJeans is no longer supported. After updating to Poly VideoOS 4.2.0, systems that are still using BlueJeans will automatically update to Poly Video Mode.
- Poly Studio G62 is certified for Microsoft Teams Rooms and Zoom Rooms.

Certification for Tencent and other providers is pending.

---

Refer to the supported partner documentation for information on using third-party applications:

- **Microsoft Teams Rooms:** <https://support.office.com/en-us/teams>
- **Zoom Rooms:** <https://support.zoom.us/hc/en-us>
- **Google Meet:** <https://apps.google.com/meet/>
- **Dialpad:** <https://help.dialpad.com/>  
(Not supported on Poly Studio G62 and Poly G7500)
- **GoToRoom by LogMeIn:** <https://support.goto.com/products>
- **RingCentral Rooms (RCV Rooms):** <https://support.ringcentral.com/>
- **Tencent:** <https://meeting.tencent.com/cloud-rooms.html>

# Navigating Your System

The system has icons and user screens to help you navigate and understand important information about your system.

When the system is running a partner application such as Teams Rooms or Zoom Rooms, the partner application provides controls and a user interface specific to their application.

When you pair a Poly TC8 touch controller with your system, the partner application presents the system controls on the TC8 touch controller.

Available system controls vary between partner applications.

## Poly IR Remote Control Button Functions

When you connect a Poly IR receiver to your G7500 or Studio X system, you can use the Poly IR remote control to navigate your system.

 **NOTE:** Remote control functionality may be limited in other partner applications.

The following illustration and table show the buttons and functionality of the Poly IR remote control.

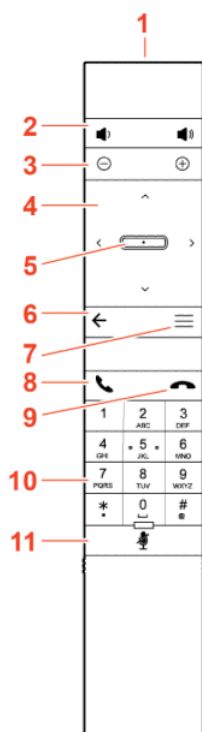

**Table 2-1** IR Remote Button Functions

Item	Description	Function
1	IR LED	Sends IR signals to the IR receiver
2	Volume	Increase or decrease the volume
3	Camera zoom	Zoom the camera in or out

**Table 2-1** IR Remote Button Functions (continued)

Item	Description	Function
4	Navigation controls	Navigate the user interface.
5	Select	Select an item on the user interface or adjust a toggle
6	Back arrow	Return to the previous screen
7	Menu	In Poly Video mode only, show or hide the settings and camera controls
8	Call	Display the calls screen or answer an incoming call
9	End call	End an active call or reject an incoming call
10	Dialpad	Dial a number
11	Mute	Mute or unmute the system microphones

## Bluetooth Remote Control Button Functions

When you pair the Poly Bluetooth remote control with your Poly Studio G62, Poly G7500, or Poly Studio X system, you can use the remote control to navigate your system.

 **NOTE:** Remote control functionality may be limited in other partner applications.

The following illustration and table show the buttons and functionality of the Bluetooth remote control. The functionality is specific to Poly Video mode.

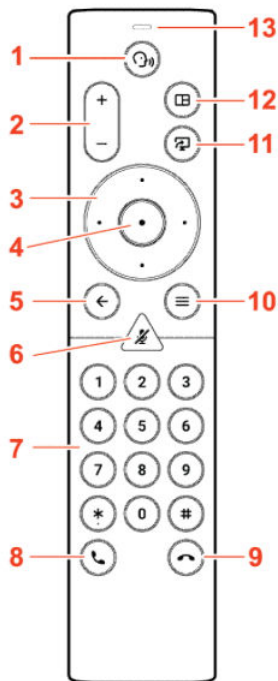

**Table 2-2 IR Remote Button Functions**

Item	Description	Function
1	Voice Assistant	Feature planned for future use
2	Volume or zoom	Adjust volume up and down or, in camera mode, zoom the camera in or out
3	Navigation controls	Navigate the screen In camera mode, controls camera pan and tilt
4	Select	Select an item on the user interface or adjust a toggle
5	Back arrow	Return to the previous screen
6	Mute	Mute the system microphones. Long press to pair the remote control with the system
7	Keypad	Dial a number. Select camera presets while in a call in
8	Call button	Display the calls screen or answer an incoming call
9	End call	End an active call, reject an incoming call, or end a meeting
10	Menu	Open the available system menu to access features
11	Present content	From the home screen, display the content help screen In a meeting, open the content tray and select available content to share
12	Layout	Open the layout screen to choose how two or more participants display on the screen
13	Voice Assistant Microphone	Feature planned for future use

## Enable TalkBack in Microsoft Teams Rooms

 **NOTE:** Talkback is disabled by default. If the device restarts, you'll need to reenable Talkback.

1. On the touch controller, select **More > Settings > Device Settings > Accessibility**.
2. Enable **Talkback**.

## Navigating Talkback in Microsoft Teams Rooms

Navigate the user interface by touch using a menu of available gestures. As you navigate the screen, the device announces the item you select.

 **NOTE:** Items in the **Settings** menu may appear below the screen. To access items below the screen, use two fingers to scroll up or swipe right on the screen to go down the list.

### Talkback Navigation

Touch Gesture	Result
Swipe right	Moves to the next user interface element and announces the element name
Swipe left	Moves to the previous user interface element and announces the element name

Touch Gesture	Result
Drag one finger around the screen	Speaks the name of the user interface item or the onscreen text as your finger moves over it
Double tap the screen	Selects the user interface item currently in focus
Swipe down then left	Returns to the main screen
Swipe up or down and right	Opens the Talkback menu
Swipe up or down with two fingers	Scrolls through menu items
Swipe down then left	Return to the main screen

## Using a Connected Trio in a Microsoft Teams Rooms Environment

Your Microsoft Teams Rooms solution may include one or two connected Poly Trio speakerphones. The Poly Trio speakerphones are used as external speakers and microphones for your system.

From a connected Poly Trio in Microsoft Teams Rooms mode, you can:

- Mute or unmute the microphones
- Adjust the call volume

# Product Overview of Poly Video Systems

Poly Studio G62, Poly G7500, Poly Studio X72, Poly Studio X70, Poly Studio X52, Poly Studio X50, and Poly Studio X30 systems support Poly video conferencing and content sharing features.

## Poly G7500 System Features and Capabilities

G7500 systems support the following features:

- Peripheral cameras and microphones make the system scalable for medium rooms and up to large integrated rooms
- Placing and joining video calls
- Sharing wireless and wired content
- Camera tracking technology that can automatically zoom in on the person talking or frame the group of people in the room (depending on the paired camera and system configuration)
- Poly NoiseBlockAI, which eliminates background and extraneous sound during calls in common working environments
- Polycom Acoustic Fence technology, which enables video conferencing in open workspaces by capturing only the voices in a defined area
- HDMI: Single input and dual output
- Using a wired or wireless USB mouse as an input device

## Poly Studio X72 features and capabilities

Poly Studio X72 systems support the following features.

- Dual 4K 20MP cameras with 70-degree and 120-degree horizontal field of view ideal for large-size conference rooms.
- Poly Expansion microphone support using the RJ11 Poly Expansion microphone port
- High fidelity audio powered by built-in microphones that pick up sound within 7.62 m (25 ft)
- Poly Acoustic Fence technology shields your calls from distracting outside voices and sounds using your conference room microphones to create a defined sound zone
- Poly DirectorAI, which includes a perimeter feature plus group framing, speaker framing, and people framing
- Poly Lens Cloud support for setting up, configuring, and managing your device
- Multiple mounting options. Use the wall mount included with your Poly Studio X72, or purchase a VESA mount, or tabletop stand.

You can mount the Poly Studio X72 above or below a display. The Poly Studio X72 doesn't support inverted mounting. For more information, see the Poly Studio X72 quick start guides.

## Poly Studio X70 Features and Capabilities

### Poly Studio X70 Features and Capabilities

Studio X70 systems support the following features:

- All-in-one collaboration system for medium-to-large rooms
- No need for a separate PC, laptop, or codec to run video-conferencing software
- Placing and joining video calls
- Sharing wireless and wired content
- Dual built-in 4K cameras
- Camera tracking technology that automatically frames the group of people in the room
- Hi-fidelity, built-in stereo microphones that pick up sound within 7.62 m (25 ft) and use spatial audio for life-like presence and clarity
- Poly NoiseBlockAI, which eliminates background and extraneous sound during calls in common working environments
- HDMI: Single input and dual output
- Using a wired or wireless USB mouse as an input device

### Poly Studio X70 Mounting Orientation

You can mount the Studio X70 above or below a display. The Studio X70 doesn't support inverted mounting. For information on mounting the Studio X70, see the Studio X70 setup sheet.

## Poly Studio X52 Features and Capabilities

Studio X52 systems support the following features:

- All-in-one collaboration system for huddle rooms and small-to-medium rooms
- No need for a separate PC, laptop, or codec to run video-conferencing software
- Placing and joining video calls
- Sharing wireless and wired content
- Sharp 4K, 20MP camera with 95-degree horizontal field of view
- Camera tracking technology that automatically frames the group of people in the room
- Hi-fidelity, built-in stereo microphones that pick up sound within 7.62 m (25 ft) and use spatial audio for life-like presence and clarity
- Poly NoiseBlockAI, which eliminates background and extraneous sound during calls in common working environments
- Dual stereo speakers
- HDMI: Single input and dual output
- Simple to set up, manage, and use with Poly Lens

## Poly Studio X52 Mounting Orientation

You can mount the Studio X52 above or below a display. The Studio X52 doesn't support inverted mounting. For information on mounting the Studio X52, see the *Poly Studio X52 Quick Start Guide*.

## Poly Studio X50 Features and Capabilities

Studio X50 systems support the following features:

- All-in-one collaboration system for huddle rooms and small-to-medium rooms
- No need for a separate PC, laptop, or codec to run video-conferencing software
- Placing and joining video calls
- Sharing wireless and wired content
- Built-in 4K camera with ultra-wide 120-degree field of view
- Camera tracking technology that automatically frames the group of people in the room
- Hi-fidelity, built-in stereo microphones that pick up sound within 7.62 m (25 ft) and use spatial audio for life-like presence and clarity
- Poly NoiseBlockAI, which eliminates background and extraneous sound during calls in common working environments
- Dual stereo speakers
- HDMI: Single input and dual output
- Using a wired or wireless USB mouse as an input device

## Poly Studio X50 Mounting Orientation

You can mount the Studio X50 above or below a display. The Studio X50 doesn't support inverted mounting. For information on mounting the Studio X50, see the Studio X50 setup sheet.

## Poly Studio X30 Features and Capabilities

Studio X30 systems support the following features:

- All-in-one collaboration system for huddle rooms and small-to-medium rooms
- No need for a separate PC, laptop, or codec to run video-conferencing software
- Placing and joining video calls
- Sharing wireless and wired content
- Built-in 4K camera with ultra-wide 120-degree field of view
- Camera tracking technology that automatically frames the group of people in the room
- High-fidelity, built-in stereo microphones that pick up sound within 4.57 m (15 ft) and use spatial audio for life-like presence and clarity
- Poly NoiseBlockAI, which eliminates background and extraneous sound during calls in common working environments

- Single mono speaker
- HDMI: Single input and output
- Using a wired or wireless USB mouse as an input device

### **Poly Studio X30 Mounting Orientation**

You can mount the Studio X30 above or below a display. The Studio X30 supports inverted mounting. For information on mounting the Studio X30, see the Studio X30 setup sheet.

## **Poly Studio E70 Camera Overview**

Poly Studio E70 is a dual-camera solution for medium to large conference rooms.

The Poly Studio E70 includes the following features:

- Standalone USB 4K camera with full tracking and framing capabilities
- Visual coverage up to 7.6 m (25 ft)
- Microphones that provide accurate sound source location to support camera tracking

## **Administrator Features and Capabilities**

The G7500 and Studio X Family systems provide features for administrators to deploy, manage, and access systems.

These systems provide the following features and capabilities:

- Remote access for managing standalone systems
- Provisioning with Poly Clariti Manager to support single system, small business, and large multisite enterprise deployments
- SNMP reporting and remote logging
- Industry-standard security techniques, including 802.1X authentication

# Overview of system hardware

The figures and tables in the following topics provide information about hardware features available on your system.

## Poly G7500 Hardware

The following figure displays the hardware features on the Poly G7500 system. The table lists each feature numbered in the figure.

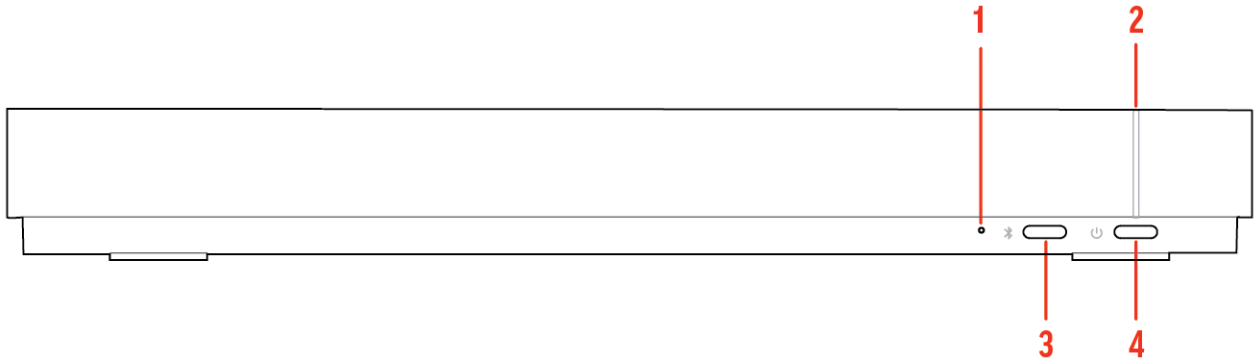
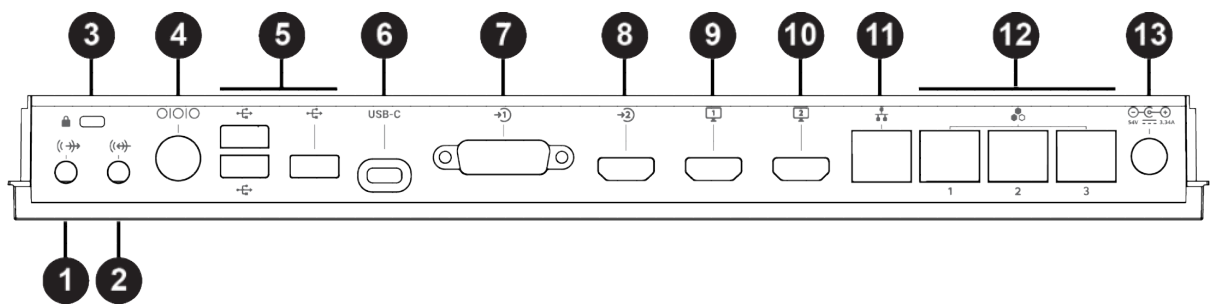

**Table 2-3 Poly G7500 Feature Descriptions**

Ref. Number	Feature	Feature Description
1	Reset button	Resets the Poly G7500 to the factory software version
2	LED indicator	Indicates the system status
3	Remote control pairing button	Enables the Bluetooth remote control pairing mode
4	Restart button	Restarts your system

## Poly G7500 System Ports

The following illustration and table explain the ports on the back panel of your G7500 system.



**Table 2-4 G7500 System Port Descriptions**

Ref. Number	Port Description
1	3.5 mm audio line out
2	3.5 mm audio line in
3	Security lock

**Table 2-4 G7500 System Port Descriptions (continued)**

Ref. Number	Port Description
4	Mini-DIN/RS-232 serial port <b>NOTE:</b> The serial port is occasionally used by third party control system devices for automation.
5	USB-A ports
6	USB-C port
7	HDCI input for Polycom cameras
8	HDMI input for sharing content (for example, from a laptop)
9	HDMI output for the primary monitor
10	HDMI output for the secondary monitor
11	LAN connection for the system
12	Link-local network (LLN) connections for IP-based peripheral devices
13	Power cord port

## Poly Studio X72 hardware

The following illustration and table explain the hardware components on your Poly Studio X72 system.

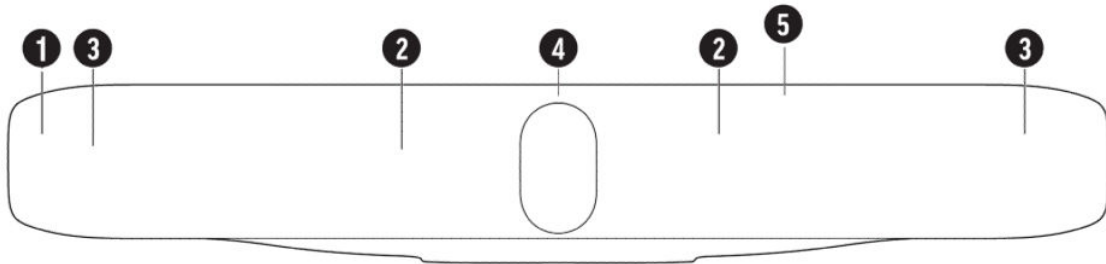

**Table 2-5 Poly Studio X72 hardware components**

Ref. Number	Feature	Description
1	Mesh screen	Protective screen that covers the front of the system
2	Microphone array	Microphone array that captures audio
3	Speakers	Audio output
4	Dual cameras	Camera array with a privacy shutter that automatically opens or closes, depending on the camera state
5	LED indicators	Indicates the system status and information on the tracked speaker

## Poly Studio X72 privacy shutter behavior

The privacy shutter automatically opens and closes depending on the state of the connected video system.

 **NOTE:** Shutter behavior may vary depending on the partner application.

**Table 2-6 Poly Studio X72 privacy shutter behavior**

System event	Shutter behavior
The system powers on	Shutters open
The system powers off	Shutters close
	<b>NOTE:</b> If you remove power immediately, the shutters don't close.
The system enters sleep mode or digital signage starts and the <b>Camera Sleep Setting</b> is set to <b>Save Energy</b>	Shutters close
The system enters sleep mode or digital signage starts and <b>Camera Sleep Setting</b> is set to <b>Fast Wake</b>	Shutters remain open
	<b>NOTE:</b> When <b>Fast Wake</b> is set, the shutters never close.
You wake the system	Shutters open
You wake the system and the built-in camera isn't the primary camera	Shutters remain closed
You select the built-in camera as the primary camera	Shutters open
The system receives an incoming call	Shutters open
The system is sending video	Shutters are open
The system is in an active call and the video is muted	Shutters are open

## Poly Studio X72 hardware ports

The following illustration and table explain the hardware ports on your Poly Studio X72 system.

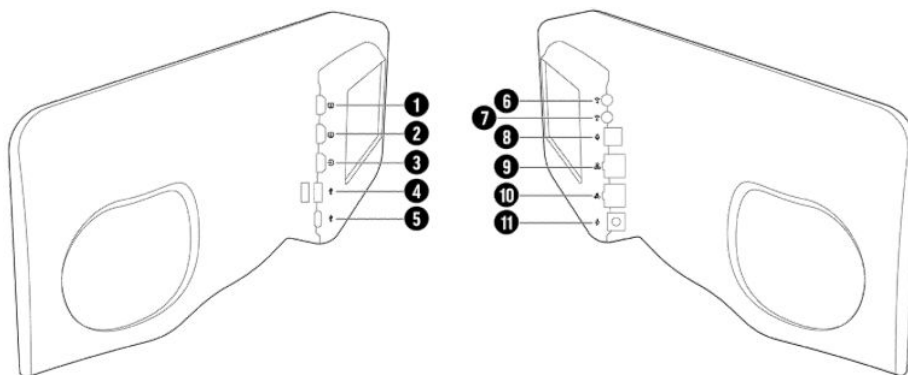

**Table 2-7 Poly Studio X72 hardware port descriptions**

Ref. Number	Port Description
1	HDMI output for the secondary monitor
2	HDMI output for the primary monitor

**Table 2-7 Poly Studio X72 hardware port descriptions (continued)**

Ref. Number	Port Description
3	HDMI input Connects a laptop for content sharing or to use the system monitor in Device Mode Connects an HDMI camera for use as an additional people camera
4	USB-A ports
5	USB Type-C port (for Device Mode only) <b>NOTE:</b> Note: USB Type-C port is used for service, installation, and Poly Device Mode only.
6	3.5 mm audio line in
7	3.5 mm audio line out
8	Expansion microphone connection
9	LAN connection for the system
10	Link-local network (LLN) connections for IP-based peripheral devices (supported in a future Poly VideoOS release)
11	Power cord port

## Poly Studio X70 Hardware

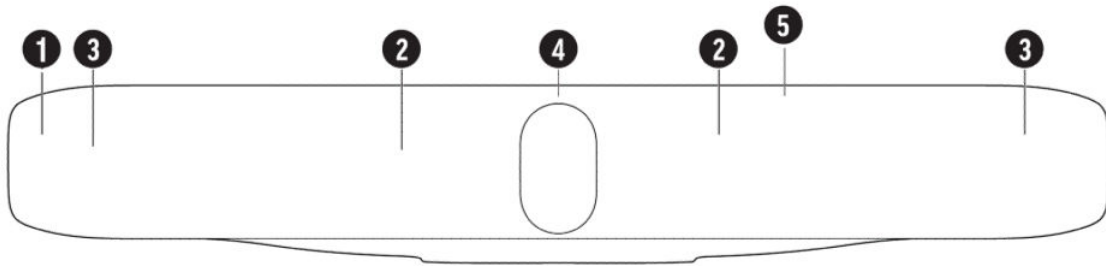
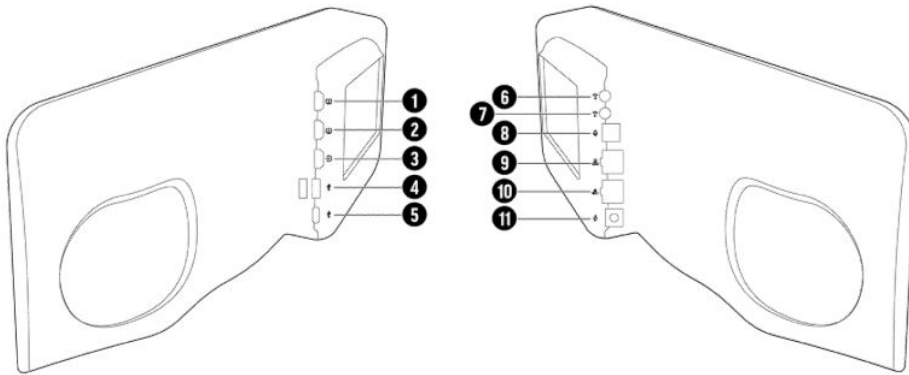

**Table 2-8**

Ref. Number	Feature	Description
1	Screen	Protective screen that covers the front of the system
2	Microphone array	Microphone array that captures audio
3	Speakers	Audio output
4	Dual cameras	Camera array with a privacy shutter that automatically opens or closes, depending on the camera state
5	LED indicators	Indicates the system status and information on the tracked speaker

## Poly Studio X70 System Hardware Ports

The following illustration and table explain the hardware ports on your Poly Studio X70 system.



**Table 2-9** Poly Studio X70 System Hardware Port Descriptions

Ref. Number	Port Description
1	HDMI output for the secondary monitor
2	HDMI output for the primary monitor
3	HDMI input for sharing content (for example, from a laptop)
4	USB-A ports
5	USB-C port
6	3.5 mm audio line in
7	3.5 mm audio line out
8	Expansion microphone connection
9	LAN connection for the system
10	Link-local network (LLN) connections for IP-based peripheral devices <b>NOTE:</b> This port is disabled and is reserved for future use.
11	Power cord port

## Poly Studio X70 and Poly Studio X72 Privacy Shutter Behavior

The privacy shutter automatically opens and closes depending on the state of the connected video system.

### Poly Studio X70 Privacy Shutter Behavior

**NOTE:** Shutter behavior may vary depending on the partner application.

System Event	Shutter Behavior
The system powers on	Shutters open
The system powers off	Shutters close <b>NOTE:</b> If you remove power immediately, the shutters don't close.

System Event	Shutter Behavior
The system enters sleep mode or digital signage starts and the <b>Camera Sleep Setting</b> is set to <b>Save Energy</b>	Shutters close
The system enters sleep mode or digital signage starts and <b>Camera Sleep Setting</b> is set to <b>Fast Wake</b>	Shutters remain open <b>NOTE:</b> When <b>Fast Wake</b> is set, the shutters never close.
You wake the system	Shutters open
You wake the system and the Studio X70 built-in camera isn't the primary camera	Shutters remain closed
You select the Studio X70 built-in camera as the primary camera	Shutters open
The system receives an incoming call	If the shutters are closed, they remain closed until the call is answered
The system is sending video	Shutters are open
The system is in an active call and the video is muted	Shutters are open

## Poly Studio X52 Hardware

The following figure displays the hardware features on the Poly Studio X52 system. The table lists each feature numbered in the figure.

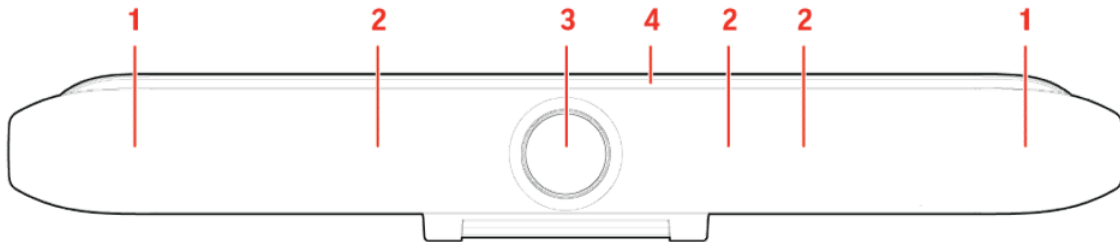
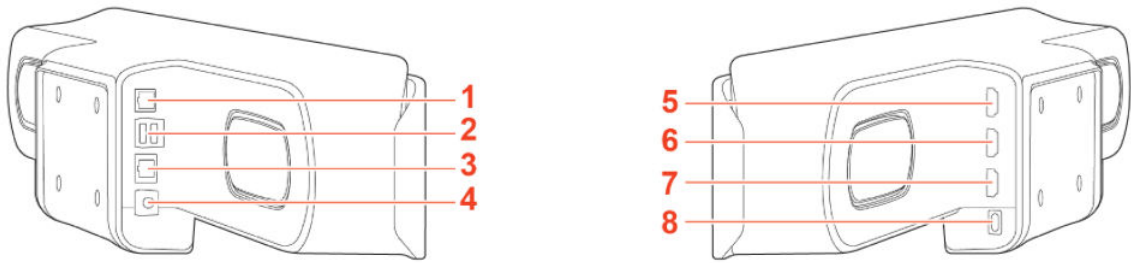

**Table 2-10** Poly Studio X52 Feature Descriptions

Ref. Number	Feature	Feature Description
1	Speakers	Audio output
2	Microphone array	Microphone array that captures audio
3	Camera	Camera with a privacy cover that enables or disables the video input as you choose
4	LED indicators	Indicates the system status and information on the tracked speaker

## Poly Studio X52 System Ports

The following illustration and table explain the ports on your Poly Studio X52 system.

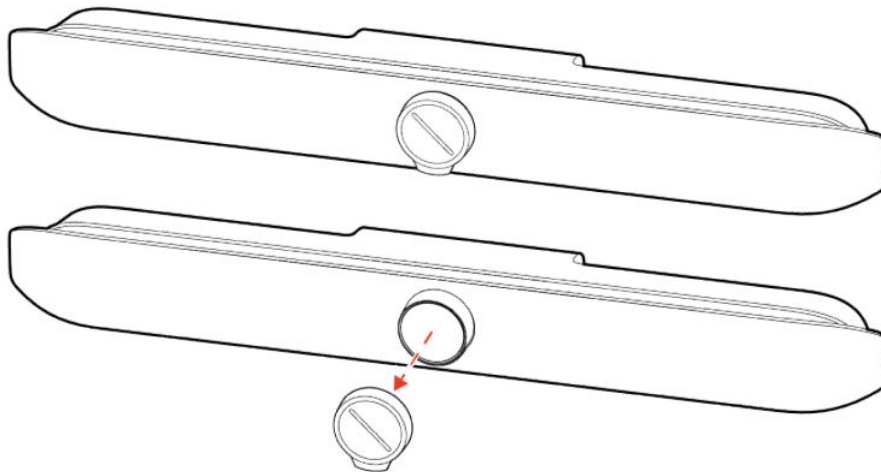

**Table 2-11 Poly Studio X52 System Port Descriptions**

Ref. Number	Port Description
1	Poly Table Expansion Microphone connection
2	USB-A ports
3	RJ45 Ethernet port
4	Power port
5	HDMI port for secondary monitor
6	HDMI port for primary monitor
7	HDMI port for content sharing and Device Mode
8	USB-C port for Device Mode

### Poly Studio X52 Privacy Cover

The Poly Studio X52 system provides a physical cover that you can place over the camera lens to protect your privacy.



### Poly Studio X50 Hardware

The following figure displays the hardware features on the Poly Studio X50 system. The table lists each feature numbered in the figure.

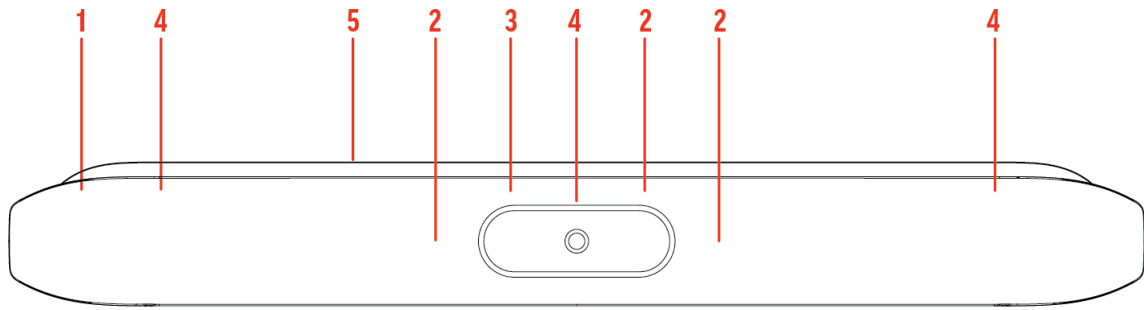
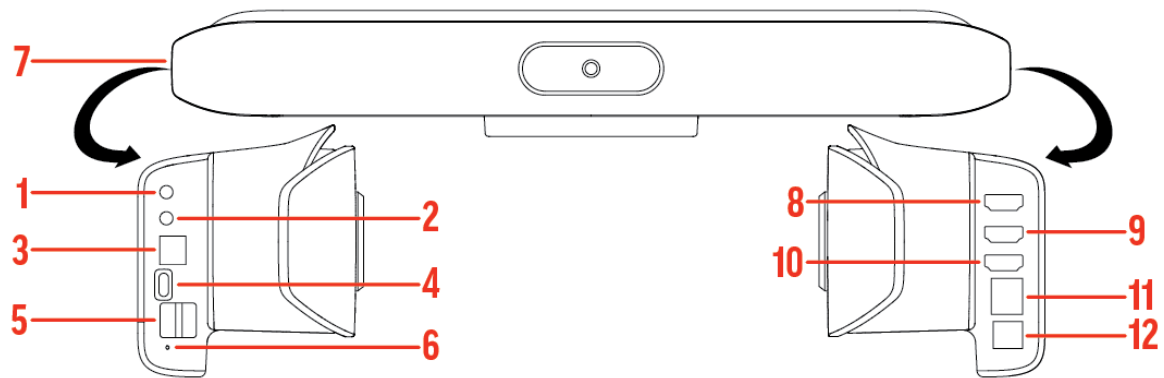

**Table 2-12 Poly Studio X50 Feature Descriptions**

Ref. Number	Feature	Feature Description
1	Screen	Protective screen that covers the front of your system
2	Microphone array	Microphone array that captures audio
3	Camera	Camera with a privacy cover that enables or disables the video input as you choose
4	Speakers	Audio output
5	LED indicators	Indicates the system status and information on the tracked speaker

## Poly Studio X50 System Ports

The following illustration and table explain the ports on your Poly Studio X50 system.



**Table 2-13 Poly Studio X50 System Port Descriptions**

Ref. Number	Port Description
1	3.5 mm audio line in
2	3.5 mm audio line out
3	Polycom RealPresence Debut expansion microphone connection
4	USB-C port
5	USB-A ports
6	Factory restore pinhole
7	Security lock (on the back flat section of the system)
8	HDMI output for the secondary monitor

**Table 2-13 Poly Studio X50 System Port Descriptions (continued)**

Ref. Number	Port Description
9	HDMI output for the primary monitor
10	HDMI input for sharing content (for example, from a laptop)
11	LAN connection for the system
12	Power cord port

## Poly Studio X50 Privacy Cover

The Poly Studio X50 provides a physical cover that you can place over the camera lens to protect your privacy.

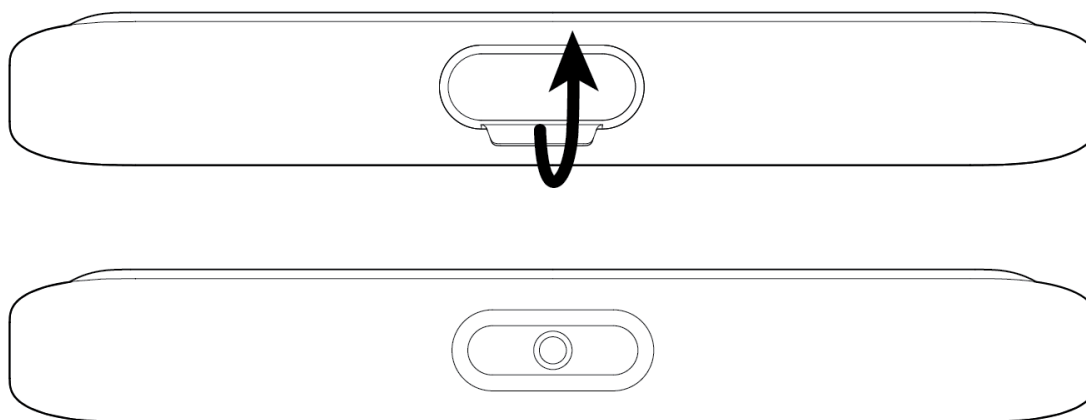

## Poly Studio X30 Hardware

The following figure displays the hardware features on the Poly Studio X30 system. The table lists each feature numbered in the figure.

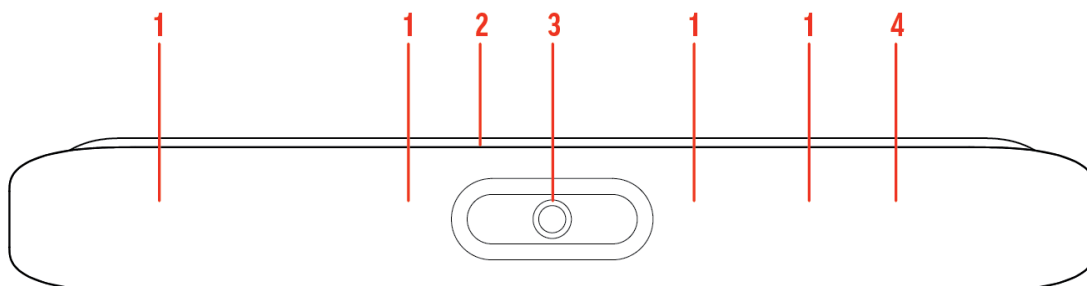
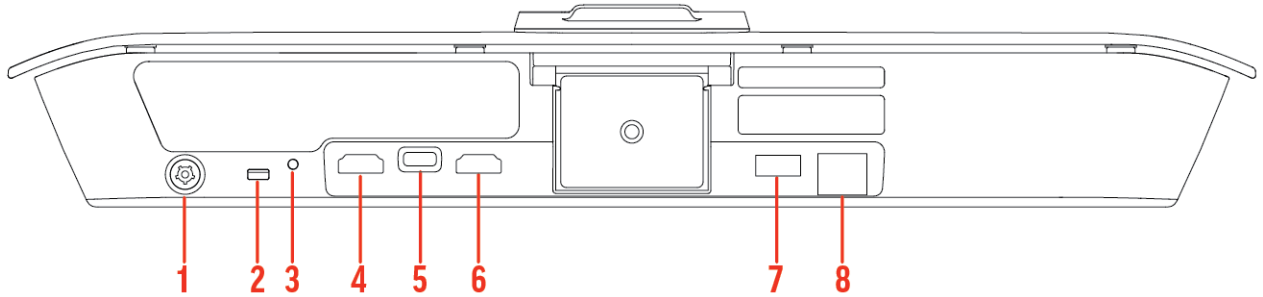

**Table 2-14 Poly Studio X30 Feature Descriptions**

Ref. Number	Feature	Feature Description
1	Microphone array	Microphone array that captures audio
2	LED indicators	Indicates the system status and information on the tracked speaker
3	Camera	Camera with a privacy cover that enables or disables the video input as you choose
4	Speaker	Mono audio output

## Poly Studio X30 System Ports

The following illustration and table explain the ports on your Poly Studio X30 system.

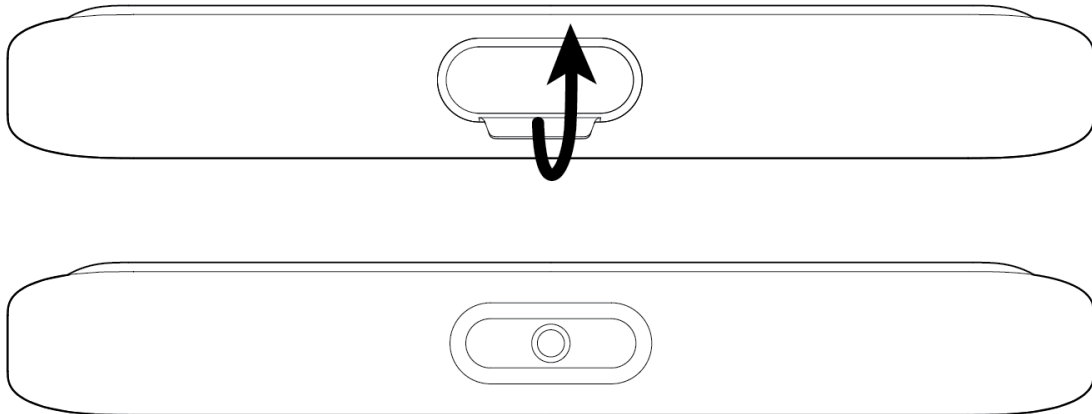

**Table 2-15** Poly Studio X30 System Port Descriptions

Ref. Number	Port Description
1	Power cord port
2	Security lock
3	Factory restore pinhole
4	HDMI output for the primary monitor
5	USB-C port
6	HDMI input for sharing content (for example, from a laptop)
7	USB-A ports
8	LAN connection for the system

## Poly Studio X30 Privacy Cover

The Poly Studio X30 provides a physical cover that you can place over the camera lens to protect your privacy.



## Poly Studio E70 Camera Hardware

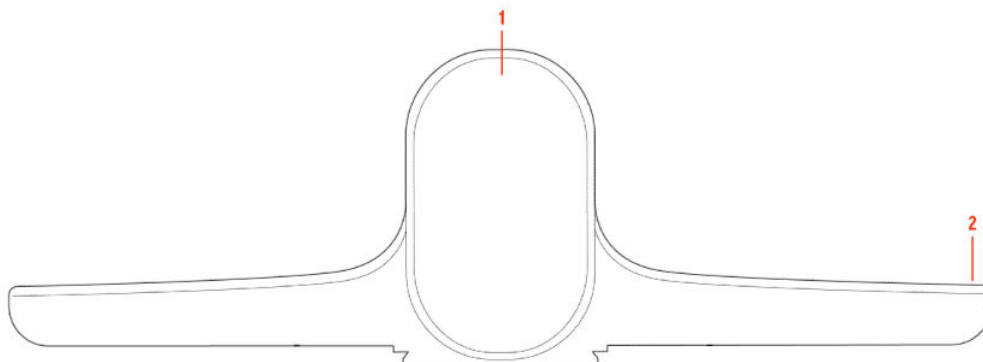
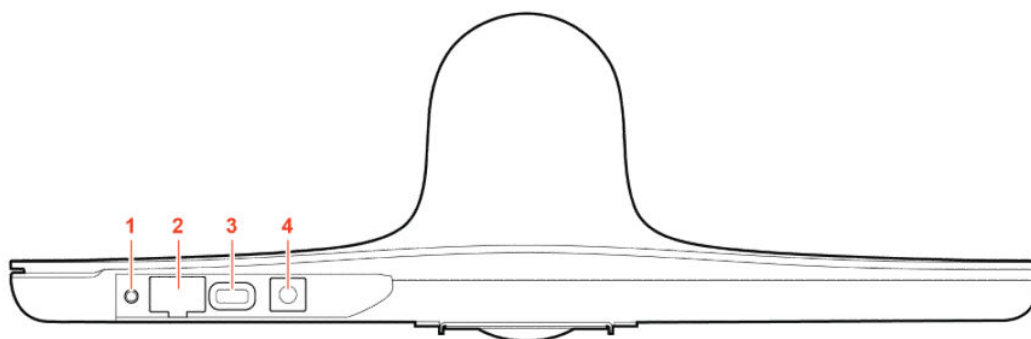

**Table 2-16 Poly Studio E70 Feature Descriptions**

Reference Number	Feature	Description
1	Dual-cameras	Camera array with a privacy shutter that automatically opens or closes depending on the camera state
2	LED indicators	Front and right indicators that show the status of the camera

## Poly Studio E70 Ports

The following illustration and table explain the ports on your Poly Studio E70 camera.



**Table 2-17 Poly Studio E70 Port Descriptions**

Ref. Number	Port Description
1	Reset button
2	Ethernet port (Can be used to provide power to the camera)
3	USB-C port

**Table 2-17 Poly Studio E70 Port Descriptions (continued)**

Ref. Number	Port Description
4	Power cord port

## Poly Studio E70 Privacy Shutter Behavior

The privacy shutter automatically opens and closes depending on the state of the connected video system.



**NOTE:** Shutter behavior may vary depending on partner application.

**Table 2-18 Poly Studio E70 shutter behavior**

System event	Shutter behavior
The system powers on	Shutters open
The system powers off	Shutters close <b>NOTE:</b> If you remove power immediately, the shutters don't close.
The system enters sleep mode or digital signage starts and the <b>Camera Sleep Setting</b> is set to <b>Save Energy</b>	Shutters close
The system enters sleep mode or digital signage starts and <b>Camera Sleep Setting</b> is set to <b>Fast Wake</b>	Shutters remain open <b>NOTE:</b> When <b>Fast Wake</b> is set, the shutters never close.
You wake the system	Shutters open
You wake the system and the Studio E70 isn't the primary camera	Shutters remain closed
You select the Studio E70 as the primary camera	Shutters open
The Studio E70 isn't the primary camera and is idle for five minutes	Shutters close
The system receives an incoming call	If the shutters are closed, they remain closed until the call is answered
The system is sending video	Shutters are open
The system is in an active call and the video is muted	Shutters are open

# LED Status Indicators

The following topics list the LED behavior for your system. The tables list each LED indicator and its associated status.

## LED Status Indicators for the Poly G7500 System

Use the LED on the front right corner of the codec to get information on the state of your system.

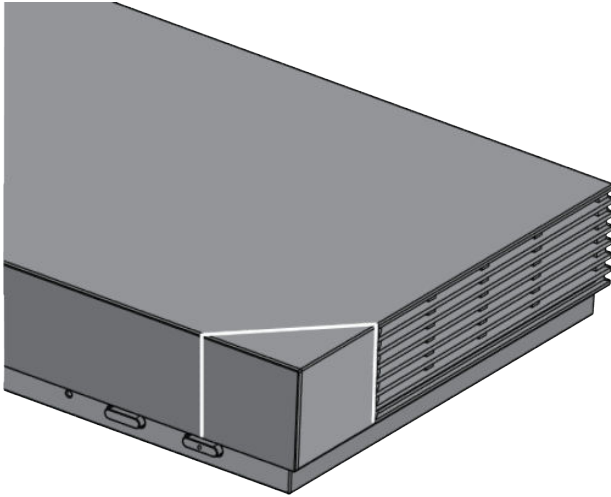

**Table 2-19** Poly G7500 System LED Status Indicators

Indicator	Status
Blinking white	Powering on
Solid white	Working normally
Solid green	In a call
Blinking amber	Update in progress.
Solid amber	Sleeping
Blinking red	Error preventing normal operation
Solid red	Muted microphone

## LED status indicators for the Poly Studio X72 and Poly Studio X70 systems

Use the LED on the right side of the system to help you understand the system's behaviors.

**Table 2-20** Poly Studio X72 and Poly Studio X70 LED Indicators and Status

Indicator	Status
Solid white	Device is idle and standing by
Pulsing white	Boot initiation in progress
Pulsing amber	Firmware update or factor restore in progress
Blinking blue and white	Bluetooth pairing
Solid blue	Bluetooth paired

**Table 2-20 Poly Studio X72 and Poly Studio X70 LED Indicators and Status (continued)**

Indicator	Status
Solid green	Active call in progress
Solid red	Audio mute

## LED Status Indicators for Poly Studio X50 and Poly Studio X30 Systems

The system provides an LED light bar above the camera to help you understand the system's behaviors.

**Table 2-21 Poly Studio X50 and Studio X30 LED Indicators and Status**

Indicator	Position	Status
Solid white	All	Boot initialization in progress
Blinking blue	Twelve in the middle	Bluetooth in discover
Solid blue for 3 seconds	All	Bluetooth paired
Blinking green	All	Incoming call
Solid green	All	Outgoing call
Solid green	Four to eight (when in the middle), indicating the tracked speaker or the direction of the camera	Working  The lights are green with supported applications in the following cases: <ul style="list-style-type: none"> <li>Tracking people in group framing and speaker tracking mode</li> <li>Indicating the direction of the camera that you customize in pan-tilt-zoom (PTZ) mode</li> </ul>
Solid amber	Twelve in the middle	Standing by  System in sleep mode with no active video output
Pulsing red	Twelve in the middle	Call on hold
Pulsing green	Twelve in the middle	Call on hold (by far site)
Solid white for 3 seconds	Twelve in the middle	Saving a preset
Solid red	All	Muted microphone
Solid red	Four in the middle	Muted camera Muted microphone LEDs take precedence over camera mute LEDs
Pulsing amber	All	Firmware update in progress
Blinking red	All	Error preventing normal operation
Blinking amber	Twelve alternating	In a POST sequence, at least one test results in a warning error. The system continues to blink amber but initializes after the sequence is complete if no severe errors occur.

## LED Status Indicators for the Poly Studio E70 Camera

The camera provides LED indicators on the front and right side of the camera to help you understand the camera's behaviors when connected to a Poly Studio G62, Poly G7500, or Poly Studio X system.

**Table 2-22 Poly Studio E70 Camera System LED Status Indicators**

Color and Pattern	Status
Pulsing white	Boot initialization is in progress
Solid white (50% brightness)	Powered on but disconnected from video system Sleep mode
Solid white (100% brightness)	Powered on and connected to the video system
Solid green	In a call or the camera is active
Pulsing amber	Firmware update or factory reset in progress
Flashing blue	Camera is IP pairing

**NOTE:** If LED continues to flash blue, unplug and then replug the Poly Studio E70 camera.

## Powering the System On and Off

The system powers on when you plug it in to a power source.

Poly recommends the following when powering off or restarting your system:

- Don't restart or power off the system during maintenance activities (for example, while a software update is in progress).

## Wake the System

After a period of no activity, the system enters sleep mode (if configured by your administrator). You can wake it using a touch monitor or Poly TC8.

- Do one of the following:
  - If you're using a touch monitor, tap the primary screen.
  - If you're using the TC8, tap the screen.
  - If you're using a Poly Trio, tap the screen.

# Accessibility Features

Poly products include a number of features to accommodate users with disabilities.

 **NOTE:** Accessibility features for Poly Studio G62 include peripherals required for system functionality included connected cameras, microphones, speakers, and monitors.

## Users Who Are Deaf or Hard of Hearing

Your system includes accessibility features so that users who are deaf or hard of hearing can use the system.

The following table lists the accessibility features for users who are deaf or hard of hearing.

**Table 2-23 Accessibility Features for Users Who Are Deaf or Hard of Hearing**

Accessibility Feature	Description
Visual notifications	Status and icon indicators let you know when you have incoming, outgoing, active, or held calls. Indicators also alert you of the device's status and when features are enabled.
Status indicator lights	The system uses LEDs to indicate some statuses, including if your microphones are muted.
Adjustable call volume	While in a call, you can raise or lower the volume of the device.
Auto-answering	You can enable the system to auto-answer calls.

## Users Who Are Blind, Have Low Vision, or Have Limited Vision

Your system includes accessibility features so that users who are blind, have low vision, or have limited vision can use the system.

The following table lists the accessibility features for users who are blind, have low vision, or have limited vision.

**Table 2-24 Accessibility Features for Users Who Are Blind, Have Low Vision, or Have Limited Vision**

Accessibility Feature	Description
Auto-answering	You can enable the system to auto-answer calls.
Adjustable backlight settings	You can change the brightness of the screen by adjusting backlight intensity settings.
Visual notifications	Status and icon indicators let you know when you have incoming, outgoing, active, or held calls. Indicators also alert you of the device's status and when features are enabled.

## Users with Limited Mobility

Your system includes accessibility features so that users with limited mobility can use various system features.

The following table lists the accessibility features for users with limited mobility.

**Table 2-25 Accessibility Features for Users with Limited Mobility**

<b>Accessibility Feature</b>	<b>Description</b>
Alternative control interface	This product provides an alternative control interface for the connected video conferencing system for people with disabilities that cause limited manipulation issues.
Auto-answering	You can enable the system to auto-answer calls.
Calling from a personal device	With administrator credentials, you can wirelessly access the system web interface from your own device to make calls and manage contacts and favorites.
Flexible mounting/display configurations	Product isn't stationary and can be mounted or displayed in various configurations. Touch controls require minimal strength to operate.

---

## 3 Sharing Content

To enhance the collaboration experience, you can share documents, graphics, and videos with other participants using a computer.

### Share Content Using an HDMI Connection

Share content from your device through an HDMI connection. This method doesn't require you to connect using a wireless service.

- Connect your device to the video system's HDMI input port.

---

## 4 Using device mode

Poly Device Mode enables you to use the system's camera, speaker, microphone, and connected monitors from your computer.

Once you connect the system to your computer with a USB cable, you can control the video system's camera and audio features using your computer's third-party conferencing application.

For example, instead of using your computer's camera for Zoom Rooms calls, connect the Studio X30 and use its 4K camera to automatically follow the conversation in the room. You also gain a Poly echo-cancelling microphone and speaker technology during calls.



---

**NOTE:** The system doesn't support hot plugging cameras. To connect a camera to the system, power the system off, connect the camera, and restart the system.

---

### Computer and cable requirements for Device Mode

Your computer and cables must meet the following requirements to use Device Mode.

Operating system requirements:

- Windows 10 1803 or later
- macOS 10.12 or later

USB cable requirements:

- A cable with at least one USB-C connection for the video system
- USB 2.0 or USB 3.0 cable (preferred to ensure connection reliability and video and audio quality)
- Self-powered USB booster extension cable for connections longer than 2 m (6.6 ft)



---

**NOTE:** Don't use a cable used for charging devices. A charging cable may not be capable of sending data.

---

HDMI cable requirements:

- An HDMI adapter is required if your computer doesn't have an HDMI port.

## Access Device Mode

Use the system touchscreen or a TC10 or TC8 touch controller to start Device Mode.

---

 **NOTE:** Your administrator may configure your system to remain in Device Mode. If your system is already in Device Mode, the system monitor and TC10 or TC8 touch controller prompt you to connect a USB and HDMI cable to your computer.

---

- Do one of the following:
  - From the right border of your screen, swipe left. Select **Device Mode** .
  - When using Zoom Rooms, connect the USB-C cable to the video system and connect the other end of the USB cable to your computer to automatically enter Device Mode.

The *Device Mode* screen appears.

## Use your system as a computer accessory

To use the video system as an external camera and audio accessory, set your system to Device Mode and connect your Windows or macOS computer with a USB cable.

If your system isn't already in Device Mode, access **Device Mode**. If your conferencing application uses echo cancellation, disable that feature.

You must use a cable with at least one USB-C connection for your video system. If you use a cable with only one USB-C connection, the USB-C end must connect to your video system for Device Mode to work properly.

---

 **NOTE:** Device Mode isn't available if your system administrator disables the system USB ports. If you need help with Device Mode or connecting a computer to your system, contact your administrator.

---

1. Connect a USB-C end of the USB cable to the video system's USB-C port, and connect the other end of the USB cable to your computer.

The system monitor and the TC10 or TC8 touch controller display a confirmation message.

If you're using Microsoft Teams or Zoom Rooms, Device Mode automatically starts when you connect the USB cable to your computer. Once you disconnect the USB cable, the system automatically exits Device Mode in 20 to 30 seconds.

2. **Optional:** To display your computer on the video system monitor, connect your computer using the system's HDMI input port.

## Adjust the system audio and camera settings in Device Mode

In Device Mode, you can mute the system, adjust the volume, and adjust camera settings.

Access **Device Mode** and connect your computer to the system.

---

 **NOTE:** The controls on a connected Poly Trio phone don't work if the system is in Device Mode.

---

1. To mute the microphones, do one of the following:
  - In a conference application on your computer, select mute.
  - On the touch controller or any connected microphone, select **Mute** .
2. To adjust the volume, do one of the following:
  - On the touchscreen or TC10 or TC8, select **Volume** and adjust the volume slider.
  - Adjust the volume from your computer using the computer or conference application settings.

---

 **NOTE:** Ensure that you select the correct device when adjusting the volume. Changing the volume alone may not work. You must select the Poly video system as the audio device.

---

3. To configure camera settings:
  - a. From the right border of the TC10 or TC8 or the touchscreen, swipe left and select **Camera Settings**.
  - b. Select **Camera Control**.
    - Turn **Camera Tracking** on or off.
    - Select or set a **Preset**.
    - Press **+** to zoom in or **-** to zoom out.
    - Press the arrows to tilt up and down or to pan left to right.

## Managing incoming calls when in Device Mode

If there's an incoming call, your video system may exit Device Mode. This depends on the partner conferencing application you're using for the video system.

## Exit Device Mode and disconnect your computer

Any camera options you change on the video system with your USB-connected computer revert to their previous settings when you exit Device Mode.

---

 **NOTE:** If the system is using Device Mode as the provider, **Exit**  isn't available.

---

- Do one of the following:
  - On the video system local interface or TC10 or TC8 touch controller, select **Exit** .
  - Unplug the cables connecting your computer and video system. After a short delay, you see the home screen (even if you haven't selected **Exit**).

---

# 5 Settings

Before or during calls, you can adjust the system volume. During calls, you can adjust your camera's position.

# Cameras

Depending on the camera type, you can control the following options:

- Adjust near-site (local) camera positions.
- Turn tracking on or off.

## Adjust an In-Room Camera

To enhance the view of meeting participants, make adjustments to the in-room camera.

If camera tracking is on, camera control is unavailable. Turn tracking off to access camera controls.



You can only make camera adjustments during a call.

With the Studio X50 and Studio X30 systems, you can't pan or tilt the camera if it's zoomed all the way out.

1. From the right border of your screen, swipe left.
2. Go to **Camera Settings** > **Camera Controls**.
3. Press **+** to zoom in or **-** to zoom out. Press the arrows to tilt up and down or to pan left to right.
4. To exit the control screen, select **Back** ←.

## Turn Camera Tracking On or Off

When camera tracking is on, the camera automatically frames the group of people in the room or the current speaker (depending on your camera and how your system is configured).

1. From the right border of your screen, swipe left.
2. Select **Camera Settings**.
3. Select **Tracking On**  or **Tracking Off** .

## Audio Adjustments

You can control several audio settings on the system.

### Adjust the Volume

You can adjust the volume before or during a call.

- Use the volume slider on the device controlling your video system.

---

# 6 Troubleshooting

This section includes information related to troubleshooting issues with your system. You can also find information on pairing your remote, configuring your monitors, and where to find help tips.

# Poly Device Mode

Use these topics to troubleshoot problems you may encounter using Device Mode.

## Audio Levels are Too High or Low

In Device Mode, audio from the video system speakers is too loud or it's difficult to hear call participants.

In Device Mode, your conferencing application and laptop control the video system's audio. You may need to adjust those volume controls.

Follow these steps until you get the audio levels you want:

1. Adjust your conferencing application's volume.
2. Adjust your laptop's volume.

## Conferencing Application Doesn't Use System Camera or Audio

Your conferencing application isn't using the video system's camera or audio in Device Mode.

Your conferencing application by default may choose the connected monitor speakers instead of, for example, the Studio X50 speakers.

- In your conferencing application, select the video system as your speaker, microphone, and camera device.

## Can't Use System's Camera or Audio

Your conferencing application isn't using the video system's camera or audio in Device Mode. There could be a few reasons for these types of problems. For instance, your conferencing application by default may choose the connected monitor speakers instead of, for example, the Studio X50 speakers.

You may notice the following while using Device Mode:

- In your laptop's conferencing application, you can't select the video system as a camera or audio source.
- The video system's camera and audio seem unavailable.
- The video system's camera doesn't display live video.

Follow these steps until you fix your problem:

1. In your conferencing application, select the video system as your speaker, microphone, and camera device.
2. In your laptop settings, select the video system as your speaker, microphone, and camera device.
3. Exit and restart Device Mode.
4. Replug the USB cable.
5. Connect the cable to a different USB port on your laptop.
6. Try using a different USB cable.

7. Restart your laptop.

## Improve Audio Quality

Audio quality during calls in Device Mode could be better. For example, people on the call notice interference or dropped words when you're speaking.

You may encounter these problems for the following reasons: additional USB connections, a bad cable, or audio processing settings.

Follow these steps until your audio quality improves:

1. Remove USB audio devices (such as a headset) connected to your laptop.
2. Connect your laptop and video system with a different USB cable.
3. If your conferencing application uses echo cancellation, disable that feature.
4. If you're playing a musical instrument, enable M-Mode in the system web interface.

## Improve Laptop Screen Mirroring

When mirroring your laptop screen with an HDMI connection, the picture on the connected monitor isn't ideal.

The resolution on your laptop may need to be adjusted for the monitor connected to the Poly video system.

Follow these steps until screen mirroring quality improves:

1. Adjust your laptop's resolution settings.
2. Adjust your laptop's display settings so the screen duplicates on the monitor.

---

# 7 Getting help

Poly is now a part of HP. The joining of Poly and HP paves the way for us to create the hybrid work experiences of the future. Information about Poly products has transitioned from the Poly Support site to the HP Support site.

The [Poly Documentation Library](#) is continuing to host the installation, configuration/administration, and user guides for Poly products in HTML and PDF format. In addition, the Poly Documentation Library provides Poly customers with information about the transition of Poly content from Poly Support to [HP Support](#).

The [HP Community](#) provides additional tips and solutions from other HP product users.

## HP Inc. addresses

### HP US

HP Inc.  
1501 Page Mill Road  
Palo Alto 94304, U.S.A.  
650-857-1501

### HP Germany

HP Deutschland GmbH  
HP HQ-TRE  
71025 Boeblingen, Germany

### HP UK

HP Inc UK Ltd  
Regulatory Enquiries, Earley West  
300 Thames Valley Park Drive  
Reading, RG6 1PT  
United Kingdom

## Document information

**Model ID:** Poly Bluetooth® Remote Control (model: P010), Poly IR Receiver (model: BW7650), Poly IR Remote (model: BW7600), Poly Microphone IP Adapter (model: P012), Poly IP Table Microphone (model: P013), Poly IP Ceiling Microphone (model: P014), Poly Studio X70 (model: P026), Poly Studio X50 (model: P017), Poly Studio X30 (model: P018), Poly Studio E70 (model: P025), Poly TC10 (model: P030), Poly TC8 (model: P020), Poly Studio G62 (Radio model: PBJ-STG-62R, No radio model: PBJ-STG-62N), Poly Studio X72 (Radio model: PATX-STX-72R, No radio model: PATX-STX-72N)

**Document part number:** P10730-001A

**Last update:** November 2024

Email us at [documentation.feedback@hp.com](mailto:documentation.feedback@hp.com) with queries or suggestions related to this document.