

OMEGA™

AV Presentation and Collaboration System

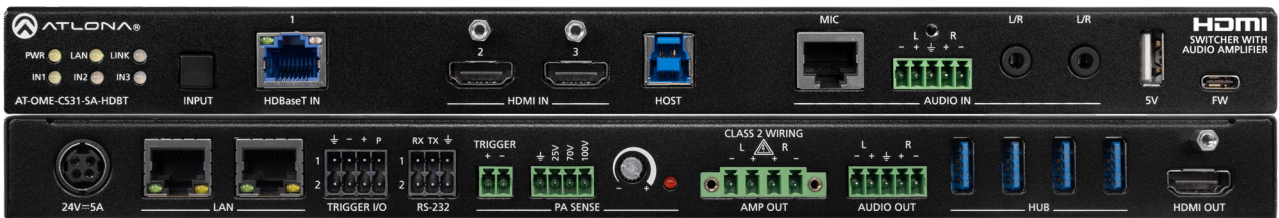

Version Information

Version	Release Date	Notes
3	Jun 2024	Added mounting instructions. Refer to Mounting Instructions (page 87) .

Sales, Marketing, and Customer Support

Main Office

Atlona Incorporated
70 Daggett Drive
San Jose, CA 95134
United States

Office: +1.408.962.0515

Sales and Customer Service Hours
Monday - Friday: 6:00 a.m. - 4:30 p.m. (PST)

<https://atlona.com/>

International Headquarters

Atlona International AG
Tödistrasse 18
8002 Zürich
Switzerland

Office: +41.43.508.4321

Sales and Customer Service Hours
Monday - Friday: 09:00 - 17:00 (UTC +1)

Operating Notes



IMPORTANT: Visit <https://www.atlona.com/product/at-ome-cs31-sa-hdbt> for the latest firmware updates and User Manual.

Warranty



To view the product warranty, use the following link or QR code:

<https://atlona.com/warranty/>.

Safety and Certification



The lightning flash with arrowhead symbol, within an equilateral triangle, is intended to alert the user to the presence of uninsulated “dangerous voltage” within the product’s enclosure that may be of sufficient magnitude to constitute a risk of electric shock to persons.

Das Symbol des Blitzzeichens innerhalb eines gleichseitigen Dreiecks soll den Benutzer davor warnen, dass innerhalb des Gehäuses gefährlich hohe Spannung an berührbaren Teilen anliegt. Die Spannung ist hoch genug um bei Berührung zu einem gefährlichen elektrischen Schlag zu führen!

三角形內帶有箭頭符號的閃電，旨意在提醒用戶產品外殼內存在未絕緣的“危險電壓”可能會造成人體觸電危險

Вспышка молнии с символом стрелки в треугольнике предназначена для предупреждения пользователя о наличии неизолированного «опасного напряжения» в корпусе продукта, которое может иметь достаточную величину, чтобы представлять опасность поражения электрическим током для людей

Le flash lumineux dans le symbole de la flèche du triangle équilatéral est destiné à alerter l'utilisateur de la présence d'une «tension dangereuse» non isolée dans l'enceinte du produit qui peut être suffisamment importante pour constituer un risque d'électrocution pour les personnes

Il simbolo del lampo con la punta di una freccia, all'interno di un triangolo equilatero, avvisa l'utente della presenza di “tensioni pericolose” non isolate all'interno del contenitore del prodotto che possono essere sufficientemente elevate da costituire un rischio di folgorazione per le persone.

El símbolo del rayo con punta de flecha dentro de un triángulo equilátero alerta al usuario de la presencia de “voltaje peligroso” no aislado en el interior del producto que puede ser de una magnitud suficiente como para constituir un riesgo de descarga eléctrica para las personas.

Safety and Certification



CAUTION: TO REDUCE THE RISK OF ELECTRIC SHOCK DO NOT OPEN ENCLOSURE OR EXPOSE TO RAIN OR MOISTURE. NO USER-SERVICEABLE PARTS INSIDE REFER SERVICING TO QUALIFIED SERVICE PERSONNEL.



The exclamation point within an equilateral triangle is intended to alert the user to the presence of important operating and maintenance instructions in the literature accompanying the product.



The information bubble is intended to alert the user to helpful or optional operational instructions in the literature accompanying the product.

1. Read these instructions.
2. Keep these instructions.
3. Heed all warnings.
4. Follow all instructions.
5. Do not use this product near water.
6. Clean only with a dry cloth.
7. Do not block any ventilation openings. Install in accordance with the manufacturer's instructions.
8. Do not install or place this product near any heat sources such as radiators, heat registers, stoves, or other apparatus (including amplifiers) that produce heat.
9. Do not defeat the safety purpose of a polarized or grounding-type plug. A polarized plug has two blades with one wider than the other. A grounding type plug has two blades and a third grounding prong. The wide blade or the third prong are provided for your safety. If the provided plug does not fit into your outlet, consult an electrician for replacement of the obsolete outlet.
10. Protect the power cord from being walked on or pinched particularly at plugs, convenience receptacles, and the point where they exit from the product.
11. Only use attachments/accessories specified by Atlona.
12. To reduce the risk of electric shock and/or damage to this product, never handle or touch this unit or power cord if your hands are wet or damp. Do not expose this product to rain or moisture.
13. Unplug this product during lightning storms or when unused for long periods of time.
14. Refer all servicing to qualified service personnel. Servicing is required when the product has been damaged in any way, such as power-supply cord or plug is damaged, liquid has been spilled or objects have fallen into the product, the product has been exposed to rain or moisture, does not operate normally, or has been dropped.



FCC Compliance

FCC Compliance and Advisory Statement: This hardware device complies with Part 15 of the FCC rules. Operation is subject to the following two conditions: 1) this device may not cause harmful interference, and 2) this device must accept any interference received including interference that may cause undesired operation. This equipment has been tested and found to comply with the limits for a Class A digital device, pursuant to Part 15 of the FCC Rules. These limits are designed to provide reasonable protection against harmful interference in a commercial installation. This equipment generates, uses, and can radiate radio frequency energy and, if not installed or used in accordance with the instructions, may cause harmful interference to radio communications. However there is no guarantee that interference will not occur in a particular installation. If this equipment does cause harmful interference to radio or television reception, which can be determined by turning the equipment off and on, the user is encouraged to try to correct the interference by one or more of the following measures: 1) reorient or relocate the receiving antenna; 2) increase the separation between the equipment and the receiver; 3) connect the equipment to an outlet on a circuit different from that to which the receiver is connected; 4) consult the dealer or an experienced radio/TV technician for help. Any changes or modifications not expressly approved by the party responsible for compliance could void the user's authority to operate the equipment. Where shielded interface cables have been provided with the product or specified additional components or accessories elsewhere defined to be used with the installation of the product, they must be used in order to ensure compliance with FCC regulations.

Copyright, Trademark, and Registration

© 2024 Atlona Inc. All rights reserved. "Atlona" and the Atlona logo are registered trademarks of Atlona Inc. Pricing, specifications and availability subject to change without notice. Actual products, product images, and online product images may vary from images shown here.

HDMI™ The terms HDMI, HDMI High-Definition Multimedia Interface, HDMI trade dress and the HDMI Logos are trademarks or registered trademarks of HDMI Licensing Administrator, Inc.

Dolby, Dolby Atmos, and the double-D symbol are registered trademarks of Dolby Laboratories Licensing Corporation.

For DTS patents, see <http://patents.dts.com>. Manufactured under license from DTS, Inc. DTS, the Symbol, DTS and the Symbol together, and Digital Surround are registered trademarks and/or trademarks of DTS, Inc. in the United States and/or other countries. © DTS, Inc. All Rights Reserved.

All other trademark(s), copyright(s), and registered technologies mentioned in this document are the properties of their respective owner(s).

Table of Contents

Introduction	8
Features	9
Package Contents	9
Panel Description	10
Front Panel	10
Rear Panel	11
Installation	12
Connection Instructions	12
Connection Diagram	14
IP Configuration	15
Obtaining the Current IP Address	15
Automatic Private IP Addressing (APIPA) Mode	15
Device Operation	16
LED Indicators	16
Logging in to the Web Server	17
Login Registration	17
Logging in after Registration	18
System Configuration	19
Getting the MAC Address	19
Setting the IP Mode	19
Changing the Telnet Port	21
Setting the Host Name	22
Auto Switching	23
Enabling / Disabling Auto Switching	23
Setting the Fallback Input	24
Input Switching	25
Using the Front Panel	25
Using the Web Server	26
HDMI Output +5V	26
HDCP Content	27
EDID Management	28
Using the Downstream EDID	28
EDID Presets	29
Storing EDID Data	30
Downloading EDID Data	32
Importing EDID Data	33
Amplifier Modes	34
Stereo Mode	34
Bridged Mono Mode	34
PA Sense	35
Tapping into the Speaker Wiring	35
Connecting to a Paging Sensor	36
USB Routing and Management	37
Follow Video	37
Manual Routing	38
Hub Vbus Control	39
LAN Management	40
Changing the Admin Password	40
Enabling / Disabling SSH and Telnet	41
RS-232 Control	42
Console Mode	42

Table of Contents

Occupancy Sensor Integration	43
Using Generic Occupancy Sensors	43
Using the AT-OCS-900N	44
Display Control	46
Using CEC	46
RS-232 Configuration	48
TCP/IP Configuration	50
Completing RS-232 or IP Configuration	51
System Settings	52
System Standby	52
Locking / Unlocking the Front Panel	53
Blink	54
Resetting to Factory-Default Settings	55
Performing a System Reboot	58
API Testing	60
Exporting the System Log	61
Exporting the System Configuration	62
Importing a System Configuration File	62
Configuration and Management Interfaces	63
Web Server	63
Login page	63
System > Info page	64
System > Network	65
Video > A/V Routing	66
Video > EDID	68
Audio > Local Audio	69
Audio > USB Audio	71
Audio > PA Sense	72
USB > USB Routing	73
USB > USB Hub	74
Control > LAN	75
Control > RS-232	76
Control > Trigger I/O	77
Control > Display Control	78
Maintenance > System	80
Maintenance > API Test	81
Maintenance > Logging	82
Maintenance > Configuration	83
Appendix	84
Updating the Firmware	84
Updating using the built-in Web Server	84
Updating over USB	86
Mounting Instructions	87
Specifications	88

Introduction

The Atlona **AT-OME-CS31-SA-HDBT** is an AV presentation and collaboration system for classrooms and conference rooms. It features AV switching of remote and local sources, a mixer amplifier, and USB hub.

The switcher has one HDBaseT® input supporting extension of HDMI, Ethernet, power, control, and USB 2.0 data up to 330 feet (100 meters) as well as two HDMI® inputs. Sources connected to these inputs, such as laptops, computers, and document cameras, are routed to the HDMI output connected to a projector or display. The amplifier of the OME-CS31-SA-HDBT delivers either two channels of 25 watts or a single channel of 50 watts into 4 or 8 ohms. It features one balanced stereo audio input and two unbalanced stereo audio inputs with independent level control for each. A balanced stereo line level output allows the mixed signal to be passed to an assistive listening system or separate amplifier. The OME-CS31-SA-HDBT's USB system integrates a USB 2.0 host over HDBaseT with a local USB 3.0 host and connections for four peripheral devices such as cameras, speakerphones, interactive displays, keyboards, mice, or storage devices.

The OME-CS31-SA-HDBT includes unique capabilities intended for education applications. Ducking automatically lowers the level on all other program audio sources when the teacher speaks into their microphone connected to the balanced line input. PA sense mutes the output of the amplifier whenever it detects activity on the school public address system. Both features ensure important lesson material and announcements are heard clearly.

For control, the OME-CS31-SA-HDBT includes dual Ethernet ports and two RS-232 ports for automated operation by the switcher itself or integration with Velocity™ and third-party control systems. The compact enclosure allows the OME-CS31-SA-HDBT to be mounted in a variety of locations such as behind a display or under a desk or table.

Features

- 3x1 AV switcher with one HDBaseT® input, two HDMI® inputs, and one HDMI output.
- HDBaseT input supports extension of HDMI, Ethernet, power, control, and USB 2.0 data up to 330 feet (100 meters).
- USB system integrates USB 2.0 host over HDBaseT with local USB 3.0 type B host port and four type A peripheral ports.
- 2 x 25 watts @ 4/8 ohms amplifier (stereo or dual mono) or 1 x 50 watts @ 4/8 ohms (bridged).
- One balanced stereo line level input and two unbalanced stereo line level inputs on 3.5 mm connections.
- Balanced stereo line level output allows the mixed signal to be passed to an assistive listening system or separate amplifier.
- Supports mixing 3 line inputs, de-embedded HDMI, and USB audio to the amplifier and line outputs.
- Ducking lowers the level of all inputs when audio, such as a teacher microphone, is present on the balanced audio input.
- Supports audio mute with contact closure or PA sense so announcements can be heard clearly.
- Dual Ethernet ports and integrated network switch allows a single connection to an AV LAN for IP control of a display and the switcher.
- Two RS-232 ports for control of the switcher or peripheral devices.
- Two digital I/O ports for automated control from occupancy sensors or other third party devices.
- 5V USB charging port for powering external devices such as a Bluetooth® receiver.
- Energy Star® qualified for power efficiency and cost savings.
- Automatic display control changes display power state via CEC, IP, or RS-232 based on active or standby mode of the switcher or status of occupancy sensors connected to the digital I/O ports.
- Auto-switching selects active input when sources are connected or if there is a change in source power status.
- Manages EDID communications with the source through the connected display's EDID or internally stored EDID
- HDCP 2.2 compliant.
- 4K/UHD capability @ 60 Hz with 4:4:4 chroma sampling.
- Supports HDR10, HLG, and Dolby® Vision™ HDR formats.
- Intuitive GUI-based configuration using integrated web server.
- Front panel LED indicators provide status for power, input selection, and LAN.
- Low profile enclosure for mounting behind a display or under a desk or table.

Package Contents

- 1 x AT-OME-CS31-SA-HDBT
- 1 x Envelope of mating connectors for all captive-screw connectors
- 1 x Surface mount brackets
- 4 x Rubber feet
- 1 x 24 V / 5 A power supply
- 1 x AC cord
- 1 x Insert w/ QR code

Panel Description

Front Panel

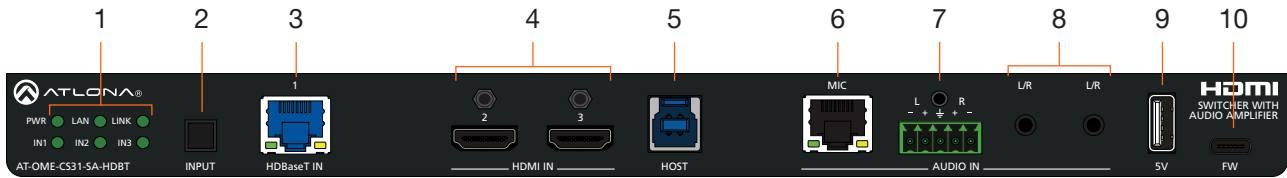

1 LED Indicators

These LED indicators provide information about the state of the unit. Refer to [LED Indicators \(page 16\)](#) for more information.

2 INPUT

Press and release this button to cycle between each of the available inputs.

3 HDBaseT IN

Connect a category cable from this port to a compatible HDBaseT transmitter or switcher.

4 HDMI IN

Connect an HDMI cable from each of these ports to an HDMI source.

5 HOST

Connect a USB cable from this port to the host USB device.

6 MIC

This port is reserved for future use.

7 VOICE L/R

Connect the included 5-pin captive screw connector from this port to a balanced analog audio input.

8 L/R

Connect a music player, Bluetooth™ receiver, or other unbalanced stereo source to each of these 3.5 mm mini-stereo ports.

9 5V

Provides +5 V USB power. Can be used to attach Bluetooth™ audio adapters or powered USB hubs.

10 FW

This USB-C port is used to update the firmware. Refer to the User Manual for more information.

Rear Panel



- 1 24V / 5A**
Connect the included 24 V / 5 A power supply from this port to an available AC electrical outlet.
- 2 LAN**
Connect an Ethernet cable from either of these ports to the LAN. The other LAN port can be used to connect an Ethernet cable to a display or other device.
- 3 TRIGGER I/O**
Connect the included 8-pin push-pin connector to this port. This port consists of two separate ports: **TRIGGER I/O 1** (top) and **TRIGGER I/O 2** (bottom).
- 4 RS-232**
Connect the included 6-pin push-pin connector to this port. This port consists of two separate ports: **RS-232 1** (top) and **RS-232 2** (bottom).
- 5 TRIGGER (PA SENSE)**
Connect the included 2-pin captive screw connector to this port. Supports audio mute with contact closure or PA sense so announcements can be heard clearly.
- 6 GND/25V/75V/100V (PA SENSE)**
Connect the included 4-pin captive screw connector from this port to a PA speaker system.
- 7 Potentiometer (PA SENSE)**
Adjusts the threshold of the **PA SENSE** speaker port. This pot has no effect on the **TRIGGER** port.
- 8 AMP OUT**
Connect the included 4-pin captive screw connector from this port to a pair of program / stereo speakers. Supports 2 x 25 watts @ 4/8 ohms amplifier (stereo or dual mono) or 1 x 50 watts @ 4/8 ohms (bridged).
- 9 AUDIO OUT**
Connect the included 5-pin captive screw connector from this port to an assistive listening device or additional amplifier.
- 10 HUB**
Connect up to 4 USB devices to these ports.
- 11 HDMI OUT**
Connect an HDMI cable from this port to a display.

Installation

Connection Instructions

1. Connect an HDMI cable from a source to these **HDMI IN** ports.
2. Connect an HDMI cable from the **HDMI OUT** port to a local display.
3. Connect a category cable from the **HDBaseT IN** port to a compatible HDBaseT transmitter or switcher. Refer to the table below for information on maximum cable length and supported resolutions.

Refer to the tables below for recommended cabling when using Altona products with HDBaseT technology. The orange bars indicate the signal quality when using each type of cable. Higher-quality signals are represented by more bars. *These tables are for guidance, only. Performance may vary, based on environmental factors.*

Core	Shielding	CAT5e	CAT6	CAT6a	CAT7
Solid	UTP (unshielded)	■	■■■	■■■■	N/A
	STP (shielded)	■■	■■■■	■■■■■	■■■■■

Cable	Max. Distance @ 4K	Max. Distance @ 1080p
CAT5e	295 feet (90 meters)	330 feet (100 meters)
CAT6a / CAT6a / CAT7	330 feet (100 meters)	330 feet (100 meters)



IMPORTANT: Stranded or patch cable is not recommended due to performance issues. Shielded cables are strongly recommended to minimize signal noise and interference.

4. Connect a USB cable from the **HOST** port to the host USB device.
5. Connect an Ethernet cable from either of these **LAN** ports to the LAN. The other **LAN** port can be used to connect an Ethernet cable to a display or other device.
6. Connect the included 5-pin captive screw connector from the **AUDIO IN** port to a line-level wireless microphone or balanced stereo mixer output. The included ground screw can be used to connect shield wire to the chassis ground.
7. Connect a music player, Bluetooth™ receiver, or other unbalanced stereo source to each of these **L/R** 3.5 mm mini-stereo ports.
8. Connect a Bluetooth™ audio adapter or powered USB hub to the **5V** port. This port provides +5 V USB power.

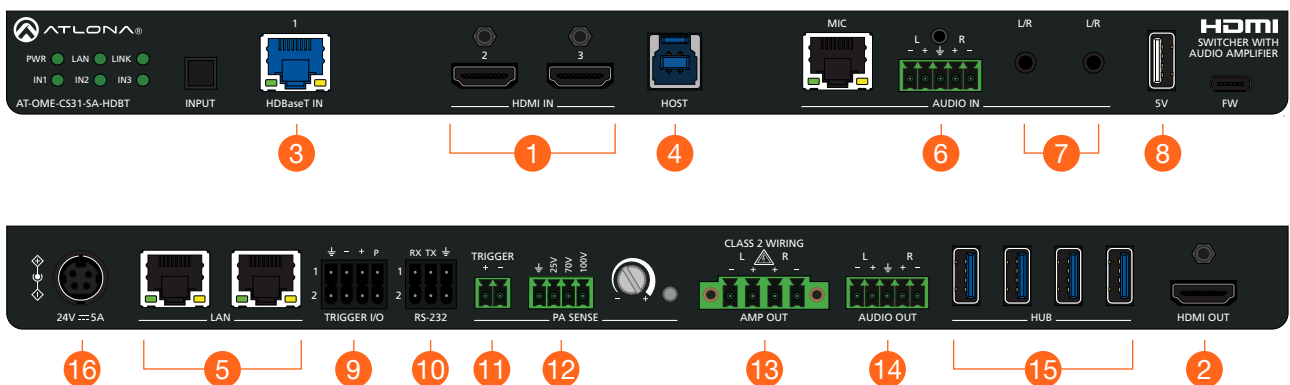

Installation

9. Connect the included double-stack 4-pin connector to the **TRIGGER I/O** port. This port consists of two separate ports: **TRIGGER I/O 1** (top) and **TRIGGER I/O 2** (bottom).
10. Connect the included double-stack 3-pin captive screw connector to the **RS-232** port. This port consists of two separate ports: **RS-232 1** (top) and **RS-232 2** (bottom). These ports can be used for console and display control.
11. Connect the included 2-pin captive screw connector to the **TRIGGER (PA SENSE)** port. This port supports audio mute with contact closure or PA sense so announcements can be heard clearly.
12. Connect the included 4-pin captive screw connector from the **GND/25V/70V/100V** port to a PA speaker system.
13. Connect the included 4-pin captive screw connector from the **AMP OUT** port to a pair of program / stereo speakers. Supports 2 x 25 watts @ 4/8 ohms amplifier (stereo or dual mono) or 1 x 50 watts @ 4/8 ohms (bridged).
14. Connect the included 4-pin captive screw connector from the **AUDIO OUT** port to a PA speaker system.
15. Connect up to 4 USB devices to these **HUB** ports.
16. Connect the included power supply from the **24V/5A** port to an available AC electrical outlet.

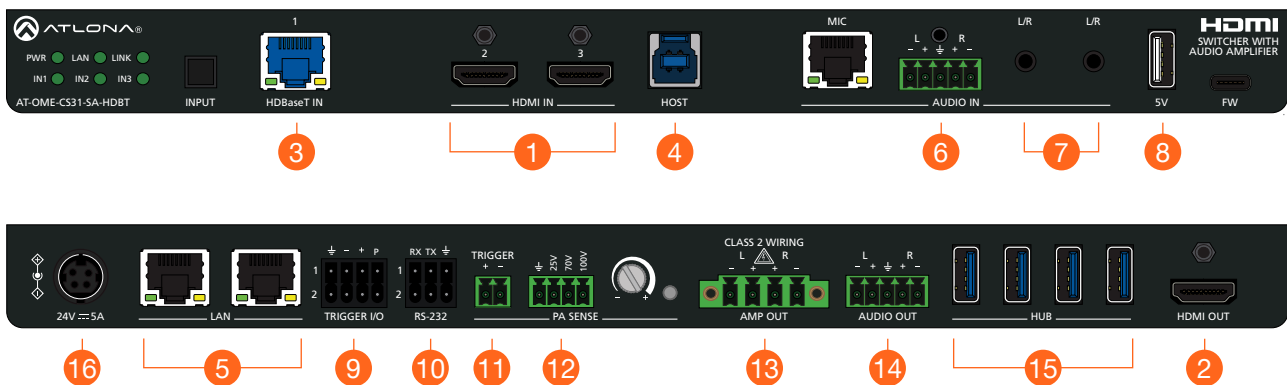

Connection Diagram

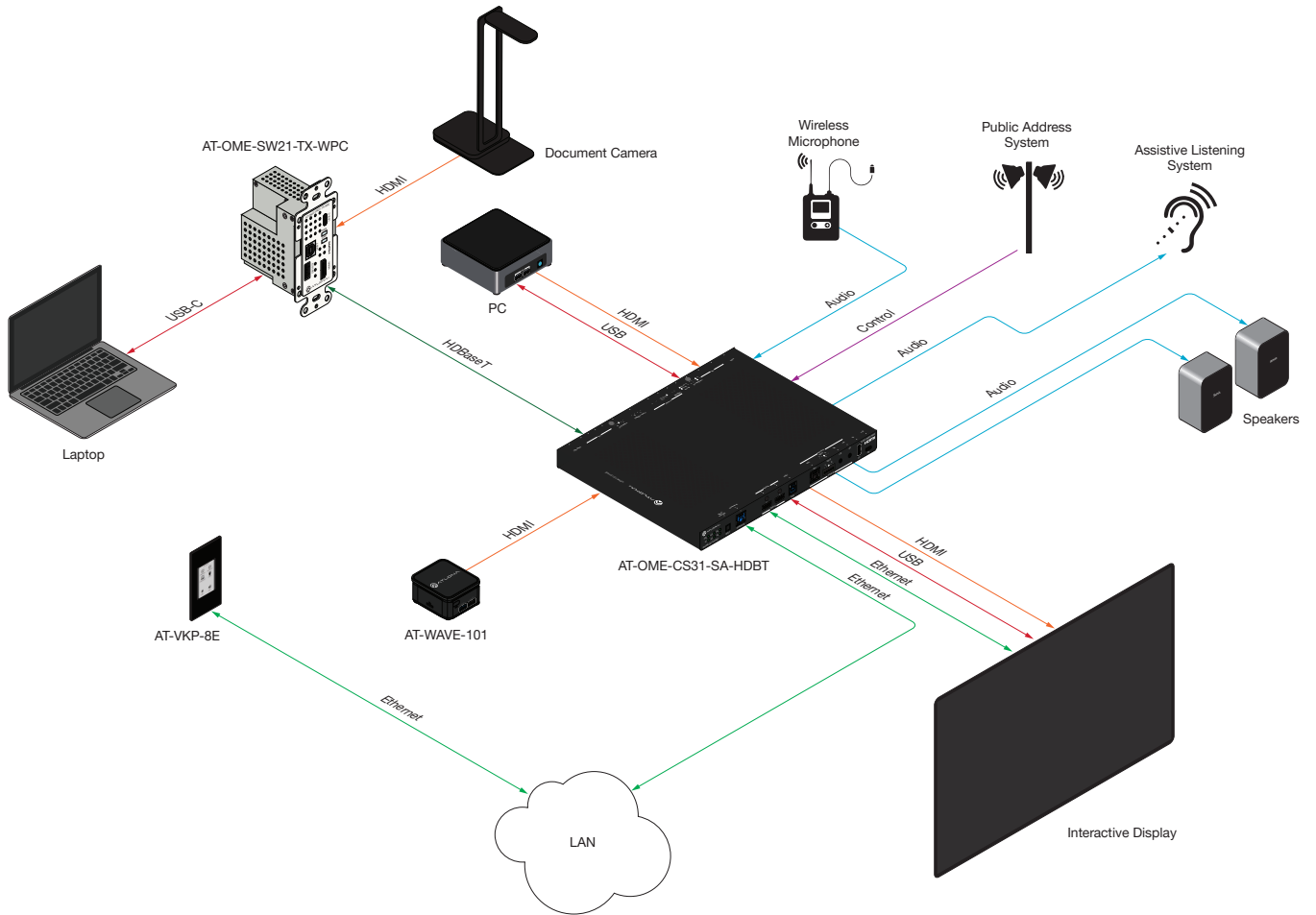

IP Configuration

The AT-OME-CS31-SA-HDBT is shipped with DHCP enabled. Once connected to a network, the DHCP server (if available), will automatically assign an IP address to the unit. If the AT-OME-CS31-SA-HDBT is unable to detect a DHCP server within 15 seconds, then the unit will use a self-assigned IP address within the range of 169.254.xxx.xxx/16. If this occurs, refer to the instructions below. Otherwise, skip to the next page.

Obtaining the Current IP Address

1. Make sure the AT-OME-CS31-SA-HDBT is powered and connected to a display.
2. Press and release the **INPUT** to cycle through each input: **IN1**, **IN2**, and **IN3**. Press the **INPUT** button again to display the **Info** screen (see *Figure 1.1*). The **Info** screen provides general information about the AT-OME-CS31-SA-HDBT, including its IP address. While the **Info** screen is displayed, none of the **IN** LED indicators will be illuminated.
3. Press the **INPUT** button once more to select **IN1** as the active input. Refer to [Input Switching \(page 25\)](#) for more information.

Automatic Private IP Addressing (APIPA) Mode

If the AT-OME-CS31-SA-HDBT is unable to detect a DHCP server within 15 seconds, when set to DHCP mode, then Automatic Private IP Addressing (APIPA) will be used to assign an address within the IPv4 address block 169.254.xxx.xxx/16. If a DHCP server is detected while in APIPA mode, then the AT-OME-CS31-SA-HDBT will be assigned an address from the DHCP server pool. To manually adjust the IP address, connect an Ethernet cable directly from the **LAN** port of the AT-OME-CS31-SA-HDBT to the LAN port of a computer, then do the following:

1. Change the IP address of the computer to an unused IP address within the range 169.254.xxx.xxx/16. *The computer must not be assigned the same address as the AT-OME-CS31-SA-HDBT.*
2. Click **Start > Settings > Control Panel > Network and Sharing Center**.
3. Click **Change adapter settings**.
4. Right-click on the adapter that is used to establish a wired connection to the network, and select **Properties** from the context menu.
5. Under the **Ethernet Properties** dialog box, select **Internet Protocol Version 4** and then click the **Properties** button. Click the **Use the following IP address** radio button.



IMPORTANT: Before continuing, write down the current IP settings in order to restore them, later. If **Obtain an IP address automatically** and **Obtain DNS server automatically** are selected, then this step is not required.

6. Enter the desired static IP address or the IP address provided by the network administrator. If the computer does not require Internet access or if a statically-assigned IP address is being used, then an address within the IPv4 address block 169.254.xxx.xxx/16 can be entered.
7. Set the subnet mask to 255.255.0.0.
8. Click the **OK** button then close all **Control Panel** windows.
9. Log in to the built-in web server to set a static IP address that can be used with the network. Contact a system administrator, if necessary. Refer to [Setting the IP Mode \(page 19\)](#) for more information.

Device Operation

LED Indicators

The LED indicators on both the front and rear of the unit provide basic information on the current status of the AT-OME-CS31-SA-HDBT.

LED	State		Description
PWR	Solid green	●	Unit is powered and in normal operating mode.
	Solid red	●	Indicates there is a fault during power up.
	Off	○	Unit is not powered. <ul style="list-style-type: none"> Check the power supply and make sure it is securely fastened to the captive screw connector on the rear of the unit. Make sure that the power supply is connected to an available electrical outlet and that the outlet is “live” (some outlets are controlled by a wall switch).
IN1, IN2, IN3	Solid green	○	The input is active.
	Off	●	The input is not active. If IN1 , IN2 , and IN3 are all ‘off’, then no inputs are active. Press and release the INPUT button to activate IN1 (HDBaseT IN) .
LAN	Solid green	○	Indicates an active connection between the LAN port and the network. Note that this does not necessarily indicate that the unit is accessible over the network.
	Off	●	No connection between the LAN port and the network is detected.
LINK	Solid green	○	Indicates an active link between the HDBaseT IN port and a compatible HDBaseT transmitter.
	Off		No HDBaseT transmitter is detected. <ul style="list-style-type: none"> Check that an HDBaseT transmitter is connected to the HDBaseT IN port of the AT-OME-CS31-SA-HDBT. Check the cable integrity of the category cable between the HDBaseT transmitter and the HDBaseT IN port of the AT-OME-CS31-SA-HDBT. Try replacing the category cable.

Logging in to the Web Server

Most of the AT-OME-CS31-SA-HDBT operation is handled through the built-in web server. In order to access the web server, the IP address of the unit must be known.

Login Registration

Before the built-in web server can be accessed, a password must be created.

1. Launch the desired web browser and enter the IP address of the AT-OME-CS31-SA-HDBT in the address bar.
2. The **Login** page will be displayed.

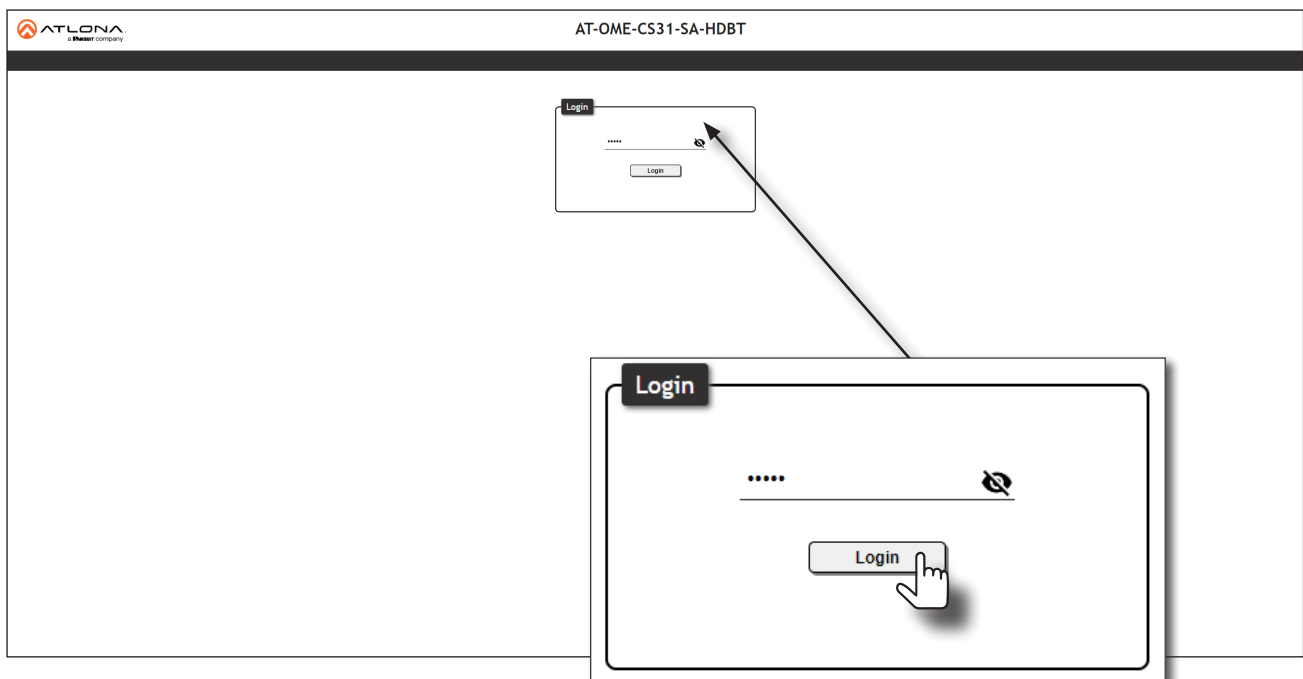

3. Enter **Atlona** in the provided field.
4. Click the **Login** button.
5. The **Change Password** screen will be displayed.

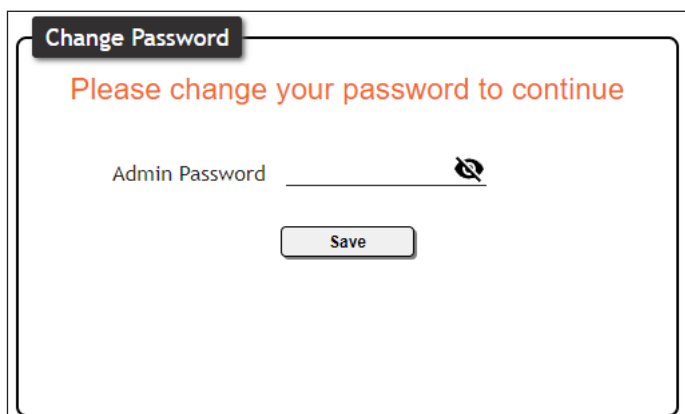

6. Enter the desired password in the **Admin Password** field.



NOTE: Passwords can be 5 to 32 characters in length and can only contain letters, numbers, dashes, underscores, and periods.

7. Click the **Save** button.
8. The **System > Info** page will be displayed.

Logging in after Registration

1. Launch the desired web browser and enter the IP address of the AT-OME-CS31-SA-HDBT in the address bar.
2. Enter the correct password in the provided field.
3. Click the **Login** button.

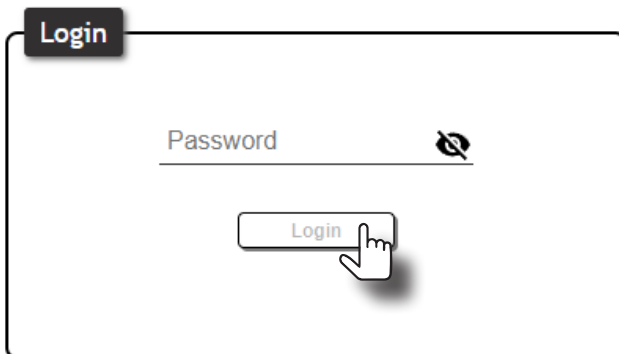

4. The **System > Info** page will be displayed.

System Configuration

The AT-OME-CS31-SA-HDBT provides easy access to system configuration through the built-in web server, and is the recommended method to adjust network settings.

Getting the MAC Address

1. Log in to the web server.
2. Click **System** > **Network** in the menu bar.
3. Locate the MAC address field, as shown below. This is the hardware address of the AT-OME-CS31-SA-HDBT.

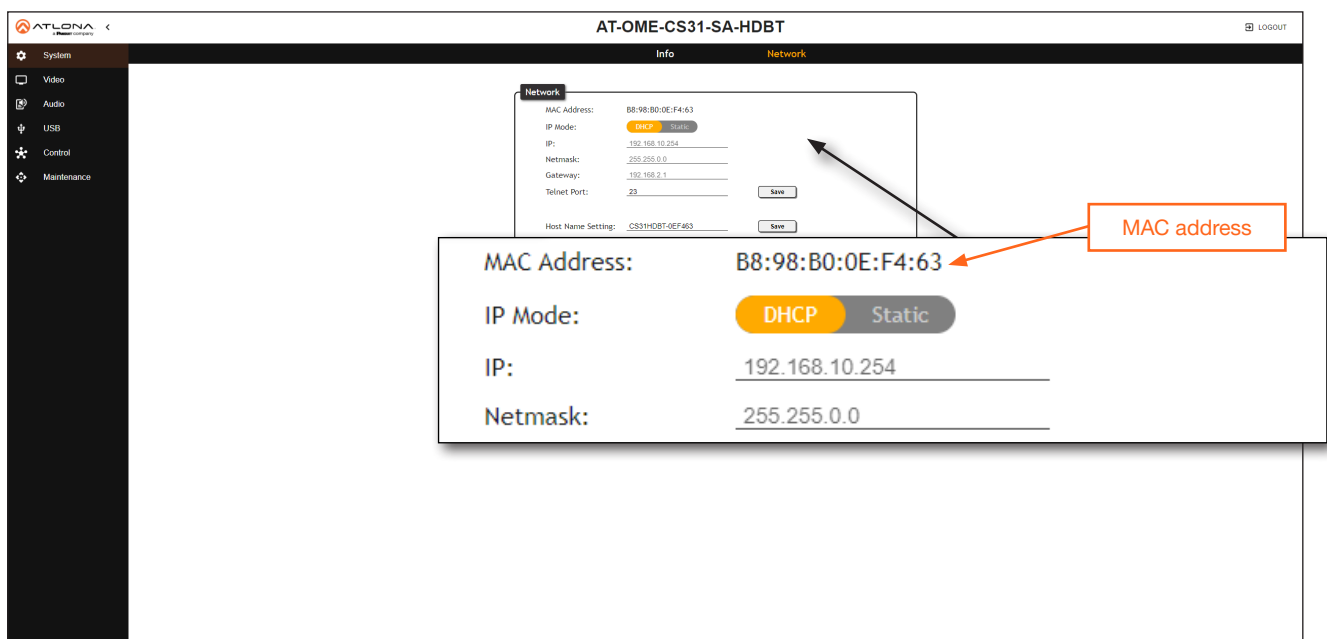

Setting the IP Mode

By default, the AT-OME-CS31-SA-HDBT is set to DHCP mode. Once connected to a network, and if a DHCP server is found (or available), the AT-OME-CS31-SA-HDBT will be assigned an IP address on the network, and no further network configuration is required. However, in some cases, a static IP address may be desired.



IMPORTANT: Before assigning a static IP address to the AT-OME-CS31-SA-HDBT, it is recommended to consult with the network or system administrator and obtain a available IP address. Assigning the AT-OME-CS31-SA-HDBT to an IP address which is already in use can result in network issues or difficulty in accessing the AT-OME-CS31-SA-HDBT.

Static IP Mode

1. Log in to the web server. Refer to [Logging in to the Web Server \(page 17\)](#) for more information.
2. Click **System** > **Network** in the menu bar.

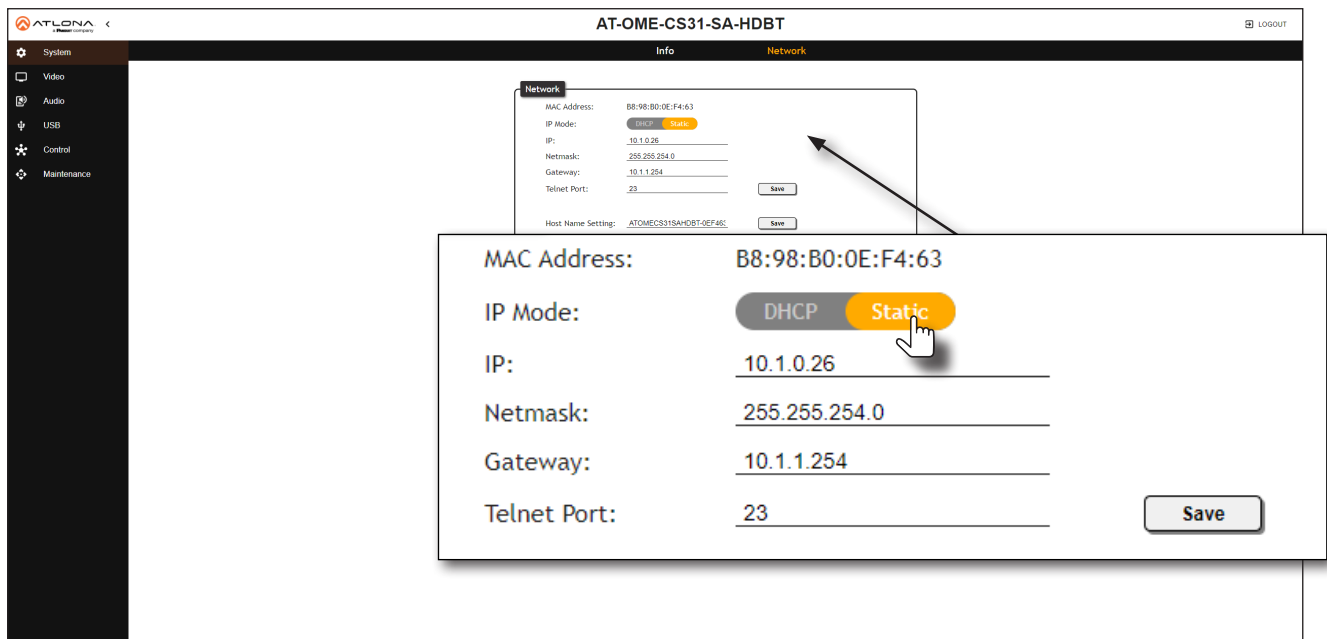

3. Locate the **IP Mode** toggle switch. The default setting of this toggle switch is `DHCP`.
4. Click this toggle switch to set it to `Static`.
5. Enter the desired IP address for the AT-OME-CS31-SA-HDBT in the **IP** field.
6. Enter the subnet mask and gateway (router) address in the **Netmask** and **Gateway** fields, respectively.
7. Click the **Save** button to commit changes.

DHCP Mode

In this mode, the AT-OME-CS31-SA-HDBT is automatically assigned an IP address from the DHCP server pool. If the DHCP server is unable to assign an IP address to the unit, then Automatic Private IP Addressing (APIPA) will be used to assign an address within the IPv4 address block `169.254.xxx.xxx/16`.

1. Log in to the web server.
2. Click **System** > **Network** in the menu bar.
3. Locate the **IP Mode** toggle switch.
4. Click this toggle switch to set it to `DHCP`.
5. Click the **Save** button to commit changes.

Changing the Telnet Port

Typically, the Telnet service is assigned to TCP port 23. This is the default setting for the AT-OME-CS31-SA-HDBT. However, depending upon the network environment, the default Telnet port can be changed. The Telnet port can be changed independently of the IP mode.

1. Log in to the web server.
2. Click **System** > **Network** in the menu bar.
3. Locate the **Telnet Port** field and enter the desired port in the field.
4. Click **Save** to commit changes.

MAC Address:	B8:98:B0:0E:F4:63
IP Mode:	<input type="radio"/> DHCP <input checked="" type="radio"/> Static
IP:	<input type="text" value="10.1.0.26"/>
Netmask:	<input type="text" value="255.255.254.0"/>
Gateway:	<input type="text" value="10.1.1.254"/>
Telnet Port:	<input type="text" value="23"/> <input type="button" value="Save"/>

Setting the Host Name

By default, the AT-OME-CS31-SA-HDBT is assigned a hostname, which is constructed as follows:

CS31HDBT-[last six digits of MAC address]

For example, a default hostname might look like this: CS31HDBT-0EF463. This value can be changed to easily identify the AT-OME-CS31-SA-HDBT within Velocity Device Manager or on a network. The hostname cannot exceed 15 characters in length.

1. Log in to the web server.
2. Click **System > Network** in the menu bar.
3. Click the **Host Name Setting** field and enter the desired name.
4. Click **Save** to commit changes.

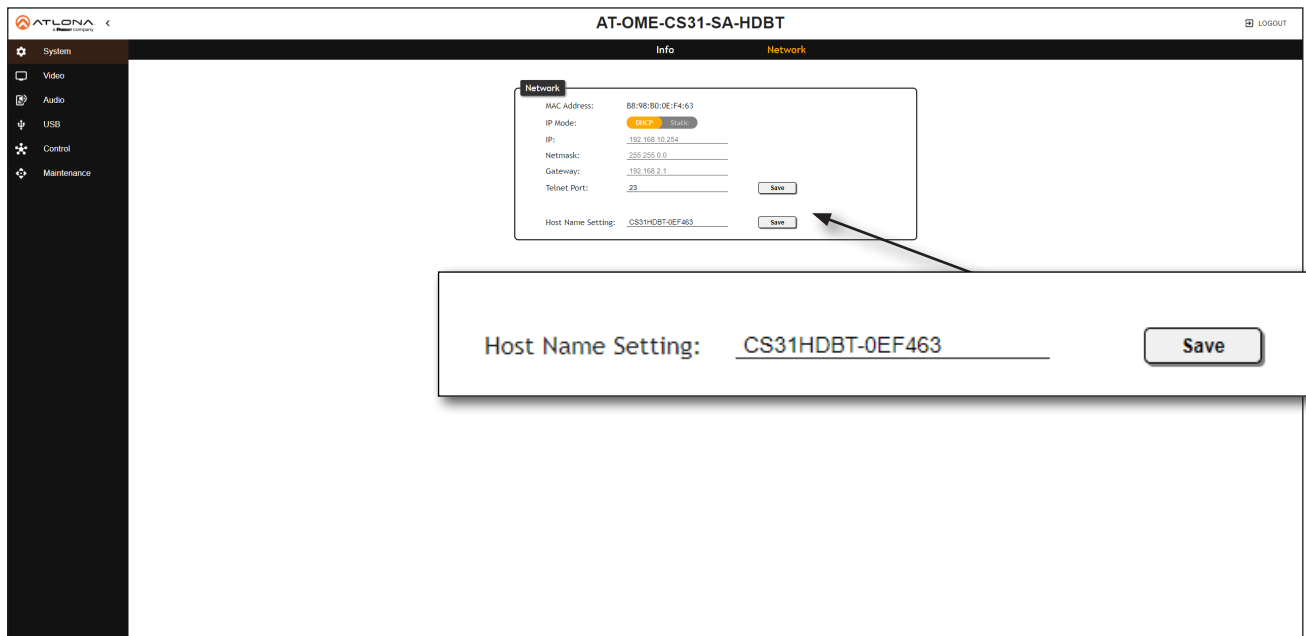

Auto Switching

The AT-OME-CS31-SA-HDBT provides Auto Switching capability, which is enabled by default. This feature will automatically switch the input to the most recently-connected source. If the active source is disconnected, then the input will automatically be switched to the previously-connected source.

Enabling / Disabling Auto Switching

By default, Auto Switching is enabled on the AT-OME-CS31-SA-HDBT, allowing the unit to automatically switch between inputs when sources are connected or disconnected.

1. Log in to the web server.
2. Click **Video > A/V Routing** in the menu bar.
3. Click the **Auto Switch** toggle switch to the **Enabled** position to enable Auto Switching. This is the default setting. If Auto Switching is not desired, click this toggle switch to the **Disabled** position.



NOTE: The AT-OME-CS31-SA-HDBT retains the currently selected input, even after the unit is powered off then powered on. The system should re-evaluate the Auto Switching logic after power on and select an input.

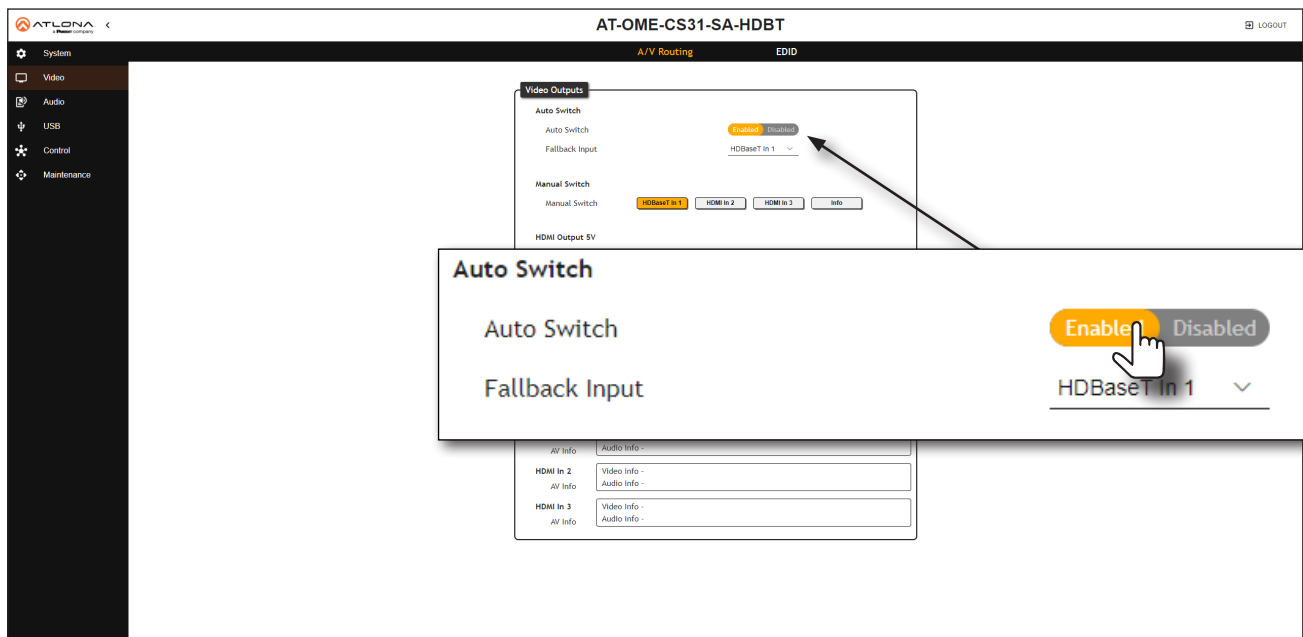

The screenshot displays the AT-OME-CS31-SA-HDBT web interface. The main content area is titled 'A/V Routing' and 'EDID'. Under 'Video Outputs', the 'Auto Switch' section shows a toggle switch set to 'Enabled' (highlighted in orange) and a 'Fallback Input' dropdown menu set to 'HDBaseT In 1'. Below this, the 'Manual Switch' section shows buttons for 'HDBaseT In 1', 'HDMI In 2', 'HDMI In 3', and 'Info'. At the bottom, there are three rows of 'HDMI In' (1, 2, 3) each with 'Video Info' and 'Audio Info' links. A callout box titled 'Auto Switch' provides a magnified view of the 'Auto Switch' toggle and the 'Fallback Input' dropdown, showing a hand cursor clicking the 'Enabled' button.

Setting the Fallback Input

If the previously active input is no longer available, then the AT-OME-CS31-SA-HDBT will switch to the input that is selected in the **Fallback Input** drop-down list.

1. Log in to the web server.
2. Click **Video > A/V Routing** in the menu bar.
3. Click the **Fallback Input** drop-down list to select the input that will become active, once the current input is not active.

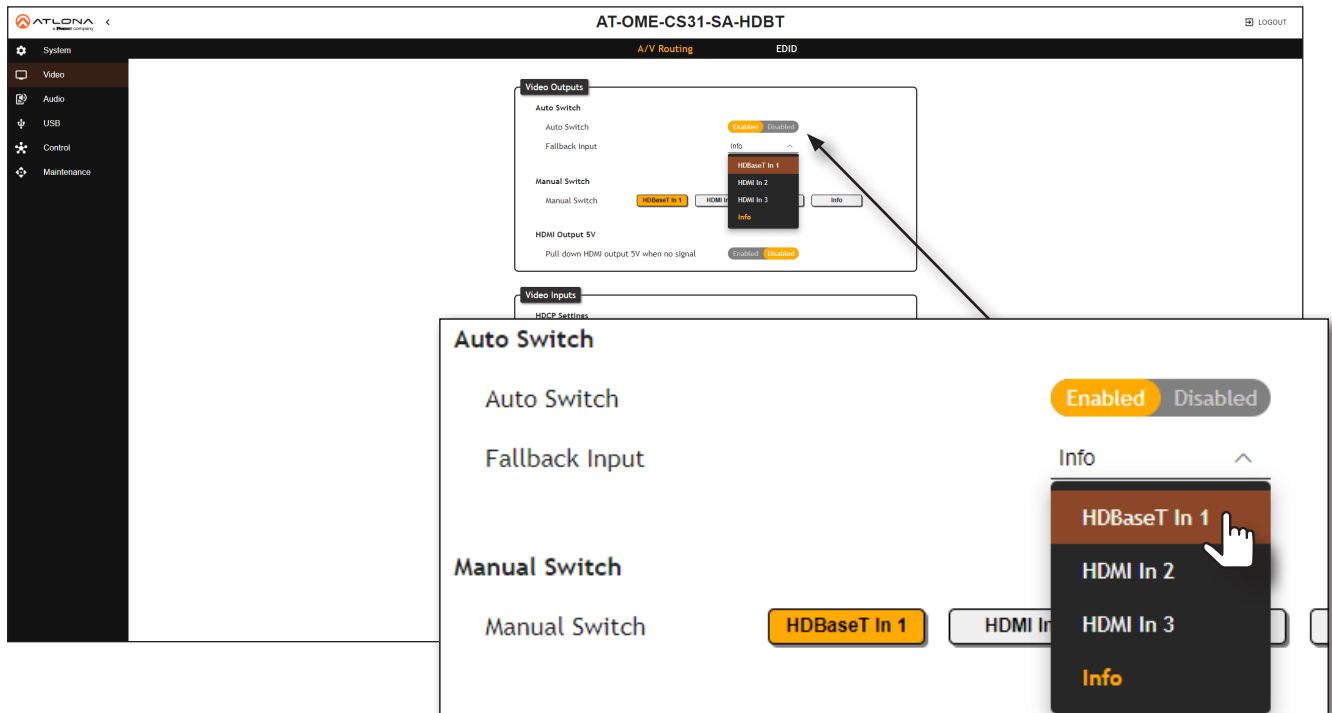

Input Switching

Switching between inputs can be performed using the front panel or through the built-in web server.

Using the Front Panel

1. Make sure the AT-OME-CS31-SA-HDBT is powered.
2. Press and release the **INPUT** to cycle through each input: **IN1**, **IN2**, and **IN3**. Press the **INPUT** button again to display the **Info** screen (see *Figure 1.1*). The **Info** screen provides general information about the AT-OME-CS31-SA-HDBT. While the **Info** screen is displayed, none of the **IN** LED indicators will be illuminated.
3. Press the **INPUT** button once more to select **IN1** as the active input.



LED indicator	Port Description
IN1	HDBaseT IN 1
IN2	HDMI IN 2
IN3	HDMI IN 3

Figure 1.1 - Info screen



Using the Web Server

1. Connect an Ethernet cable between the **LAN** port of the AT-OME-CS31-SA-HDBT and the Local Area Network (LAN).
2. Log in to the web server.
3. Click **Video > A/V Routing** in the menu bar.
4. Click the desired input from the **Manual Switch** section. Pressing the **Info** button will display the Info screen. Refer to [Using the Front Panel \(page 25\)](#) for more information.

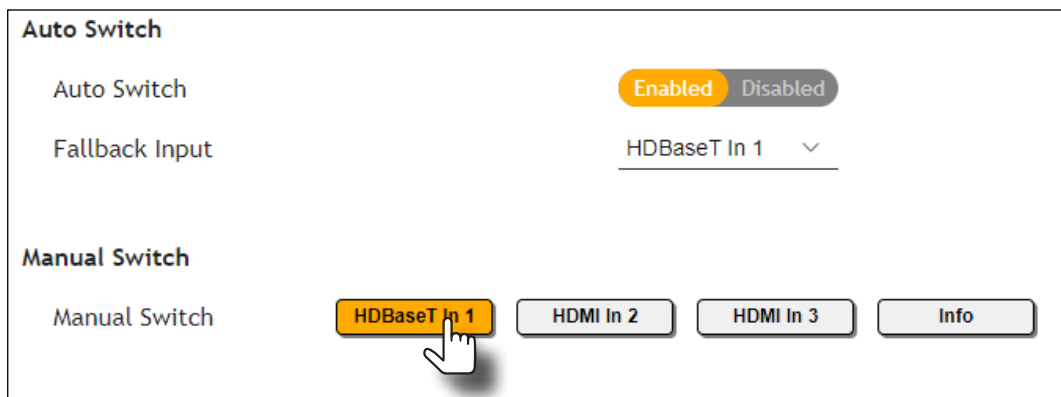

HDMI Output +5V

This option sets the +5V pin on the **HDMI OUT** port to the desired setting. This feature allows a display to go to sleep when there is no signal present. It's also used for VTC codecs that need to see a change in HDMI +5V in order to change modes. If faster switching times are desired, then this should be set to **Enabled**. The default setting is **Disabled**.

Setting	Description
Enabled	Forces the +5V pin on the HDMI output to “high” (always on).
Disabled	Allows the +5V pin on the HDMI output to toggle, based on the presence of an input video signal.

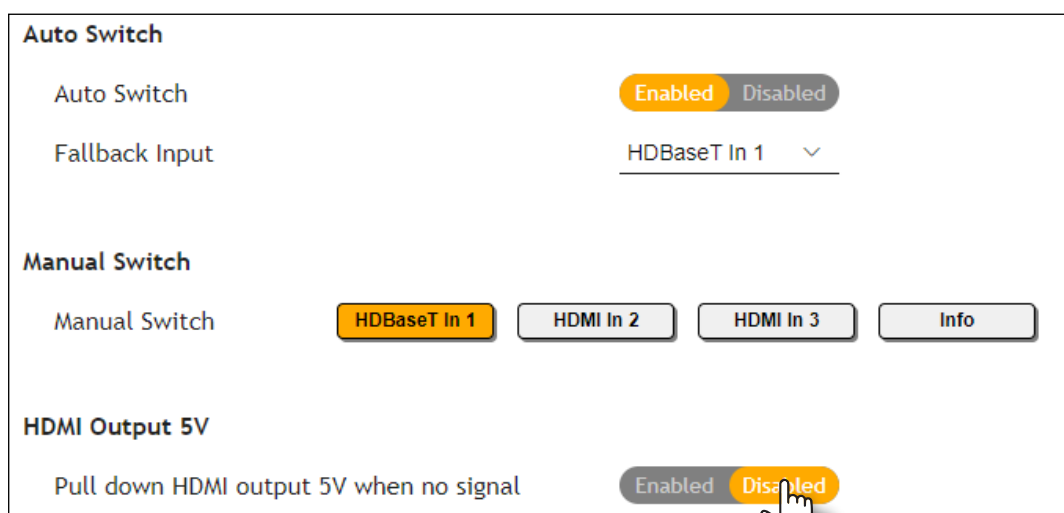

HDCP Content

Transmitting HDCP content to a display that is not HDCP compliant can result in “snow”, image flickering, or no picture. In the illustration below, a laptop source is connected to the AT-OME-CS31-SA-HDBT, which is connected to a display that is not HDCP compliant.



IMPORTANT: Not all source devices are capable of transmitting non-HDCP content. For example, Sony PlayStation® gaming consoles and Mac® computers always transmit HDCP-encrypted content.

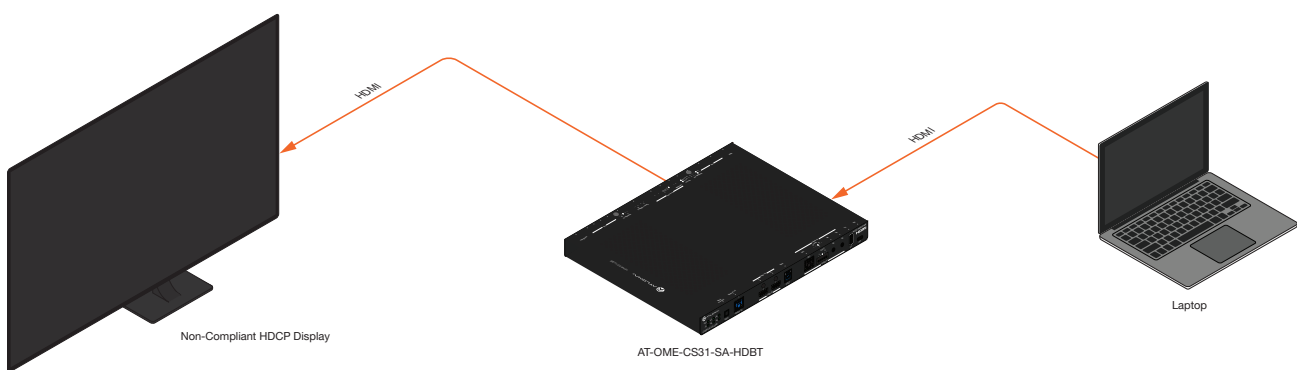

By default, the laptop may transmit HDCP content. However, when connected to a display that does not support HDCP, the laptop must be instructed to send non-HDCP content in order for the content to be displayed.

1. Log in to the web server.
2. Click **Video > A/V Routing** in the menu bar.
3. Locate the **Video Inputs** section.
4. Click the toggle switch next to the desired input. In this example, clicking the **HDMI In 2** toggle switch and setting it to the **Off** position will instruct the source device to send non-HDCP content, if possible.

Video Inputs

HDCP Settings

HDBaseT In 1	<input type="checkbox"/> On <input type="checkbox"/> Off
HDMI In 2	<input type="checkbox"/> On <input checked="" type="checkbox"/> Off
HDMI In 3	<input type="checkbox"/> On <input type="checkbox"/> Off

If the display is unable to receive HDCP content, then a “black screen” with no image will be displayed.

EDID Management

Before a source can send picture and sound to a display device, the source reads the EDID (Extended Display Identification Data) stored in the display. The EDID contains information about what type of video and audio formats are supported by the display. The AT-OME-CS31-SA-HDBT can use either the downstream EDID (from the display/sink) or use a built-in EDID preset. The AT-OME-CS31-SA-HDBT also provides a blank memory location that can be used to store EDID data. This section will cover each of the following topics:

- Using the Downstream EDID
- EDID Presets
- Storing EDID Data

Using the Downstream EDID

By default, the AT-OME-CS31-SA-HDBT will read the EDID from the display device. The term “downstream” is used to describe the route signals take from the source device to the display or other sink device. For example, if a Blu-ray player is connected to a display, the display is said to be “downstream” of the Blu-ray player.

1. Log in to the web server.
2. Click **Video** > **EDID** in the menu bar.
3. Locate the **EDID Settings** section.
4. Click the drop-down list, next to the input that is connected to the source device, and select **Connected Display**. For example, if the **HDBaseT IN** port is connected to a source, click the **HDBaseT In 1** drop-down list and select **Connected Display**. The source device will read the EDID of the connected display and determine all supported video and audio formats.

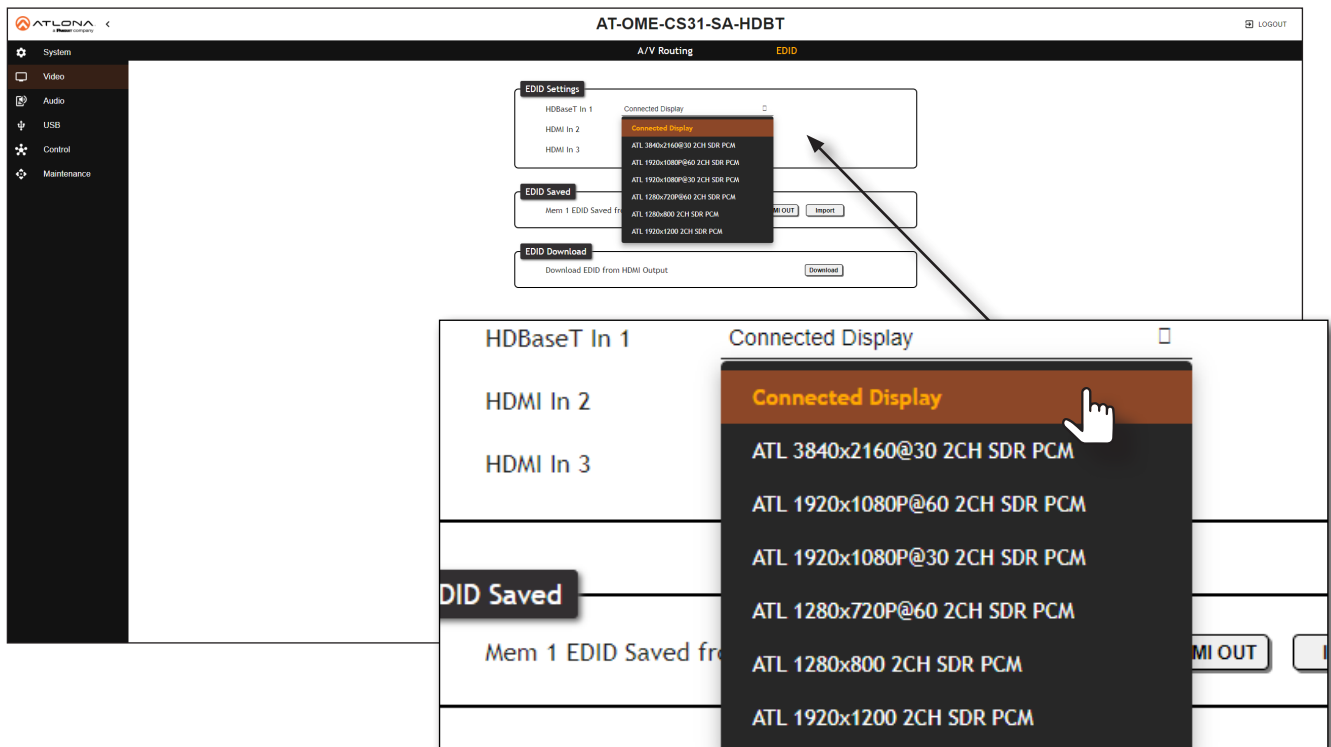

EDID Presets

The AT-OME-CS31-SA-HDBT provides the option of selecting a preset EDID. The following presets are available.

EDID	Description
Connected Display	Uses the downstream EDID of the connected display
ATL 3840x2160@60 2CH HDR PCM*	3840 x 2160 @ 60 Hz w/ 2-channel audio / HDR / Linear PCM
ATL 3840x2160@30 2CH SDR PCM	3840 x 2160 @ 30 Hz w/ 2-channel audio / SDR / Linear PCM
ATL 1920x1080P@60 2CH SDR PCM	1920 x 1080p @ 60 Hz w/ 2-channel audio / SDR / Linear PCM
ATL 1920x1080P@30 2CH SDR PCM	1920 x 1080p @ 30 Hz w/ 2-channel audio / SDR / Linear PCM
ATL 1280x720P@60 2CH SDR PCM	1280 x 720p @ 60 Hz w/ 2-channel audio / SDR / Linear PCM
ATL 1280x800 2CH SDR PCM	1280 x 800 w/ 2-channel audio / SDR / Linear PCM
ATL 1920x1200 2CH SDR PCM	1920 x 1200 w/ 2-channel audio / SDR / Linear PCM
Mem 1	Blank memory location available for EDID storage

* This EDID is only available on HDMI inputs.

1. Log in to the web server.
2. Click **Video** > **EDID** in the menu bar.
3. Locate the **EDID Settings** section.
4. Click the drop-down list, next to the port that is connected to the source device, and select the desired EDID preset. For example, if the **HDBaseT IN 1** port is connected to the source, click the **HDBaseT In 1** drop-down list and select the desired EDID. The source device will use the selected EDID to determine all supported video and audio formats.



IMPORTANT: If problems are encountered when using an EDID preset, it is recommended that the input be set to *Connected Display*. Not all displays will support all video and audio formats in a given EDID preset.

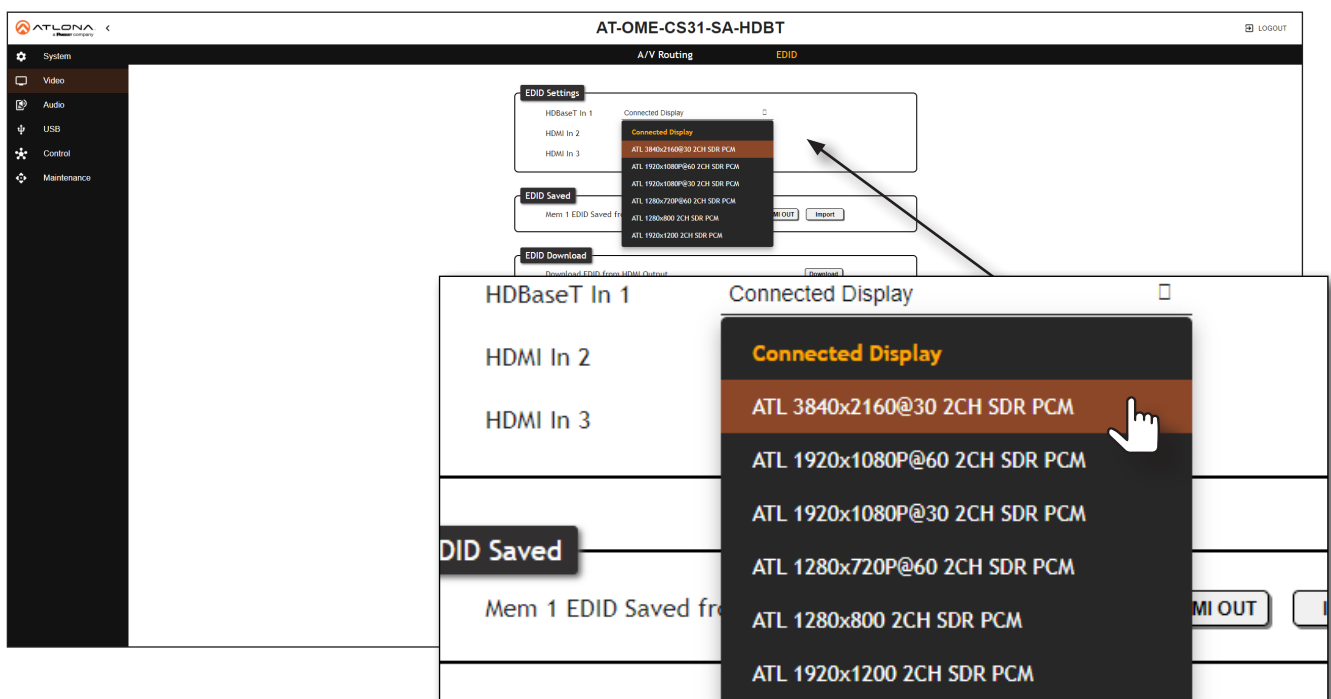

The screenshot displays the AT-OME-CS31-SA-HDBT web interface. The main content area is titled 'EDID' and shows 'EDID Settings' for 'A/V Routing'. Under 'EDID Settings', there are three input ports: 'HDBaseT In 1', 'HDMI In 2', and 'HDMI In 3'. The 'HDBaseT In 1' port is currently set to 'Connected Display'. A dropdown menu is open for 'HDBaseT In 1', showing a list of EDID presets: 'Connected Display', 'ATL 3840x2160@30 2CH SDR PCM', 'ATL 1920x1080P@60 2CH SDR PCM', 'ATL 1920x1080P@30 2CH SDR PCM', 'ATL 1280x720P@60 2CH SDR PCM', 'ATL 1280x800 2CH SDR PCM', and 'ATL 1920x1200 2CH SDR PCM'. A 'DID Saved' notification is visible in the bottom left corner. A 'Connected Display' modal window is open, showing the same list of EDID presets with 'ATL 3840x2160@30 2CH SDR PCM' selected. A hand cursor is pointing at this selection.

Storing EDID Data

The AT-OME-CS31-SA-HDBT provides a blank memory location that can be used to store EDID data. Any downstream EDID can be captured and stored in this location. This memory location is non-volatile and captured EDID data is stored after power is disconnected from the unit.

1. Connect an HDMI cable from the **HDMI OUT** port on the AT-OME-CS31-SA-HDBT to the HDMI input on the display, containing the EDID to be stored.
2. Log in to the web server.

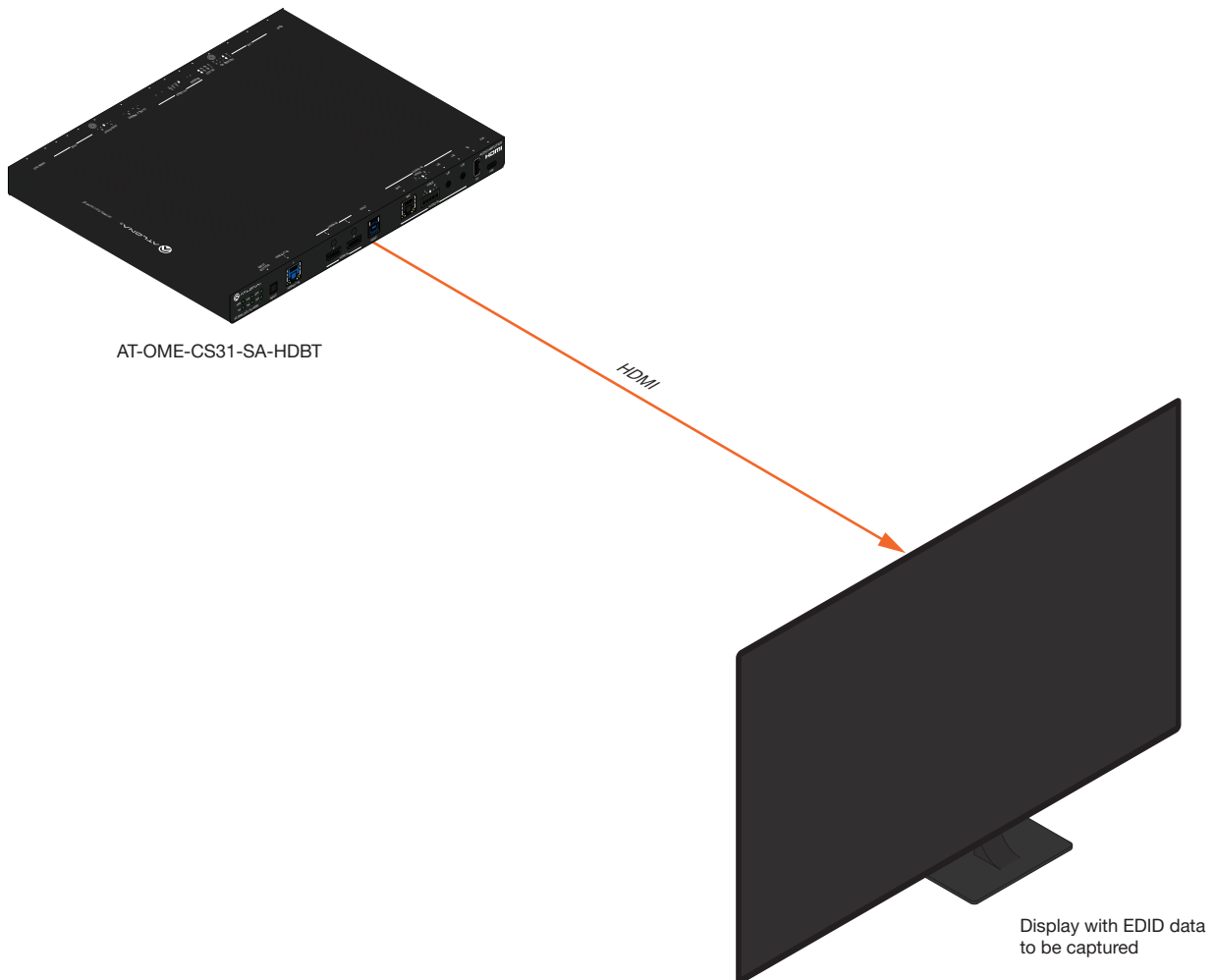

3. Click **Video > EDID** in the menu bar.
4. Locate the **EDID Saved** section.
5. Click the **HDMI OUT** button to fetch the EDID.

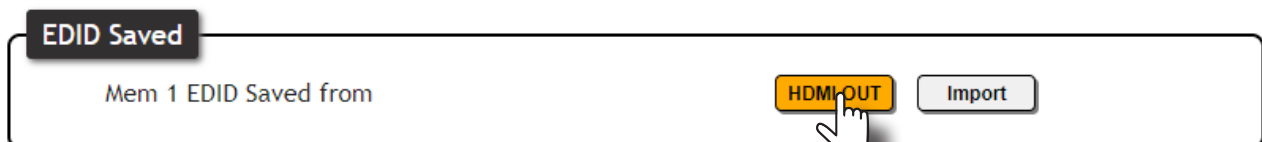

6. Once the EDID has been captured, the following message will be displayed near the bottom of the screen.



7. Click any of the input drop-down list boxes. Note that the stored EDID appears as an available EDID preset for each available input on the AT-OME-CS31-SA-HDBT.

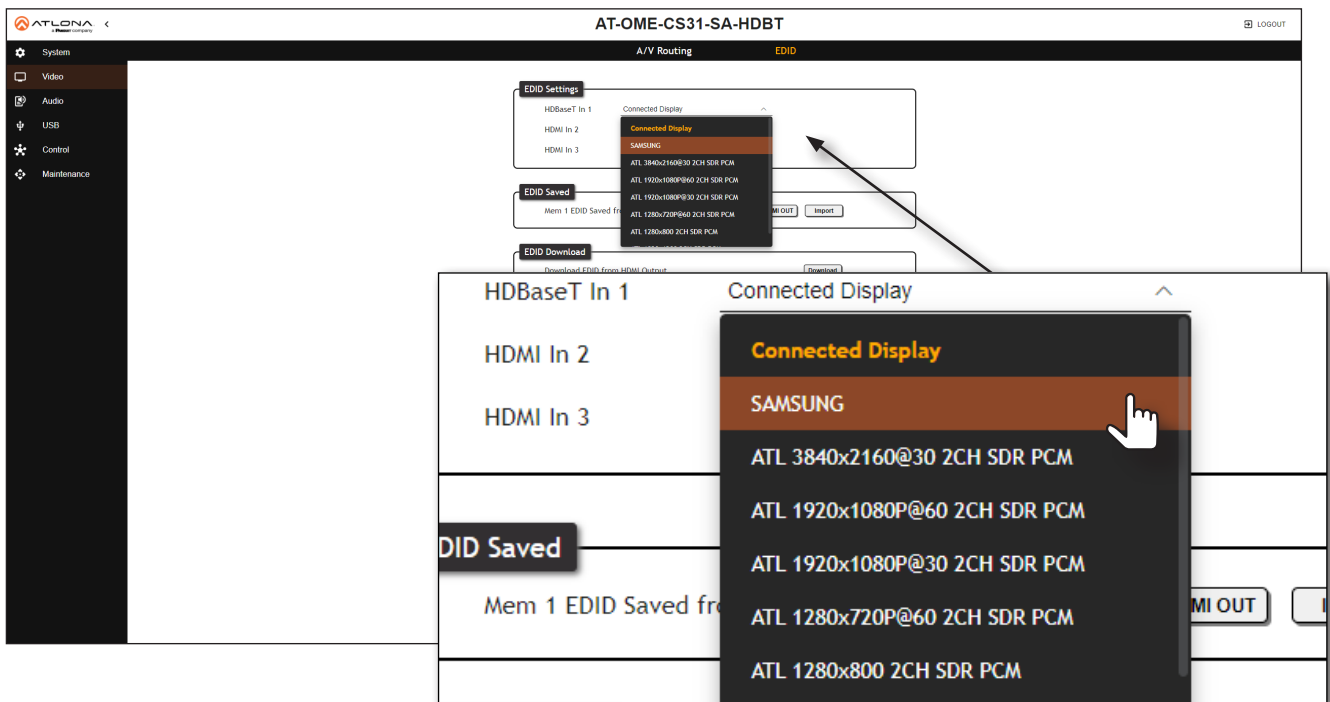

NOTE: Once an EDID is written to the memory location, it can be overwritten with a different EDID, when desired. To overwrite an EDID with a different EDID, connect a different display and click the **HDMI OUT** button.

Downloading EDID Data

The AT-OME-CS31-SA-HDBT can download the EDID from the **HDMI OUT** port.

1. Connect an HDMI cable from the **HDMI OUT** port on the AT-OME-CS31-SA-HDBT to the HDMI input on the display, containing the EDID to be stored.
2. Log in to the web server.
3. Click **Video > EDID** in the menu bar.
4. Locate the **EDID Download** section.
5. Click the **Download** button. The EDID data will automatically be saved to a file called `edid.bin`. This EDID can then be loaded into an EDID editor and modified, then reloaded, if desired. Refer to [Importing EDID Data \(page 33\)](#) for more information.

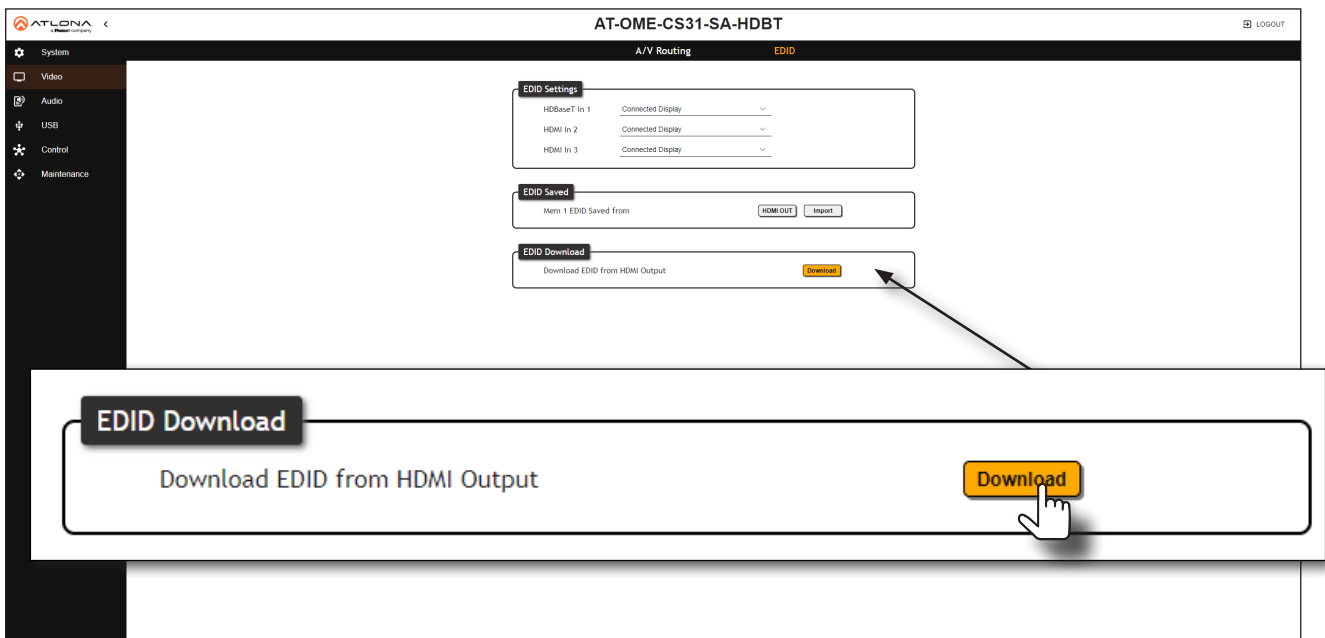

Importing EDID Data

Imports a .bin file, containing EDID data, to be loaded into the AT-OME-CS31-SA-HDBT.

1. Log in to the web server.
2. Click **Video > EDID** in the menu bar.
3. Locate the **EDID Saved** section.
4. Click the **Import** button.
5. Locate the desired .bin file and click the **Open** button on the open file dialog window.

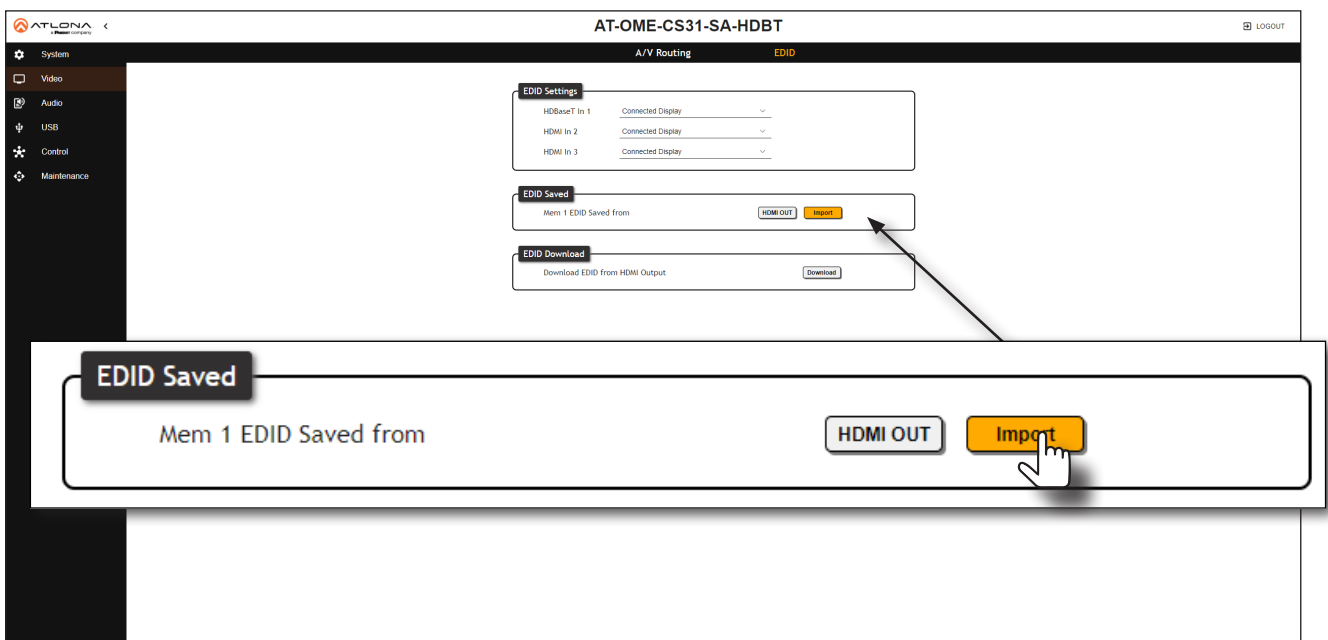

Amplifier Modes

This section covers wiring of both amplifier modes: stereo and bridged-mono.

Stereo Mode

In stereo mode, the output delivers 25 watts per left and right channel. Stereo sources will pass through to the amplifier, unchanged.

1. Locate the included 4-pin captive screw connector, for the **AMP OUT** port.
2. Connect the wires, from the amplifier, to the port as shown below.

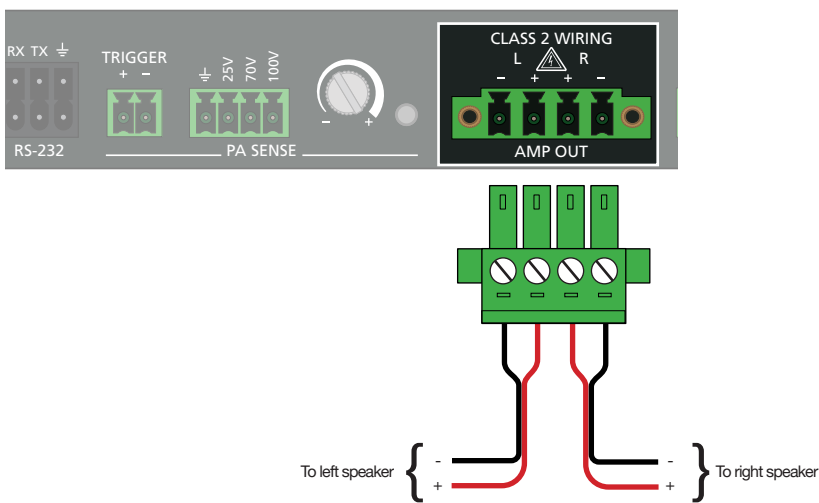

Bridged Mono Mode

In bridged mono mode, the output delivers 50 watts on a single channel. Stereo sources will be summed to mono at the amplifier.

1. Locate the included 4-pin captive screw connector, for the **AMP OUT** port.
2. Connect the wires, from the amplifier, to the port as shown below. This is the *recommended* wiring scheme. However, bridged mono can be connected to any pin from the left channel and any pin from the right channel, as shown in the green box.

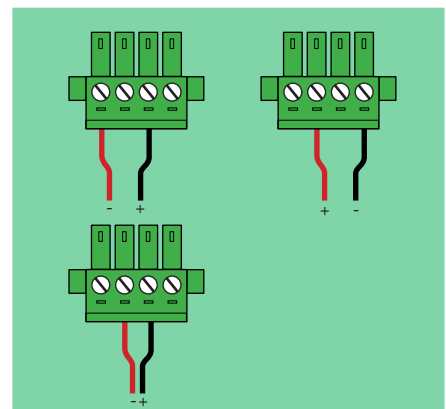
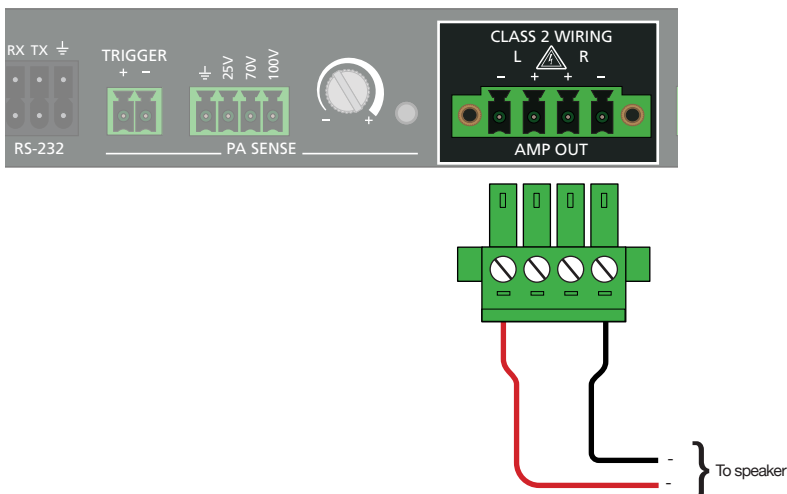

PA Sense

This section covers PA sense, which mutes the current audio program for the duration of a PA broadcast. The AT-OME-CS31-SA-HDBT provides two options to trigger PA sense: 1) by tapping into the speaker wire or 2) using the **TRIGGER** port.

Tapping into the Speaker Wiring

1. Locate the last speaker in series. If this is not possible, locate the closest speaker to the AT-OME-CS31-SA-HDBT, based on the length of wiring used.
2. Connect the wire, from the speaker system, to the **PA SENSE** port using the included 4-pin captive screw connector. The example, below, is wired for a 70 V system.



IMPORTANT: The AT-OME-CS31-SA-HDBT supports 25 V, 70 V, and 100 V systems. The wiring of the **PA SENSE** port must match the voltage rating of the system's amplifier.

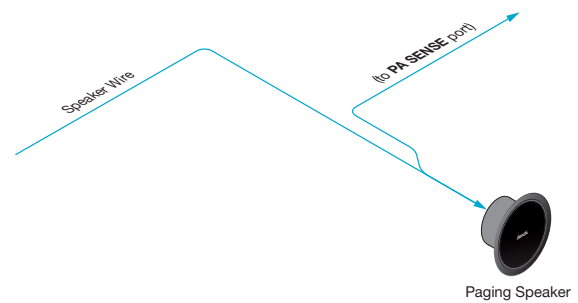
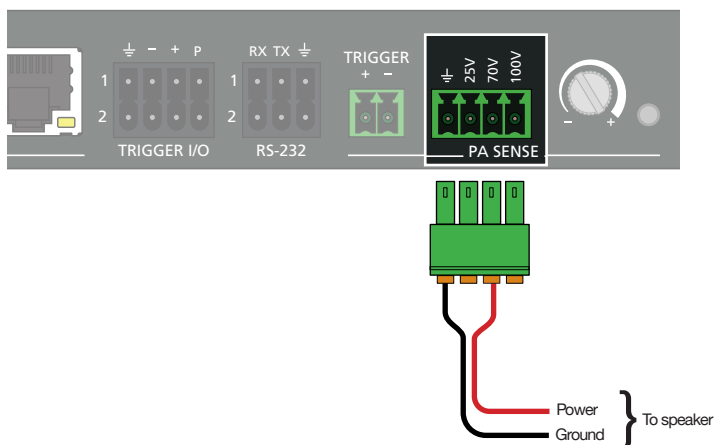

3. Adjust the **PA SENSE** pot to fine-tune the sensitivity.

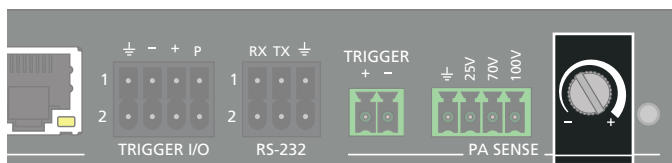

Connecting to a Paging Sensor

1. Connect the included 2-pin captive screw connector from the **TRIGGER** port to the paging sensor.

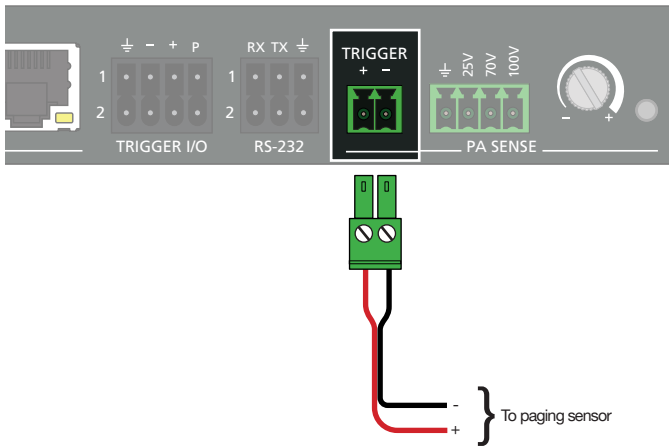

2. Log in to the web server.
3. Click **Audio** > **PA Sense** in the menu bar.
4. Enter the release time, in seconds, in the **Release Time** field.
5. Click the **Trigger Mode** drop-down list and select the desired mode. This port can be configured as **NO** (normally open) or **NC** (normally closed). By default, it is set to **NO**.

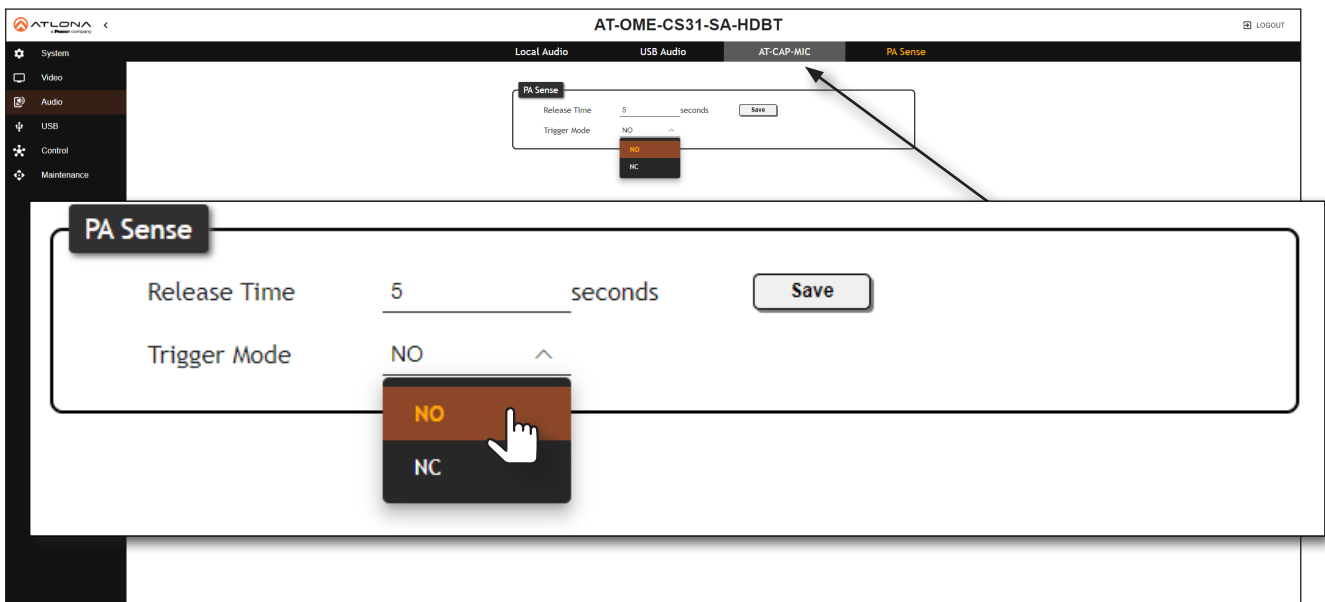

6. Click the **Save** button to commit changes.

USB Routing and Management

The AT-OME-CS31-SA-HDBT provides two different USB modes: **Follow Video**, and **Manual**. Each mode provides a different method of controlling USB, based on how the system is connected. Both modes will be covered in this section. VBus control will also be covered.

Follow Video

This is the default mode. The drop-down lists for each input are locked and cannot be changed. Since there is only one **HOST** port, the host device will have access to the same USB devices, when switching between inputs. Note that **HDBaseT In 1** is assigned to **HDBaseT USB**, not to **Local USB-B Host** (**HOST** port on the AT-OME-CS31-SA-HDBT). This means that the HDBaseT source will use the USB host port on the transmitter.

1. Connect the host computer to the **HOST** port.
2. Log in to the web server.
3. Click **USB > USB Routing** in the menu bar.
4. Click the **Follow Video** radio button.

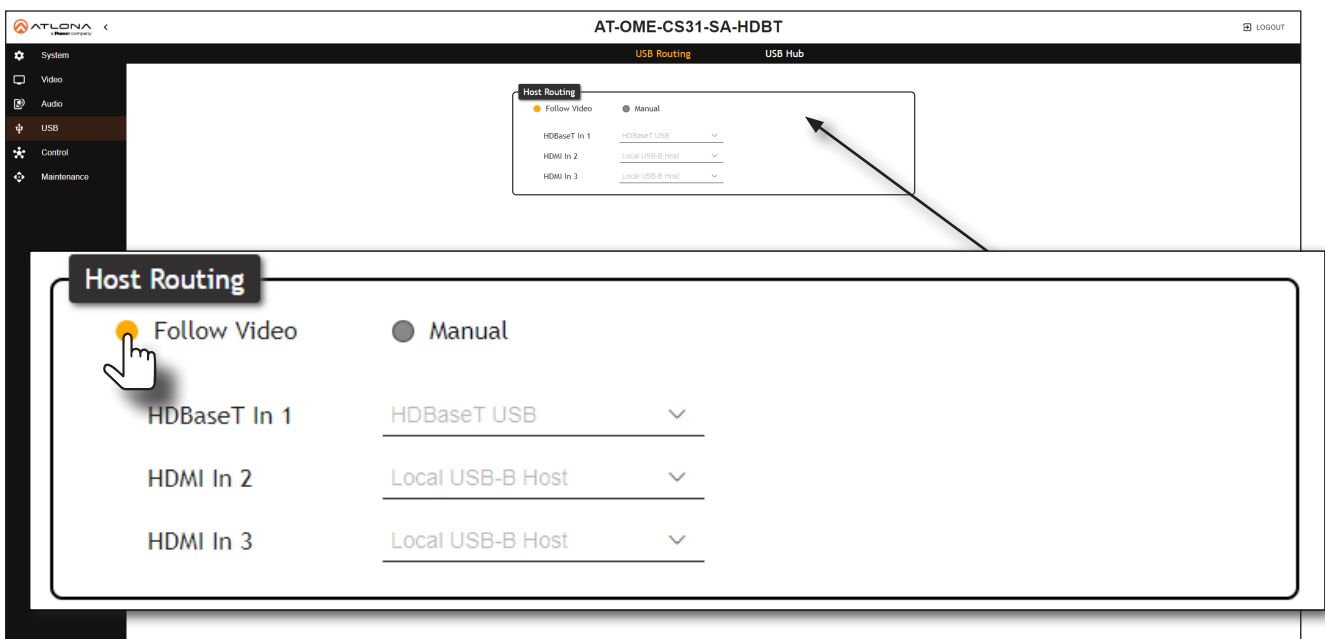

Manual Routing

This mode provides manual selection of the USB host port to be used.

1. Connect the host computer to the **HOST** port.
2. Log in to the web server.
3. Click **USB > USB Routing** in the menu bar.
4. Click the **Manual** radio button.

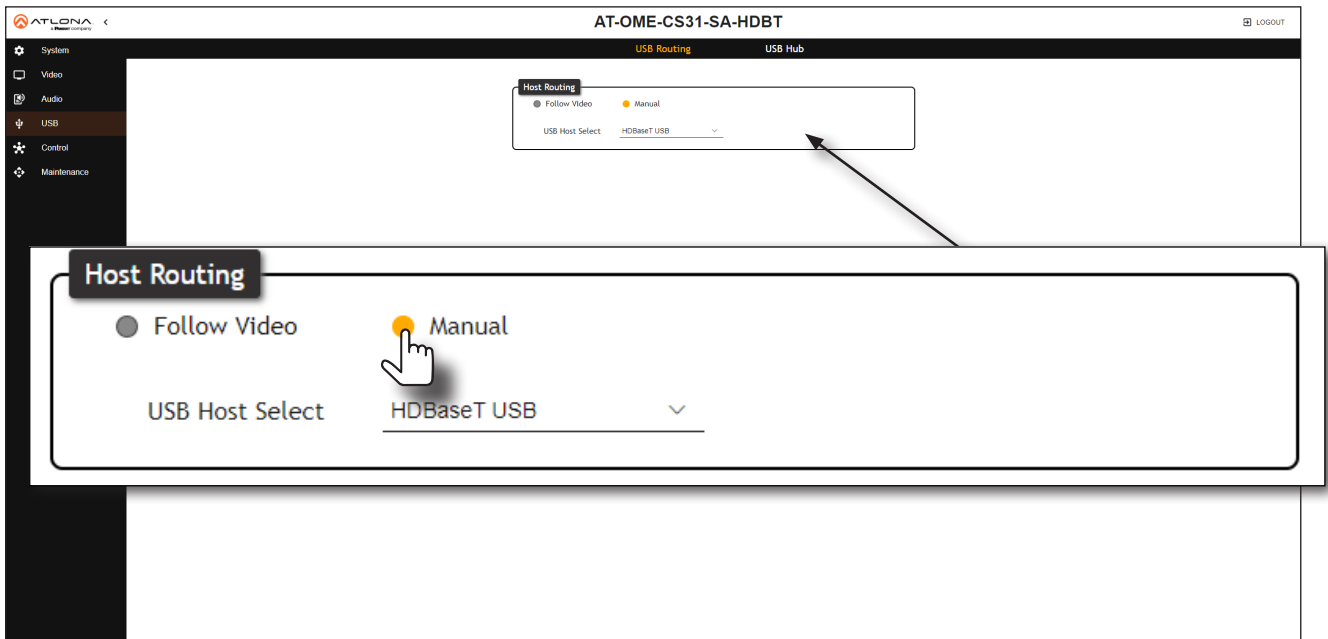

5. Click the **USB Host Select** drop-down list to select the desired USB port.

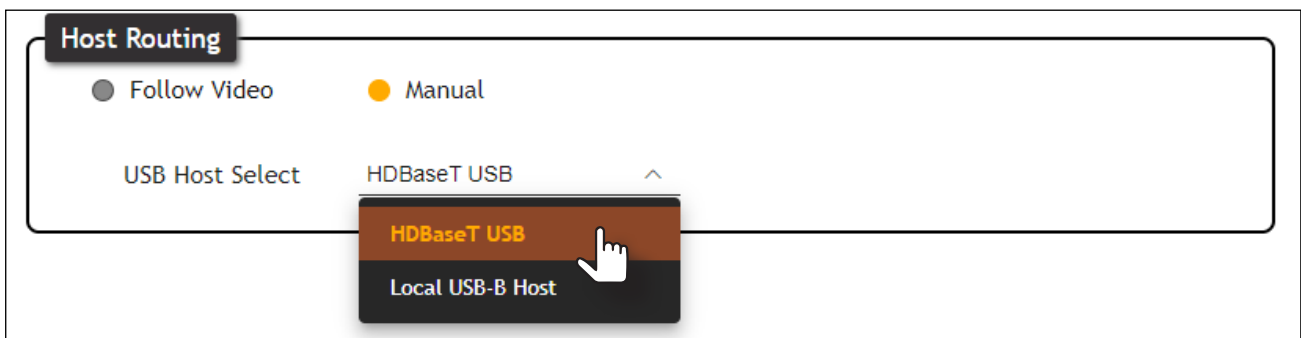

Hub Vbus Control

This feature provides the ability to toggle the USB Vbus. This allows the USB hub port to always provide power or follow the presence of the connected USB host. The default setting is `Follow Presence of USB Host`.

1. Connect the host computer to the **HOST** port.
2. Log in to the web server.
3. Click **USB > USB Hub** in the menu bar.

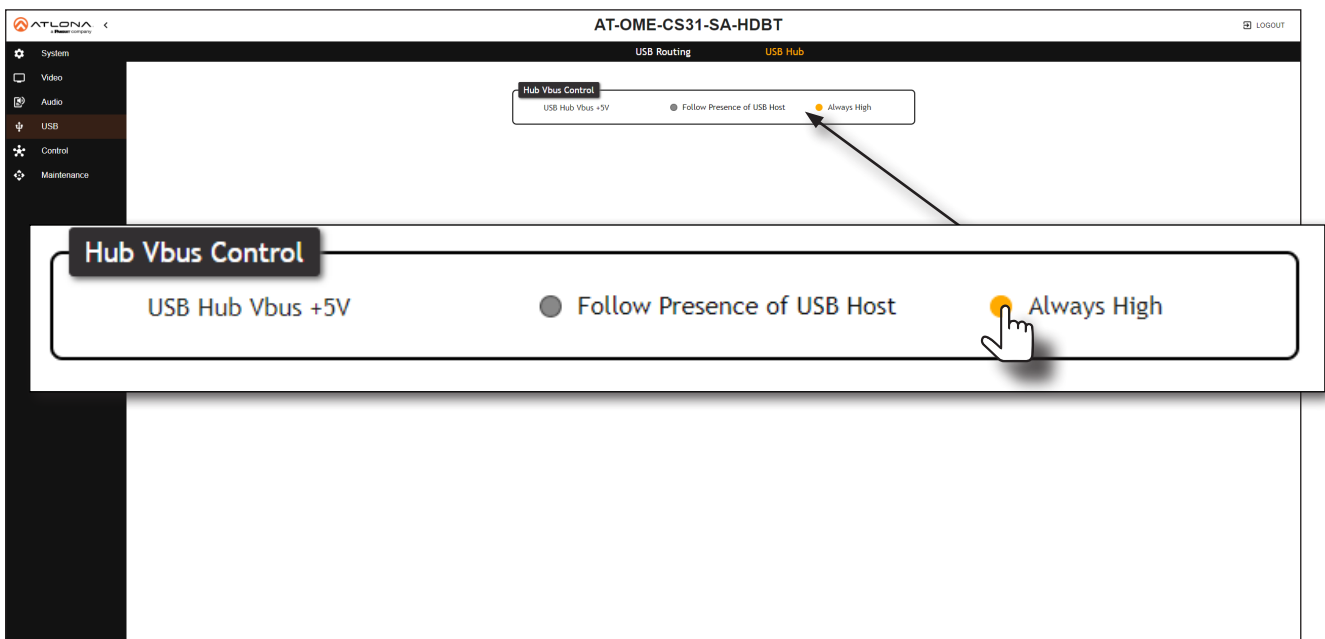

4. Click the desired radio button.

Setting	Description
Follow Presence of USB Host	Allows the USB hub port to toggle on and off based on the presence of a USB host.
Always High	USB power to the HOST port is always on. For example, when connecting to the AT-CAP-SP100, setting this feature to <code>Always High</code> would allow the AT-CAP-SP100 to continually charge, even if no USB host is present.

LAN Management

This section covers enabling/disabling SSH and/or Telnet protocols, in addition to changing the password.

Changing the Admin Password

1. Log in to the web server.
2. Click **Control** > **LAN** in the menu bar.
3. Click the **Admin Password** field and enter the new password.
4. Click the **Save** button.

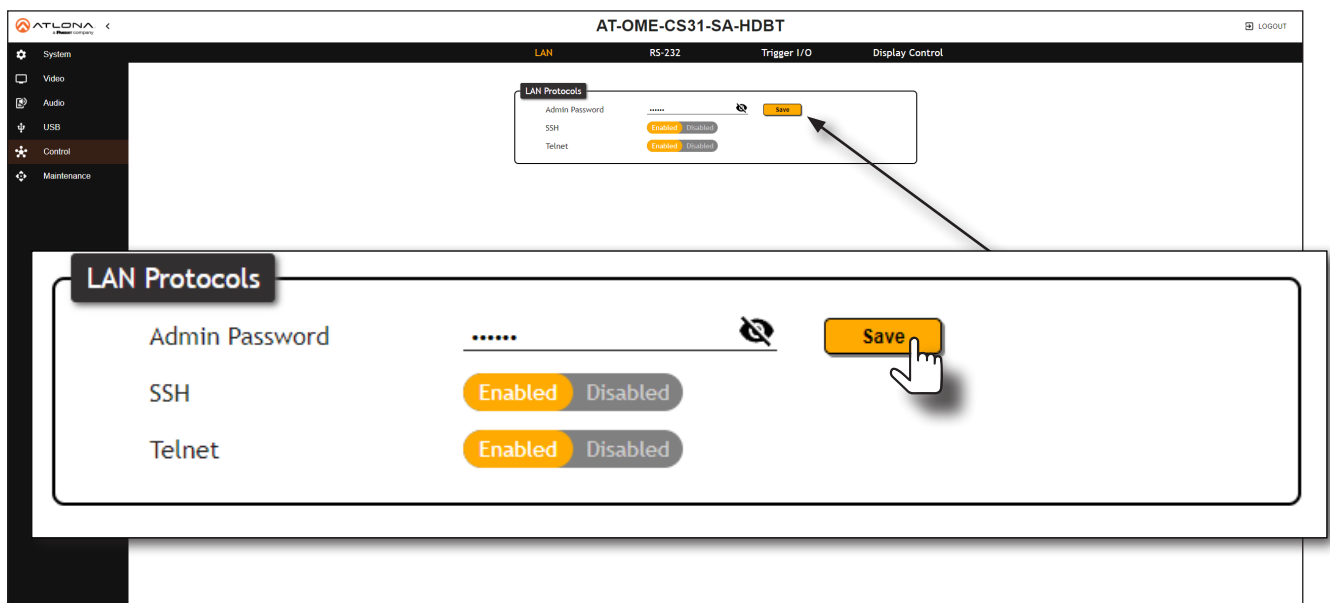

5. The following message will be displayed.

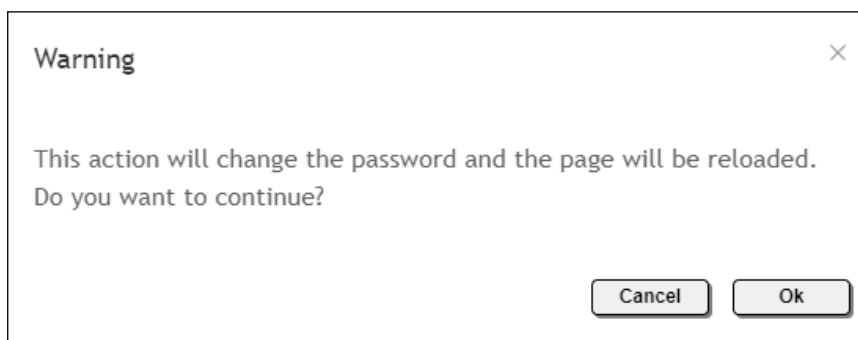

6. Click **Ok** to continue with the password change or click **Cancel** to abort and return to the **Control** > **LAN** page.
7. When the password is successfully changed, the following message will be displayed at the bottom of the screen.



Enabling / Disabling SSH and Telnet

Both **SSH** and **Telnet** protocols are enabled, by default.

1. Log in to the web server.
2. Click **Control** > **LAN** in the menu bar.
3. Click the **SSH** and/or **Telnet** toggles to the **Enabled** or **Disabled** position.

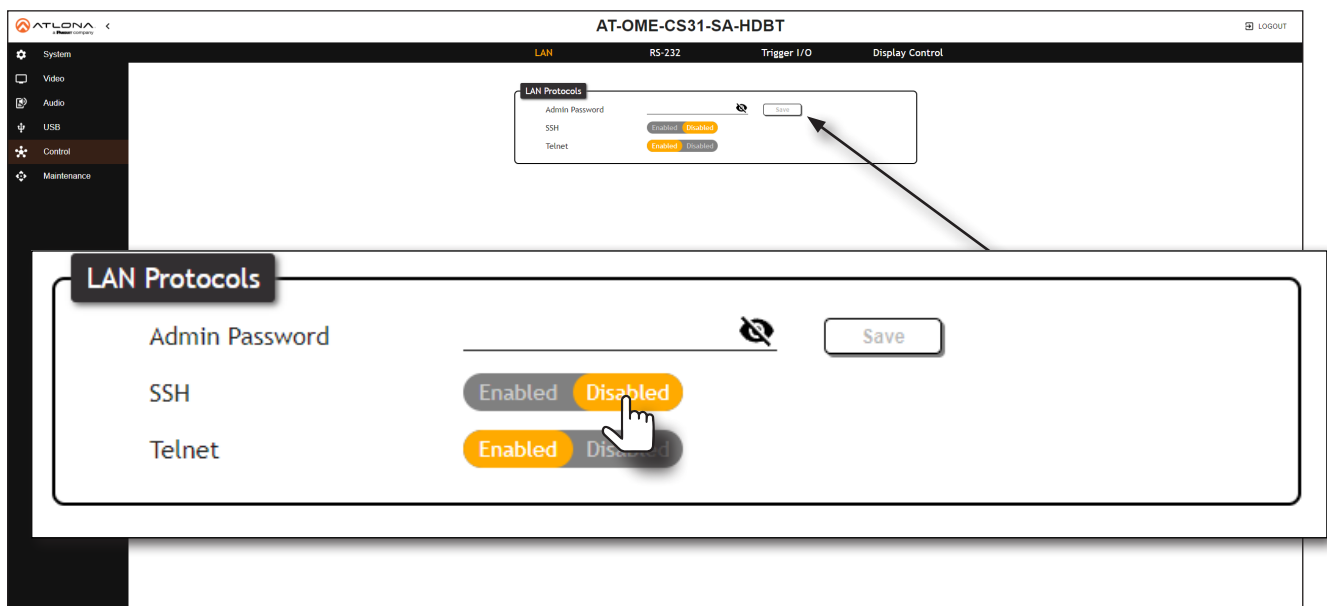

RS-232 Control

The **RS-232** port is used to directly control the AT-OME-CS31-SA-HDBT using a control system (Console Mode). To control a display, refer to [Display Control](#) (page 46).

Console Mode

1. Connect the RS-232 cable between the control system and the **RS-232** port on the AT-OME-CS31-SA-HDBT. Use the included 2 x 3-pin push-pin connector to wire the RS-232 cable as shown.

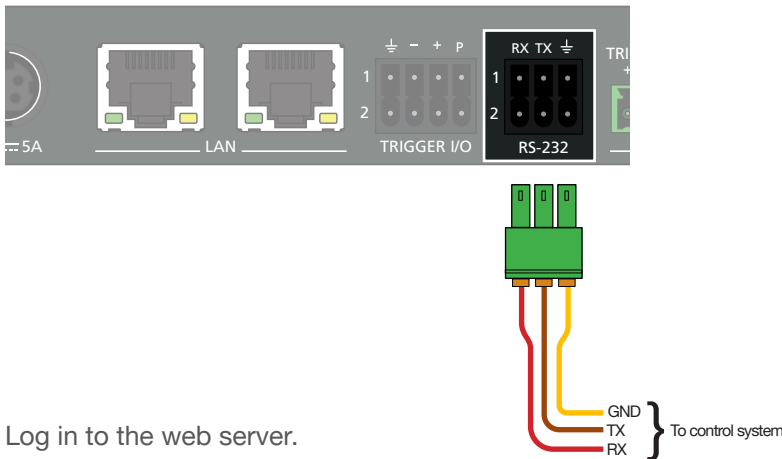

2. Log in to the web server.
3. Click **Control** > **RS-232** in the menu bar.

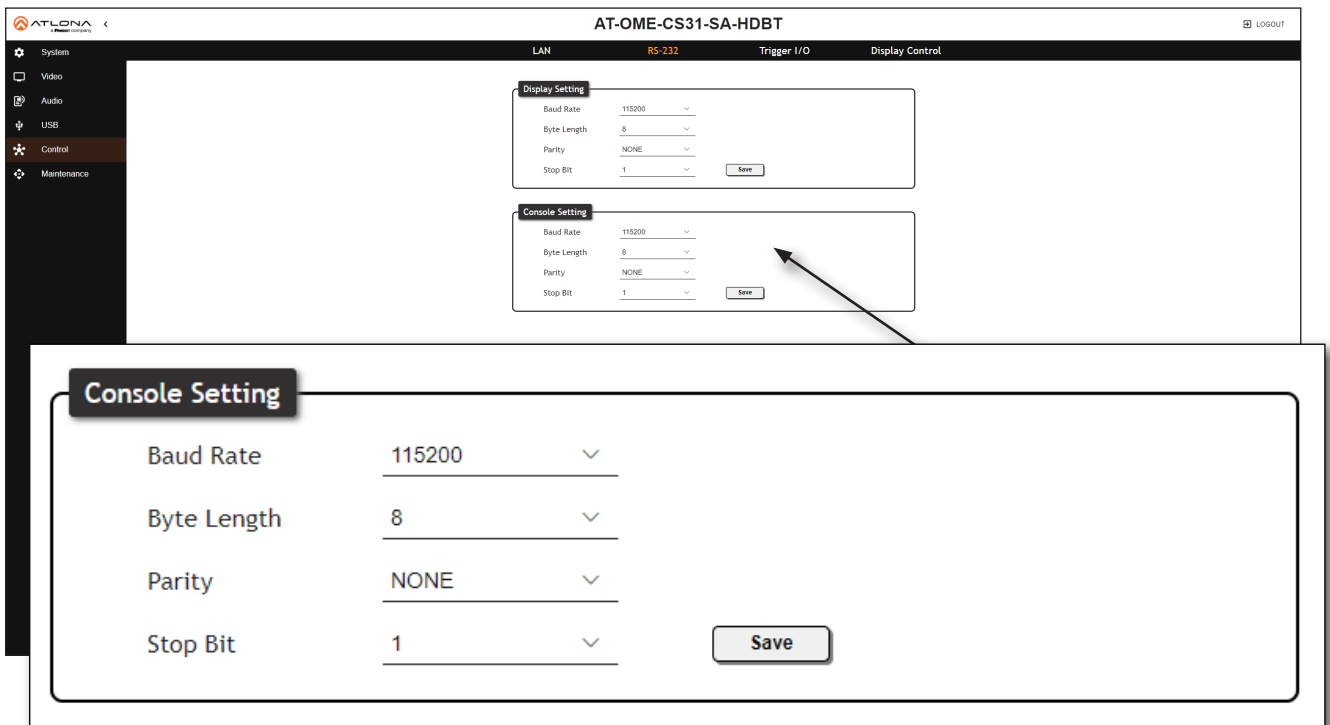

4. Under the **Console Setting** section, select the proper baud rate, data bit, parity, and stop bit settings. These settings must correspond with the control system RS-232 settings.
5. Click the **Save** button to commit changes.

Occupancy Sensor Integration

The following provides instructions on adding any occupancy sensor to the AT-OME-CS31-SA-HDBT. The AT-OME-CS31-SA-HDBT can support two standard occupancy sensors and two Atlona AT-OCS-900N devices at the same time.

Using Generic Occupancy Sensors

1. Connect the included 2 x 4-pin push-pin connector between the occupancy sensor and the **TRIGGER I/O** port on the AT-OME-CS31-SA-HDBT, as shown. Verify the wiring for the type of sensor that is being used. Voltage range: +3 to +30 V DC. 0 V = Off. +3 to +30 V DC = On.

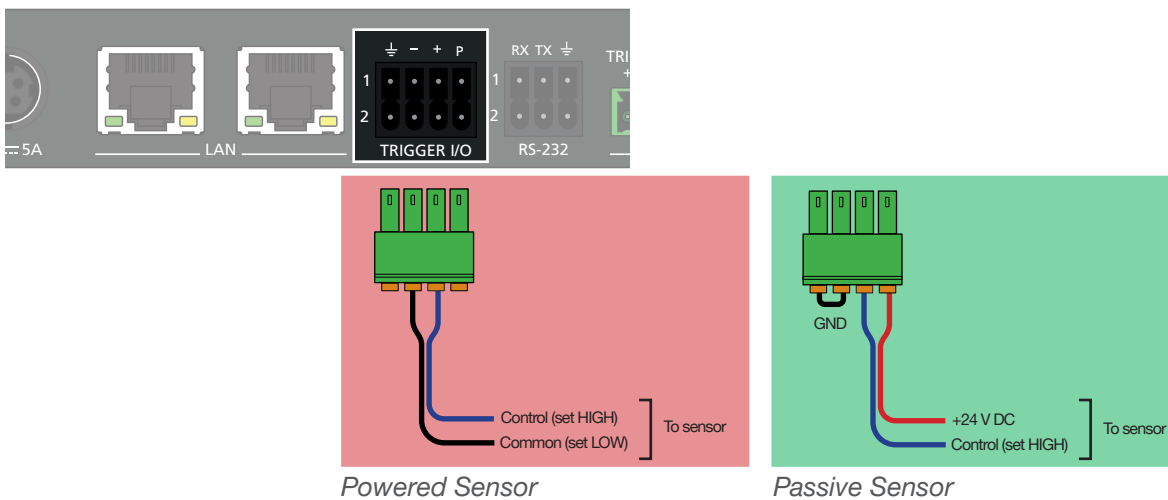

NOTE: If only a single port is required, single-port captive screws are also included. When using the single-port captive screw connectors, make sure that the connector is wired with the screw heads facing down.

2. Login to the web server of the AT-OME-CS31-SA-HDBT.
3. Click **Control > Trigger I/O** in the menu bar.
4. Locate the **Trigger I/O OCS** section and select the desired functionality of the occupancy sensor.

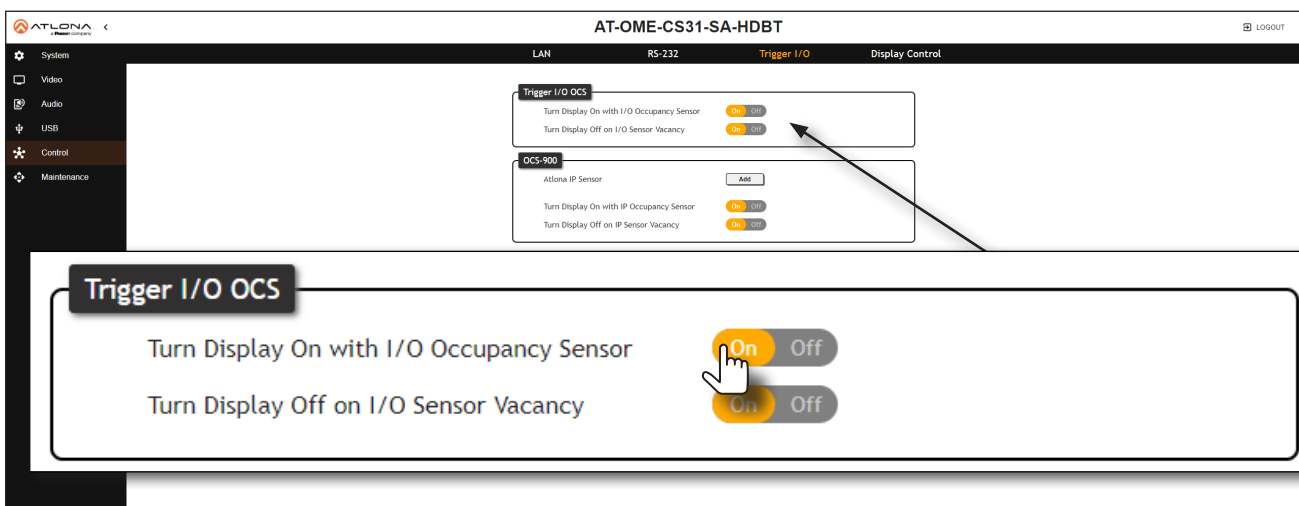

- Click the **Turn Display On with I/O Occupancy Sensor** toggle to the **On** or **Off** position. When **On**, the display will stay powered when the room is occupied.
- Click the **Turn Display Off on I/O Sensor Vacancy** toggle to the **On** or **Off** position. When **On**, the toggle will power-off the display when the room is no longer occupied.

Using the AT-OCS-900N

The following provides instructions on adding the AT-OCS-900N occupancy sensor as a device. The **Auto Switch** feature on the AT-OME-CS31-SA-HDBT does not need to be enabled for this to work. The AT-OME-CS31-SA-HDBT supports a maximum of two AT-OCS-900N devices.

1. Connect the AT-OCS-900N to the same network as the AT-OME-CS31-SA-HDBT. Refer to the AT-OCS-900N User Manual for more information.



IMPORTANT: A username and password must be configured on the AT-OCS-900N before using the device with the AT-OME-CS31-SA-HDBT.

2. Login to the web server of the AT-OME-CS31-SA-HDBT.
3. Click **Control** > **Trigger I/O** in the menu bar.
4. Locate the **OCS-900** section.
5. Click the **Add** button.

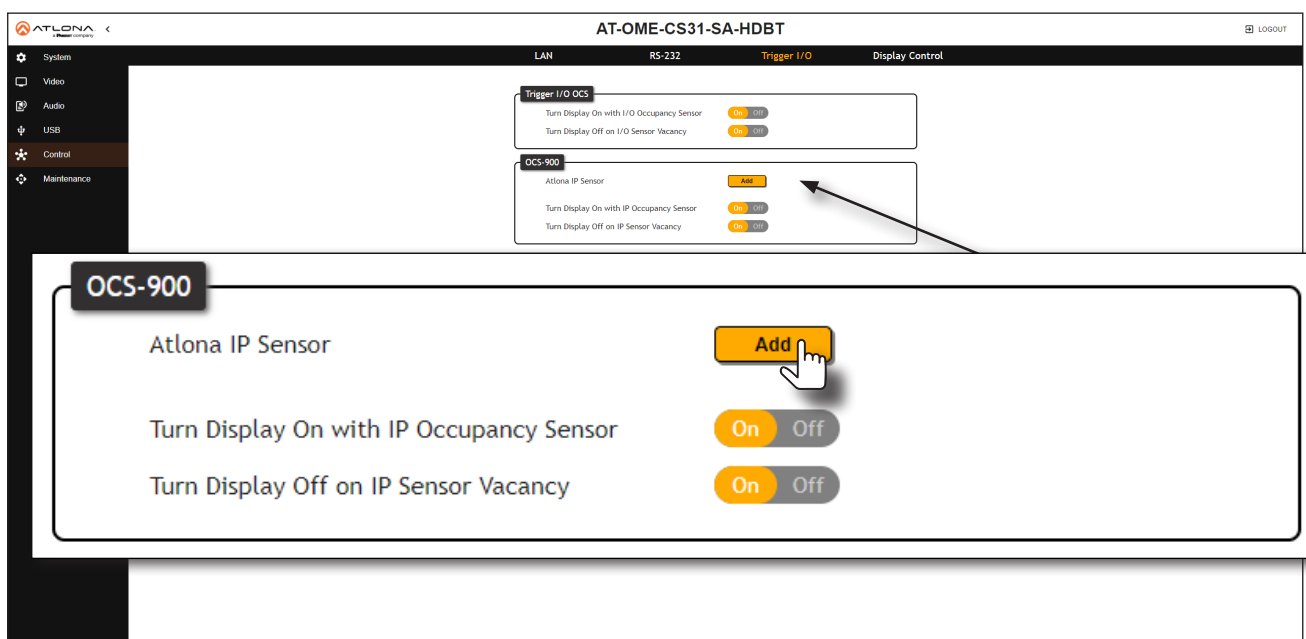

The screenshot shows the AT-OME-CS31-SA-HDBT web interface. The top navigation bar includes 'LAN', 'RS-232', 'Trigger I/O', and 'Display Control'. The 'Trigger I/O OCS' section contains two rows of controls:

- Trigger I/O OCS:**
 - Turn Display On with I/O Occupancy Sensor: **On** (yellow) / **Off** (grey)
 - Turn Display Off on I/O Sensor Vacancy: **On** (yellow) / **Off** (grey)
- OCS-900:**
 - Atlona IP Sensor: **Add** (yellow button)
 - Turn Display On with IP Occupancy Sensor: **On** (yellow) / **Off** (grey)
 - Turn Display Off on IP Sensor Vacancy: **On** (yellow) / **Off** (grey)

An arrow points from the 'Add' button in the OCS-900 section to a larger, detailed view of the OCS-900 controls shown in a separate box below. This detailed view shows the 'Atlona IP Sensor' label, the 'Add' button, and the two toggle switches for 'Turn Display On with IP Occupancy Sensor' and 'Turn Display Off on IP Sensor Vacancy'.

6. Enter the IP address of the AT-OCS-900N in the **IP Address** field.

Add Sensor
✕

Host

Port

7. Click the **Add** button. If the correct IP address was entered and the AT-OCS-900N is found, information about the sensor will be displayed.

Trigger I/O OCS

Turn Display On with I/O Occupancy Sensor On Off

Turn Display Off on I/O Sensor Vacancy On Off

OCS-900

Atlona IP Sensor

OCS-900 Status (Connection, IP and Occupancy)

●
10.1.0.25:9000, Occupancy Detected

🗑️

Turn Display On with IP Occupancy Sensor On Off

Turn Display Off on IP Sensor Vacancy On Off

- Click the **Turn Display On with IP Occupancy Sensor** toggle to the **On** or **Off** position. When **On**, the display will stay powered when the room is occupied.
- Click the **Turn Display Off on IP Sensor Vacancy** toggle to the **On** or **Off** position. When **On**, the toggle will power-off the display when the room is no longer occupied.
- Click the **Identify** button to identify the occupancy sensor. This feature is useful when multiple sensors are connected.

Display Control

The AT-OME-CS31-SA-HDBT provides three protocols for display control: CEC, RS-232, and IP. No external control system is required. Each of these methods will be covered in this section.

Using CEC

Consumer Electronics Control* (CEC) is the simplest method of control when working with a display. Note that the display must have CEC enabled to receive CEC messages. The **HDMI OUT** port is used for CEC control.

**Atlona has confirmed proper CEC functionality with several current models of Samsung, Panasonic, and Sony displays. However, it is not guaranteed that CEC will work with all displays. Many manufacturers do not support the CEC "off" command, and older displays use proprietary commands. Atlona only supports displays that use the CEC command structure defined in HDMI 1.2a. It is recommended that dealers request an evaluation product from Atlona, before designing a system using the CEC protocol. If this is not possible, then other control methods will need to be considered, in order to control displays using Atlona products.*

1. Enable CEC on the display device. Refer to the documentation for the display device. It should be noted that different manufacturers will identify CEC with their own brand name. Refer to the table below.

Manufacturer	CEC Designation
Hitachi	HDMI-CEC
LG	SIMPLINK
Philips	EasyLink
Samsung	AnyNet+
Sony	BRAVIA Sync
Toshiba	CE Link / REGZA Link
Visio	HDMI-CEC

2. Log in to the web server.
3. Click **Control > Display Control** in the menu bar.
4. Under **Display Control**, click the **Control Type** drop-down list and select **CEC**. This is the default control method.

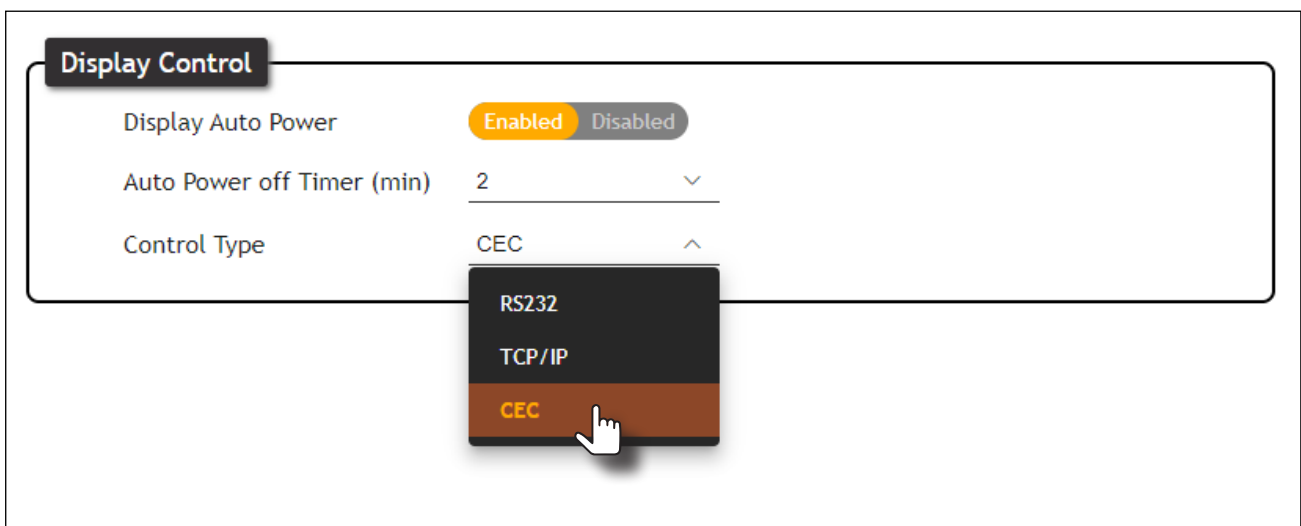

5. Under the **CEC** section, near the top of the page, test the CEC commands for power, volume, and muting by clicking the associated buttons. The display should respond correctly to each of these commands.

If the display does not respond, check the following:

- Verify that CEC is enabled on the display device.
- Verify the integrity of the HDMI cable. Try connecting a different cable between the AT-OME-CS31-SA-HDBT and the display device.
- Try connecting the HDMI cable to a different HDMI input on the display device.

RS-232 Configuration

1. Connect a serial cable from the **RS-232** port on the AT-OME-CS31-SA-HDBT, to the RS-232 port on the display. The included 3-pin push-pin connector should be wired as shown.

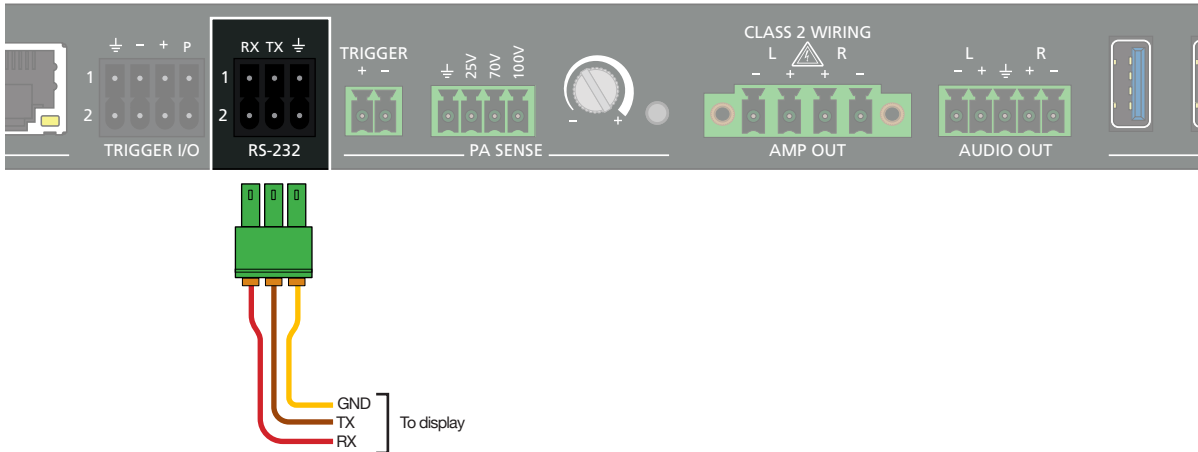

NOTE: If only a single port is required, single-port captive screws are also included. When using the single-port captive screw connectors, make sure that the connector is wired with the screw heads facing down.

2. Log in to the web server.
3. Click **Control** > **RS-232** in the menu bar.

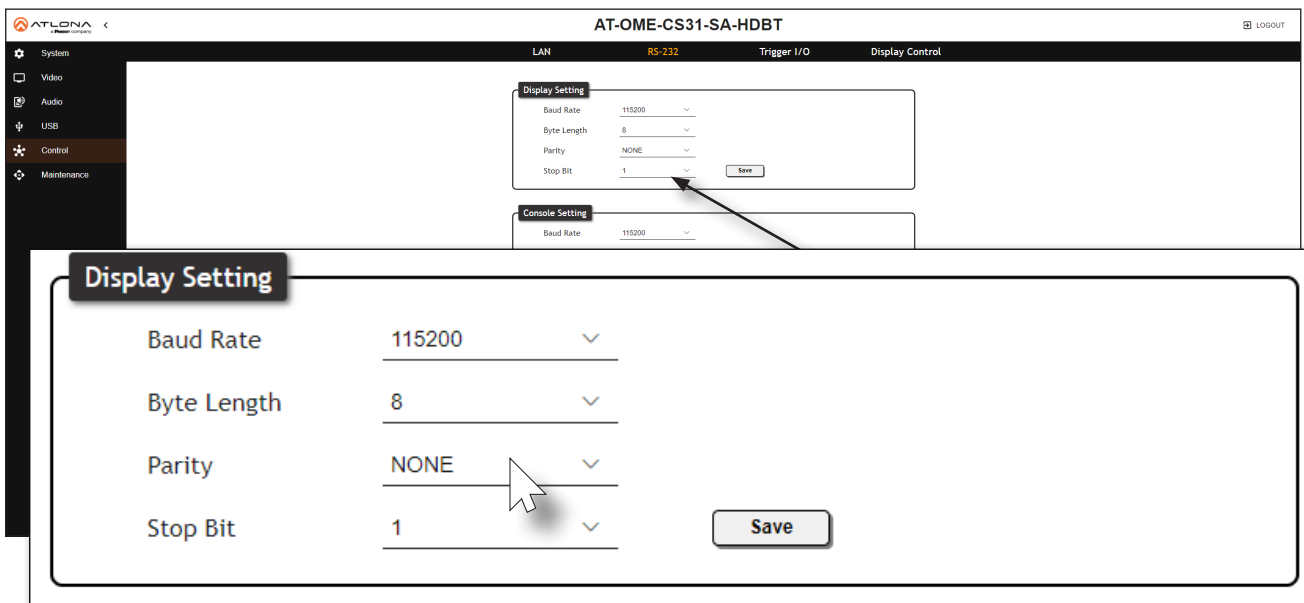

NOTE: Although there are both **Display Setting** and **Console Setting** window groups in the built-in web server, the RS-232 1 and RS-232 2 ports can function as either display or console RS-232 control.

4. Set the RS-232 settings for the display (sink) device. These settings must match the device settings for the display. Refer to the User Manual of the display device for more information.
5. Click **Control** > **Display Control** in the menu bar.
6. Under **System Settings**, click the **Control Type** drop-down list and select RS-232.

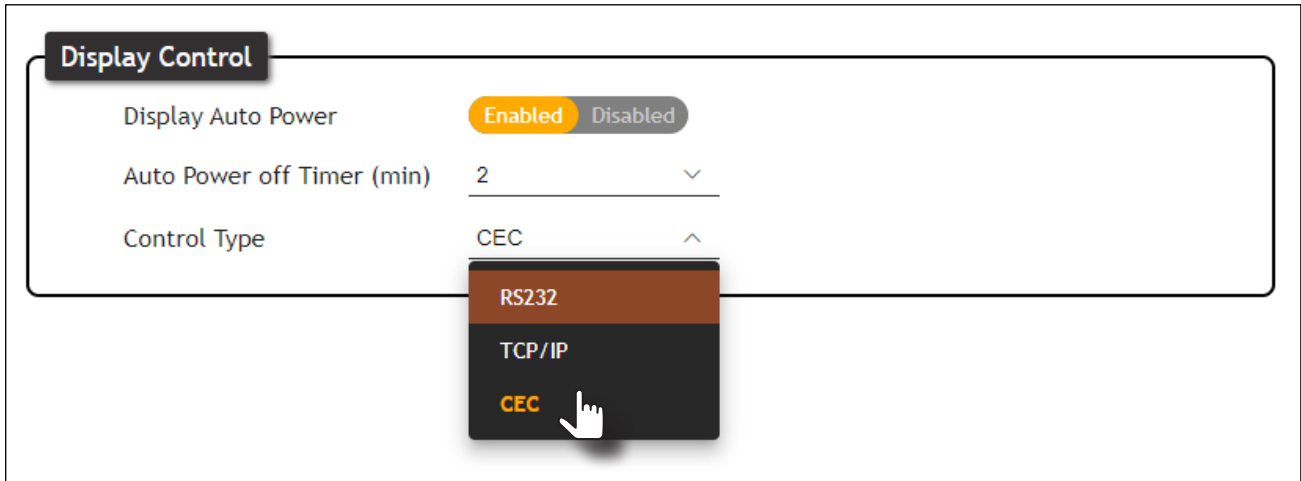

7. Refer to [Completing RS-232 or IP Configuration \(page 51\)](#) for completing the configuration process.

TCP/IP Configuration

Instead of using a serial cable to send commands, this method uses an Ethernet cable to send commands from the AT-OME-CS31-SA-HDBT to the display device over the network.

1. Connect the display to the LAN.
2. Log in to the web server.
3. Click **Control > Display Control** in the menu bar.
4. Click the **Control Type** drop-down list and select `TCP/IP`.

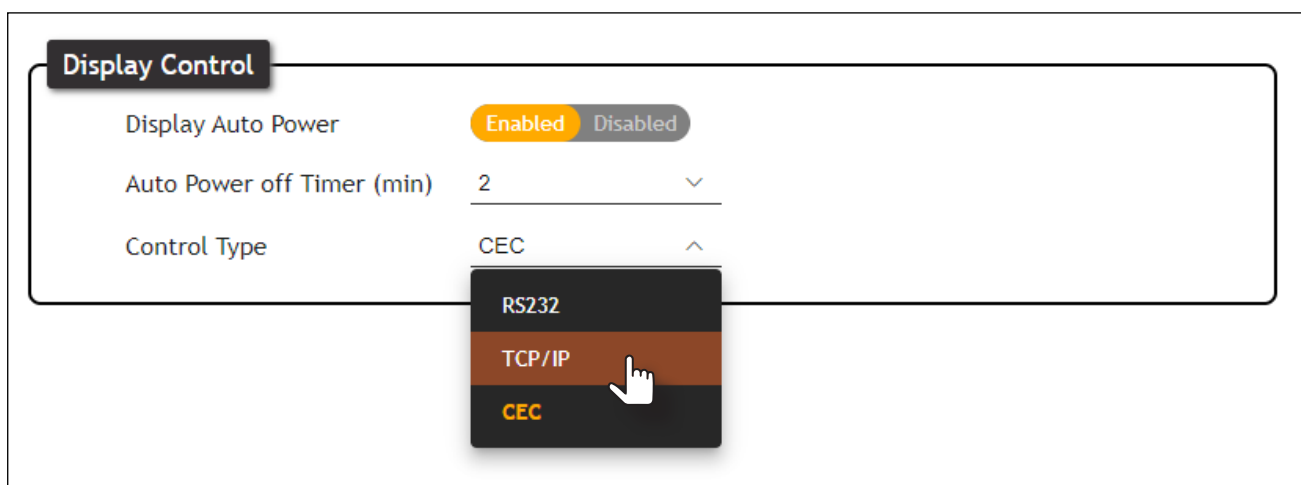

Display Control	
Display Auto Power	Enabled Disabled
Auto Power off Timer (min)	2
Control Type	CEC

- RS232
- TCP/IP**
- CEC

5. Under **Display TCP/IP Settings**, click the **IP Mode** drop-down list and select the desired mode. Selecting `Login` will display the **Username** and **Password** fields, and prompt for these credentials when logging in. If no login credentials are required, then select the `Non-Login` option.
6. Enter the IP address of the display in the **IP Address** field.
7. Enter the port number in the **Port** field.
8. Enter the username and password in the **Username** and **Password** fields, respectively. This option is only required if the **IP Mode** is set to `Login`.
9. Click the **Save** button to commit changes.



Display TCP/IP Settings	
IP Mode	Login
IP Address	10.1.0.68
Port	23
Username	username
Password

Save

Completing RS-232 or IP Configuration

Once RS-232 or IP control has been configured, the commands for power, volume, muting, and volume will need to be assigned.

1. Locate the **Display Commands** section on the **Control > Display** Control page.
2. Some devices may require that the command be sent multiple times before an acknowledge message is received from the display. Refer to the User Manual for the display device for more information. If repeating the command is *not* required, steps 3 and 4 can be skipped.
3. Under **Repeat Command**, click the **Status** toggle switch to the `Enabled` position.
4. Click the **Times** drop-down list and select the number of times which the command must be sent to the device, before an acknowledge message is returned. The available values are 2, 3, and 4.

HEX Command Strings

- a. Enter the hexadecimal command string in the correct field. An example *power-on* command for a display might be:

```
\xBE\xEF\x03\x06\x00\xBA\xD2\x01\x00\x00\x60\x01\x00\x0D
```

This command would be entered in the **ON** field. Consult the documentation for the display for the correct command strings.

- b. Make sure the command string is terminated correctly. In most cases, a CR (carriage return) should be specified. In the example above, `\x0D` is the hexadecimal value for a carriage return.

ASCII Command Strings

- a. Enter the ASCII command string in the correct field. An example *power-on* command for a display might be:

```
PWON
```

This command would be entered in the **ON** field. Consult the documentation for the display for the correct command strings.

5. Click the **Send** button to verify that each command works properly. If not, check the values entered for each command.
6. Click the **Save** button to commit all changes.

System Settings

The AT-OME-CS31-SA-HDBT provides easy access to system configuration through the built-in web server, and is the recommended method to adjust network settings.

System Standby

This mode places the AT-OME-CS31-SA-HDBT in low power mode. Any video output from the unit will be turned off.

1. Log in to the web server.
2. Click **Maintenance** > **System** in the menu bar.
3. Click the **System Standby** toggle switch to the `Enabled` position.

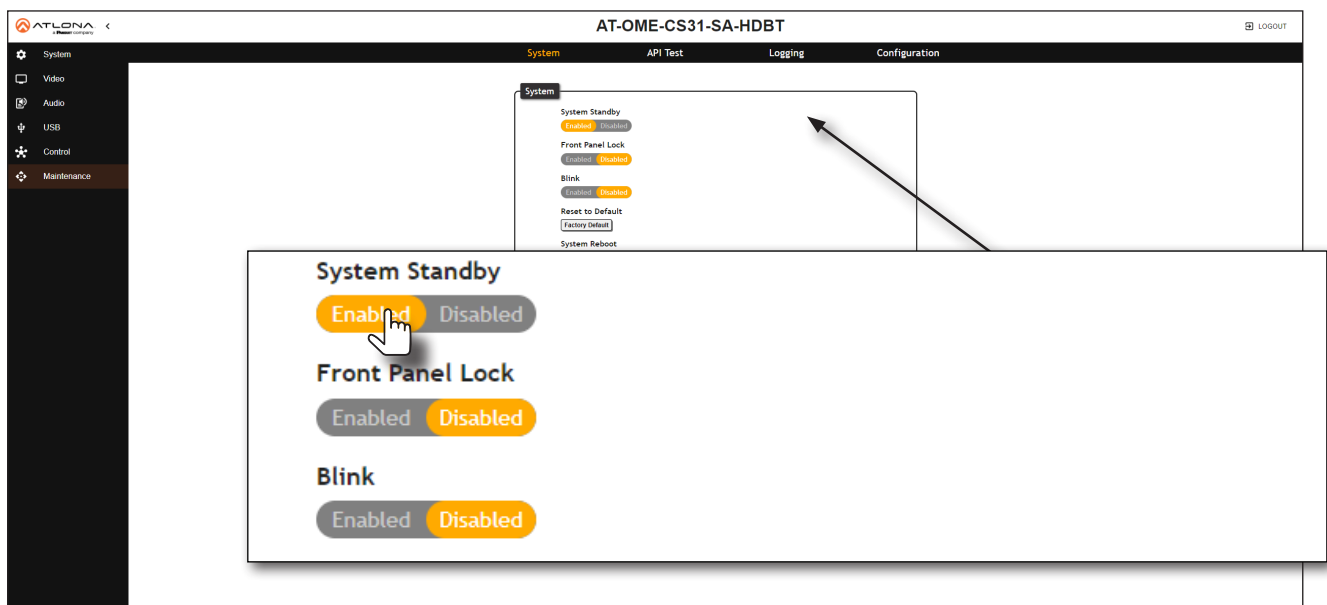

Locking / Unlocking the Front Panel

To prevent accidental pressing of the INPUT button, the front panel can be locked. This may be desirable if, for example, the AT-OME-CS31-SA-HDBT is installed in a rack environment. By default, the front panel buttons are unlocked.

1. Log in to the web server.
2. Click **Maintenance** > **System** in the menu bar.
3. Click the **Front Panel Lock** toggle switch to toggle between values. When set to **Enabled**, the **INPUT** button on the front will be disabled until the toggle switch is set to **Disabled**.

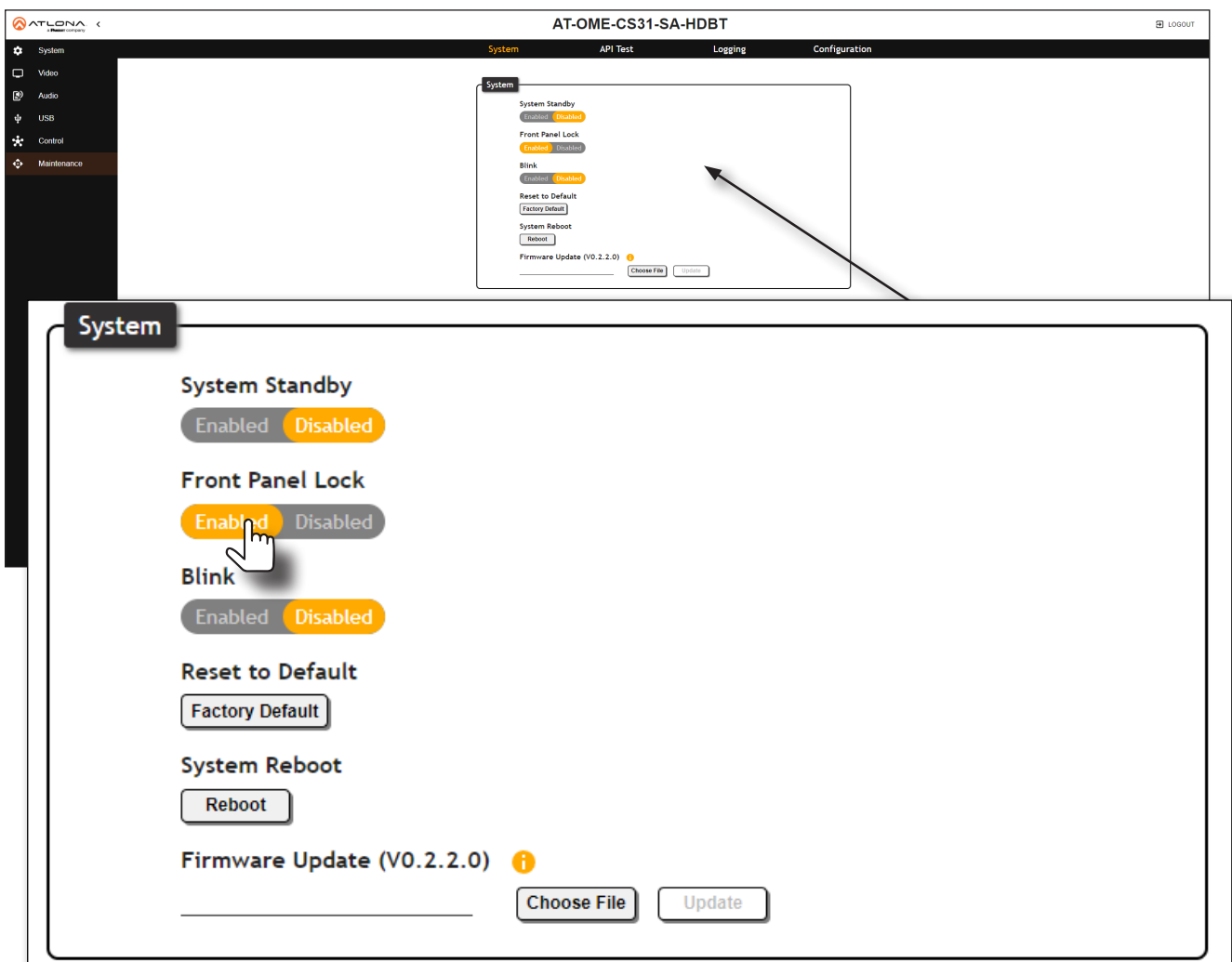

Blink

This feature is useful to visually identify the AT-OME-CS31-SA-HDBT in a rack environment, particularly when multiple units are installed. When this feature is set to `Enabled`, all LED indicators on the front panel will flash continuously until the feature is set to `Disabled`.



NOTE: If an HDBaseT transmitter is not connected to the **HDBaseT IN** port, on the AT-OME-CS31-SA-HDBT, then the **LINK** LED indicator will not flash.

1. Log in to the web server.
2. Click **Maintenance** > **System** in the menu bar.
3. Click the **Front Panel Lock** toggle switch to toggle between values. When set to `Enabled`, the **INPUT** button on the front will be disabled until the toggle switch is set to `Disabled`.

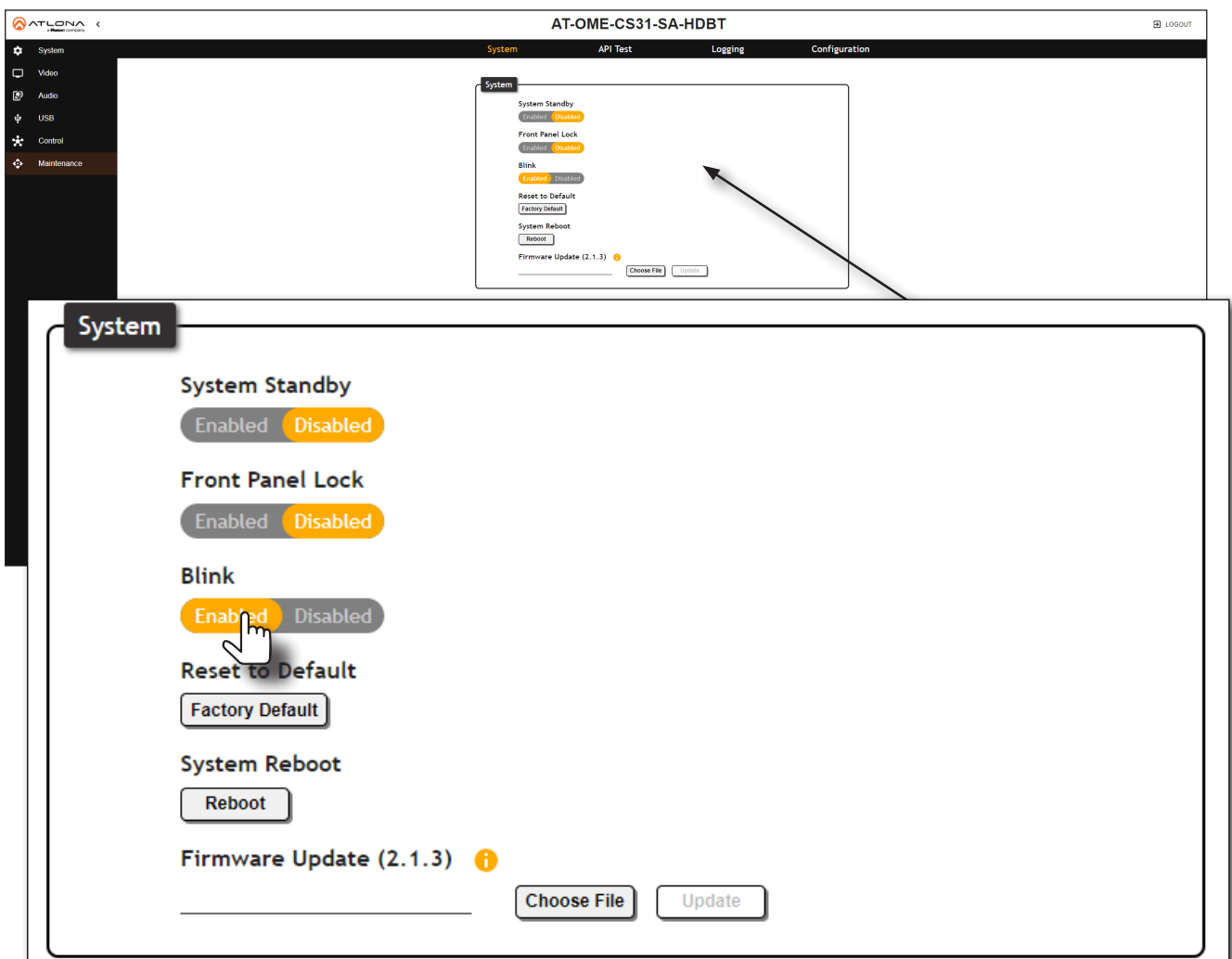

The screenshot shows the web interface for the AT-OME-CS31-SA-HDBT device. The main menu on the left includes System, Video, Audio, USB, Control, and Maintenance. The 'System' page is active, displaying various configuration options:

- System Standby:** Enabled (selected), Disabled
- Front Panel Lock:** Enabled (selected), Disabled
- Blink:** Enabled (selected), Disabled (highlighted with a hand cursor)
- Reset to Default:** Factory Default
- System Reboot:** Reboot
- Firmware Update (2.1.3):** Choose File, Update

Resetting to Factory-Default Settings

The AT-OME-CS31-SA-HDBT can be restored to factory-default settings through the built-in web server or through the INPUT button on the front panel. After performing a factory reset, the network IP mode will be set to DHCP mode and the login credentials will be reset. A new password will need to be created.

Using the Web Server

1. Log in to the web server.
2. Click **Maintenance** > **System** in the menu bar.
3. Click the **Factory Default** button.

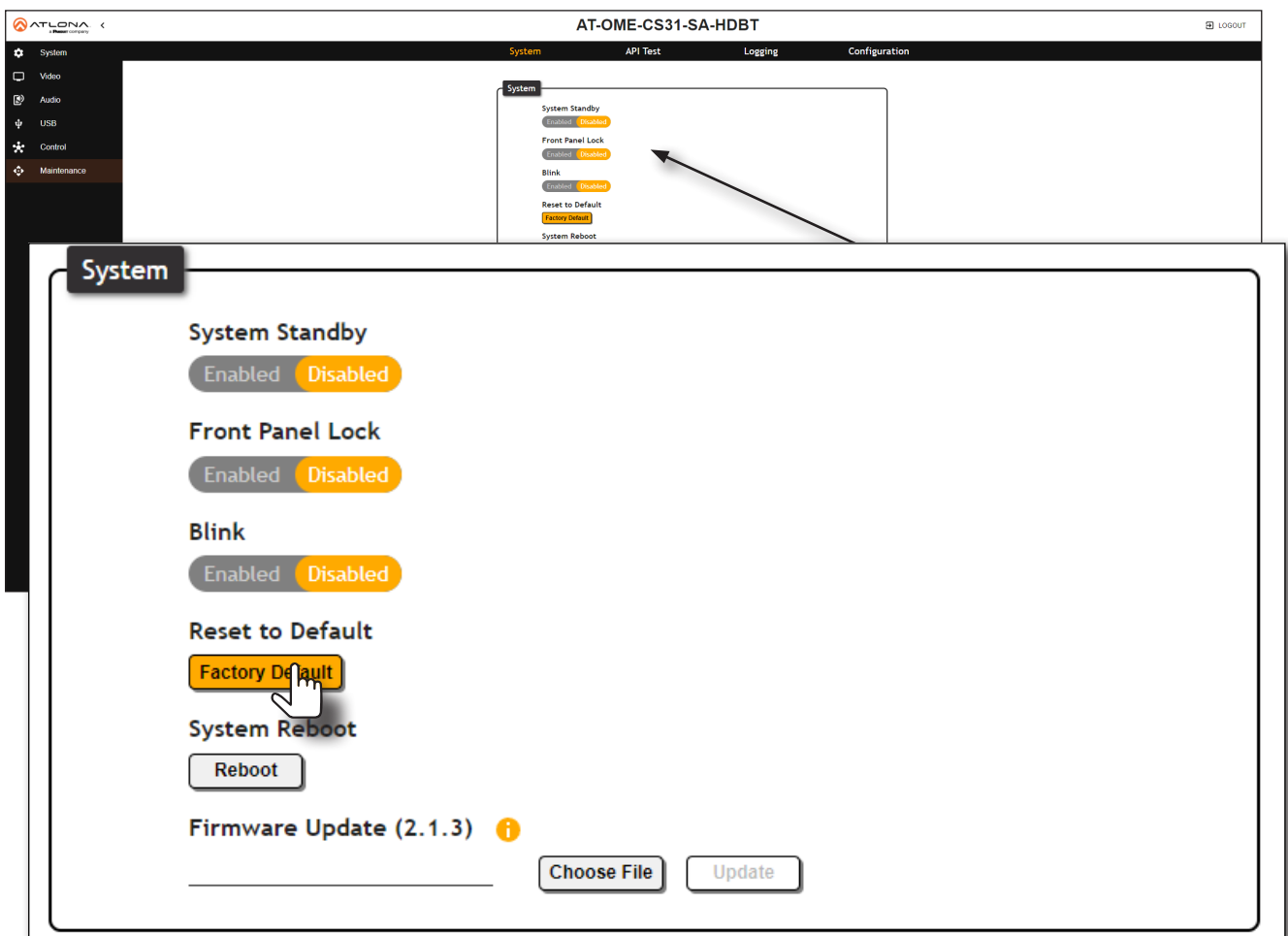

4. The following message will be displayed.

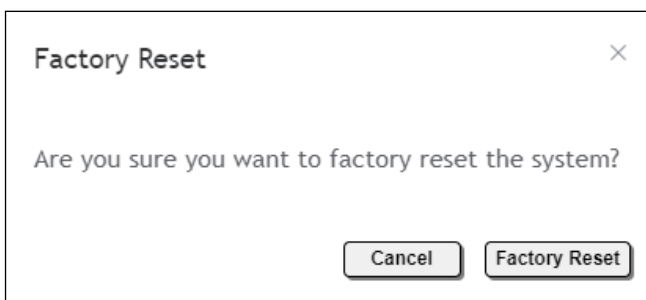

- Click **Factory Reset** to continue with the reset process. Click **Cancel** to abort and return to the **Maintenance > System** page.
- If the **Factory Reset** option is selected, then the following screen will be displayed.

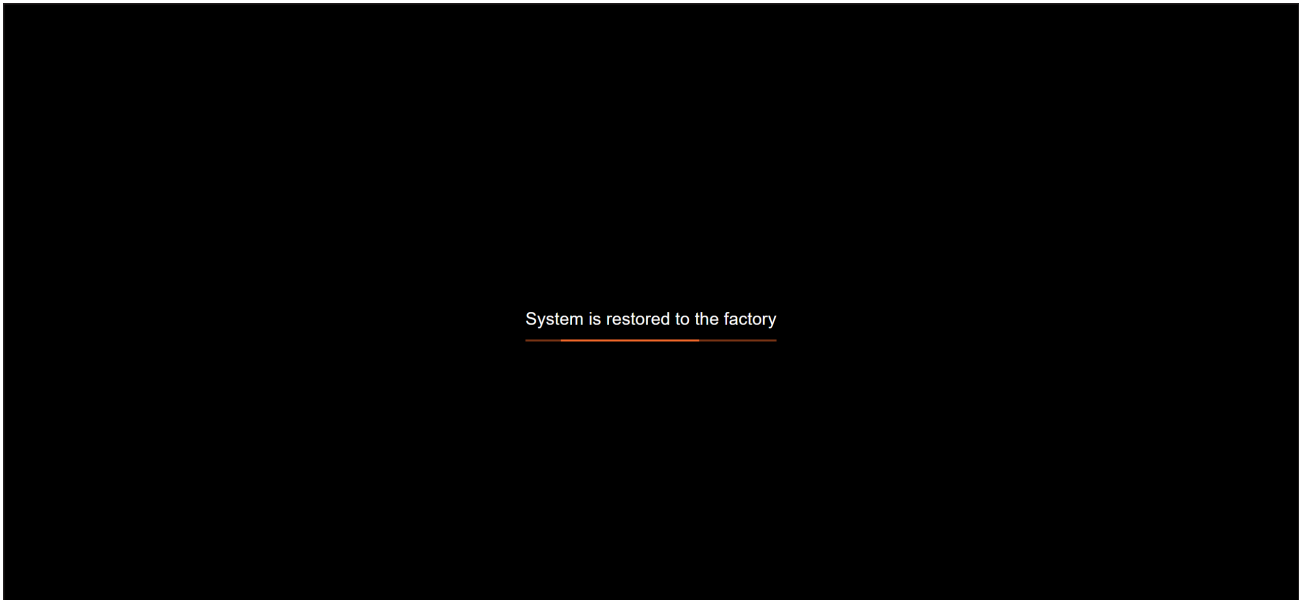

- Once the unit has finished rebooting, the **Login** page will be displayed. Enter `Atlona` in the provided field.
- Click the **Login** button.
- The **Change Password** screen will be displayed.

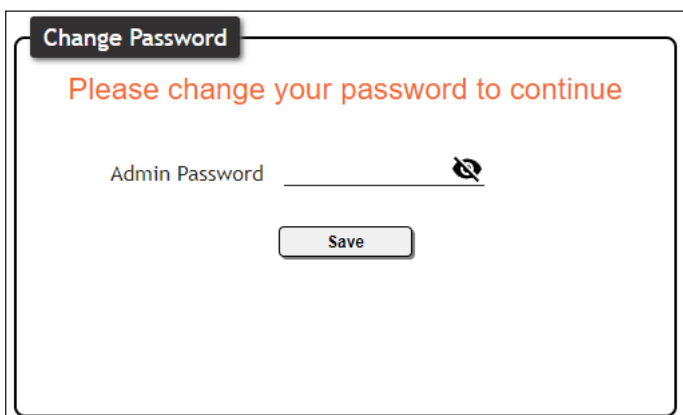

Change Password

Please change your password to continue

Admin Password 

Save

- Enter the desired password in the **Admin Password** field.



NOTE: Passwords can be 5 to 32 characters in length and can only contain letters, numbers, dashes, underscores, and periods.

- Click the **Save** button.
- The **System > Info** page will be displayed.

Using the Front Panel

1. Press and hold the **INPUT** button, on the front panel, for 10 seconds. While holding the INPUT button, the **LAN** LED indicator will flash.

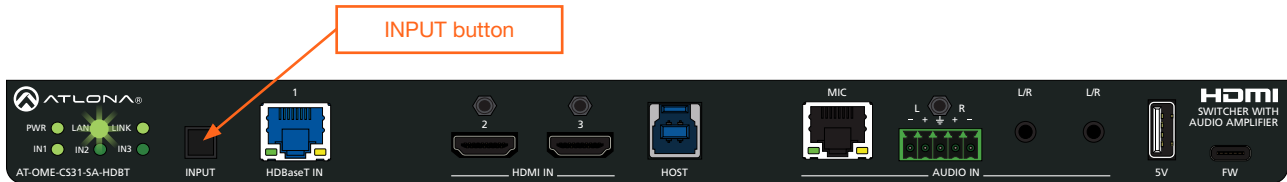

2. Release the **INPUT** button.
3. The AT-OME-CS31-SA-HDBT has been restored to factory settings.
4. Create a new password. Refer to [Login Registration \(page 17\)](#) for more information. To set the IP mode, refer to [Setting the IP Mode \(page 19\)](#) for more information.

Performing a System Reboot

The following procedure will reboot the AT-OME-CS31-SA-HDBT. All network and other settings are preserved.

1. Log in to the web server.
2. Click **Maintenance** > **System** in the menu bar.
3. Click the **Reboot** button.

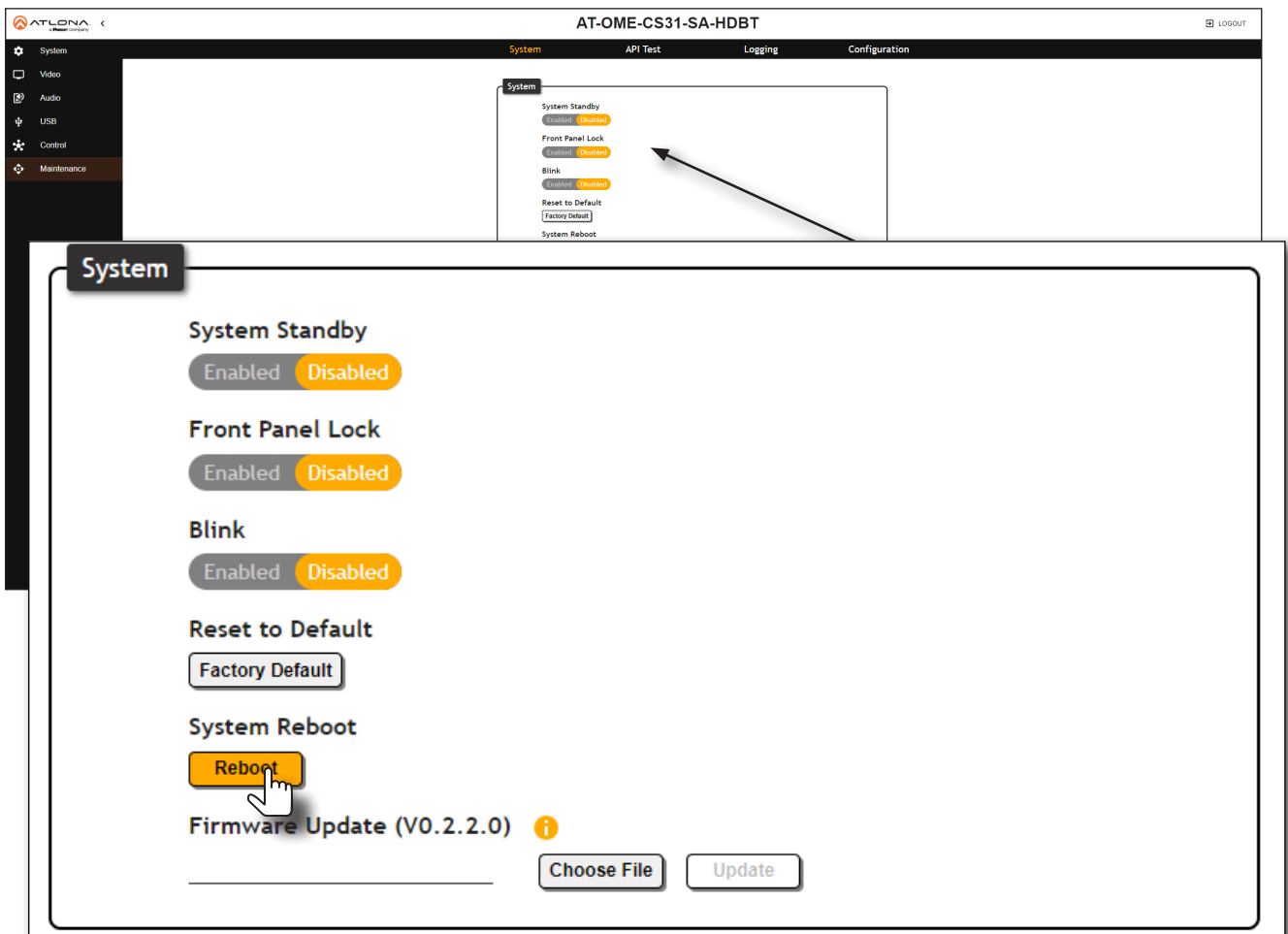

4. The following message will be displayed.

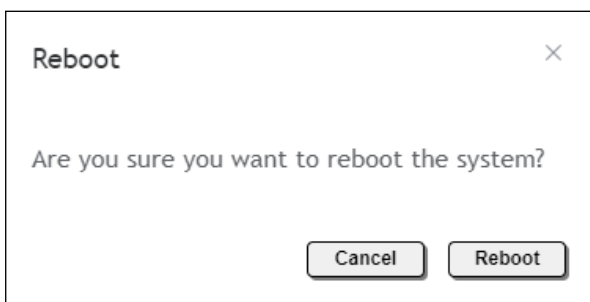

5. Click **Reboot** to continue with the reboot process. Click **Cancel** to abort and return to the **Maintenance** > **System** page.

6. If the **Reboot** option is selected, then the following screen will be displayed.

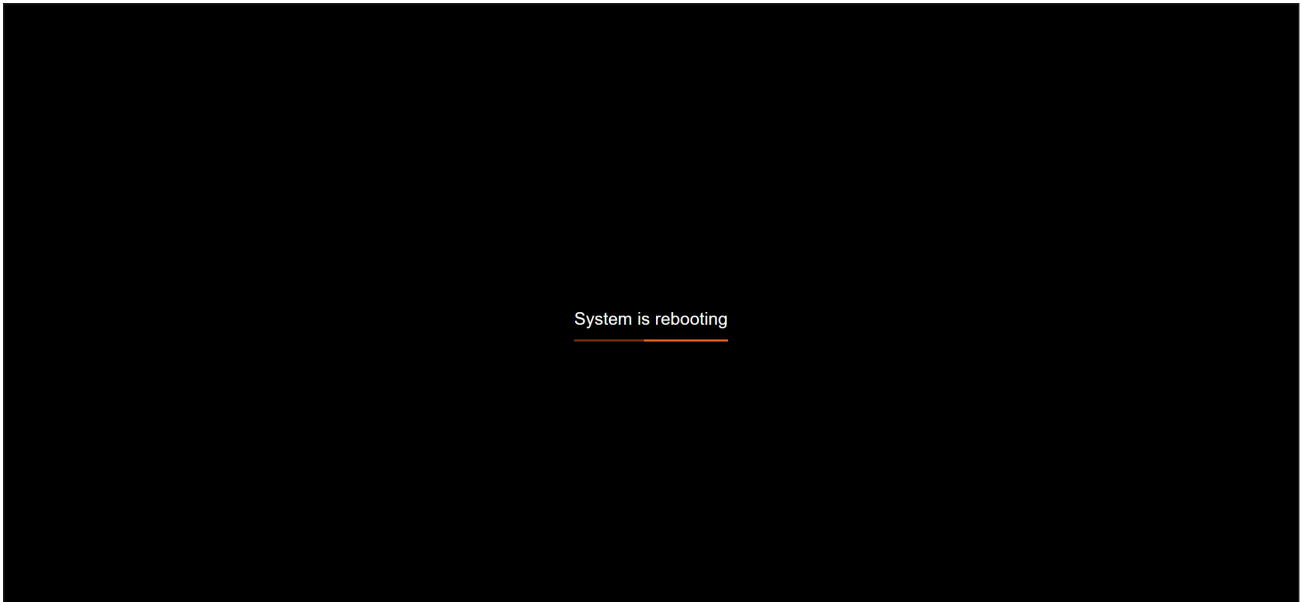

Once the unit has finished rebooting, the **Login** page will be displayed.

API Testing

This page provides testing of JSON command strings.

1. Log in to the web server.
2. Click **Maintenance > API Test** in the menu bar.
3. Enter the JSON string in the **API Command** field.
4. Click the **Send** button.



5. If the JSON is valid, feedback will be displayed under the **Live Log** section.

Live Log		
Time	Verbosity	Message
08:28:24	Receive	{"id":"X","jsonrpc":"2.0","result":{"CPLDVer":"1.7","FwVer":"V0.2.2.0","HwVer":"V0.3","MCUVer":"1.1.6","OnTime":"0-1:1:11","SerialNumber":"","USB-C":"","ValensVer":"7.5.21","XMOSVer":"2.2.3","blinkled":false,"frontpanel":false,"model":"AT-OME-CS31-SA-HDBT","network":{"hostname":"CS31HDBT-0EF463","ipaddress":"10.1.0.26","macaddress":"B8:98:B0:0E:F4:63","standby":false}}
08:28:24	Send	{"jsonrpc": "2.0", "id": "X", "method": "System.Get"}

If the JSON command is invalid, then the following message will be displayed at the bottom of the screen:

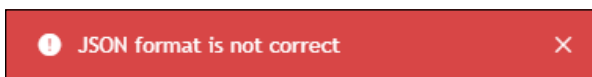

Exporting the System Log

A log of the ARM, MCU, and web sub-system can be provided to technical support if more advanced troubleshooting is required.

1. Log in to the web server.
2. Click **Maintenance** > **Logging** in the menu bar.
3. Click the **Export Log** button.
4. The log file will be exported as a compressed file, such as: LOG_18012024_153532.tar.gz.

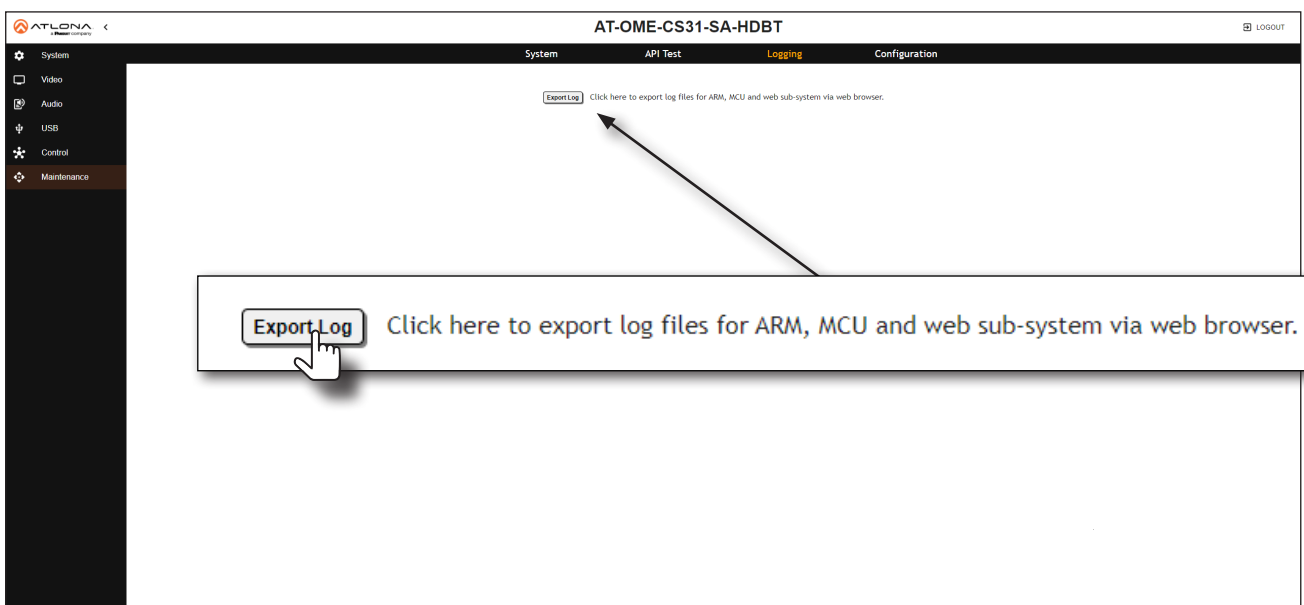

Exporting the System Configuration

The AT-OME-CS31-SA-HDBT system configuration can be exported, if desired. This provides the ability to restore (import) the system configuration, in the event of an accidental factory reset or other issue. Network settings are not exported. This configuration file can also be imported by other AT-OME-CS31-SA-HDBT units.

1. Log in to the web server.
2. Click **Maintenance** > **Configuration** in the menu bar.
3. Click the **Export** button.
4. The configuration file will be exported in JSON format, in the format: `ATOMECS31SA_DDMMYY_HHMMSS.json`.

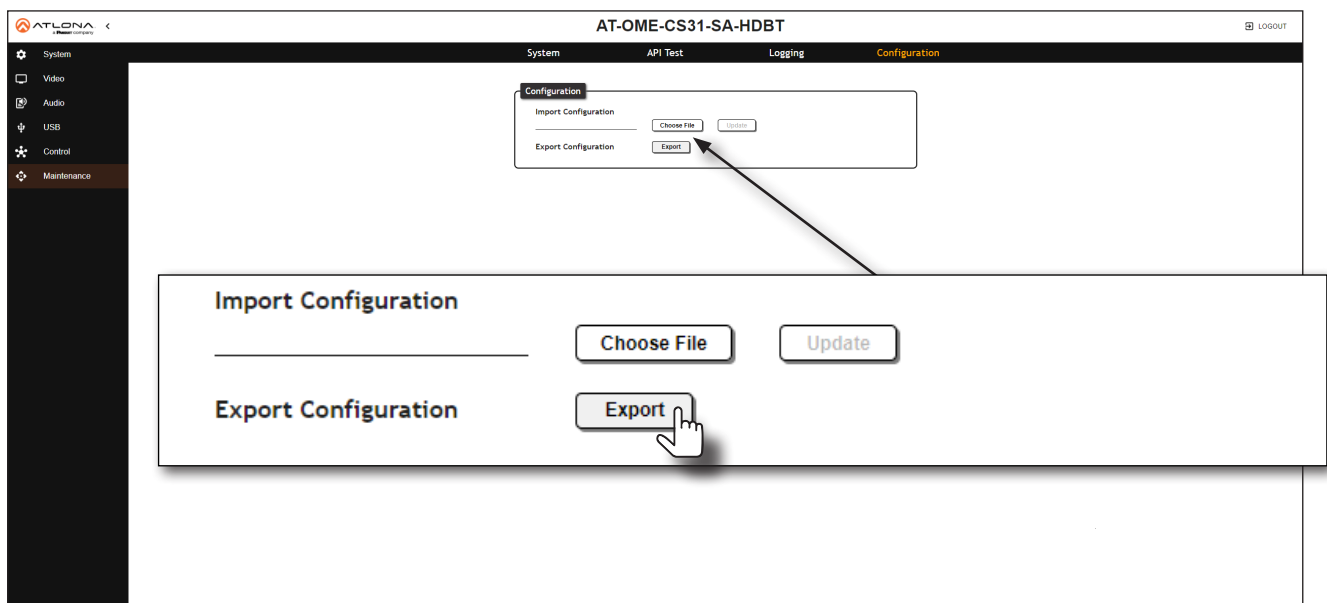

Importing a System Configuration File

1. Log in to the web server.
2. Click **Maintenance** > **Configuration** in the menu bar.
3. Click the **Choose File** button and select the desired configuration file.
4. Click the **Update** button.

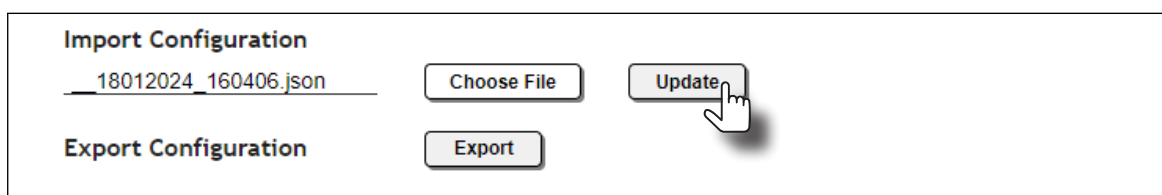

Configuration and Management Interfaces

Web Server

The AT-OME-CS31-SA-HDBT includes a built-in web server. Atlona recommends that the web server be used to set up the AT-OME-CS31-SA-HDBT, as it provides intuitive management of all features. Refer to [Logging in after Registration \(page 18\)](#) for more information.

The AT-OME-CS31-SA-HDBT is shipped with DHCP enabled. Once connected to a network, the DHCP server will automatically assign an IP address to the unit. Use an IP scanner to determine the IP address of the AT-OME-CS31-SA-HDBT. If a DHCP server cannot be located within 15 seconds, the AT-OME-CS31-SA-HDBT will be placed in [Automatic Private IP Addressing \(APIPA\) Mode \(page 15\)](#). If a static IP address is desired, refer to [IP Configuration \(page 15\)](#).

Login page

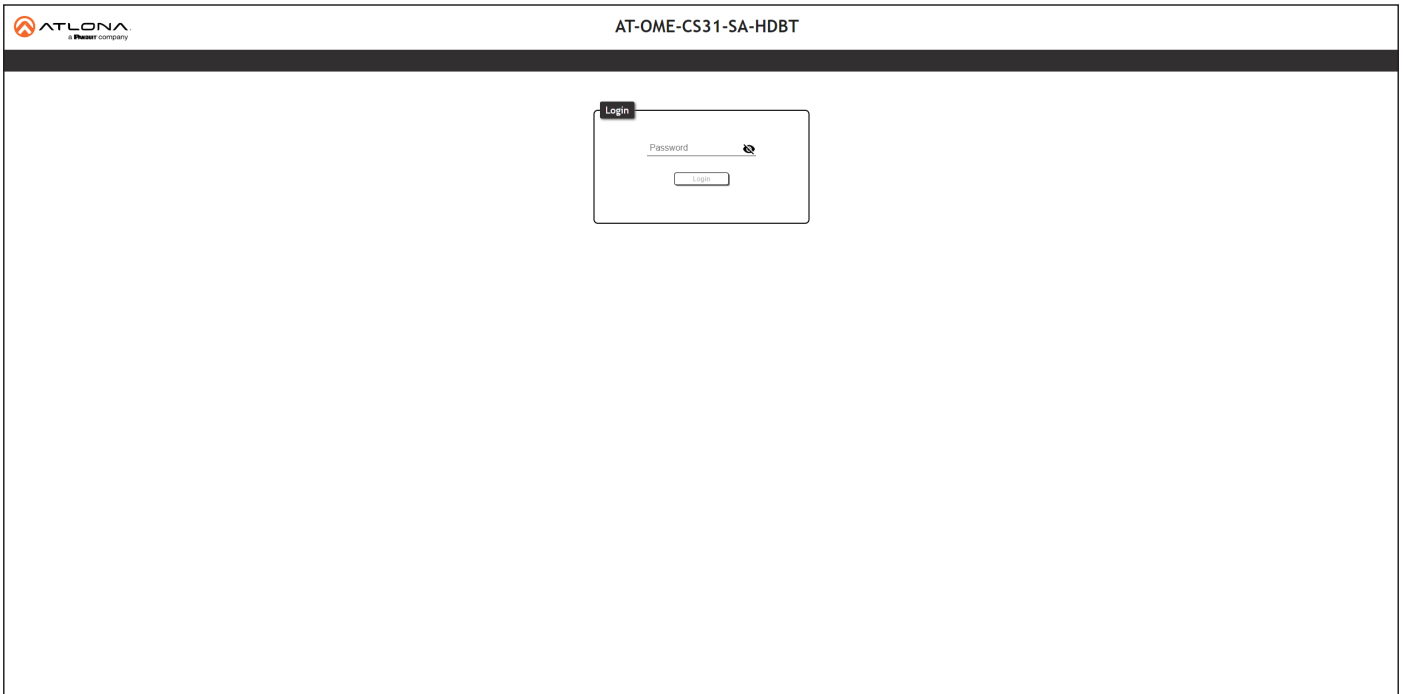

Password

Enter the password in this field.

Login

Click this button to log in.

Configuration and Management Interfaces

System > Info page

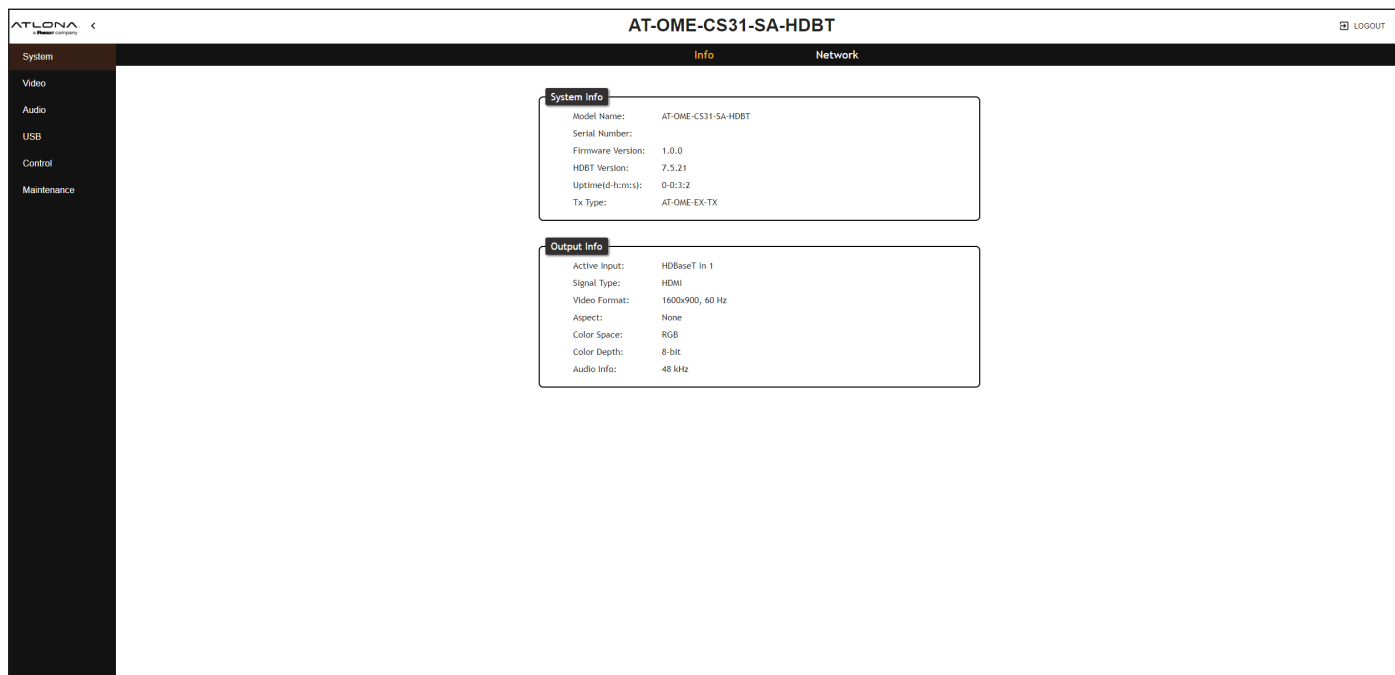

The screenshot shows the AT-OME-CS31-SA-HDBT configuration interface. The top navigation bar includes 'System', 'Info', and 'Network'. The 'System Info' section displays the following details:

Model Name:	AT-OME-CS31-SA-HDBT
Serial Number:	
Firmware Version:	1.0.0
HDBT Version:	7.5.21
Uptime(d-h:m:s):	0-0:3:2
Tx Type:	AT-OME-EX-TX

The 'Output Info' section displays the following details:

Active Input:	HDBaseT In 1
Signal Type:	HDMI
Video Format:	1600x900, 60 Hz
Aspect:	None
Color Space:	RGB
Color Depth:	8-bit
Audio Info:	48 kHz

System Info

Model Name

The model SKU of this product.

Serial Number

Displays the serial number of the unit.

Firmware Version

The version of firmware that the AT-OME-CS31-SA-HDBT is running. Always make sure to check the AT-OME-CS31-SA-HDBT product page, on the Atlona web site, for the latest version of firmware.

Valens Version

The version of Valens firmware for the HDBaseT chip.

Uptime (d-h:m:s)

Displays the amount of time elapsed since the unit was powered.

Tx Type

Displays the amount of time elapsed since the unit was powered.

Video Info

Displays signal information for the active input.

Active Input

The input signal port name.

Signal Type

The type of input signal.

Video Format

The input resolution of the source device.

Aspect

Aspect ratio of the input signal.

Color Space

Displays the color space and chroma sub-sampling of the input signal.

Color Depth

The color depth of the input signal.

Audio Info

The type of audio that is being received on the input.

Configuration and Management Interfaces

System > Network

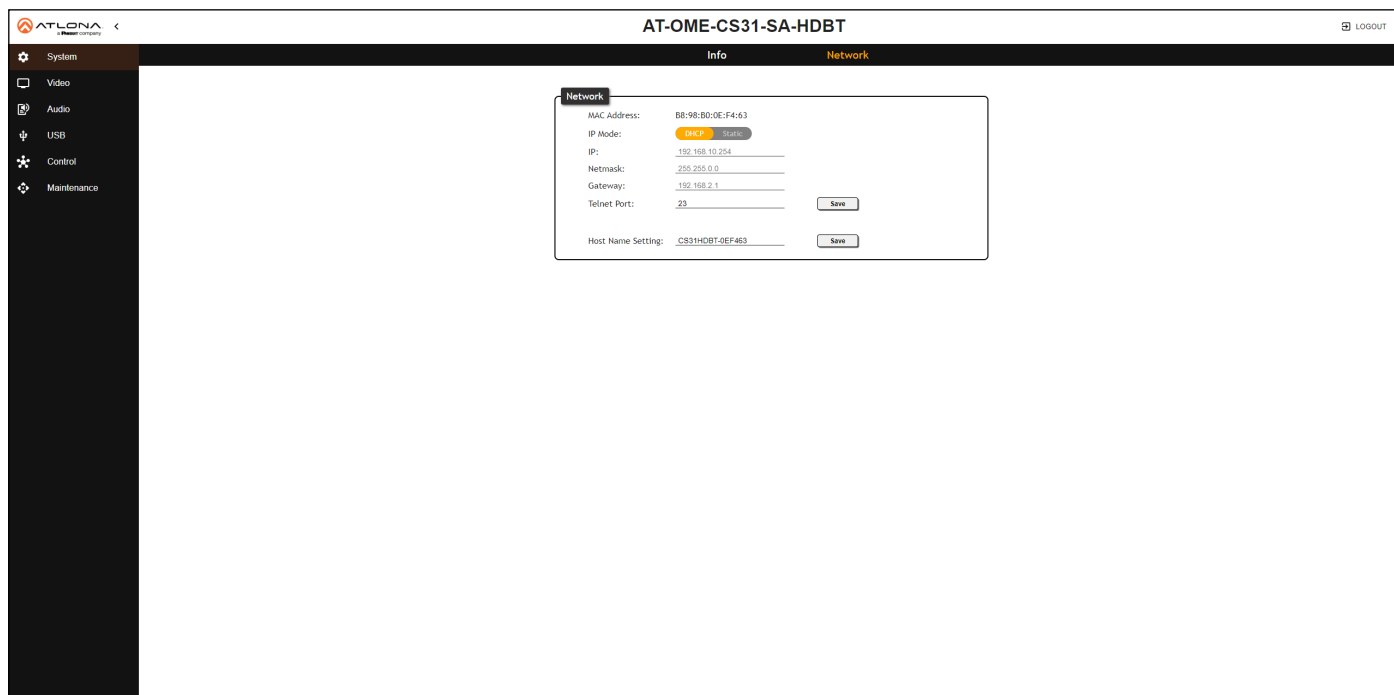

Network

MAC address

Displays the MAC address of the AT-OME-CS31-SA-HDBT.

IP Mode

Click this toggle to set the IP mode of the AT-OME-CS31-SA-HDBT.

Setting	Description
DHCP	Uses an available DHCP server to assign an IP address.
Static	Allows the IP address, subnet mask, and gateway IP address to be entered manually.

IP

Enter the IP address of the AT-OME-CS31-SA-HDBT in this field. This field will only be available if **IP Mode** is set to **STATIC IP**.

Netmask

Enter the subnet mask in this field. This field will only be available if **IP Mode** is set to **Static**.

Gateway

Enter the gateway (router) address in this field. This field will only be available if **IP Mode** is set to **Static**.

Telnet Port

Enter the Telnet listening port in this field.

Host Name Setting

Displays the hostname of the AT-OME-CS31-SA-HDBT, as it would appear on a network. To change the hostname, type the new hostname in this field and click the **Save** button. Refer to [Setting the Host Name \(page 22\)](#) for more information.

Configuration and Management Interfaces

Video > A/V Routing

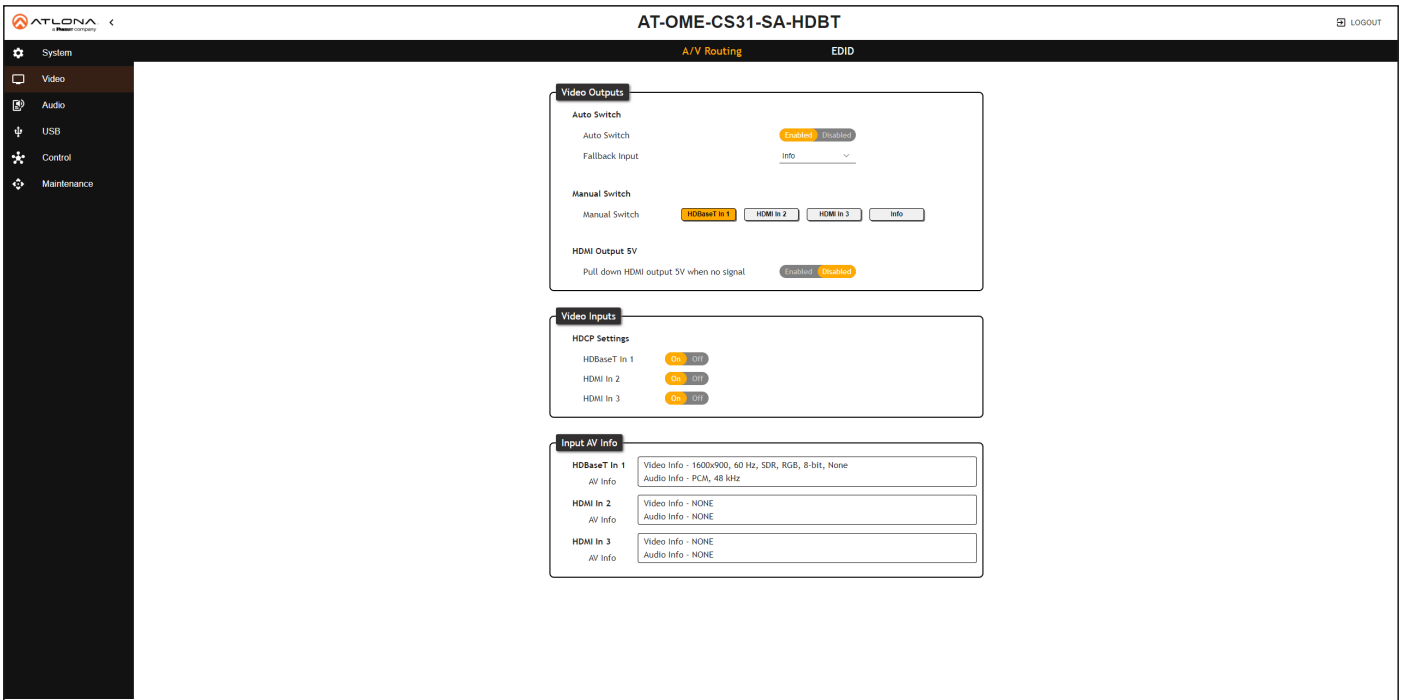

Video Outputs

Auto Switch

Click this toggle switch to enable or disable Auto Switching. When set to `Enabled`, the AT-OME-CS31-SA-HDBT will automatically switch to the another input, if the signal is disrupted on the currently active input.

Fallback Input

Click this drop-down list to select the fallback input. The AT-OME-CS31-SA-HDBT will automatically switch to the specified input, once the signal is disrupted on the currently active input.

Manual Switch

Click the these button to select the active input. Clicking the **Info** button will display the **Info** screen, on the connected display. Refer to [Input Switching \(page 25\)](#) for more information.

HDMI Output 5V

This option sets the +5V pin on the **HDMI OUT** port to the desired setting. This feature allows a display to go to sleep when there is no signal present. It's also used for VTC codecs that need to see a change in HDMI +5V in order to change modes. If faster switching times are desired, then this should be set to `Enabled`. The default setting is `Disabled`.

Setting	Description
Enabled	Forces the +5V pin on the HDMI output to “high” (always on).
Disabled	Allows the +5V pin on the HDMI output to toggle, based on the presence of an input video signal.

Configuration and Management Interfaces

Video Inputs

HDCP Settings

Each input provides control of how HDCP content is handled. Some source devices will send HDCP content if an HDCP-compliant display (sink) is detected. However, there may be applications where sending HDCP content is not desired. Setting the port to the `Off` position, will instruct the source to send non-HDCP content to the display. Note that not all sources have this capability. When set to `ON`, the source will have the ability to transmit HDCP content to the AT-OME-CS31-SA-HDBT.



NOTE: Setting this feature to `Off`, for any source, does *not* provide decryption of HDCP content to non-HDCP compliant sink devices. Sources such as Mac[®] computers and the Sony PlayStation[®] will *always* transmit HDCP content.

Input AV Info

Display video and audio format information for each input.

Configuration and Management Interfaces

Video > EDID

Refer to [EDID Management \(page 28\)](#) for more information.

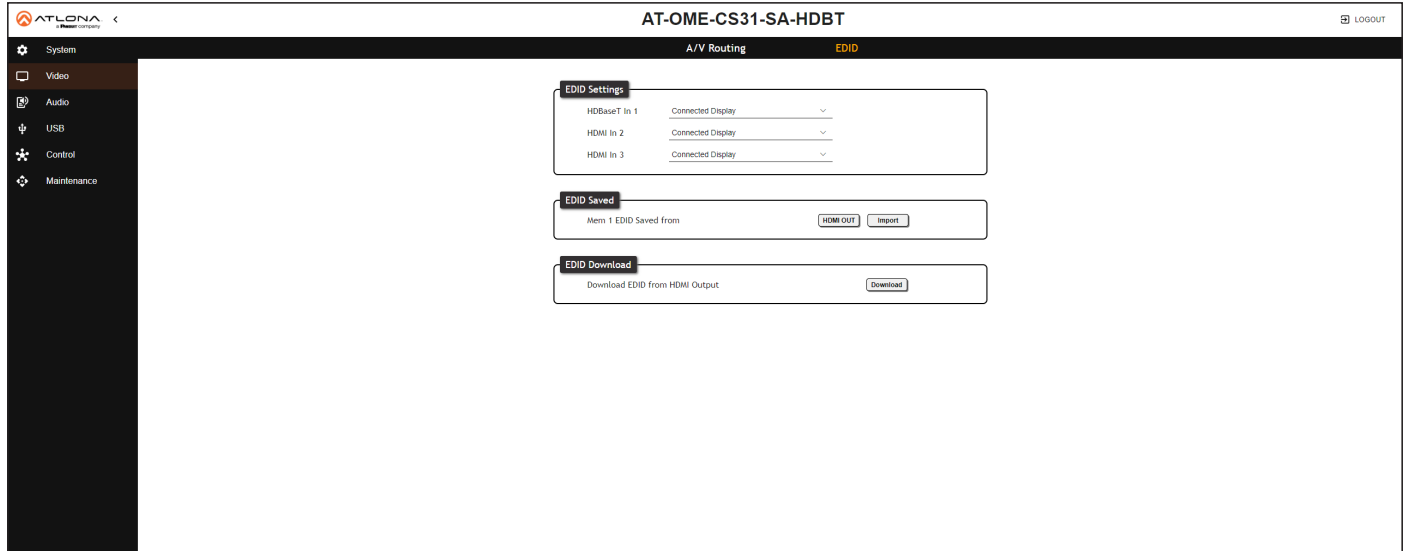

EDID Settings

Click these drop-down lists to select the desired EDID to be used for each input. The following EDID presets are available. When selecting an EDID, make sure that the display/sink device is capable of supporting the resolution/timing. If the sink device is not able to support a feature, then the source will not be displayed. Selecting the *Connected Display* EDID will provide the most compatible settings for most displays. In addition, a blank memory location is available for storing captured EDID data. If an EDID is stored in the memory location, it will also be added to the list of available EDID selections.

EDID	Description
Connected Display	Uses the downstream EDID of the connected display
ATL 3840x2160@60 2CH HDR PCM*	3840 x 2160 @ 60 Hz w/ 2-channel audio / HDR / Linear PCM
ATL 3840x2160@30 2CH SDR PCM	3840 x 2160 @ 30 Hz w/ 2-channel audio / SDR / Linear PCM
ATL 1920x1080P@60 2CH SDR PCM	1920 x 1080p @ 60 Hz w/ 2-channel audio / SDR / Linear PCM
ATL 1920x1080P@30 2CH SDR PCM	1920 x 1080p @ 30 Hz w/ 2-channel audio / SDR / Linear PCM
ATL 1280x720P@60 2CH SDR PCM	1280 x 720p @ 60 Hz w/ 2-channel audio / SDR / Linear PCM
ATL 1280x800 2CH SDR PCM	1280 x 800 w/ 2-channel audio / SDR / Linear PCM
ATL 1920x1200 2CH SDR PCM	1920 x 1200 w/ 2-channel audio / SDR / Linear PCM
Mem 1	Blank memory location available for EDID storage

* This EDID is only available on HDMI inputs.

EDID Saved

HDMI OUT

Click this button to capture the EDID on the HDMI OUT port.

Import

Click this button to load an EDID to the AT-OME-CS31-SA-HDBT.

EDID Download

Download

Click this button to download the EDID from the connected display (HDMI OUT) to a .bin file.

Configuration and Management Interfaces

Audio > Local Audio



Local Audio

Balanced Input 1

Adjusts the input gain on the **AUDIO IN** port. Click the **Muted/Unmuted** toggle switch to mute or unmute the audio signal.

Unbalanced Input 2

Adjusts the input gain on the **L/R** (left) port. Click the **Muted/Unmuted** toggle switch to mute or unmute the audio signal.

Unbalanced Input 3

Adjusts the input gain on the **L/R** (right) port. Click the **Muted/Unmuted** toggle switch to mute or unmute the audio signal.

HDMI Out 4

Adjusts the de-embedded HDMI audio output level. Click the **Muted/Unmuted** toggle switch to mute or unmute the audio signal.

USB Host Input 5

Adjusts the host PC audio level, when the AT-OME-CS31-SA-HDBT is selected as Audio DAC. Click the **Muted/Unmuted** toggle switch to mute or unmute the audio signal.

Ducking

Click this toggle switch to enable or disable local audio ducking. When set to **On**, this will enable audio ducking, and allows the **Attack Time**, **Release Time**, **Program Decrease**, and **Ducking Trigger** settings to be adjusted.

Priority Selection

As of this writing, **Balanced Input** is the only option.

Configuration and Management Interfaces

Attack Time

Click and drag this slider to set the amount of time, in milliseconds, before audio ducking will be triggered. With a shorter attack time, the ducking will activate quickly. With a longer attack time, it will take longer for the audio ducking to be applied. The value can also be entered directly into the **Attack Time** field. Range: 1 - 1000.

Release Time

Click and drag this slider to set the amount of time, in milliseconds, for the sound to return to its normal volume, after the voice audio stops. 100 milliseconds is usually a good starting point for this value. If this value is too low, then the primary audio source (music), will bounce back when you take a breath, while speaking. It's good practice to start with a higher release value, then adjust it for best results. Range: 1 - 3000.

Program Decrease

This is amount the volume will be decreased when the **Ducking** toggle switch is set to **On**.

Ducking Trigger

Click and drag this slider to define the trigger threshold. The trigger is defined in decibels and attenuates the signal above this threshold.

Balanced Output Volume

Adjusts the line level output volume. Click the **Muted/Unmuted** toggle switch to mute or unmute the audio signal. Click the  button to adjust both the **Balanced Output Volume** and **Amplifier Output Volume** slider, in tandem.

Amplifier Output Volume

Adjusts the internal amplifier output volume. Click the **Muted/Unmuted** toggle switch to mute or unmute the audio signal. Click the  button to adjust both the **Balanced Output Volume** and **Amplifier Output Volume** slider, in tandem.

Amplifier Mode

Stereo/Mono Selection

Click this toggle to switch between stereo or mono output.

Configuration and Management Interfaces

Audio > USB Audio

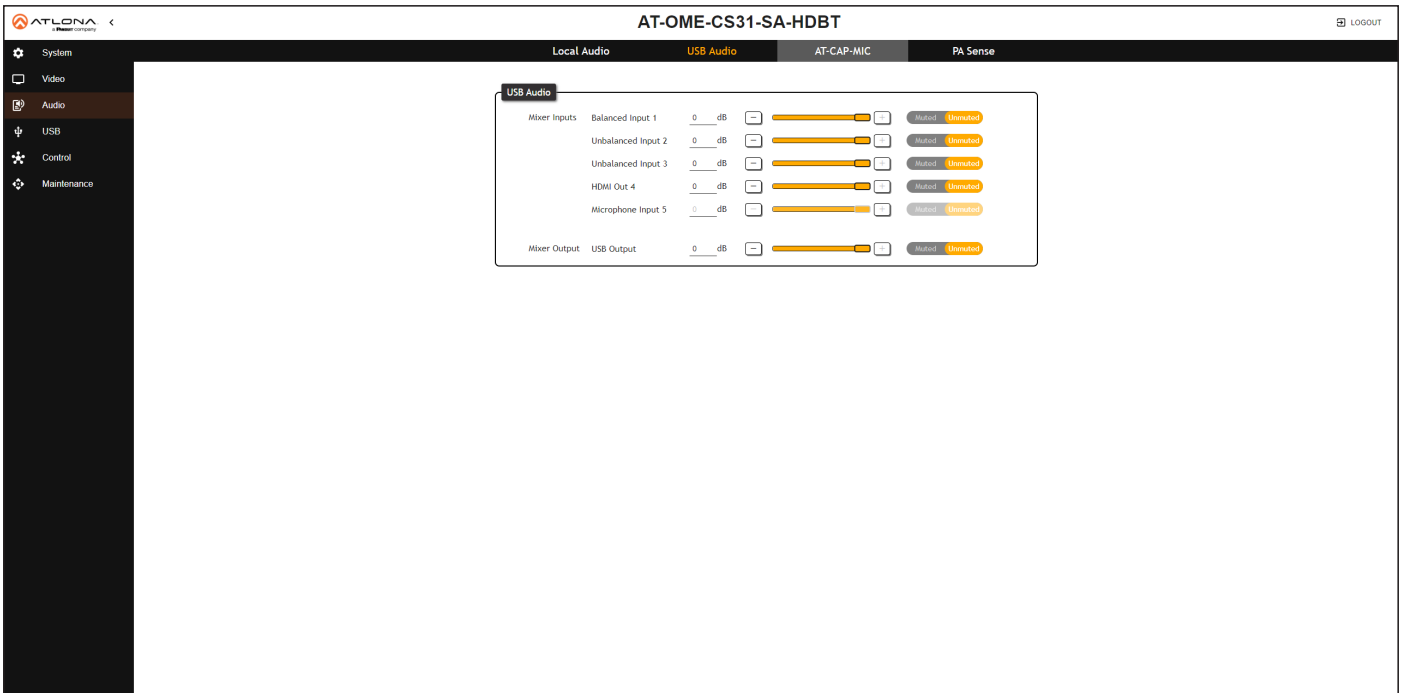

USB Audio

Balanced Input 1

Adjusts the input gain on the **VOICE** port. Click the **Muted/Unmuted** toggle switch to mute or unmute the audio signal.

Unbalanced Input 2

Adjusts the input gain on the **L/R** (left) port. Click the **Muted/Unmuted** toggle switch to mute or unmute the audio signal.

Unbalanced Input 3

Adjusts the input gain on the **L/R** (right) port. Click the **Muted/Unmuted** toggle switch to mute or unmute the audio signal.

HDMI Out 4

Adjusts the de-embedded HDMI audio output level. Click the **Muted/Unmuted** toggle switch to mute or unmute the audio signal.

Microphone Input 5

This slider is reserved for future use.

USB Output

Adjusts the overall volume output for the USB device. Click the **Muted/Unmuted** toggle switch to mute or unmute the audio signal.

Configuration and Management Interfaces

Audio > PA Sense

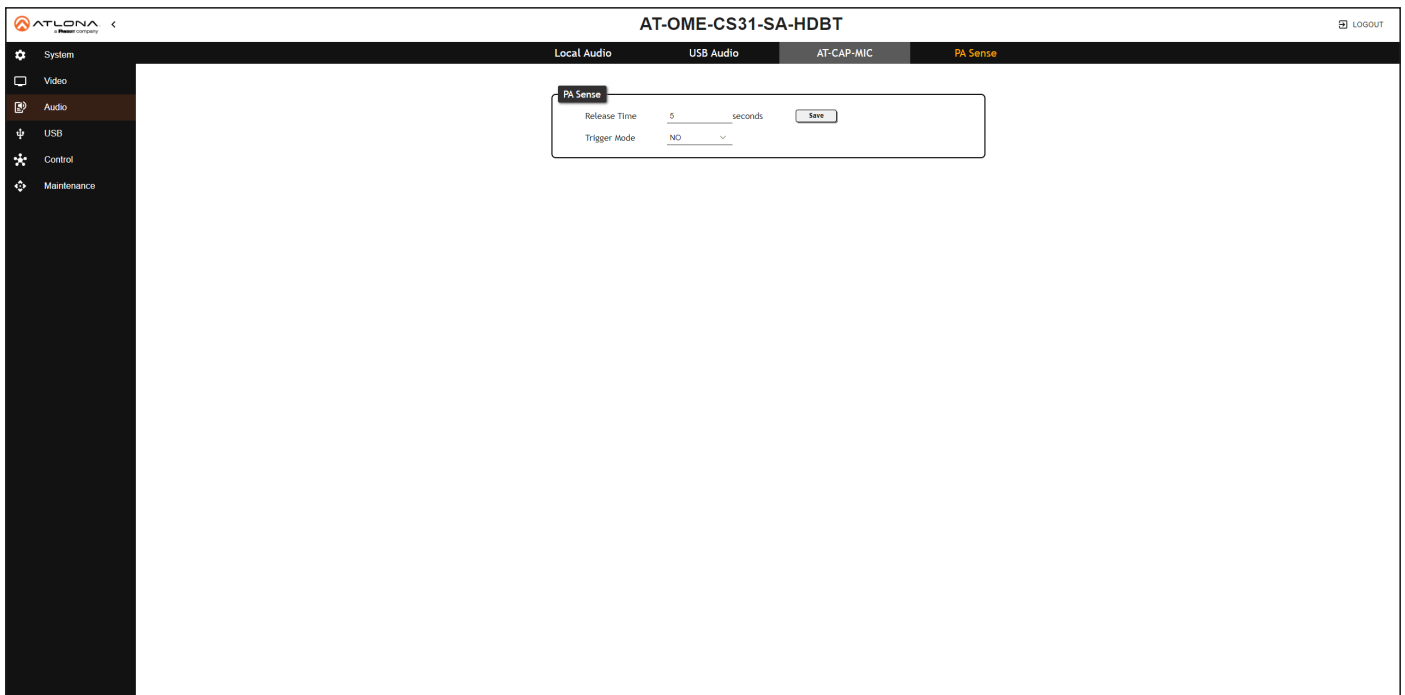

PA Sense

Release Time

Sets the release time for the PA sensitivity.

Trigger Mode

Click this drop-down list to select the trigger mode. Available options are NO (Normally Open) and NC (Normally Closed).

Save

Click this button to commit changes.

Configuration and Management Interfaces

USB > USB Routing

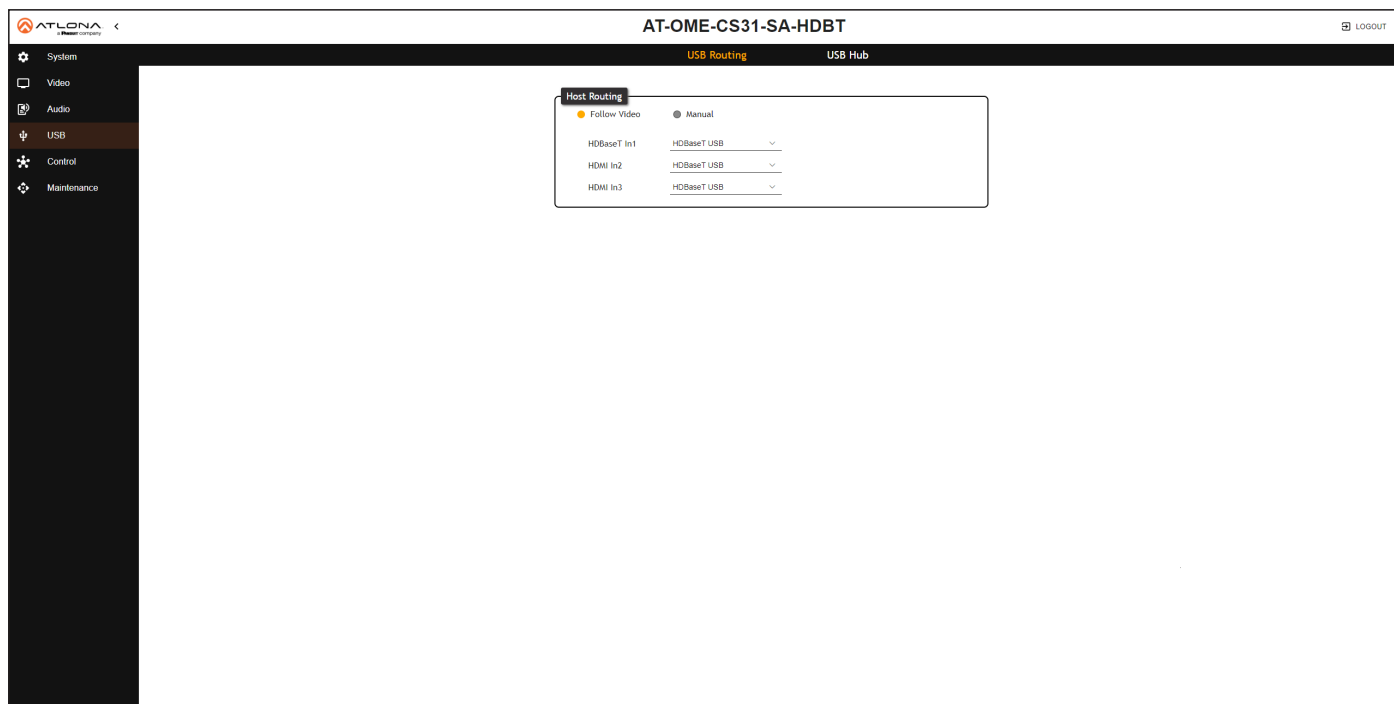

Host Routing

Selects the desired USB switching mode. Refer to [USB Routing and Management \(page 37\)](#) for more information.

Setting	Description
Follow Video	This is the default mode. The drop-down lists for each input are locked and cannot be changed. Since there is only one HOST port, the host device will have access to the same USB devices, when switching between video inputs. Note that HDBaseT In 1 is assigned to HDBaseT USB, not to Local USB-B Host (HOST port on the AT-OME-CS31-SA-HDBT). This means that the HDBaseT source will use the USB host port on the transmitter.
Manual	This mode provides manual selection of the USB host port to be used. When this mode is selected, select either HDBaseT USB or Local USB-B Host from the drop-down list.

Configuration and Management Interfaces

USB > USB Hub

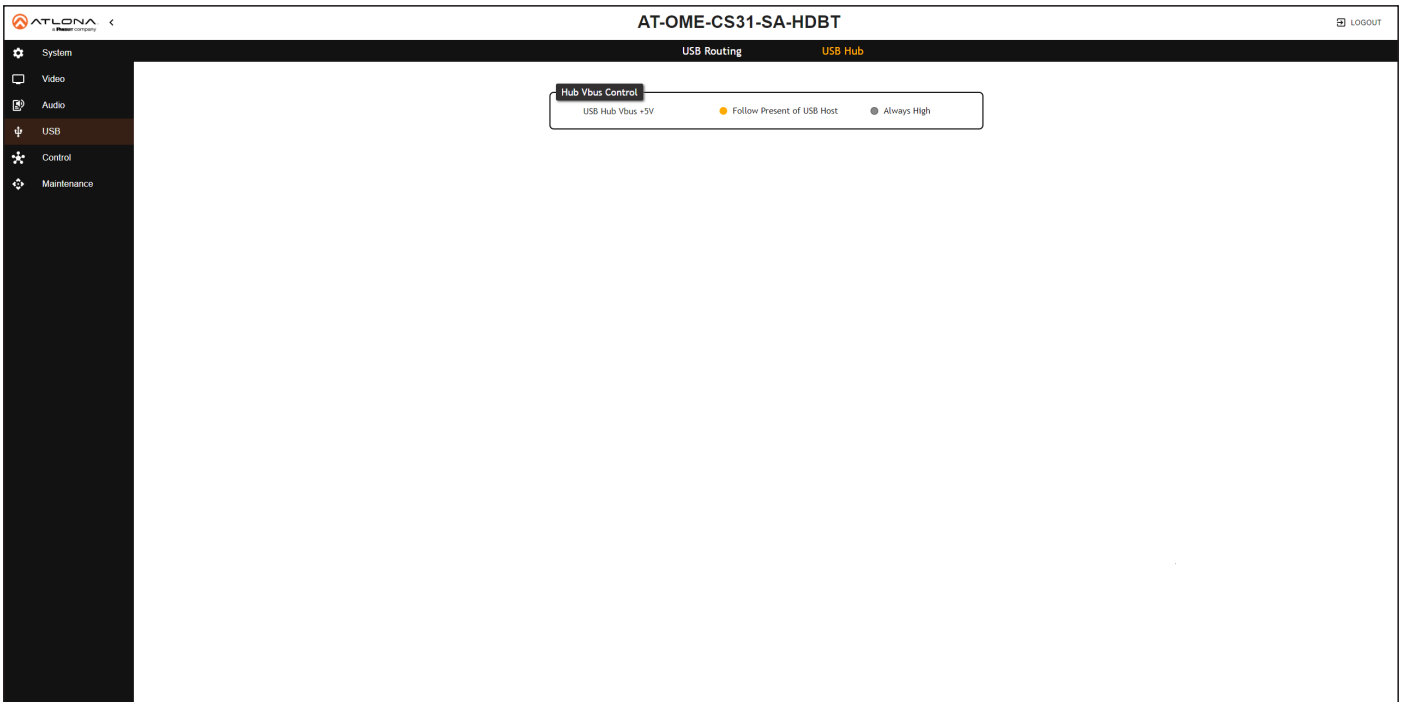

Hub Vbus Control

USB VBus

Click the desired radio button to adjust the behavior of the power function of the USB hub ports. Refer to [Hub Vbus Control](#) (page 39) for more information.

Setting	Description
Follow the presence of USB Host	Allows the USB hub ports to toggle on and off based on the presence of a USB host.
Always High	Keeps the USB power on the hub ports always on. For example, connecting the AT-CAP-SP100 to the AT-OME-CS31-SA-HDBT, when no host is connected, would allow the speakerphone to charge, continuously.

Configuration and Management Interfaces

Control > LAN

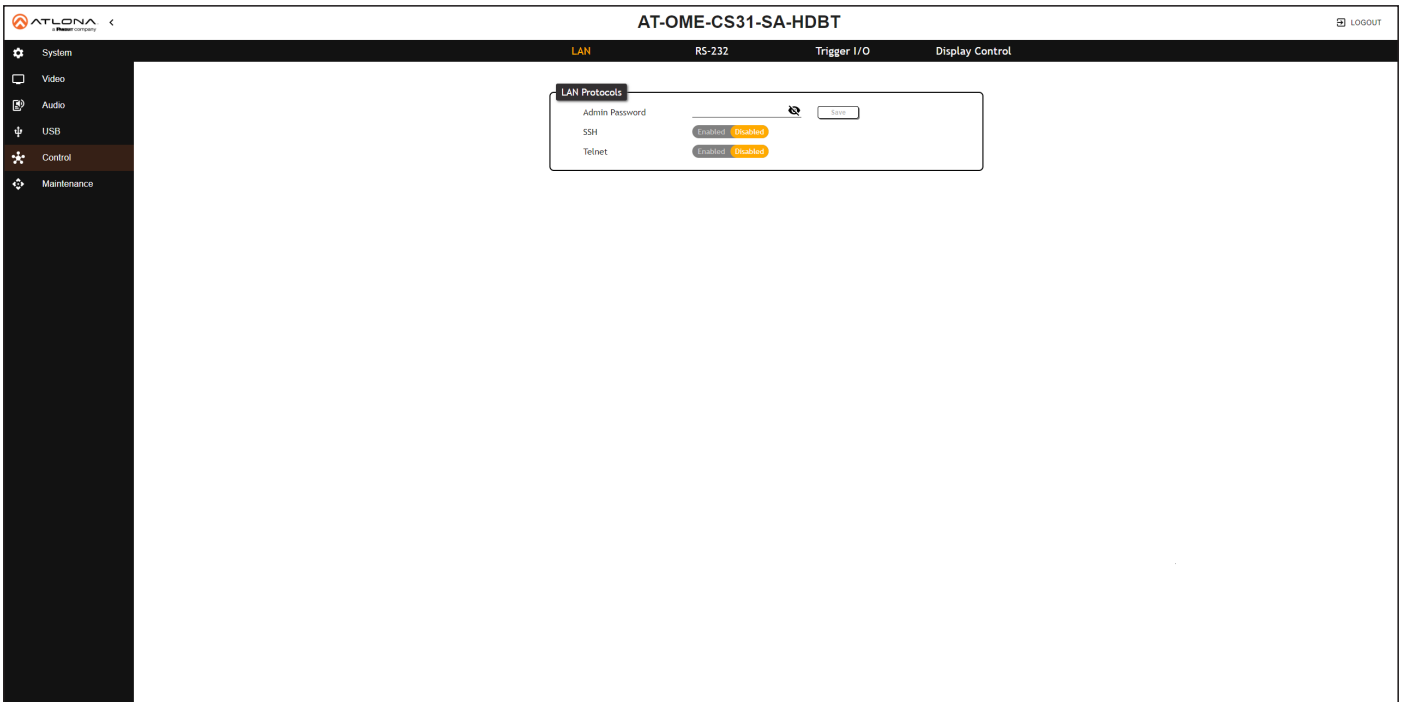

LAN Protocols

Refer to [LAN Management \(page 40\)](#) for more information.

Admin Password

Enter a new administrator password in this field. All passwords are masked. Click the **Save** button to commit changes.

SSH

Click this toggle switch to enable or disable SSH (Secure Shell protocol).

Telnet

Click this toggle switch to enable or disable Telnet connections to the AT-OME-CS31-SA-HDBT.

Configuration and Management Interfaces

Control > RS-232

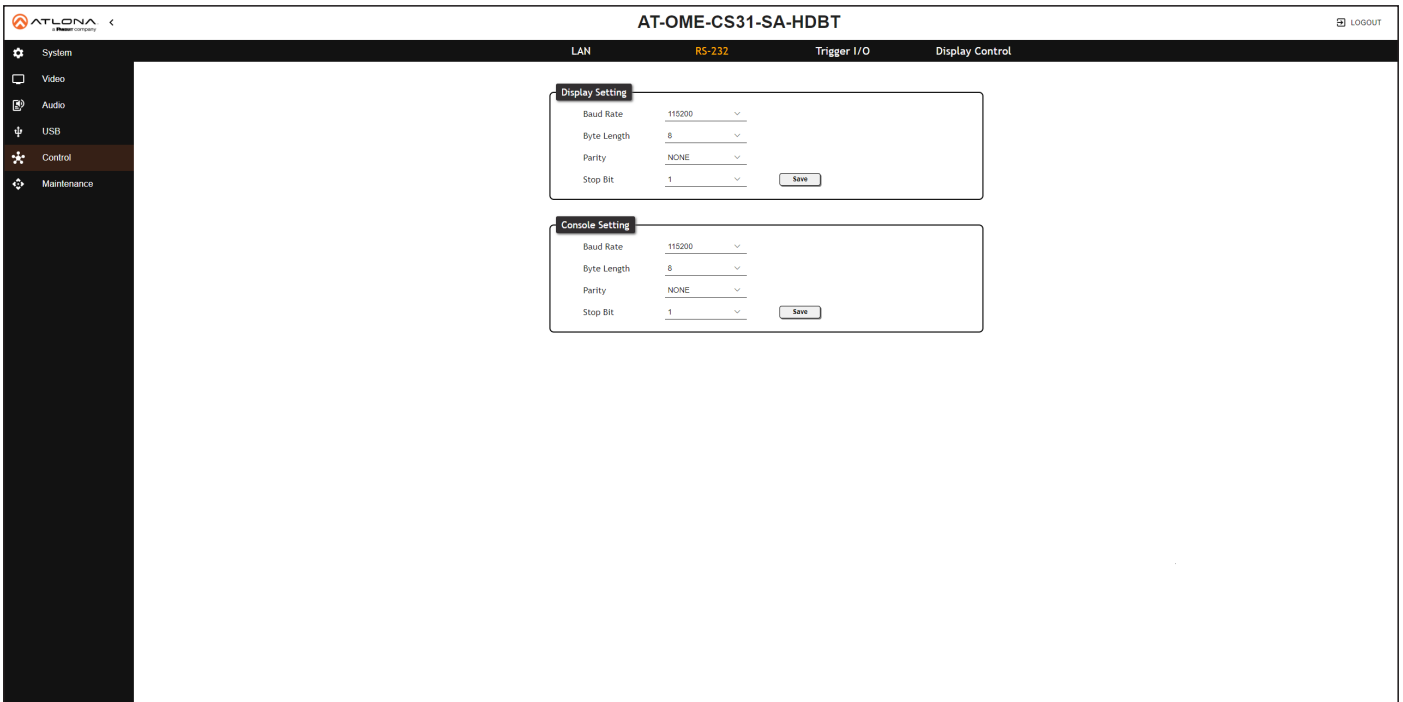

The screenshot shows the configuration interface for the AT-OME-CS31-SA-HDBT device. The top navigation bar includes 'LAN', 'RS-232', 'Trigger I/O', and 'Display Control'. The left sidebar contains 'System', 'Video', 'Audio', 'USB', 'Control', and 'Maintenance'. The main content area is divided into two sections: 'Display Setting' and 'Console Setting'. Each section contains four dropdown menus: 'Baud Rate' (set to 115200), 'Byte Length' (set to 8), 'Parity' (set to NONE), and 'Stop Bit' (set to 1). A 'Save' button is located at the bottom right of each section.

Display Setting

RS-232 settings for local or HDBaseT RS-232 control. Refer to [Display Control \(page 46\)](#) for more information.

Display Setting

Sets the RS-232 port settings when controlling a display, over HDBaseT, using a control system.

Console Setting

Sets the RS-232 port settings used for local control by a third-party control system.

Save

Click this button to commit all changes.

Setting	Description
Baud rate	Sets the baud rate. The following options are available: 2400, 9600, 19200, 38400, 56000, 57600, 115200.
Data bit	Sets the number of data bits used to represent each character of data. The following options are available: 7 or 8.
Parity	Sets the parity bit, which can be included with each character to detect errors during the transmission of data. The following options are available: None, Odd, or Even.
Stop bit	Sets the stop bit. Stop bits are sent at the end of each character, allowing the client to detect the end of a character stream. The following options are available: 1 or 2.

Configuration and Management Interfaces

Control > Trigger I/O

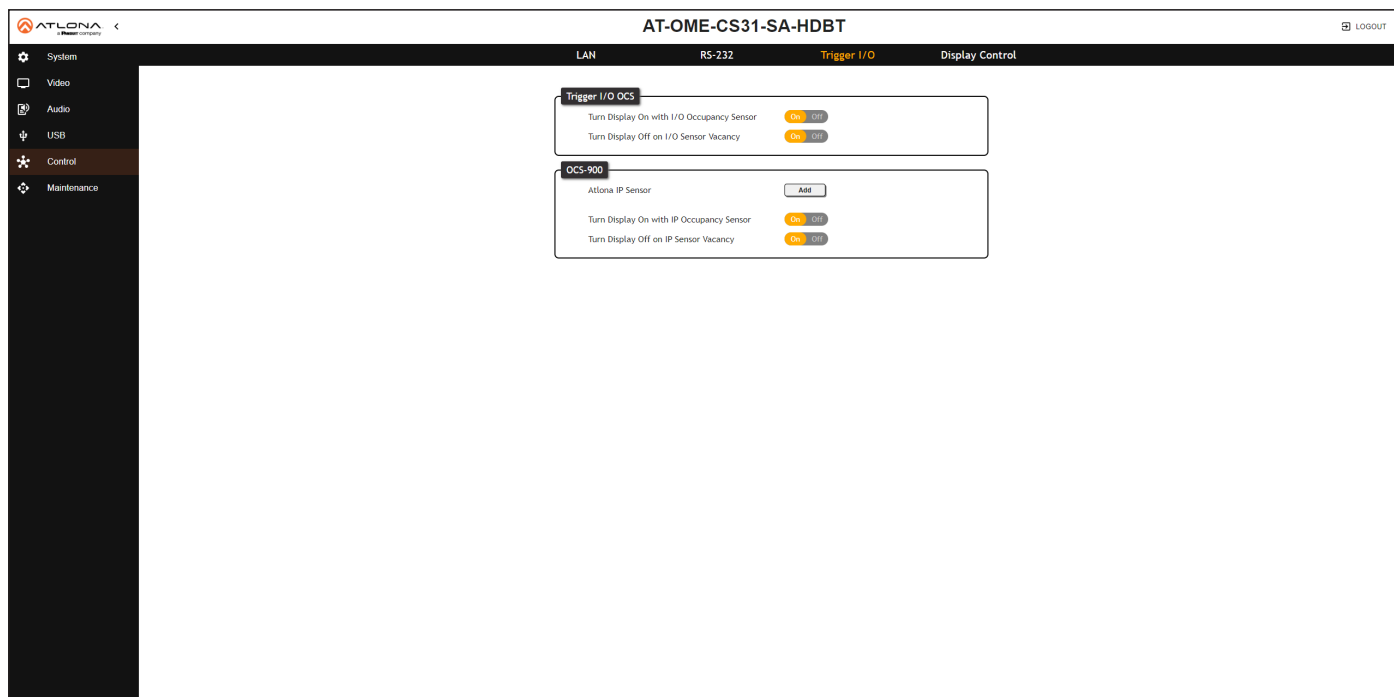

Trigger I/O OCS

Trigger settings for generic occupancy sensors. Refer to [Using Generic Occupancy Sensors \(page 43\)](#) for more information.

Turn Display On with I/O Occupancy Sensor

Click this toggle switch to the On or Off position. When On, the display will stay powered when the room is occupied.

Turn Display Off on I/O Sensor Vacancy

Click this toggle switch to the On or Off position. When On, the toggle will power-off the display when the room is no longer occupied.

OCS-900

Trigger settings for the AT-OCS-900N occupancy sensor. Refer to [Using the AT-OCS-900N \(page 44\)](#) for more information.

Turn Display On with IP Occupancy Sensor

Click this toggle switch to the On or Off position. When On, the display will stay powered when the room is occupied.

Turn Display Off on IP Sensor Vacancy

Click this toggle switch to the On or Off position. When On, the toggle will power-off the display when the room is no longer occupied.

Configuration and Management Interfaces

Control > Display Control

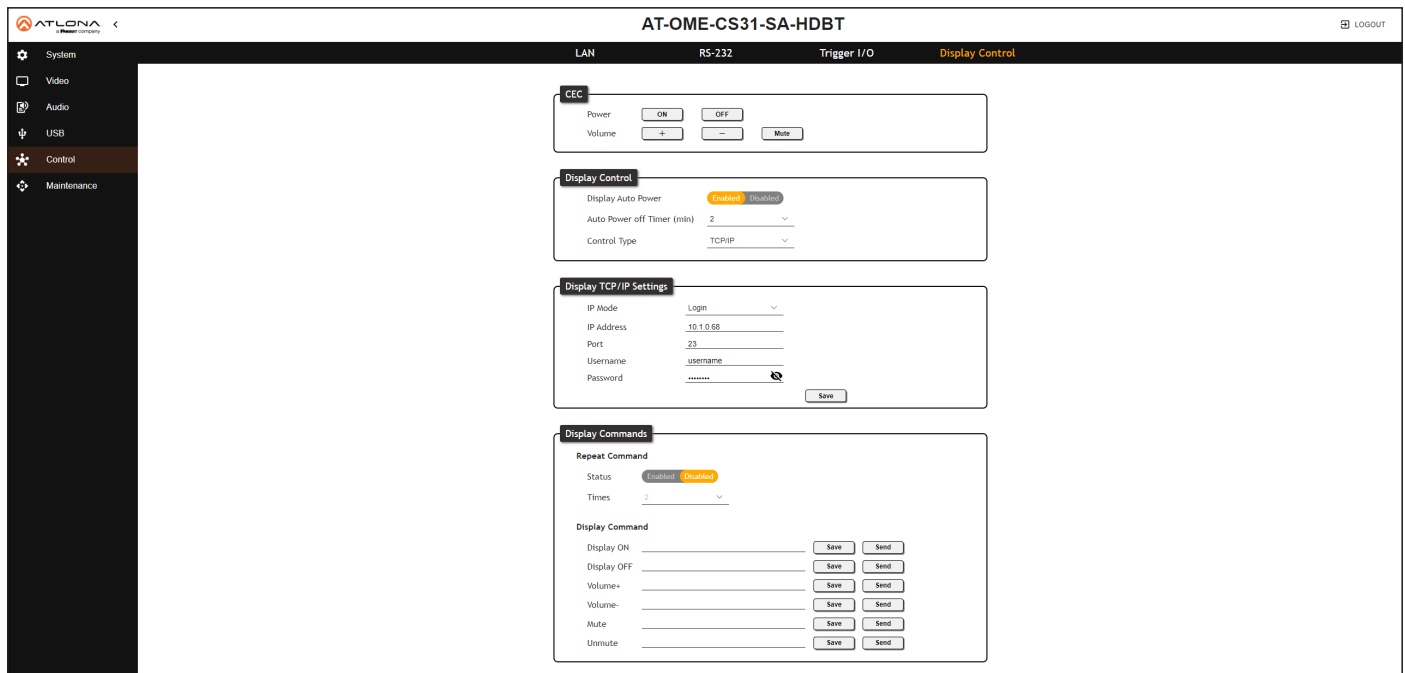

The screenshot shows the configuration interface for the AT-OME-CS31-SA-HDBT device. The interface is divided into several sections:

- CEC:** Contains 'Power' buttons for ON and OFF, and 'Volume' buttons for +, -, and Mute.
- Display Control:** Includes a 'Display Auto Power' toggle (set to Enabled), an 'Auto Power off Timer (min)' dropdown (set to 2), and a 'Control Type' dropdown (set to TCP/IP).
- Display TCP/IP Settings:** Includes fields for IP Mode (Login), IP Address (19.1.0.88), Port (23), Username (username), and Password (masked with dots), with a 'Save' button.
- Display Commands:** Includes a 'Repeat Command' section with a 'Status' toggle (set to Enabled) and a 'Times' dropdown (set to 2). Below this are several 'Display Command' entries (Display ON, Display OFF, Volume+, Volume-, Mute, Unmute), each with a 'Save' and 'Send' button.

CEC

Refer to [Display Control \(page 46\)](#) for more information.

Power

Click the **ON** button to send the power-on command to the display device. Click the **OFF** button to toggle the power state to off.

Volume

Click the **+** and **-** buttons to adjust the volume. Click the **Mute** button to test the volume muting function.

Consumer Electronics Control (CEC): Atlona has confirmed proper CEC functionality with several current models of Samsung, Panasonic, and Sony displays. However, it is not guaranteed that CEC will work with all displays. Many manufacturers do not support the CEC "off" command, and older displays use proprietary commands. Atlona only supports displays that use the CEC command structure defined in HDMI 1.2a. It is recommended that dealers request an evaluation product from Atlona, before designing a system using the CEC protocol. If this is not possible, then other control methods will need to be considered, in order to control displays using Atlona products.

Display Control

Refer to [Display Control \(page 46\)](#) for more information.

Display Auto Power

Set this toggle to **Enabled** to allow the AT-OME-CS31-SA-HDBT to send the power-on command to the display when an A/V signal is detected. When the AV signal is no longer present, the AT-OME-CS31-SA-HDBT will send the power-off command to the display. If this feature is not desired, then set to **Disabled**. This feature is set to **Enabled** by default.

Auto Power off Timer (min)

Sets the time interval before the command to power-off the display is sent, when an A/V signal is no longer present. The default value is 2 minutes. Available values are 2 to 30 minutes.

Control Type

Sets the control protocol for the connected display. Click this drop-down to select the control type. Available settings are **RS-232**, **TCP/IP**, and **CEC**. By default, **CEC** is selected for control of the display. If **TCP/IP** or **RS-232** is selected, then additional fields will be displayed.

Configuration and Management Interfaces

Display TCP/IP Settings

This window group is only available if the **Control Type** drop-down list is set to `TCP/IP`. Refer to [Display Control \(page 46\)](#) for more information.

IP Mode

Click this drop-down list to select the login mode.

Setting	Description
Non-login	Does not require a username and password when using TCP/IP to control the display.
Login	Requires a username and password to control the display through TCP/IP.

IP Address

Enter the IP address of the device in this field.

Port

Enter the listening port of the device in this field.

Username

Enter the username for login. If the **IP Mode** is set to `Non-Login`, then this field will not be displayed.

Password

Enter the password for login. If the **IP Mode** is set to `Non-Login`, then this field will not be displayed.

Save

Click this button to save all changes in this window group.

Display Commands

This section is only available when the **Control Type** is set to either `RS-232` or `TCP/IP`. Refer to [Display Control \(page 46\)](#) for more information.

Repeat Command

Click this toggle switch to `Enabled` or `Disabled`. Enabling this feature will re-send the command. Specify the number of times that the command is transmitted by setting the **Times** value. This feature is set to `Disabled` by default.

Times

Click this drop-down list to specify the number of times the command is sent. This drop-down list will only be available if the Repeat Command toggle switch is set to `Enabled`. Available values are 2, 3, and 4. The default value is 2.

Display ON, Display OFF, Volume+, Volume-, Mute, Unmute

These fields will need to be populated with the correct strings (either hex or ASCII format) for each function, which control the display device. If hexadecimal values are used, then use the `/x` delimiter at the end of the command string.

Save

Click this button to commit changes to the command string.

Send

Click this button to send the command string.

Configuration and Management Interfaces

Maintenance > System

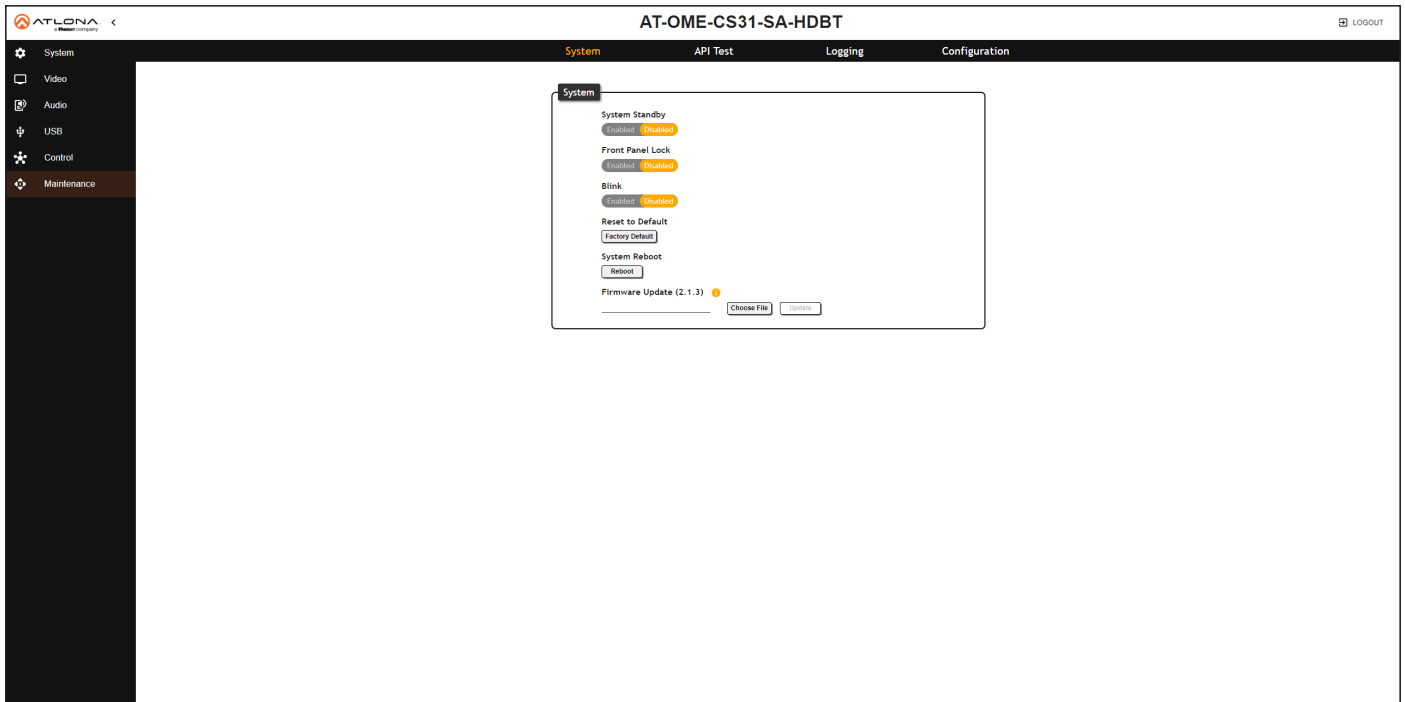

System

Refer to [System Settings \(page 52\)](#) for more information.

System Standby

Click this toggle switch to **Enabled** or **Disabled**. Enabling this feature will place the AT-OME-CS31-SA-HDBT in standby mode. This feature is set to **Disabled** by default.

Front Panel Lock

Click this toggle switch to **Enabled** or **Disabled**. When set to **Enabled**, the buttons on the front panel of the AT-OME-CS31-SA-HDBT will be locked. This feature is set to **Disabled** by default.

Blink

Click this toggle switch to **Enabled** or **Disabled**. When set to **Enabled**, the LED indicators on the front panel will blink. This is useful for identifying a unit, in a rack mount environment. This feature is set to **Disabled** by default.

Reset to Default

Click the **Factory Default** button to reset the AT-OME-CS31-SA-HDBT to factory-default settings.

System Reboot

Click the **Reboot** button to reset the AT-OME-CS31-SA-HDBT to factory-default settings.

Firmware Update

Click the **Choose File** button to begin the firmware update procedure. Refer to [Updating the Firmware \(page 84\)](#) for more information.

Configuration and Management Interfaces

Maintenance > API Test

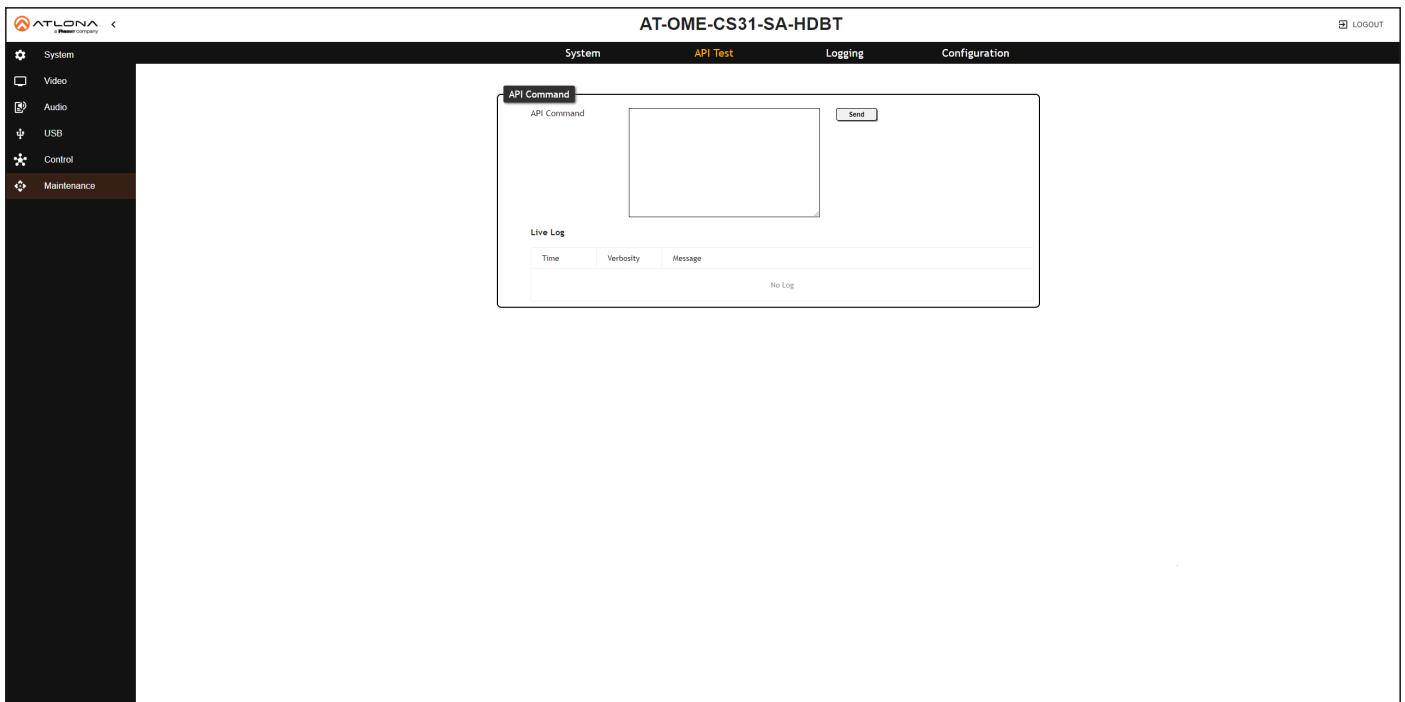

API Command

Send

Click this button to send the JSON command to the AT-OME-CS31-SA-HDBT. Feedback is displayed under the **Live Log** section. Refer to [API Testing \(page 60\)](#) for more information.

Configuration and Management Interfaces

Maintenance > Logging

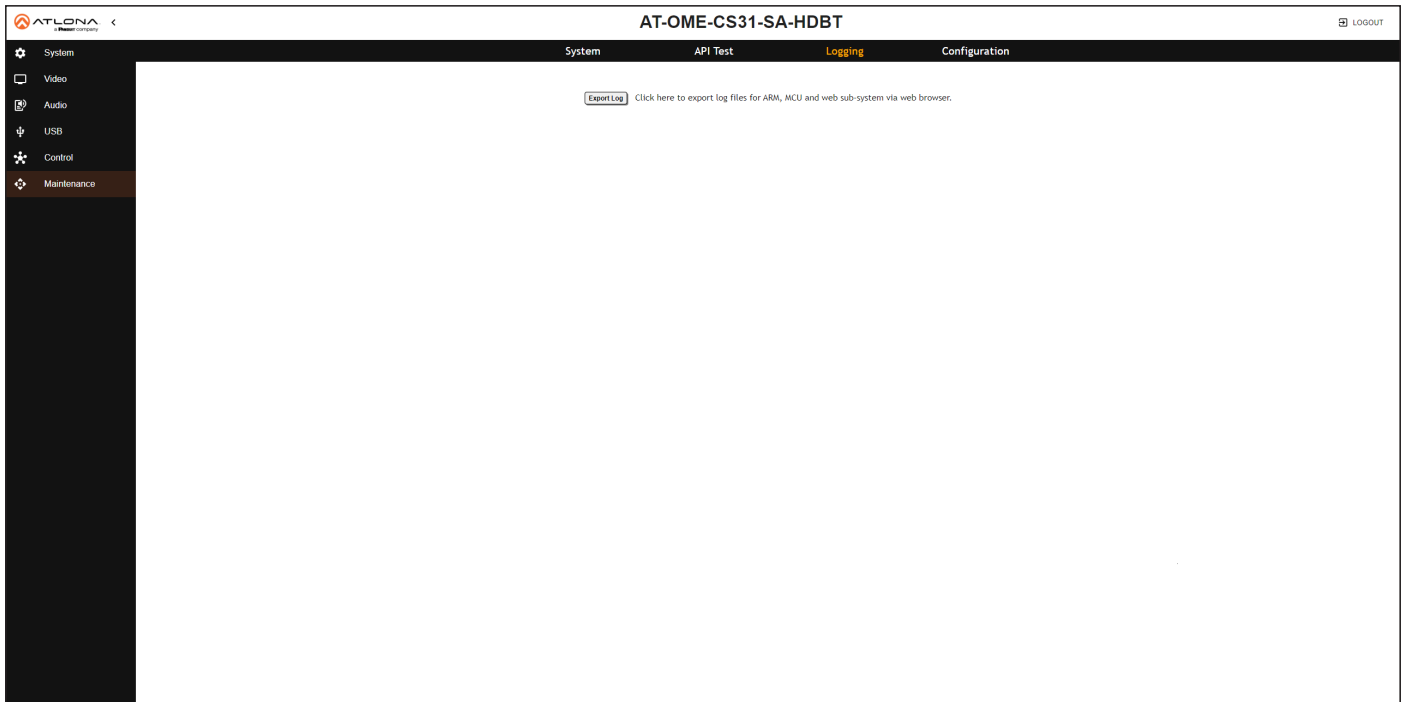

Export

Click this button to export the system log. A log of the ARM, MCU, and web sub-system can be exported for debugging and technical support purposes. Refer to [Exporting the System Log \(page 61\)](#) for more information.

Configuration and Management Interfaces

Maintenance > Configuration

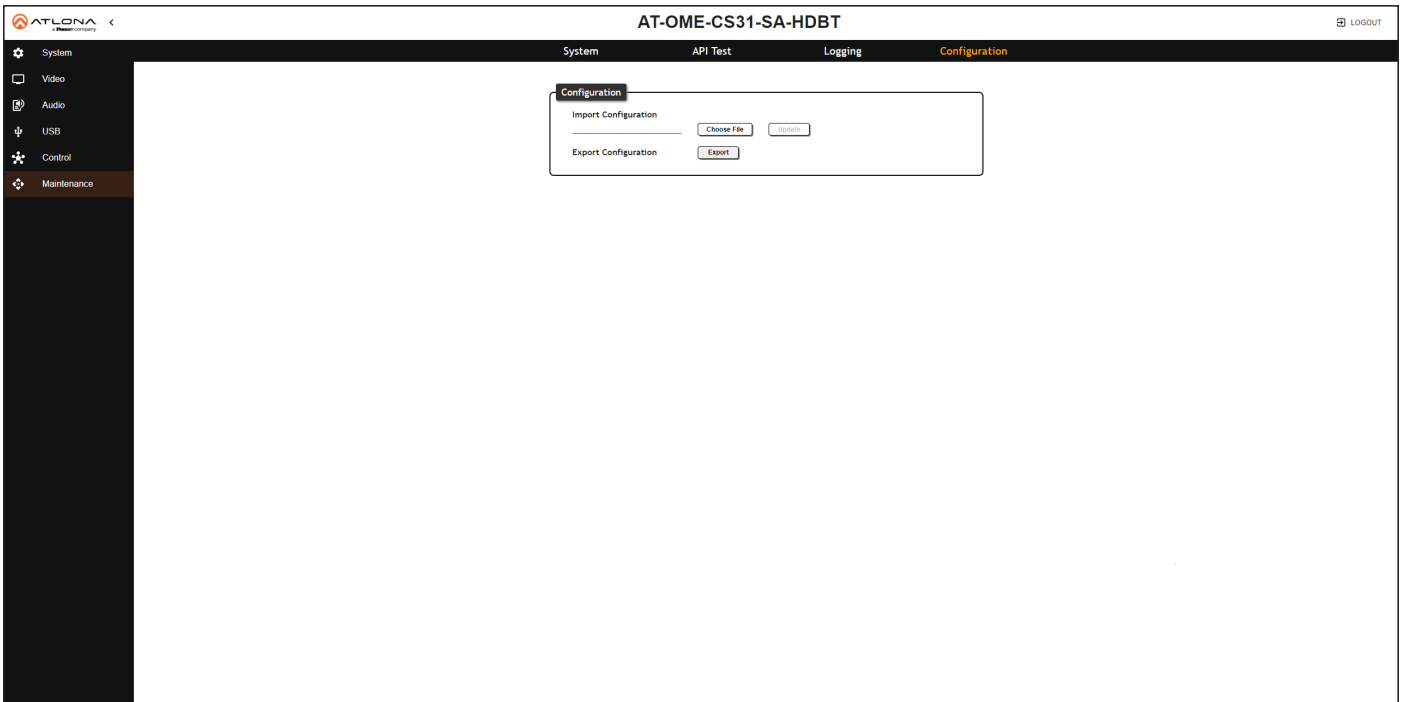

Configuration

The AT-OME-CS31-SA-HDBT system configuration can be exported, if desired. Refer to [Exporting the System Configuration \(page 62\)](#) for more information.

Choose File

Click this button to select the desired configuration file to be uploaded to the AT-OME-CS31-SA-HDBT.

Update

Click this button to upload the configuration file.

Export

Click this button to export the system configuration file. System configuration files are exported in JSON format.

Appendix

Updating the Firmware

Updating the firmware can be performed using the built-in web server or over USB.

Updating using the built-in Web Server

Requirements:

- AT-OME-CS31-SA-HDBT
 - Firmware file
 - Computer on the same network as the AT-OME-CS31-SA-HDBT
1. Download the firmware file from atlona.com and extract the contents of the .zip file to a folder on the computer desktop. The firmware file will be in .tar.gz format.
 2. Power on the unit and connect an Ethernet cable from the computer, containing the firmware, to the same network where the AT-OME-CS31-SA-HDBT is connected.
 3. Login to the web server.
 4. Click **System > Maintenance** in the menu bar.

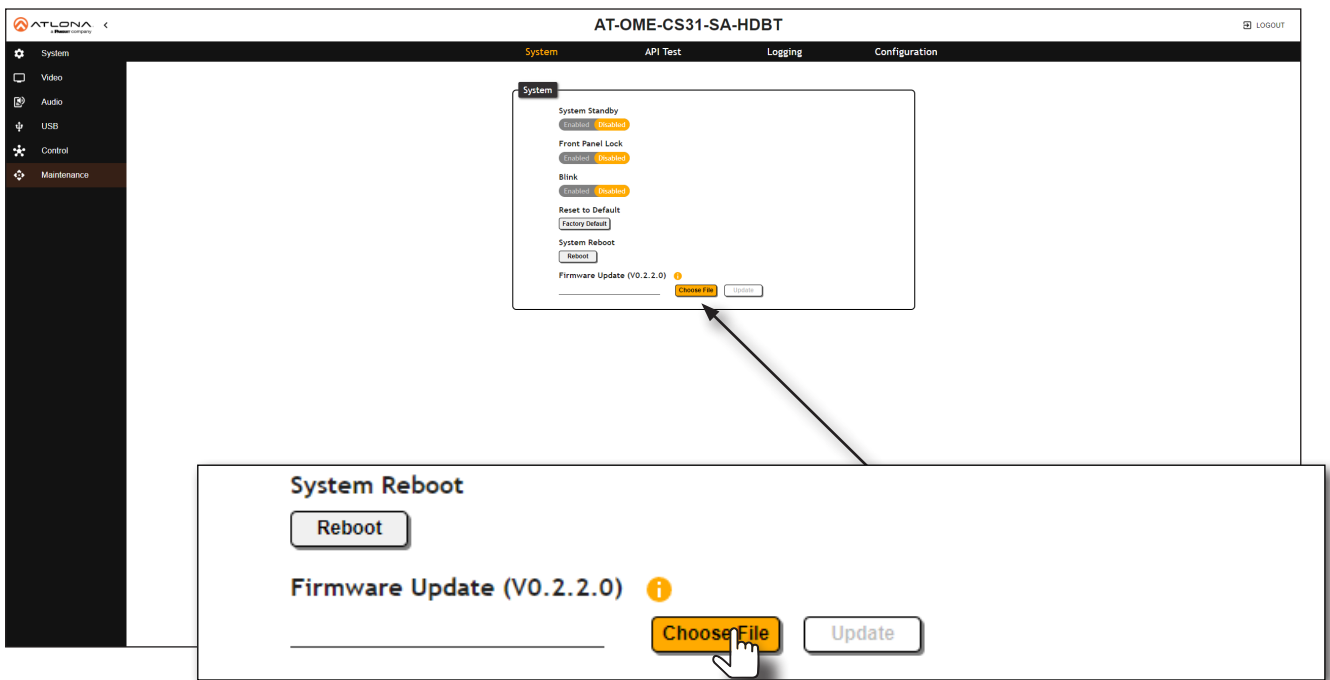

5. Click the **Choose File** button.
6. Browse to the location of the firmware file, select it, and click the **Open** button.
7. Click the **Update** button.

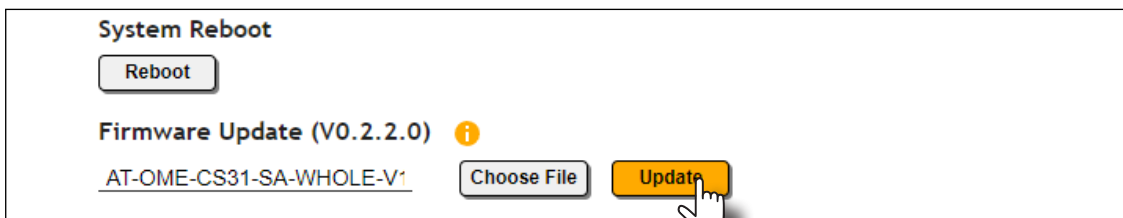

8. The following screen will be displayed, while the unit is updating.

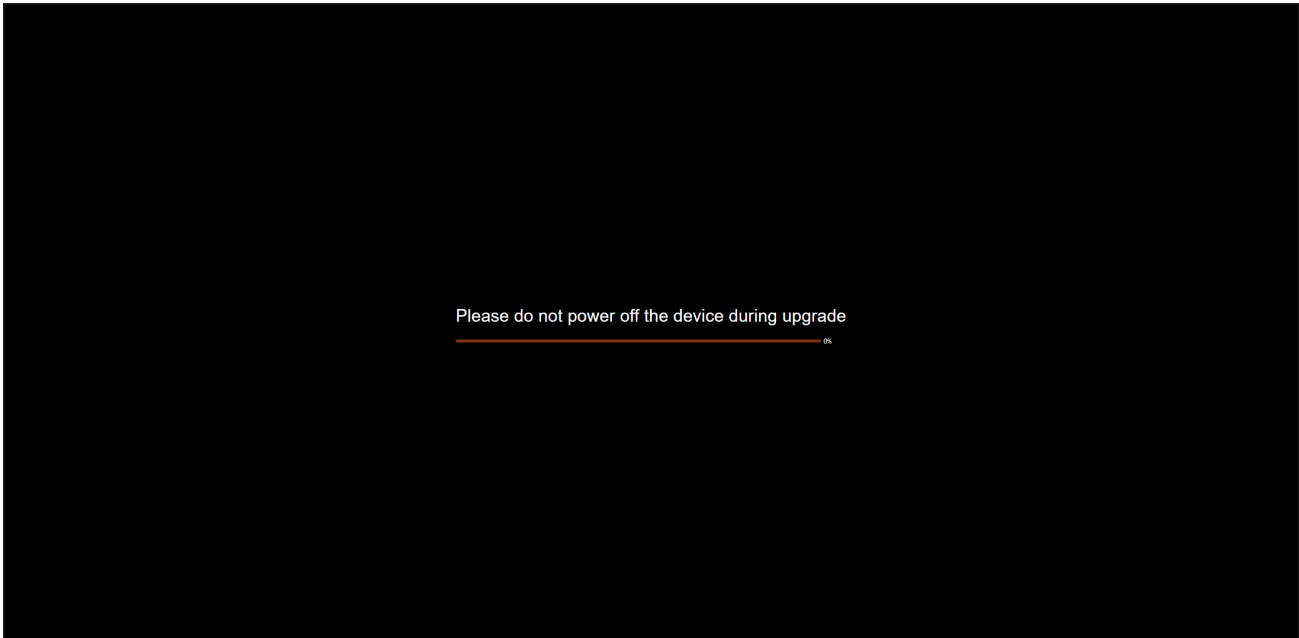

9. After the update process has completed, the AT-OME-CS31-SA-HDBT will automatically reboot.
10. After rebooting, the **Login** screen will be displayed.

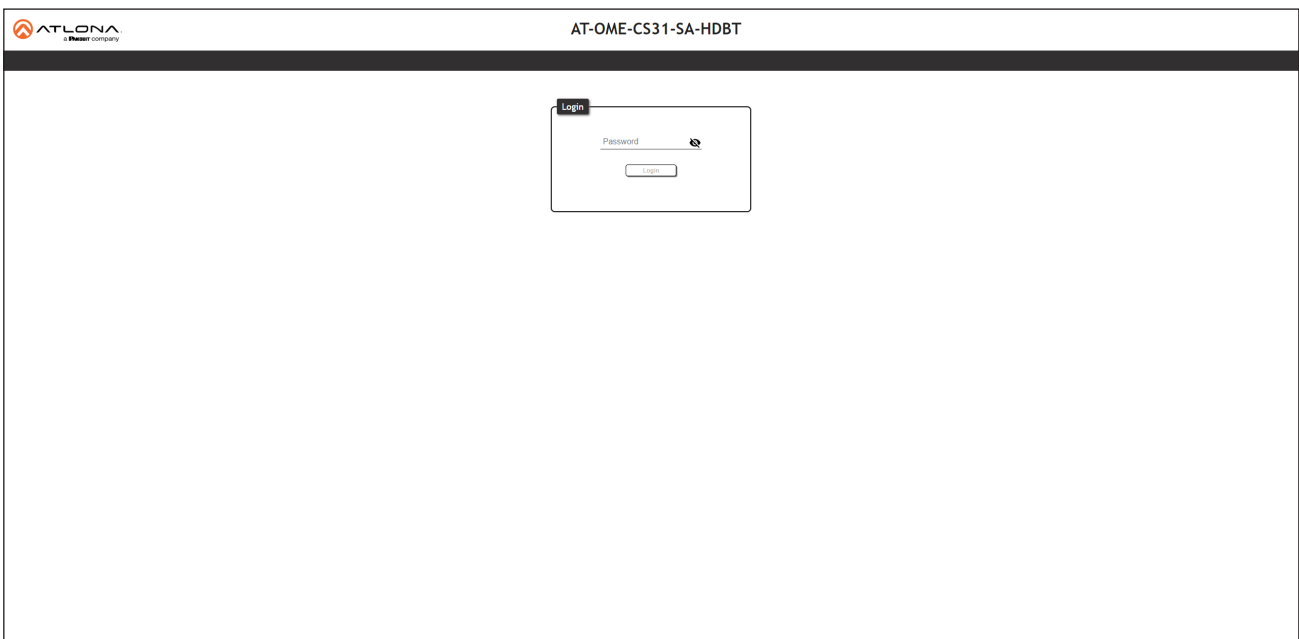

Updating over USB

Requirements:

- AT-OME-CS31-SA-HDBT
- Firmware file
- USB-C cable

1. Download the firmware file from atlona.com and extract the contents of the .zip file to a folder on the computer desktop. The firmware file will be in .tar.gz format.
2. Power on the unit.
3. Connect the USB-C cable to the computer. USB-C to USB-C or USB-A to USB-C cables can be used.
4. Press and hold the **INPUT** button on the front panel, until the front panel LED indicators start blinking.

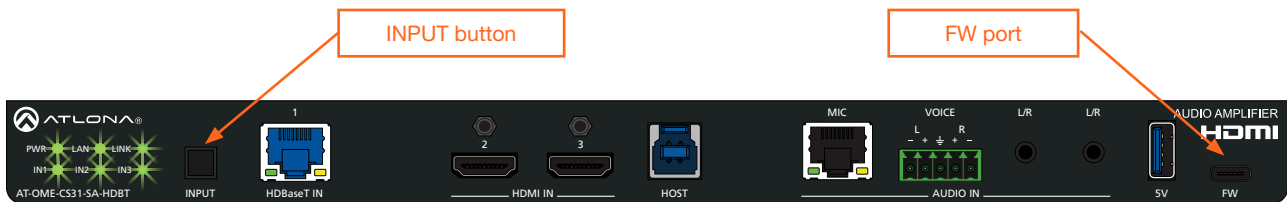

5. While continuing to hold down the **INPUT** button, connect the USB-C cable to the **FW** port on the AT-OME-CS31-SA-HDBT.
6. Release the **INPUT** button.
7. A virtual USB drive will be created and the folder of this drive will be displayed. If this folder is not displayed automatically, then select the drive from within Windows Explorer (Windows) or the Finder (Mac).
8. Delete all files from the drive, if any are present.
9. Drag-and-drop the firmware file to the drive folder.
10. Disconnect the USB cable from the AT-OME-CS31-SA-HDBT.

Mounting Instructions

The AT-OME-CS31-SA-HDBT includes mounting brackets, which can be used to attach the unit to any flat surface.

1. Position one of the mounting brackets, as shown below, aligning the holes on the side of the enclosure with one set of holes on the mounting bracket.

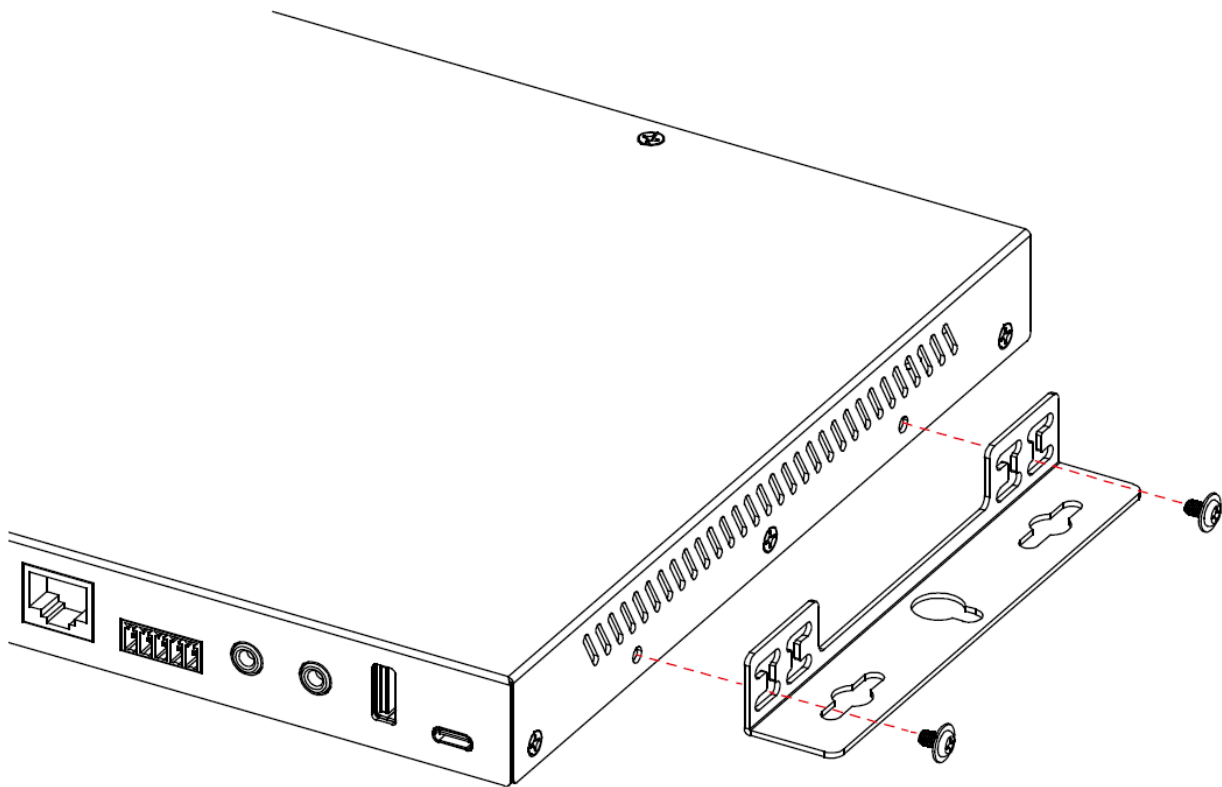

2. Using a small Phillips screwdriver, attach the installation bracket to the enclosure, using the included screws.
3. Repeat steps 1 and 2 to attach the second mounting bracket to the opposite side of the unit.
4. Mount the unit to a flat surface using the oval-shaped holes, on each mounting bracket. If using a drywall surface, a #6 drywall screw is recommended.

Specifications

Video	
Signal	Input - HDMI, HDBaseT Output - HDMI
Copy Protection	HDCP 2.2
Pixel Clock	HDMI: 600 MHz, HDBaseT: 300 MHz
UHD/HD/SD	4096x2160 (DCI) @ 24/25/30/50/60 ⁽¹⁾ Hz 720x576p @ 50 Hz 3840x2160 (UHD) @ 24/25/30/50/60 ⁽¹⁾ Hz 720x576i @ 25/50 Hz 1920x1080p @ 720x480p @ 60 Hz 23.97/24/25/29.97/30/50/60 Hz 640x480p @ 60 Hz 1920x1080i @ 50/60 Hz 640x480i @ 60 Hz 1280x720p @ 30/50/60 Hz
VESA All resolutions are 60 Hz	2560x2048 1366x768 2560x1600 1360x768 2048x1536 1280x1024 1920x1200 1280x800 1680x1050 1280x768 1600x1200 1152x768 1600x900 1024x768 1440x900 800x600 1400x1050 640x480
Color Space	YUV, RGB
Chroma Subsampling	4:4:4, 4:2:2, 4:2:0
Color Depth	8-bit, 10-bit, 12-bit
HDR	HDR10, Hybrid-Log Gamma (HLG), and Dolby® Vision™ @ 60 Hz

Audio			
HDMI Pass-Through Formats	LPCM 2.0 LPCM 5.1 LPCM 7.1	Dolby® Digital Dolby Digital Plus™ Dolby TrueHD Dolby Atmos®	DTS® Digital Surround™ DTS-HD Master Audio™ DTS:X®
Bit Depth	Up to 24 bits		
Sample Rate	32 kHz, 44.1 kHz, 48 kHz, 88.2 kHz, 96 kHz, 176.4 kHz, 192 kHz		
Analog Audio			
Format	Stereo 2-Channel		
Balanced Input	+4 dBu		
Unbalanced Input	-10 dBV		
Amplifier Output	2 x 25 W @ 4 or 8 Ω Frequency Response: 20 Hz to 20 kHz +/- 2 dB THD+N: < 0.1% @ 1 kHz SNR: 85 dB		
Balanced Output	+4 dBu Frequency Response: 20 Hz to 20 kHz +/- 0.5 dB THD+N: < 0.025% from 20 Hz to 20 kHz		

USB	
Signal	3.0
Maximum Data Rate	5 Gbps
Internal Hubs	1 USB hub

Ethernet	
Port	2 x RJ45
Standards and Protocols	HTTP, HTTPS, Telnet, SSH, JSON over WebSockets
Speeds	10/100/1000 Mbps
Addressing	DHCP, Static – selectable through built-in web server and API commands

RS-232	
Port	2 x 3-pin captive screw
Use	Unit and external device control and configuration
Baud Rates	2400, 4800, 9600, 19200, 38400, 57600, 115200
Data Flow	Bidirectional

CEC	
Ports	1 x HDMI OUT, Type A, 19-pin female
Triggering	Through HDMI

Resolution / Distance	4K/UHD - Feet / Meters		1080p - Feet / Meters	
HDMI IN/OUT	15	5	30	10
CAT5e	295	90	330	100
CAT6/6a/7	330	100	330	100

Buttons and Indicators	
Buttons: INPUT	1 x momentary, tact-type
Indicators: PWR, LAN, LINK IN1, IN2, IN3	6 x LED, green

Connectors	
HDMI IN	2 x Type A, 19-pin female
HDMI OUT	1 x Type A, 19-pin female
HDBaseT IN	1 x RJ45
HOST	1 x USB type B, female
MIC	1 x RJ45
VOICE L/R	1 x 5-pin captive screw
L/R	2 x 3.5 mm mini-stereo
5V	1 x USB type A, female
FW	1 x USB type C, female
LAN	2 x RJ45
TRIGGER I/O	2 x 4-pin captive screw
RS-232	2 x 3-pin captive screw
PA SENSE TRIGGER	1 x 2-pin captive screw
PA SENSE GND/25V/75V/100V	1 x 4-pin captive screw
AMP OUT	1 x 4-pin captive screw
AUDIO OUT	1 x 5-pin captive screw
HUB	4 x USB type A, female
24V / 5A	1 x 4-pin DIN

Environmental	Fahrenheit	Celsius
Operating Temperature	+32 to +122	0 to +50
Storage Temperature	-4 to +140	-20 to +60
Operating Humidity (RH)	20% to 90%, non-condensing	

Power	
Consumption (max.)	95.3 W
BTU/h	325.2
External Power Supply	100 - 240 V AC, 50/60 Hz Output: 24 V / 5 A DC

Dimensions (H x W x D)	Inches	Millimeters
Unit	0.98 x 11.81 x 8.27	25 x 300 x 210
Power Supply (AT-PS-245-D4)	1.6 x 2.6 x 6.2	40.6 x 66 x 157

Weight	Pounds	Kilograms
Device	3.8	1.7

Certification	
Device	CE, RoHS, FCC
Power Supply	CE, FCC, UL, CUL, TUV-GS, CB, PSE, CCC

Compliance	
NDA-889	Yes

Warranty	
3 years	View the full warranty information here: https://atlon.com/warranty

Footnotes

(1) 4K/UHD @ 60 Hz only supports 4:2:0.

