



Maintenance and Service Guide

SUMMARY

This guide provides information about spare parts, removal and replacement of parts, security, backing up, and more.

Legal information

© Copyright 2021, 2022 HP Development Company, L.P.

Intel, Celeron, and Pentium are trademarks of Intel Corporation or its subsidiaries in the U.S. and/or other countries. Microsoft and Windows are either registered trademarks or trademarks of Microsoft Corporation in the United States and/or other countries. USB Type-C and USB-C are registered trademarks of USB Implementers Forum.

The information contained herein is subject to change without notice. The only warranties for HP products and services are set forth in the express warranty statements accompanying such products and services. Nothing herein should be construed as constituting an additional warranty. HP shall not be liable for technical or editorial errors or omissions contained herein.

Third Edition: March 2022

First Edition: November 2021

Document Part Number: M76758-003

Product notice

This guide describes features that are common to most models. Some features may not be available on your computer.

Not all features are available in all editions or versions of Windows. Systems may require upgraded and/or separately purchased hardware, drivers, software or BIOS update to take full advantage of Windows functionality. Windows is automatically updated, which is always enabled. High-speed internet and Microsoft account required. ISP fees may apply and additional requirements may apply over time for updates. See <http://www.windows.com>. **If your product ships with Windows in S Mode:** Windows in S Mode works exclusively with apps from the Microsoft Store within Windows. Certain default settings, features, and apps cannot be changed. Some accessories and apps that are compatible with Windows may not work (including some antivirus, PDF writers, driver utilities, and accessibility apps), and performance may vary, even if you switch out of S Mode. If you switch to Windows, you cannot switch back to S Mode. Learn more at [Windows.com/SmodeFAQ](https://www.windows.com/SmodeFAQ).

To access the latest user guides, go to <http://www.hp.com/support>, and follow the instructions to find your product. Then select **Manuals**.

Software terms

By installing, copying, downloading, or otherwise using any software product preinstalled on this computer, you agree to be bound by the terms of the HP End User License Agreement (EULA). If you do not accept these license terms, your sole remedy is to return the entire unused product (hardware and software) within 14 days for a full refund subject to the refund policy of your seller.

For any further information or to request a full refund of the price of the computer, please contact your seller.

Safety warning notice

Reduce the possibility of heat-related injuries or of overheating the computer by following the practices described.

-
-  **WARNING!** To reduce the possibility of heat-related injuries or of overheating the computer, do not place the computer directly on your lap or obstruct the computer air vents. Use the computer only on a hard, flat surface. Do not allow another hard surface, such as an adjoining optional printer, or a soft surface, such as pillows or rugs or clothing, to block airflow. Also, do not allow the AC adapter to come into contact with the skin or a soft surface, such as pillows or rugs or clothing, during operation. The computer and the AC adapter comply with the user-accessible surface temperature limits defined by applicable safety standards.
-

Table of contents

1 Computer features	1
Standard features	1
Integrated features	2
Stand options	3
Essential Stand components	4
Advanced Stand and Advanced Swivel Stand components	4
Essential VESA Hub components	5
Pro VESA Hub components	5
Locating the system power button	6
Adjusting the head unit	6
System serial number location	7
Essential Stand serial number location	7
Advanced Stand and Advanced Swivel Stand serial number location	8
Installing a security cable on the Advanced Stand or the Advanced Swivel Stand	8
2 Illustrated parts catalog	9
Computer major components	9
Miscellaneous parts	10
3 Routine care, SATA drive guidelines, and disassembly preparation	12
Electrostatic discharge information	12
Generating static electricity	12
Preventing electrostatic damage to equipment	13
Personal grounding methods and equipment	13
Grounding the work area	14
Recommended materials and equipment	14
Operating guidelines	15
Routine care	15
General cleaning safety precautions	15
Cleaning the computer case	16
Cleaning the keyboard	16
Cleaning the monitor	16
Cleaning the mouse	17
Service considerations	17
Tools and software requirements	17
Screws	17
Cables and connectors	17
Lithium coin cell battery	18

Cable management.....	18
4 Removal and replacement procedures.....	19
Preparation for disassembly	19
Head unit from stand.....	19
Back plate	21
Integrated payment installation	22
Expansion slot cover.....	24
System board cover	25
Memory module (SODIMM).....	25
Solid-state drive	27
Battery	29
Microphone module	30
Power button board.....	31
Left expansion slot cable.....	32
NFC module.....	33
WLAN module	34
WLAN antenna	35
Speaker	36
Processor heat sink	37
Magnetic stripe reader.....	38
Fingerprint reader.....	39
System board.....	40
5 Configuring the software	42
Configuring the powered serial ports on the Advanced Stand or Advanced Swivel Stand	42
Touch screen calibration for Windows 10 Professional and Windows 10 IoT Enterprise for Retail	42
Configuring optional HP integrated peripheral modules.....	43
Updating the system	43
Downloading HP Firmware Installer.....	43
Installing updates	43
6 Computer Setup (F10) Utility	44
Using Computer Setup (F10) Utilities	44
Computer Setup Main	45
Computer Setup Security.....	49
Computer Setup Advanced	53
7 POST error messages.....	62
POST numeric codes and text messages	62
Interpreting POST diagnostic front panel lights and audible codes	68

8 Password security and resetting CMOS	71
Changing a setup or power-on password	71
Deleting a setup or power-on password.....	71
9 Backing up, restoring, and recovering	73
Backing up information and creating recovery media.....	73
Using Windows tools for backing up.....	73
Using the HP Cloud Recovery Download Tool to create recovery media (select products only).....	73
Restoring and recovering your system	73
Creating a system restore	74
Restoring and recovery methods.....	74
Recovering using HP Recovery media	74
Changing the computer boot order	75
Using HP Sure Recover (select products only)	75
10 Using HP PC Hardware Diagnostics	76
Using HP PC Hardware Diagnostics Windows (select products only)	76
Using an HP PC Hardware Diagnostics Windows hardware failure ID code.....	76
Accessing HP PC Hardware Diagnostics Windows.....	76
Accessing HP PC Hardware Diagnostics Windows from HP Help and Support (select products only).....	76
Accessing HP PC Hardware Diagnostics Windows from Support Assistant.....	77
Accessing HP PC Hardware Diagnostics Windows from the Start menu (select products only)	77
Downloading HP PC Hardware Diagnostics Windows	77
Downloading the latest HP PC Hardware Diagnostics Windows version from HP	77
Downloading the HP PC Hardware Diagnostics Windows from the Microsoft Store.....	77
Downloading HP Hardware Diagnostics Windows by product name or number (select products only)	78
Installing HP PC Hardware Diagnostics Windows	78
Using HP PC Hardware Diagnostics UEFI.....	78
Using an HP PC Hardware Diagnostics UEFI hardware failure ID code	78
Starting HP PC Hardware Diagnostics UEFI.....	79
Downloading HP PC Hardware Diagnostics UEFI to a USB flash drive	79
Downloading the latest HP PC Hardware Diagnostics UEFI version	79
Downloading HP PC Hardware Diagnostics UEFI by product name or number (select products only).....	79
Using Remote HP PC Hardware Diagnostics UEFI settings (select products only)	80
Downloading Remote HP PC Hardware Diagnostics UEFI.....	80
Downloading the latest Remote HP PC Hardware Diagnostics UEFI version	80
Downloading Remote HP PC Hardware Diagnostics UEFI by product name or number	80
Customizing Remote HP PC Hardware Diagnostics UEFI settings	80
11 Statement of memory volatility	82
Current BIOS steps.....	82
Nonvolatile memory usage	84
Questions and answers	86
Using HP Sure Start (select products only)	88
12 Power cord set requirements	89
General requirements.....	89

Japanese power cord requirements	89
Country-specific requirements	89
13 Specifications	91
Index	92

1 Computer features

This chapter provides you with an overview of your computer's features.

Standard features

To identify a typical computer configuration, read this section. Features vary depending on the model.



The HP Engage One Essential All-in-One System is designed for long-term deployment within general retail, hospitality, and other markets. It includes the following features:

- Modern design form factor fan-less system with options for integrated peripherals
- **35.6 cm (14.0 in)** display panel; 16:9 high definition (1920 × 1080) resolution, 250 nit, multitouch, direct bond, anti-smudge, 1.1 mm soda-lime glass
- Choice of three stands (with tilt):
 - Essential Stand
 - Advanced Stand
 - Advanced Swivel Stand
- Major integrated peripherals:
 - Near-field communication (NFC) authentication
 - Magnetic stripe reader (MSR) (optional)
 - Barcode scanner with integrated audio feedback (optional)
 - Customer-facing display (CFD) (optional)
 - Fingerprint reader (optional)
 - Integrated payment card scanner (available in the US only) (optional)
- Essential Stand (including hub):

- Two USB ports
- Two USB Type-C® power connector and SuperSpeed 5 Gbps ports, one with DisplayPort™ output
- RJ-45 (network) jack
- Advanced Stand or Advanced Swivel Stand (including hub):
 - Two powered serial ports (0 V, 5 V, 12 V)
 - Four USB 2.0 ports
 - USB Type-C power connector and SuperSpeed 5 Gbps port with DisplayPort output
 - RJ-12 (cash drawer) jack
 - 24 V powered USB port
 - RJ-45 (network) jack
 - Power connector
- Essential VESA Hub:
 - Two USB ports
 - Two USB Type-C power connector and SuperSpeed 5 Gbps ports; one with DisplayPort output
 - RJ-45 (network) jack
- Pro VESA Hub:
 - 12 V powered USB port
 - 24 V powered USB port
 - Three USB SuperSpeed 5 Gbps ports
 - RJ-45 (network) jack
 - USB Type-C SuperSpeed 5 Gbps port with DisplayPort output
 - Power connector

Integrated features

To identify the computer features, use this illustration and table.



NOTE: The integrated devices shown are optional.

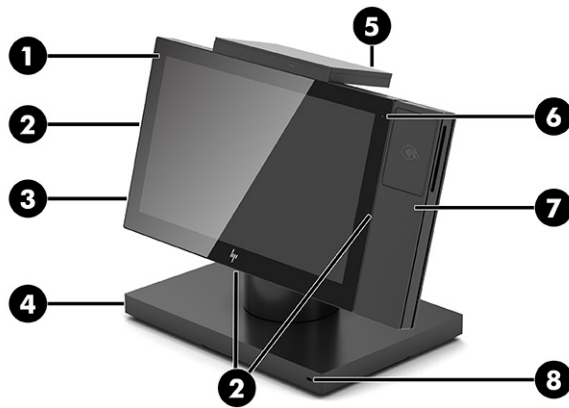

Table 1-1 Identifying the integrated features

Features			
1	35.6 cm (14.0 in), 1920 × 1080, high definition display	5	Peripheral bay (top): <ul style="list-style-type: none"> Customer-facing display (CFD) (optional)
2	Peripheral bays (left side, right side or bottom) (3): <ul style="list-style-type: none"> Barcode scanner with integrated audio feedback (optional) 	6	Magnetic stripe reader (MSR) (optional)
3	Fingerprint reader (optional)	7	Integrated payment card scanner (available in the US only) (optional)
4	Advanced Swivel Stand (select products only)	8	Security cable slot (available only on stands)

Stand options

To identify the available stands, use this illustration and table.



Table 1-2 Identifying the stands

Options	
1	Essential Stand with 15°–40° tilt
2	Advanced Stand with 15°–40° tilt
3	Advanced Swivel Stand with 15°–40° tilt

Essential Stand components

To identify the Essential Stand features, use this illustration and table.

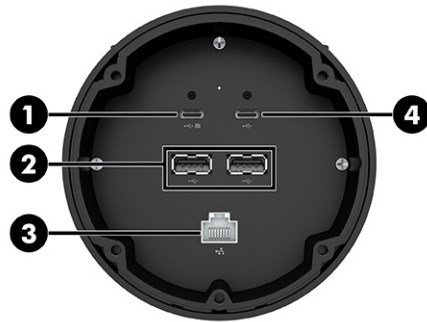

Table 1-3 Identifying the Essential Stand features

Features			
1	USB Type-C power connector and SuperSpeed 5 Gbps port with DisplayPort output	3	RJ-45 (network) jack
2	USB 2.0 ports (2)	4	USB Type-C power connector and SuperSpeed 5 Gbps port

Advanced Stand and Advanced Swivel Stand components

To identify the Advanced Stand and Advanced Swivel Stand features, use this illustration and table.

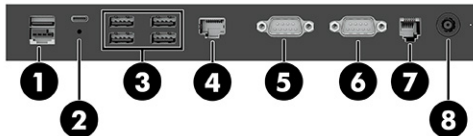

Table 1-4 Advanced Stand and Advanced Swivel Stand features

Features	
1	Powered USB 24 V port
5	Powered serial port (COM B 0V/5V/12V) You can configure the serial port as a standard (unpowered) serial port or powered serial port. Some devices use a powered serial port. If the serial port is configured as a powered port, devices that support a powered serial interface do not require an external power source. To configure the powered serial port, see Configuring the powered serial ports on the Advanced Stand or Advanced Swivel Stand on page 42 .

Table 1-4 Advanced Stand and Advanced Swivel Stand features (continued)

Features			
2	USB Type-C power connector and SuperSpeed 5 Gbps port with DisplayPort output	6	Powered serial port (COM A 0V/5V/12V) You can configure the serial port as a standard (unpowered) serial port or powered serial port. Some devices use a powered serial port. If the serial port is configured as a powered port, devices that support a powered serial interface do not require an external power source. To configure the powered serial port, see Configuring the powered serial ports on the Advanced Stand or Advanced Swivel Stand on page 42 .
3	USB 2.0 ports (4)	7	RJ-12 (cash drawer) jack
4	RJ-45 (network) jack	8	Power connector

IMPORTANT: To avoid damage to the computer, **do not** plug a telephone cable into the cash drawer jack.

Essential VESA Hub components

To identify the Essential VESA Hub features, use this illustration and table.

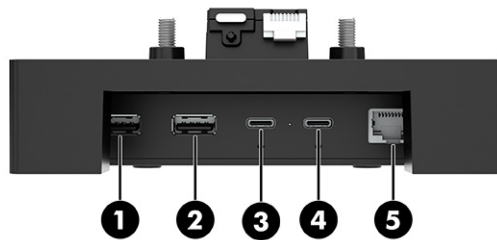

Table 1-5 Essential VESA Hub features

Features			
1	USB 2.0 port	4	USB Type-C power connector and SuperSpeed 5 Gbps port with DisplayPort output
2	USB 2.0 port	5	RJ-45 (network) jack
3	USB Type-C power connector and SuperSpeed 5 Gbps port		

Pro VESA Hub components

To identify the Pro VESA Hub features, use this illustration and table.

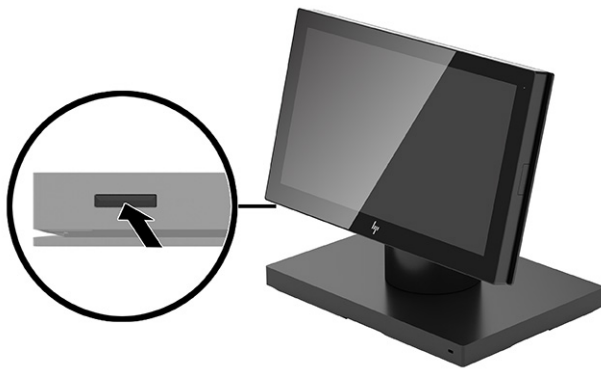

Table 1-6 Pro VESA Hub features

Features	
1	RJ-45 (network) jack
2	Power connector
3	Powered USB 24 V port
4	Powered USB 12 V port
5	USB Type-C port with DisplayPort output
6	USB SuperSpeed 5 Gbps ports (3)

Locating the system power button

The computer power button is located on the bottom left edge of the bezel.



Adjusting the head unit

You can tilt the head unit on each stand option by as much as 25° when you set the angle between 15° and 40°.



 **NOTE:** You can swivel the Advanced Swivel Stand head unit 180° in either direction.

System serial number location

Each computer has a unique serial number and a product ID number that are located on the exterior of the computer at the bottom of the display bezel. Keep these numbers available when you contact customer service for assistance.



Essential Stand serial number location

Each Essential Stand has a unique serial number and a product ID number that is located on the exterior of the base. Keep these numbers available when you contact customer service for assistance.



Regulatory information is located in the base plate or wall mount.

Advanced Stand and Advanced Swivel Stand serial number location

Each Advanced Stand and Advanced Swivel Stand has a unique serial number and a product ID number that is located on the exterior of the base. Keep these numbers available when you contact customer service for assistance.



Regulatory information is located in the base plate or wall mount.

Installing a security cable on the Advanced Stand or the Advanced Swivel Stand

You can secure the Advanced Stand to a fixed object with an optional security cable available from HP.

 **NOTE:** The security cable is sold separately as an aftermarket option kit only.

1. Locate the security cable slot on the back of the stand.
2. Insert the security cable lock into the slot, and then use the key to lock it.

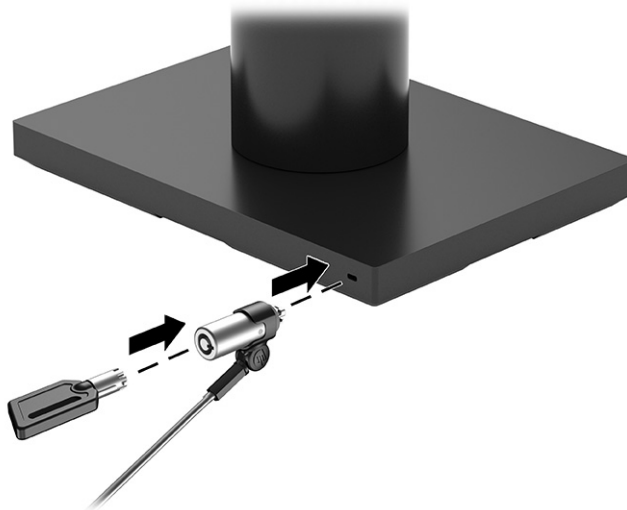

2 Illustrated parts catalog

Use this information to determine the spare parts that are available for the computer.

 **NOTE:** HP continually improves and changes product parts. For complete and current information about supported parts for your computer, go to <http://partsurfer.hp.com>, select your country or region, and then follow the on-screen instructions.

Computer major components

To identify the computer major components, use this illustration and table.

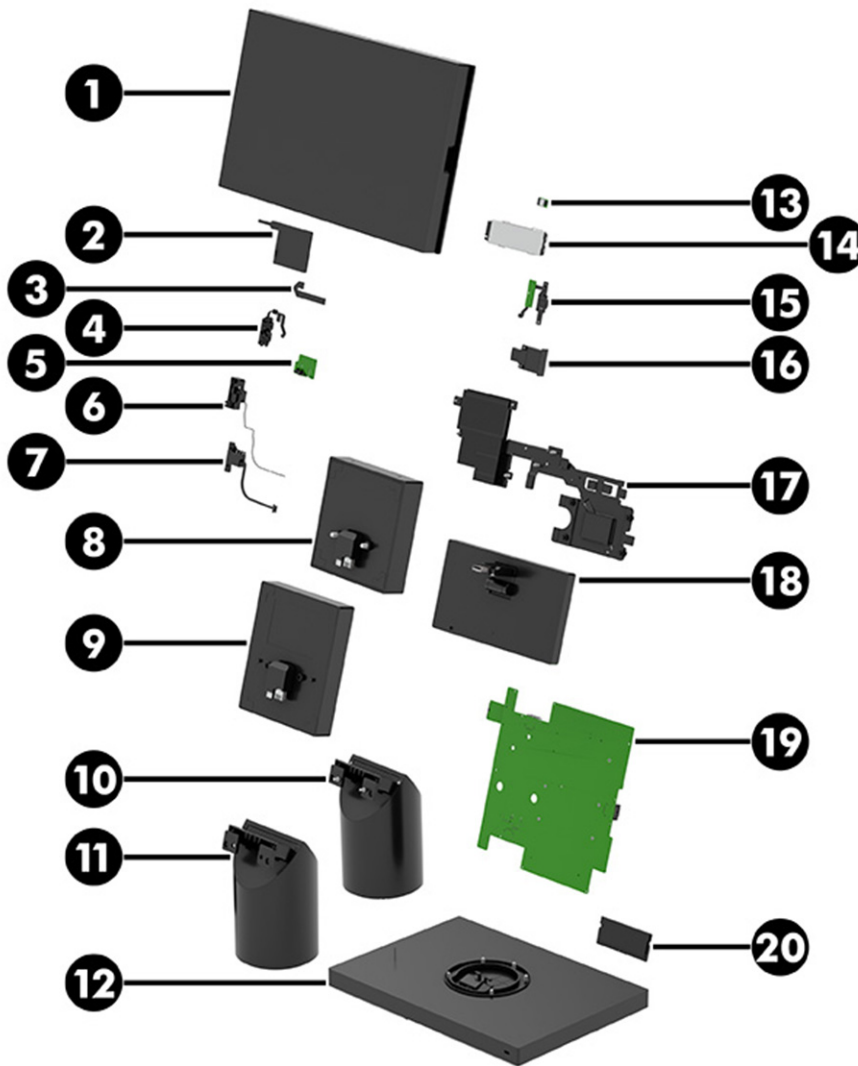

Table 2-1 Computer major components and their descriptions

Item	Description
(1)	Display head unit (35.6 cm [14.0 inch])
(2)	NFC antenna
(3)	Power button board cable
(4)	Fingerprint reader
(5)	Power button board
(6)	Speaker
(7)	USB expansion slot insert
(8)	Essential VESA hub
(9)	Pro VESA Hub
(10)	Essential stand
(11)	Advanced stand
(12)	Display head unit
(13)	NFC module
(14)	Solid-state drive (M.2 2280, PCIe; not illustrated)
	256 GB, TLC
	128 GB, TLC
(15)	Magnetic stripe reader
(16)	Expansion slot insert
(17)	Heat sink assembly
(18)	16.8 cm (6.6-inch) customer-facing display (CFD)
(19)	System board (includes processor)
	Pentium processor
	Celeron processor
(20)	Memory modules (PC4-3200)
	8 GB
	4 GB
	WLAN module (not illustrated)
	Bottom cover (not illustrated)

Miscellaneous parts

To identify the various computer parts, use this table.

Table 2-2 Miscellaneous parts and their descriptions

Description
RTC battery
Seal ring
Power cord (C5, 1.8 m [6 ft])
AC adapter
150 W, 7.4 mm, 3 pin, power correcting factor (PFC)
65 W, USB Type-C®, non-power correcting factor (nPFC)
Antenna Kit
Memory module cover
Cables
FPC cable, 0.55 mm
FPC cable, 0.15 mm
FPC cable, 0.12 mm
NFC cable
USB cable

3 Routine care, SATA drive guidelines, and disassembly preparation

This information provides general service information for the computer. Adherence to the procedures and precautions is essential for proper service.

 **IMPORTANT:** When the computer is plugged into an AC power source, AC voltage is always applied to the system board. You must disconnect the power cord from the power source before opening the computer to prevent electric shock, system board, or component damage.

Electrostatic discharge information

A sudden discharge of static electricity from your finger or other conductor can destroy static-sensitive devices or microcircuitry. Often the spark is neither felt nor heard, but damage occurs.

An electronic device exposed to electrostatic discharge (ESD) might not appear to be affected at all and can work perfectly throughout a normal cycle. The device might function normally for a while, but it has been degraded in the internal layers, reducing its life expectancy.

Networks built into many integrated circuits provide some protection, but in many cases, the discharge contains enough power to alter device parameters or melt silicon junctions.

 **IMPORTANT:** To prevent damage to the device when you are removing or installing internal components, observe these precautions:

Keep components in their electrostatic-safe containers until you are ready to install them.

Before touching an electronic component, discharge static electricity by using the guidelines described in this section.

Avoid touching pins, leads, and circuitry. Handle electronic components as little as possible.

If you remove a component, place it in an electrostatic-safe container.

Generating static electricity

This table shows how humidity affects the electrostatic voltage levels generated by different activities. A product can be degraded by 700 V.

- Different activities generate different amounts of static electricity.
- Static electricity increases as humidity decreases.

Table 3-1 Static electricity occurrence based on activity and humidity

Event	Relative humidity		
	55%	40%	10%

Table 3-1 Static electricity occurrence based on activity and humidity (continued)

	Relative humidity		
Walking across carpet	7,500 V	15,000 V	35,000 V
Walking across vinyl floor	3,000 V	5,000 V	12,000 V
Motions of bench worker	400 V	800 V	6,000 V
Removing DIPs (dual in-line packages) from plastic tube	400 V	700 V	2,000 V
Removing DIPs from vinyl tray	2,000 V	4,000 V	11,500 V
Removing DIPs from polystyrene foam	3,500 V	5,000 V	14,500 V
Removing bubble pack from PCB (printed circuit board)	7,000 V	20,000 V	26,500 V
Packing PCBs in foam-lined box	5,000 V	11,000 V	21,000 V

Multiple electric components can be packaged together in plastic tubes, trays, or polystyrene foam.

Preventing electrostatic damage to equipment

Many electronic components are sensitive to ESD. Circuitry design and structure determine the degree of sensitivity. The following packaging and grounding precautions are necessary to prevent static electricity damage to electronic components.

- To avoid hand contact, transport products in static-safe containers such as tubes, bags, or boxes.
- Protect all electrostatic parts and assemblies with conductive or approved containers or packaging.
- Keep electrostatic-sensitive parts in their containers until they arrive at static-free stations.
- Place items on a grounded surface before removing them from their container.
- Always be properly grounded when touching a sensitive component or assembly.
- Avoid contact with pins, leads, or circuitry.
- Place reusable electrostatic-sensitive parts from assemblies in protective packaging or conductive foam.

Personal grounding methods and equipment

Use this equipment to prevent static electricity damage to electronic components.

- **Wrist straps** are flexible straps with a maximum of $1\text{ M}\Omega \pm 10\%$ resistance in the ground cords. To provide proper ground, a strap must be worn snug against bare skin. The ground cord must be connected and fit snugly into the banana plug connector on the grounding mat or workstation.
- **Heel straps/Toe straps/Boot straps** can be used at standing workstations and are compatible with most types of shoes or boots. On conductive floors or dissipative floor mats, use them on both feet with a maximum of $1\text{ M}\Omega \pm 10\%$ resistance between the operator and ground.

Table 3-2 Static shielding protection levels

Static shielding protection levels	
Method	Voltage

Table 3-2 Static shielding protection levels (continued)

Static shielding protection levels	
Antistatic plastic	1,500 V
Carbon-loaded plastic	7,500 V
Metallized laminate	15,000 V

Grounding the work area

To prevent static damage at the work area, use these precautions.

- Cover the work surface with approved static-dissipative material. Provide a wrist strap connected to the work surface and properly grounded tools and equipment.
- Use static-dissipative mats, foot straps, or air ionizers to give added protection.
- Handle electrostatic sensitive components, parts, and assemblies by the case or PCB laminate. Handle them only at static-free work areas.
- Turn off power and input signals before inserting and removing connectors or test equipment.
- Use fixtures made of static-safe materials when fixtures must directly contact dissipative surfaces.
- Keep work area free of nonconductive materials such as ordinary plastic assembly aids and polystyrene foam.
- Use field service tools, such as cutters, screwdrivers, and vacuums, that are conductive.

Recommended materials and equipment

HP recommends the these materials and equipment to prevent static electricity.

- Antistatic tape
- Antistatic smocks, aprons, or sleeve protectors
- Conductive bins and other assembly or soldering aids
- Conductive foam
- Conductive tabletop workstations with ground cord of $1\text{ M}\Omega \pm 10\%$ resistance
- Static-dissipative table or floor mats with hard tie to ground
- Field service kits
- Static awareness labels
- Wrist straps and footwear straps providing $1\text{ M}\Omega \pm 10\%$ resistance
- Material handling packages
- Conductive plastic bags
- Conductive plastic tubes
- Conductive tote boxes

- Opaque shielding bags
- Transparent metallized shielding bags
- Transparent shielding tubes

Operating guidelines

This information details how to prevent overheating and to help prolong the life of the computer.

- Keep the computer away from excessive moisture, direct sunlight, and extremes of heat and cold.
- Operate the computer on a sturdy, level surface. Leave a 10.2 cm (4 inch) clearance on all vented sides of the computer and above the monitor to permit the required airflow.
- Never restrict the airflow into the computer by blocking any vents or air intakes. Do not place the keyboard, with the keyboard feet down, directly against the front of the desktop unit as this also restricts airflow.
- Occasionally clean the air vents on all vented sides of the computer. Lint, dust, and other foreign matter can block the vents and limit the airflow. Be sure to unplug the computer before cleaning the air vents.
- Never operate the computer with the cover or side panel removed.
- Do not stack computers on top of each other or place computers so near each other that they are subject to each other's recirculated or preheated air.
- If the computer is to be operated within a separate enclosure, intake and exhaust ventilation must be provided on the enclosure, and the same operating guidelines listed previously still apply.
- Keep liquids away from the computer and keyboard.
- Never cover the ventilation slots on the monitor with any type of material.
- Install or enable power management functions of the operating system or other software, including Sleep states.

Routine care

Use this information to properly care for your computer.

General cleaning safety precautions

Use this information to safely clean your computer.

⚠ CAUTION: To prevent electric shock or damage to components, never clean a product while it is turned on or plugged in.

- Never use solvents or flammable solutions to clean the computer.
- Never immerse any parts in water or cleaning solutions; apply any liquids to a clean cloth and then use the cloth on the component.
- Always unplug the computer when cleaning with liquids or damp cloths.
- Always unplug the computer before cleaning the keyboard, mouse, or air vents.

- Disconnect the keyboard before cleaning it.
- Wear safety glasses equipped with side shields when cleaning the keyboard.

Cleaning the computer case

Follow all safety precautions before cleaning the computer case.

To clean the computer case, follow these procedures:

- To remove light stains or dirt, use plain water with a clean, lint-free cloth or swab.
- For stronger stains, use a mild dishwashing liquid diluted with water. Rinse well by wiping it with a cloth or swab dampened with clear water.
- For stubborn stains, use isopropyl (rubbing) alcohol. No rinsing is needed because the alcohol evaporates quickly and does not leave a residue.
- After cleaning, always wipe the unit with a clean, lint-free cloth.
- Occasionally clean the air vents on the computer. Lint and other foreign matter can block the vents and limit the airflow.

Cleaning the keyboard

Use this information to properly clean the keyboard. Follow all safety precautions before cleaning the keyboard.

To clean the tops of the keys or the keyboard body, follow the procedures described in [Cleaning the computer case on page 16](#).

When cleaning debris from under the keys, review all rules in [General cleaning safety precautions on page 15](#) before following these procedures.

 **CAUTION:** Use safety glasses equipped with side shields before attempting to clean debris from under the keys.

- You can remove visible debris underneath or between the keys by vacuuming or shaking.
- You can use canned, pressurized air to clean debris from under the keys. Use caution because too much air pressure can dislodge lubricants applied under the wide keys.
- If you remove a key, use a specially designed key puller to prevent damage to the keys. This tool is available through many electronic supply outlets.

 **IMPORTANT:** Never remove a wide leveled key (like the space bar) from the keyboard. If these keys are improperly removed or installed, the keyboard might not function properly.

- You can clean under a key with a swab moistened with isopropyl alcohol and squeezed out. Be careful not to wipe away lubricants necessary for proper key functions. Use tweezers to remove any fibers or dirt in confined areas. Allow the parts to air dry before reassembly.

Cleaning the monitor

Follow all safety precautions before cleaning dirt and debris from your computer. Use this information to properly clean the monitor.

- Wipe the monitor screen with a clean cloth moistened with water or with a towelette designed for cleaning monitors. Do not use sprays or aerosols directly on the screen; the liquid can seep into the housing and damage a component. Never use solvents or flammable liquids on the monitor.
- To clean the monitor body, follow the procedures in [Cleaning the computer case on page 16](#).

Cleaning the mouse

Follow all safety precautions before cleaning dirt and debris from your computer. Use this information to properly clean the mouse.

- Clean the mouse ball by first removing the retaining plate and the ball from the housing. Pull out any debris from the ball socket and wipe the ball with a clean, dry cloth before reassembly.
- To clean the mouse body, follow the procedures in [Cleaning the computer case on page 16](#).

Service considerations

Keep these considerations in mind during the disassembly and assembly of the computer.

Tools and software requirements

Servicing the computer requires these tools.

- Phillips P1 screwdriver
- Nonconductive, nonmarking pry tool
- Diagnostics software

Screws

The screws used in the computer are not interchangeable. They could have standard or metric threads and might be of different lengths.

If you use an incorrect screw during the reassembly process, it can damage the unit. HP strongly recommends that you keep all screws that you remove during disassembly with the removed part and then return them to their proper locations.



IMPORTANT: As you remove each subassembly from the computer, place it away from the work area to prevent damage.

Cables and connectors

Use this information properly handle cables.

Apply only the tension required to seat or unseat the cables during insertion or removal from the connector. Handle cables by the connector whenever possible. In all cases, avoid bending or twisting the cables, and route the cables so that they cannot be caught or snagged by parts being removed or replaced.





IMPORTANT: When servicing this computer, be sure to place cables in their proper location during the reassembly process. Improper cable placement can damage the computer.

Lithium coin cell battery

The battery that comes with the computer provides power to the real-time clock and has a minimum lifetime of approximately three years.

See the appropriate removal and replacement chapter for the chassis that you are working on for instructions on the replacement procedures.

 **WARNING!** This computer contains a lithium battery. There is a risk of fire and chemical burn if the battery is handled improperly. Do not disassemble, crush, puncture, short external contacts, dispose of in water or fire, or expose it to temperatures higher than 140°F (60°C). Do not attempt to recharge the battery.

 **NOTE:** Do not dispose of batteries, battery packs, and accumulators with general household waste. To forward them to recycling centers or proper disposal, use the public collection system or return them to HP, their authorized partners, or their agents.

Cable management

Always follow good cable management practices when working inside the computer.

- Keep cables away from major heat sources like the heat sink.
- Keep cables clear of sliding or moveable parts to prevent them from being cut or crimped when the parts are moved.
- When folding a flat ribbon cable, never fold to a sharp crease. Sharp creases can damage the wires.
- Do not bend any cable sharply. A sharp bend can break the internal wires.
- Never bend a SATA data cable tighter than a 30 mm (1.18 in) radius.
- Never crease a SATA data cable.

4 Removal and replacement procedures

Adherence to these procedures and precautions is essential for proper service. After completing all necessary removal and replacement procedures, run the Diagnostics utility to verify that all components operate properly.

 **NOTE:** Not all features listed in this guide are available on all computers.

 **NOTE:** HP continually improves and changes product parts. For complete and current information about supported parts for your computer, go to <http://partsurfer.hp.com>, select your country or region, and then follow the on-screen instructions.

Preparation for disassembly

Use this information to properly prepare to disassemble and reassemble the computer.

See [Routine care, SATA drive guidelines, and disassembly preparation on page 12](#) for initial safety procedures.

1. Turn off the computer. If you are unsure whether the computer is off or in Hibernation, turn the computer on, and then shut it down through the operating system.

 **IMPORTANT:** Turn off the computer before disconnecting any cables.

Regardless of the power state, voltage is always present on the system board as long as the system is plugged into an active AC outlet. In some systems, the cooling fan is on even when the computer is in the Standby or Suspend modes. Always disconnect the power cord before servicing a unit.

2. Disconnect the power from the computer by unplugging the power cord from the computer.
3. Disconnect all external devices from the computer

 **CAUTION:** Beware of sharp edges inside the chassis.

 **NOTE:** During disassembly, label each cable as you remove it, and note its position and routing. Keep all screws with the removed components.

Head unit from stand

To remove the head unit, use these procedures and illustrations.

Before removing the head unit from the stand, follow these steps:

- Prepare the computer for disassembly (see [Preparation for disassembly on page 19](#)).

Remove the head unit from the stand:

1. Slide the cover off the top of the stand.

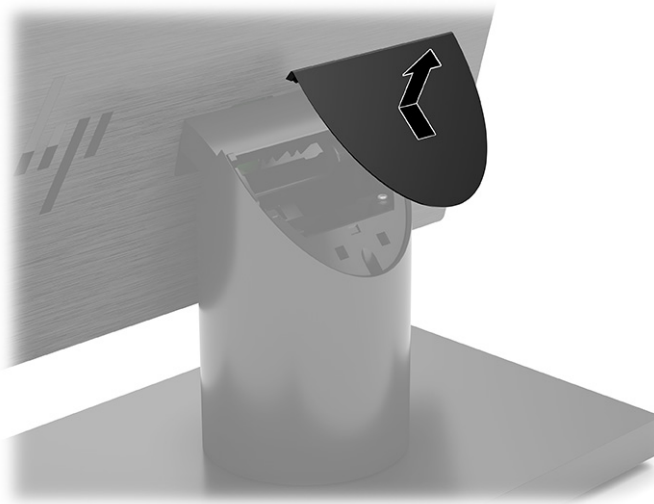

2. Remove the cable cover by squeezing the back of each side and pulling the cover toward up and off the computer (1). Disconnect the USB cable (2) and the RJ-45 cable (3) from the head unit.

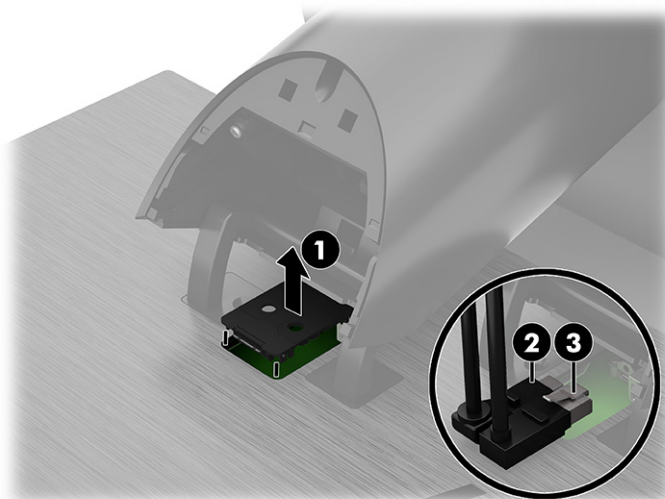

3. Remove the two screws (1) that secure the head unit to the stand, and then remove the head unit (2).

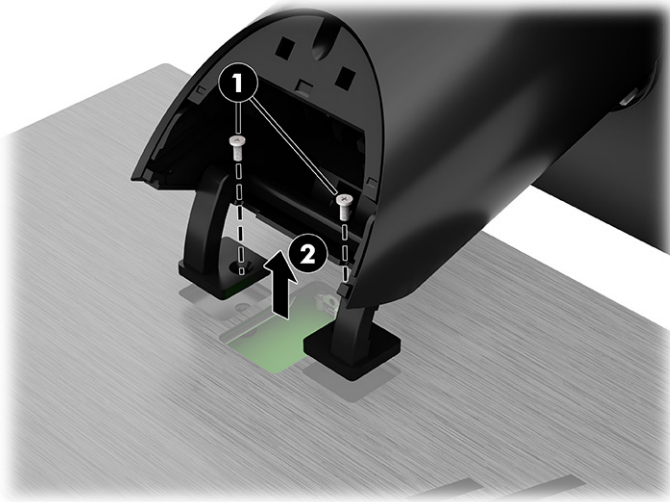

To install the head unit to the stand, reverse the removal procedure.

Back plate

To remove the back plate, use these procedures and illustration.

Before removing the back plate, follow these steps:

1. Prepare the computer for disassembly (see [Preparation for disassembly on page 19](#)).
2. Remove the head unit from the stand (see [Head unit from stand on page 19](#)).

Remove the back plate:

- Slide the back plate toward the bottom of the head unit to release it (1), and then lift the back plate off the head unit (2).

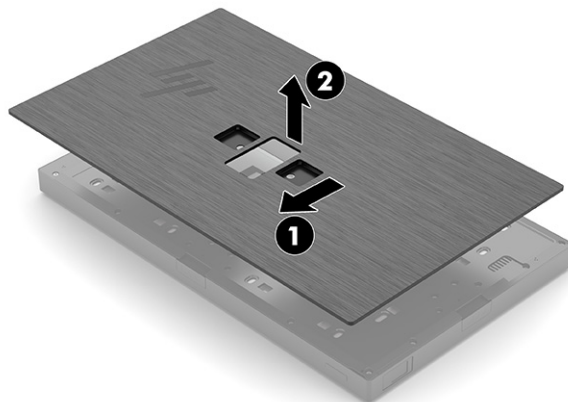

To install the back plate, reverse the removal procedures.

Integrated payment installation

To install the integrated payment option, use these procedures and illustrations.

Before installing the integrated payment option, follow these steps:

1. Prepare the computer for disassembly (see [Preparation for disassembly on page 19](#)).
2. Remove the head unit ([Head unit from stand on page 19](#)).
3. Remove the back plate ([Back plate on page 21](#)).

Install the integrated payment option:

1. Lift the cover off the payment module.

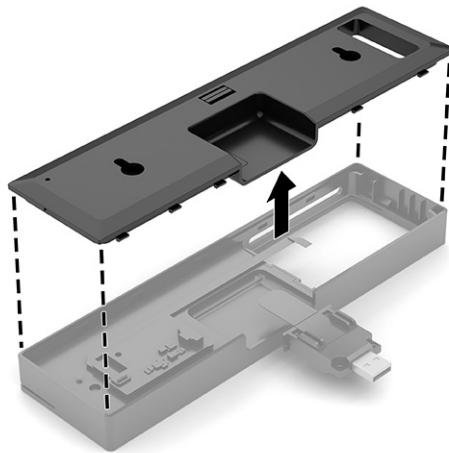

2. Insert the cost module into the payment module.

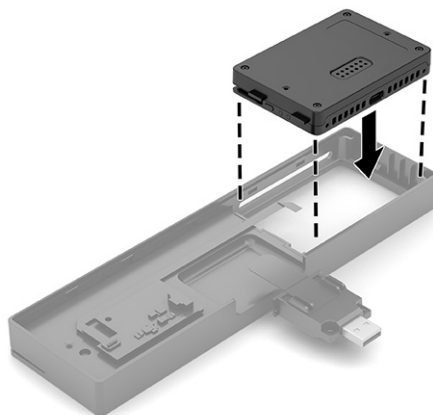

3. Insert the cover onto the payment module.

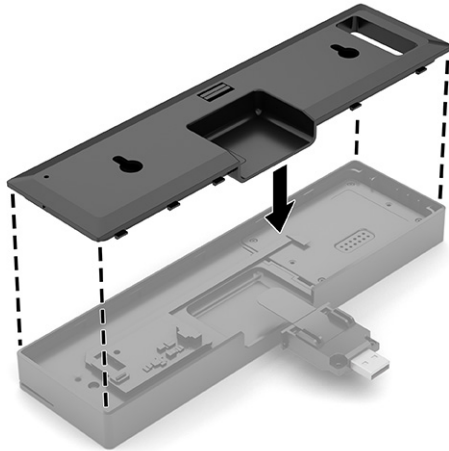

4. Insert the payment module into the head unit.

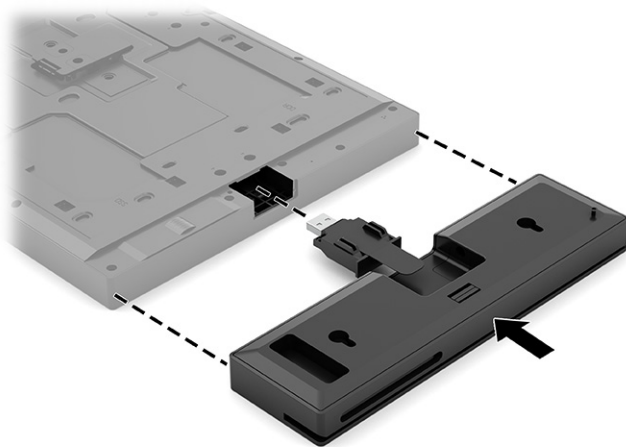

5. Place the back plate onto the computer (1) and slide it into place (2).

6. Install the screw (3).

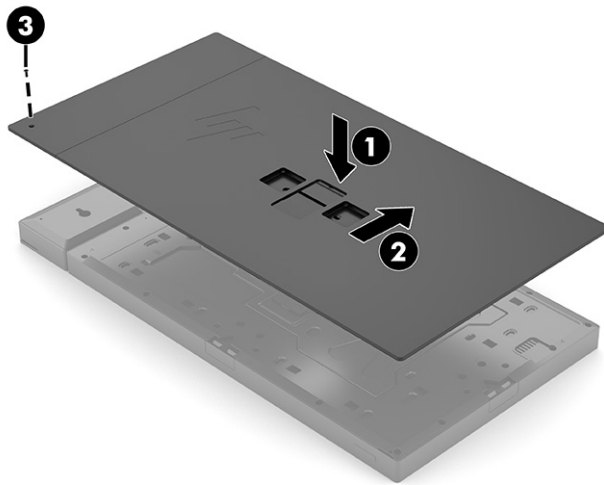

Expansion slot cover

Covers are used on empty expansion slots on each side of the head unit. To remove an expansion slot cover, use these procedures.

Before removing an expansion slot cover, follow these steps:

1. Prepare the computer for disassembly (see [Preparation for disassembly on page 19](#)).
2. Remove the head unit from the stand (see [Head unit from stand on page 19](#)).
3. Remove the back plate from the head unit (see [Back plate on page 21](#)).

Remove an expansion slot cover:

1. Remove the two Phillips screw that secure the cover to the head unit (1).
2. Slide the cover out of the head unit (2).

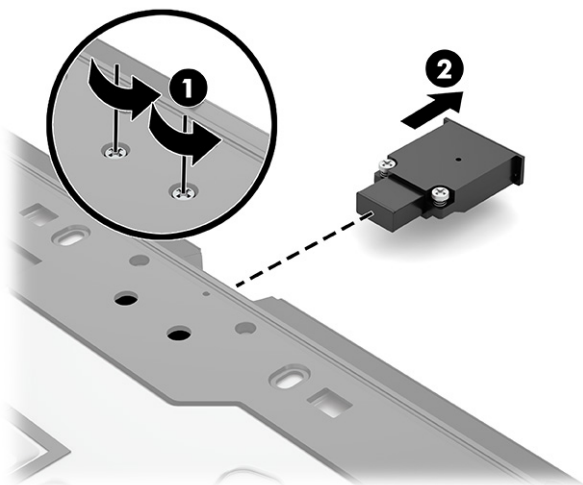

To install the expansion slot cover, reverse the removal procedure.

System board cover

To remove the system board cover, use this procedure and illustration.

Before removing the system board cover, follow these steps:

1. Prepare the computer for disassembly (see [Preparation for disassembly on page 19](#)).
2. Remove the head unit from the stand (see [Head unit from stand on page 19](#)).
3. Remove the back plate from the head unit (see [Back plate on page 21](#)).

Remove the system board cover:

1. Remove the expansion slot covers (1). See [Expansion slot cover on page 24](#) for more information.
2. Loosen the 19 captive Phillips screws that secure the cover to the head unit (2), and then lift the cover off the head unit (3).

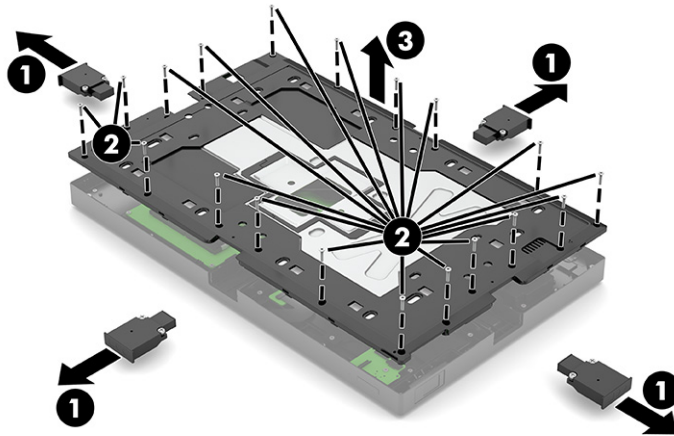

To install the system board cover, reverse the removal procedure.

Memory module (SODIMM)

To remove the memory module, use this information and these procedures.

The memory socket on the system board must be populated with one industry-standard SODIMM. To achieve the maximum memory support, you can populate the system board with up to 8 GB of memory.

Table 4-1 Memory module specifications

Component	Specification
Memory module	1.2 volt DDR4-SDRAM memory module
Compliance	Unbuffered non-ECC DDR4-3200 MHz-compliant
Pins	Industry-standard 260-pin containing the mandatory Joint Electronic Device Engineering Council (JEDEC) specification

Table 4-1 Memory module specifications (continued)

Component	Specification
Slots	1
Maximum memory	8 GB
Supported	2 Gbit, 4 Gbit, 8 Gbit, and 16 Gbit non-ECC memory technologies single-sided and double-sided memory module

NOTE: The system does not operate properly if you install an unsupported memory module. Memory modules constructed with ×8 and ×16 DDR devices are supported; memory modules constructed with ×4 SDRAM are not supported.

 **NOTE:** Memory modules support data transfer rates up to 3200 MT/s. Actual data rate is determined by system configuration.

The computer comes with one double data rate 3 synchronous dynamic random access memory (DDR4-SDRAM) small outline dual inline memory module (SODIMM). There is one SODIMM socket on the system board labeled DIMM1.

 **IMPORTANT:** You must disconnect the power cord and wait approximately 30 seconds for the power to drain before adding or removing memory modules. Regardless of the power state, voltage is always supplied to the memory modules as long as the computer is plugged into an active AC outlet. Adding or removing memory modules while voltage is present can cause irreparable damage to the memory modules or system board.

 **IMPORTANT:** When handling a memory module, be careful not to touch any of the contacts. Doing so can damage the module.

Memory module sockets have gold-plated metal contacts. When upgrading the memory, use memory modules with gold-plated metal contacts to prevent corrosion, oxidation, or both, resulting from having incompatible metals in contact with each other.

Static electricity can damage the electronic components of the computer or optional cards. Before beginning these procedures, be sure that you are discharged of static electricity by briefly touching a grounded metal object.

Before removing the memory module, follow these steps:

1. Prepare the computer for disassembly (see [Preparation for disassembly on page 19](#)).
2. Remove the head unit from the stand (see [Head unit from stand on page 19](#)).
3. Remove the back plate from the head unit (see [Back plate on page 21](#)).
4. Remove the system board cover (see [System board cover on page 25](#)).

Remove the memory module:

1. Remove the protective cover to gain access to the memory module **(1)**.
2. Spread the two retention clips outward **(2)** until the memory module tilts up at a 45° angle, and then remove the module **(3)**.

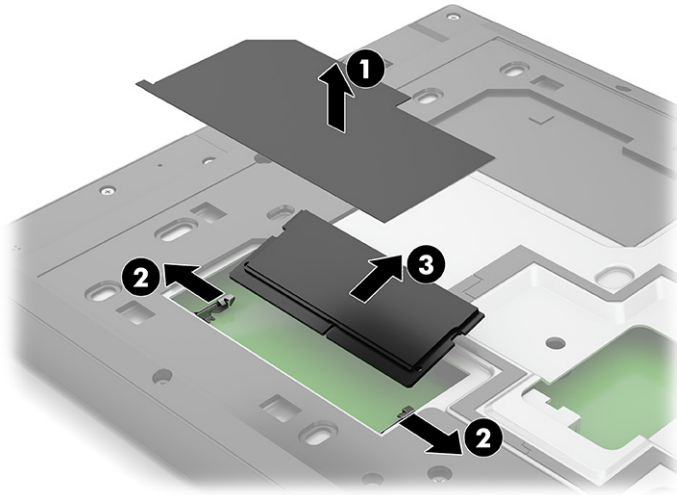

To install a memory module, reverse the removal procedure.

When you turn on the computer, it automatically recognizes additional memory.

Solid-state drive

To remove the solid-state drive, use these procedures and illustrations.

Before removing the solid-state drive, follow these steps:

1. Prepare the computer for disassembly (see [Preparation for disassembly on page 19](#)).
2. Remove the head unit from the stand (see [Head unit from stand on page 19](#)).
3. Remove the back plate from the head unit (see [Back plate on page 21](#)).
4. Remove the system board cover (see [System board cover on page 25](#)).

Remove the solid-state drive:

1. Lift the protective cover off the top of the drive (1).
2. Remove the screw that secures the drive/heat sink assembly (2).

3. Pull the assembly out of the socket (3).

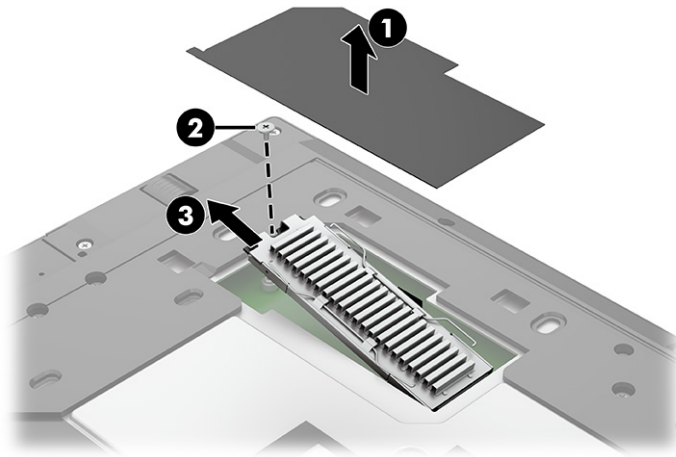

4. When replacing a solid-state drive, remove the heat sink from the old drive and install it onto the new drive. To remove the heat sink, lift the retaining arms (1), and then remove the heat sink from the top of the drive (2). Remove the drive from the bottom plate (3).

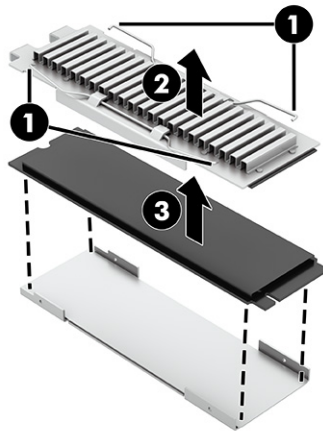

To install the solid-state drive, reverse the removal procedure.

When installing a new solid-state drive, be sure to install a thermal pad onto the top of the drive, under the heat sink.

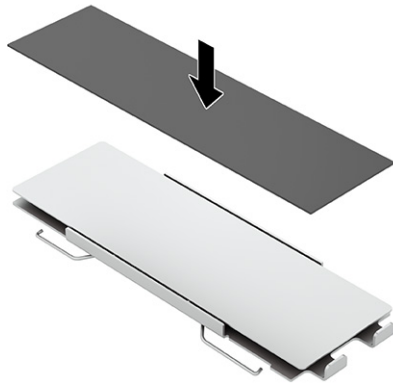

Battery

To remove the battery, use these procedures. The battery that comes with the computer provides power to the real-time clock. When replacing the battery, use a battery equivalent to the battery originally installed in the computer. The computer comes with a 3 V lithium coin cell battery.

⚠ WARNING! The computer contains an internal lithium manganese dioxide battery. There is a risk of fire and burns if the battery is not handled properly. To reduce the risk of personal injury:

Do not attempt to recharge the battery.

Do not expose to temperatures higher than 60°C (149°F).

Do not disassemble, crush, puncture, short external contacts, or dispose of in fire or water.

Replace the battery only with the HP spare part that is designated for this product.

📝 IMPORTANT: Before replacing the battery, back up the computer CMOS settings. When the battery is removed or replaced, the CMOS settings are cleared.

Static electricity can damage the electronic components of the computer or optional equipment. Before beginning these procedures, be sure that you are discharged of static electricity by briefly touching a grounded metal object.

📝 NOTE: You can extend the lifetime of the lithium battery by plugging the computer into an AC outlet. The lithium battery is used only when the computer is not connected to AC power.

HP encourages customers to recycle used electronic hardware, HP original print cartridges, and rechargeable batteries. For more information about recycling programs, go to <http://www.hp.com/recycle>.

Before removing the battery, follow these steps:

1. Prepare the computer for disassembly ([Preparation for disassembly on page 19](#)).
2. Remove the head unit from the stand (see [Head unit from stand on page 19](#)).
3. Remove the back plate from the head unit (see [Back plate on page 21](#)).
4. Remove the system board cover (see [System board cover on page 25](#)).

Remove the battery:

- Disconnect the battery cable from the system board (1), and then pull the battery off the computer (2). The battery is secured with adhesive.

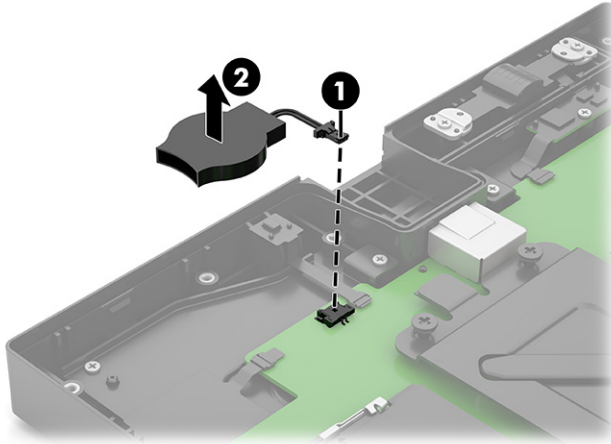

To install the battery, reverse the removal procedure.

Microphone module

To remove the microphone module, use this procedure and illustration.

Before removing the microphone module, follow these steps:

1. Prepare the computer for disassembly (see [Preparation for disassembly on page 19](#)).
2. Remove the head unit from the stand (see [Head unit from stand on page 19](#)).
3. Remove the back plate from the head unit (see [Back plate on page 21](#)).
4. Remove the system board cover (see [System board cover on page 25](#)).

Remove the microphone module:

- Disconnect the microphone module cable from the ZIF connector on the system board (1), and then remove the module from the computer (2).

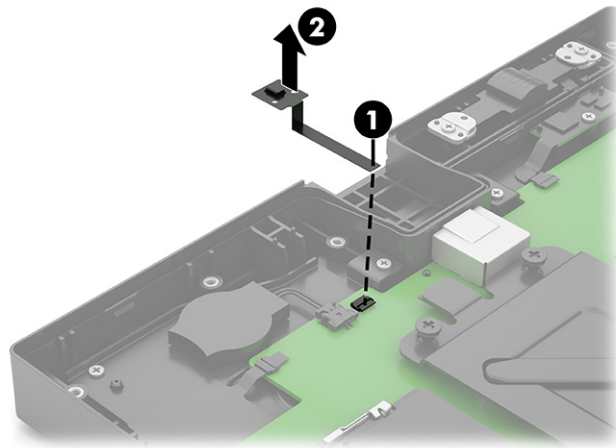

To install the microphone module, reverse the removal procedure.

Power button board

To remove the power button board, use this procedure and illustration.

Before removing the power button board, follow these steps:

1. Prepare the computer for disassembly (see [Preparation for disassembly on page 19](#)).
2. Remove the head unit from the stand (see [Head unit from stand on page 19](#)).
3. Remove the back plate from the head unit (see [Back plate on page 21](#)).
4. Remove the system board cover (see [System board cover on page 25](#)).

Remove the power button board:

1. Disconnect the fingerprint reader cable and the system board cable from the reverse ZIF connector on the power button board (1).
2. Remove the Phillips screw (2) from the board.

3. Remove the board from the computer (3).

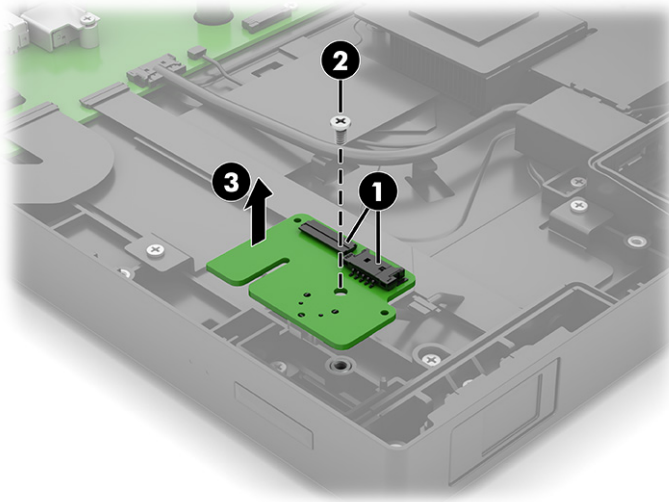

To install the power button board, reverse the removal procedure.

Left expansion slot cable

To remove the left expansion slot cable, use this procedure and illustration.

Before removing the left expansion slot cable, follow these steps:

1. Prepare the computer for disassembly (see [Preparation for disassembly on page 19](#)).
2. Remove the head unit from the stand (see [Head unit from stand on page 19](#)).
3. Remove the back plate from the head unit (see [Back plate on page 21](#)).
4. Remove the system board cover (see [System board cover on page 25](#)).

Remove the left expansion slot cable:

1. Disconnect the cable from the system board (1).
2. Remove the cable from the clips in the computer chassis (2).

3. Remove the two Phillips screws from the connector (3), and then remove the assembly from the computer (4).

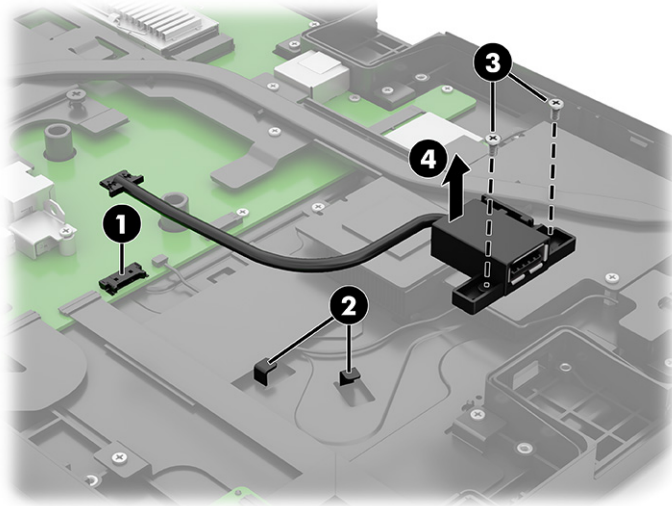

To install the left expansion slot cable, reverse the removal procedure.

NFC module

To remove the NFC module, use this procedure and illustration.

Before removing the NFC module, follow these steps:

1. Prepare the computer for disassembly (see [Preparation for disassembly on page 19](#)).
2. Remove the head unit from the stand (see [Head unit from stand on page 19](#)).
3. Remove the back plate from the head unit (see [Back plate on page 21](#)).
4. Remove the system board cover (see [System board cover on page 25](#)).

Remove the NFC module:

1. Remove the protective cover from the NFC module (1).
2. Disconnect the cables from the reverse ZIF connectors on both ends of the NFC module (2).

3. Remove the Phillips screw **(3)** that secures the module, and then remove the module from the computer **(4)**.

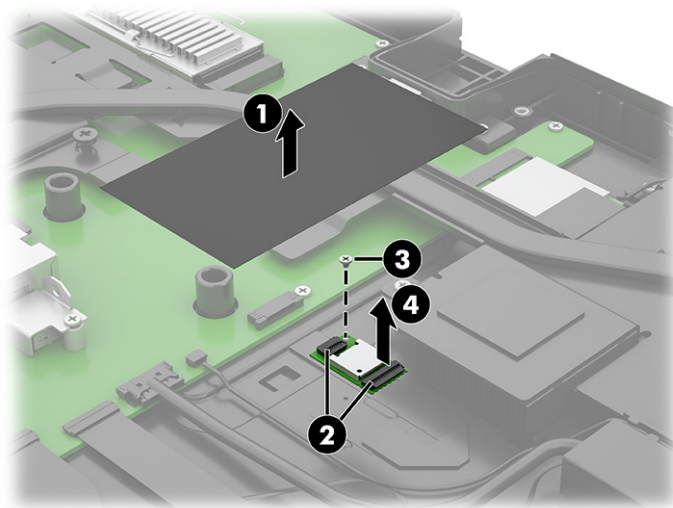

To install the NFC module, reverse the removal procedure.

WLAN module

To remove the WLAN module, use these procedures.

Before removing the WLAN module, follow these steps:

1. Prepare the computer for disassembly (see [Preparation for disassembly on page 19](#)).
2. Remove the head unit from the stand (see [Head unit from stand on page 19](#)).
3. Remove the back plate from the head unit (see [Back plate on page 21](#)).
4. Remove the system board cover (see [System board cover on page 25](#)).

Remove the WLAN module:

1. Remove the protective cover from the module **(1)**.
2. Disconnect the antenna cable from the module **(2)**.
3. Remove the Phillips screw **(3)** that secures the module to the computer.

4. Pull the module from the socket (4).

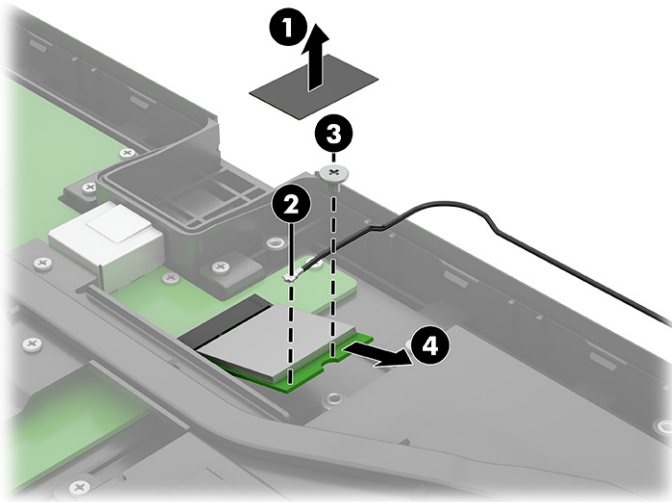

5. If the WLAN antenna is not connected to the terminal on the WLAN module, a protective sleeve must be installed on the antenna connector, as shown in the following illustration.

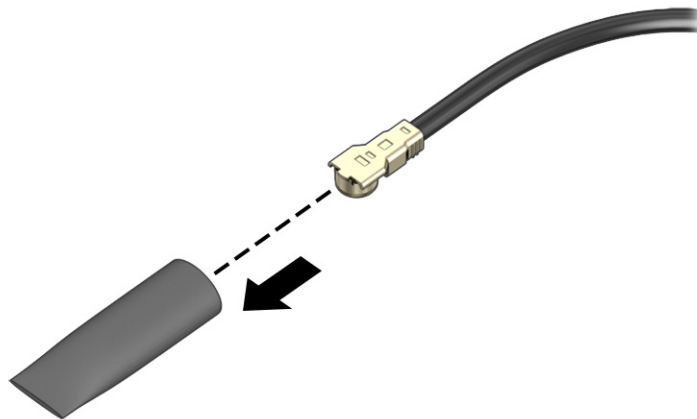

To install the WLAN module, reverse the removal procedure.

 **NOTE:** WLAN modules are designed with a notch to prevent incorrect insertion.

WLAN antenna

To remove the WLAN antenna, use this procedure and illustration.

Before removing the WLAN antenna, follow these steps:

1. Prepare the computer for disassembly (see [Preparation for disassembly on page 19](#)).
2. Remove the head unit from the stand (see [Head unit from stand on page 19](#)).

3. Remove the back plate from the head unit (see [Back plate on page 21](#)).
4. Remove the system board cover (see [System board cover on page 25](#)).

Remove the WLAN antenna:

1. Disconnect the antenna cable from the WLAN module (1).
2. Remove the cable from the clips near the bottom of the computer (2).
3. Remove the screw from the antenna (3), and then remove the antenna and cable from the computer (4).

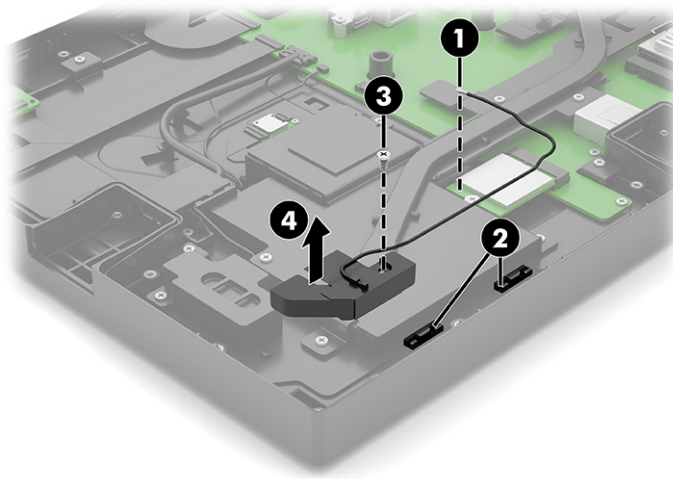

To install the WLAN antenna, reverse the removal procedure.

Speaker

To remove the speaker, use this procedure and illustration.

Before removing the speaker, follow these steps:

1. Prepare the computer for disassembly (see [Preparation for disassembly on page 19](#)).
2. Remove the head unit from the stand (see [Head unit from stand on page 19](#)).
3. Remove the back plate from the head unit (see [Back plate on page 21](#)).
4. Remove the system board cover (see [System board cover on page 25](#)).

Remove the speaker:

1. Remove the two Phillips screws from the speaker (1).
2. Remove the speaker cable from the clips in the computer chassis (2).
3. Disconnect the speaker cable from the system board (3).

4. Remove the speaker from the computer (4).

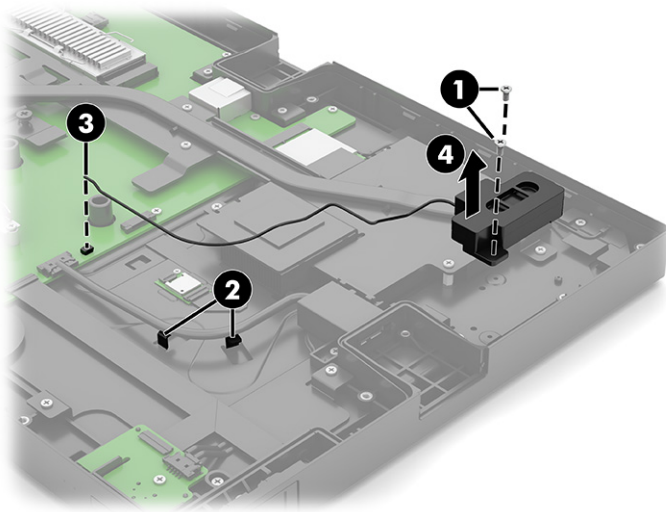

To install the speaker, reverse the removal procedure.

Processor heat sink

To remove the processor heat sink, use these procedures.

Before removing the processor heat sink, follow these steps:

1. Prepare the computer for disassembly (see [Preparation for disassembly on page 19](#)).
2. Remove the head unit from the stand (see [Head unit from stand on page 19](#)).
3. Remove the back plate from the head unit (see [Back plate on page 21](#)).
4. Remove the system board cover (see [System board cover on page 25](#)).

Remove the processor heat sink:

1. Remove the six Phillips screws (1).
2. Loosen the four captive Phillips screws (2).
3. Remove the heat sink from the computer (3).

 **IMPORTANT:** For optimum thermal performance, be sure not to touch the thermal grease on the surface of the processor or the heat sink.

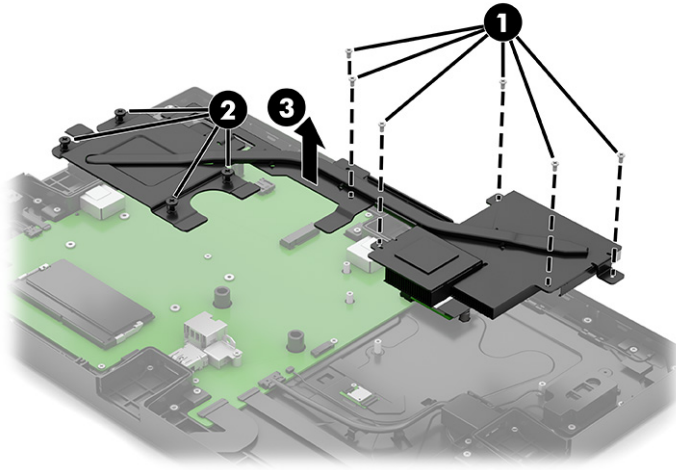

4. Thoroughly clean the thermal material from the surfaces of the heat sink and the system board components each time the heat sink is removed. Replacement thermal material is included with the heat sink and system board spare part kits.

To replace the heat sink, reverse the removal procedures.

Magnetic stripe reader

To remove the magnetic stripe reader, use this procedure and illustration.

Before removing the magnetic stripe reader, follow these steps:

1. Prepare the computer for disassembly (see [Preparation for disassembly on page 19](#)).
2. Remove the head unit from the stand (see [Head unit from stand on page 19](#)).
3. Remove the back plate from the head unit (see [Back plate on page 21](#)).
4. Remove the system board cover (see [System board cover on page 25](#)).

Remove the magnetic stripe reader:

1. Disconnect the cable from the reverse ZIF connector on the system board **(1)**.
2. Remove the Phillips screw **(2)** from the board.
3. Remove the two Phillips screws **(3)** from the reader.
4. Remove the bracket from each side (top and bottom) of the reader **(4)**.

5. Lift the seal (5), and then remove the assembly by pulling the board toward the reader and out from under the seal (6).

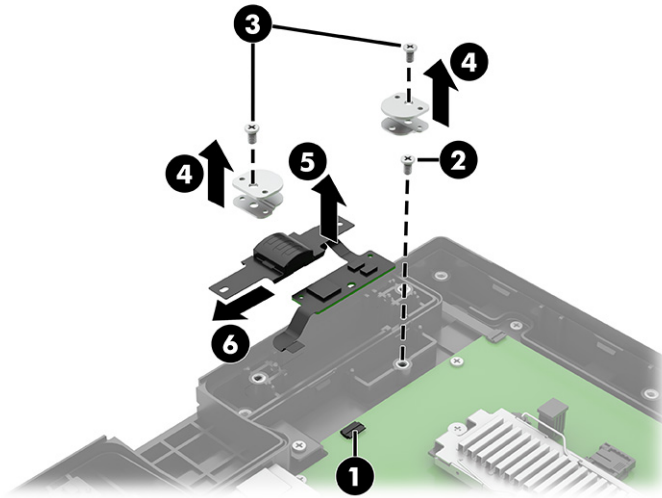

To install the magnetic stripe reader, reverse the removal procedure.

Fingerprint reader

To remove the fingerprint reader, use this procedure and illustration.

Before removing the fingerprint reader, follow these steps:

1. Prepare the computer for disassembly (see [Preparation for disassembly on page 19](#)).
2. Remove the head unit from the stand (see [Head unit from stand on page 19](#)).
3. Remove the back plate from the head unit (see [Back plate on page 21](#)).
4. Remove the system board cover (see [System board cover on page 25](#)).

Remove the fingerprint reader:

1. Disconnect the fingerprint reader cable from the power button board (1).
2. Remove the two Phillips screws (2) from the plastic bracket, and then remove the bracket from the computer (3).

3. Remove the fingerprint reader and cable from the computer **(4)**.

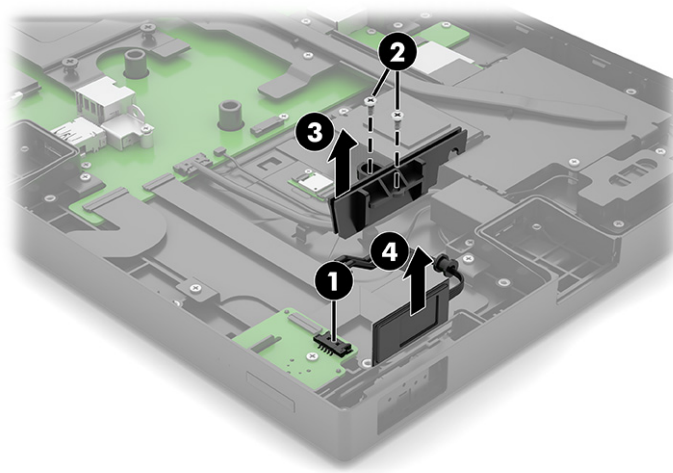

To install the fingerprint reader, reverse the removal procedure.

System board

To remove the system board, use this procedure and illustration.

Before removing the system board, follow these steps:

1. Prepare the computer for disassembly (see [Preparation for disassembly on page 19](#)).
2. Remove the head unit from the stand (see [Head unit from stand on page 19](#)).
3. Remove the back plate from the head unit (see [Back plate on page 21](#)).
4. Remove the system board cover (see [System board cover on page 25](#)).
5. Remove the memory module (see [Memory module \(SODIMM\) on page 25](#)).
6. Remove the solid-state drive (see [Solid-state drive on page 27](#)).
7. Remove the WLAN module (see [WLAN module on page 34](#)).
8. Remove the heat sink (see [Processor heat sink on page 37](#)).

Remove the system board:

1. Disconnect the following cables from the system board:
 - (1) Magnetic stripe reader LED cable (reverse ZIF)
 - (2) Magnetic stripe reader board cable (reverse ZIF)
 - (3) Microphone module cable (reverse ZIF)
 - (4) Battery cable
 - (5) Touch cable (reverse ZIF)
 - (6) NFC module cable
 - (7) Speaker cable

- (8) Left expansion slot cable
- (9) Power button board cable (reverse ZIF)
- (10) Display cable

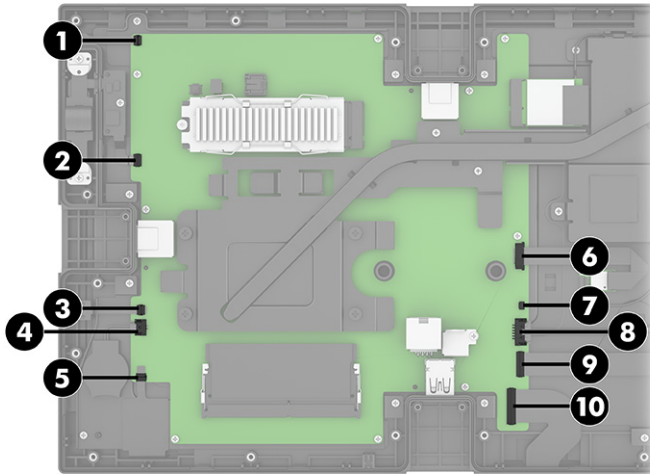

2. Remove the 10 Phillips screws from the board (1).
3. Lift the system board straight up and out of the computer (2).

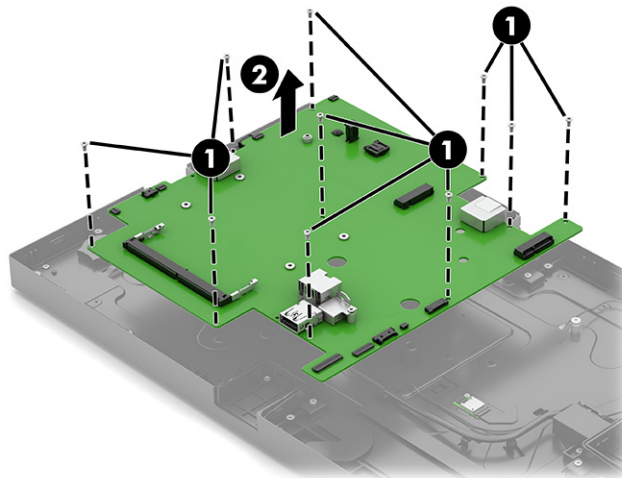

To install the system board, reverse the removal procedure.

NOTE: When replacing the system board, you must change the chassis serial number in the BIOS.

When replacing the system board, you must reprogram the SMBIOS information about the affected computer. Failure to reprogram the board will result in eventual failure, such as an activation failure (when you would have to reactivate the computer) or a system recovery failure.

Update the SMBIOS information in Computer Setup.

5 Configuring the software

You can configure the computer and integrated peripherals and calibrate the touch screen.

Configuring the powered serial ports on the Advanced Stand or Advanced Swivel Stand

You can configure the serial ports as standard (unpowered) serial ports or powered serial ports. Some devices use a powered serial port. If the serial port is configured as a powered port, devices that support a powered serial interface do not require an external power source.



NOTE: The Advanced Stand and Advanced Swivel Stand ships with all serial ports configured in standard unpowered serial mode (0 volts) by default.

Each serial port has three voltage settings.

- 0 volts
- 5 volts
- 12 volts

To change the voltage settings for each powered serial port:

1. Turn on or restart the computer, quickly press **esc**, and then press **f10**.
2. Select **Configuration**.
3. Select the Power Serial Port Voltage by changing the output voltage to 0V, 5V, or 12V.
4. Select **Exit**, and then select **Save Changes and Exit** to save your settings.

Touch screen calibration for Windows 10 Professional and Windows 10 IoT Enterprise for Retail

The Windows calibration tool works only in digitizer touch mode. If you install a retail touch utility, it sets the touch screen to mouse mode by default and does not allow the Windows calibration tool to run.

To calibrate the touch module in Windows 10 Professional and Windows 10 IoT Enterprise for Retail:

1. Open Control Panel. You can type **Control Panel** in the Search box to access it.
2. In Control Panel, type **calibrate** in the Search box. Under **Tablet PC Settings**, tap the **Calibrate the screen for pen or touch input** link. In the Tablet PC Settings dialog box, tap the **Calibrate** button, and then proceed to step 3.
3. Follow the on-screen instructions to press the target marks on the touch screen. At the end of the calibration process, the touch module should be aligned with the video, and the touch points will be accurate.

Configuring optional HP integrated peripheral modules

Use this information to configure peripheral modules.

To configure the integrated USB peripheral, see the HP Point of Sale Configuration Guide (available in English only). The guide is located with the documentation on your retail computer and at <http://www.hp.com/support>. To access the guide on the retail computer, select **Start**, and then select **HP Point of Sale Information**.



NOTE: Check <http://www.hp.com/support> for updated software or documentation that became available between the time your product was manufactured and the time it was delivered to you.

Updating the system

Use these sections to update the system.

Downloading HP Firmware Installer

Use these steps to download the firmware installation app.

1. Go to <http://www.hp.com/support>.
2. Select **Software and Drivers**, and follow the on-screen instructions to find your docking station.
3. Follow the on-screen instructions to select and download **HP Firmware Installer**.
4. Complete the installation wizard.
5. Choose to restart now or later. The computer might not work until the next restart. Select **Finish**.

Installing updates

You can update the system immediately or the next time it is shut down.

To install updates:

1. Open Windows Explorer, and navigate to where you saved HP Firmware Installer.
2. Double-click **HPFirmwareInstaller.exe**, and then select **OK**.
3. Verify that updates are available, select which updates to install, and then select **Install**.



TIP: You must be connected to the internet for new updates to download to HP Firmware Installer.

4. Select one of the following options:
 - **Shut down now:** Installs the update immediately.



NOTE: You might see the display flicker and hear some audio clicks, your internet connection might be intermittent, and your mouse and keyboard could become unresponsive until installation is complete.

- **Close and shut down later:** Installs the update the next time you shut down the computer.

The computer turns on automatically after the firmware update is complete.

6 Computer Setup (F10) Utility

This information provides details of the Computer Setup Utility.

- Change settings from the defaults or restore the settings to default values.
- View the system configuration, including settings for processor, graphics, memory, audio, storage, communications, and input devices.
- Modify the boot order of bootable devices such as hard drives or USB flash media devices.
- Enter the Asset Tag or property identification number assigned by the company to this computer.
- Enable the power-on password prompt during system restarts (warm boots) as well as during startup.
- Establish an administrator password that controls access to the Computer Setup (F10) Utility and the settings described in this section.
- Establish minimum requirements for valid passwords, including length and required types of characters.
- Secure integrated I/O functionality, including the serial, USB, or audio, or embedded NIC, so that they cannot be used until they are unsecured.
- Enable or disable different types of boot sources.
- Configure features such as Secure Boot, power management, virtualization support, and language and keyboard type used in Setup and POST.
- Replicate the system setup by saving system configuration information about a USB device and restoring it on one or more computers.
- Enable or disable DriveLock security or securely erase a hard drive (when supported by drive).

Using Computer Setup (F10) Utilities

You can access Computer Setup only by turning the computer on or restarting the system.

To access the Computer Setup Utilities menu, complete these steps:

1. Turn on or restart the computer.
2. Repeatedly press **f10** when the power button light turns white to access the utility.

You can also press **esc** to see a menu that allows you to access different options available at startup, including the Computer Setup utility.

A choice of four headings appears in the Computer Setup Utilities menu: Main, Security, Advanced, and UEFI Drivers.

 **NOTE:** If you do not press **f10** at the appropriate time, you must restart the computer and again repeatedly press **f10** when the power button light turns white to access the utility.

 **NOTE:** Selecting UEFI Drivers restarts the computer into the third-party option ROM management application. You can access this application directly by pressing **f3** during startup.

3. Use the arrow (left and right) keys to select the appropriate heading. Use the arrow (up and down) keys to select the option you want, and then press **enter**. To return to the Computer Setup Utilities menu, press **esc**.
4. To apply and save changes, select **Main > Save Changes and Exit**.
 - If you have made changes that you do not want applied, select **Ignore Changes and Exit**.
 - To restore settings from the Advanced and Main menus to original values, select **Apply Factory Defaults and Exit**.
 - To restore settings from the Advanced and Main menus to those previously saved by **Save Custom Defaults**, select **Apply Custom Defaults and Exit**. If no custom defaults have been saved, then factory defaults are used.

 **NOTE:** You cannot modify settings in the Security menu by selecting **Apply Defaults**. You reset those values by selecting **Restore Security Settings to Factory Defaults** at the bottom of the **Security** menu.

 **NOTE:** Not all settings shown in the following sections are available for all models.

 **IMPORTANT:** Do not turn computer power off while the BIOS is saving the Computer Setup (F10) changes because the settings could become corrupted. It is safe to turn off the computer only after exiting the F10 Setup screen.

Computer Setup Main

This table provides information about the Computer Setup Main menu.

 **NOTE:** Support for specific Computer Setup options can vary, depending on the hardware configuration.

Table 6-1 Computer Setup Main

Option	Description
System Information	Lists all information in following list if Advanced System Information is selected. Lists smaller subset if Basic System Information is selected. <ul data-bbox="507 331 911 1688" style="list-style-type: none"><li data-bbox="507 331 679 359">• Product name<li data-bbox="507 380 746 407">• Installed memory size<li data-bbox="507 428 687 455">• Processor type<li data-bbox="507 476 831 504">• Processor cache size (L1/L2/L3)<li data-bbox="507 525 699 552">• Processor speed<li data-bbox="507 573 719 600">• MicroCode revision<li data-bbox="507 621 724 648">• Processor stepping<li data-bbox="507 669 687 697">• Memory speed<li data-bbox="507 718 879 745">• DIMM size (for each installed module)<li data-bbox="507 766 735 793">• System BIOS version<li data-bbox="507 814 836 842">• ME Firmware version (Intel only)<li data-bbox="507 863 719 890">• Video BIOS version<li data-bbox="507 911 762 938">• Reference code revision<li data-bbox="507 959 791 987">• Super I/O firmware version<li data-bbox="507 1008 911 1035">• USB Type-C® controller firmware version<li data-bbox="507 1056 667 1083">• Born on date<li data-bbox="507 1104 679 1131">• Serial number<li data-bbox="507 1152 667 1180">• SKU number<li data-bbox="507 1201 863 1228">• UUID (Universally Unique Identifier)<li data-bbox="507 1249 751 1276">• Asset tracking number<li data-bbox="507 1297 667 1325">• Feature byte<li data-bbox="507 1346 619 1373">• Build ID<li data-bbox="507 1394 683 1421">• Product family<li data-bbox="507 1442 699 1470">• System board ID<li data-bbox="507 1491 775 1518">• System board CT number<li data-bbox="507 1539 651 1566">• Panel type<li data-bbox="507 1587 730 1614">• Panel serial number<li data-bbox="507 1635 762 1663">• Integrated MAC Address

Table 6-1 Computer Setup Main (continued)

Option	Description
System Diagnostics	<p>If the hard drive has the HP Advanced Diagnostics installed, the application launches. If HP Advanced Diagnostics is not installed, then a basic version that is built into the BIOS provides the capability to perform the following functions:</p> <ul style="list-style-type: none"><li data-bbox="528 359 695 386">• Memory Test<li data-bbox="528 411 727 438">• Hard Drive Check<li data-bbox="528 464 667 491">• Language
BIOS Event Log	<p>View BIOS Event Log</p> <p>Displays a list of events, alerts, or warnings that have been logged since the log was last cleared.</p> <p>Export to USB Key</p> <p>Saves a file named BiosEventLog.txt containing the log entries to an inserted USB storage device.</p> <p>Clear BIOS Event Log on Next Boot</p> <p>When selected, the BIOS clears the event log when the user saves and exits. Default is disabled.</p>

Table 6-1 Computer Setup Main (continued)

Option	Description
Update System BIOS	<p>Lets you update the system BIOS from www.hp.com or another network server, from a removable USB drive, or from a file located on the hard drive.</p> <p>Check [current selection] for BIOS Updates</p> <p>The string that appears here depends on the setting in BIOS Update Preferences.</p> <p>Lock BIOS Version</p> <p>If this option is selected, the system is locked to the current BIOS version, and updates are not allowed.</p> <p>Native OS Firmware Update Service</p> <p>Allows the operating system to drive firmware updates (for example, Windows Update).</p> <p>BIOS Rollback Policy</p> <ul style="list-style-type: none">■ Unrestricted Rollback to older BIOS: Lets you roll back to any previous version of BIOS.■ Restricted Rollback to older BIOS: If selected, Minimum BIOS Version becomes active, which lets you manually enter the minimum BIOS version that you can roll back to. <p>Minimum BIOS Version</p> <p>Defaults to current version. Read-only unless restricted rollback is selected.</p> <p>Allow BIOS Updates Using a Network</p> <p>Lets you configure scheduled, automatic BIOS updates through the network.</p> <p>BIOS Update Preferences</p> <ul style="list-style-type: none">■ Check for Update on Next Reboot: Default is disabled.■ BIOS Source: Lets you select either HP.com or a custom URL. If Custom URL is selected, Edit Custom URL becomes active. HP recommends using a custom URL only for a managed IT environment. <p>Automatic BIOS Update Setting</p> <p>Allows configuration of a periodic check for updates:</p> <p>NOTE: If Microsoft® Windows® BitLocker Drive Encryption (BDE) is enabled, it must be temporarily suspended before the BIOS is flashed.</p> <ul style="list-style-type: none">■ Do not update■ Checking for updates and prompt the user to accept or reject the update at that time■ Checking for updates and install all new versions■ Checking for updates and install only new versions marked important <p>BIOS Update Frequency</p> <ul style="list-style-type: none">■ Daily■ Weekly■ Monthly (default) <p>Network Configuration Settings</p> <p>Lets you configure the network connection to the server that is the host for system firmware updates.</p> <p>Update BIOS Using Local Media</p> <p>Lets you access files on either USB storage or the hard drive. The HP BIOS Update and Recovery application included in BIOS Softpaqs at www.hp.com copies the BIOS file to the correct location on the hard drive or USB device.</p>

Table 6-1 Computer Setup Main (continued)

Option	Description
Change date and time	Lets you update system date and time.
System IDs	Lets you set the following values: <ul style="list-style-type: none"> • Asset Tracking Number • Ownership Tag
Replicated Setup	<p>Backup current settings to USB device</p> <p>Saves system configuration to a formatted USB flash media device.</p> <p>Restore current settings from USB device</p> <p>Restores system configuration from a USB flash media device.</p>
Save Custom Defaults	Saves the current system configuration settings as the custom default set.
Apply Custom Defaults and Exit	Applies the custom default settings to the computer after rebooting. Does not apply to options in the Security menu.
Apply Factory Defaults and Exit	Restores the factory system configuration settings to the computer after rebooting. Does not apply to options in the Security menu.
Ignore Changes and Exit	Exits Computer Setup without applying or saving any changes.
Save Changes and Exit	Saves changes to current system configuration, exits Computer Setup, and reboots.

Computer Setup Security

This table provides information about the Computer Setup Security menu.



NOTE: Support for specific Computer Setup options can vary, depending on the hardware configuration.

Table 6-2 Computer Setup Security

Option	Description
Create BIOS Administrator Password	<p>Lets you set and enable a BIOS administrator password, which controls access to the following features:</p> <ul style="list-style-type: none"> • Setup Menu (F10) • Third Party Option ROM Management (F3) • Update system ROM • WMI commands that change system settings • BIOS Configuration Utility (BCU) • Alternative power-on password <p>NOTE: Creating a BIOS user disables the Fast Boot option.</p>
Change BIOS Administrator Password (This selection is active only if a BIOS administrator password is set.)	<p>Lets you change the BIOS administrator password.</p> <p>You must know the current password to be able to change it.</p>

Table 6-2 Computer Setup Security (continued)

Option	Description
Create POST Power-On Password	Lets you change or delete power-on password. The power-on password prompt appears after a power cycle or reboot. If the user does not enter the correct power-on password, the unit will not boot.
Change POST Power-On Password (This selection is active only if a BIOS administrator password is set.)	Lets you change the POST power-on password. You must know the current password to be able to change it.
Password Policies	Let you set the guidelines for a valid password. Options include: <ul style="list-style-type: none">• Password minimum length• Requires at least one symbol• Requires at least one number• Requires at least one uppercase character• Requires at least one lowercase character• Allow spaces
Administrator Authentication Policies	Lets you set limitations on some boot features restricting them to admin only, including: <ul style="list-style-type: none">• Prompt for administrator authorization to access:<ul style="list-style-type: none">– Boot menu in POST– System Recovery– Network boot– BIOS update• Allow the use of administrator credentials to modify the power-on password.

Table 6-2 Computer Setup Security (continued)

Option	Description
Security Configuration	TPM Embedded Security
	<ul style="list-style-type: none"> • TPM Specification Version
	Displays the current TPM version.
	<ul style="list-style-type: none"> • TPM Device
	Lets you set the Trusted Platform Module as available or hidden. Default is available.
	<ul style="list-style-type: none"> • TPM State
	Select to enable the TPM. Default is disabled.
	<ul style="list-style-type: none"> • Clear TPM
	Select to reset the TPM to an unowned state. After the TPM is cleared, it is also turned off. To temporarily suspend TPM operations, turn the TPM off instead of clearing it. Default is no.
	<p>IMPORTANT: Clearing the TPM resets it to factory defaults and turns it off. You will lose all created keys and data protected by those keys.</p>
	<ul style="list-style-type: none"> • TPM Activation Policy
	<ul style="list-style-type: none"> ○ F1 to boot
	<ul style="list-style-type: none"> ○ Allow user to reject (default)
	<ul style="list-style-type: none"> ○ No prompts
	BIOS Sure Start
	<ul style="list-style-type: none"> • Verify Boot Block on every boot: Select to enable HP Sure Start. Default is disabled.
	<ul style="list-style-type: none"> • BIOS Data Recovery Policy: Select Automatic or Manual to determine data recovery process. Manual recovery is intended only for situations when you want forensic analysis before HP Sure Start recovery. When this policy is set to manual, HP Sure Start will not correct any issues that are found until the local user enters the manual recovery key sequence. This can result in a computer that cannot boot until the manual recovery key sequence is entered.
	<ul style="list-style-type: none"> • Network Controller Configuration Restore: Select to restore the network controller parameters to the factory state saved in the HP Sure Start Private nonvolatile (flash) memory. This setting is available only on computers with built-in NIC.
	<p>NOTE: This process can take up to 30 seconds. You need to restore this only when the Network Controller Configuration mismatch warning is set.</p>
	<ul style="list-style-type: none"> • Dynamic Runtime Scanning of Boot Block: Verifies the integrity of the BIOS boot block region several times each hour while the computer is running. Default is enabled.
	<ul style="list-style-type: none"> • Sure Start BIOS Settings Protection: When enabled, HP Sure Start locks all critical BIOS settings and provides enhanced protection for these settings using nonvolatile (flash) memory. Default is off.
	<p>NOTE: An administrator password must be set to activate this setting.</p>
	<ul style="list-style-type: none"> • Sure Start Secure Boot Keys Protection: Saves a backup copy of Secure Boot Keys so that they can be recovered if someone attempts to alter them in an unauthorized manner.
	<ul style="list-style-type: none"> • Enhanced HP Firmware Runtime Intrusion Prevention and Detection: Enables monitoring of HP system firmware executing out of main memory while the operating system is running. Any anomalies detected in HP system firmware that is active while the operating system is running will result in a Sure Start security event being generated.
	<ul style="list-style-type: none"> • Sure Start Security Event Policy. Controls HP Sure Start behavior upon identifying a critical security event (any modification to HP firmware) while the operating system is running.
	<ul style="list-style-type: none"> – Log Event Only: HP Sure Start will log all critical security events in the HP Sure Start audio log within the HP Sure Start nonvolatile (flash) memory.
	<ul style="list-style-type: none"> – Log Event and notify user: In addition to logging all critical security events, HP Sure Start will notify the user within the operating system that a critical event has occurred.
	<ul style="list-style-type: none"> – Log Event and power off system: In addition to logging all critical security events, HP Sure Start turns of the computer upon detecting a HP Sure Start Security Event. Because of the potential

Table 6-2 Computer Setup Security (continued)

Option	Description
Utilities	<p data-bbox="497 256 671 287">Hard Drive Utilities</p> <ul style="list-style-type: none"> <li data-bbox="497 310 1444 415"> <p data-bbox="497 310 903 342">● Save/Restore GPT of System Hard Drive</p> <p data-bbox="544 359 1430 415">Enabling this feature saves the GUID Partition Table (GPT) of the system hard drive. If the GPT is subsequently changed, the user is prompted to choose whether to restore GPT. Default is disabled.</p> <li data-bbox="497 436 1444 510"> <p data-bbox="497 436 852 468">● Boot Sector (GPT) Recovery Policy</p> <p data-bbox="544 485 1107 510">Allows selection of the default action when a GPT event occurs.</p> <li data-bbox="497 531 1444 888"> <p data-bbox="497 531 831 562">● DriveLock/Automatic DriveLock</p> <p data-bbox="544 579 1430 684">Allows you to assign or modify a master or user password for hard drives. When this feature is enabled, the user is prompted to provide one of the DriveLock passwords during POST. If neither is successfully entered, the hard drive remains inaccessible until one of the passwords is successfully provided during a subsequent cold-boot sequence.</p> <p data-bbox="544 709 1430 766">NOTE: This selection appears only when at least one drive that supports the DriveLock feature is attached to the system.</p> <p data-bbox="544 783 1390 810">IMPORTANT: Be aware that these settings take place immediately. It is not necessary to save.</p> <p data-bbox="544 831 1382 888">IMPORTANT: Be sure to document the DriveLock password. Losing a DriveLock password will render a drive permanently locked.</p> <p data-bbox="544 909 1444 961">NOTE: Disable DriveLock on NVMe drives before using applications for hardware-based encryption. After you select a drive, the following options are available:</p> <ul style="list-style-type: none"> <li data-bbox="544 982 1430 1010">- Set DriveLock Master Password. Sets the drive's master password but does not enable DriveLock. <li data-bbox="544 1031 1203 1058">- Enable DriveLock. Sets the drive's user password and enables DriveLock. <li data-bbox="497 1079 1444 1262"> <p data-bbox="497 1079 671 1110">● Secure Erase</p> <p data-bbox="544 1127 979 1155">Lets you select a hard drive to completely erase.</p> <p data-bbox="544 1176 1444 1262">After you erase a hard drive with a program that uses Secure Erase firmware commands, no file recovery program, partition recovery program, or other data recovery method can extract data from the drive.</p> <li data-bbox="497 1283 1444 1465"> <p data-bbox="497 1283 919 1314">● Allow OPAL Hard Drive SID Authentication</p> <p data-bbox="544 1331 1444 1465">BIOS supports drive encryption using the DriveLock feature by creating the storage device's ownership key. If BIOS creates the key, any 3rd party applications (including other encryption software) are not allowed to perform certain drive operations such as establishing their own key using SID. Encryption software applications may or may not be limited by SID authentication lockout depending on how they are designed. Default is disabled.</p>
Absolute Persistence Module Current State	<p data-bbox="497 1476 1038 1503">Shows the current state of the Absolute Persistence module.</p> <p data-bbox="497 1524 624 1551">Yes: Disabled</p> <p data-bbox="497 1572 624 1600">No: Available</p>
System Management Command	<p data-bbox="497 1623 1355 1650">Allows authorized personnel to reset security settings during a service event. Default is enabled.</p>
Restore Security Settings to Factory Default	<p data-bbox="497 1696 1444 1759">This action resets security devices, clears BIOS passwords (not including DriveLock), and restores settings in the Security menu to factory defaults.</p>

Computer Setup Advanced

This table provides information about the Computer Setup Advanced menu.



NOTE: Support for specific Computer Setup options can vary, depending on the hardware configuration.

Table 6-3 Computer Setup Advanced (for advanced users)

Option	Heading
Display Language	Lets you select the language of the menus in F10 Setup and the keyboard layout.
Scheduled Power-On	This feature wakes the system when it is off at a specified date and time.

Table 6-3 Computer Setup Advanced (for advanced users) (continued)

Option	Heading
Boot Options	<p>Select the devices that the computer can boot from, as well as other options, including:</p> <ul style="list-style-type: none">• Startup Delay (sec): Enabling this feature adds a user-specified delay to the POST process. One purpose for the delay is to provide additional time to activate hotkeys such as esc for the Startup Menu or f10 for Computer Setup.• Fast Boot: Default is enabled.• CD-ROM Boot (select products only): Default is enabled.• USB Storage Boot: Default is enabled.• Network (PXE) Boot: Default is enabled.• After Power Loss: Default is Power Off.<ul style="list-style-type: none">■ Power off: Causes the computer to remain off when power is restored.■ Power on: Causes the computer to turn on automatically as soon as power is restored.■ Previous state: Causes the computer to turn on automatically as soon as power is restored, if it was on when power was lost. <p>NOTE: If the system is configured to Power On from Keyboard Ports (see Power Management Options), then this setting is forced to Power On.</p> <ul style="list-style-type: none">• Prompt on Memory Size Change: Default is enabled.• Prompt on Fixed Storage Change: Default is disabled.• Audio Alerts During Boot: Default is enabled. When disabled, most audible beeps from errors, warnings, and password prompts during boot up are suppressed.• Numlock on at boot: Default is disabled.• UEFI Boot Order: Specify the order in which UEFI boot sources are checked for a bootable operating system image. The default boot order is:<ol style="list-style-type: none">1. USB2. SATA DVD3. SATA hard drives4. M.2 devices5. Network boot <p>NOTE: Use the UP and DOWN arrows to highlight an item. Press enter to select. Use the UP and DOWN arrows to move a selected item. Press f5 to enable or disable. Press esc to exit.</p> <p>NOTE: MS-DOS drive lettering assignments might not apply after a non-MS-DOS operating system has started.</p> <p>Shortcut to Temporarily Override Boot Order</p> <p>To boot one time from a device other than the default device specified in Boot Order, restart the computer and press esc (to access the Startup menu) and then f9 (Boot Menu), or only f9 (skipping the Startup menu) when the power button light turns white. After POST is completed, a list of bootable devices is displayed. Use the arrow keys to select the preferred bootable device and press enter. The computer then boots from the selected non-default device for this one time.</p>

Table 6-3 Computer Setup Advanced (for advanced users) (continued)

Option	Heading
HP Sure Recover	<p data-bbox="528 264 676 285">HP Sure Recover</p> <p data-bbox="528 312 1461 386">If enabled and HP Sure Recover is launched, the system firmware honors local and remote requests to reinstall the operating system. If it is disabled, all requests to reinstall the operating system are ignored. Default is enabled.</p> <p data-bbox="528 413 730 434">Recover from Network</p> <p data-bbox="528 462 1426 512">Allows system firmware to retrieve the recovery agent from the network. If disabled, system firmware retrieves the recovery agent from a local drive. Default is enabled.</p> <p data-bbox="528 539 759 560">Recover after Boot Failure</p> <p data-bbox="528 588 1441 638">If enabled and no bootable UEFI operating system is found, system firmware launches HP Sure Recover. Default is disabled.</p> <p data-bbox="528 665 858 686">Recover before Boot Failure Recovery</p> <p data-bbox="528 714 1436 787">If enabled and HP Sure Recover is launched because of a boot failure, the user is notified of the boot failure and asked to choose whether to start or cancel HP Sure Recover. This setting is displayed only if Recover after Boot Failure is selected.</p> <p data-bbox="528 814 671 835">Recovery Agent</p> <p data-bbox="528 863 1394 913">Displays recovery agent information. This information is displayed only if Recover from Network is selected.</p> <p data-bbox="528 940 671 961">Recovery Image</p> <p data-bbox="528 989 1399 1039">Displays recovery image information. This information is displayed only if Recover from Network is selected.</p> <p data-bbox="528 1066 775 1087">OS Recovery Image Version.</p> <p data-bbox="528 1115 1461 1165">Display the version of the recovery image stored in the embedded secure storage device. This information is displayed only if an embedded secure storage device is installed.</p> <p data-bbox="528 1192 770 1213">OS Recovery Driver Version</p> <p data-bbox="528 1241 1461 1291">Display the version of the recovery driver stored in the embedded secure storage device. This information is displayed only if an embedded secure storage device is installed.</p>

Table 6-3 Computer Setup Advanced (for advanced users) (continued)

Option	Heading
System Options	Configure storage controller for Intel Optane (Intel products only)
	Enables the Intel® Optane™ memory module.
	Configure storage controller for RAID
	Enables RAID. Default is enabled.
	Limit PCIe Speed (workstation models only)
	Lets you restrict the maximum speed of the PCI Express devices to previous generations. The following settings are possible:
	- Auto
	- Gen 1 (2.5 Gbps)
	- Gen 2 (5 Gbps)
	- Gen 3 (8 Gbps)
	Turbo-boost (Intel products only)
	Allows Intel Turbo Boost Technology to improve performance when operation conditions allow. Default is enabled.
	Hyperthreading (Intel products only)
	Lets you control processor capability. Default is enabled.
	Virtualization Technology (VTx) (Intel only)
	Controls the virtualization features of the processor. Changing this setting requires turning the computer off and then back on. Default is disabled.
	Virtualization Technology for Directed I/O (VTd) (Intel only)
	Controls virtualization DMA remapping features of the chipset. Changing this setting requires turning the computer off and then back on. Default is disabled.
	SVM CPU Virtualization (AMD® products only)
	Enables AMD-V and AMD-Vi virtualization features on AMD-based systems
	Enhanced Hello Sign-in (systems with supporting hardware for biometric identification only)
Allows for secure logon using the Windows Hello feature.	
DMA Protection	
Enables DMA redirection using IOMMU for enhanced security. Default is enabled.	
NOTE: Requires that VTd is enabled.	
Pre-boot DMA protection	
Secures memory access through DMA to allowed regions prior to operating system startup.	
Full encryption of main memory (DRAM) (select products only)	
Stores all data to DRAM in an encrypted format. Default is enabled.	
PCI slots (vary by product)	
Lets you enable or display PCI slots. Default is enabled.	
M.2 slots (vary by product)	
Lets you enable or display M.2 slots. Default is enabled.	
Power Button Override (disable/4 sec/15 sec/30 sec)	
Lets you enable and select the number of seconds you have to hold down the power button for it to force the system to turn off. Default is 4 sec.	

Table 6-3 Computer Setup Advanced (for advanced users) (continued)

Option	Heading
Built-In Device Options	<p data-bbox="528 260 951 281">Embedded LAN Controller (select products only)</p> <p data-bbox="528 310 1139 331">Select to show the device in the operating system. Default is enabled.</p> <p data-bbox="528 361 647 382">Wake On LAN</p> <p data-bbox="528 411 1425 457">Lets you either disable the Wake On LAN feature or configure where the computer boots, including the network or hard drive. Default is boot to network.</p> <p data-bbox="528 487 967 508">LAN Controller Option (1)(2) (select products only)</p> <p data-bbox="528 537 1198 558">Enables the integrated network controller in the designated rear option slot.</p> <p data-bbox="528 588 815 609">Dust Filter (select products only)</p> <p data-bbox="528 638 699 659">Default is disabled.</p> <p data-bbox="528 688 967 709">Dust Filter Reminder (Days) (select products only)</p> <p data-bbox="528 739 647 760">Default is 60.</p> <p data-bbox="528 789 1110 810">Allow No Panel configuration (All-in-One 1000 series models only)</p> <p data-bbox="528 837 1307 858">Allows operation of the base unit without a boot warning when the panel is not installed.</p> <p data-bbox="528 888 956 909">Integrated Video (models with discrete graphics)</p> <p data-bbox="528 938 1453 984">Disables the integrated video device. When not using integrated video, disabling the integrated video will free some system memory.</p> <p data-bbox="528 1014 956 1035">VGA Boot Device (models with discrete graphics)</p> <p data-bbox="528 1064 1442 1110">Selects the graphics controller to use as the primary VGA device during boot-up when there are multiple graphics devices. The firmware can use only one graphics device when booting up.</p> <p data-bbox="528 1140 699 1161">Video Memory Size</p> <p data-bbox="528 1190 1453 1236">Lets you manage graphics memory allocation. The value you choose is allocated permanently to graphics and is unavailable to the operating system.</p> <p data-bbox="528 1266 695 1287">Integrated Camera</p> <p data-bbox="528 1316 1046 1337">Lets you disable the integrated camera. Default is enabled.</p> <p data-bbox="528 1367 644 1388">Audio Device</p> <p data-bbox="528 1417 1461 1505">Select to show audio devices in the operating system, including integrated microphone, internal speakers, and headphone out. When selected, operating system visibility of each audio device is controlled independently. When this setting is cleared, all audio devices are hidden from the operating system. Individual audio device settings are also disabled. Default is enabled.</p> <p data-bbox="528 1535 636 1556">Microphone</p> <p data-bbox="528 1585 1442 1656">Clear to disable the integrated microphone. This does not affect devices plugged into audio jacks. The disable and lock setting prevents other audio ports from being remapped to the microphone function in the operating system. Default is enabled.</p> <p data-bbox="528 1686 995 1707">Internal Speakers (does not affect external speakers)</p> <p data-bbox="528 1736 1437 1782">Clear to disable the chassis speaker or speakers. This function is applicable to normal audio playback in the operating system and does not affect the error or warning beeps during POST. Default is enabled.</p> <p data-bbox="528 1812 699 1833">Headphone Output</p> <p data-bbox="528 1862 1016 1883">Clear to disable the headphone jack. Default is enabled.</p> <p data-bbox="528 1913 919 1934">Collaboration Buttons (select products only)</p> <p data-bbox="528 1963 1067 1984">Clear to disable the collaboration buttons. Default is enabled.</p> <p data-bbox="528 2013 882 2034">Button Sensitivity (select products only)</p> <p data-bbox="528 2064 1275 2085">Controls touch sensitivity of collaboration buttons. Select from low, medium, or high.</p>

Table 6-3 Computer Setup Advanced (for advanced users) (continued)

Option	Heading
Port Options	<p data-bbox="507 262 751 287">USB ports (varies by model)</p> <p data-bbox="507 312 979 338">Lets you enable specific USB ports. Default is enabled.</p> <p data-bbox="507 363 735 388">USB Legacy Port Charging</p> <p data-bbox="507 413 1378 459">Lets you enable USB charging port capability when the computer is in hibernate or shutdown mode. Default is enabled.</p> <p data-bbox="507 485 810 510">USB Type-C Downstream Charging</p> <p data-bbox="507 535 1378 581">Lets you enable USB charging port capability when the computer is in hibernate on or off. Default is enabled.</p> <p data-bbox="507 606 788 632">Media Card Reader/SD_RDR USB</p> <p data-bbox="507 657 1315 682">Enables the media card reader connector (labeled SD_RDR) on a desktop. Default is enabled.</p> <p data-bbox="507 707 707 732">SATA (varies by model)</p> <p data-bbox="507 758 1246 783">Lets you hide SATA ports from the operating system. Default is enabled (not hidden).</p> <p data-bbox="507 808 756 833">Serial Port (varies by model)</p> <p data-bbox="507 858 995 884">Lets you enable specific serial ports. Default is enabled.</p> <p data-bbox="507 909 1160 934">Serial Port Voltage (Retail Point-of-Sale models only; ports vary by model)</p> <p data-bbox="507 959 1442 1005">Lets you configure powered serial port voltage selection on RPOS units that include this feature. Default is 0 Volts.</p> <ul data-bbox="507 1031 628 1157" style="list-style-type: none"><li data-bbox="507 1031 616 1056">• 0 Volts<li data-bbox="507 1081 616 1106">• 5 Volts<li data-bbox="507 1131 628 1157">• 12 Volts <p data-bbox="507 1182 963 1207">Cash Drawer Port (Retail Point-of-Sale models only)</p> <p data-bbox="507 1232 1166 1257">Controls whether the cash drawer port can be activated. Default is enabled.</p> <p data-bbox="507 1283 687 1308">Restrict USB Devices</p> <p data-bbox="507 1333 1011 1358">Specify the following categories of USB devices to enable:</p> <ul data-bbox="507 1383 895 1509" style="list-style-type: none"><li data-bbox="507 1383 820 1409">• Allow all USB devices (default)<li data-bbox="507 1434 836 1459">• Allow only keyboard and mouse<li data-bbox="507 1484 895 1509">• Allow all but storage devices and hubs. <p data-bbox="507 1535 1426 1619">When some devices are restricted, the system will disable USB ports that do not meet the allowed criteria. This feature is usually combined with similar policies within the operating system because USB devices can be moved to different ports. The ports disabled by the BIOS remain disabled until the system is restarted.</p>

Table 6-3 Computer Setup Advanced (for advanced users) (continued)

Option	Heading
Power Management Options	Runtime Power Management
	Allows certain operating systems to reduce processor voltage and frequency when the current software load does not require the full capabilities of the processor. Default is enabled.
	Extended Idle Power States
	Allows certain operating systems to decrease the processors power consumption when the processor is idle. Default is enabled.
	S5 Maximum Power Savings
	Enabling this feature reduces the power of the system as much as possible in the S5 state. Power is removed from the wake up circuitry, the expansion slots, and any management features while in S5. Default is disabled.
	SATA Power Management
	Enables or disables SATA bus, device power management, or both. Default is enabled.
	PCI Express Power Management
	Enabling this option permits the PCI Express links to use Active Power State Management (ASPM) to enter lower power states while not in use. Default is enabled.
	Power On from Keyboard Ports
When enabled, this feature allows a key press to turn on the system when it is off (S5 state). If using a USB keyboard, you must plug it into one of the rear ports labeled with the keyboard icon. Default is disabled.	
Unique Sleep State Blink Rates	
This feature is designed to provide a visual indication of what Sleep state the system is in. Each Sleep state has a unique blink pattern. Default is disabled.	
NOTE: A normal shutdown goes to the S4 state for Windows 8 or later.	
S0 (On) = solid white light.	
S3 (Stand By) = 3 blinks at 1 Hz (50% duty cycle) followed by a pause of 2 seconds (white light), repeated cycles of 3 blinks and a pause.	
S4 (Hibernation) = 4 blinks at 1 Hz (50% duty cycle) followed by a pause of 2 seconds (white light), repeated cycles of 4 blinks and a pause.	
S5 (Soft Off) = Light is off.	

Table 6-3 Computer Setup Advanced (for advanced users) (continued)

Option	Heading
Remote Management Options (Intel only)	Active Management Technology (AMT)
	Allows you to discover, repair, and protect networked computing devices. Default is enabled.
	USB Key Provisioning Support
	Enables AMT provisioning using a USB storage device. Default is disabled.
	USB Redirection Support
	USB redirection allows USB devices plugged into a client computer to be transparently redirected to the guest operating system. Default is enabled.
	Unconfigure AMT on next boot. Resets AMT configuration options on next boot. Default is Do Not Apply.
	SOL Terminal Emulation Mode
	SOL (serial-over-LAN) terminal emulation mode is only activated during remote AMT (Active Management Technology) redirection operations. The emulation options allow administrators to select which mode works best with their console. Default is ANSI.
	Show Unconfigure ME Confirmation Prompt
	Requires user confirmation when unconfiguring the Intel Management Engine. Default is enabled.
	Verbose Boot Messages
Verbose boot shows additional logging information during startup, which is mainly for debugging if something goes wrong during bootup. Default is enabled.	
Watchdog Timer	
Allows you to set amount of time for a operating system and BIOS watchdog alert to be sent if the timers are not deactivated. BIOS watchdog is deactivated by BIOS and would indicate that a halt occurred during execution if the alert is sent to the management console. An operating system alert is deactivated by the operating system image and would indicate that a hang occurred during its initialization. Default is enabled.	
<ul style="list-style-type: none">• OS Watchdog Timer (min.). Default is 5 min.• BIOS Watchdog Timer (min.). Default is 5 min.	
CIRA Timeout (min.)	
CIRA is Customer Initiated Remote Assistance, an Intel service to help users employing Active Management Technology (AMT). Default is 1.	

Table 6-3 Computer Setup Advanced (for advanced users) (continued)

Option	Heading
Thunderbolt Options (select products only)	Thunderbolt Mode
	Enables Thunderbolt™ connections on the Type-C port. When cleared, disables Thunderbolt connections on the Type-C port and disables PCIe tunneling on USB4 connections.
	Require BIOS PW to change Thunderbolt Security Level
	When selected, Thunderbolt Security Level cannot be changed unless a BIOS administrator password has been created. This setting cannot be disabled if DMA Protection (System Options) is enabled.
	Thunderbolt Security Level
	<ul style="list-style-type: none">• PCIe and DisplayPort – No Security: Any Thunderbolt device detected that requests a PCI-express connection is connected to the system PCI-express bus without approval by the local user.• PCIe and DisplayPort – User Authorization (default): Each Thunderbolt peripheral includes a unique identifier used to determine if the device has been previously connected. If the user previously-selected Always Connect for a device, it is automatically connected to the PCI-Express bus when attached.• PCIe and DisplayPort – Secure Connect: Offers enhanced protection for authenticating a previously-connected Thunderbolt device beyond relying on its identifier. The device is provisioned with a key when initially connected, and on subsequent connections a challenge-response is implemented to verify the device before it is connected to the PCI-express bus.• DisplayPort only: Permits only USB and DisplayPort™ functionality to be available via the Type-C Thunderbolt port. PCI-Express will not be connected from the Thunderbolt device to the internal PCI-express interface, thus any Thunderbolt device that requires PCI-Express will not function correctly.
	Native PCIe Hot Plug
	Enables hot plug support to the system PCI-Express bus.
Remote HP PC Hardware Diagnostics	Settings
	Sets the configuration for Remote HP PC Hardware Diagnostics, including the URLs used for download and upload and scheduled execution frequency.
	Execute Remote HP PC Hardware Diagnostics
	Select to immediately execute Remote HP PC Hardware Diagnostics based on the how settings are configured. Any unsaved BIOS settings will be lost.

7 POST error messages

This section lists the error codes, error messages, and the various indicator light and audible sequences that you may encounter during Power-On Self-Test (POST) or computer restart, the probable source of the problem, and steps you can take to resolve the error condition.

POST Message Disabled suppresses most system messages during POST, such as memory count and non-error text messages. If a POST error occurs, the screen will display the error message. To manually switch to the POST Messages Enabled mode during POST, press any key (except **f10**, **f11**, or **f12**). The default mode is POST Message Disabled.

The POST mode selection determines the speed at which the computer loads the operating system and the extent to which it is tested.

Quick Boot is a fast startup process that does not run all of the system level tests, such as the memory test. Full Boot runs all of the ROM-based system tests and takes longer to complete.

You can enable Full Boot to run every 1 to 30 days on a regularly scheduled basis. To establish the schedule, reconfigure the computer to the Full Boot Every x Days mode, using Computer Setup.

 **NOTE:** For more information about Computer Setup, see [Computer Setup \(F10\) Utility on page 44](#).

POST numeric codes and text messages

This section identifies those POST errors that have numeric codes associated with them. The section also includes some text messages that you might encounter during POST.

 **NOTE:** The computer beeps once after a POST text message is displayed on the screen.

Table 7-1 POST numeric codes and text messages

Control panel message	Description	Recommended action
002-Option ROM Checksum Error	System ROM or expansion board option ROM checksum.	<ol style="list-style-type: none">1. Verify the correct ROM.2. Flash the ROM if needed.3. If an expansion board was recently added, remove it to see if the problem remains.4. Clear CMOS.5. If the message disappears, there might be a problem with the expansion card.6. Replace the system board.
003-System Board Failure	DMA or timers.	<ol style="list-style-type: none">1. Clear CMOS.2. Replace the system board.

Table 7-1 POST numeric codes and text messages (continued)

Control panel message	Description	Recommended action
005-Real-Time Clock Power Loss	Invalid time or date in configuration memory. RTC (real-time clock) battery might need to be replaced.	Reset the date and time under Control Panel (Computer Setup can also be used). If the problem persists, replace the RTC battery. See the Removal and Replacement section for instructions on installing a new battery.
008-Microcode Patch Error	Processor is not supported by the BIOS.	<ol style="list-style-type: none"> 1. Upgrade BIOS to proper version. 2. Change the processor.
009-PMM Allocation Error during MEBx Download	Memory error during POST execution of the Management Engine (ME) BIOS Extensions option ROM.	<ol style="list-style-type: none"> 1. Reboot the computer. 2. Unplug the power cord, reseat the memory modules, and reboot the computer. 3. If the memory configuration was recently changed, unplug the power cord, restore the original memory configuration, and reboot the computer. 4. If the error persists, replace the system board.
00A-Product Information Not Valid	The product information programmed into the system board is missing or invalid.	Use Computer Setup to update this information.
00B-MEBx Module did not checksum correctly	Memory error during POST execution of the Management Engine (ME) BIOS Extensions option ROM.	<ol style="list-style-type: none"> 1. Reboot the computer. 2. Unplug the power cord, reseat the memory modules, and reboot the computer. 3. If the memory configuration was recently changed, unplug the power cord, restore the original memory configuration, and reboot the computer. 4. If the error persists, replace the system board.
00C-PMM Deallocation Error during MEBx Cleanup	Memory error during POST execution of the Management Engine (ME) BIOS Extensions option ROM.	<ol style="list-style-type: none"> 1. Reboot the computer. 2. Unplug the power cord, reseat the memory modules, and reboot the computer. 3. If the memory configuration was recently changed, unplug the power cord, restore the original memory configuration, and reboot the computer. 4. If the error persists, replace the system board.

Table 7-1 POST numeric codes and text messages (continued)

Control panel message	Description	Recommended action
00D-Setup Error during MEBx Execution	MEBx selection or exit resulted in a setup failure.	<ol style="list-style-type: none"> 1. Reboot the computer. 2. Unplug the power cord, reseal the memory modules, and reboot the computer. 3. If the memory configuration was recently changed, unplug the power cord, restore the original memory configuration, and reboot the computer. 4. If the error persists, replace the system board.
00E-Inventory Error during MEBx Execution	BIOS information passed to the MEBx resulted in a failure.	<ol style="list-style-type: none"> 1. Reboot the computer. 2. If the error persists, update to the latest BIOS version. 3. If the error still persists, replace the system board.
00F-Interface Error during MEBx Execution	MEBx operation experienced a hardware error during communication with the ME.	<ol style="list-style-type: none"> 1. Reboot the computer. 2. If the error persists, update to the latest BIOS version. 3. If the error still persists, replace the system board.
100-Front Audio Not Connected	Front audio cable has been detached or unseated from system board.	Reconnect or replace front audio cable.
2E1-MemorySize Error	Memory amount has changed since the last boot (memory added or removed).	The system memory size is different from the last startup. The most common reason is the removal of memory from the system board. Press the f1 key to save the memory changes.
2E2-Memory Error	Memory module configuration failed during boot up.	<ol style="list-style-type: none"> 1. Be sure that memory modules are correctly installed. 2. Verify proper memory module type. 3. Remove and replace the identified faulty memory modules. 4. If the error persists after replacing memory modules, replace the system board.
2E3-Incompatible Memory Module in Memory Socket(s) X, X, ...	A memory module in memory socket identified in the error message is missing critical SPD information, or is incompatible with the chipset.	<ol style="list-style-type: none"> 1. Verify proper memory module type. 2. Try another memory socket. 3. Replace with a supported module.
2E4-DIMM Configuration Warning	Populated DIMM Configuration is not optimized.	Rearrange the DIMMs so that each channel has the same amount of memory.

Table 7-1 POST numeric codes and text messages (continued)

Control panel message	Description	Recommended action
2E5-ECC Memory Module Detected on Unsupported Platform	Recently added memory modules support ECC memory error correction.	<ol style="list-style-type: none"> 1. If additional memory was recently added, remove it to see if the problem remains. 2. Check product documentation for memory support information.
2E6-Memory Not Configured Correctly for Proper MEBx Execution	DIMM1 is not installed.	Be sure that a memory module in the DIMM1 socket and that it is properly seated.
300-Configuration Change Warning	A change in storage configuration has been detected (see Boot Options menu in BIOS Setup to enable this feature). Either the installed hardware has changed, storage or firmware mode might have been changed, or a storage device might have failed to respond.	If no changes were made before this warning, check that the drives are connected properly to power cables and system board. User Diagnostics (F2 during boot-up) might help identify any problem with specific devices.
301-Hard Disk 1: SMART Hard Drive Detects Imminent Failure	Hard drive will soon fail. (Some hard drives have a hard drive firmware patch that will fix an erroneous error message.)	<ol style="list-style-type: none"> 1. Determine whether hard drive is giving correct error message. Run the Drive Protection System test under using F2 Diagnostics when booting the computer. 2. Apply hard drive firmware patch if applicable. (Available at http://www.hp.com/support.) 3. Back up contents and replace hard drive.
302-Hard Disk 2: SMART Hard Drive Detects Imminent Failure	Hard drive will soon fail. (Some hard drives have a hard drive firmware patch that will fix an erroneous error message.)	<ol style="list-style-type: none"> 1. Determine whether hard drive is giving correct error message. Run the Drive Protection System test under using F2 Diagnostics when booting the computer. 2. Apply hard drive firmware patch if applicable. (Available at http://www.hp.com/support.) 3. Back up contents and replace hard drive.
309 – 30C: Hard Disk 3–6: SMART Hard Drive Detects Imminent Failure	Hard drive will soon fail. (Some hard drives have a hard drive firmware patch that will fix an erroneous error message.)	<ol style="list-style-type: none"> 1. Determine whether hard drive is giving correct error message. Run the Drive Protection System test under using F2 Diagnostics when booting the computer. 2. Apply hard drive firmware patch if applicable. (Available at http://www.hp.com/support.) 3. Back up contents and replace hard drive.
3F0-Boot Device Not Found	Boot device not found.	Insert boot device or load operating system.

Table 7-1 POST numeric codes and text messages (continued)

Control panel message	Description	Recommended action
3F1–Hard Disk 1 Error	Hard disk 1 error.	<ol style="list-style-type: none"> 1. Check and/or replace cables. 2. Clear CMOS. 3. Replace the hard disk drive.
3F2–Hard Disk 2 Error	Hard disk 2 error.	<ol style="list-style-type: none"> 1. Check and/or replace cables. 2. Clear CMOS. 3. Replace the hard disk drive.
400–Serial Port A Address Conflict Detected	Both external and internal serial ports are assigned to the same resources.	<ol style="list-style-type: none"> 1. Remove any serial port expansion cards. 2. Clear CMOS. 3. Reconfigure card resources and/or run Computer Setup or Windows utilities.
401–Serial Port B Address Conflict Detected	Both external and internal serial ports are assigned to the same resources.	<ol style="list-style-type: none"> 1. Remove any serial port expansion cards. 2. Clear CMOS. 3. Reconfigure card resources and/or run Computer Setup or Windows utilities.
402–Serial Port C Address Conflict Detected	Both external and internal serial ports are assigned to the same resources.	<ol style="list-style-type: none"> 1. Remove any serial port expansion cards. 2. Clear CMOS. 3. Reconfigure card resources and/or run Computer Setup or Windows utilities.
403–Serial Port D Address Conflict Detected	Both external and internal serial ports are assigned to the same resources.	<ol style="list-style-type: none"> 1. Remove any serial port expansion cards. 2. Clear CMOS. 3. Reconfigure card resources and/or run Computer Setup or Windows utilities.
419–Out of Memory Space for Option ROMs	Recently added PCI expansion card contains an option ROM too large to download during POST.	If a PCI expansion card was recently added, remove it to see if the problem remains.
41A–Front USB1/USB2 Not Connected	Front USB cable has been detached or unseated from system board.	Reconnect or replace front USB cable.
41B–Device in PCI Express Slot Failed To Initialize	There is an incompatibility or problem with a PCIe device and the system or PCIe link could not be configured to a valid bus width or speed.	Try rebooting the system. If the error reoccurs, the device might not work with this system
43A–USB Type-C I2C Not Connected	Cable is required between I2C on card and USB-C on the system board.	Install cable between I2C on card and USB-C on the system board.
43B–More Than One USB type-C Cards Are Installed	More than one USB type-C card is installed.	Remove USB type-C card so only one is installed.

Table 7-1 POST numeric codes and text messages (continued)

Control panel message	Description	Recommended action
500–BIOS Recovery	A system BIOS recovery has occurred.	Not applicable.
70x–Wireless Mode Not Supported	The system has detected a wireless module installed in the system that is not supported and has been disabled.	Replace with a supported module.
800–Keyboard Error	Keyboard failure.	<ol style="list-style-type: none"> 1. Reconnect keyboard with computer turned off. 2. Check connector for bent or missing pins. 3. Be sure that none of the keys are pressed. 4. Replace keyboard.
801–Keyboard or System Unit Error	Keyboard failure.	<ol style="list-style-type: none"> 1. Reconnect the keyboard with computer turned off. 2. Be sure that none of the keys are pressed. 3. Replace the keyboard. 4. Replace the system board.
900–CPU Fan Not Detected	CPU fan is not connected or might have malfunctioned.	<ol style="list-style-type: none"> 1. Reseat fan. 2. Reseat fan cable. 3. Replace fan.
901–Chassis, Rear Chassis, Front Chassis, or PCIe blower Fan not Detected	Fan is not connected or might have malfunctioned.	<ol style="list-style-type: none"> 1. Reseat fan. 2. Reseat fan cable. 3. Replace fan.
904–SATA Cabling Error	One or more SATA devices are improperly attached. For optimal performance, the SATA 0, SATA 1, and SATA 2 ports should be used for hard drives before other ports.	Be sure that SATA connectors are used in ascending order. For one device, use SATA 0. For two devices, use SATA 0 and SATA 1. For three devices, use SATA 0, SATA 1, and SATA 2.
90B–Fan Failure	The system has detected that a cooling fan is not operating correctly.	<ol style="list-style-type: none"> 1. Reseat fan. 2. Reseat fan.cable. 3. Replace fan.
90D–System Temperature	Thermal shutdown occurred. The system BIOS has detected that your machine was previously shut down to avoid overheating. Overheating might occur if the cooling vents are blocked or the operating temperature exceeds the system specifications. The machine should return to normal operation once the situation is resolved.	Be sure system has proper airflow.
90E–Power Supply Fan Not detected	Power supply fan is not connected or might have malfunctioned.	<ol style="list-style-type: none"> 1. Reseat power supply fan. 2. Reseat fan cable. 3. Replace power supply fan.

Table 7-1 POST numeric codes and text messages (continued)

Control panel message	Description	Recommended action
910—Filter Warning	Airflow filter is dirty.	Replace the airflow filter.
911—Graphics Module Fan Not Detected	Graphics card fan is not connected or might have malfunctioned.	<ol style="list-style-type: none"> 1. Reseat graphics card fan. 2. Reseat fan cable. 3. Replace graphics card fan.
912—Incorrect CPU cooler installed for this configuration	The processor cooler/heat sink does not match processor power requirement.	Replace the cooler/heat sink to match the processor power requirement.

Interpreting POST diagnostic front panel lights and audible codes

This section identifies the front panel light codes as well as the audible codes that can occur before or during POST that might not have an error code or text message associated with them.

⚠ CAUTION: When the computer is plugged into an AC power source, voltage is always applied to the system board. To reduce the risk of personal injury from electrical shock and/or hot surfaces, be sure to disconnect the power cord from the AC outlet and allow the internal system components to cool before touching.

During the system validation phase that occurs at system startup, the BIOS validates the functionality of the following subsystems and conditions:

- AC adapter
- System board power
- Processor failure
- BIOS corruption
- Memory failure
- Graphics failure
- System board failure
- BIOS authentication failure

If an error is detected, specific patterns of long and short blinks, accompanied by long and short beeps (where applicable) are used to identify the error. These patterns make up a two-part code:

- Major: The category of the error
- Minor: The specific error within the category

📄 NOTE: Single beep and blink codes are not used.

Table 7-2 Beep pattern error identification

Number of long beeps/blinks	Error category
1	Not used
2	BIOS

Table 7-2 Beep pattern error identification (continued)

Number of long beeps/blinks	Error category
3	Hardware
4	Thermal
5	System board

Patterns of blink/beep codes are determined by using the following parameters:

- 1 second pause occurs after the last major blink.
- 2 second pause occurs after the last minor blink.
- Beep error code sequences occur for the first five iterations of the pattern and then stop.
- Blink error code sequences continue until the computer is unplugged or the power button is pressed.



NOTE: Not all diagnostic lights and audible codes are available on all models.

The red LED blinks to represent the major error category (long blinks). The white LED blinks to represent the minor error category (short blinks). For example, '3.5' indicates 3 long red blinks and 5 short white blinks to communicate the processor is not detected.

Table 7-3 Interpreting POST diagnostic front panel lights and audible codes

Category	Major/minor code	Description
BIOS	2.2	The main area (DXE) of BIOS has become corrupted, and there is no recovery binary image available.
	2.3	The embedded controller policy requires the user to enter a key sequence.
	2.4	The embedded controller is checking or recovering the boot block.
Hardware	3.2	The embedded controller has timed out waiting for BIOS to return from memory initialization.
	3.3	The embedded controller has timed out waiting for BIOS to return from graphics initialization.
	3.4	The system board displays a power failure (crowbar).*
	3.5	The processor is not detected.*
	3.6	The processor does not support an enabled feature.
	3.7	The access panel/top cover has been opened since last boot.
Thermal	4.2	A processor over temperature condition has been detected.*
	4.3	An ambient temperature over temperature condition has been detected.
	4.4	An MXM over temperature condition has been detected.

Table 7-3 Interpreting POST diagnostic front panel lights and audible codes (continued)

Category	Major/minor code	Description
System board	5.2	The embedded controller cannot find valid firmware.
	5.3	The embedded controller has timed out waiting for the BIOS.
	5.4	The embedded controller has timed out waiting for BIOS to return from system board initialization.
	5.5	The embedded controller rebooted the system after a possible lockup condition had been detected through the use of a System Health Timer, Automated System Recovery Timer, or other mechanism.

* Indicates hardware-triggered event; BIOS controls all other events.

8 Password security and resetting CMOS

This computer supports two security password features that you can establish through the Computer Setup Utilities menu: administrator password and power-on password.

When you establish only an administrator password, any user can access all the information on the computer except Computer Setup. When you establish only a power-on password, the power-on password is required to access Computer Setup and any other information on the computer. When you establish both passwords, only the administrator password will give you access to Computer Setup.

When both passwords are set, you can use the administrator password in place of the power-on password as an override to log in to the computer. This feature is useful for a network administrator.

 **IMPORTANT:** Back up the BIOS settings or save them as custom defaults in case you need them later. You can back up in Computer Setup or with the BiosConfigUtility tool available from www.hp.com. See [Computer Setup \(F10\) Utility on page 44](#) for information about backing up the BIOS settings.

Changing a setup or power-on password

Use this procedure to change a password.

To change the power-on or setup password, complete the following steps:

1. Turn on or restart the computer.
To change the setup password, go to step 2.
To change the power-on password, go to step 3.
2. To change the setup password, as soon as the computer turns on:
 - Press **esc** while the “Press the ESC key for Startup Menu” message is displayed.
 - Press **f10** to enter Computer Setup.
3. When the key icon appears, type your current password, a slash (/) or alternate delimiter character, your new password, another slash (/) or alternate delimiter character, and your new password again as shown:

current password/new password/new password

 **NOTE:** Type the new password carefully because the characters do not appear on the screen.

4. Press **enter**.

The new password will take effect the next time the computer is restarted.

Deleting a setup or power-on password

Use this procedure to delete a password.

To delete the power-on or setup password, complete the following steps:

1. Turn on or restart the computer.

To delete the Setup password, go to step 2.

To delete the Power-on password, go to step 3.

2. To delete the Setup password, as soon as the computer turns on:

- Press **esc** while the “Press the ESC key for Startup Menu” message is displayed.

- Press **f10** to enter Computer Setup.

3. When the key icon appears, type your current password, a slash (/) or alternate delimiter character, your new password, another slash (/) or alternate delimiter character, and your new password again as shown:

current password/

4. Press **enter**.

9 Backing up, restoring, and recovering

You can use Windows tools or HP software to back up your information, create a restore point, reset your computer, create recovery media, or restore your computer to its factory state. Performing these standard procedures can return your computer to a working state faster.

 **IMPORTANT:** If you will be performing recovery procedures on a tablet, the tablet battery must be at least 70% charged before you start the recovery process.

 **IMPORTANT:** For a tablet with a detachable keyboard, connect the tablet to the keyboard base before beginning any recovery process.

Backing up information and creating recovery media

These methods of creating recovery media and backups are available on select products only.

Using Windows tools for backing up

HP recommends that you back up your information immediately after initial setup. You can do this task either using Windows Backup locally with an external USB drive or using online tools.

 **IMPORTANT:** Windows is the only option that allows you to back up your personal information. Schedule regular backups to avoid information loss.

 **NOTE:** If computer storage is 32 GB or less, Microsoft® System Restore is disabled by default.

Using the HP Cloud Recovery Download Tool to create recovery media (select products only)

You can use the HP Cloud Recovery Download Tool to create HP Recovery media on a bootable USB flash drive.

For details:

- Go to <http://www.hp.com>, search for HP Cloud Recovery, and then select the result that matches the type of computer that you have.

 **NOTE:** If you cannot create recovery media yourself, contact support to obtain recovery discs. Go to <http://www.hp.com/support>, select your country or region, and then follow the on-screen instructions.

 **IMPORTANT:** HP recommends that you follow the [Restoring and recovery methods on page 74](#) to restore your computer before you obtain and use the HP recovery discs. Using a recent backup can return your machine to a working state sooner than using the HP recovery discs. After the system is restored, reinstalling all the operating system software released since your initial purchase can be a lengthy process.

Restoring and recovering your system

You have several tools available to recover your system both within and outside of Windows if the desktop cannot load.

HP recommends that you attempt to restore your system using the [Restoring and recovery methods on page 74](#).

Creating a system restore

System Restore is available in Windows. The System Restore software can automatically or manually create restore points, or snapshots, of the system files and settings on the computer at a particular point.

When you use System Restore, it returns your computer to its state at the time you made the restore point. Your personal files and documents should not be affected.

Restoring and recovery methods

After you run the first method, test to see whether the issue still exists before you proceed to the next method, which might now be unnecessary.

1. Run a Microsoft System Restore.
2. Run Reset this PC.



NOTE: The options **Remove everything** and then **Fully clean the drive** can take several hours to complete and leave no information on your computer. It is the safest way to reset your computer before you recycle it.

3. Recover using HP Recovery media. For more information, see [Recovering using HP Recovery media on page 74](#).

For more information about the first two methods, see the Get Help app:

Select the **Start** button, select the **Get Help** app, and then enter the task you want to perform.



NOTE: You must be connected to the internet to access the Get Help app.

Recovering using HP Recovery media

You can use HP Recovery media to recover the original operating system and software programs that were installed at the factory. On select products, it can be created on a bootable USB flash drive using the HP Cloud Recovery Download Tool.

For details, see [Using the HP Cloud Recovery Download Tool to create recovery media \(select products only\) on page 73](#).



NOTE: If you cannot create recovery media yourself, contact support to obtain recovery discs. Go to <http://www.hp.com/support>, select your country or region, and then follow the on-screen instructions.

To recover your system:

- Insert the HP Recovery media, and then restart the computer.



NOTE: HP recommends that you follow the [Restoring and recovery methods on page 74](#) to restore your computer before you obtain and use the HP recovery discs. Using a recent backup can return your machine to a working state sooner than using the HP recovery discs. After the system is restored, reinstalling all the operating system software released since your initial purchase can be a lengthy process.

Changing the computer boot order

If your computer does not restart using the HP Recovery media, you can change the computer boot order, the order of devices listed in BIOS for startup information. You can select an optical drive or a USB flash drive, depending on the location of your HP Recovery media.

 **IMPORTANT:** For a tablet with a detachable keyboard, connect the tablet to the keyboard base before beginning these steps.

To change the boot order:

1. Insert the HP Recovery media.
2. Access the system **Startup** menu.
 - For computers or tablets with keyboards attached, turn on or restart the computer or tablet, quickly press **esc**, and then press **f9** for boot options.
 - For tablets without keyboards, turn on or restart the tablet, quickly press and hold the volume up button, and then select **f9**.

– or –

Turn on or restart the tablet, quickly press and hold the volume down button, and then select **f9**.
3. Select the optical drive or USB flash drive from which you want to boot, and then follow the on-screen instructions.

Using HP Sure Recover (select products only)

Select computer models are configured with HP Sure Recover, a PC operating system (OS) recovery solution built into the hardware and software. HP Sure Recover can fully restore the HP OS image without installed recovery software.

Using HP Sure Recover, an administrator or user can restore the system and install:

- Latest version of the operating system
- Platform-specific device drivers
- Software applications, in the case of a custom image

To access the latest documentation for HP Sure Recover, go to <http://www.hp.com/support>. Follow the on-screen instructions to find your product and locate your documentation.

10 Using HP PC Hardware Diagnostics

You can use the HP PC Hardware Diagnostics utility to determine whether your computer hardware is running properly. The three versions are HP PC Hardware Diagnostics Windows, HP PC Hardware Diagnostics UEFI (Unified Extensible Firmware Interface), and (for select products only) Remote HP PC Hardware Diagnostics UEFI, a firmware feature.

Using HP PC Hardware Diagnostics Windows (select products only)

HP PC Hardware Diagnostics Windows is a Windows-based utility that allows you to run diagnostic tests to determine whether the computer hardware is functioning properly. The tool runs within the Windows operating system to diagnose hardware failures.

If HP PC Hardware Diagnostics Windows is not installed on your computer, first you must download and install it. To download HP PC Hardware Diagnostics Windows, see [Downloading HP PC Hardware Diagnostics Windows on page 77](#).

Using an HP PC Hardware Diagnostics Windows hardware failure ID code

When HP PC Hardware Diagnostics Windows detects a failure that requires hardware replacement, a 24-digit failure ID code is generated for select component tests. For interactive tests, such as keyboard, mouse, or audio and video palette, you must perform troubleshooting steps before you can receive a failure ID.

- You have several options after you receive a failure ID:
 - Select **Next** to open the Event Automation Service (EAS) page, where you can log the case.
– or –
 - Scan the QR code with your mobile device, which takes you to the EAS page, where you can log the case.
– or –
 - Select the box next to the 24-digit failure ID to copy your failure code and send it to support.

Accessing HP PC Hardware Diagnostics Windows

After HP PC Hardware Diagnostics Windows is installed, you can access it from HP Support Assistant or the Start menu.

Accessing HP PC Hardware Diagnostics Windows from HP Help and Support (select products only)

After HP PC Hardware Diagnostics Windows is installed, follow these steps to access it from HP Help and Support.

1. Select the **Start** button, and then select **HP Help and Support**.
2. Select **HP PC Hardware Diagnostics Windows**.
3. When the tool opens, select the type of diagnostic test that you want to run, and then follow the on-screen instructions.



NOTE: To stop a diagnostic test, select **Cancel**.

Accessing HP PC Hardware Diagnostics Windows from Support Assistant

After HP PC Hardware Diagnostics Windows is installed, follow these steps to access it from HP Support Assistant.

1. Type `support` in the taskbar search box, and then select the **HP Support Assistant** app.
– or –
Select the question mark icon in the taskbar.
2. Select **Troubleshooting and fixes**.
3. Select **Diagnostics**, and then select **HP PC Hardware Diagnostics Windows**.
4. When the tool opens, select the type of diagnostic test that you want to run, and then follow the on-screen instructions.



NOTE: To stop a diagnostic test, select **Cancel**.

Accessing HP PC Hardware Diagnostics Windows from the Start menu (select products only)

After HP PC Hardware Diagnostics Windows is installed, follow these steps to access it from the Start menu.

1. Select the **Start** button.
2. Right-click **HP PC Hardware Diagnostics for Windows**, select **More**, and then select **Run as administrator**.
3. When the tool opens, select the type of diagnostic test that you want to run, and then follow the on-screen instructions.



NOTE: To stop a diagnostic test, select **Cancel**.

Downloading HP PC Hardware Diagnostics Windows

The HP PC Hardware Diagnostics Windows downloading instructions are provided in English only. You must use a Windows computer to download this tool because only .exe files are provided.

Downloading the latest HP PC Hardware Diagnostics Windows version from HP

To download HP PC Hardware Diagnostics Windows from HP, follow these steps.

1. Go to <http://www.hp.com/go/techcenter/pcdiags>. The HP PC Diagnostics home page is displayed.
2. Select **Download HP Diagnostics Windows**, and then select the specific Windows diagnostics version to download to your computer or a USB flash drive.

The tool downloads to the selected location.

Downloading the HP PC Hardware Diagnostics Windows from the Microsoft Store

You can download the HP PC Hardware Diagnostics Windows from the Microsoft Store.

1. Select the Microsoft Store app on your desktop or enter `Microsoft Store` in the taskbar search box.
2. Enter `HP PC Hardware Diagnostics Windows` in the **Microsoft Store** search box.

3. Follow the on-screen directions.

The tool downloads to the selected location.

Downloading HP Hardware Diagnostics Windows by product name or number (select products only)

You can download HP PC Hardware Diagnostics Windows by product name or number.



NOTE: For some products, you might have to download the software to a USB flash drive by using the product name or number.

1. Go to <http://www.hp.com/support>.
2. Select **Software and Drivers**, select your type of product, and then enter the product name or number in the search box that is displayed.
3. In the **Diagnostics** section, select **Download**, and then follow the on-screen instructions to select the specific Windows diagnostics version to be downloaded to your computer or USB flash drive.

The tool downloads to the selected location.

Installing HP PC Hardware Diagnostics Windows

To install HP PC Hardware Diagnostics Windows, navigate to the folder on your computer or the USB flash drive where the .exe file downloaded, double-click the .exe file, and then follow the on-screen instructions.

Using HP PC Hardware Diagnostics UEFI

HP PC Hardware Diagnostics UEFI (Unified Extensible Firmware Interface) allows you to run diagnostic tests to determine whether the computer hardware is functioning properly. The tool runs outside the operating system so that it can isolate hardware failures from issues that are caused by the operating system or other software components.



NOTE: For Windows 10 S computers, you must use a Windows computer and a USB flash drive to download and create the HP UEFI support environment because only .exe files are provided. For more information, see [Downloading HP PC Hardware Diagnostics UEFI to a USB flash drive on page 79](#).

If your PC does not start in Windows, you can use HP PC Hardware Diagnostics UEFI to diagnose hardware issues.

Using an HP PC Hardware Diagnostics UEFI hardware failure ID code

When HP PC Hardware Diagnostics UEFI detects a failure that requires hardware replacement, a 24-digit failure ID code is generated.

For assistance in solving the problem:

- Select **Contact HP**, accept the HP privacy disclaimer, and then use a mobile device to scan the failure ID code that appears on the next screen. The HP Customer Support - Service Center page appears with your failure ID and product number automatically filled in. Follow the on-screen instructions.

– or –

Contact support, and provide the failure ID code.



NOTE: To start diagnostics on a convertible computer, your computer must be in notebook mode, and you must use the attached keyboard.

 **NOTE:** If you need to stop a diagnostic test, press [esc](#).

Starting HP PC Hardware Diagnostics UEFI

To start HP PC Hardware Diagnostics UEFI, follow this procedure.

1. Turn on or restart the computer, and quickly press [esc](#).
2. Press [f2](#).

The BIOS searches three places for the diagnostic tools, in the following order:

- a. Connected USB flash drive

 **NOTE:** To download the HP PC Hardware Diagnostics UEFI tool to a USB flash drive, see [Downloading the latest HP PC Hardware Diagnostics UEFI version on page 79](#).

- b. Hard drive
 - c. BIOS
3. When the diagnostic tool opens, select a language, select the type of diagnostic test you want to run, and then follow the on-screen instructions.

Downloading HP PC Hardware Diagnostics UEFI to a USB flash drive

Downloading HP PC Hardware Diagnostics UEFI to a USB flash drive can be useful in some situations.

- HP PC Hardware Diagnostics UEFI is not included in the preinstallation image.
- HP PC Hardware Diagnostics UEFI is not included in the HP Tool partition.
- The hard drive is damaged.

 **NOTE:** The HP PC Hardware Diagnostics UEFI downloading instructions are provided in English only, and you must use a Windows computer to download and create the HP UEFI support environment because only .exe files are provided.

Downloading the latest HP PC Hardware Diagnostics UEFI version

To download the latest HP PC Hardware Diagnostics UEFI version to a USB flash drive, follow this procedure.

1. Go to <http://www.hp.com/go/techcenter/pcdiags>. The HP PC Diagnostics home page is displayed.
2. Select **Download HP Diagnostics UEFI**, and then select **Run**.

Downloading HP PC Hardware Diagnostics UEFI by product name or number (select products only)

You can download HP PC Hardware Diagnostics UEFI by product name or number (select products only) to a USB flash drive.

 **NOTE:** For some products, you might have to download the software to a USB flash drive by using the product name or number.

1. Go to <http://www.hp.com/support>.
2. Enter the product name or number, select your computer, and then select your operating system.

3. In the **Diagnostics** section, follow the on-screen instructions to select and download the specific UEFI Diagnostics version for your computer.

Using Remote HP PC Hardware Diagnostics UEFI settings (select products only)

Remote HP PC Hardware Diagnostics UEFI is a firmware (BIOS) feature that downloads HP PC Hardware Diagnostics UEFI to your computer. It can then execute the diagnostics on your computer, and it might upload results to a preconfigured server.

For more information about Remote HP PC Hardware Diagnostics UEFI, go to <http://www.hp.com/go/techcenter/pcdiags>, and then select **Find out more**.

Downloading Remote HP PC Hardware Diagnostics UEFI

HP Remote PC Hardware Diagnostics UEFI is also available as a SoftPaq that you can download to a server.

Downloading the latest Remote HP PC Hardware Diagnostics UEFI version

You can download the latest HP PC Hardware Diagnostics UEFI version to a USB flash drive.

1. Go to <http://www.hp.com/go/techcenter/pcdiags>. The HP PC Diagnostics home page is displayed.
2. Select **Download Remote Diagnostics**, and then select **Run**.

Downloading Remote HP PC Hardware Diagnostics UEFI by product name or number

You can download HP Remote PC Hardware Diagnostics UEFI by product name or number.



NOTE: For some products, you might have to download the software by using the product name or number.

1. Go to <http://www.hp.com/support>.
2. Select **Software and Drivers**, select your type of product, enter the product name or number in the search box that is displayed, select your computer, and then select your operating system.
3. In the **Diagnostics** section, follow the on-screen instructions to select and download the **Remote UEFI** version for the product.

Customizing Remote HP PC Hardware Diagnostics UEFI settings

Using the Remote HP PC Hardware Diagnostics setting in Computer Setup (BIOS), you can perform several customizations.

- Set a schedule for running diagnostics unattended. You can also start diagnostics immediately in interactive mode by selecting **Execute Remote HP PC Hardware Diagnostics**.
- Set the location for downloading the diagnostic tools. This feature provides access to the tools from the HP website or from a server that has been preconfigured for use. Your computer does not require the traditional local storage (such as a hard drive or USB flash drive) to run remote diagnostics.
- Set a location for storing the test results. You can also set the user name and password that you use for uploads.
- Display status information about the diagnostics run previously.

To customize Remote HP PC Hardware Diagnostics UEFI settings, follow these steps:

1. Turn on or restart the computer, and when the HP logo appears, press **f10** to enter Computer Setup.
2. Select **Advanced**, and then select **Settings**.
3. Make your customization selections.
4. Select **Main**, and then **Save Changes and Exit** to save your settings.

Your changes take effect when the computer restarts.

11 Statement of memory volatility

For general information regarding nonvolatile memory in HP business computers, and to restore nonvolatile memory that can contain personal data after the system has been turned off and the hard drive has been removed, use these instructions.

HP business computer products that use Intel®-based or AMD®-based system boards contain volatile DDR memory. The amount of nonvolatile memory present in the system depends upon the system configuration. Intel-based and AMD-based system boards contain nonvolatile memory subcomponents as originally shipped from HP, with the following assumptions:

- No subsequent modifications were made to the system.
- No applications, features, or functionality were added to or installed on the system.

Following system shutdown and removal of all power sources from an HP business computer system, personal data can remain on volatile system memory (DIMMs) for a finite period of time and also remains in nonvolatile memory. Use the following steps to remove personal data from the computer, including the nonvolatile memory found in Intel-based and AMD-based system boards.

 **NOTE:** If your tablet has a keyboard base, connect to the keyboard base before beginning steps in this chapter.

Current BIOS steps

Use these instructions to restore nonvolatile memory.

1. Follow these steps to restore the nonvolatile memory that can contain personal data. Restoring or reprogramming nonvolatile memory that does not store personal data is neither necessary nor recommended.

- a. Turn on or restart the computer, and then quickly press **esc**.

 **NOTE:** If the system has a BIOS administrator password, type the password at the prompt.

- b. Select **Main**, select **Apply Factory Defaults and Exit**, and then select **Yes** to load defaults. The computer restarts.

- c. During the restart, press **esc** while the "Press the ESC key for Startup Menu" message is displayed at the bottom of the screen.

 **NOTE:** If the system has a BIOS administrator password, type the password at the prompt.

- d. Select the **Security** menu, select **Restore Security Settings to Factory Defaults**, and then select **Yes** to restore security level defaults. The computer reboots.

- e. During the reboot, press **esc** while the "Press the ESC key for Startup Menu" message is displayed at the bottom of the screen.

 **NOTE:** If the system has a BIOS administrator password, type the password at the prompt.

- f. If an asset or ownership tag is set, select the **Security** menu and scroll down to the **Utilities** menu. Select **System IDs**, and then select **Asset Tracking Number**. Clear the tag, and then make the selection to return to the prior menu.
- g. If a DriveLock password is set, select the **Security** menu, and scroll down to **Hard Drive Utilities** under the **Utilities** menu. Select **Hard Drive Utilities**, select **DriveLock**, and then clear the check box for **DriveLock password on restart**. Select **OK** to proceed.
- h. Select the **Main** menu, and then select **Reset BIOS Security to factory default**. Select **Yes** at the warning message. The computer reboots.
- i. During the reboot, press **esc** while the "Press the ESC key for Startup Menu" message is displayed at the bottom of the screen.



NOTE: If the system has a BIOS administrator password, type the password at the prompt.

- j. Select the **Main** menu, select **Apply Factory Defaults and Exit**, select **Yes** to save changes and exit, and then select **Shutdown**.
 - k. Reboot the system. If the system has a Trusted Platform Module (TPM), fingerprint reader, or both, one or two prompts will appear—one to clear the TPM and the other to Reset Fingerprint Sensor. Press or tap **f1** to accept or **f2** to reject.
 - l. Remove all power and system batteries for at least 24 hours.
2. Complete one of the following:
- Remove and retain the storage drive.
– or –
 - Clear the drive contents by using a third-party utility designed to erase data from an SSD.
– or –
 - Clear the contents of the drive by using the following BIOS Setup Secure Erase command option steps:



NOTE: If you clear data using Secure Erase, you cannot recover it.

- a. Turn on or restart the computer, and then quickly press **esc**.
- b. Select the **Security** menu and scroll down to the **esc** menu.
- c. Select **Hard Drive Utilities**.
- d. Under **Utilities**, select **Secure Erase**, select the hard drive storing the data you want to clear, and then follow the on-screen instructions to continue.
– or –
Clear the contents of the drive using the following Disk Sanitizer commands steps:
 - i. Turn on or restart the computer, and then quickly press **esc**.
 - ii. Select the **Security** menu and scroll down to the **Utilities** menu.
 - iii. Select **Hard Drive Utilities**.

- iv. Under **Utilities**, select **Disk Sanitizer**, select the hard drive with the data that you want to clear, and then follow the on-screen instructions to continue.

 **NOTE:** The amount of time it takes for Disk Sanitizer to run can take several hours. Plug the computer into an AC outlet before starting.

Nonvolatile memory usage

Use this table to troubleshooting nonvolatile memory usage.

Table 11-1 Troubleshooting steps for nonvolatile memory usage

Nonvolatile memory type	Amount (Size)	Does this memory store customer data?	Does this memory retain data when power is removed?	What is the purpose of this memory?	How is data entered into this memory?	How is this memory write-protected?
HP Sure Start flash (select models only)	8 MB	No	Yes	Provides protected backup of critical System BIOS code, EC firmware, and critical computer configuration data for select platforms that support HP Sure Start. For more information, see Using HP Sure Start (select models only)HP Sure Start on page 88.	Data cannot be written to this device via the host processor. The content is managed solely by the HP Sure Start Embedded Controller.	This memory is protected by the HP Sure Start Embedded Controller.
Real Time Clock (RTC) battery backed-up CMOS configuration memory	256 bytes	No	Yes	Stores system date and time and noncritical data.	RTC battery backed-up CMOS is programmed using Computer Setup (BIOS), or by changing the Windows date & time.	This memory is not write-protected.
Controller (NIC) EEPROM	64 KB (not customer accessible)	No	Yes	Stores NIC configuration and NIC firmware.	NIC EEPROM is programmed using a utility from the NIC vendor that can be run from DOS.	A utility must be used to write data to this memory and is available from the NIC vendor. Writing data to this ROM in an inappropriate manner will render the NIC nonfunctional.

Table 11-1 Troubleshooting steps for nonvolatile memory usage (continued)

Nonvolatile memory type	Amount (Size)	Does this memory store customer data?	Does this memory retain data when power is removed?	What is the purpose of this memory?	How is data entered into this memory?	How is this memory write-protected?
DIMM Serial Presence Detect (SPD) configuration data	256 bytes per memory module, 128 bytes programmable (not customer accessible)	No	Yes	Stores memory module information.	DIMM SPD is programmed by the memory vendor.	Data cannot be written to this memory when the module is installed in a computer. The specific write-protection method varies by memory vendor.
System BIOS	9 MB	Yes	Yes	Stores system BIOS code and computer configuration data.	System BIOS code is programmed at the factory. Code is updated when the system BIOS is updated. Configuration data and settings are entered using the Computer Setup (BIOS) or a custom utility.	NOTE: Writing data to this ROM in an inappropriate manner can render the computer nonfunctional. A utility must be used for writing data to this memory and is available on the HP website; go to http://www.hp.com/support . Select Find your product , and then follow the on-screen instructions.
Intel Management Engine Firmware (present only in select Elite or Z models. For more information, go to http://www.hp.com/support . Select Identify your product for manuals and specific product information , and then follow the on-screen instructions.)	1.5 MB or 7 MB	Yes	Yes	Stores Management Engine Code, Settings, Provisioning Data and iAMT third-party data store.	Management Engine Code is programmed at the factory. Code is updated via Intel secure firmware update utility. Unique Provisioning Data can be entered at the factory or by an administrator using the Management Engine (MEBx) setup utility. The third-party data store contents can be populated by a remote management console or local applications that have been registered by an administrator to have access to the space.	The Intel chipset is configured to enforce hardware protection to block all direct read-write access to this area. An Intel utility must be used for updating the firmware. Only firmware updates digitally signed by Intel can be applied using this utility.
Bluetooth flash (select products only)	2 megabits	No	Yes	Stores Bluetooth configuration and firmware.	Bluetooth flash is programmed at the factory. Tools for writing data to this memory are not publicly available but can be obtained from the silicon vendor.	A utility must be used for writing data to this memory and is made available through newer versions of the driver whenever the flash requires an upgrade.

Table 11-1 Troubleshooting steps for nonvolatile memory usage (continued)

Nonvolatile memory type	Amount (Size)	Does this memory store customer data?	Does this memory retain data when power is removed?	What is the purpose of this memory?	How is data entered into this memory?	How is this memory write-protected?
802.11 WLAN EEPROM	4 kilobits to 8 kilobits	No	Yes	Stores configuration and calibration data.	802.11 WLAN EEPROM is programmed at the factory. Tools for writing data to this memory are not made public.	A utility must be used for writing data to this memory and is typically not made available to the public unless a firmware upgrade is necessary to address a unique issue.
Camera (select products only)	64 kilobits	No	Yes	Stores camera configuration and firmware.	Camera memory is programmed using a utility from the device manufacturer that can be run from Windows.	A utility must be used for writing data to this memory and is typically not made available to the public unless a firmware upgrade is necessary to address a unique issue.
Fingerprint reader (select products only)	512 KB flash	Yes	Yes	Stores fingerprint templates.	Fingerprint reader memory is programmed by user enrollment in HP ProtectTools Security Manager.	Only a digitally signed application can make the call to write to the flash.

Questions and answers

Use this section to answer your questions about nonvolatile memory.

1. How can the BIOS settings be restored (returned to factory settings)?

 **IMPORTANT:** The restore defaults feature does not securely erase any information on your hard drive. See question and answer 6 for steps to securely erase information.

The restore defaults feature does not reset the Custom Secure Boot keys. See question and answer 7 for information about resetting the keys.

- a. Turn on or restart the computer, and then quickly press **esc**.
- b. Select **Main**, and then select **Apply Factory Defaults and Exit**.
- c. Follow the on-screen instructions.
- d. Select **Main**, select **Save Changes and Exit**, and then follow the on-screen instructions.

2. What is a UEFI BIOS, and how is it different from a legacy BIOS?

The Unified Extensible Firmware Interface (UEFI) BIOS is an industry-standard software interface between the platform firmware and an operating system (OS). It replaces the older BIOS architecture but supports much of the legacy BIOS functionality.

Like the legacy BIOS, the UEFI BIOS provides an interface to display the system information and configuration settings and to change the configuration of your computer before an OS is loaded. BIOS provides a secure runtime environment that supports a Graphic User Interface (GUI). In this environment, you can use either a pointing device (touch screen, touchpad, pointing stick, or USB mouse) or the keyboard to navigate and make menu and configuration selections. The UEFI BIOS also contains basic system diagnostics.

The UEFI BIOS provides functionality beyond that of the legacy BIOS. In addition, the UEFI BIOS works to initialize the computer's hardware before loading and executing the OS; the runtime environment allows the loading and execution of software programs from storage devices to provide more functionality, such as advanced hardware diagnostics (with the ability to display more detailed system information) and advanced firmware management and recovery software.

HP has provided options in Computer Setup (BIOS) to allow you to run in legacy BIOS, if required by the operating system. Examples of this requirement would be if you upgrade or downgrade the OS.

3. Where is the UEFI BIOS located?

The UEFI BIOS is located on a flash memory chip. You must use a utility to write to the chip.

4. What kind of configuration data is stored on the DIMM Serial Presence Detect (SPD) memory module? How would this data be written?

The DIMM SPD memory contains information about the memory module, such as size, serial number, data width, speed and timing, voltage, and thermal information. This information is written by the module manufacturer and stored on an EEPROM. You cannot write to this EEPROM when the memory module is installed in a computer. Third-party tools do exist that can write to the EEPROM when the memory module is not installed in a computer. Various third-party tools are available to read SPD memory.

5. What is meant by "Restore the nonvolatile memory found in Intel-based system boards"?

This message relates to clearing the Real Time Clock (RTC) CMOS memory that contains computer configuration data.

6. How can the BIOS security be reset to factory defaults and erase the data?

 **IMPORTANT:** Resetting results in the loss of information.

These steps do not reset Custom Secure Boot Keys. See question and answer 7 for information about resetting the keys.

- a. Turn on or restart the computer, and then quickly press **esc**.
- b. Select **Main**, and then select **Reset Security to Factory Defaults**.
- c. Follow the on-screen instructions.
- d. Select **Main**, select **Save Changes and Exit**, and then follow the on-screen instructions.

7. How can the Custom Secure Boot Keys be reset?

Secure Boot is a feature to ensure that only authenticated code can start on a platform. If you enabled Secure Boot and created Custom Secure Boot Keys, disabling Secure Boot does not clear the keys. You must also select to clear the Custom Secure Boot Keys. Use the same Secure Boot access procedure that you used to create the Custom Secure Boot Keys, but select to clear or delete all Secure Boot Keys.

- a. Turn on or restart the computer, and then quickly press **esc**.

- b. Select the **Security** menu, select **Secure Boot Configuration**, and then follow the on-screen instructions.
- c. At the **Secure Boot Configuration** window, select **Secure Boot**, select **Clear Secure Boot Keys**, and then follow the on-screen instructions to continue.

Using HP Sure Start (select products only)

Select computer models are configured with HP Sure Start, a technology that continuously monitors your computer's BIOS for attacks or corruption.

If the BIOS becomes corrupted or is attacked, HP Sure Start restores the BIOS to its previously safe state, without user intervention. Those select computer models ship with HP Sure Start configured and enabled. HP Sure Start is configured and already enabled so that most users can use the HP Sure Start default configuration. Advanced users can customize the default configuration.

To access the latest documentation on HP Sure Start, go to <http://www.hp.com/support>.

12 Power cord set requirements

The power supplies on some computers have external power switches.

The voltage select switch feature on the computer permits it to operate from any line voltage of 100 V ac–120 V ac or 220 V ac–240 V ac. Power supplies on those computers that do not have external power switches are equipped with internal switches that sense the incoming voltage and automatically switch to the proper voltage.

The power cord set received with the computer meets the requirements for use in the country where you purchased the equipment.

Power cord sets for use in other countries must meet the requirements of the country where you use the computer.

General requirements

These requirements are applicable to all countries.

1. The power cord must be approved by an acceptable accredited agency responsible for evaluation in the country where the power cord set will be installed.
2. The power cord set must have a minimum current capacity of 10A (7A Japan only) and a nominal voltage rating of 125 V ac or 250 V ac, as required by each country's power system.
3. The diameter of the wire must be a minimum of 0.75 mm² or 18AWG, and the length of the cord must be between 1.8 m (6 ft) and 3.6 m (12 ft).

The power cord should be routed so that it is not likely to be walked on or pinched by items placed upon it or against it. Particular attention should be paid to the plug, electrical outlet, and the point where the cord exits from the product.

 **WARNING!** Do not operate this product with a damaged power cord set. If the power cord set is damaged in any manner, replace it immediately.

Japanese power cord requirements

For use in Japan, use only the power cord received with this product.

 **IMPORTANT:** Do not use the power cord received with this product on any other products.

Country-specific requirements

This information provides additional requirements specific to a country.

Table 12-1 Power cord country-specific requirements

Country	Accrediting Agency	Country	Accrediting Agency
Australia (1)	EANSW	Italy (1)	IMQ
Austria (1)	OVE	Japan (3)	METI
Belgium (1)	CEBC	Norway (1)	NEMKO
Canada (2)	CSA	Sweden (1)	SEMKO
Denmark (1)	DEMKO	Switzerland (1)	SEV
Finland (1)	SETI	United Kingdom (1)	BSI
France (1)	UTE	United States (2)	UL
Germany (1)	VDE		

1. The flexible cord must be Type HO5VV-F, 3-conductor, 0.75mm² conductor size. Power cord set fittings (appliance coupler and plug) must bear the certification mark of the agency responsible for evaluation in the country where it will be used.
2. The flexible cord must be Type SVT or equivalent, No. 18 AWG, 3 conductor. The plug must be a 2-pole grounding type with a NEMA 5-15P (15 A, 125 V) or NEMA 6-15P (15 A, 250 V) configuration.
3. Appliance coupler, flexible cord, and plug must bear a T mark and registration number in accordance with the Japanese Dentori Law. Flexible cord must be Type VCT or VCTF, 3-conductor, 0.75 mm² conductor size. Plug must be a 2-pole grounding type with a Japanese Industrial Standard C8303 (7 A, 125 V) configuration.

13 Specifications

This section provides specifications for your computer.

Table 13-1 Specifications

	Metric	U.S.
Temperature range		
Operating	0°C to 35°C	32°C to 95°F
Nonoperating	-20°C to 60°C	-4°F to 140°F
NOTE: Operating temperature is derated 1.0°C per 300 m (1000 ft) to 3000 m (10,000 ft) above sea level; no direct sustained sunlight. Maximum rate of change is 10°C/hr. The upper limit might be limited by the type and number of options installed.		
Maximum altitude (unpressurized)		
Operating	-15 m to 3,048 m	-50 ft to 10,000 ft
Nonoperating	-15 m to 9,144 m	-50 ft to 30,000 ft
Relative humidity (noncondensing)		
Operating	10% to 90%	
Nonoperating (38.7°C max wet bulb)	5% to 95%	
Power supply		
Operating voltage range	90 V ac to 264 V ac	
Rated voltage range ¹	100 V ac to 240 V ac	
Rated line frequency	50 Hz to 60 Hz	
Operating line frequency	47 Hz to 63 Hz	
Power supply	150 W	
	65 W	

¹ This system uses an active power factor-corrected power supply. This allows the system to pass the CE mark requirements for use in the countries of the European Union. The active power factor-corrected power supply also has the added benefit of not requiring an input-voltage range select switch.

Index

- A**
 - adjusting the head unit 6
 - Advanced menu, Computer Setup 53
 - Advanced Stand features 4
 - Advanced Swivel Stand features 4
 - audible codes 68
- B**
 - back plate
 - removal and replacement 21
 - backup, creating 73
 - backups 73
 - battery
 - disposal 12, 17, 18
 - battery replacement 29
 - beep codes 68
 - blinking lights 68
 - boot order, changing 75
 - booting options
 - Full Boot 62
 - Quick Boot 62
- C**
 - cable management 12, 18
 - cable pinouts, SATA data 12
 - calibrating the touch screen 42
 - changing a Power-On password 71
 - changing a Setup password 71
 - cleaning
 - computer 12, 15, 16
 - mouse 12, 15, 17
 - safety precautions 12, 15
 - CMOS
 - clearing and resetting 71
 - computer cleaning 12, 15, 16
 - Computer Setup
 - Advanced menu 53
 - Main menu 45
 - Security menu 49
 - Computer Setup Utility 44
 - configure
 - peripheral modules 43
 - powered serial ports 42
 - configuring the software 42
 - country power cord set requirements 89
- D**
 - deleting a Power-On password 71
 - deleting a Setup password 71
 - downloading HP Firmware Installer 43
- E**
 - electrostatic discharge (ESD) 12
 - preventing damage 12, 13
 - error
 - codes 62, 68
 - error messages 62
 - Essential Stand components 4
 - Essential VESA Hub features 5
 - expansion slot cover
 - removal and replacement 24
 - touch board 24
- F**
 - F10 Setup 44
 - features 4
 - fingerprint reader
 - removal and replacement 39
 - firmware update 43
- G**
 - grounding methods 12, 13
- H**
 - hard drive
 - proper handling 12, 17
 - SATA characteristics 12
 - head unit
 - removal and replacement 19
 - heat sink
 - removal and replacement 37
 - HP PC Hardware Diagnostics UEFI
 - downloading 79
 - failure ID code 78
 - starting 79
 - using 78
 - HP PC Hardware Diagnostics Windows
 - accessing 76, 77
 - downloading 77
 - failure ID code 76
 - installing 78
 - using 76
 - HP Recovery media
 - recovery 74
 - HP Sure Recover 75
 - HP Sure Start 82, 88
- I**
 - illustrated parts catalog 9
 - install
 - security cable on the Advanced Stand 8
 - security cable on the Advanced Swivel Stand 8
 - installing
 - battery 29
 - memory 25
 - installing updates 43
 - integrated features 2
 - integrated payment option
 - removal and replacement 22
- K**
 - keyboard
 - cleaning 12, 15, 16
- L**
 - left expansion slot cable
 - removal and replacement 32
 - lights
 - blinking PS/2 keyboard 68
- M**
 - magnetic stripe reader
 - removal and replacement 38
 - Main menu, Computer Setup 45
 - major components
 - illustrated 9
 - memory
 - nonvolatile 82
 - removal and replacement 25
 - socket population 25
 - specifications 25
 - volatile 82
 - memory module
 - installation 25

- microphone module
 - removal and replacement 30
- miscellaneous parts 10
- mouse
 - cleaning 12, 15, 17
- N**
- NFC module
 - removal and replacement 33
- nonvolatile memory 82
- numeric error codes 62
- O**
- operating guidelines 12, 15
- overheating, prevention 12, 15
- P**
- password
 - Power-On 71
 - security 71
 - Setup 71
- POST error messages 62
- power button
 - system 6
- power button board
 - removal and replacement 31
- power cord set requirements
 - country specific 89
- power supply
 - operating voltage range 91
- Power-On password 71
- Pro VESA Hub features 5
- processor heat sink
 - removal and replacement 37
- R**
- recovery 73
 - discs 74
 - media 74
 - USB flash drive 74
- recovery media 73
 - creating using HP Cloud Recovery Download Tool 73
 - creating using Windows tools 73
- Remote HP PC Hardware Diagnostics
 - UEFI settings
 - customizing 80
 - using 80
- removal and replacement
 - back plate 21
 - fingerprint reader 39
 - head unit 19
 - heat sink 37
 - integrated payment option 22
 - left expansion slot cable 32
 - magnetic stripe reader 38
 - memory 25
 - microphone module 30
 - NFC module 33
 - power button board 31
 - processor heat sink 37
 - solid-state drive 27
 - speaker 36
 - system board 40
 - system board cover 25
 - WLAN antenna 35
 - WLAN module 34
- removing
 - battery 29
- removing personal data from
 - volatile system memory 82
- restoring 73
- restoring and recovery methods 74
- S**
- safety precautions
 - cleaning 12, 15
- SATA
 - connectors on system board 12
 - data cable pinouts 12
 - hard drive characteristics 12
- screws, correct size 12, 17
- Security menu, Computer Setup 49
- serial number location
 - Advanced Stand 8
 - Advanced Swivel Stand 8
 - Essential Stand 7
 - system 7
- service considerations 12, 17
- Setup password 71
- software 42
 - servicing computer 12, 17
- solid-state drive
 - removal and replacement 27
- speaker
 - removal and replacement 36
- specifications
 - computer 91
 - memory 25
- stand 3
- static electricity 12
- system board
 - removal and replacement 40
 - SATA connectors 12
- system board cover
 - removal and replacement 25
- system memory, removing personal data from volatile 82
- system restore 74
- system restore point, creating 73
- T**
- temperature control 12, 15
- tools, servicing 12, 17
- Torx T15 screwdriver 12, 17
- touch screen calibration 42
- U**
- update system 43
- using Computer Setup Utilities 44
- V**
- ventilation, proper 12, 15
- W**
- Windows
 - backup 73
 - recovery media 73
 - system restore point 73
- Windows tools, using 73
- WLAN antenna
 - removal and replacement 35
- WLAN module
 - removal and replacement 34