



# Maintenance and Service Guide

## HP Engage Flex Mini G2 Retail System

### **SUMMARY**

This guide provides maintenance information about such topics as spare parts, removal and replacement of parts, security, and backing up.

## Legal information

© Copyright 2025 HP Development Company, L.P.

AMD is a trademark of Advanced Micro Devices, Inc. Bluetooth is a trademark owned by its proprietor and used by HP Inc. under license. Intel, Core, Optane, Thunderbolt, and vPro are trademarks of Intel Corporation or its subsidiaries in the U.S. and/or other countries. Microsoft and Windows are either registered trademarks or trademarks of Microsoft Corporation in the United States and/or other countries. USB4, USB Type-C, USB-C, and the USB 10 Gbps and USB 20 Gbps port logos are registered trademarks of USB Implementers Forum. DisplayPort and the DisplayPort logo are trademarks owned by the Video Electronics Standards Association (VESA) in the United States and other countries. Wi-Fi is a registered trademark of Wi-Fi Alliance.

The information contained herein is subject to change without notice. The only warranties for HP products and services are set forth in the express warranty statements accompanying such products and services. Nothing herein should be construed as constituting an additional warranty. HP shall not be liable for technical or editorial errors or omissions contained herein.

First Edition: April 2025

Document Part Number: P36431-001

### Product notice

This guide describes features that are common to most models. Some features may not be available on your computer.

Not all features are available in all editions or versions of Windows. Systems may require upgraded and/or separately purchased hardware, drivers, software or BIOS update to take full advantage of Windows functionality. Windows is automatically updated, which is always enabled. High-speed internet and Microsoft account required. ISP fees may apply and additional requirements may apply over time for updates. See <http://www.windows.com>.

**If your product ships with Windows in S Mode:** Windows in S Mode works exclusively with apps from the Microsoft Store within Windows. Certain default settings, features, and apps cannot be changed. Some accessories and apps that are compatible with Windows may not work (including some antivirus, PDF writers, driver utilities, and accessibility apps), and performance may vary, even if you switch out of S Mode. If you switch to Windows, you cannot switch back to S Mode. Learn more at [Windows.com/SmodeFAQ](https://www.windows.com/SmodeFAQ).

To access the latest user guides, go to <http://www.hp.com/support>, and follow the instructions to find your product. Then select **Setup & User Guides**.

To help us improve this document, please send any suggestions, comments, or errors to <mailto:hp.doc.feedback@hp.com>. Include the document part number when submitting your feedback.

### Software terms

By installing, copying, downloading, or otherwise using any software product preinstalled on this computer, you agree to be bound by the terms of the HP End User License Agreement (EULA). If you do not accept these license terms, your sole remedy is to return the entire unused product (hardware and software) within 14 days for a full refund subject to the refund policy of your seller.

For any further information or to request a full refund of the price of the computer, please contact your seller.

## Important notice about Customer Self-Repair parts

Your computer includes Customer Self-Repair parts and parts that should be accessed only by an authorized service provider.



---

**IMPORTANT:** See [Removal and replacement procedures for Customer Self-Repair parts on page 20](#) for details.

Accessing parts described in [Removal and replacement procedures on page 28](#) can damage the computer or void your warranty.

---

---

# Table of contents

<b>1 Product features</b>	<b>1</b>
Standard configuration features	1
Front panel components	1
Rear panel components	3
Serial number location	4
<b>2 Illustrated parts catalog</b>	<b>5</b>
Computer major components	5
Miscellaneous parts	7
<b>3 Routine care, drive guidelines, and disassembly preparation</b>	<b>11</b>
Electrostatic discharge information	11
Generating static electricity	11
Preventing electrostatic damage to equipment	12
Personal grounding methods and equipment	12
Grounding the work area	13
Recommended materials and equipment	13
Operating guidelines	14
Routine care	14
General cleaning safety precautions	14
Removing dirt and debris from your computer	15
Cleaning your computer with a disinfectant	15
Cleaning the computer case	16
Cleaning the keyboard	16
Cleaning the monitor	17
Cleaning the mouse	17
Service considerations	17
Tools and software requirements	17
Screws	18
Cables and connectors	18
Hard drives	18
Lithium coin cell battery	19
Cable management	19
<b>4 Removal and replacement procedures for Customer Self-Repair parts</b>	<b>20</b>
Component replacement procedures	20
Preparation for disassembly	20
Access panel	21
Fans	21
Speaker	23
WLAN module	23

Memory modules (SODIMMs) .....	25
<b>5 Removal and replacement procedures.....</b>	<b>28</b>
Component replacement procedures .....	28
Solid-state drive (on support bracket).....	28
Support bracket.....	29
Solid-state drive.....	30
Battery.....	32
Flex I/O connector board.....	33
Flex I/O connector board (board-to-board) .....	34
Heat sink .....	35
Processor .....	36
System board .....	38
System board callouts .....	39
<b>6 Computer Setup (F10) Utility .....</b>	<b>41</b>
Using Computer Setup (F10) Utilities.....	41
Computer Setup Main.....	42
Computer Setup Security.....	46
Computer Setup Advanced .....	52
<b>7 POST error messages .....</b>	<b>62</b>
POST numeric codes and text messages .....	62
Interpreting POST diagnostic front panel lights and audible codes.....	68
<b>8 Password security and resetting CMOS.....</b>	<b>71</b>
Changing a setup or power-on password.....	71
Deleting a setup or power-on password.....	71
<b>9 Backing up, restoring, and recovering.....</b>	<b>73</b>
Backing up information and creating recovery media.....	73
Using Windows tools for backing up.....	73
Using the HP Cloud Recovery Download Tool to create recovery media (select products only).....	73
Restoring and recovering your system.....	74
Creating a system restore .....	74
Restoring and recovery methods.....	74
Recovering using HP Recovery media .....	74
Changing the computer boot order .....	75
Using HP Sure Recover (select products only).....	75
<b>10 Statement of memory volatility.....</b>	<b>76</b>
Current BIOS steps .....	76
Nonvolatile memory usage .....	78
Questions and answers .....	79
<b>11 Using HP PC Hardware Diagnostics .....</b>	<b>81</b>
Using HP PC Hardware Diagnostics Windows (select products only).....	81

Using an HP PC Hardware Diagnostics Windows hardware failure ID code.....	81
Accessing HP PC Hardware Diagnostics Windows.....	81
Accessing HP PC Hardware Diagnostics Windows from HP Support Assistant.....	81
Accessing HP PC Hardware Diagnostics Windows from the Start menu (select products only).....	82
Downloading HP PC Hardware Diagnostics Windows.....	82
Downloading the latest HP PC Hardware Diagnostics Windows version from HP.....	82
Downloading the HP PC Hardware Diagnostics Windows from the Microsoft Store.....	82
Downloading HP Hardware Diagnostics Windows by product name or number (select products only).....	83
Installing HP PC Hardware Diagnostics Windows.....	83
Using HP PC Hardware Diagnostics UEFI.....	83
Using an HP PC Hardware Diagnostics UEFI hardware failure ID code.....	83
Starting HP PC Hardware Diagnostics UEFI.....	83
Starting HP PC Hardware Diagnostics UEFI through HP Hotkey Support software (select products only).....	84
Downloading HP PC Hardware Diagnostics UEFI to a USB flash drive.....	84
Downloading the latest HP PC Hardware Diagnostics UEFI version.....	85
Downloading HP PC Hardware Diagnostics UEFI by product name or number (select products only).....	85
Using Remote HP PC Hardware Diagnostics UEFI settings (select products only).....	85
Downloading Remote HP PC Hardware Diagnostics UEFI.....	85
Downloading the latest Remote HP PC Hardware Diagnostics UEFI version.....	85
Downloading Remote HP PC Hardware Diagnostics UEFI by product name or number.....	86
Customizing Remote HP PC Hardware Diagnostics UEFI settings.....	86
<b>12 Power cord set requirements.....</b>	<b>87</b>
General requirements.....	87
Japanese power cord requirements.....	87
Country-specific requirements.....	87
<b>13 Specifications.....</b>	<b>89</b>
<b>Index.....</b>	<b>90</b>

---

# 1 Product features

This chapter provides you with an overview of your computer's features.

## Standard configuration features

To identify a typical computer configuration, read this section. Features vary depending on the model. For support assistance and to learn more about the hardware and software installed on your computer model, run the HP Support Assistant utility.







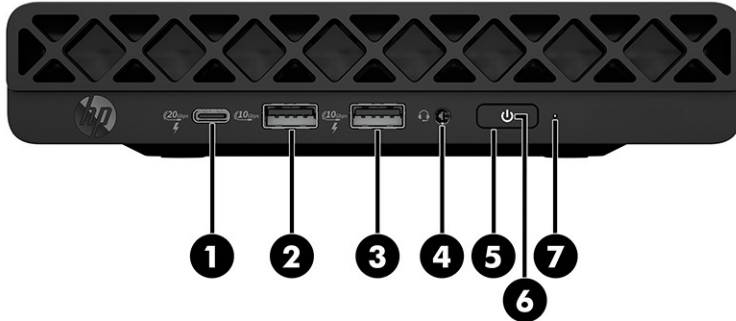

## Front panel components

To identify the front panel components, use this illustration and table.



**Table 1-1** Identifying the front panel components

		Front panel components			
(1)		USB Type-C® 20 Gbps port with HP Sleep and Charge	(5)		Power light
<p><b>NOTE:</b> Use a standard USB Type-C charging cable or cable adapter (purchased separately) when charging a small external device such as a smartphone.</p>					
(2)		USB Type-A 10 Gbps port	(6)		Power button**
<p><b>NOTE:</b> Use a standard USB Type-A charging cable or cable adapter (purchased separately) when charging a small external device such as a smartphone.</p>					
(3)		USB Type-A 10 Gbps port	(7)		Hard drive activity light
(4)		Audio-out (headphone)/Audio-in (microphone) combo jack*			

\*The combo jack supports headphones, line output devices, microphones, line input devices, or CTIA-style headsets.



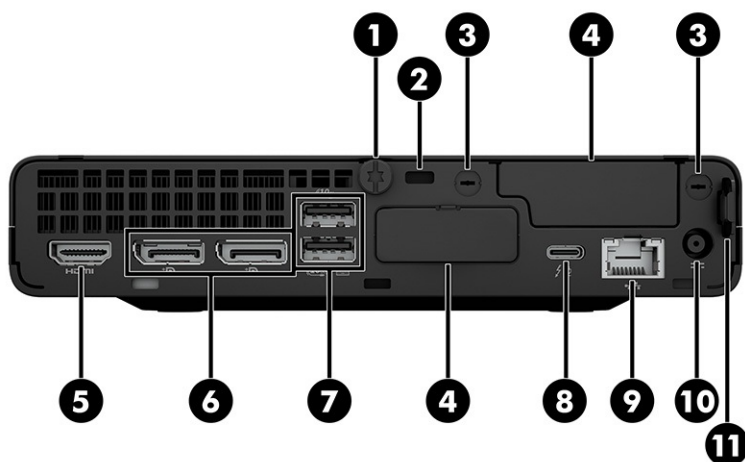

\*\*The light on the power button is normally white when the power is on. If the light blinks red, the computer displays a diagnostic code to indicate a problem. See the *Maintenance and Service Guide* to interpret the code.

## Rear panel components

To identify the rear panel components, use this illustration and table.



**Table 1-2** Identifying the rear panel components

Rear panel components			
(1)	Thumbscrew	(7)	 USB Type-A 10 Gbps ports (2) <b>NOTE:</b> Use a standard USB Type-A charging cable or cable adapter (purchased separately) when charging a small external device such as a smartphone.
(2)	Security cable slot	(8)	 USB Type-C Thunderbolt port with HP Sleep and Charge <b>NOTE:</b> Use a standard USB Type-C charging cable or cable adapter (purchased separately) when charging a small external device such as a smartphone.
(3)	External antennas (2)	(9)	 RJ-45 (network) jack
(4)	Optional ports (2)	(10)	Power connector
(5)	HDMI port	(11)	Padlock bracket
(6)	 DisplayPort™ monitor connectors (2)		

 **NOTE:** Your model might have additional ports available from HP.

When a graphics card is installed in one of the system board slots, you can use the video connectors on the graphics card or the integrated graphics on the system board. The specific graphics card installed and software configuration determine the behavior.

You can disable the system board graphics by changing settings in BIOS F10 Setup.

---

## Serial number location

Each computer has a unique serial number and a product ID number that are located on the exterior of the computer. Keep these numbers available when contacting customer service for assistance.

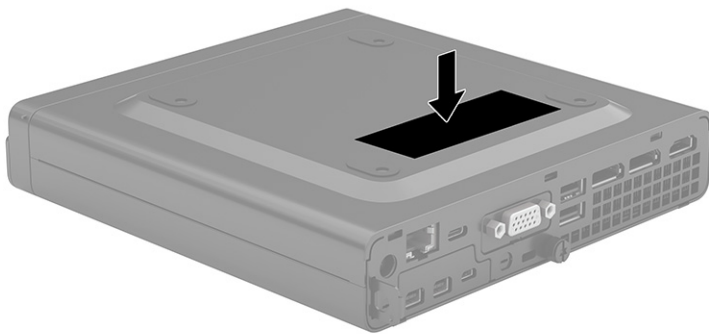

## 2 Illustrated parts catalog

Use this information to determine the spare parts that are available for the computer.

 **NOTE:** HP continually improves and changes product parts. For complete and current information about supported parts for your computer, go to <https://partsurfer.hp.com/>, select your country or region, and then follow the on-screen instructions.

### Computer major components

To identify the computer major components, use this illustration and table.

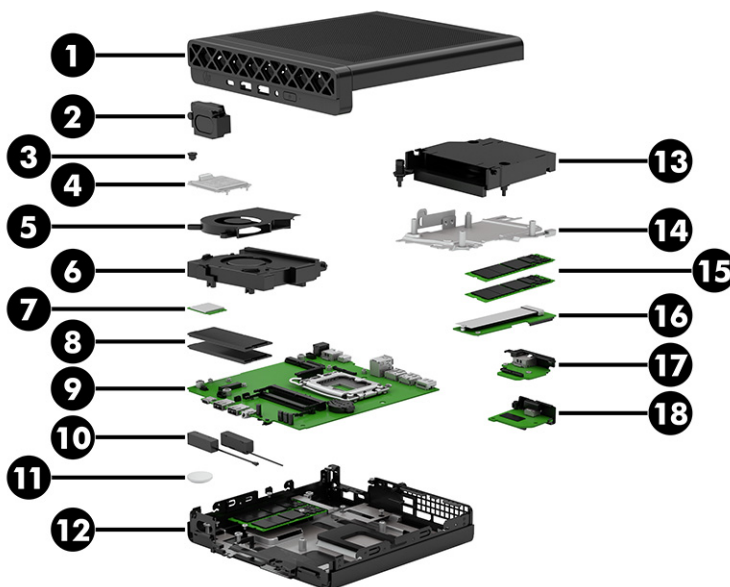

**Table 2-1** Computer major components and their descriptions

Item	Description	Spare part number
(1)	Access panel	not available as a spare part
(2)	Speaker	P35215-001
(3)	Ambient (thermal) sensor	P34939-001
(4)	Processor (includes replacement thermal material)	
	Intel Core Ultra 5-225T processor with Intel UHD Graphics 3Xe (10 core, 35 W)	P38437-003
	Intel Core Ultra 5-235T processor with Intel UHD Graphics 3Xe (vPro®, 14 core, 35 W)	P36623-003
	Intel Core Ultra 5-245T processor with Intel UHD Graphics 3Xe (vPro, 14 core, 35 W)	P38438-003
	Intel Core Ultra 7-265T processor with Intel UHD Graphics 4Xe (vPro, 20 core, 35 W)	P36624-003
	Intel Core Ultra 9-285T processor with Intel UHD Graphics 4Xe (vPro, 24 core, 35 W)	P36622-003

**Table 2-1 Computer major components and their descriptions (continued)**

<b>Item</b>	<b>Description</b>	<b>Spare part number</b>
<b>(5)</b>	<b>Fan (second fan)</b>	P35210-001
<b>(6)</b>	<b>Fan</b>	P34938-001
<b>(7)</b>	<b>WLAN</b>	
	Intel Wi-Fi® 7 BE200, vPro + Bluetooth® 5.4	N39882-001
	Intel Wi-Fi 7 BE200, non-vPro + Bluetooth 5.4	N39883-001
	Realtek RTL8852CE Wi-Fi® 6E + Bluetooth® 5.3	N19618-001
<b>(8)</b>	<b>Memory (DDR5 5600)</b>	
	32 GB (for use in The People's Republic of China)	N77400-001
	16 GB	N38627-001
	16 GB (PRC)	N77399-001
	8 GB (PRC)	N77398-001
	8 GB	N37792-001
<b>(9)</b>	<b>System board</b>	
	For use in models with a standard BIOS	P34930-xx1
	For use in models with a NetClone BIOS	P34931-xx1
<b>(10)</b>	<b>Antenna</b>	P34935-001
<b>(11)</b>	<b>RTC battery</b>	not available as a spare part
<b>(12)</b>	<b>System chassis</b>	not available as a spare part
<b>(13)</b>	<b>Heat sink</b>	P34936-001
<b>(14)</b>	<b>Support bracket</b>	not available as a spare part
<b>(15)</b>	<b>Solid-state drive (M.2 2280, PCIe 4 × 4)</b>	
	2 TB, TLC	N77396-002
	2 TB, ZTurbo	M52027-001
	1 TB, TLC	M16560-001
	1 TB, value	P17111-001
	1 TB, TLC (PRC)	N77395-002
	1 TB (PRC)	N77394-002
	512 GB (PRC)	N77392-002
	512 GB, TLC (PRC)	N77393-002
	512 GB, value	N44321-001
	512 GB, TLC	M17436-001
	512 GB, TLC, self-encrypting drive (SED)	M52031-002

**Table 2-1 Computer major components and their descriptions (continued)**

Item	Description	Spare part number
	256 GB (PRC)	N77391-002
	256 GB, SED	N35225-002
	256 GB	N30732-001
<b>(16)</b>	<b>Solid-state drive board</b>	not available as a spare part
<b>(17)</b>	<b>Flex I/O connector board (board-to-board)</b>	
	HP DisplayPort 2.1	P27712-001
	HP VGA Flex IO v3	P27714-001
	HP HDMI 2.1 Flex IO v3	P27713-001
	HP dual USB Type-A 3.1 Gen 1	P37127-001
	HP Thunderbolt 4™ Flex IO v3	P27709-001
	HP Serial Port v3 FlexIO	P37040-001
	Intel Ethernet Controller I226-V 2.5 Gb network connection LOM (non-vPro)	P07166-001
	HP Dual USB Type-C 3.2 Gen2 15W Out Flex IO v3	P27711-001
<b>(18)</b>	<b>Flex I/O connector board</b>	
	HP Flex 1 GbE fiber LC single port	M27481-002
	USB to Serial	N07478-001
	HP dual USB Type-A 3.1	P27715-001

## Miscellaneous parts

To identify the various computer parts, use this table.

**Table 2-2 Miscellaneous parts and their descriptions**

Description	Spare part number
<b>Bezel</b>	not available as a spare part
<b>Bezel dust filter</b>	P34942-001
<b>Stand assembly</b>	768430-001
<b>Solid-state drive latch (toolless)</b>	P37117-001
<b>Adapters</b>	
HP Display Port to DVI adapter	753744-001
HP USB-C to USB 3.0 adapter	814618-001
HP USB-C to HDMI 2.0 Adapter	935325-001
USB-C to DisplayPort G2	N81435-001
<b>Cable lock</b>	840158-001

**Table 2-2** Miscellaneous parts and their descriptions (continued)

Description	Spare part number
<b>Dual VESA sleeve</b>	N68878-001
<b>Cables</b>	
DisplayPort to LCD	487562-001
Ambient sensor	P34939-001
HP Display Port to VGA adapter	753745-001
HDMI 1.4 to HDMI 2.0 (1.8 m)	L05069-001
Mini DisplayPort (Mini DP) to DisplayPort	L76565-001
Thunderbolt4 Gen3 40 Gbps, 1 m (3.3 ft)	M91121-001
USB to Serial adapter	778835-001
<b>Antenna</b>	
Antenna bar	M11547-001
Dual internal WLAN antenna	P34934-001
<b>Mounting kit</b>	
Quick Release 2	L57512-001
<b>Plastic port cover</b>	P37186-001
<b>Shelf bracket</b>	L03412-002
<b>Mouse</b>	
HP Halley USB mouse	P10675-001
HP 128 laser wired mouse	P10669-001
HP USB 125 antimicrobial mouse (PRC)	P10668-001
HP 128 laser wired mouse	P10666-001
<b>Keyboard</b> (country codes are listed following this table)	
HP 125 wired	P10665-001
HP 125 wired antimicrobial (PRC)	P10667-AA1
HP Halley USB	P10674-001
<b>Network interface card</b>	N73408-001
<b>Power adapters</b>	
90 W Smart PFC slim barrel	L40098-001
100 W USB-C slim straight	N57045-001
120 W Smart PFC slim barrel	L57117-001
<b>Power cord</b> (C5, 1.8 m [6 ft])	
Argentina	L19357-002
Australia	L19358-002
Brazil	L19359-002

**Table 2-2** Miscellaneous parts and their descriptions (continued)

<b>Description</b>	<b>Spare part number</b>
Denmark	L19360-002
Denmark (halogen free)	M75269-001
Europe (Austria, Belgium, Finland, France, Germany, the Netherlands, Norway, and Sweden)	L19361-002
Europe (Austria, Belgium, Finland, France, Germany, the Netherlands, Norway, and Sweden) (halogen free)	M75279-001
Israel	L19362-002
Israel (halogen free)	M75271-001
India	L19363-002
Italy	L19364-002
Japan	L19365-002
Korea	L19366-002
North America	L19367-002
The People's Republic of China	L19368-002
South Africa	L19369-002
Switzerland	L19370-002
Switzerland (halogen free)	M75275-001
Thailand	L19371-002
Thailand, bundle	M85420-001
Taiwan	L19372-002
The United Kingdom	L19373-002
The United Kingdom (halogen free)	M75277-001
<b>Power cord (C5, 1.0 m [3.3 ft])</b>	
Argentina	L19357-001
Australia	L19358-001
Brazil	L19359-001
Denmark	L19360-001
Denmark (halogen free)	M79264-001
Europe (Austria, Belgium, Finland, France, Germany, the Netherlands, Norway, and Sweden)	L19361-001
Europe (Austria, Belgium, Finland, France, Germany, the Netherlands, Norway, and Sweden) (halogen free)	M79266-001
Israel	L19362-001
Israel (halogen free)	M82712-001
India	L19363-001
Italy	L19364-001
Japan	L19365-001

**Table 2-2** Miscellaneous parts and their descriptions (continued)

Description	Spare part number
Korea	L19366-001
North America	L19367-001
The People's Republic of China	L19368-001
South Africa	L19369-001
Switzerland	L19370-001
Switzerland (halogen free)	M79265-001
Thailand	L19371-001
Taiwan	L19372-001
The United Kingdom	L19373-001
The United Kingdom (halogen free)	M82711-001

**Table 2-3** Spare part country codes

For use in country or region	Spare part number	For use in country or region	Spare part number	For use in country or region	Spare part number
Belgium	-A41	Iceland	-DD1	Saudi Arabia	-171
Brazil	-201	India	-D61	Slovenia	-BA1
Bulgaria	-261	Israel	-BB1	South Korea	-AD1
Chile	-161	Italy	-061	Spain	-071
Czech Republic/Slovakia	-FL1	Japan	-291	Switzerland	-BG1
Denmark, Finland, and Norway	-DH1	Kazakhstan	-DF1	Taiwan	-AB1
French Canada	-DB1	The Netherlands	-B31	Thailand	-281
France	-051	Northern Africa	-FP1	Turkey	-141
Germany	-041	Portugal	-131	Ukraine	-BD1
Greece	-151	Romania	-271	United Kingdom	-031
Hungary	-211	Russia	-251	United States	-001

# 3 Routine care, drive guidelines, and disassembly preparation

This information provides general service information for the computer. Adherence to the procedures and precautions is essential for proper service.

 **IMPORTANT:** When the computer is plugged into an AC power source, DC voltage is always applied to the system board. You must disconnect the power cord from the power source before opening the computer to prevent electric shock, system board, or component damage.

## Electrostatic discharge information

A sudden discharge of static electricity from your finger or other conductor can destroy static-sensitive devices or microcircuitry. Often the spark is neither felt nor heard, but damage occurs.

An electronic device exposed to electrostatic discharge (ESD) might not appear to be affected at all and can work perfectly throughout a normal cycle. The device might function normally for a while, but it has been degraded in the internal layers, reducing its life expectancy.

Networks built into many integrated circuits provide some protection, but in many cases, the discharge contains enough power to alter device parameters or melt silicon junctions.

 **IMPORTANT:** To prevent damage to the device when you are removing or installing internal components, observe these precautions:

- Keep components in their electrostatic-safe containers until you are ready to install them.
- Before touching an electronic component, discharge static electricity by using the guidelines described in this section.
- Avoid touching pins, leads, and circuitry. Handle electronic components as little as possible.
- If you remove a component, place it in an electrostatic-safe container.

## Generating static electricity

This table shows how humidity affects the electrostatic voltage levels generated by different activities. A product can be degraded by 700 V of static electricity.

- Different activities generate different amounts of static electricity.
- Static electricity increases as humidity decreases.

Multiple electric components can be packaged in plastic tubes, trays, or polystyrene foam.

**Table 3-1** Static electricity occurrence based on activity and humidity

Event	Relative humidity		
	55%	40%	10%

**Table 3-1 Static electricity occurrence based on activity and humidity (continued)**

	Relative humidity		
Walking across carpet	7,500 V	15,000 V	35,000 V
Walking across vinyl floor	3,000 V	5,000 V	12,000 V
Motions of bench worker	400 V	800 V	6,000 V
Removing DIPs (dual in-line packages) from plastic tube	400 V	700 V	2,000 V
Removing DIPs from vinyl tray	2,000 V	4,000 V	11,500 V
Removing DIPs from polystyrene foam	3,500 V	5,000 V	14,500 V
Removing bubble pack from PCB (printed circuit board)	7,000 V	20,000 V	26,500 V
Packing PCBs in foam-lined box	5,000 V	11,000 V	21,000 V

## Preventing electrostatic damage to equipment

Many electronic components are sensitive to ESD. Circuitry design and structure determine the degree of sensitivity. The following packaging and grounding precautions are necessary to prevent static electricity damage to electronic components.

- To avoid hand contact, transport products in static-safe containers such as tubes, bags, or boxes.
- Protect all electrostatic parts and assemblies with conductive or approved containers or packaging.
- Keep electrostatic-sensitive parts in their containers until they arrive at static-free stations.
- Place items on a grounded surface before removing them from their container.
- Always be properly grounded when touching a sensitive component or assembly.
- Avoid contact with pins, leads, or circuitry.
- Place reusable electrostatic-sensitive parts from assemblies in protective packaging or conductive foam.

## Personal grounding methods and equipment

Use this equipment to prevent static electricity damage to electronic components.

- **Wrist straps** are flexible straps with a maximum of 1 MΩ ±10% resistance in the ground cords. To provide proper ground, wear a strap snug against bare skin. Verify that the ground cord is connected and fits snugly into the banana plug connector on the grounding mat or workstation.
- **Heel straps/Toe straps/Boot straps** can be used at standing workstations and are compatible with most types of shoes or boots. On conductive floors or dissipative floor mats, use them on both feet with a maximum of 1 MΩ ±10% resistance between the operator and ground.

**Table 3-2 Static shielding protection levels**

Static shielding protection levels	
Method	Voltage

**Table 3-2 Static shielding protection levels (continued)**

Static shielding protection levels	
Antistatic plastic	1,500 V
Carbon-loaded plastic	7,500 V
Metallized laminate	15,000 V

## Grounding the work area

To prevent static damage at the work area, use these precautions.

- Cover the work surface with approved static-dissipative material. Provide a wrist strap connected to the work surface and properly grounded tools and equipment.
- Use static-dissipative mats, foot straps, or air ionizers to give added protection.
- Handle electrostatic sensitive components, parts, and assemblies by the case or PCB laminate. Handle them only at static-free work areas.
- Turn off power and input signals before inserting and removing connectors or test equipment.
- Use fixtures made of static-safe materials when fixtures must directly contact dissipative surfaces.
- Keep work area free of nonconductive materials such as ordinary plastic assembly aids and polystyrene foam.
- Use field service tools, such as cutters, screwdrivers, and vacuums, that are conductive.

## Recommended materials and equipment

HP recommends these materials and equipment to prevent static electricity.

- Antistatic tape
- Antistatic smocks, aprons, or sleeve protectors
- Conductive bins and other assembly or soldering aids
- Conductive foam
- Conductive tabletop workstations with ground cord of  $1\text{ M}\Omega \pm 10\%$  resistance
- Static-dissipative table or floor mats with hard tie to ground
- Field service kits
- Static awareness labels
- Wrist straps and footwear straps providing  $1\text{ M}\Omega \pm 10\%$  resistance
- Material handling packages
- Conductive plastic bags
- Conductive plastic tubes
- Conductive tote boxes

- Opaque shielding bags
- Transparent metallized shielding bags
- Transparent shielding tubes

## Operating guidelines

This information details how to prevent overheating and to help prolong the life of the computer.

- Keep the computer away from excessive moisture, direct sunlight, and extremes of heat and cold.
- Operate the computer on a sturdy, level surface. Leave a 10.2 cm (4 inch) clearance on all vented sides of the computer and above the monitor to permit the required airflow.
- Do not restrict the airflow into the computer by blocking any vents or air intakes. Do not place the keyboard, with the keyboard feet down, directly against the front of the desktop unit as this also restricts airflow.
- Occasionally clean the air vents on all vented sides of the computer. Lint, dust, and other foreign matter can block the vents and limit the airflow. Be sure to unplug the computer before cleaning the air vents.
- Do not operate the computer with the cover or side panel removed.
- Do not stack computers on top of each other or place computers so near each other that they are subject to each other's recirculated or preheated air.
- If the computer is to be operated within a separate enclosure, intake and exhaust ventilation must be provided on the enclosure, and the same operating guidelines listed previously still apply.
- Keep liquids away from the computer and keyboard.
- Do not cover the ventilation slots on the monitor with any type of material.
- Install or enable power management functions of the operating system or other software, including Sleep states.

## Routine care

Use this information to properly care for your computer.

### General cleaning safety precautions

Use this information to safely clean your computer.

---

**⚠ CAUTION:** To prevent electric shock or damage to components, never clean a product while it is turned on or plugged in.

---

- Never use solvents or flammable solutions to clean the computer.
- Never immerse any parts in water or cleaning solutions; apply any liquids to a clean cloth and then use the cloth on the component.
- Always unplug the computer when cleaning with liquids or damp cloths.
- Always unplug the computer before cleaning the keyboard, mouse, or air vents.

- Disconnect the keyboard before cleaning it.
- Wear safety glasses equipped with side shields when cleaning the keyboard.

## Removing dirt and debris from your computer

Here are the recommended steps to clean dirt and debris from your computer.

1. Wear disposable gloves made of latex (or nitrile gloves, if you are latex-sensitive) when cleaning the surfaces.
2. Turn off your device and unplug the power cord and other connected external devices. Remove any installed batteries from items such as wireless keyboards.

---

 **CAUTION:** To prevent electric shock or damage to components, never clean a product while it is turned on or plugged in.

---

3. Moisten a microfiber cloth with water. The cloth should be moist, but not dripping wet.

---

 **IMPORTANT:** To avoid damaging the surface, avoid abrasive cloths, towels, and paper towels.

---

4. Wipe the exterior of the product gently with the moistened cloth.

---

 **IMPORTANT:** Keep liquids away from the product. Avoid getting moisture in any openings. If liquid makes its way inside your HP product, it can cause damage to the product. Do not spray liquids directly on the product. Do not use aerosol sprays, solvents, abrasives, or cleaners containing hydrogen peroxide or bleach that might damage the finish.

---

5. Start with the display (if applicable). Wipe carefully in one direction, and move from the top of the display to the bottom. Finish with any flexible cables, like power cord, keyboard cable, and USB cables.
6. Be sure that surfaces have completely air-dried before turning the device on after cleaning.
7. Discard the gloves after each cleaning. Clean your hands immediately after you remove the gloves.

See [Cleaning your computer with a disinfectant on page 15](#) for recommended steps to clean the high-touch, external surfaces on your computer to help prevent the spread of harmful bacteria and viruses.

## Cleaning your computer with a disinfectant

The World Health Organization (WHO) recommends cleaning surfaces, followed by disinfection, as a best practice for preventing the spread of viral respiratory illnesses and harmful bacteria.

After cleaning the external surfaces of your computer using the steps in [Removing dirt and debris from your computer on page 15](#), you might also choose to clean the surfaces with a disinfectant. A disinfectant that is within HP's cleaning guidelines is an alcohol solution consisting of 70% isopropyl alcohol and 30% water. This solution is also known as rubbing alcohol and is sold in most stores.

Follow these steps when disinfecting high-touch, external surfaces on your computer:

1. Wear disposable gloves made of latex (or nitrile gloves, if you are latex-sensitive) when cleaning the surfaces.

2. Turn off your device and unplug the power cord and other connected external devices. Remove any installed batteries from items such as wireless keyboards.

---

 **CAUTION:** To prevent electric shock or damage to components, never clean a product while it is turned on or plugged in.

---

3. Moisten a microfiber cloth with a mixture of 70% isopropyl alcohol and 30% water. The cloth should be moist, but not dripping wet.

---

 **CAUTION:** Do not use any of the following chemicals or any solutions that contain them, including spray-based surface cleaners: bleach, peroxides (including hydrogen peroxide), acetone, ammonia, ethyl alcohol, methylene chloride, or any petroleum-based materials, such as gasoline, paint thinner, benzene, or toluene.

 **IMPORTANT:** To avoid damaging the surface, avoid abrasive cloths, towels, and paper towels.

---

4. Wipe the exterior of the product gently with the moistened cloth.

---

 **IMPORTANT:** Keep liquids away from the product. Avoid getting moisture in any openings. If liquid makes its way inside your HP product, it can cause damage to the product. Do not spray liquids directly on the product. Do not use aerosol sprays, solvents, abrasives, or cleaners containing hydrogen peroxide or bleach that might damage the finish.

---

5. Start with the display (if applicable). Wipe carefully in one direction, and move from the top of the display to the bottom. Finish with any flexible cables, like power cord, keyboard cable, and USB cables.
6. Be sure that surfaces have completely air-dried before turning the device on after cleaning.
7. Discard the gloves after each cleaning. Clean your hands immediately after you remove the gloves.

## Cleaning the computer case

Follow all safety precautions before cleaning the computer case.

To clean the computer case, follow these procedures:

---

 **NOTE:** You can also use these procedures to clean the tops of the keys, keyboard body, monitor body, or mouse body.

---

- To remove light stains or dirt, use plain water with a clean, lint-free cloth or swab.
- For stronger stains, use a mild dishwashing liquid diluted with water. Rinse well by wiping it with a cloth or swab dampened with clear water.
- For stubborn stains, use isopropyl (rubbing) alcohol. No rinsing is needed because the alcohol evaporates quickly and does not leave a residue.
- After cleaning, always wipe the unit with a clean, lint-free cloth.
- Occasionally clean the air vents on the computer. Lint and other foreign matter can block the vents and limit the airflow.

## Cleaning the keyboard

Use this information to properly clean the keyboard. Follow all safety precautions before cleaning the keyboard.

To clean the tops of the keys or the keyboard body, follow the procedures described in [Cleaning the computer case on page 16](#).

When cleaning debris from under the keys, review all rules in [General cleaning safety precautions on page 14](#) before following these procedures.

---

**⚠ CAUTION:** Use safety glasses equipped with side shields before attempting to clean debris from under the keys.

---

- You can remove visible debris underneath or between the keys by vacuuming or shaking.
- You can use canned, pressurized air to clean debris from under the keys. Use caution because too much air pressure can dislodge lubricants applied under the wide keys.
- If you remove a key, use a specially designed key puller to prevent damage to the keys. This tool is available through many electronic supply outlets.

---

**📌 IMPORTANT:** Never remove a wide leveled key (like the space bar) from the keyboard. If these keys are improperly removed or installed, the keyboard might not function properly.

---

- You can clean under a key with a swab moistened with isopropyl alcohol and squeezed out. Be careful not to wipe away lubricants necessary for proper key functions. Use tweezers to remove any fibers or dirt in confined areas. Allow the parts to air dry before reassembly.

## Cleaning the monitor

Follow all safety precautions before cleaning dirt and debris from your computer. Use this information to properly clean the monitor.

- Wipe the monitor screen with a clean cloth moistened with water or with a towelette designed for cleaning monitors. Do not use sprays or aerosols directly on the screen; the liquid can seep into the housing and damage a component. Never use solvents or flammable liquids on the monitor.
- To clean the monitor body, follow the procedures in [Cleaning the computer case on page 16](#).

## Cleaning the mouse

Follow all safety precautions before cleaning your mouse. Use this information to properly clean the mouse.

To clean the mouse body, follow the procedures in [Cleaning the computer case on page 16](#).

## Service considerations

Keep these considerations in mind during the disassembly and assembly of the computer.

## Tools and software requirements

Servicing the computer requires these tools.

- Torx T-15 screwdriver
- Flat-bladed screwdriver (can sometimes be used in place of the Torx screwdriver)
- Phillips PH1 screwdriver
- Nonconductive, nonmarking pry tool

- Diagnostics software

## Screws

The screws used in the computer are not interchangeable. They could have standard or metric threads and might be of different lengths.

If you use an incorrect screw during the reassembly process, it can damage the unit. HP strongly recommends that you keep all screws that you remove during disassembly with the removed part and then return them to their proper locations.



---

**IMPORTANT:** As you remove each subassembly from the computer, place it away from the work area to prevent damage.

---

## Cables and connectors

Use this information to properly handle cables.

Apply only the tension required to seat or unseat the cables during insertion or removal from the connector. Handle cables by the connector whenever possible. In all cases, avoid bending or twisting the cables, and route the cables so that they cannot be caught or snagged by parts being removed or replaced.

### Graphics cards adapter cables

To prevent electrical issues, only use high-quality, HP certified 12VHPWR adapter cables. Be sure to fully insert the 12VHPWR connector into a graphics card until it clicks into place. A loose connection can cause overheating and could be a potential fire hazard. Do not sharply bend the cable near the connector. Maintain at least a 35 mm bending radius to prevent strain on the connection. Check for discoloration, burnt smell, or signs of damage before and after use. If you find any abnormalities, immediately stop using the cable.



---

**IMPORTANT:** When servicing this computer, be sure to place cables in their proper location during the reassembly process. Improper cable placement can damage the computer.

---

## Hard drives

Handle hard drives as delicate, precision components, and avoid all physical shock and vibration. This advice applies to failed drives as well as replacement spares.

- If a drive must be mailed, place the drive in a bubble-pack mailer or other suitable protective packaging and label the package “Fragile: Handle With Care.”
- Do not remove hard drives from the shipping package for storage. Keep hard drives in their protective packaging until they are actually mounted in the computer.
- Avoid dropping drives from any height onto any surface.
- If you are inserting or removing a hard drive, turn off the computer. Do not remove a hard drive while the computer is on or in standby mode.
- Before handling a drive, ensure that you are discharged of static electricity. While handling a drive, avoid touching the connector.
- Do not use excessive force when inserting a drive.

- Avoid exposing a hard drive to liquids, temperature extremes, or products that have magnetic fields such as monitors or speakers.

## Lithium coin cell battery

The battery that comes with the computer provides power to the real-time clock and has a minimum lifetime of approximately three years.

See the removal and replacement chapter for replacement instructions.

---

 **WARNING!** This computer contains a lithium battery. There is a risk of fire and chemical burn if the battery is handled improperly. Do not disassemble, crush, puncture, short external contacts, dispose of in water or fire, or expose it to temperatures higher than 140°F (60°C). Do not attempt to recharge the battery.

 **NOTE:** Do not dispose of batteries, battery packs, and accumulators with general household waste. To forward them to recycling centers or proper disposal, use the public collection system or return them to HP, their authorized partners, or their agents.

---

## Cable management

Always follow good cable management practices when working inside the computer.

- Keep cables away from major heat sources like the heat sink.
- Keep cables clear of sliding or moveable parts to prevent them from being cut or crimped when the parts are moved.
- When folding a flat ribbon cable, never fold to a sharp crease. Sharp creases can damage the wires.
- Do not bend any cable sharply. A sharp bend can break the internal wires.
- Never bend a SATA data cable tighter than a 30 mm (1.18 in) radius.
- Never crease a SATA data cable.

---

## 4 Removal and replacement procedures for Customer Self-Repair parts

This chapter provides removal and replacement procedures for Customer Self-Repair parts.

 **NOTE:** The Customer Self-Repair program is not available in all locations. Installing a part that is not supported by the Customer Self-Repair program can void your warranty. Check your warranty to determine whether Customer Self-Repair is supported in your location.

 **NOTE:** The [HP Support YouTube Channel](#) (in English) has videos that provide step-by-step removal and replacement instructions for many common parts and models.

---

### Component replacement procedures

To remove and replace computer components, use these procedures.

 **NOTE:** Details about your computer, including the model, serial number, product key, and length of warranty, are on the service tag at the bottom of your computer.

 **NOTE:** HP continually improves and changes product parts. For complete and current information about supported parts for your computer, go to <https://partsurfer.hp.com/>, select your country or region, and then follow the on-screen instructions.

---

Make special note of each screw size and location during removal and replacement.

### Preparation for disassembly

Use this information to properly prepare to disassemble and reassemble the computer.

See [Routine care, drive guidelines, and disassembly preparation on page 11](#) for initial safety procedures.

1. Turn off the computer. If you are unsure whether the computer is off or in Hibernation, turn the computer on, and then shut it down through the operating system.

 **IMPORTANT:** Turn off the computer before disconnecting any cables.

Regardless of the power state, voltage is always present on the system board as long as the system is plugged into an active AC outlet. In some systems, the cooling fan is on even when the computer is in the Standby or Suspend modes. Always disconnect the power cord before servicing a unit.

---

2. Disconnect the power from the computer by unplugging the power cord from the computer.
3. Disconnect all external devices from the computer.

 **CAUTION:** Beware of sharp edges inside the chassis.

 **NOTE:** During disassembly, label each cable as you remove it, and note its position and routing. Keep all screws with the removed components.

---

## Access panel

To remove the access panel, use these procedures.

**Table 4-1** Access panel description and part number

Description	Spare part number
Access panel	not available as a spare part

**IMPORTANT:** On workstations, the computer will not turn on if a removable access panel is not installed, and the computer displays error code 3.7.

Before removing the access panel, follow these steps:

- Prepare the computer for disassembly (see [Preparation for disassembly on page 20](#)).

Remove the access panel:

- Loosen the thumbscrew (1) on the rear of the computer, slide the panel (2) forward, and lift it off the computer (3).

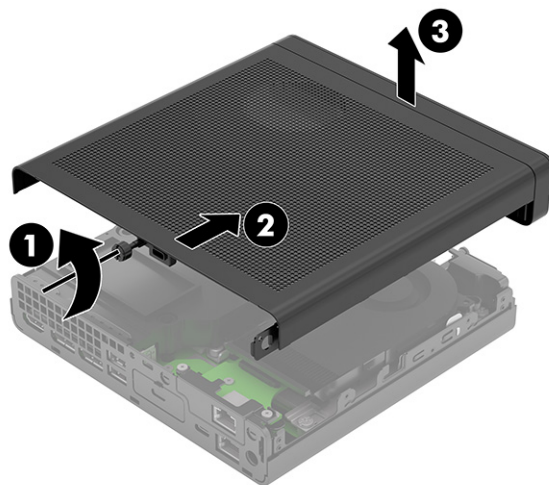

To install the access panel, reverse the removal procedure.

## Fans

To remove the fan, use these procedures.

**Table 4-2** Fan descriptions and part numbers

Description	Spare part number
Fan	P34938-001
Fan (smaller)	P35210-001

Before removing the fan, follow these steps:

1. Prepare the computer for disassembly (see [Preparation for disassembly on page 20](#)).
2. Remove the access panel (see [Access panel on page 21](#)).

Remove the large fan:

1. Lift the fan (1) up to about 45°, and then disconnect the fan cable (2) from the system board.
2. Lift the fan out of the computer (3).

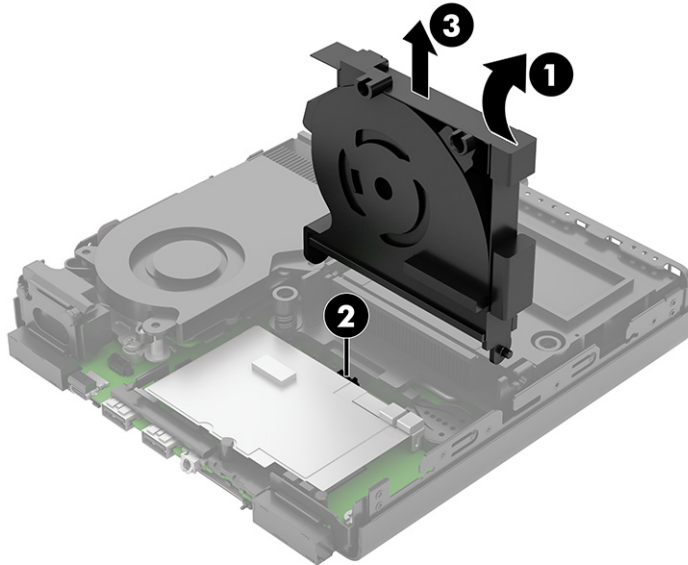

Remove the smaller fan:

3. Remove the three screws (1) that secure the fan to the computer.
4. Remove the fan from the computer (2).

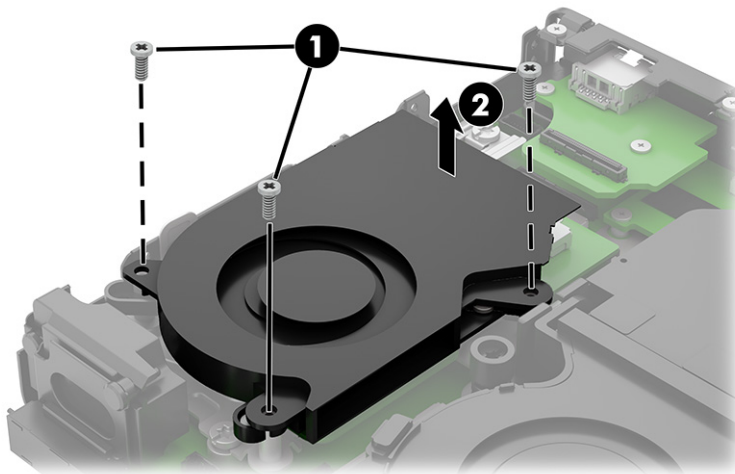

To install the fan, reverse the removal procedure.

## Speaker

To remove the speaker, use these procedures. A single speaker is located on the left side of the computer behind the front bezel, inside the chassis.

**Table 4-3 Speaker description and part number**

Description	Spare part number
Speaker	P35215-001

Before removing the speaker, follow these steps:

1. Prepare the computer for disassembly (see [Preparation for disassembly on page 20](#)).
2. Remove the access panel (see [Access panel on page 21](#)).

Remove the speaker:

1. From the front of the computer, pull up on the tabs **(1)** that secure the speaker.
2. Disconnect the speaker cable from the system board connector **(2)**.
3. Lift to remove the speaker **(3)** from the computer.

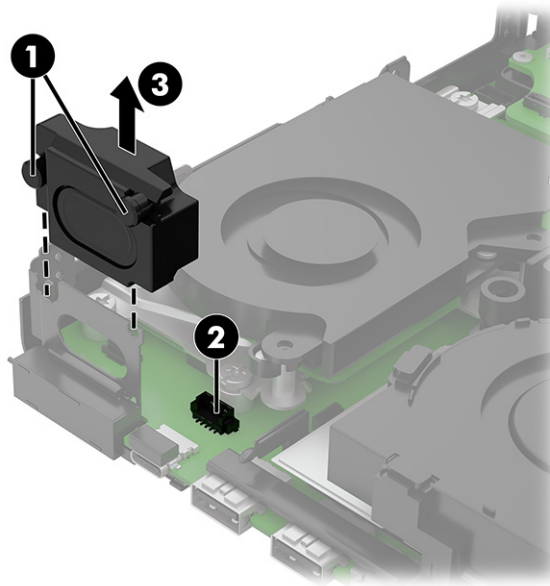

To install the speaker, reverse the removal procedures.

## WLAN module

To remove the WLAN module, use these procedures.

**Table 4-4 WLAN module descriptions and part numbers**

Description	Spare part number
Intel Wi-Fi 7 BE200, vPro + Bluetooth 5.4	N39882-001
Intel Wi-Fi 7 BE200, non-vPro + Bluetooth 5.4	N39883-001

**Table 4-4 WLAN module descriptions and part numbers (continued)**

Description	Spare part number
Realtek RTL8852CE Wi-Fi® 6E + Bluetooth® 5.3	N19618-001

 **NOTE:** WLAN module appearance can vary.

Before removing the WLAN module, follow these steps:

1. Prepare the computer for disassembly (see [Preparation for disassembly on page 20](#)).
2. Remove the access panel (see [Access panel on page 21](#)).
3. Remove the fan (see [Fans on page 21](#)).
4. Remove the solid-state drive from the metal bracket (see [Solid-state drive \(on support bracket\) on page 28](#)).
5. Remove the solid-state drive board (see [Solid-state drive on page 30](#)).

Remove the WLAN module:

1. Remove the tape (1) from the top of the WLAN module.
2. Disconnect the antenna cables (2) from the module.

 **NOTE:** The WLAN antenna cable labeled 1/MAIN connects to the WLAN module Main terminal. The WLAN antenna cable labeled 2/AUX connects to the WLAN module Aux terminal.

3. Remove the screw (3) that secures the module to the computer.
4. Pull the module (4) out of the socket.

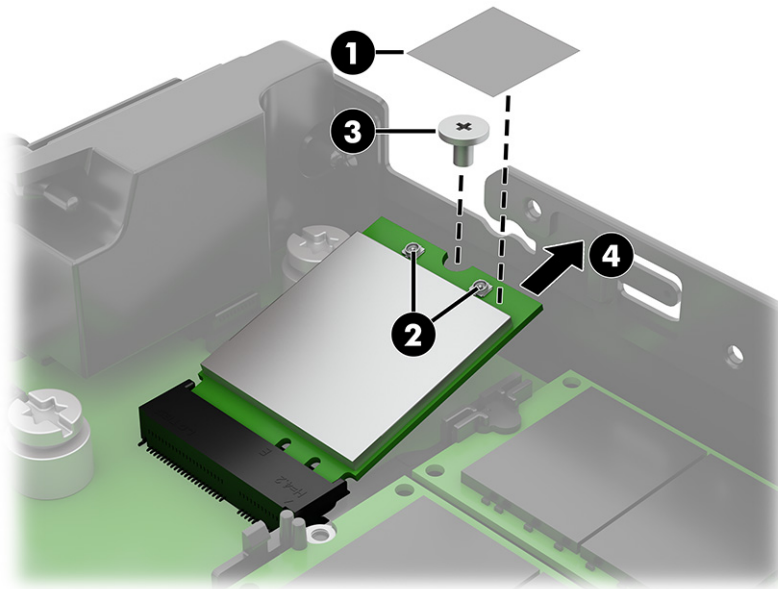

5. If the WLAN antenna is not connected to the terminal on the WLAN module, a protective sleeve must be installed on the antenna connector, as shown in the following illustration.

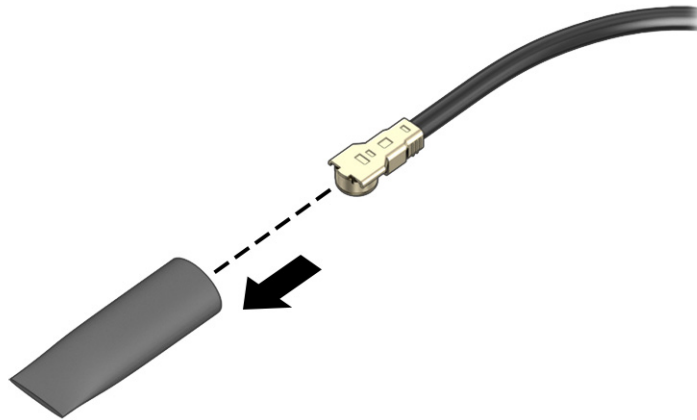

To install the WLAN module, reverse the removal procedure.

 **NOTE:** WLAN modules are designed with a notch to prevent incorrect insertion.

## Memory modules (SODIMMs)

To remove the memory modules, use the information in this section.

**Table 4-5** Memory module descriptions and part numbers

Description	Spare part number
16 GB, DDR 5600	N38627-001
16 GB, DDR 5600	N77399-001
8 GB, DDR 5600	N77398-001
8 GB, DDR 5600	N37792-001

Use this information to correctly populate SODIMM sockets:

- There are two SODIMM sockets on the system board, with one socket per channel. The sockets are labeled DIMM1 and DIMM3. The DIMM1 socket operates in memory channel B. The DIMM3 socket operates in memory channel A.
- The computer comes with double data rate 5 synchronous dynamic random access memory (DDR5-SDRAM) small outline dual inline memory modules (SODIMMs).
- The memory sockets are populated with at least one preinstalled SODIMM. To achieve the maximum memory support, you can populate the system board with up to 64 GB of memory.

DDR5-SDRAM SODIMMs requirements:

- Industry-standard 262 pin

- Unbuffered non-ECC DDR5-5600 MHz-compliant
- 1.1 V DDR5-SDRAM SODIMMs
- Supports maximum DDR5-5600 MHz

In addition, the computer supports:

- 256 Mbit, 512 Mbit, 1 Gbit, and 2 Gbit non-ECC memory technologies
- Single-sided and double-sided SODIMMS
- SODIMMs constructed with ×8 and ×16 devices; SODIMMs constructed with ×4 SDRAM are not supported

 **NOTE:** The system will not operate properly if you install unsupported SODIMMs.

 **IMPORTANT:** You must disconnect the power cord and wait approximately 30 seconds for the power to drain before adding or removing memory modules. Regardless of the power state, voltage is always supplied to the memory modules as long as the computer is plugged into an active AC outlet. Adding or removing memory modules while voltage is present can cause irreparable damage to the memory modules or system board.

 **IMPORTANT:** When handling a memory module, be careful not to touch any of the contacts. Doing so can damage the module.

The memory module sockets have gold-plated metal contacts. When upgrading the memory, use memory modules with gold-plated metal contacts to prevent corrosion, oxidation, or both, resulting from having incompatible metals in contact with each other.

Static electricity can damage the electronic components of the computer or optional cards. Before beginning these procedures, be sure that you are discharged of static electricity by briefly touching a grounded metal object.

**Table 4-6 Memory module socket locations**

Item	Description	System Board Label	Socket Color
1	SODIMM1 socket, channel A	DIMM1	Black
2	SODIMM3 socket, channel B	DIMM3	Black

The system automatically operates in single-channel mode, dual-channel mode, or flex mode, depending on how the SODIMMs are installed.

- The system operates in single-channel mode if the SODIMM sockets are populated in one channel only.
- The system operates in a higher-performing dual-channel mode if the memory capacity of the SODIMM in channel A is equal to the memory capacity of the SODIMM in channel B.
- In any mode, the maximum operational speed is determined by the slowest SODIMM in the system.

Before replacing the memory modules, follow these steps:

1. Prepare the computer for disassembly (see [Preparation for disassembly on page 20](#)).
2. Remove the access panel (see [Access panel on page 21](#)).

3. Remove the fan (see [Fans on page 21](#)).

Remove a memory module:

1. To remove a SODIMM, lift up the DIMM shield (1), press outward on the two latches (2) on each side of the SODIMM, and then pull the SODIMM (3) out of the socket.

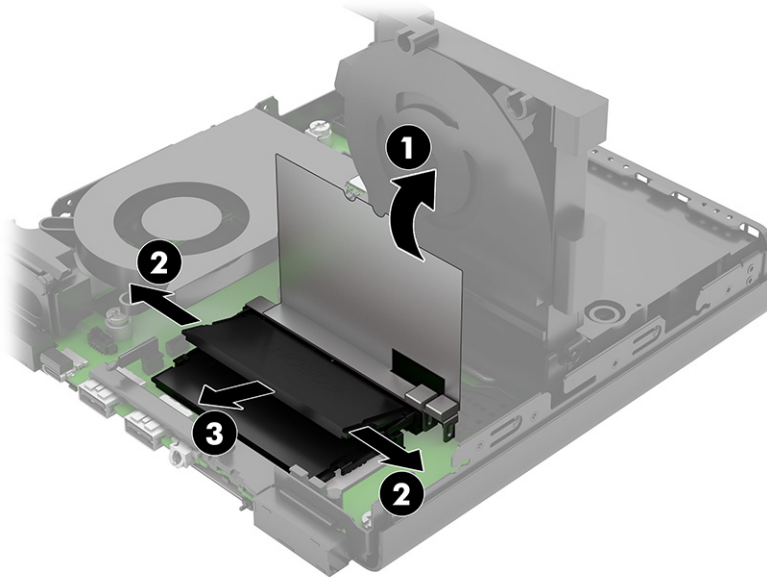

2. Match the notch on the module with the tab on the memory socket (1). Slide the new SODIMM into the socket at approximately a 30° angle, and then press the SODIMM (2) down so that the latches lock it in place.

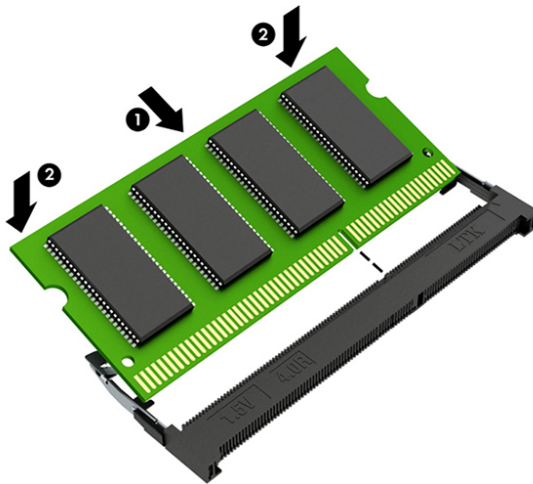

---







 **NOTE:** A memory module can be installed in only one way.

---

The computer automatically recognizes the additional memory when you turn on the computer.

# 5 Removal and replacement procedures

This chapter provides removal and replacement procedures.

-  **NOTE:** The Customer Self-Repair program is not available in all locations. Installing a part that is not supported by the Customer Self-Repair program can void your warranty. Check your warranty to determine whether Customer Self-Repair is supported in your location.
-  **NOTE:** The [HP Support YouTube Channel](#) (in English) has videos that provide step-by-step removal and replacement instructions for many common parts and models.
-  **NOTE:** Details about your computer, including model, serial number, product key, and length of warranty, are on the service tag.
-  **NOTE:** HP continually improves and changes product parts. For complete and current information about supported parts for your computer, go to <https://partsurfer.hp.com/>, select your country or region, and then follow the on-screen instructions.
-  **IMPORTANT:** Adherence to these procedures and precautions is essential for proper service. After completing all necessary removal and replacement procedures, run the Diagnostics utility to verify that all components operate properly.
-  **NOTE:** Not all features listed in this guide are available on all computers.

## Component replacement procedures

To remove and replace computer components, use the procedures described in this section.

-  **NOTE:** HP continually improves and changes product parts. For complete and current information about supported parts for your computer, go to <https://partsurfer.hp.com/>, select your country or region, and then follow the on-screen instructions.

Make special note of each screw size and location during removal and replacement.

### Solid-state drive (on support bracket)

To remove the solid-state drive, use these procedures.

**Table 5-1 Solid-state drive (SSD) module descriptions and part numbers**

Description	Spare part number
2 TB, TLC	N77396-002
2 TB, ZTurbo	M52027-001
1 TB, TLC	M16560-001
1 TB, value	P17111-001
1 TB, TLC (PRC)	N77395-002
1 TB (PRC)	N77394-002
512 GB (PRC)	N77392-002

**Table 5-1** Solid-state drive (SSD) module descriptions and part numbers (continued)

Description	Spare part number
512 GB, TLC (PRC)	N77393-002
512 GB, value	N44321-001
512 GB, TLC	M17436-001
512 GB, TLC, SED	M52031-002
256 GB (PRC)	N77391-002
256 GB, SED	N35225-002
256 GB	N30732-001

Before removing the solid-state drive, follow these steps:

1. Prepare the computer for disassembly (see [Preparation for disassembly on page 20](#)).
2. Remove the access panel (see [Access panel on page 21](#)).

Remove the solid-state drive module from the support bracket:

1. Lift the solid-state drive cover (1) up, and then remove the screw (2) that secures the drive.
2. Pull the drive (2) out of the system board connector (3).

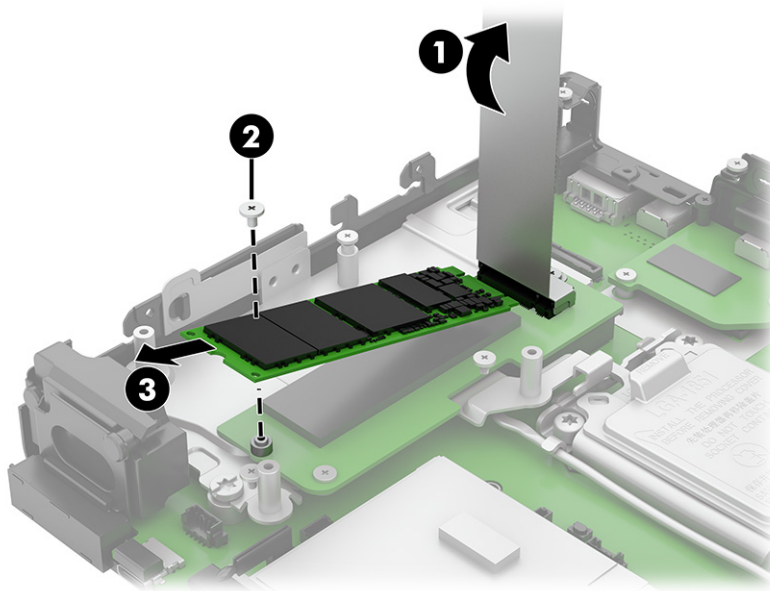

To install the solid-state drive, reverse the removal procedure.

## Support bracket

To remove the support bracket, use these procedures.

**Table 5-2** Support bracket description and part number

Description	Spare part number
Support bracket	not available as a spare part

Before removing the support bracket, follow these steps:

1. Prepare the computer for disassembly (see [Preparation for disassembly on page 20](#)).
2. Remove the access panel (see [Access panel on page 21](#)).

Remove the support bracket:

1. Remove the screws that secure the support bracket (1) to the system board.
2. Lift the support bracket out of the computer (2).

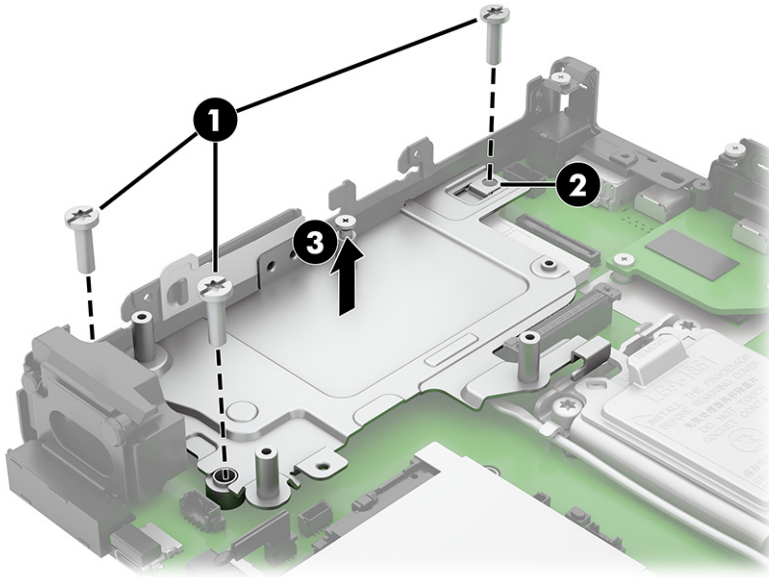

To install the support bracket, reverse the removal procedure.

## Solid-state drive

To remove the solid-state drive module, use these procedures.

**Table 5-3** Solid-state drive (SSD) module descriptions and part numbers

Description	Spare part number
2 TB, TLC	N77396-002
2 TB, ZTurbo	M52027-001
1 TB, TLC	M16560-001
1 TB, value	P17111-001
1 TB, TLC (for use in the People's Republic of China)	N77395-002

**Table 5-3 Solid-state drive (SSD) module descriptions and part numbers (continued)**

Description	Spare part number
1 TB (for use in the People's Republic of China)	N77394-002
512 GB (for use in the People's Republic of China)	N77392-002
512 GB, TLC (for use in the People's Republic of China)	N77393-002
512 GB, value	N44321-001
512 GB, TLC	M17436-001
512 GB, TLC, SED	M52031-002
256 GB (for use in the People's Republic of China)	N77391-002
256 GB, SED	N35225-002
256 GB	N30732-001

Before removing the solid-state drive module, follow these steps:

1. Prepare the computer for disassembly (see [Preparation for disassembly on page 20](#)).
2. Remove the access panel (see [Access panel on page 21](#)).

Remove the solid-state drive module:

1. Open the green latch (1) that secures the drive, and then push the connector away from the solid-state drive module.
2. Pull the drive (2) out of the system board connector.

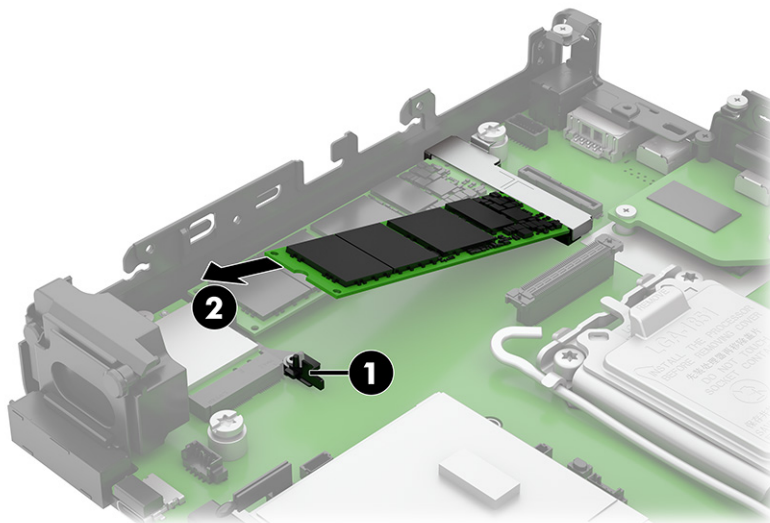

To install a solid-state drive module, reverse the removal procedure.

 **NOTE:** Solid-state drive modules are designed with a notch to prevent incorrect insertion.

## Battery

To remove the battery, use these procedures. The battery that comes with the computer provides power to the real-time clock. When replacing the battery, use a battery equivalent to the battery originally installed in the computer. The computer comes with a 3 V lithium coin cell battery.

**⚠ WARNING!** The computer contains an internal lithium manganese dioxide battery. There is a risk of fire and burns if the battery is not handled properly. To reduce the risk of personal injury:

- Do *not* attempt to recharge the battery.
- Do *not* expose to temperatures higher than 60°C (149°F).
- Do *not* disassemble, crush, puncture, short external contacts, or dispose of in fire or water.
- Replace the battery only with the HP spare part that is designated for this product.

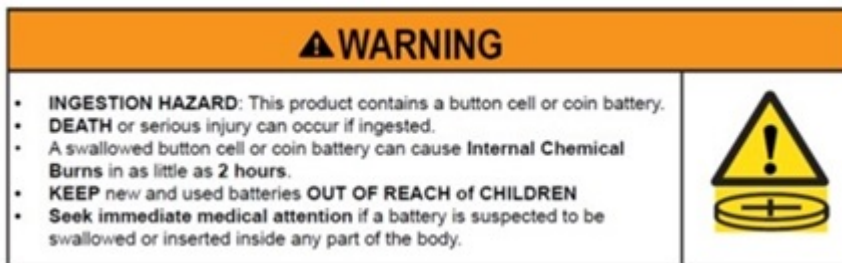

**📄 IMPORTANT:** Before replacing the battery, back up the computer CMOS settings. When the battery is removed or replaced, the CMOS settings are cleared.

Static electricity can damage the electronic components of the computer or optional equipment. Before beginning these procedures, be sure that you are discharged of static electricity by briefly touching a grounded metal object.

**📄 NOTE:** You can extend the lifetime of the lithium battery by plugging the computer into an AC outlet. The lithium battery is used only when the computer is not connected to AC power.

HP encourages customers to recycle used electronic hardware, HP original print cartridges, and rechargeable batteries. For more information about recycling programs, go to <http://www.hp.com/recycle>.

Before removing the battery, follow these steps:

1. Prepare the computer for disassembly (see [Preparation for disassembly on page 20](#)).
2. Remove the access panel (see [Access panel on page 21](#)).

Remove the battery:

1. Squeeze the latch (1), lift the cover (2) to open it, and then remove the battery.

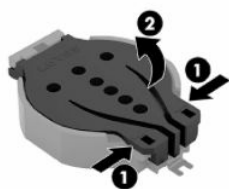

2. With the positive side up, insert the battery (1) onto the battery socket at an angle, and then press the battery (2) down until it locks into place. The battery holder automatically secures the battery in the proper position.



3. Rotate the cover (1) onto the battery socket, and then press the cover (2) down until it locks into place.



## Flex I/O connector board

To remove the flex I/O connector board, use these procedures.

**Table 5-4 Flex I/O connector board descriptions and part numbers**

Description	Spare part number
HP Flex 1 GbE fiber LC single port	M27481-002
USB to Serial	N07478-001
Dual USB Type-A	P27715-001
USB-C to DisplayPort adapter	P39602-001

Before removing the flex I/O connector board, follow these steps:

1. Prepare the computer for disassembly (see [Preparation for disassembly on page 20](#)).
2. Remove the access panel (see [Access panel on page 21](#)).

Remove the flex I/O connector board:

1. Remove the four Phillips screws (1) that secure the board to the computer.
2. Disconnect the cable from the system board.
3. Remove the board (2) from the computer.



**NOTE:** Screw and connector locations can vary depending on the type of flex I/O connector board that is installed.

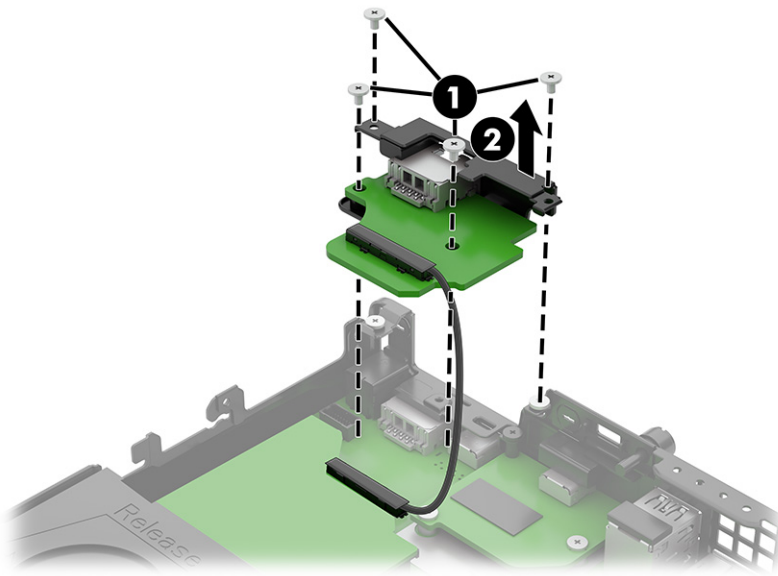

To install the flex I/O connector board, reverse the removal procedure.

## Flex I/O connector board (board-to-board)

To remove the flex I/O connector board, use these procedures.

**Table 5-5** Flex I/O connector board descriptions and part numbers

Description	Spare part number
HP DisplayPort 2.1	P27712-001
HP VGA Flex IO v3	P27714-001
HP HDMI 2.1 Flex IO v3	P27713-001
HP dual USB Type-A 3.1 Gen 1	P37127-001
HP Thunderbolt 4™ Flex IO v3	P27709-001
HP Serial Port v3 FlexIO	P37040-001
HP Dual USB Type-C 3.2 Gen2 15W Out Flex IO v3	P27711-001

Before removing the flex I/O connector board, follow these steps:

1. Prepare the computer for disassembly (see [Preparation for disassembly on page 20](#)).
2. Remove the access panel (see [Access panel on page 21](#)).
3. If applicable, remove the flex I/O connector board (see [Flex I/O connector board on page 33](#)).

Remove the flex I/O connector board:

- Remove the three Phillips screws (1) that secure the board to the computer, and then lift the board (2) to disconnect it from the connector on the system board.

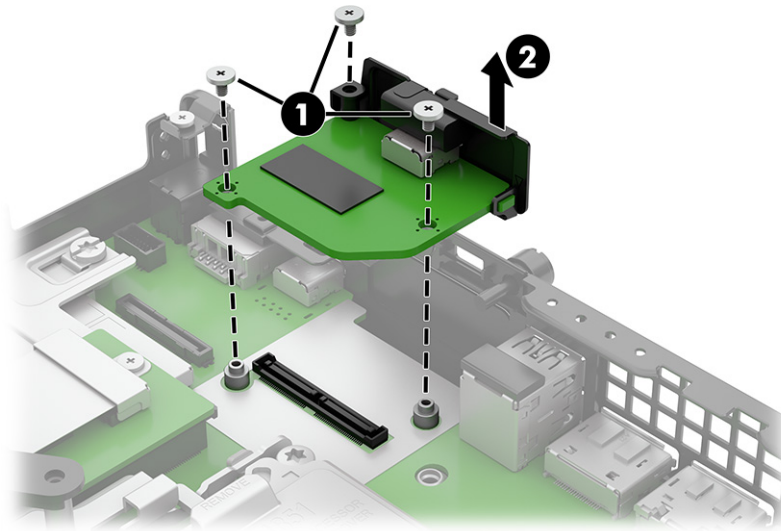

To install the flex I/O connector board, reverse the removal procedure.

## Heat sink

To remove the heat sink, use these procedures.

**Table 5-6** Heat sink description and part number

Description	Spare part number
For use in 35 W models	P34936-001

 **IMPORTANT:** The bond between the heat sink and the processor can be very tight.

If the computer will turn on, before removing the heat sink, turn on the computer until it warms the heat sink. Warming the heat sink loosens the bond between the heat sink and the processor, thereby making it easier to separate them.

Be sure not to pull the processor out of the socket when you lift the heat sink, especially if you cannot warm the heat sink before removal. Inadvertently removing the processor can damage the pins.

Before removing the heat sink, follow these steps:

1. Prepare the computer for disassembly (see [Preparation for disassembly on page 20](#)).

2. Remove the access panel (see [Access panel on page 21](#)).

Remove the heat sink:

- In the order indicated on the heat sink, loosen the three captive Torx screws (1-3), and then lift the heat sink (4) out of the computer.

 **IMPORTANT:** Be sure to loosen the screws in the order indicated by the numbers stamped on the heat sink.

 **IMPORTANT:** For optimum thermal performance, be sure not to touch the thermal grease on the surface of the processor or the heat sink.

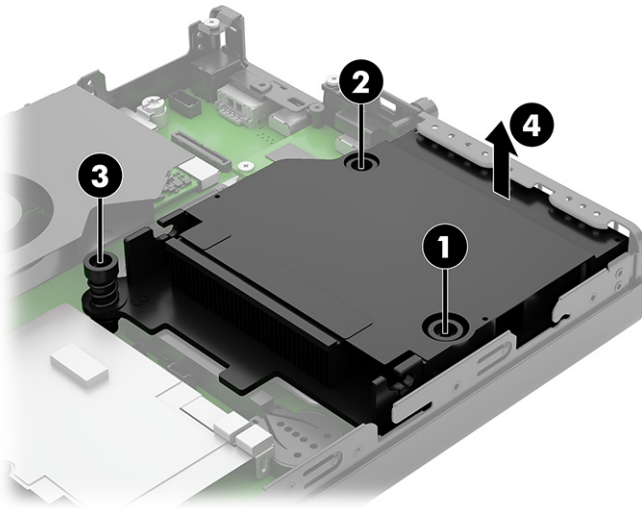

Thermal grease location

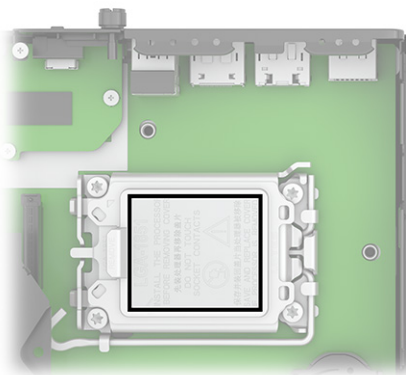

 **IMPORTANT:** Tighten heat sink retaining screws in diagonally opposite pairs (as in an X) to evenly seat the heat sink on the processor to avoid damage that could require replacing the system board.

To replace the heat sink, reverse the removal procedures.

## Processor

To remove the processor, use these procedures.

**Table 5-7 Processor descriptions and part numbers**

Description	Spare part number
Intel Core Ultra 5-235T processor with Intel UHD Graphics 3Xe (vPro, 14 core, 35 W)	P36623-003
Intel Core Ultra 7-265T processor with Intel UHD Graphics 4Xe (vPro, 20 core, 35 W)	P36624-003
Intel Core Ultra 9-285T processor with Intel UHD Graphics 4Xe (vPro, 24 core, 35 W)	P36622-003

Before removing the processor, follow these steps:

1. Prepare the computer for disassembly (see [Preparation for disassembly on page 20](#)).
2. Remove the access panel (see [Access panel on page 21](#)).
3. Remove the heat sink (see [Heat sink on page 35](#)).

Remove the processor:

1. Pull the locking lever **(1)** away from the processor socket.
2. Rotate the locking lever **(2)** to its full open position.
3. Raise and rotate the microprocessor retainer **(3)** to its fully open position.
4. Carefully lift the processor **(4)** from the socket.

 **IMPORTANT:** Do not handle the pins in the processor socket. These pins are fragile, and handling them could cause irreparable damage. If pins are damaged, you might have to replace the system board.

The heat sink must be installed within 24 hours of installing the processor to prevent damage to the processor's solder connections.

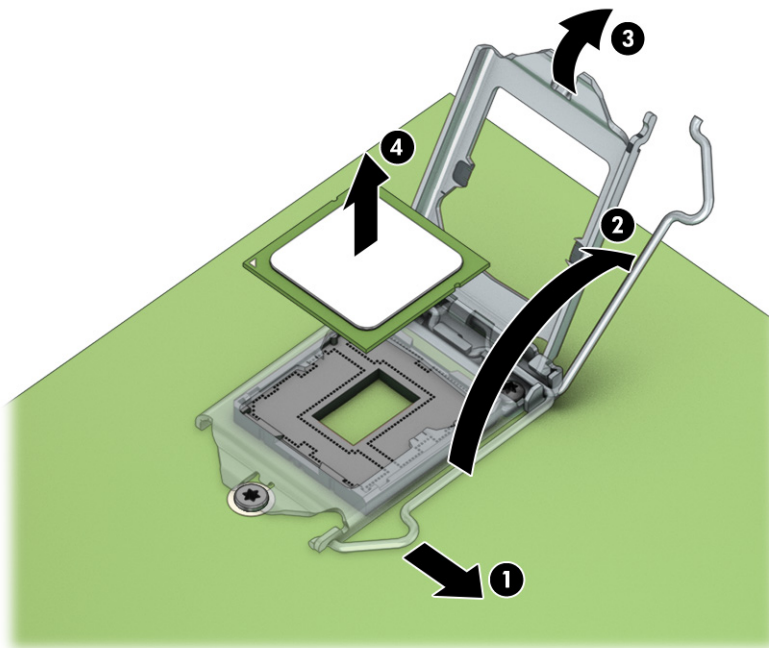

To replace the processor, reverse the removal procedures.



**NOTE:** After installing a new processor onto the system board, always update the system ROM to ensure that the latest version of the BIOS is being used on the computer. You can find the latest system BIOS on the web at: <https://support.hp.com/us-en>.

## System board

To remove the system board, use these procedures.

**Table 5-8 System board descriptions and part numbers**

Description	Spare part number
For use in models with a standard BIOS	P34930-xx1
For use in models with a NetClone BIOS	P34931-xx1



**NOTE:** All system board spare part kits include replacement thermal material.



**NOTE:** System board appearance can vary.

Before removing the system board, follow these steps:

1. Prepare the computer for disassembly (see [Preparation for disassembly on page 20](#)).
2. Remove the access panel (see [Access panel on page 21](#)).
3. Remove the heat sink (see [Heat sink on page 35](#)).
4. Remove the fan (see [Fans on page 21](#)).
5. Remove the solid-state drives (see [Solid-state drive \(on support bracket\) on page 28](#) and [Solid-state drive on page 30](#)).
6. Remove the memory modules (see [Memory modules \(SODIMMs\) on page 25](#)).
7. Remove the WLAN module (see [WLAN module on page 23](#)).
8. Remove the processor (see [Processor on page 36](#)).

Remove the system board:

1. Disconnect all cables from the system board, and note their location for reinstallation.
2. Remove the Torx screw **(1)** that secures the system board to the computer.

- Lift the left side of the system board (2), and then remove it from the computer.

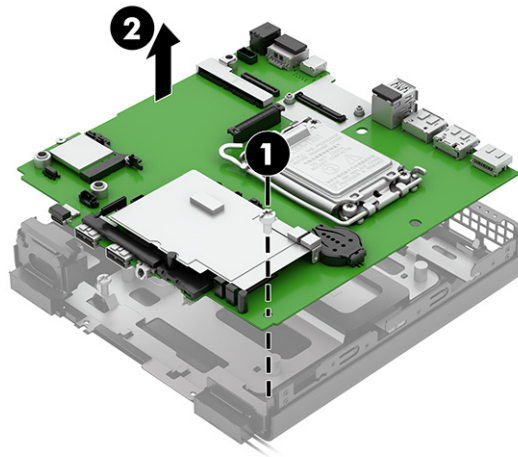

To install the system board, reverse the removal procedures.

 **NOTE:** When replacing the system board, you must change the chassis serial number in the BIOS.

When replacing the system board, you must reprogram the SMBIOS information about the affected computer. Failure to reprogram the board will result in eventual failure, such as an activation failure (need to reactivate the system) or a system recovery failure.

Update SMBIOS information in Computer Setup.

## System board callouts

Use this illustration and table to determine system board callout locations.

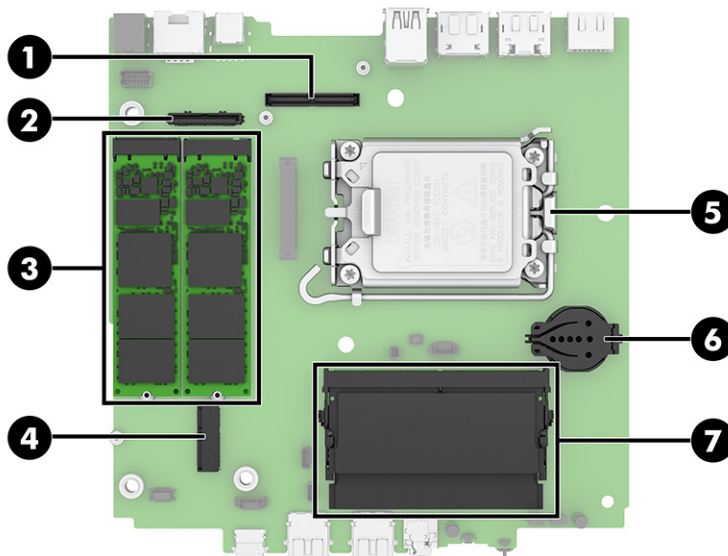

**Table 5-9 System board components**

<b>Item</b>	<b>Component</b>	<b>Item</b>	<b>Component</b>
<b>(1)</b>	Flex I/O board slot	<b>(5)</b>	Processor
<b>(2)</b>	Flex I/O board slot	<b>(6)</b>	RTC battery
<b>(3)</b>	SSD1 (solid-state drive) and SSD2 (solid-state drive)	<b>(7)</b>	SODIMM slots
<b>(4)</b>	WLAN connector		

---

## 6 Computer Setup (F10) Utility

This information provides details of the Computer Setup Utility.

- Change settings from the defaults or restore the settings to default values.
- View the system configuration, including settings for processor, graphics, memory, audio, storage, communications, and input devices.
- Modify the boot order of bootable devices such as hard drives or USB flash media devices.
- Enter the Asset Tag or property identification number assigned by the company to this computer.
- Enable the power-on password prompt during system restarts (warm boots) as well as during startup.
- Establish an administrator password that controls access to the Computer Setup (F10) Utility and the settings described in this section.
- Establish minimum requirements for valid passwords, including length and required types of characters.
- Secure integrated I/O functionality, including the serial, USB, or audio, or embedded NIC, so that they cannot be used until they are unsecured.
- Enable or disable different types of boot sources.
- Configure features such as Secure Boot, power management, virtualization support, and language and keyboard type used in Setup and POST.
- Replicate the system setup by saving system configuration information about a USB device and restoring it on one or more computers.
- Enable or disable DriveLock security or securely erase a hard drive.

### Using Computer Setup (F10) Utilities

You can access Computer Setup only by turning on the computer or restarting the system.

To access the Computer Setup Utilities menu, complete these steps:

1. Turn on or restart the computer.
2. Repeatedly press **f10** when the power button light turns white to access the utility.

You can also press **esc** to see a menu that allows you to access different options available at startup, including the Computer Setup utility.

A choice of four headings appears in the Computer Setup Utilities menu: Main, Security, Advanced, and UEFI Drivers.

---

 **NOTE:** If you do not press **f10** at the appropriate time, you must restart the computer and again repeatedly press **f10** when the power button light turns white to access the utility.

 **NOTE:** Selecting UEFI Drivers restarts the computer into the third-party option ROM management application. You can access this application directly by pressing **f3** during startup.

---

3. Use the left and right arrow keys to select the appropriate heading. Use the up and down arrow keys to select the option you want, and then press **enter**. To return to the Computer Setup Utilities menu, press **esc**.
4. To apply and save changes, select **Main > Save Changes and Exit**.
  - If you have made changes that you do not want applied, select **Ignore Changes and Exit**.
  - To restore settings from the Advanced and Main menus to original values, select **Apply Factory Defaults and Exit**.
  - To restore settings from the Advanced and Main menus to those previously saved by **Save Custom Defaults**, select **Apply Custom Defaults and Exit**. If no custom defaults have been saved, factory defaults are used.

---

 **NOTE:** You cannot modify settings in the Security menu by selecting **Apply Defaults**. You reset those values by selecting **Restore Security Settings to Factory Defaults** at the bottom of the **Security** menu.

 **NOTE:** Not all settings shown in the following sections are available for all models.

---

 **IMPORTANT:** Do not turn computer power off while the BIOS is saving the Computer Setup (F10) changes because the settings could become corrupted. It is safe to turn off the computer only after exiting the F10 Setup screen.

---

## Computer Setup Main

This table provides information about the Computer Setup Main menu.

---

 **NOTE:** Support for specific Computer Setup options can vary, depending on the hardware configuration.

---

**Table 6-1 Computer Setup Main**

Option	Description
<b>System Information</b>	Lists all information in following list if <b>Advanced System Information</b> is selected. Lists smaller subset if <b>Basic System Information</b> is selected. <ul data-bbox="528 327 946 1682" style="list-style-type: none"><li data-bbox="528 327 711 348">• Product name</li><li data-bbox="528 380 783 401">• Installed memory size</li><li data-bbox="528 432 722 453">• Processor type</li><li data-bbox="528 485 871 506">• Processor cache size (L1/L2/L3)</li><li data-bbox="528 537 740 558">• Processor speed</li><li data-bbox="528 590 762 611">• MicroCode revision</li><li data-bbox="528 642 762 663">• Processor stepping</li><li data-bbox="528 695 722 716">• Memory speed</li><li data-bbox="528 747 927 768">• DIMM size (for each installed module)</li><li data-bbox="528 800 775 821">• System BIOS version</li><li data-bbox="528 852 871 873">• ME Firmware version (Intel only)</li><li data-bbox="528 905 762 926">• Video BIOS version</li><li data-bbox="528 957 807 978">• Reference code revision</li><li data-bbox="528 1010 831 1031">• Super I/O firmware version</li><li data-bbox="528 1062 946 1083">• USB Type-C controller firmware version</li><li data-bbox="528 1115 699 1136">• Born on date</li><li data-bbox="528 1167 711 1188">• Serial number</li><li data-bbox="528 1220 699 1241">• SKU number</li><li data-bbox="528 1272 903 1293">• UUID (Universally Unique Identifier)</li><li data-bbox="528 1325 791 1346">• Asset tracking number</li><li data-bbox="528 1377 699 1398">• Feature byte</li><li data-bbox="528 1430 651 1451">• Build ID</li><li data-bbox="528 1482 715 1503">• Product family</li><li data-bbox="528 1535 735 1556">• System board ID</li><li data-bbox="528 1587 815 1608">• System board CT number</li><li data-bbox="528 1640 679 1661">• Panel type</li><li data-bbox="528 1692 767 1713">• Panel serial number</li><li data-bbox="528 1745 807 1766">• Integrated MAC Address</li></ul>

**Table 6-1 Computer Setup Main (continued)**

Option	Description
<b>System Diagnostics</b>	<p>If the hard drive has the HP Advanced Diagnostics installed, the application launches. If HP Advanced Diagnostics is not installed, a basic version that is built into the BIOS provides the capability to perform the following functions:</p> <ul style="list-style-type: none"><li data-bbox="507 359 676 384">• Memory Test</li><li data-bbox="507 407 719 432">• Hard Drive Check</li><li data-bbox="507 455 647 480">• Language</li></ul>
<b>BIOS Event Log</b>	<p><b>View BIOS Event Log</b></p> <p>Displays a list of events, alerts, or warnings that have been logged since the log was last cleared.</p> <p><b>Export to USB Key</b></p> <p>Saves a file named BiosEventLog.txt containing the log entries to an inserted USB storage device.</p> <p><b>Clear BIOS Event Log on Next Boot</b></p> <p>When selected, the BIOS clears the event log when the user saves and exits. Default is disabled.</p>

**Table 6-1 Computer Setup Main (continued)**

Option	Description
<b>Update System BIOS</b>	<p>Lets you update the system BIOS from <a href="http://www.hp.com">www.hp.com</a> or another network server, from a removable USB drive, or from a file located on the hard drive.</p>
	<p><b>Check [current selection] for BIOS Updates</b></p>
	<p>The string that appears here depends on the setting in <b>BIOS Update Preferences</b>.</p>
	<p><b>Lock BIOS Version</b></p>
	<p>If this option is selected, the system is locked to the current BIOS version, and updates are not allowed.</p>
	<p><b>Native OS Firmware Update Service</b></p>
	<p>Allows the operating system to drive firmware updates (for example, Windows® Update).</p>
	<p><b>BIOS Rollback Policy</b></p>
	<ul style="list-style-type: none"><li>• Unrestricted Rollback to older BIOS: Lets you roll back to any previous version of BIOS.</li><li>• Restricted Rollback to older BIOS: If selected, <b>Minimum BIOS Version</b> becomes active, which lets you manually enter the minimum BIOS version that you can roll back to.</li></ul>
	<p><b>Minimum BIOS Version</b></p>
	<p>Defaults to current version. Read-only unless restricted rollback is selected.</p>
	<p><b>Allow BIOS Updates Using a Network</b></p>
	<p>Lets you configure scheduled, automatic BIOS updates through the network.</p>
	<p><b>BIOS Update Preferences</b></p>
	<ul style="list-style-type: none"><li>• Check for Update on Next Reboot: Default is disabled.</li><li>• BIOS Source: Lets you select either HP.com or a custom URL. If <b>Custom URL</b> is selected, <b>Edit Custom URL</b> becomes active. HP recommends using a custom URL only for a managed IT environment.</li></ul>
	<p><b>Automatic BIOS Update Setting</b></p>
	<p>Allows configuration of a periodic check for updates:</p>
	<p><b>NOTE:</b> If Windows BitLocker Drive Encryption (BDE) is enabled, it must be temporarily suspended before the BIOS is flashed.</p>
	<ul style="list-style-type: none"><li>• Do not update</li><li>• Check for updates and prompt the user to accept or reject the update at that time</li><li>• Check for updates and install all new versions</li><li>• Check for updates and install only new versions marked important</li></ul>
	<p><b>BIOS Update Frequency</b></p>
	<ul style="list-style-type: none"><li>• Daily</li><li>• Weekly</li><li>• Monthly (default)</li></ul>

**Table 6-1 Computer Setup Main (continued)**

Option	Description
<b>Update System BIOS</b>	<p><b>Network Configuration Settings</b></p> <p>Lets you configure the network connection to the server that is the host for system firmware updates.</p> <p><b>Update BIOS Using Local Media</b></p> <p>Lets you access files on either USB storage or the hard drive. The HP BIOS Update and Recovery application included in BIOS Softpaqs at <a href="http://www.hp.com">www.hp.com</a> copies the BIOS file to the correct location on the hard drive or USB device.</p>
<b>Change date and time</b>	Lets you update system date and time.
<b>System IDs</b>	Let you set the following values: <ul style="list-style-type: none"><li>• Asset Tracking Number</li><li>• Ownership Tag</li></ul>
<b>Replicated Setup</b>	<p><b>Back up current settings to USB device</b></p> <p>Saves system configuration to a formatted USB flash media device.</p> <p><b>Restore current settings from USB device</b></p> <p>Restores system configuration from a USB flash media device.</p>
<b>Save Custom Defaults</b>	Saves the current system configuration settings as the custom default set.
<b>Apply Custom Defaults and Exit</b>	Applies the custom default settings to the computer after rebooting. Does not apply to options in the <b>Security</b> menu.
<b>Apply Factory Defaults and Exit</b>	Restores the factory system configuration settings to the computer after rebooting. Does not apply to options in the <b>Security</b> menu.
<b>Ignore Changes and Exit</b>	Exits Computer Setup without applying or saving any changes.
<b>Save Changes and Exit</b>	Saves changes to current system configuration, exits Computer Setup, and reboots.

## Computer Setup Security

This table provides information about the Computer Setup Security menu.



**NOTE:** Support for specific Computer Setup options can vary, depending on the hardware configuration.

**Table 6-2 Computer Setup Security**

Option	Description
<b>Create BIOS Administrator Password</b>	<p>Lets you set and enable a BIOS administrator password, which controls access to the following features:</p> <ul style="list-style-type: none"><li>• Setup Menu (F10)</li><li>• Third-Party Option ROM Management (F3)</li><li>• Update system ROM</li><li>• WMI commands that change system settings</li><li>• BIOS Configuration Utility (BCU)</li><li>• Alternative power-on password</li></ul> <p><b>NOTE:</b> Creating a BIOS user disables the Fast Boot option.</p>
<b>Change BIOS Administrator Password</b> (This selection is active only if a BIOS administrator password is set.)	<p>Lets you change the BIOS administrator password.</p> <p>You must know the current password to be able to change it.</p>
<b>Create POST Power-On Password</b>	<p>Lets you change or delete power-on password. The power-on password prompt appears after a power cycle or reboot. If the user does not enter the correct power-on password, the unit will not boot.</p>
<b>Change POST Power-On Password</b> (This selection is active only if a BIOS administrator password is set.)	<p>Lets you change the POST power-on password.</p> <p>You must know the current password to be able to change it.</p>
<b>Password Policies</b>	<p>Let you set the guidelines for a valid password. Options include:</p> <ul style="list-style-type: none"><li>• Using a password minimum length</li><li>• Requiring at least one symbol</li><li>• Requiring at least one number</li><li>• Requiring at least one uppercase character</li><li>• Requiring at least one lowercase character</li><li>• Allowing spaces</li></ul>
<b>Administrator Authentication Policies</b>	<p>Let you set limitations on some boot features restricting them to admin only, including:</p> <ul style="list-style-type: none"><li>• Prompt for administrator authorization to access:<ul style="list-style-type: none"><li>– Boot menu in POST</li><li>– System Recovery</li><li>– Network boot</li><li>– BIOS update</li></ul></li><li>• Allow the use of administrator credentials to modify the power-on password.</li></ul>

**Table 6-2 Computer Setup Security (continued)**

Option	Description
Security Configuration	<b>TPM Embedded Security</b>
	<ul style="list-style-type: none"><li>• <b>TPM Specification Version</b> Displays the current Trusted Platform Module (TPM) version.</li></ul>
	<ul style="list-style-type: none"><li>• <b>TPM Device</b> Lets you set the TPM as available or hidden. Default is available.</li></ul>
	<ul style="list-style-type: none"><li>• <b>TPM State</b> Select to enable the TPM. Default is disabled.</li></ul>
	<ul style="list-style-type: none"><li>• <b>Clear TPM</b> Select to reset the TPM to an unowned state. After the TPM is cleared, it is also turned off. To temporarily suspend TPM operations, turn the TPM off instead of clearing it. Default is no. <b>IMPORTANT:</b> Clearing the TPM resets it to factory defaults and turns it off. You will lose all created keys and data protected by those keys.</li></ul>
	<ul style="list-style-type: none"><li>• <b>TPM Activation Policy</b><ul style="list-style-type: none"><li>– F1 to boot</li><li>– Allow user to reject (default)</li><li>– No prompts</li></ul></li></ul>
	<b>BIOS Sure Start</b>
	<ul style="list-style-type: none"><li>• Verify Boot Block on every boot: Select to enable HP Sure Start. Default is disabled.</li></ul>
	<ul style="list-style-type: none"><li>• BIOS Data Recovery Policy: Select Automatic or Manual to determine data recovery process. Manual recovery is intended only for situations when you want forensic analysis before HP Sure Start recovery. When this policy is set to manual, HP Sure Start will not correct any issues that are found until the local user enters the manual recovery key sequence. This can result in a computer that cannot start until the manual recovery key sequence is entered.</li></ul>
	<ul style="list-style-type: none"><li>• Network Controller Configuration Restore: Select to restore the network controller parameters to the factory state saved in the HP Sure Start Private nonvolatile (flash) memory. This setting is available only on computers with built-in NIC. <b>NOTE:</b> This process can take up to 30 seconds. You need to restore this only when the Network Controller Configuration mismatch warning is set.</li></ul>

**Table 6-2 Computer Setup Security (continued)**

Option	Description
<b>Security Configuration</b> <i>(continued)</i>	<ul style="list-style-type: none"><li>● Sure Start Security Event Policy. Controls HP Sure Start behavior upon identifying a critical security event, such as any modification to HP firmware, while the operating system is running.<ul style="list-style-type: none"><li>– Log Event Only: HP Sure Start will log all critical security events in the HP Sure Start audio log within the HP Sure Start nonvolatile (flash) memory.</li><li>– Log Event and notify user: In addition to logging all critical security events, HP Sure Start will notify the user within the operating system that a critical event has occurred.</li><li>– Log Event and power off system: In addition to logging all critical security events, HP Sure Start turns off the computer upon detecting a HP Sure Start Security Event. Because of the potential for data loss, HP recommends this setting only in situations where security integrity of the system is a higher priority than the risk of potential data loss.</li></ul></li><li>● Sure Start Security Event Boot Notification: Lets you enable a warning message on the startup screen if a Sure Start event, such as BIOS recovery or Memory intrusion, occurs.</li></ul>
	<b>Secure Boot Configuration.</b>
	<p>Lets you be sure that an operating system is legitimate before booting to it, making Windows resistant to malicious modification from preboot to full operating system booting, preventing firmware attacks. UEFI and Windows Secure Boot only allow code signed by preapproved digital certificates to run during the firmware and OS boot process.</p>
	<p><b>NOTE:</b> An administrator password must be set to activate this setting. Secure Boot must also be enabled.</p>
	<ul style="list-style-type: none"><li>● Secure Boot: Default is disabled.</li><li>● Secure Boot Key Management: Lets you manage the custom key settings.</li></ul>
	<p><b>NOTE:</b> Access to these settings requires Sure Start Secure Boot Keys Protection to be disabled.</p>
	<ul style="list-style-type: none"><li>– Import Custom Secure Boot Keys: Default is disabled.</li><li>– Clear Secure Boot keys: Lets you delete any previously loaded custom boot keys. Clearing keys will disable secure boot. Default is disabled.</li><li>– Reset Secure Boot keys to factory defaults: Default is disabled.</li><li>– Enable MS UEFI CA key: Disabling this setting alters the Secure Boot key list to further restrict the allowed software components. Set this option to disable to support Device Guard. Default is enabled.</li><li>– Ready BIOS for Device Guard Use: Requires BIOS Administrator password to be configured and Secure Boot to be enabled.</li></ul>

**Table 6-2 Computer Setup Security (continued)**

Option	Description
<b>Security Configuration</b> <i>(continued)</i>	<p><b>Secure Platform Management (SPM)</b></p> <ul style="list-style-type: none"> <li>• SPM Current State: Displays the current state. Also lets you change the state.</li> <li>• Unprovision SPM: Deprovisions SPM, which causes HP Sure Run to revert to the inactive state and return HP Sure Recover to default settings.</li> <li>• HP Sure Run Current State: Displays the current state. Also lets you change the state.</li> </ul> <p>Deactivate HP Sure Run: Deactivates HP Sure Run without deprovisioning SPM.</p> <ul style="list-style-type: none"> <li>• Smart Health Enable</li> <li>• EBAM Current State: Displays the current state. Also lets you change the state.</li> </ul> <p>Disable EBAM: Disables Enhanced BIOS Authentication Mode (EBAM).</p> <ul style="list-style-type: none"> <li>• Deactivate HP Sure Run: Requires BIOS Administrator password to be configured.</li> <li>• Local Access Key: Indicates that the key is present. Also lets you clear the keys and reboot.</li> </ul> <p>Clear EBAM Local Access Keys and Reboot: Deletes all currently established local access keys created for Enhanced BIOS Authentication Mode (EBAM).</p> <p><b>Physical Presence Interface:</b> When set to enabled, the user is notified at system power up when changes are made to system security policy. The user must manually agree to those changes before the change is confirmed. Default is enabled.</p> <p><b>Smart Cover:</b> The Smart Cover Lock (select products only) is a software-controllable solenoid lock that restricts unauthorized access to the system's internal components.</p> <ul style="list-style-type: none"> <li>• Cover Lock: Default is unlock.</li> <li>• Cover Removal Sensor: Lets you disable the cover sensor or configure what action is taken if the computer cover is removed. Default is disabled.</li> </ul> <p><b>NOTE:</b> <b>Notify user</b> alerts the user with a POST error on the first boot after the sensor detects removal of the cover. If the password is set, <b>Administrator Password</b> requires that the password be entered to boot the computer if the sensor detects that the cover has been removed.</p> <p><b>Trusted Execution Technology (TXT)</b></p> <p>Enables Trusted Execution Technology on select Intel-based systems. Default is disabled.</p> <p><b>NOTE:</b> Enabling this feature disables OS management of the Trusted Platform Module (TPM), prevents a reset of the TPM, and constrains the configuration of VTx, VTd, and TPM.</p> <p><b>Intel Software Guard Extensions (SGX)</b></p> <p>Intel SGX is a set of processor code instructions that allows user-level code to allocate private regions of memory. Unlike normal process memory, SGX protects these private memory regions from processes running at higher privilege levels.</p> <ul style="list-style-type: none"> <li>• Software control</li> <li>• Disable</li> <li>• Enable</li> </ul> <p><b>Full encryption of main memory (DRAM) (select products only)</b></p> <p>When selected, the computer stores all data to DRAM in an encrypted format.</p>

**Table 6-2 Computer Setup Security (continued)**

Option	Description
<b>Utilities</b>	<p data-bbox="528 254 707 285"><b>Hard Drive Utilities</b></p> <ul style="list-style-type: none"> <li data-bbox="528 306 1460 451"> <p data-bbox="528 306 954 338">● <b>Save/Restore GPT of System Hard Drive</b></p> <p data-bbox="576 359 1437 432">Enabling this feature saves the GUID Partition Table (GPT) of the system hard drive. If the GPT is subsequently changed, the user is prompted to choose whether to restore GPT. Default is disabled.</p> </li> <li data-bbox="528 457 1460 531"> <p data-bbox="528 457 898 489">● <b>Boot Sector (GPT) Recovery Policy</b></p> <p data-bbox="576 510 1166 531">Allows selection of the default action when a GPT event occurs.</p> </li> <li data-bbox="528 558 1460 1010"> <p data-bbox="528 558 874 590">● <b>DriveLock/Automatic DriveLock</b></p> <p data-bbox="576 611 1453 705">Allows you to assign or modify a master or user password for hard drives. When this feature is enabled, the user is prompted to provide one of the DriveLock passwords during POST. If neither is successfully entered, the hard drive remains inaccessible until one of the passwords is successfully provided during a subsequent cold-boot sequence.</p> <p data-bbox="576 730 1398 783"><b>NOTE:</b> This selection appears only when at least one drive that supports the DriveLock feature is attached to the system.</p> <p data-bbox="576 808 1461 829"><b>IMPORTANT:</b> Be aware that these settings take place immediately. It is not necessary to save.</p> <p data-bbox="576 854 1453 907"><b>IMPORTANT:</b> Be sure to document the DriveLock password. Losing a DriveLock password will render a drive permanently locked.</p> <p data-bbox="576 932 1406 1005"><b>NOTE:</b> Disable DriveLock on NVMe drives before using applications for hardware-based encryption. After you select a drive, the following options are available:</p> <ul style="list-style-type: none"> <li data-bbox="576 1031 1433 1083">– Set DriveLock Master Password. Sets the drive's master password but does not enable DriveLock.</li> <li data-bbox="576 1108 1305 1129">– Enable DriveLock. Sets the drive's user password and enables DriveLock.</li> </ul> </li> <li data-bbox="528 1157 1460 1335"> <p data-bbox="528 1157 707 1188">● <b>Secure Erase</b></p> <p data-bbox="576 1209 1026 1230">Lets you select a hard drive to completely erase.</p> <p data-bbox="576 1255 1445 1329">After you erase a hard drive with a program that uses Secure Erase firmware commands, no file recovery program, partition recovery program, or other data recovery method can extract data from the drive.</p> </li> <li data-bbox="528 1360 1460 1539"> <p data-bbox="528 1360 970 1392">● <b>Allow OPAL Hard Drive SID Authentication</b></p> <p data-bbox="576 1413 1449 1528">BIOS supports drive encryption using the DriveLock feature by creating the storage device's ownership key. If BIOS creates the key, any third-party applications (including other encryption software) are not allowed to perform certain drive operations such as establishing their own key using SID. Encryption software applications might not be limited by SID authentication lockout depending on how they are designed. Default is disabled.</p> </li> </ul>
<b>Absolute Persistence Module Current State</b>	<p data-bbox="528 1556 1094 1577">Shows the current state of the Absolute Persistence module.</p> <p data-bbox="528 1602 655 1623">Yes: Disabled</p> <p data-bbox="528 1648 655 1669">No: Available</p>
<b>System Management Command</b>	<p data-bbox="528 1703 1426 1724">Allows authorized personnel to reset security settings during a service event. Default is enabled.</p>
<b>Restore Security Settings to Factory Default</b>	<p data-bbox="528 1776 1437 1829">This action resets security devices, clears BIOS passwords (not including DriveLock), and restores settings in the <b>Security menu</b> to factory defaults.</p>

# Computer Setup Advanced

This table provides information about the Computer Setup Advanced menu.



**NOTE:** Support for specific Computer Setup options can vary, depending on the hardware configuration.

**Table 6-3 Computer Setup Advanced (for advanced users)**

Option	Heading
Display Language	Lets you select the language of the menus in F10 Setup and the keyboard layout.
Scheduled Power-On	This feature wakes the system when it is off at a specified date and time.
Boot Options	Select the devices that the computer can boot from, as well as other options, including: <ul style="list-style-type: none"><li>• Startup Delay (sec): Enabling this feature adds a user-specified delay to the POST process. One purpose for the delay is to provide additional time to activate hotkeys such as <b>esc</b> for the Startup Menu or <b>f10</b> for Computer Setup.</li><li>• Fast Boot: Default is enabled.</li><li>• CD-ROM Boot (select products only): Default is enabled.</li><li>• USB Storage Boot: Default is enabled.</li><li>• Network (PXE) Boot: Default is enabled.</li><li>• After Power Loss: Default is Power Off.<ul style="list-style-type: none"><li>– Power off: Causes the computer to remain off when power is restored.</li><li>– Power on: Causes the computer to turn on automatically as soon as power is restored.</li><li>– Previous state: Causes the computer to turn on automatically as soon as power is restored, if it was on when power was lost.</li></ul></li></ul> <p><b>NOTE:</b> If the system is configured to Power On from Keyboard Ports in Power Management Options, this setting is forced to Power On.</p> <ul style="list-style-type: none"><li>• Prompt on Memory Size Change: Default is enabled.</li><li>• Prompt on Fixed Storage Change: Default is disabled.</li><li>• Audio Alerts During Boot: Default is enabled. When disabled, most audible beeps from errors, warnings, and password prompts during boot up are suppressed.</li><li>• Numlock on at boot: Default is disabled.</li><li>• UEFI Boot Order: Specify the order in which UEFI boot sources are checked for a bootable operating system image. The default boot order is:<ol style="list-style-type: none"><li>1. USB</li><li>2. SATA DVD</li><li>3. SATA hard drives</li><li>4. M.2 devices</li><li>5. Network boot</li></ol></li></ul>

**Table 6-3 Computer Setup Advanced (for advanced users) (continued)**

Option	Heading
<b>Boot Options</b>	<b>NOTE:</b> Use the UP and DOWN arrows to highlight an item. Press <b>enter</b> to select. Use the UP and DOWN arrows to move a selected item. Press <b>f5</b> to enable or disable. Press <b>esc</b> to exit.
	<b>NOTE:</b> MS-DOS drive lettering assignments might not apply after a non-MS-DOS operating system has started.
	<b>Shortcut to Temporarily Override Boot Order</b>  To boot <b>one time</b> from a device other than the default device specified in Boot Order, restart the computer and press <b>esc</b> (to access the Startup menu) and then <b>f9</b> (Boot Menu), or only <b>f9</b> (skipping the Startup menu) when the power button light turns white. After POST is completed, a list of bootable devices is displayed. Use the arrow keys to select the preferred bootable device and press <b>enter</b> . The computer then boots from the selected non-default device for this one time.
<b>HP Sure Recover</b>	<b>HP Sure Recover</b>
	If enabled and HP Sure Recover is launched, the system firmware honors local and remote requests to reinstall the operating system. If it is disabled, all requests to reinstall the operating system are ignored. Default is enabled.
	<b>Recover from Network</b>
	Allows system firmware to retrieve the recovery agent from the network. If disabled, system firmware retrieves the recovery agent from a local drive. Default is enabled.
	<b>Recover after Boot Failure</b>
	If enabled and no bootable UEFI operating system is found, system firmware launches HP Sure Recover. Default is disabled.
	<b>Recover before Boot Failure Recovery</b>
	If enabled and HP Sure Recover is launched because of a boot failure, the user is notified of the boot failure and asked to choose whether to start or cancel HP Sure Recover. This setting is displayed only if <b>Recover after Boot Failure</b> is selected.
	<b>Recovery Agent</b>
	Displays recovery agent information. This information is displayed only if <b>Recover from Network</b> is selected.
<b>Recovery Image</b>	
Displays recovery image information. This information is displayed only if <b>Recover from Network</b> is selected.	
<b>OS Recovery Image Version.</b>	
Display the version of the recovery image stored in the embedded secure storage device. This information is displayed only if an embedded secure storage device is installed.	
<b>OS Recovery Driver Version</b>	
Display the version of the recovery driver stored in the embedded secure storage device. This information is displayed only if an embedded secure storage device is installed.	

**Table 6-3 Computer Setup Advanced (for advanced users) (continued)**

Option	Heading
System Options	<b>Configure storage controller for Intel Optane™</b> (Intel products only) Enables the Intel Optane memory module.
	<b>Configure storage controller for RAID</b> Enables RAID. Default is enabled.
	<b>Limit PCIe Speed</b> (workstation models only) Lets you restrict the maximum speed of the PCI Express devices to previous generations. The following settings are possible: <ul style="list-style-type: none"><li>• Auto</li><li>• Gen 1 (2.5 Gbps)</li><li>• Gen 2 (5 Gbps)</li><li>• Gen 3 (8 Gbps)</li></ul>
	<b>Turbo-boost</b> (Intel products only) Allows Intel Turbo Boost Technology to improve performance when operation conditions allow. Default is enabled.
	<b>Hyperthreading</b> (Intel products only) Lets you control processor capability. Default is enabled.
	<b>Virtualization Technology (VTx)</b> (Intel only) Controls the virtualization features of the processor. Changing this setting requires turning the computer off and then back on. Default is disabled.
	<b>Virtualization Technology for Directed I/O (VTd)</b> (Intel only) Controls virtualization DMA remapping features of the chipset. Changing this setting requires turning the computer off and then back on. Default is disabled.
	<b>SVM CPU Virtualization</b> (AMD® products only) Enables AMD-V and AMD-Vi virtualization features on AMD-based systems
	<b>Enhanced Hello Sign-in</b> (systems with supporting hardware for biometric identification only) Allows for secure logon using the Windows Hello feature.
	<b>DMA Protection</b> Enables DMA redirection using IOMMU for enhanced security. Default is enabled. <b>NOTE:</b> Requires that VTd is enabled.
	<b>Pre-boot DMA protection</b> Secures memory access through DMA to allowed regions prior to operating system startup.
	<b>Full encryption of main memory (DRAM)</b> (select products only) Stores all data to DRAM in an encrypted format. Default is enabled.
	<b>PCI slots</b> (vary by product) Lets you enable or display PCI slots. Default is enabled.

**Table 6-3 Computer Setup Advanced (for advanced users) (continued)**

Option	Heading
<b>System Options</b>	<p data-bbox="528 262 774 283"><b>M.2 slots</b> (vary by product)</p> <p data-bbox="528 310 1027 331">Let you enable or display M.2 slots. Default is enabled.</p> <p data-bbox="528 359 1275 380"><b>Performance Control</b> (High Performance Mode/Performance Mode/Quiet Mode)</p> <p data-bbox="528 407 1377 457">Select <b>Quiet Mode</b> to prioritize acoustics. Select <b>Performance Mode</b> for a balance between performance and acoustics. Select <b>High Performance Mode</b> to prioritize performance.</p> <p data-bbox="528 485 1018 506"><b>Power Button Override</b> (disable/4 sec/15 sec/30 sec)</p> <p data-bbox="528 533 1445 583">Lets you enable and select the number of seconds you have to hold down the power button for it to force the system to turn off. Default is 4 sec.</p> <p data-bbox="528 611 1267 632"><b>USB Type-C Connector System Software Interface (UCSI)</b> (select products only)</p> <p data-bbox="528 659 1118 680">Allows UCSI to be exposed to the operating system (ACPI table).</p> <p data-bbox="528 707 730 728"><b>HP Application Driver</b></p> <p data-bbox="528 756 1386 806">Provides ACPI structure to enable HP common software application framework. The driver is provided in the latest HP support software that you can download from the web.</p> <p data-bbox="528 833 1437 884"><b>NOTE:</b> Device Manager shows an alert if this setting is enabled without the HP application driver installed.</p> <p data-bbox="528 911 639 932"><b>AMD DASH</b></p> <p data-bbox="528 959 1286 980">Lets you enable AMD Remote system management capability. Default is disabled.</p> <p data-bbox="528 1008 967 1029"><b>Hardware enabled Spectre Variant 2 Mitigation</b></p> <p data-bbox="528 1056 1445 1106">Enables Single Thread Indirect Branch Predictor (STIBP) functionality in AMD processors. Default is disabled.</p>

**Table 6-3 Computer Setup Advanced (for advanced users) (continued)**

Option	Heading
<b>Built-In Device Options</b>	<p data-bbox="507 260 954 281"><b>Embedded LAN Controller</b> (select products only)</p> <p data-bbox="507 310 1147 331">Select to show the device in the operating system. Default is enabled.</p> <p data-bbox="507 361 635 382"><b>Wake On LAN</b></p> <p data-bbox="507 411 1418 457">Lets you either disable the Wake On LAN feature or configure where the computer boots, including the network or hard drive. Default is boot to network.</p> <p data-bbox="507 487 959 508"><b>LAN Controller Option (1)(2)</b> (select products only)</p> <p data-bbox="507 537 1206 558">Enables the integrated network controller in the designated rear option slot.</p> <p data-bbox="507 588 807 609"><b>Dust Filter</b> (select products only)</p> <p data-bbox="507 638 683 659">Default is disabled.</p> <p data-bbox="507 688 963 709"><b>Dust Filter Reminder (Days)</b> (select products only)</p> <p data-bbox="507 739 628 760">Default is 60.</p> <p data-bbox="507 789 1107 810"><b>Allow No Panel configuration</b> (All-in-One 1000 series models only)</p> <p data-bbox="507 837 1315 858">Allows operation of the base unit without a boot warning when the panel is not installed.</p> <p data-bbox="507 888 956 909"><b>Integrated Video</b> (models with discrete graphics)</p> <p data-bbox="507 938 1437 984">Disables the integrated video device. When not using integrated video, disabling the integrated video will free some system memory.</p> <p data-bbox="507 1014 959 1035"><b>VGA Boot Device</b> (models with discrete graphics)</p> <p data-bbox="507 1064 1390 1110">Selects the graphics controller to use as the primary VGA device during boot-up when there are multiple graphics devices. The firmware can use only one graphics device when booting up.</p> <p data-bbox="507 1140 687 1161"><b>Video Memory Size</b></p> <p data-bbox="507 1190 1398 1236">Lets you manage graphics memory allocation. The value you choose is allocated permanently to graphics and is unavailable to the operating system.</p> <p data-bbox="507 1266 683 1287"><b>Integrated Camera</b></p> <p data-bbox="507 1316 1046 1337">Lets you disable the integrated camera. Default is enabled.</p> <p data-bbox="507 1367 632 1388"><b>Audio Device</b></p> <p data-bbox="507 1417 1390 1509">Select to show audio devices in the operating system, including integrated microphone, internal speakers, and headphone out. When selected, operating system visibility of each audio device is controlled independently. When this setting is cleared, all audio devices are hidden from the operating system. Individual audio device settings are also disabled. Default is enabled.</p> <p data-bbox="507 1539 619 1560"><b>Microphone</b></p> <p data-bbox="507 1589 1410 1661">Clear to disable the integrated microphone. This does not affect devices plugged into audio jacks. The disable and lock setting prevents other audio ports from being remapped to the microphone function in the operating system. Default is enabled.</p> <p data-bbox="507 1690 999 1711"><b>Internal Speakers</b> (does not affect external speakers)</p> <p data-bbox="507 1740 1362 1812">Clear to disable the chassis speaker or speakers. This function is applicable to normal audio playback in the operating system and does not affect the error or warning beeps during POST. Default is enabled.</p> <p data-bbox="507 1841 687 1862"><b>Headphone Output</b></p> <p data-bbox="507 1892 1023 1913">Clear to disable the headphone jack. Default is enabled.</p>

**Table 6-3 Computer Setup Advanced (for advanced users) (continued)**

Option	Heading
<b>Built-In Device Options</b>	<b>Collaboration Buttons</b> (select products only)
	Clear to disable the collaboration buttons. Default is enabled.
	<b>Button Sensitivity</b> (select products only)
	Controls touch sensitivity of collaboration buttons. Select from low, medium, or high.
	<b>LAN/WLAN auto switching</b>
	Select to enable auto switching between a wired and wireless connection. Default is disabled.
	<b>Wake on WLAN</b>
	Select to enable wake on WLAN. Default is disabled.
	<b>M.2 USB/Bluetooth</b>
Select to enable the M.2 controller. Default is enabled.	
<b>Increase Idle Fan Speed (%)</b>	
Increases the minimum fan speeds over the normal settings while still enabling normal control using the internal thermal sensors.	
<b>Force enable HP Sure View</b>	
Enables the HP Sure View privacy panel by changing the screen brightness.	

**Table 6-3 Computer Setup Advanced (for advanced users) (continued)**

Option	Heading
<b>Port Options</b>	<p data-bbox="507 260 762 281"><b>USB ports</b> (varies by model)</p> <p data-bbox="507 310 1011 331">Lets you enable specific USB ports. Default is enabled.</p> <p data-bbox="507 361 751 382"><b>USB Legacy Port Charging</b></p> <p data-bbox="507 411 1430 457">Lets you enable USB charging port capability when the computer is in hibernate or shutdown mode. Default is enabled.</p> <p data-bbox="507 487 831 508"><b>USB Type-C Downstream Charging</b></p> <p data-bbox="507 537 1430 583">Lets you enable USB charging port capability when the computer is in hibernate, on, or off. Default is enabled.</p> <p data-bbox="507 613 815 634"><b>Media Card Reader/SD_RDR USB</b></p> <p data-bbox="507 663 1366 684">Enables the media card reader connector (labeled SD_RDR) on a desktop. Default is enabled.</p> <p data-bbox="507 714 719 735"><b>SATA</b> (varies by model)</p> <p data-bbox="507 764 1283 785">Lets you hide SATA ports from the operating system. Default is enabled (not hidden).</p> <p data-bbox="507 814 767 835"><b>Serial Port</b> (varies by model)</p> <p data-bbox="507 865 1023 886">Lets you enable specific serial ports. Default is enabled.</p> <p data-bbox="507 915 1177 936"><b>Serial Port Voltage</b> (Retail Point-of-Sale models only; ports vary by model)</p> <p data-bbox="507 966 1398 1012">Lets you configure powered serial port voltage selection on RPOS units that include this feature. Default is 0 Volts.</p> <ul data-bbox="507 1041 624 1155" style="list-style-type: none"><li data-bbox="507 1041 619 1062">• 0 Volts</li><li data-bbox="507 1079 619 1100">• 5 Volts</li><li data-bbox="507 1129 624 1150">• 12 Volts</li></ul> <p data-bbox="507 1180 979 1201"><b>Cash Drawer Port</b> (Retail Point-of-Sale models only)</p> <p data-bbox="507 1230 1209 1251">Controls whether the cash drawer port can be activated. Default is enabled.</p> <p data-bbox="507 1281 703 1302"><b>Restrict USB Devices</b></p> <p data-bbox="507 1331 1046 1352">Specify the following categories of USB devices to enable:</p> <ul data-bbox="507 1381 911 1495" style="list-style-type: none"><li data-bbox="507 1381 831 1402">• Allow all USB devices (default)</li><li data-bbox="507 1432 847 1453">• Allow only keyboard and mouse</li><li data-bbox="507 1482 911 1503">• Allow all but storage devices and hubs</li></ul> <p data-bbox="507 1524 1430 1619">When some devices are restricted, the system will disable USB ports that do not meet the allowed criteria. This feature is usually combined with similar policies within the operating system because USB devices can be moved to different ports. The ports disabled by the BIOS remain disabled until the system is restarted.</p>

**Table 6-3 Computer Setup Advanced (for advanced users) (continued)**

Option	Heading
<b>Power Management Options</b>	<b>Runtime Power Management</b>
	Allows certain operating systems to reduce processor voltage and frequency when the current software load does not require the full capabilities of the processor. Default is enabled.
	<b>Extended Idle Power States</b>
	Allows certain operating systems to decrease the processors power consumption when the processor is idle. Default is enabled.
	<b>S5 Maximum Power Savings</b>
	Enabling this feature reduces the power of the system as much as possible in the S5 state. Power is removed from the wake up circuitry, the expansion slots, and any management features while in S5. Default is disabled.
	<b>SATA Power Management</b>
	Enables or disables SATA bus, device power management, or both. Default is enabled.
	<b>PCI Express Power Management</b>
	Enabling this option permits the PCI Express links to use Active Power State Management (ASPM) to enter lower power states while not in use. Default is enabled.
<b>Power On from Keyboard Ports</b>	
When enabled, this feature allows a key press to turn on the system when it is off (S5 state). If using a USB keyboard, you must plug it into one of the rear ports labeled with the keyboard icon. Default is disabled.	
<b>Unique Sleep State Blink Rates</b>	
This feature is designed to provide a visual indication of what Sleep state the system is in. Each Sleep state has a unique blink pattern. Default is disabled.	
<b>NOTE:</b> A normal shutdown goes to the S4 state for Windows 8 or later.	
S0 (On) = solid white light.	
S3 (Stand By) = 3 blinks at 1 Hz (50% duty cycle) followed by a pause of 2 seconds (white light), repeated cycles of 3 blinks and a pause.	
S4 (Hibernation) = 4 blinks at 1 Hz (50% duty cycle) followed by a pause of 2 seconds (white light), repeated cycles of 4 blinks and a pause.	
S5 (Soft Off) = Light is off.	

**Table 6-3 Computer Setup Advanced (for advanced users) (continued)**

Option	Heading
<b>Remote Management Options</b> (Intel only)	<b>Active Management Technology (AMT)</b>
	Allows you to discover, repair, and protect networked computing devices. Default is enabled.
	<b>USB Key Provisioning Support</b>
	Enables AMT provisioning using a USB storage device. Default is disabled.
	<b>USB Redirection Support</b>
	USB redirection allows USB devices plugged into a client computer to be transparently redirected to the guest operating system. Default is enabled.
	<b>Unconfigure AMT on next boot.</b> Resets AMT configuration options on next boot. Default is Do Not Apply.
	<b>SOL Terminal Emulation Mode</b>
	SOL (serial-over-LAN) terminal emulation mode is only activated during remote AMT (Active Management Technology) redirection operations. The emulation options allow administrators to select which mode works best with their console. Default is ANSI.
	<b>Show Unconfigure ME Confirmation Prompt</b>
Requires user confirmation when unconfiguring the Intel Management Engine. Default is enabled.	
<b>Verbose Boot Messages</b>	
Verbose boot shows additional logging information during startup, which is mainly for debugging if something goes wrong during bootup. Default is enabled.	
<b>Watchdog Timer</b>	
Allows you to set the amount of time for an operating system and BIOS watchdog alert to be sent if the timers are not deactivated. BIOS watchdog is deactivated by BIOS and would indicate that a halt occurred during execution if the alert is sent to the management console. An operating system alert is deactivated by the operating system image and would indicate that a hang occurred during its initialization. Default is enabled.	
<ul style="list-style-type: none"><li data-bbox="504 1232 951 1260">• OS Watchdog Timer (min.): Default is 5 min.</li><li data-bbox="504 1281 970 1306">• BIOS Watchdog Timer (min.): Default is 5 min.</li></ul>	<b>CIRA Timeout (min.)</b>
	CIRA is Customer Initiated Remote Assistance, an Intel service to help users employing Active Management Technology (AMT). Default is 1.

**Table 6-3 Computer Setup Advanced (for advanced users) (continued)**

Option	Heading
<b>Thunderbolt Options</b> (select products only)	<p data-bbox="528 254 703 281"><b>Thunderbolt Mode</b></p> <p data-bbox="528 304 1378 359">Enables Thunderbolt™ connections on the Type-C port. When cleared, disables Thunderbolt connections on the Type-C port and disables PCIe tunneling on USB4® connections.</p> <p data-bbox="528 380 1043 407"><b>Require BIOS PW to change Thunderbolt Security Level</b></p> <p data-bbox="528 430 1422 506">When selected, <b>Thunderbolt Security Level</b> cannot be changed unless a BIOS administrator password has been created. This setting cannot be disabled if DMA Protection (System Options) is enabled.</p> <p data-bbox="528 527 783 554"><b>Thunderbolt Security Level</b></p> <ul data-bbox="528 577 1460 1031" style="list-style-type: none"> <li data-bbox="528 577 1460 653">• PCIe and DisplayPort - No Security: Any Thunderbolt device detected that requests a PCI-express connection is connected to the system PCI-express bus without approval by the local user.</li> <li data-bbox="528 674 1460 779">• PCIe and DisplayPort - User Authorization (default): Each Thunderbolt peripheral includes a unique identifier used to determine if the device has been previously connected. If the user previously selected <b>Always Connect</b> for a device, it is automatically connected to the PCI-Express bus when attached.</li> <li data-bbox="528 800 1460 905">• PCIe and DisplayPort - Secure Connect: Offers enhanced protection for authenticating a previously connected Thunderbolt device beyond relying on its identifier. The device is provisioned with a key when initially connected, and on subsequent connections a challenge-response is implemented to verify the device before it is connected to the PCI-express bus.</li> <li data-bbox="528 926 1460 1031">• DisplayPort™ only: Permits only USB and DisplayPort functionality to be available via the Type-C Thunderbolt port. PCI-Express will not be connected from the Thunderbolt device to the internal PCI-express interface, thus any Thunderbolt device that requires PCI-Express will not function correctly.</li> </ul> <p data-bbox="528 1052 724 1079"><b>Native PCIe Hot Plug</b></p> <p data-bbox="528 1102 1054 1129">Enables hot plug support to the system PCI-Express bus.</p>
<b>Remote HP PC Hardware Diagnostics</b>	<p data-bbox="528 1157 612 1184"><b>Settings</b></p> <p data-bbox="528 1207 1385 1255">Sets the configuration for Remote HP PC Hardware Diagnostics, including the URLs used for download and upload and scheduled execution frequency.</p> <p data-bbox="528 1276 959 1304"><b>Execute Remote HP PC Hardware Diagnostics</b></p> <p data-bbox="528 1327 1453 1381">Select to immediately execute Remote HP PC Hardware Diagnostics based on the how settings are configured. Any unsaved BIOS settings will be lost.</p>

# 7 POST error messages

This section lists the error codes, error messages, and the various indicator light and audible sequences that you might encounter during Power-On Self-Test (POST) or computer restart, the probable source of the problem, and steps you can take to resolve the error condition.

POST Message Disabled suppresses most system messages during POST, such as memory count and non-error text messages. If a POST error occurs, the screen will display the error message. To manually switch to the POST Messages Enabled mode during POST, press any key except **f10**, **f11**, or **f12**. The default mode is POST Message Disabled.

The POST mode selection determines the speed at which the computer loads the operating system and the extent to which it is tested.

Quick Boot is a fast startup process that does not run all of the system level tests, such as the memory test. Full Boot runs all of the ROM-based system tests and takes longer to complete.

You can enable Full Boot to run every 1 to 30 days on a regularly scheduled basis. To establish the schedule, reconfigure the computer to the Full Boot Every x Days mode, using Computer Setup.



**NOTE:** For more information about Computer Setup, see [Computer Setup \(F10\) Utility on page 41](#).

## POST numeric codes and text messages

This section identifies those POST errors that have numeric codes associated with them. The section also includes some text messages that you might encounter during POST.



**NOTE:** The computer beeps once after a POST text message is displayed on the screen.

**Table 7-1** POST numeric codes and text messages

Control panel message	Description	Recommended action
002-Option ROM Checksum Error	System ROM or expansion board option ROM checksum.	<ol style="list-style-type: none"><li>1. Verify the correct ROM.</li><li>2. Flash the ROM if needed.</li><li>3. If an expansion board was recently added, remove it to see if the problem remains.</li><li>4. Clear CMOS.</li><li>5. If the message disappears, there might be a problem with the expansion card.</li><li>6. Replace the system board.</li></ol>
003-System Board Failure	DMA or timers.	<ol style="list-style-type: none"><li>1. Clear CMOS.</li><li>2. Replace the system board.</li></ol>

**Table 7-1 POST numeric codes and text messages (continued)**

Control panel message	Description	Recommended action
005-Real-Time Clock Power Loss	Invalid time or date in configuration memory. RTC (real-time clock) battery might need to be replaced.	Reset the date and time under Control Panel (you can also use Computer Setup). If the problem persists, replace the RTC battery. See <a href="#">Removal and replacement procedures on page 28</a> for instructions about installing a new battery.
008-Microcode Patch Error	Processor is not supported by the BIOS.	<ol style="list-style-type: none"><li>1. Upgrade BIOS to proper version.</li><li>2. Change the processor.</li></ol>
009-PMM Allocation Error during MEBx Download	Memory error during POST execution of the Management Engine (ME) BIOS Extensions option ROM.	<ol style="list-style-type: none"><li>1. Reboot the computer.</li><li>2. Unplug the power cord, reseal the memory modules, and reboot the computer.</li><li>3. If the memory configuration was recently changed, unplug the power cord, restore the original memory configuration, and reboot the computer.</li><li>4. If the error persists, replace the system board.</li></ol>
00A-Product Information Not Valid	The product information programmed into the system board is missing or invalid.	Use <a href="#">Computer Setup (F10) Utility on page 41</a> to update this information.
00B-MEBx Module did not checksum correctly	Memory error during POST execution of the Management Engine (ME) BIOS Extensions option ROM.	<ol style="list-style-type: none"><li>1. Reboot the computer.</li><li>2. Unplug the power cord, reseal the memory modules, and reboot the computer.</li><li>3. If the memory configuration was recently changed, unplug the power cord, restore the original memory configuration, and reboot the computer.</li><li>4. If the error persists, replace the system board.</li></ol>
00C-PMM Deallocation Error during MEBx Cleanup	Memory error during POST execution of the Management Engine (ME) BIOS Extensions option ROM.	<ol style="list-style-type: none"><li>1. Reboot the computer.</li><li>2. Unplug the power cord, reseal the memory modules, and reboot the computer.</li><li>3. If the memory configuration was recently changed, unplug the power cord, restore the original memory configuration, and reboot the computer.</li><li>4. If the error persists, replace the system board.</li></ol>

**Table 7-1 POST numeric codes and text messages (continued)**

Control panel message	Description	Recommended action
00D-Setup Error during MEBx Execution	MEBx selection or exit resulted in a setup failure.	<ol style="list-style-type: none"> <li>1. Reboot the computer.</li> <li>2. Unplug the power cord, reseal the memory modules, and reboot the computer.</li> <li>3. If the memory configuration was recently changed, unplug the power cord, restore the original memory configuration, and reboot the computer.</li> <li>4. If the error persists, replace the system board.</li> </ol>
00E-Inventory Error during MEBx Execution	BIOS information passed to the MEBx resulted in a failure.	<ol style="list-style-type: none"> <li>1. Reboot the computer.</li> <li>2. If the error persists, update to the latest BIOS version.</li> <li>3. If the error still persists, replace the system board.</li> </ol>
00F-Interface Error during MEBx Execution	MEBx operation experienced a hardware error during communication with the ME.	<ol style="list-style-type: none"> <li>1. Reboot the computer.</li> <li>2. If the error persists, update to the latest BIOS version.</li> <li>3. If the error still persists, replace the system board.</li> </ol>
100-Front Audio Not Connected	Front audio cable has been detached or unseated from system board.	Reconnect or replace front audio cable.
2E1-MemorySize Error	Memory amount has changed since the last boot (memory added or removed).	The system memory size is different from the last startup. The most common reason is the removal of memory from the system board. Press the <b>f1</b> key to save the memory changes.
2E2-Memory Error	Memory module configuration failed during startup.	<ol style="list-style-type: none"> <li>1. Be sure that memory modules are correctly installed.</li> <li>2. Verify proper memory module type.</li> <li>3. Remove and replace the identified faulty memory modules.</li> <li>4. If the error persists after replacing memory modules, replace the system board.</li> </ol>
2E3-Incompatible Memory Module in Memory Socket(s) X, X, ...	A memory module in memory socket identified in the error message is missing critical SPD information, or is incompatible with the chipset.	<ol style="list-style-type: none"> <li>1. Verify proper memory module type.</li> <li>2. Try another memory socket.</li> <li>3. Replace with a supported module.</li> </ol>
2E4-DIMM Configuration Warning	Populated DIMM Configuration is not optimized.	Rearrange the DIMMs so that each channel has the same amount of memory.

**Table 7-1 POST numeric codes and text messages (continued)**

Control panel message	Description	Recommended action
2E5-ECC Memory Module Detected on Unsupported Platform	Recently added memory modules support ECC memory error correction.	<ol style="list-style-type: none"> <li>1. If additional memory was recently added, remove it to see if the problem remains.</li> <li>2. Check product documentation for memory support information.</li> </ol>
2E6-Memory Not Configured Correctly for Proper MEBx Execution	DIMM1 is not installed.	Be sure that a memory module is in the DIMM1 socket and that it is properly seated.
300-Configuration Change Warning	A change in storage configuration has been detected (see the <b>Boot Options</b> menu in BIOS Setup to enable this feature). Either the installed hardware has changed, storage or firmware mode might have been changed, or a storage device might have failed to respond.	If no changes were made before this warning, check that the drives are connected properly to power cables and system board. User Diagnostics (f2 during startup) might help identify any problem with specific devices.
301-Hard Disk 1: SMART Hard Drive Detects Imminent Failure	Hard drive will soon fail. Some hard drives have a hard drive firmware patch that will fix an erroneous error message.	<ol style="list-style-type: none"> <li>1. Determine whether hard drive is giving correct error message. Run the Drive Protection System test under using F2 Diagnostics when booting the computer.</li> <li>2. Apply hard drive firmware patch if applicable. The patch is available at <a href="http://www.hp.com/support">http://www.hp.com/support</a>.</li> <li>3. Back up contents and replace hard drive.</li> </ol>
302-Hard Disk 2: SMART Hard Drive Detects Imminent Failure	Hard drive will soon fail. Some hard drives have a hard drive firmware patch that will fix an erroneous error message.	<ol style="list-style-type: none"> <li>1. Determine whether hard drive is giving correct error message. Run the Drive Protection System test under using F2 Diagnostics when booting the computer.</li> <li>2. Apply hard drive firmware patch if applicable. The patch is available at <a href="http://www.hp.com/support">http://www.hp.com/support</a>.</li> <li>3. Back up contents and replace hard drive.</li> </ol>
309 - 30C: Hard Disk 3-6: SMART Hard Drive Detects Imminent Failure	Hard drive will soon fail. Some hard drives have a hard drive firmware patch that will fix an erroneous error message.	<ol style="list-style-type: none"> <li>1. Determine whether hard drive is giving correct error message. Run the Drive Protection System test under using F2 Diagnostics when booting the computer.</li> <li>2. Apply hard drive firmware patch if applicable. The patch is available at <a href="http://www.hp.com/support">http://www.hp.com/support</a>.</li> <li>3. Back up contents and replace hard drive.</li> </ol>
3F0-Boot Device Not Found	Boot device not found.	Insert boot device or load operating system.

**Table 7-1 POST numeric codes and text messages (continued)**

Control panel message	Description	Recommended action
3F1-Hard Disk 1 Error	Hard disk 1 error.	<ol style="list-style-type: none"> <li>1. Check cables and replace if necessary.</li> <li>2. Clear CMOS.</li> <li>3. Replace the hard disk drive.</li> </ol>
3F2-Hard Disk 2 Error	Hard disk 2 error.	<ol style="list-style-type: none"> <li>1. Check cables and replace if necessary.</li> <li>2. Clear CMOS.</li> <li>3. Replace the hard disk drive.</li> </ol>
400-Serial Port A Address Conflict Detected	Both external and internal serial ports are assigned to the same resources.	<ol style="list-style-type: none"> <li>1. Remove any serial port expansion cards.</li> <li>2. Clear CMOS.</li> <li>3. Reconfigure card resources, run Computer Setup or Windows utilities, or do both if needed.</li> </ol>
401-Serial Port B Address Conflict Detected	Both external and internal serial ports are assigned to the same resources.	<ol style="list-style-type: none"> <li>1. Remove any serial port expansion cards.</li> <li>2. Clear CMOS.</li> <li>3. Reconfigure card resources, run Computer Setup or Windows utilities, or do both if needed.</li> </ol>
402-Serial Port C Address Conflict Detected	Both external and internal serial ports are assigned to the same resources.	<ol style="list-style-type: none"> <li>1. Remove any serial port expansion cards.</li> <li>2. Clear CMOS.</li> <li>3. Reconfigure card resources, run Computer Setup or Windows utilities, or do both if needed.</li> </ol>
403-Serial Port D Address Conflict Detected	Both external and internal serial ports are assigned to the same resources.	<ol style="list-style-type: none"> <li>1. Remove any serial port expansion cards.</li> <li>2. Clear CMOS.</li> <li>3. Reconfigure card resources, run Computer Setup or Windows utilities, or do both if needed.</li> </ol>
419-Out of Memory Space for Option ROMs	Recently added PCI expansion card contains an option ROM too large to download during POST.	If a PCI expansion card was recently added, remove it to see if the problem remains.
41A-Front USB1/USB2 Not Connected	Front USB cable has been detached or unseated from system board.	Reconnect or replace front USB cable.
41B-Device in PCI Express Slot Failed To Initialize	There is an incompatibility or problem with a PCIe device and the system or PCIe link could not be configured to a valid bus width or speed.	Try rebooting the system. If the error reoccurs, the device might not work with this system
43A-USB Type-C I2C Not Connected	Cable is required between I2C on card and USB-C® on the system board.	Install cable between I2C on card and USB-C on the system board.

**Table 7-1 POST numeric codes and text messages (continued)**

Control panel message	Description	Recommended action
43B-More Than One USB type-C Cards Are Installed	More than one USB Type-C card is installed.	Remove USB Type-C card so that only one is installed.
500-BIOS Recovery	A system BIOS recovery has occurred.	Not applicable.
513-(GFX) Configuration requires a front chassis fan and this fan is not detected.	The system does not detect a front chassis fan assembly when installing a graphics card.	Install a front chassis fan assembly.
517-Memory configuration requires a memory fan and this fan is not detected.	The system does not detect a memory fan when installing a memory module.	Install a memory fan.
519-Aux fan not detected	The system does not detect a PCIe retainer fan assembly when installing a graphics card.	Install a PCIe retainer fan assembly.
520-Memory configuration requires a second memory fan and this fan is not detected.	The system does not detect a memory fan when installing a memory module.	Install a memory fan.
525-(GFX) Configuration requires a second front chassis fan and this fan is not detected.	The system does not detect a front chassis fan assembly when installing a graphics card.	Install a front chassis fan assembly.
70x-Wireless Mode Not Supported	The system has detected a wireless module installed in the system that is not supported and has been disabled.	Replace with a supported module.
800-Keyboard Error	Keyboard failure.	<ol style="list-style-type: none"> <li>1. Reconnect keyboard with computer turned off.</li> <li>2. Check connector for bent or missing pins.</li> <li>3. Be sure that none of the keys are pressed.</li> <li>4. Replace keyboard.</li> </ol>
801-Keyboard or System Unit Error	Keyboard failure.	<ol style="list-style-type: none"> <li>1. Reconnect the keyboard with computer turned off.</li> <li>2. Be sure that none of the keys are pressed.</li> <li>3. Replace the keyboard.</li> <li>4. Replace the system board.</li> </ol>
900-CPU Fan Not Detected	CPU fan is not connected or might have malfunctioned.	<ol style="list-style-type: none"> <li>1. Reseat fan.</li> <li>2. Reseat fan cable.</li> <li>3. Replace fan.</li> </ol>
901-Chassis, Rear Chassis, Front Chassis, or PCIe blower Fan not Detected	Fan is not connected or might have malfunctioned.	<ol style="list-style-type: none"> <li>1. Reseat fan.</li> <li>2. Reseat fan cable.</li> <li>3. Replace fan.</li> </ol>
904-SATA Cabling Error	One or more SATA devices are improperly attached. For optimal performance, the SATA0, SATA1, and SATA2 ports should be used for hard drives before other ports.	Be sure that SATA connectors are used in ascending order. For one device, use SATA0. For two devices, use SATA0 and SATA1. For three devices, use SATA0, SATA1, and SATA2.

**Table 7-1 POST numeric codes and text messages (continued)**

Control panel message	Description	Recommended action
90B-Fan Failure	The system has detected that a cooling fan is not operating correctly.	<ol style="list-style-type: none"> <li>1. Reseat fan.</li> <li>2. Reseat fan cable.</li> <li>3. Replace fan.</li> </ol>
90D-System Temperature	Thermal shutdown occurred. The system BIOS has detected that your machine was previously shut down to avoid overheating. Overheating might occur if the cooling vents are blocked or the operating temperature exceeds the system specifications. The machine should return to normal operation once the situation is resolved.	Be sure system has proper airflow.
90E-Power Supply Fan Not detected	Power supply fan is not connected or might have malfunctioned.	<ol style="list-style-type: none"> <li>1. Reseat power supply fan.</li> <li>2. Reseat fan cable.</li> <li>3. Replace power supply fan.</li> </ol>
910-Filter Warning	Airflow filter is dirty.	Replace the airflow filter.
911-Graphics Module Fan Not Detected	Graphics card fan is not connected or might have malfunctioned.	<ol style="list-style-type: none"> <li>1. Reseat graphics card fan.</li> <li>2. Reseat fan cable.</li> <li>3. Replace graphics card fan.</li> </ol>
912-Incorrect CPU cooler installed for this configuration	The processor cooler/heat sink does not match processor power requirement.	Replace the cooler/heat sink to match the processor power requirement.
915-Front Panel OcuLink Cable not Connected	The cable from the system board to the front panel is not connected or might have malfunctioned.	<ol style="list-style-type: none"> <li>1. Reseat cable.</li> <li>2. Replace the cable.</li> </ol>

## Interpreting POST diagnostic front panel lights and audible codes

This section identifies the front panel light codes as well as the audible codes that can occur before or during POST that might not have an error code or text message associated with them.

- ⚠ CAUTION:** When the computer is plugged into an AC power source, voltage is always applied to the system board. To reduce the risk of personal injury from electrical shock or hot surfaces, be sure to disconnect the power cord from the AC outlet and allow the internal system components to cool before touching.

During the system validation phase that occurs at system startup, the BIOS validates the functionality of the following subsystems and conditions:

- AC adapter
- System board power
- Processor failure
- BIOS corruption

- Memory failure
- Graphics failure
- System board failure
- BIOS authentication failure

If an error is detected, specific patterns of long and short blinks, accompanied by long and short beeps (where applicable) are used to identify the error. These patterns make up a two-part code:

- Major: The category of the error
- Minor: The specific error within the category

 **NOTE:** Single beep and blink codes are not used.

**Table 7-2** Beep pattern error identification

Number of long beeps or blinks	Error category
1	Not used
2	BIOS
3	Hardware
4	Thermal
5	System board

Patterns of blink/beep codes are determined by using the following parameters:

- 1-second pause occurs after the last major blink.
- 2-second pause occurs after the last minor blink.
- Beep error code sequences occur for the first five iterations of the pattern and then stop.
- Blink error code sequences continue until the computer is unplugged or the power button is pressed.

 **NOTE:** Not all diagnostic lights and audible codes are available on all models.

The red LED blinks to represent the major error category (long blinks). The white LED blinks to represent the minor error category (short blinks). For example, 3.5 indicates 3 long red blinks and 5 short white blinks to communicate the processor is not detected.

**Table 7-3** Interpreting POST diagnostic front panel lights and audible codes

Category	Major/minor code	Description
BIOS	2.2	The main area (DXE) of BIOS has become corrupted, and there is no recovery binary image available.
	2.3	The embedded controller policy requires the user to enter a key sequence.
	2.4	The embedded controller is checking or recovering the boot block.

**Table 7-3** Interpreting POST diagnostic front panel lights and audible codes (continued)

Category	Major/minor code	Description
Hardware	3.2	The embedded controller has timed out waiting for BIOS to return from memory initialization.
	3.3	The embedded controller has timed out waiting for BIOS to return from graphics initialization.
	3.4	The system board displays a power failure (crowbar).*
	3.5	The processor is not detected.*
	3.6	The processor does not support an enabled feature.
	3.7	A removable side panel is not installed.  <b>NOTE:</b> On workstations, the computer will not turn on if a removable side panel is not installed.
	Thermal	4.2
4.3		An ambient temperature over temperature condition has been detected.
4.4		An MXM over temperature condition has been detected.
System board	5.2	The embedded controller cannot find valid firmware.
	5.3	The embedded controller has timed out waiting for the BIOS.
	5.4	The embedded controller has timed out waiting for BIOS to return from system board initialization.
	5.5	The embedded controller rebooted the system after a possible lockup condition had been detected through the use of a System Health Timer, Automated System Recovery Timer, or other mechanism.

\* Indicates a hardware-triggered event; BIOS controls all other events.

---

## 8 Password security and resetting CMOS

This computer supports two security password features that you can establish through the Computer Setup Utilities menu: administrator password and power-on password.

When you establish only an administrator password, any user can access all the information on the computer except Computer Setup. When you establish only a power-on password, the power-on password is required to access Computer Setup and any other information on the computer. When you establish both passwords, only the administrator password will give you access to Computer Setup.

When both passwords are set, you can use the administrator password in place of the power-on password as an override to log in to the computer. This feature is useful for a network administrator.

 **IMPORTANT:** Back up the BIOS settings or save them as custom defaults in case you need them later. You can back up in Computer Setup or with the BiosConfigUtility tool available from [www.hp.com](http://www.hp.com). See [Computer Setup \(F10\) Utility on page 41](#) for information about backing up the BIOS settings.

---

### Changing a setup or power-on password

Use this procedure to change a password.

To change the power-on or setup password, complete the following steps:

1. Turn on or restart the computer.
  - To change the setup password, go to step 2.
  - To change the power-on password, go to step 3.
2. To change the setup password, as soon as the computer turns on:
  - Press **esc** while the “Press the ESC key for Startup Menu” message is displayed.
  - Press **f10** to enter Computer Setup.
3. When the key icon appears, type your current password, a slash (/) or alternate delimiter character, your new password, another slash (/) or alternate delimiter character, and your new password again as shown:

*current password/new password/new password*

 **NOTE:** Type the new password carefully because the characters do not appear on the screen.

---

4. Press **enter**.

The new password will take effect the next time the computer is restarted.

### Deleting a setup or power-on password

Use this procedure to delete a password.

To delete the power-on or setup password, complete the following steps:

1. Turn on or restart the computer.
  - To delete the Setup password, go to step 2.
  - To delete the Power-on password, go to step 3.
2. To delete the Setup password, as soon as the computer turns on:
  - Press `esc` while the “Press the ESC key for Startup Menu” message is displayed.
  - Press `f10` to enter Computer Setup.
3. When the key icon appears, type your current password, a slash (/) or alternate delimiter character, your new password, another slash (/) or alternate delimiter character, and your new password again as shown:

*current password/new password/new password*

4. Press `enter`.

---

## 9 Backing up, restoring, and recovering

You can use Windows tools or HP software to back up your information, create a restore point, reset your computer, create recovery media, or restore your computer to its factory state. Performing these standard procedures can return your computer to a working state faster.

---

 **IMPORTANT:** If you are performing recovery procedures on a tablet, the tablet battery must be at least 70% charged before you start the recovery process.

 **IMPORTANT:** For a tablet with a detachable keyboard, connect the tablet to the keyboard base before beginning any recovery process.

---

### Backing up information and creating recovery media

These methods of creating recovery media and backups are available on select products only.

#### Using Windows tools for backing up

HP recommends that you back up your information immediately after initial setup. You can do this task either using Windows Backup locally with an external USB drive or using online tools.

---

 **IMPORTANT:** Windows is the only option that allows you to back up your personal information. Schedule regular backups to avoid information loss.

 **NOTE:** If computer storage is 32 GB or less, Microsoft® System Restore is disabled by default.

---

#### Using the HP Cloud Recovery Download Tool to create recovery media (select products only)

You can use the HP Cloud Recovery Download Tool to create HP Recovery media on a bootable USB flash drive.

For details:

- Go to <http://www.hp.com>, search for HP Cloud Recovery, and then select the result that matches the type of computer that you have.

---

 **NOTE:** If you cannot create recovery media yourself, contact support to obtain recovery discs. Go to <http://www.hp.com/support>, select your country or region, and then follow the on-screen instructions.

 **IMPORTANT:** HP recommends that you follow the [Restoring and recovery methods on page 74](#) to restore your computer before you obtain and use the HP recovery discs. Using a recent backup can return your machine to a working state sooner than using the HP recovery discs. After the system is restored, reinstalling all the operating system software released since your initial purchase can be a lengthy process.

---

# Restoring and recovering your system

You have several tools available to recover your system both within and outside of Windows if the desktop cannot load.

HP recommends that you attempt to restore your system using the [Restoring and recovery methods on page 74](#).

## Creating a system restore

System Restore is available in Windows. The System Restore software can automatically or manually create restore points, or snapshots, of the system files and settings on the computer at a particular point.

When you use System Restore, it returns your computer to its state at the time you made the restore point. Your personal files and documents should not be affected.

## Restoring and recovery methods

After you run the first method, test to see whether the issue still exists before you proceed to the next method, which might now be unnecessary.

1. Run a Microsoft System Restore.
2. Run Reset this PC.



---

**NOTE:** The options **Remove everything** and then **Fully clean the drive** can take several hours to complete and leave no information on your computer. It is the safest way to reset your computer before you recycle it.

---

3. Recover using HP Recovery media. For more information, see [Recovering using HP Recovery media on page 74](#).

For more information about the first two methods, see the Get Help app:

Select the **Start** button, select the **Get Help** app, and then enter the task you want to perform.



---

**NOTE:** You must be connected to the internet to access the Get Help app.

---

## Recovering using HP Recovery media

You can use HP Recovery media to recover the original operating system and software programs that were installed at the factory. On select products, it can be created on a bootable USB flash drive using the HP Cloud Recovery Download Tool.

For details, see [Using the HP Cloud Recovery Download Tool to create recovery media \(select products only\) on page 73](#).



---

**NOTE:** If you cannot create recovery media yourself, contact support to obtain recovery discs. Go to <http://www.hp.com/support>, select your country or region, and then follow the on-screen instructions.

---

To recover your system:

- Insert the HP Recovery media, and then restart the computer.



---

**NOTE:** HP recommends that you follow the [Restoring and recovery methods on page 74](#) to restore your computer before you obtain and use the HP recovery discs. Using a recent backup can return your

machine to a working state sooner than using the HP recovery discs. After the system is restored, reinstalling all the operating system software released since your initial purchase can be a lengthy process.

---

## Changing the computer boot order

If your computer does not restart using the HP Recovery USB flash drive, you can change the computer boot order, which is the order of devices listed in BIOS for startup information.



**IMPORTANT:** For a tablet with a detachable keyboard, connect the tablet to the keyboard base before beginning these steps.

---

To change the boot order:

1. Insert the HP Recovery USB flash drive.
2. Access the system **Startup** menu.
  - For computers or tablets with keyboards attached, turn on or restart the computer or tablet, quickly press **esc**, and then press **f9** for boot options.
  - For tablets without keyboards, turn on or restart the tablet, and then quickly press and hold one of the following buttons:
    - Volume up
    - Volume down

Then select **f9**.
3. Select the USB flash drive to boot from, and then follow the on-screen instructions.

## Using HP Sure Recover (select products only)

Select computer models are configured with HP Sure Recover, a PC operating system (OS) recovery solution built into the hardware and software. HP Sure Recover can fully restore the HP OS image without installed recovery software.

Using HP Sure Recover, an administrator or user can restore the system and install:

- Latest version of the operating system
- Platform-specific device drivers
- Software applications, in the case of a custom image

To access the latest documentation for HP Sure Recover, go to <http://www.hp.com/support>. Follow the on-screen instructions to find your product and locate your documentation.

---

# 10 Statement of memory volatility

For general information regarding nonvolatile memory in HP business computers, and to restore nonvolatile memory that can contain personal data after the system has been turned off and the hard drive has been removed, use these instructions.

HP business computer products that use Intel®-based or AMD®-based system boards contain volatile DDR memory. The amount of nonvolatile memory present in the system depends upon the system configuration. Intel-based and AMD-based system boards contain nonvolatile memory subcomponents as originally shipped from HP, with the following assumptions:

- No subsequent modifications were made to the system.
- No applications, features, or functionality were added to or installed on the system.

Following system shutdown and removal of all power sources from an HP business computer system, personal data can remain on volatile system memory (DIMMs) for a finite period of time and also remains in nonvolatile memory. Use the following steps to remove personal data from the computer, including the nonvolatile memory found in Intel-based and AMD-based system boards.

---

 **NOTE:** If your tablet has a keyboard base, connect to the keyboard base before beginning steps in this chapter.

---

## Current BIOS steps

Use these instructions to restore nonvolatile memory.

1. Follow these steps to restore the nonvolatile memory that can contain personal data. Restoring or reprogramming nonvolatile memory that does not store personal data is neither necessary nor recommended.
  - a. Turn on or restart the computer, and then quickly press **esc**.

---

 **NOTE:** If the system has a BIOS administrator password, type the password at the prompt.

---

- b. Select **Main**, select **Apply Factory Defaults and Exit**, and then select **Yes** to load defaults. The computer restarts.
- c. During the restart, press **esc** while the "Press the ESC key for Startup Menu" message is displayed at the bottom of the screen.

---

 **NOTE:** If the system has a BIOS administrator password, type the password at the prompt.

---

- d. Select the **Security** menu, select **Restore Security Settings to Factory Defaults**, and then select **Yes** to restore security level defaults. The computer restarts.
- e. During the restart, press **esc** while the "Press the ESC key for Startup Menu" message is displayed at the bottom of the screen.

---

 **NOTE:** If the system has a BIOS administrator password, type the password at the prompt.

---

- f. If an asset or ownership tag is set, select the **Security** menu and scroll down to the **Utilities** menu. Select **System IDs**, and then select **Asset Tracking Number**. Clear the tag, and then make the selection to return to the prior menu.
- g. If a DriveLock password is set, select the **Security** menu, and scroll down to **Hard Drive Utilities** under the **Utilities** menu. Select **Hard Drive Utilities**, select **DriveLock**, and then clear the check box for **DriveLock password on restart**. Select **OK** to proceed.
- h. Select the **Main** menu, and then select **Reset BIOS Security to factory default**. Select **Yes** at the warning message. The computer restarts.
- i. During the restart, press **esc** while the "Press the ESC key for Startup Menu" message is displayed at the bottom of the screen.



---

**NOTE:** If the system has a BIOS administrator password, type the password at the prompt.

---

- j. Select the **Main** menu, select **Apply Factory Defaults and Exit**, select **Yes** to save changes and exit, and then select **Shutdown**.
  - k. Restart the system. If the system has a Trusted Platform Module (TPM), fingerprint reader, or both, one or two prompts will appear—one to clear the TPM and the other to Reset Fingerprint Sensor. Press or tap **f1** to accept or **f2** to reject.
  - l. Remove all power and system batteries for at least 24 hours.
2. Complete one of the following tasks:
- Remove and retain the storage drive.
  - Clear the drive contents by using a third-party utility designed to erase data from an SSD.
  - Clear the contents of the drive by using the following BIOS Setup Secure Erase command option steps:



---

**NOTE:** If you clear data using Secure Erase, you cannot recover it.

---

- a. Turn on or restart the computer, and then quickly press **esc**.
- b. Select the **Security** menu and scroll down to the **esc** menu.
- c. Select **Hard Drive Utilities**.
- d. Finish by completing one of these tasks:
  - Under **Utilities**, select **Secure Erase**, select the hard drive storing the data you want to clear, and then follow the on-screen instructions to continue.
  - Clear the contents of the drive using the following Disk Sanitizer commands steps:
    - i. Turn on or restart the computer, and then quickly press **esc**.
    - ii. Select the **Security** menu and scroll down to the **Utilities** menu.
    - iii. Select **Hard Drive Utilities**.

- iv. Under **Utilities**, select **Disk Sanitizer**, select the hard drive with the data that you want to clear, and then follow the on-screen instructions to continue.



**NOTE:** The amount of time it takes for Disk Sanitizer to run can take several hours. Plug the computer into an AC outlet before starting.

## Nonvolatile memory usage

Use this table to troubleshoot nonvolatile memory usage.

**Table 10-1** Troubleshooting information for nonvolatile memory usage

Description	Volatility description	Storage user data	How to erase
Primary storage device, holds the OS, applications, and application settings	Nonvolatile, 8-256 GB of eMMC or NVMe SSD storage, removable	Yes <sup>1</sup>	Follow instructions below under “Erase the Primary Storage Device.”
System memory (RAM), holds transient data during system operation	Volatile, SODIMM socket. Removable (4 GB/8 GB/16 GB)	Yes	Unplug unit from power.
Permanent system BIOS settings	Nonvolatile; 16 KB; stored	No <sup>2</sup>	Follow instructions below under “Clearing BIOS Settings.”
System boot ROM (BIOS)	Nonvolatile memory, 128 Mbit (16 MB) socketed, removable	No	Download the latest BIOS for your model from the HP website and follow the instructions to flash the BIOS that are on the website.
RTC (CMOS) RAM	Volatile memory, 256 bytes located in AMD embedded System on Chip (SoC)	No	<p><b>Desktop computers with a CMOS button:</b></p> <p>Unplug unit from main power, remove top cover and press the <b>Clear CMOS</b> button.</p> <p><b>Notebook and desktop computers without a CMOS button:</b></p> <p>Remove and replace the RTC battery.</p>
Keyboard/mouse (ROM)	Nonvolatile, 2 KB embedded in the super I/O controller (SIO2)	Yes	N/A
Keyboard/mouse (RAM)	Volatile, 256 bytes embedded in the super I/O controller (SIO2)	No	Unplug unit from main power.
LOM EEPROM	Nonvolatile, 2 MB embedded in LAN controller	No	N/A
Trusted Platform Module (TPM)	Nonvolatile; 51 KB ROM for firmware and 38 KB system parametric data	No <sup>3</sup>	Follow instructions below under “Clearing TPM.”

<sup>1</sup> Under typical operation, the only user data stored on the primary storage device are preferences for device configuration and settings for connections. However, the administrator can configure the system to allow users to store data locally.

<sup>2</sup> The only user data potentially stored in BIOS Settings are the ownership and asset tags, administrator password, and startup password.

<sup>3</sup> The Trusted Platform Module might contain encrypted passwords or certificates generated from user or administrator input.

## Questions and answers

Use this section to answer your questions about nonvolatile memory.

### 1. How can the BIOS settings be restored (returned to factory settings)?

 **IMPORTANT:** The restore defaults feature does not securely erase any information on your hard drive. See question and answer 6 for steps to securely erase information.

The restore defaults feature does not reset the Custom Secure Boot keys. See question and answer 7 for information about resetting the keys.

- a. Turn on or restart the computer, and then quickly press **esc**.
- b. Select **Main**, and then select **Apply Factory Defaults and Exit**.
- c. Follow the on-screen instructions.
- d. Select **Main**, select **Save Changes and Exit**, and then follow the on-screen instructions.

### 2. What is a UEFI BIOS?

The Unified Extensible Firmware Interface (UEFI) BIOS is an industry-standard software interface between the platform firmware and an operating system (OS). It replaces the older legacy BIOS architecture.

The UEFI BIOS provides an interface to display the system information and configuration settings and to change the configuration of your computer before an OS is loaded. BIOS provides a secure runtime environment that supports a GUI. In this environment, you can use either a pointing device (touch screen, touchpad, pointing stick, or USB mouse) or the keyboard to navigate and make menu and configuration selections. The UEFI BIOS also contains basic system diagnostics.

In addition, the UEFI BIOS works to initialize the computer's hardware before loading and executing the OS; the runtime environment allows the loading and execution of software programs from storage devices to provide more functionality, such as advanced hardware diagnostics (with the ability to display more detailed system information) and advanced firmware management and recovery software.

### 3. Where is the UEFI BIOS located?

The UEFI BIOS is located on a flash memory chip. You must use a utility to write to the chip.

### 4. What kind of configuration data is stored on the DIMM Serial Presence Detect (SPD) memory module? How would this data be written?

The DIMM SPD memory contains information about the memory module, such as size, serial number, data width, speed and timing, voltage, and thermal information. This information is written by the module manufacturer and stored on an EEPROM. You cannot write to this EEPROM when the memory module is installed in a computer. Third-party tools do exist that can write to the EEPROM when the memory module is not installed in a computer. Various third-party tools are available to read SPD memory.

5. What is meant by “Restore the nonvolatile memory found in Intel-based system boards”?

This message relates to clearing the Real Time Clock (RTC) CMOS memory that contains computer configuration data.

6. How can the BIOS security be reset to factory defaults and erase the data?



**IMPORTANT:** Resetting results in the loss of information.

These steps do not reset Custom Secure Boot Keys. See question and answer 7 for information about resetting the keys.

- a. Turn on or restart the computer, and then quickly press **esc**.
- b. Select **Main**, and then select **Reset Security to Factory Defaults**.
- c. Follow the on-screen instructions.
- d. Select **Main**, select **Save Changes and Exit**, and then follow the on-screen instructions.

7. How can the Custom Secure Boot Keys be reset?

Secure Boot is a feature to ensure that only authenticated code can start on a platform. If you enabled Secure Boot and created Custom Secure Boot Keys, disabling Secure Boot does not clear the keys. You must also select to clear the Custom Secure Boot Keys. Use the same Secure Boot access procedure that you used to create the Custom Secure Boot Keys, but select to clear or delete all Secure Boot Keys.

- a. Turn on or restart the computer, and then quickly press **esc**.
- b. Select the **Security** menu, select **Secure Boot Configuration**, and then follow the on-screen instructions.
- c. At the **Secure Boot Configuration** window, select **Secure Boot**, select **Clear Secure Boot Keys**, and then follow the on-screen instructions to continue.

---

# 11 Using HP PC Hardware Diagnostics

You can use the HP PC Hardware Diagnostics utility to determine whether your computer hardware is running properly. The three versions are HP PC Hardware Diagnostics Windows, HP PC Hardware Diagnostics UEFI (Unified Extensible Firmware Interface), and (for select products only) Remote HP PC Hardware Diagnostics UEFI, a firmware feature.

## Using HP PC Hardware Diagnostics Windows (select products only)

HP PC Hardware Diagnostics Windows is a Windows-based utility that allows you to run diagnostic tests to determine whether the computer hardware is functioning properly. The tool runs within the Windows operating system to diagnose hardware failures.

If HP PC Hardware Diagnostics Windows is not installed on your computer, you must download and install it. To download HP PC Hardware Diagnostics Windows, see [Downloading HP PC Hardware Diagnostics Windows on page 82](#).

## Using an HP PC Hardware Diagnostics Windows hardware failure ID code

When HP PC Hardware Diagnostics Windows detects a failure that requires hardware replacement, a 24-digit failure ID code is generated for select component tests. For interactive tests, such as keyboard, mouse, or audio and video palette, you must perform troubleshooting steps before you can receive a failure ID.

You have several options after you receive a failure ID:

- Select **Next** to open the Event Automation Service (EAS) page, where you can log the case.
- Scan the QR code with your mobile device, which takes you to the EAS page, where you can log the case.
- Select the box next to the 24-digit failure ID to copy your failure code and send it to support.

## Accessing HP PC Hardware Diagnostics Windows

After HP PC Hardware Diagnostics Windows is installed, you can access it from HP Support Assistant or the Start menu.

### Accessing HP PC Hardware Diagnostics Windows from HP Support Assistant

After HP PC Hardware Diagnostics Windows is installed, follow these steps to access it from HP Support Assistant:

1. Complete one of the following tasks:
  - Select the **Search** icon in the taskbar, type `support` in the search box, and then select the **HP Support Assistant** app.
  - Select the question mark icon in the taskbar.
2. Select **Fixes & Diagnostics**.

3. Select **Run hardware diagnostics**, and then select **Launch**.
4. When the tool opens, select the type of diagnostic test that you want to run, and then follow the on-screen instructions.



---

**NOTE:** To stop a diagnostic test, select **Cancel**.

---

## Accessing HP PC Hardware Diagnostics Windows from the Start menu (select products only)

After HP PC Hardware Diagnostics Windows is installed, follow these steps to access it from the Start menu:

1. Select the **Start** button, and then select **All apps**.
2. Select **HP PC Hardware Diagnostics Windows**.
3. When the tool opens, select the type of diagnostic test that you want to run, and then follow the on-screen instructions.



---

**NOTE:** To stop a diagnostic test, select **Cancel**.

---

## Downloading HP PC Hardware Diagnostics Windows

The HP PC Hardware Diagnostics Windows downloading instructions are provided in English only. You must use a Windows computer to download this tool because only .exe files are provided.

### Downloading the latest HP PC Hardware Diagnostics Windows version from HP

To download HP PC Hardware Diagnostics Windows from HP, follow these steps:

1. Go to <http://www.hp.com/go/techcenter/pcdiags>. The HP PC Diagnostics home page is displayed.
2. Select **Diagnose PC Hardware issues in Windows**, scroll down to the expanded window that appears, and then select **Download**.
3. A pop-up that asks what you want to do with the file opens. Select **Open** or **Save As**. The latest version of the diagnostics tool opens or downloads to the selected location.

### Downloading the HP PC Hardware Diagnostics Windows from the Microsoft Store

You can download the HP PC Hardware Diagnostics Windows from the Microsoft Store:

1. Select the Microsoft Store app on your desktop or select the **Search** icon in the taskbar, and then type `Microsoft Store` in the search box.
2. Type `HP PC Hardware Diagnostics Windows` in the **Microsoft Store** search box.
3. Follow the on-screen directions.

The tool downloads to the selected location.

## Downloading HP Hardware Diagnostics Windows by product name or number (select products only)

You can download HP PC Hardware Diagnostics Windows by product name or number.

 **NOTE:** For some products, you might have to download the software to a USB flash drive by using the product name or number.

1. Go to <http://www.hp.com/support>.
2. Select **Software and Drivers**, select your type of product, and then enter the product name or number in the search box that is displayed.
3. In the **Diagnostics** section, select **Download**, and then follow the on-screen instructions to select the specific Windows diagnostics version to be downloaded to your computer or USB flash drive.

The tool downloads to the selected location.

## Installing HP PC Hardware Diagnostics Windows

To install HP PC Hardware Diagnostics Windows, navigate to the folder on your computer or the USB flash drive where the .exe file downloaded, double-click the .exe file, and then follow the on-screen instructions.

## Using HP PC Hardware Diagnostics UEFI

HP PC Hardware Diagnostics Unified Extensible Firmware Interface (UEFI) allows you to run diagnostic tests to determine whether the computer hardware is functioning properly. The tool runs outside the operating system so that it can isolate hardware failures from issues that are caused by the operating system or other software components.

 **NOTE:** For some products, you must use a Windows computer and a USB flash drive to download and create the HP UEFI support environment because only .exe files are provided. For more information, see [Downloading HP PC Hardware Diagnostics UEFI to a USB flash drive on page 84](#).

If your PC does not start in Windows, you can use HP PC Hardware Diagnostics UEFI to diagnose hardware issues.

## Using an HP PC Hardware Diagnostics UEFI hardware failure ID code

When HP PC Hardware Diagnostics UEFI detects a failure that requires hardware replacement, a 24-digit failure ID code is generated.

For assistance in solving the problem, complete one of these tasks:

- Select **Contact HP**, accept the HP privacy disclaimer, and then use a mobile device to scan the failure ID code that appears on the next screen. The HP Customer Support - Service Center page appears with your failure ID and product number automatically filled in. Follow the on-screen instructions.
- Contact support, and provide the failure ID code.

## Starting HP PC Hardware Diagnostics UEFI

To start HP PC Hardware Diagnostics UEFI, follow this procedure.

1. Turn on or restart the computer, and quickly press **esc**.
2. Press **f2**.

The BIOS searches three places for the diagnostic tools, in the following order:

- a. Connected USB flash drive



**NOTE:** To download the HP PC Hardware Diagnostics UEFI tool to a USB flash drive, see [Downloading the latest HP PC Hardware Diagnostics UEFI version on page 85](#).

- b. Hard drive

- c. BIOS

3. When the diagnostic tool opens, select the type of diagnostic test that you want to run, and then follow the on-screen instructions.

## Starting HP PC Hardware Diagnostics UEFI through HP Hotkey Support software (select products only)

This section describes how to start HP PC Hardware Diagnostics UEFI through HP Hotkey Support software.



**NOTE:** You must disable fast boot to access HP PC Hardware Diagnostics UEFI from the HP System Information application.

To disable fast boot:

1. Turn on or restart the computer, and when the HP logo appears, press **f10** to enter Computer Setup.
2. Select **Advanced**, and then select **Boot Options**.
3. Clear **Fast Boot**.
4. Select **Save Changes and Exit**, and then select **Yes**.

To start HP PC Hardware Diagnostics UEFI through HP Hotkey Support software, follow this procedure:

1. From the **Start** menu, open the HP System Information Application or press **fn+esc**.
2. In HP System Information screen, select **Run System Diagnostics**, select **Yes** to run the application, and then select **Restart**.



**IMPORTANT:** To prevent loss of data, save your work in all open apps before restarting your computer.



**NOTE:** When the restart is complete, the computer opens the HP PC Hardware Diagnostics UEFI Application. Proceed with the troubleshooting tests.

## Downloading HP PC Hardware Diagnostics UEFI to a USB flash drive

Downloading HP PC Hardware Diagnostics UEFI to a USB flash drive can be useful in some situations.

- HP PC Hardware Diagnostics UEFI is not included in the preinstallation image.
- HP PC Hardware Diagnostics UEFI is not included in the HP Tool partition.

- The hard drive is damaged.



---

**NOTE:** The HP PC Hardware Diagnostics UEFI downloading instructions are provided in English only, and you must use a Windows computer to download and create the HP UEFI support environment because only .exe files are provided.

---

## Downloading the latest HP PC Hardware Diagnostics UEFI version

To download the latest HP PC Hardware Diagnostics UEFI version to a USB flash drive, follow these steps:

1. Go to <http://www.hp.com/go/techcenter/pcdiags>. The HP PC Diagnostics home page is displayed.
2. Select **Diagnose PC Hardware Issues outside of the OS**, scroll down to the expanded window that appears, and then select **Download**.
3. A pop-up that asks what you want to do with the file opens. Select **Open** or **Save As**. The latest version of the diagnostics tool opens or downloads to the selected location.

## Downloading HP PC Hardware Diagnostics UEFI by product name or number (select products only)

You can download HP PC Hardware Diagnostics UEFI by product name or number (select products only) to a USB flash drive.



---

**NOTE:** For some products, you might have to download the software to a USB flash drive by using the product name or number.

---

1. Go to <http://www.hp.com/support>.
2. Enter the product name or number, select your computer, and then select your operating system.
3. In the **Diagnostics** section, follow the on-screen instructions to select and download the specific UEFI Diagnostics version for your computer.

## Using Remote HP PC Hardware Diagnostics UEFI settings (select products only)

Remote HP PC Hardware Diagnostics UEFI is a firmware (BIOS) feature that downloads HP PC Hardware Diagnostics UEFI to your computer. It can then run the diagnostics on your computer, and it might upload results to a preconfigured server.

For more information about Remote HP PC Hardware Diagnostics UEFI, go to <http://www.hp.com/go/techcenter/pcdiags>, select **Diagnose Other Potential Issues**, scroll down to **Remote PC Hardware Diagnostics UEFI**, and then select **Learn More**.

## Downloading Remote HP PC Hardware Diagnostics UEFI

Remote HP PC Hardware Diagnostics UEFI is also available as a SoftPaq that you can download to a server.

## Downloading the latest Remote HP PC Hardware Diagnostics UEFI version

You can download the latest Remote HP PC Hardware Diagnostics UEFI version to a USB flash drive.

1. Go to <http://www.hp.com/go/techcenter/pcdiags>. The HP PC Diagnostics home page is displayed.

2. Select **Diagnose PC Hardware Issues outside of the OS**, scroll down to the expanded window that appears, and then select **Download**.
3. A pop-up that asks what you want to do with the file opens. Select **Open** or **Save As**. The latest version of the diagnostics tool opens or downloads to the selected location.

## Downloading Remote HP PC Hardware Diagnostics UEFI by product name or number

You can download Remote HP PC Hardware Diagnostics UEFI by product name or number.



**NOTE:** For some products, you might have to download the software by using the product name or number.

1. Go to <http://www.hp.com/support>.
2. Select **Software and Drivers**, select your type of product, enter the product name or number in the search box that is displayed, select your computer, and then select your operating system.
3. In the **Diagnostics** section, follow the on-screen instructions to select and download the **Remote UEFI** version for the product.

## Customizing Remote HP PC Hardware Diagnostics UEFI settings

Using the Remote HP PC Hardware Diagnostics setting in Computer Setup (BIOS), you can perform several customizations.

- Set a schedule for running diagnostics unattended. You can also start diagnostics immediately in interactive mode by selecting **Execute Remote HP PC Hardware Diagnostics UEFI**.
- Set the location for downloading the diagnostic tools. This feature provides access to the tools from the HP website or from a server that has been preconfigured for use. Your computer does not require the traditional local storage, such as a hard drive or USB flash drive, to run remote diagnostics.
- Set a location for storing the test results. You can also set the user name and password that you use for uploads.
- Display status information about the diagnostics run previously.

To customize Remote HP PC Hardware Diagnostics UEFI settings, follow these steps:

1. Turn on or restart the computer, and when the HP logo appears, press **f10** to enter Computer Setup.
2. Select **Advanced**, and then select **Settings**.
3. Make your customization selections.
4. Select **Main**, then select **Save Changes and Exit** to save your settings.

Your changes take effect when the computer restarts.

---

## 12 Power cord set requirements

The power supplies on some computers have external power switches.

The voltage select switch feature on the computer permits it to operate from any line voltage of 100 V AC to 120 V AC or 220 V AC to 240 V AC. Power supplies on those computers that do not have external power switches are equipped with internal switches that sense the incoming voltage and automatically switch to the proper voltage.

The power cord set received with the computer meets the requirements for use in the country where you purchased the equipment.

Power cord sets for use in other countries must meet the requirements of the country where you use the computer.

### General requirements

These requirements are applicable to all countries.

1. The power cord must be approved by an acceptable accredited agency responsible for evaluation in the country where the power cord set will be installed.
2. The power cord set must have a minimum current capacity of 10 A (7 A Japan only) and a nominal voltage rating of 125 V AC or 250 V AC, as required by each country's power system.
3. The diameter of the wire must be a minimum of 0.75 mm<sup>2</sup> or 18 AWG, and the length of the cord must be between 1.8 m (6 ft) and 3.6 m (12 ft).

The power cord should be routed so that it is not likely to be walked on or pinched by items placed upon it or against it. Particular attention should be paid to the plug, electrical outlet, and the point where the cord exits from the product.

---

 **WARNING!** Do not operate this product with a damaged power cord set. If the power cord set is damaged in any manner, replace it immediately.

---

### Japanese power cord requirements

For use in Japan, use only the power cord received with this product.

---

 **IMPORTANT:** Do not use the power cord received with this product on any other products.

---

### Country-specific requirements

This information provides additional requirements specific to a country.

**Table 12-1 Power cord country-specific requirements**

Country	Accrediting Agency	Country	Accrediting Agency
Australia (1)	EANSW	Italy (1)	IMQ
Austria (1)	OVE	Japan (3)	METI
Belgium (1)	CEBC	Norway (1)	NEMKO
Canada (2)	CSA	Sweden (1)	SEMKO
Denmark (1)	DEMKO	Switzerland (1)	SEV
Finland (1)	SETI	United Kingdom (1)	BSI
France (1)	UTE	United States (2)	UL
Germany (1)	VDE		

1. The flexible cord must be Type HO5VV-F, 3-conductor, 0.75 mm<sup>2</sup> conductor size. Power cord set fittings (appliance coupler and plug) must bear the certification mark of the agency responsible for evaluation in the country where it will be used.
2. The flexible cord must be Type SVT or equivalent, No. 18 AWG, 3 conductor. The plug must be a 2-pole grounding type with a NEMA 5-15P (15 A, 125 V) or NEMA 6-15P (15 A, 250 V) configuration.
3. Appliance coupler, flexible cord, and plug must bear a T mark and registration number in accordance with the Japanese Dentori Law. Flexible cord must be Type VCT or VCTF, 3-conductor, 0.75 mm<sup>2</sup> conductor size. Plug must be a 2-pole grounding type with a Japanese Industrial Standard C8303 (7 A, 125 V) configuration.

# 13 Specifications

This section provides specifications for your computer.

**Table 13-1 Specifications**

	Metric	U.S.
<b>Dimensions</b>		
Height	34 mm	1.3 in
Width	177 mm	6.9 in
Depth	181 mm	7.0 in
<b>Approximate weight</b>	1.4 kg	3.1 lb
<b>Temperature range</b>		
Operating	10°C to 35°C	50°F to 95°F
Nonoperating	-30°C to 65°C	-22°F to 149°F
<b>Maximum altitude (unpressurized)</b>		
Operating	5,000 m	16,404 ft
Nonoperating	1,5240 m	50,000 ft
<b>Relative humidity (noncondensing)</b>		
Operating	10% to 95%	
Nonoperating (38.7°C max wet bulb)	0% to 95%	
<b>Power supply</b>		
Operating voltage range	90 V AC to 264 V AC	
Rated voltage range <sup>1</sup>	100 V AC to 240 V AC	
Rated line frequency	50 Hz to 60 Hz	
Operating line frequency	47 Hz to 63 Hz	
<b>Standard efficiency</b>		
	90 W EPS, 88% efficient	
	100 W EPS, 88% efficient	
	120 W EPS, 88% efficient	

<sup>1</sup> This system uses an active power factor-corrected power supply. This allows the system to pass the CE mark requirements for use in the countries of the European Union. The active power factor-corrected power supply also has the added benefit of not requiring an input-voltage range select switch.

 **NOTE:** Operating temperature is derated 1.0°C per 300 m (1000 ft) to 3000 m (10,000 ft) above sea level; no direct sustained sunlight. Maximum rate of change is 10°C/hour. The upper limit might be limited by the type and number of options installed.

---

# Index

- A**
  - access panel
    - illustrated 5
    - removal and replacement 21
    - spare part number 21
  - Advanced menu, Computer Setup 52
  - ambient sensor
    - illustrated 5
  - antenna
    - illustrated 6
  - audible codes 68
- B**
  - backup, creating 73
  - backups 73
  - battery
    - disposal 11, 17, 19
  - battery replacement 32
  - beep codes 68
  - blinking lights 68
  - boot order, changing 75
  - booting options
    - Full Boot 62
    - Quick Boot 62
  - bracket
    - removal and replacement 29
    - spare part number 29
- C**
  - cable management 11, 19
  - changing a Power-On password 71
  - changing a Setup password 71
  - cleaning
    - computer 11, 14, 16
    - mouse 11, 14, 17
    - safety precautions 11, 14
  - cleaning your computer
    - disinfecting 15
    - removing dirt and debris 15
  - CMOS
    - clearing and resetting 71
  - computer cleaning 11, 14, 16
  - computer major components 5
  - Computer Setup
    - Advanced menu 52
    - Main menu 42
    - Security menu 46
  - Computer Setup Utility 41
  - country power cord set requirements 87
- D**
  - deleting a Power-On password 71
  - deleting a Setup password 71
- E**
  - electrostatic discharge (ESD) 11
    - preventing damage 11, 12
  - error
    - codes 62, 68
    - error messages 62
- F**
  - F10 Setup 41
  - fan
    - removal and replacement 21
    - spare part number 21
  - Fan
    - illustrated 6
  - Fan (second)
    - illustrated 6
  - flex I/O connector board
    - removal and replacement 33
  - flex I/O connector board (board-to-board)
    - removal and replacement 34
  - front panel components 1
- G**
  - grounding methods 11, 12
- H**
  - hard drive
    - proper handling 11, 17, 18
  - heat sink
    - removal and replacement 35
    - spare part number 35
  - heat sink with fan
    - illustrated 6
  - HP PC Hardware Diagnostics UEFI
    - downloading 84
    - failure ID code 83
    - HP Hotkey Support
      - software 84
    - starting 83, 84
    - using 83
  - HP PC Hardware Diagnostics Windows
    - accessing 81, 82
    - downloading 82
    - failure ID code 81
    - installing 83
    - using 81
  - HP Recovery media
    - recovery 74
  - HP Sure Recover 75
  - HP Sure Start 76
- I**
  - illustrated parts catalog 5
  - installing
    - battery 32
    - memory modules 25
- K**
  - keyboard
    - cleaning 11, 14, 16
- L**
  - lights
    - blinking PS/2 keyboard 68
- M**
  - Main menu, Computer Setup 42
  - memory
    - nonvolatile 76
    - socket population 25
    - volatile 76
  - memory modules
    - removal and replacement 25
    - spare part number 25
  - miscellaneous parts 7
  - mouse
    - cleaning 11, 14, 17
- N**
  - nonvolatile memory 76

- numeric error codes 62
- O**
- operating guidelines 11, 14
- overheating, prevention 11, 14
- P**
- password
  - Power-On 71
  - security 71
  - Setup 71
- POST error messages 62
- power cord set requirements
  - country specific 87
- power supply
  - operating voltage range 89
- Power-On password 71
- processor
  - removal and replacement 36
  - spare part number 36
- Processor
  - illustrated 5
- product features 1
- product ID location 4
- R**
- rear panel components 3
- recovery 73, 74
  - discs 74
  - media 74
  - USB flash drive 74
- recovery media 73
  - creating using HP Cloud Recovery Download Tool 73
  - creating using Windows tools 73
- Remote HP PC Hardware Diagnostics UEFI settings
  - customizing 86
  - using 85
- removal and replacement
  - access panel 21
  - bracket 29
  - fan 21, 28
  - flex I/O connector board 33
  - flex I/O connector board (board-to-board) 34
  - heat sink 35
  - memory modules 25
  - procedures 20, 28
  - processor 36
  - solid-state drive 30
  - speaker 23
  - system board 38
  - WLAN module 23
- removing
  - battery 32
- removing personal data from volatile system memory 76
- restoring 73
- restoring and recovery methods 74
- S**
- safety precautions
  - cleaning 11, 14
- screws, correct size 11, 17, 18
- Security menu, Computer Setup 46
- serial number location 4
- service considerations 11, 17
- Setup password 71
- software
  - servicing computer 11, 17
- solid-state drive
  - removal and replacement 30
  - spare part number 30
- solid-state drive on support bracket
  - removal and replacement 28
  - spare part number 28
- spare part number
  - access panel 21
  - bracket 29
  - fan 21, 28
  - heat sink 35
  - memory modules 25
  - processor 36
  - solid-state drive 30
  - speaker 23
  - system board 38
  - WLAN module 23
- speaker
  - illustrated 5
  - removal and replacement 23
  - spare part number 23
- specifications
  - computer 89
- static electricity 11
- support bracket
  - illustrated 6
- system board
  - illustrated 6
  - removal and replacement 38
  - spare part number 38
- system board callouts 39
- system memory, removing
  - personal data from volatile 76
- system restore 74
- system restore point, creating 73
- T**
- temperature control 11, 14
- tools, servicing 11, 17
- Torx T15 screwdriver 11, 17
- U**
- using Computer Setup Utilities 41
- V**
- ventilation, proper 11, 14
- W**
- Windows
  - backup 73
  - recovery media 73
  - system restore point 73
- Windows tools, using 73
- WLAN
  - illustrated 6
- WLAN module
  - removal and replacement 23
  - spare part number 23