

5320 Series Quick Reference

Follow these steps to get the switch ready for use.

For complete installation instructions see *5320 Series Hardware Installation Guide* at www.extremenetworks.com/documentation

Necessary Tools



- #2 Phillips screwdriver (magnetic screwdriver recommended)
- ESD-protective wrist strap

1 Prepare the Site

The installation site must meet the following requirements:

- Appropriately grounded power receptacles located within 1.8 m (6 ft.).
- A readily accessible device for disconnecting power, such as a breaker or master switch.
- Network cabling within reach.
- Up to at least of 7.6 cm (3.0 in.) on all sides, for proper ventilation.
- Temperature between 0°C (32°F) and 50°C (122°F) -- or as noted in "Operating Temperature:" -- with fluctuations of less than 10°C (18°F) per hour.

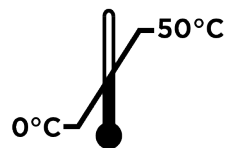

2 Unpack the Box

Remove the packing material, and verify that all of the following components are included:

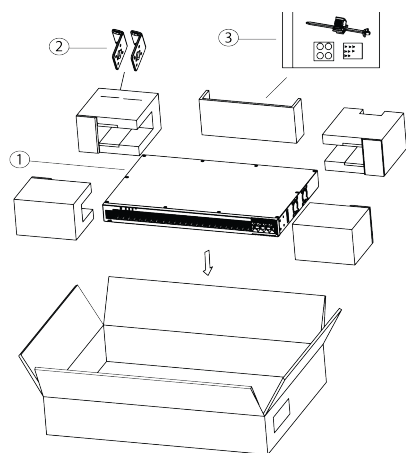

- Switch
- Rack mount ears (2)
- Accessory bag (Power cable tie, rubber feet (4), and screws (8))

Console cables can be ordered separately. If the switch appears to be damaged, contact Extreme Networks. See "Getting Help" for more information.

3 Install the 5320 Series

You can install any 5320 Series in a standard 19-inch equipment rack.

All 5320 Series support mounting on a table (rubber feet provided) or in a rack (mounting ears provided). Both 5320-16P-4XE and 5320-16P-4XE-DC also support wall mounting, under the table mounting, and cleaner mounting. Anchors and wood screws are provided.

Two-Post Rack Mount

This procedure uses a two-post mounting kit, which accommodates rack posts 3 inches or 6 inches wide. Rack ears can support both flush and mid-mount, and can be installed in a four-post rack, using just the two front posts or two back posts.

- Attach a mounting bracket to each side of the switch, screwing it into the holes so that the flange (ear) faces the front of the switch to flush-mount, or faces the rear of the switch to mid-mount.

Note: Do not block the air vent on the top of the unit. Leaving a space between units ensures adequate airflow.

Figure 1 5320-48P/T and 5320-24P/T Flush-Mount

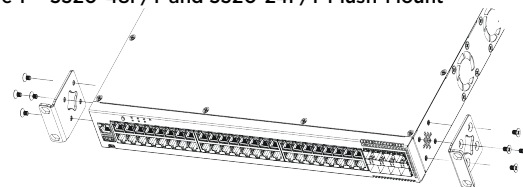

Figure 2 5320-48P/T and 5320-24P/T Mid-Mount

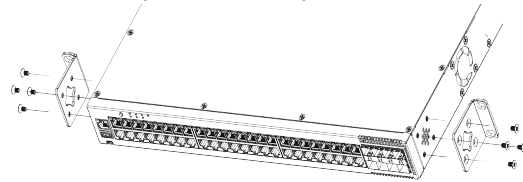

Figure 3 5320-16P Flush-Mount

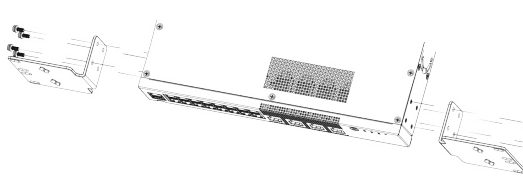

Figure 4 5320-16P Mid-Mount

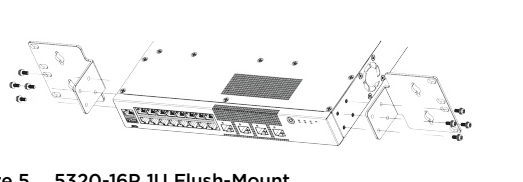

Figure 5 5320-16P 1U Flush-Mount

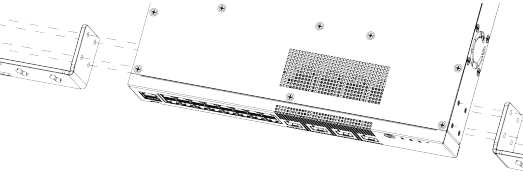
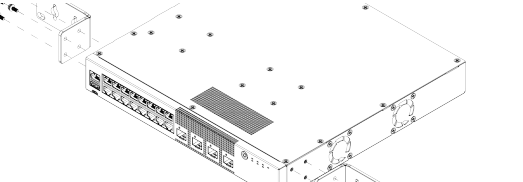

Figure 6 5320-16P 1U Mid-Mount



- Secure the brackets to the rack posts.

Note: Do not overlap rack mounting ears when using the longer mounting ears. Leaving a space between units ensures adequate airflow.

Under Table Mount and Wall Mount

Note: Limited orientation for wall mounting, power inlet upward. Install the short brackets onto a wall or under a table.

- Use the short brackets as a template and mark the holes to be used. Use two holes per short rack ear.
- Drill the holes and attach the brackets using four wood screws and four anchors, provided in the accessory kit.

Figure 7 5320-16P Table Mount

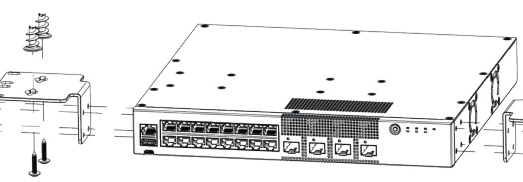
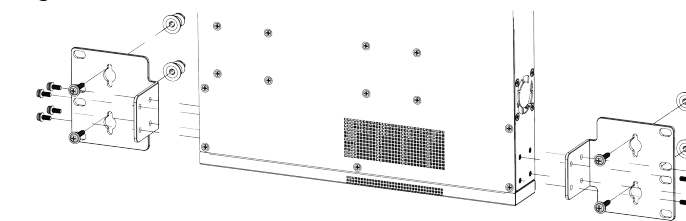
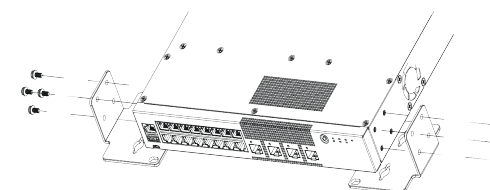

Figure 8 5320-16P Wall Mount



- Attach the short brackets to both sides of the switch. There is a "cleaner" method of attaching the mounting ears to the switch so that they are tucked under the switch instead of pointing away from the switch. Attach a mounting bracket to each side of the switch, screwing it into the holes so that the flange (ear) faces the bottom of the switch, using the four screws provided.

Figure 9 5320-16P Alternate Mount Ear Attachment



4 Install Transceivers

(Optional) Transceivers send and receive data over optical fiber rather than through electrical wires. You can insert transceivers or DAC cables into any of the switch's data ports.

Note: Transceivers can be Class 1 or Class 1M laser devices.

To install a transceiver:

- Attach the ESD wrist strap to your wrist and connect the metal end to an appropriate ground point on the rack.
- Remove the transceiver from its packaging.
- If applicable, remove the protective dust cover from the connector.
- Hold the transceiver so that the connector will seat properly.
- Carefully align the transceiver with the port slot.
- Push the transceiver into the port slot until it clicks into place.

5 Connect Power

Most 5320 Series switches run on AC power. Model 5320-16P-4XE-DC runs on DC power.

Note: Installing the system as described in this guide meets the protective earth grounding requirements of the National Electrical Code (NEC), UL/CSA/IEC/EN 60950-1 standards. However, in some cases, it may be necessary to use an alternative grounding method. In these cases, a 14 AWG wire can be connected between the grounding lug on the chassis and a nearby building ground point.

Connecting to the Primary Power Source

To attach your 5320 Series to an AC power source, do the following:

- Connect the AC power cord to the AC power input socket on the power supply and an AC power outlet.
- When power is connected, verify that the switch's power LEDs turn green. If the LEDs do not turn green, refer to *5320 Series Hardware Installation Guide* for troubleshooting information.

Note: Power over Ethernet (PoE) is also supported on specific models.

To attach the 5320-16P-4XE-DC switch to a DC power source, see the *5320 Series Hardware Installation Guide*.

6 Update and Configure the Switch

Upgrade to a generally available (GA) version of the software before you use this unit. Switch Engine is the default operating system (OS) for the 5320 Series. You can change the switch OS from the Bootloader Menu on initial activation only. See the *5320 Series Hardware Installation Guide* for all OS selection and upgrade procedures.

To change the switch OS via the Bootloader Menu:

- Connect the switch to a console with a baudrate of 115200.
- Once the switch is powered or reset, press the **spacebar** key within 30 seconds after seeing the "5320 Boot Menu" screen to activate the Bootloader Menu.
- Use the **down-arrow** key to select **Change the switch OS to Fabric Engine**, then select **Enter**.
- The switch will install Fabric Engine, then reset.

Safety Notices



Caution! Shock hazard! Disconnect all power inputs before servicing.



Electrical Hazard: Only qualified instructed or skilled personnel should perform installation, repair, or disassembly procedures.

Risques d'électrocution: Seul un personnel qualifié ou expérimenté peut effectuer les procédures d'installation, de réparation ou de démontage.

Warning: Extreme Networks power supplies do not have switches for turning the unit on and off. Before servicing, disconnect all power cords to remove power from the device. Make sure that these connections are easily accessible.

Avertissement: Extreme Networks alimentations n'ont pas d'interrupteurs pour allumer ou éteindre l'appareil. Avant l'entretien, débranchez tous les cordons d'alimentation pour couper l'alimentation de l'appareil. Assurez-vous que ces connexions sont facilement accessibles.

Warning: A dedicated Listed circuit breaker rated at 15A is to be used for each power supply connection.

Avertissement: Un disjoncteur certifié 15A et dédié à l'installation doit être utilisé pour chaque connexion d'alimentation.

Caution: Before mounting the device, ensure that the rack can support it without compromising stability. Otherwise, personal injury or equipment damage may result.

Caution: Follow appropriate ESD procedures when unpacking and handling the switch. These include unpacking the switch in an ESD-safe environment and wearing appropriate ESD protective gear, such as ESD-safe footwear and ESD wrist straps where appropriate.

Warning: This unit must be installed indoors. The unit, AC power adapter, and its cables are not designed for outdoor use. **The PoE cables must not be distributed outside the building.**

Caution: Use of controls or adjustments or performance of procedures other than those specified herein may result in hazardous radiation exposure.

Warning: Do not use optical instruments to view the laser output. The use of optical instruments to view laser output increases eye hazard. Use only UL/CSA, IEC/EN60825-1/-2 recognized pluggable modules.

Avertissement: Ne pas utiliser d'instruments optiques pour regarder l'extrémité du laser. L'utilisation d'instruments optiques pour regarder l'extrémité du laser représente un danger pour les yeux. Utilisez uniquement des modules certifiés UL/CSA, IEC/EN60825-1/-2.

Hardware Components

Figure 10 5320 Series: Sample Front Panels

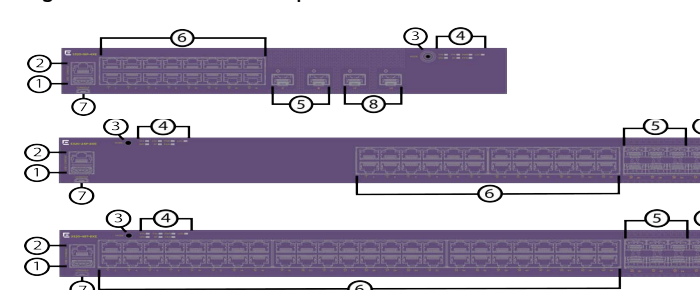

- RJ-45 Serial console port
- Type A USB port
- Micro-B USB console port
- 10/100/1000BASE-T full/half duplex ports
- 1/10Gb SFP uplink ports (MACsec capable)
- 10G SFP+ Universal Ports/stacking ports

Note: 5320 Series switches have either PoE or non-PoE ports, not a mix of both. For component details, see the *5320 Series Hardware Installation Guide*.

Figure 11 5320 Series: Sample Rear Panels

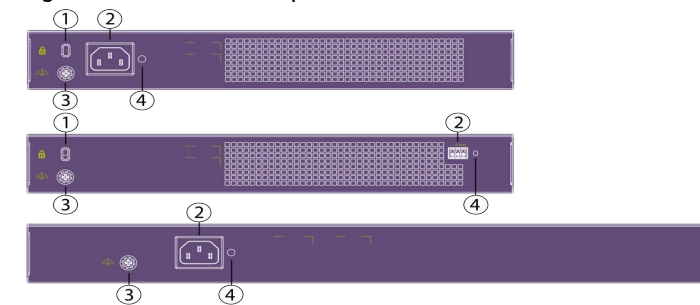

- Kensington lock
- AC/DC power inlet connector
- Grounding lug
- Cable tie mount for power cord management

Operating Conditions

Operating Temperature: 0°C (32°F) to 50°C (122°F) up to 3000 m (9842 ft)
5320-16P-4XE, AC/DC, no fans:
0°C (32°F) to 35°C (95°F) up to 3000 m (9842 ft)
Temperature restrictions apply for some models at high altitudes. See the *5320 Series Hardware Installation Guide* for details.

Storage Temperature: -40°C to 70°C (-40°F to 158°F)

Operating Relative Humidity: 5% to 95% (non-condensing)

Interfaces

Each 5320 Series includes a Micro-B USB and RJ-45 serial console ports, a USB Type A port, one fixed power supply unit and fixed fan modules with side-to-side (left to right) cooling. 5320 factory switches are pre-loaded with both Switch Engine and Fabric Engine operating systems. The following table lists the specific interfaces for each switch:

5320-48T-8XE	48 10/100/1000BASE-T full/half duplex MACsec capable ports, 8 10G unpopulated SFP+ ports, and one AC PSU
5320-48P-8XE	48 10/100/1000BASE-T full/half duplex MACsec capable ports with 802.3at Type 2 PoE+ (30W), 8 10G unpopulated SFP+ ports, and one AC PSU
5320-24T-8XE	24 10/100/1000BASE-T full/half duplex MACsec capable ports, 8 10G unpopulated SFP+ ports, and one AC PSU
5320-24P-8XE	24 10/100/1000BASE-T full/half duplex MACsec capable ports with 802.3at Type 2 PoE+ (30W), 8 10G unpopulated SFP+ ports, and one AC PSU
5320-16P-4XE	16 10/100/1000BASE-T full/half duplex MACsec capable ports with 802.3at Type 2 PoE+ (30W), 4 10G unpopulated SFP+ ports, and one AC PSU
5320-16P-4XE-DC	16 10/100/1000BASE-T full/half duplex MACsec capable ports with 802.3at Type 2 PoE+ (30W), 4 10G unpopulated SFP+ ports, and one DC PSU

Available Rack-Mount Kits

Two-post rack-mount kit (XN-2P-RMKIT-006)	Two-post fixed rack-mount kit for models 5320-48T-8XE, 5320-48P-8XE, 5320-24T-8XE, and 5320-24P-8XE
Two-post rack-mount kit (XN-2P-RMKIT-007)	Two-post fixed rack-mount kit for models 5320-16P-4XE and 5320-16P-4XE-DC
1U Two-post rack mount kit (XN-2P-RMKIT-011)	1U Two-post rack mount kit for models 5320-16P-4XE and 5320-16P-4XE-DC.

PoE Budgets

SKU	PoE Budgets
5320-48P-8XE	740 W
5320-24P-8XE	370 W
5320-16P-4XE	185 W
5320-16P-4XE-DC	185 W

Getting Help

For additional support related to 5320 Series switches or this document, contact Extreme Networks using one of the following methods:

Product Documentation	https://www.extremenetworks.com/support/documentation/
Global Technical Assistance Center (GTAC)	Phone: 1-800-998-2408 (toll-free in U.S. and Canada) or +1-408-579-2826. For the support phone number in your country, visit: http://www.extremenetworks.com/support/contact/
GTAC Knowledge	Get on-demand and tested resolutions from the GTAC Knowledgebase, or create a help case if you need more guidance. Visit: https://gtacknowledge.extremenetworks.com/
The Hub	A forum for Extreme customers to connect with one another, get questions answered, share ideas and feedback, and get problems solved. The community is monitored by Extreme Networks employees, but is not intended to replace specific guidance from GTAC. Visit: https://community.extremenetworks.com
Support Portal	Manage cases, downloads, service contracts, product licensing, and training and certifications. Visit: http://support.extremenetworks.com/

Notice

Copyright © 2024 Extreme Networks, Inc. All Rights Reserved.

Legal Notices

Extreme Networks, Inc. reserves the right to make changes in specifications and other information contained in this document and its website without prior notice. The reader should in all cases consult representatives of Extreme Networks to determine whether any such changes have been made.

The hardware, firmware, software or any specifications described or referred to in this document are subject to change without notice.

Trademarks

Extreme Networks and the Extreme Networks logo are trademarks or registered trademarks of Extreme Networks, Inc. in the United States and/or other countries.

All other names (including any product names) mentioned in this document are the property of their respective owners and may be trademarks or registered trademarks of their respective companies/owners. For additional information on Extreme Networks trademarks, please see: www.extremenetworks.com/company/legal/trademarks/

Warranty

Warranty information for 5320 Series is located online at: www.extremenetworks.com/support/policies/

Regulatory and Compliance Information

Federal Communications Commission (FCC) Notice

This device complies with Part 15 of the FCC rules. Operation is subject to the following two conditions: (1) this device may not cause harmful interference, and (2) this device must accept any interference received, including interference that may cause undesired operation.

NOTE: This equipment has been tested and found to comply with the limits for a class A digital device, pursuant to Part 15 of the FCC rules. These limits are designed to provide reasonable protection against harmful interference when the equipment is operated in a commercial environment. This equipment uses, generates, and can radiate radio frequency energy and if not installed in accordance with the operator's manual, may cause harmful interference to radio communications. Operation of this equipment in a residential area is likely to cause interference in which case the user will be required to correct the interference at his own expense.

WARNING: Changes or modifications made to this device which are not expressly approved by the party responsible for compliance could void the user's authority to operate the equipment.

Industry Canada Notice CAN ICES-003(A)/NMB-003(A)

This digital apparatus does not exceed the class A limits for radio noise emissions from digital apparatus set out in the Radio Interference Regulations of the Canadian Department of Communications.

Le présent appareil numérique n'émet pas de bruits radioélectriques dépassant les limites applicables aux appareils numériques de la class A prescrites dans le Règlement sur le brouillage radioélectrique dicté par le Ministère des Communications du Canada.

Class A ITE Notice

WARNING: This equipment is compliant with Class A of CISPR 32. In a residential environment this equipment may cause radio interference.

Product Safety

This product complies with the following international safety standards:

- UL 62368-1
- UL 60950-1
- CAN/CSA C22.2 No. 62368-1
- CAN/CSA C22.2 No. 60950-1-07
- IEC/EN 62368-1
- IEC/EN 60950-1
- 2014/35/EU
- CNS 15598-1
- GB 4943.1

Optical Module Compliance

Extreme Networks pluggable optical modules and direct-attach cables meet the following regulatory requirements:

- UL and/or CSA registered component for North America
- Class 1 or Class 1M Laser Product
- FCC 21 CFR Chapter 1, Sub-chapter J in accordance with FDA & CDRH requirements
- IEC/EN 60825-1, IEC/EN 60825-2 or later, European Standard

Korea EMC Statement

이 기기는 업무용 환경에서 사용할 목적으로 적합성평가를 받은 기기로서 가정용 환경에서 사용하는 경우 전파간섭의 우려가 있습니다.

Australia (RCM)

WARNING: This equipment is compliant with Class A of CISPR 32. In a residential environment this equipment may cause radio interference.

Electromagnetic Compatibility (EMC)

This product complies with the following: FCC 47 CFR Part 15 Subpart B Class A (US), ICES-003 (Canada), EN 55032 (ITE Emissions), EN 55035 (ITE Immunity), EN 61000-3-2 (Harmonics), EN 61000-3-3 (Flicker), 2014/30/EU (EMC Directive), EN 300 386 (Telecom), EN 55011 (ISM), EN 61000-6-2 (Ind. Immunity), EN 61000-6-4 (Ind. Emissions), RCM (Australia), VCCI (Japan), MSIP KCC (Korea), BSMI (Taiwan), ANATEL (Brazil), TEC (India), CQC (China).

VCCI Notice

This is a Class A product based on the standard of the Voluntary Control Council for Interference by Information Technology Equipment (VCCI). If this equipment is used in a domestic environment, radio disturbance may arise. When such trouble occurs, the user may be required to take corrective actions.

この装置は、クラスA機器です。この装置を住宅環境で使用すると電波妨害を引き起こすことがあります。この場合には使用者が適切な対策を講ずるよう要求されることがあります。 VCCI-A

BSMI EMC Statement — Taiwan

This is a Class A product. In a domestic environment this product may cause radio interference in which case the user may be required to take adequate measures.

Taiwan BSMI 報關義務人

申請人：愛爾蘭商極進網絡技術行動有限公司台灣分公司
地址：臺北市松山區南京東路4段126號5樓

警告:為避免電磁干擾,本產品不應安裝或用於住宅環境。

警告:在居住環境中，運行此設備可能會造成無線電干擾。

Battery Warning — Taiwan

警告

如果更換不正確之電池型式會有爆炸的風險，

請依製造商說明書處理用過之電池。



Battery Notice

Warning: This product contains a battery used to maintain product information. If the battery should need replacement it must be replaced by Service Personnel. Please contact Technical Support for assistance.

Risk of explosion if battery is replaced by an incorrect type. Dispose of expended battery in accordance with local disposal regulations.

Avvertimento: Ce produit renferme une pile servant à conserver les renseignements sur le produit. Le cas échéant, faites remplacer la pile par le personnel du service de réparation. Veuillez communiquer avec l'assistance technique pour du soutien.

Il y a risque d'explosion si la pile est remplacée par un type de pile incorrect. Éliminez les piles usées en conformité aux règlements locaux d'élimination des piles.

Hazardous Substances- China and Taiwan BSMI RoHS

Guidance concerning the China and Taiwan BSMI RoHS (Restriction of Hazardous Substances) directive for this Extreme Networks® product can be found on the following web page:

www.extremenetworks.com/support/restriction-hazardous-substances/

The page contains tables detailing the presence of 10 substances defined by the RoHS directive.

Hazardous Substances - EU

This product complies with the requirements of Directive 2011/65/EU of the European Parliament and of the Council of 8 June 2011 on the restriction of the use of certain hazardous substances in electrical and electronic equipment.

European Waste Electrical and Electronic Equipment (WEEE) Notice



In accordance with Directive 2012/19/EU of the European Parliament on waste electrical and electronic equipment (WEEE):

- The symbol above indicates that separate collection of electrical and electronic equipment is required.
- When this product has reached the end of its serviceable life, it cannot be disposed of as unsorted municipal waste. It must be collected and treated separately.
- It has been determined by the European Parliament that there are potential negative effects on the environment and human health as a result of the presence of hazardous substances in electrical and electronic equipment.
- It is the users' responsibility to utilize the available collection system to ensure WEEE is properly treated.

For information about the available collection system, please contact Extreme Customer Support at +353 61 705500 (Ireland).

Extreme Networks

5320 Series

Quick Reference

5320-48T-8XE

5320-48P-8XE

5320-24T-8XE

5320-24P-8XE

5320-16P-4XE

5320-16P-4XE-DC

ExtremeCloud IQ

Scan to learn more about **ExtremeCloud IQ™** and **ExtremeCloud IQ™ - Site Engine**.

Your new switch can be managed by ExtremeCloud IQ if cloud management is preferred as well as ExtremeCloud IQ - Site Engine if locally deployed management is preferred.



Read Me First - Switch OS Selection

Scan for instructions to choose your preferred switch OS on the Universal Switch.



P/N 9037029-00 Rev. AE

