

Installation Guide

Omada Smart Switch

*Images may differ from your actual product.

LED Explanation

LED	Explanation
Power/PWR	On/Off: Power on/off
System/SYS	Blinking: System running normally On/Off: System running abnormally
Link/Act (For SG2210XMP-M2 only)	On (Green): Running at 2.5 Gbps On (Yellow): Running at 1000 Mbps/100 Mbps Blinking: Transmitting/receiving data Off: No connected device
Link/Act (For other models)	On (Green): Running at 1000 Mbps On (Yellow): Running at 10 Mbps/100 Mbps Blinking: Transmitting/receiving data Off: No connected device
SPF+ (For Port 9-10 of SG2210XMP-M2 only)	Green/Yellow On: Running at 10 Gbps/1 Gbps Blinking: Transmitting/receiving data Off: No connected device
SPF1/SFP2 (For SG2210P only)	Green/Yellow On: Running at 1000/100 Mbps Blinking: Transmitting/receiving data Off: No connected device
PoE Status (For Port 1-4 of SG2008P/ Port 1-8 of SG2210P/ Port 1-8 of SG2210XMP-M2/ Port 1-8 of SG2016P)	On: Providing PoE power Blinking: Current-overload/Short-circuit/Connected to a non-standard PD/Power exceeded the user-defined value Off: Not providing PoE Power
PoE Max	On: Remaining power supply \leq 7W Blinking: Remaining power supply keeps \leq 7 W for more than 2 minutes Off: Remaining power supply $>$ 7W

Desktop Installation

For simplicity, we will take SG2008 for example.

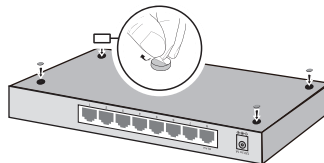

1. Remove the adhesive backing papers from the rubber feet.
2. Attach the rubber feet to the bottom of the switch to prevent it from slipping when placed on a desktop.

Note:
This device also supports wall-mounting installation. For detailed information, please refer to the Wall Mounting Guide on the device's support page.

Connection for PoE Switch

For simplicity, we will take SG2210XMP-M2 for example.

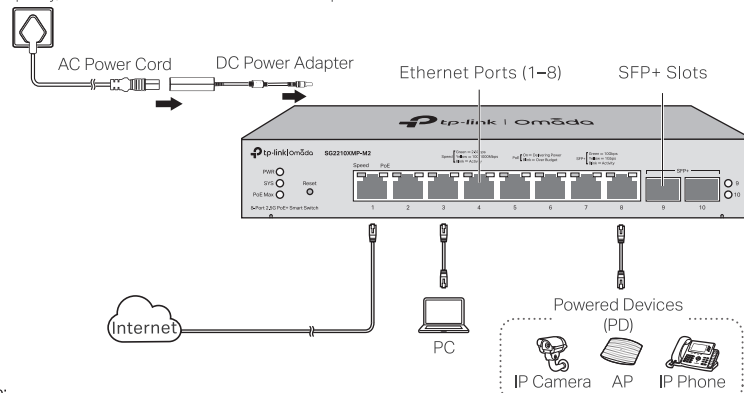

Note:

1. The PoE ports can also connect to non-PoE devices, but only transmit data.
2. The PoE ports shall not be used to charge lithium batteries or devices supplied by lithium batteries.
3. Maximum PoE power is 30 W for each PoE port, and total PoE budget is 62 W (for SG2008P)/61 W (for SG2210P)/160 W (for SG2210XMP-M2)/120 W (for SG2016P) respectively.
4. PoE budget calculations are based on laboratory testing. Actual PoE power budget is not guaranteed and will vary as a result of client limitations and environmental factors.

Connection for Non-PoE Switch

For simplicity, we will take SG2008 for example.

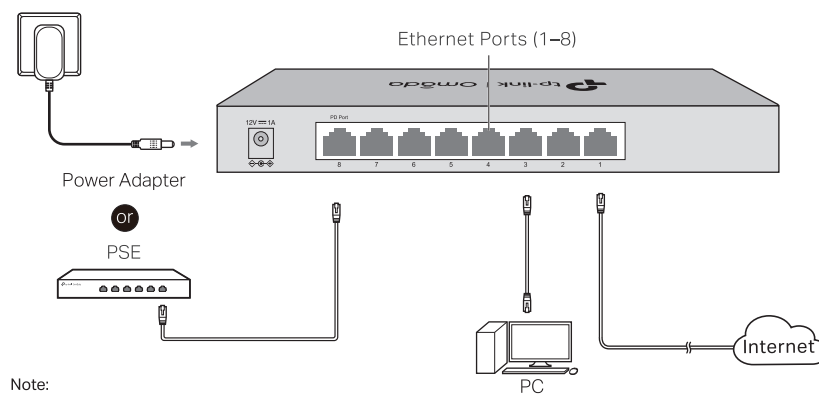

Note:

1. Port 8 is a PD (Powered Device) port. When powered through port 8, the switch can only be powered by power supplies that comply with the 802.3af/at standard and Power Source Class 2 (PS2) or Limited Power Source (LPS) defined in the standard of IEC 62368-1.
2. The DC power input takes precedence over the PD port. If the DC input fails, the PoE input on the PD port will supply power instead.

Configuration

The switch supports two configuration methods:

- Standalone Mode: Configure and manage the switch singly.
- Controller Mode: Configure and manage the network devices centrally. It is recommended in the large-scale network, which consists of mass devices such as access points, switches, and gateways.

Note: When the switch is changed from Standalone Mode to Controller Mode, configurations of the switch will be lost. For details, refer to the related documents on the download center of our official website: <https://www.tp-link.com/support/download/?type=smb>

Method 1: Standalone Mode

In Standalone Mode, use a computer to configure and manage the switch.

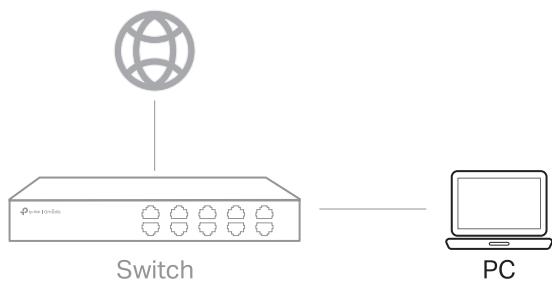

1. To access the management page of the switch, open a browser and type the switch's IP address in the address field, then press the **Enter** key.
 - If the switch obtains IP address from the DHCP server (typically a router), find the switch's IP address on the DHCP server.
 - If not, use the default IP address 192.168.0.1 to launch the switch's management page.

Note: Make sure the switch and computer are in the same subnet.

2. Enter **admin** for both the username and password in the lower case letters to log in. The first time you log in, change the password to better protect your network and devices.
3. After a successful login, the main page will appear. You can click the menus on the top side and left side to configure the corresponding functions.

For the detailed configurations, refer to the User Guide and CLI Guide. The guides can be found on the download center of our official website:

<https://www.tp-link.com/support/download/?type=smb>

Method 2: Controller Mode

Choose from the following two types of Omada Controller:

• Type 1: Omada Hardware Controller (OC200/OC300)

Omada Hardware Controller (OC200/OC300) is a good alternative if you have no spare PC to keep running Omada Software Controller in the network. It needs to be purchased additionally. For more details, refer to the Installation Guide of OC200/OC300.

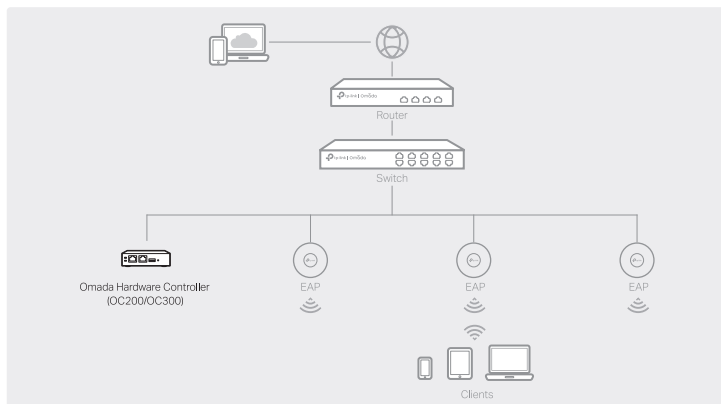

Note:

- Before you start, be sure to power up and connect your devices according to the topology figure.
- A DHCP server (typically a router with DHCP function enabled) is required to assign IP addresses to the EAPs and clients in your local network.
- Omada Controller must have network access to your Omada devices (the router, switch, and EAPs) in order to find, adopt, and manage them.

• Type 2: Omada Software Controller

On a PC with Windows OS or Linux OS, download the Omada Software Controller from <https://www.tp-link.com/support/download/omada-software-controller/>. Then run the file and follow the wizard to install and launch the Omada Software Controller. To manage your devices, Omada Software Controller needs to keep running on your computer.

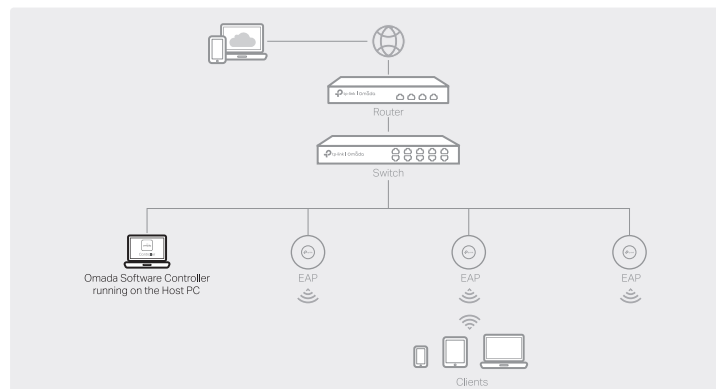

Choose from the following two types of Management Interface:

• Type 1: Via Web Browser

1. Open the Omada Controller's web page.

- * For Omada Software Controller
Launch the Omada Software Controller on your PC. After the initiation process, the controller automatically opens its web page. If not, click **Launch a Browser to Manage the Network**.
- * For Omada Hardware Controller
As Omada Hardware Controller gets its IP address from the DHCP server of the router, we don't know its IP address explicitly. However, we can find it out on the router's DHCP client list.

- a. You need first find the IP address of the router. Open the command line on your PC and enter `ipconfig`. In the result list, find the **Default Gateway**, which is also the IP address of the router.
 - b. Launch a web browser and enter the IP address of the router. Log into the router's web page, and both the username and password are **admin** by default. Then go to **Network > LAN > DHCP Client List** to find the IP address of your controller according to its MAC address.
 - c. Enter the IP address of your controller in address bar to open its web page.
2. On the Omada Controller's page, follow the wizard to complete the quick setup.
 3. After quick setup, login page appears. Enter the username and password you have created and click **Log in**. Then you can further configure the controller.
 4. (For Remote Management) You can remotely access and manage your controller via Omada Cloud Service.

Note: Before you start, make sure that both your controller and your PC can access the internet.

* For Omada Software Controller, refer to its User Guide

* For Omada Hardware Controller

- a. Make sure **Cloud Access** is enabled on your controller. By default, **Cloud Access** is enabled. Make sure that the Cloud LED is flashing slowly.
- b. Launch a web browser and enter <https://omada.tp-linkcloud.com> in the address bar. Enter your TP-Link ID and password to log in. Click **+ Add Controller** and choose **Hardware Controller** to add your controller.

• Type 2: Via Omada App

1. Download the TP-Link Omada App on your mobile device. It can be downloaded from App Store or Google Play:



2. Launch your Omada App and configure the controller at a local site or remote site.

• Local Management

- a. Connect your mobile device to the EAP by using the default SSID (format: `TP-Link_2.4GHz/5GHz_XXXXXX`) printed on the label at the bottom of the product.
- b. Launch Omada App and go to **Local Access**, tap the **+** button on the upper-right corner to add the controller. Then you can further configure the controller.

• Remote Management

Note: Before you start, make sure that both your controller and mobile device can access the internet.

* For Omada Software Controller

- a. Make sure that **Cloud Access** is enabled on your controller and your controller has been bound with your TP-Link ID.
- b. Launch Omada App and log in with your TP-Link ID. Then go to **Cloud Access**. A list of controllers that have been bound with your TP-Link ID will appear. Then you can further configure the controller.

* For Omada Hardware Controller

- a. Make sure that **Cloud Access** is enabled on your controller. By default, **Cloud Access** is enabled. Make sure that the Cloud LED is flashing slowly.
- b. Launch Omada App and log in with your TP-Link ID. Then go to **Cloud Access**. Tap the **+** button on the upper-right to add your controller. Then you can further configure the controller.

EU declaration of conformity

TP-Link hereby declares that the device is in compliance with the essential requirements and other relevant provisions of directives 2014/30/EU, 2014/35/EU, 2011/65/EU and (EU)2015/863.

The original EU declaration of conformity may be found at <https://www.tp-link.com/en/support/ce/>

UK declaration of conformity

TP-Link hereby declares that the device is in compliance with the essential requirements and other relevant provisions of the Electromagnetic Compatibility Regulations 2016 and Electrical Equipment (Safety) Regulations 2016.

The original UK declaration of conformity may be found at <https://www.tp-link.com/support/ukca/>

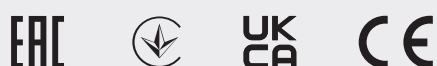

Safety Information

- Keep the device away from water, fire, humidity or hot environments.
- Do not attempt to disassemble, repair, or modify the device. If you need service, please contact us.
- Do not use damaged charger or USB cable to charge the device.
- Do not use any other chargers than those recommended.
- Adapter shall be installed near the equipment and shall be easily accessible.
- Plug the product into the wall outlets with earthing connection through the power supply cord.
- The plug on the power supply cord is used as the disconnect device, the socket-outlet shall be easily accessible. (Not for SG2008)
- The working temperature for the device shall be within 0-40 °C.

To ask questions, find answers, and communicate with TP-Link users or engineers, please visit <https://community.tp-link.com/business> to join TP-Link Community.

For technical support and other information, please visit <https://www.tp-link.com/support/?type=smb>, or simply scan the QR code.

