



Cisco IP DECT 6800 Series User Guide

First Published: 2019-02-18

Last Modified: 2023-07-18

Americas Headquarters

Cisco Systems, Inc.
170 West Tasman Drive
San Jose, CA 95134-1706
USA
<http://www.cisco.com>
Tel: 408 526-4000
800 553-NETS (6387)
Fax: 408 527-0883

THE SPECIFICATIONS AND INFORMATION REGARDING THE PRODUCTS IN THIS MANUAL ARE SUBJECT TO CHANGE WITHOUT NOTICE. ALL STATEMENTS, INFORMATION, AND RECOMMENDATIONS IN THIS MANUAL ARE BELIEVED TO BE ACCURATE BUT ARE PRESENTED WITHOUT WARRANTY OF ANY KIND, EXPRESS OR IMPLIED. USERS MUST TAKE FULL RESPONSIBILITY FOR THEIR APPLICATION OF ANY PRODUCTS.

THE SOFTWARE LICENSE AND LIMITED WARRANTY FOR THE ACCOMPANYING PRODUCT ARE SET FORTH IN THE INFORMATION PACKET THAT SHIPPED WITH THE PRODUCT AND ARE INCORPORATED HEREIN BY THIS REFERENCE. IF YOU ARE UNABLE TO LOCATE THE SOFTWARE LICENSE OR LIMITED WARRANTY, CONTACT YOUR CISCO REPRESENTATIVE FOR A COPY.

The following information is for FCC compliance of Class A devices: This equipment has been tested and found to comply with the limits for a Class A digital device, pursuant to part 15 of the FCC rules. These limits are designed to provide reasonable protection against harmful interference when the equipment is operated in a commercial environment. This equipment generates, uses, and can radiate radio-frequency energy and, if not installed and used in accordance with the instruction manual, may cause harmful interference to radio communications. Operation of this equipment in a residential area is likely to cause harmful interference, in which case users will be required to correct the interference at their own expense.

The following information is for FCC compliance of Class B devices: This equipment has been tested and found to comply with the limits for a Class B digital device, pursuant to part 15 of the FCC rules. These limits are designed to provide reasonable protection against harmful interference in a residential installation. This equipment generates, uses and can radiate radio frequency energy and, if not installed and used in accordance with the instructions, may cause harmful interference to radio communications. However, there is no guarantee that interference will not occur in a particular installation. If the equipment causes interference to radio or television reception, which can be determined by turning the equipment off and on, users are encouraged to try to correct the interference by using one or more of the following measures:

- Reorient or relocate the receiving antenna.
- Increase the separation between the equipment and receiver.
- Connect the equipment into an outlet on a circuit different from that to which the receiver is connected.
- Consult the dealer or an experienced radio/TV technician for help.

Modifications to this product not authorized by Cisco could void the FCC approval and negate your authority to operate the product.

The Cisco implementation of TCP header compression is an adaptation of a program developed by the University of California, Berkeley (UCB) as part of UCB's public domain version of the UNIX operating system. All rights reserved. Copyright © 1981, Regents of the University of California.

NOTWITHSTANDING ANY OTHER WARRANTY HEREIN, ALL DOCUMENT FILES AND SOFTWARE OF THESE SUPPLIERS ARE PROVIDED "AS IS" WITH ALL FAULTS. CISCO AND THE ABOVE-NAMED SUPPLIERS DISCLAIM ALL WARRANTIES, EXPRESSED OR IMPLIED, INCLUDING, WITHOUT LIMITATION, THOSE OF MERCHANTABILITY, FITNESS FOR A PARTICULAR PURPOSE AND NONINFRINGEMENT OR ARISING FROM A COURSE OF DEALING, USAGE, OR TRADE PRACTICE.

IN NO EVENT SHALL CISCO OR ITS SUPPLIERS BE LIABLE FOR ANY INDIRECT, SPECIAL, CONSEQUENTIAL, OR INCIDENTAL DAMAGES, INCLUDING, WITHOUT LIMITATION, LOST PROFITS OR LOSS OR DAMAGE TO DATA ARISING OUT OF THE USE OR INABILITY TO USE THIS MANUAL, EVEN IF CISCO OR ITS SUPPLIERS HAVE BEEN ADVISED OF THE POSSIBILITY OF SUCH DAMAGES.

Any Internet Protocol (IP) addresses and phone numbers used in this document are not intended to be actual addresses and phone numbers. Any examples, command display output, network topology diagrams, and other figures included in the document are shown for illustrative purposes only. Any use of actual IP addresses or phone numbers in illustrative content is unintentional and coincidental.

All printed copies and duplicate soft copies of this document are considered uncontrolled. See the current online version for the latest version.

Cisco has more than 200 offices worldwide. Addresses and phone numbers are listed on the Cisco website at www.cisco.com/go/offices.

The documentation set for this product strives to use bias-free language. For purposes of this documentation set, bias-free is defined as language that does not imply discrimination based on age, disability, gender, racial identity, ethnic identity, sexual orientation, socioeconomic status, and intersectionality. Exceptions may be present in the documentation due to language that is hardcoded in the user interfaces of the product software, language used based on standards documentation, or language that is used by a referenced third-party product.

Cisco and the Cisco logo are trademarks or registered trademarks of Cisco and/or its affiliates in the U.S. and other countries. To view a list of Cisco trademarks, go to this URL: <https://www.cisco.com/c/en/us/about/legal/trademarks.html>. Third-party trademarks mentioned are the property of their respective owners. The use of the word partner does not imply a partnership relationship between Cisco and any other company. (1721R)

© 2019–2022 Cisco Systems, Inc. All rights reserved.



CONTENTS

CHAPTER 1

Your Handset 1

Your Handset	1
Feature Support	3
New and Changed Information	3
New and Changed Information for Firmware Release 5.1(2)	3
New and Changed Information for Firmware Release 5.1(1)	4
New and Changed Information for Firmware Release 5.0	4
New and Changed Information for Firmware Release 4.8	5
New and Changed Information for Firmware Release 4.7	6
New and Changed Information for Firmware Release V460	6
Getting Started	7
Turn on your handset	7
Turn off your handset	7
Report an Emergency Situation	8
Lock the handset keypad	8
Unlock the handset keypad	8
Buttons and Hardware	9
Navigation	12
Supported Characters	12
Handset Screen Features	13
Header Icons	14
Differences Between Phone Calls and Lines	16
Phone Batteries	16
16	
Clean the handset screen	17
Clean the handset exterior	17

If you drop your handset in water 18

Additional Help and Information 18

Document Accessibility for Visually-Impaired and Blind Users 19

Cisco IP DECT 6800 Series Documentation 19

Lost Phone Connectivity 19

Cisco One-Year Limited Hardware Warranty Terms 19

CHAPTER 2

Handset Setup 21

Handset Hardware Installation 21

Handset Package Contents 21

Install the Battery in the Handset 22

Remove the Handset Clip 25

Handset Battery Charging 27

Set Up the Charging Cradle 27

Charge the Handset Battery 27

Automatic Handset Configuration 28

Set Up Your Handset Automatically 28

Set Up a Handset Automatically with the Username and Password 29

Set Up a Handset Automatically with a Short Activation Code 29

Add the Handset Automatically in HEBU Mode 30

Manual Handset Configuration 31

Reset the Language and Text to Default in the Handset 31

Handset Firmware Upgrades or Downgrades 31

CHAPTER 3

Calls 33

Make Calls 33

Make a Call 33

Make a New Call with Intercom 34

Make a Call on a Different Line 34

Make a Call with the Speakerphone 34

Make a Call with a Headset 35

Speed Dial Calls 35

Assign a Speed-Dial Number 35

Delete a Speed-Dial Number 37

Make a Speed Dial Call	37
Answer a Call	38
Answer an Alarm (Emergency) Call	38
Answer Call Waiting	39
Silence an Incoming Call	39
Answer a Call within Your Group	40
End a Call	40
Hold and Resume a Call	40
Swap Between Active and Held Calls	40
Hold and Make a New Call with Intercom	41
Mute Your Call	41
Create a Conference Call	41
Create a Conference Call with Intercom	42
Call Transfer	42
Transfer a Call Directly (Direct Transfer)	42
Consult and Transfer a Call (Consult Transfer)	43
Transfer a Call with Intercom	43
BroadWorks Shared Call Appearance	44
Make a Call on a Shared Line	44
Join a Shared Call	45
Hold and Retrieve a Shared Call	45
Star codes	45
Return a call with a star code	45
Transfer a call with a star code	46
Activate and deactivate call forward all with star codes	46
Activate and deactivate call waiting with star codes	46
Block and unblock outgoing caller information with a star code	47
Block and unblock anonymous calls with a star code	47
Turn do not disturb on and off with a star code	47
Use Push to Talk	48
Paging	48
Send a Page	49

- Text Messages 51
 - Send a Text Message 51
 - Reply to a Text Message Immediately 52
 - Add a Text Message Sender to Your Local Contacts 53
 - Append a Text Message Sender to a Local Contact 53
 - Forward a Text Message 54
 - Delete a Text Message Immediately 54
 - Delete all Text Messages 55
 - View Your Text Message History 55
 - Reply to a Text Message from Your Text History 56
 - Delete a Text Message from the Text Message History 56
 - Delete all Text Messages from the Text Message History 57
 - Configure Your Text Message Settings 57

CHAPTER 5

Contacts and Directories 59

- Local Contacts 59
 - Add a Local Contact 59
 - Call a Local Contact 60
 - Edit a Local Contact 60
 - Delete a Local Contact 61
 - Delete all Local Contacts 61
- Directories 62
 - Call a Central Directory Contact 62

CHAPTER 6

Recent Calls and Voicemail 63

- Recent Calls List 63
 - View Your Recent Calls 63
 - Call Someone in Your Recent Calls List 64
 - Add a Recent Caller to Your Contact List 64
- Access Your Voicemail 65

CHAPTER 7

Alarm Clock, Emergency Alarm List, and Function Keys 67

- Alarm Clock 67
 - Set an Alarm 67

Set a Recurrent Alarm	68
Set the Snooze Time	68
Respond to an Alarm	69
Emergency Alarm List	69
View the Received Emergency Alarms	70
Function keys	70
Set up an F-key	70
Make a call with an F-key or a speed dial	71
Add an F-key or a speed dial to your speed dial list	71
Delete an F-key or a speed dial	72
Delete all F-keys or speed dials	72
View your speed dial list	72

CHAPTER 8**Settings 75**

Settings Menu	75
Audio Settings Menu	75
Set Silent Mode from the Settings Menu	75
Set the Ring Volume from the Settings Menu	75
Set the Ringtone For Different Call Types	76
Set Ringtone for Loud Environment	77
Set the Alert Volume	77
Set the Handset Vibration Mode	78
Set the Tone When a Key is Pressed	78
Set the Confirmation Sound	78
Set the Coverage Warning	79
Set the Charger Warning	79
Time and Date Menu	80
Set the Time Format	80
Set the Date Format	80
Set the Handset Language	81
Set the Handset LED	81
Set the Timer to Turn Off the Screen	82
Security Menu	83
Set the Handset Lock and PIN	83

- Set the Timer to Automatically Lock the Handset 83
- Change the Settings PIN 84
- Set the Handset Name 84
- Select Your Default Line 85
- Set Auto Answer 85
- Allow the Handset to Ring While Charging 86
- Set Do Not Disturb 86
- Hide Your Caller ID When You Make a Call 87
- Call Forward Menu 87
 - Set Call Forward Unconditional 87
 - Set Call Forward When There is No Answer 88
 - Set Call Forward When the Line is Busy 88
- Set the Idle Screen Saver 88
- Set the Idle Clock 89
- Bluetooth Menu 89
 - Bluetooth and your handset 89
 - Enable Bluetooth 90
 - Search and pair a Bluetooth device 90
 - Manage the paired Bluetooth devices 90
 - Turn on Push To Talk 91
- Set the Ring Volume for an Incoming Call 91
- Change the Volume on a Call 92

CHAPTER 9

Accessories 93

- Supported Headsets 93
- Important Headset Safety Information 93
- Audio Quality 94

CHAPTER 10

Troubleshooting 95

- General Troubleshooting 95
 - Handset Won't Turn On 95
 - Handset Won't Stay On 96
 - Handset Doesn't Ring 96
 - Handset Doesn't Respond to Key Presses 96

Handset Beeps Continuously While in the Charger	97
Handset Screen Displays "Searching"	97
View the Handset Status	98
Reset the Handset Settings	98

CHAPTER 11
Product Safety and Security 99

Safety and Performance Information	99
Safety Guidelines	100
Battery Safety Notices	100
Power Outage	101
Regulatory Domains	101
Health-Care Environments	101
External Devices Usage	101
System Behavior During Times of Network Congestion	102
Product Label	102
Compliance Statements	102
Compliance Statements for the European Union	102
CE Marking	102
RF Exposure Statement for the European Union	102
Compliance Statements for the USA	103
General RF Exposure Compliance	103
Part 15 Radio Device	103
Compliance Statements for Canada	103
Canadian RF Exposure Statement	103
Compliance Statements for New Zealand	104
Permit to Connect (PTC) General Warning	104
Use of IP Networks with the PSTN	104
The Use of Voice Compression Through the PSTN	104
Echo Cancellation	104
Compliance Statements for Taiwan	105
DGT Warning Statement	105
Compliance Statement for Argentina	105
Compliance Statement for Singapore	105
Cisco Product Security Overview	105

[Important Online Information](#) 105



CHAPTER 1

Your Handset

- [Your Handset](#), on page 1
- [Feature Support](#), on page 3
- [New and Changed Information](#), on page 3
- [Getting Started](#), on page 7
- [Buttons and Hardware](#), on page 9
- [, on page 16](#)
- [Additional Help and Information](#), on page 18

Your Handset

The Cisco IP DECT 6800 Series is designed for small and medium businesses, as well as larger organizations. The series is made up of:

- Cisco IP DECT 110 Single-Cell Base Station
- Cisco IP DECT 210 Multi-Cell Base Station
- Cisco IP DECT 110 Repeater
- Cisco IP DECT Phone 6823 Handset
- Cisco IP DECT Phone 6825 Handset
- Cisco IP DECT Phone 6825 Ruggedized Handset

The base stations and repeater look the same from the front, but each has a different function. The Base stations communicate with the call control system, the handsets, and the optional repeaters. Repeaters communicate with the base station and handsets.

You can identify the devices by the symbol on the top of the device.

Device	Symbols
Cisco IP DECT 110 Single-Cell Base Station	

Device	Symbols
Cisco IP DECT 210 Multi-Cell Base Station	
Cisco IP DECT 110 Repeater	



Note This document covers the Cisco IP DECT 6800 Series only. This series is different from the Cisco IP Phone 6800 Series Multiplatform Phones. For information on the Cisco IP Phone 6800 Series Multiplatform Phones, see <https://www.cisco.com/c/en/us/support/collaboration-endpoints/ip-phone-6800-series-multiplatform-firmware/series.html>

Figure 1: Cisco IP DECT Phone 6823 Handset, Cisco IP DECT Phone 6825 Handset, Cisco IP DECT Phone 6825 Ruggedized Handset, Cisco IP DECT 110 Repeater, Cisco IP DECT 210 Multi-Cell Base Station, and Cisco IP DECT 110 Single-Cell Base Station



451053

The handsets communicate with the base station and repeaters using Digital Enhanced Cordless Telecommunications (DECT).

If you need to use a handset in a volatile, dusty, or damp environment, you can use the Cisco IP DECT Phone 6825 Ruggedized Handset. This handset is IP65-rated, which means that the handset is sealed to protect it from dust and water.

The Cisco IP DECT Phone 6823 Handset is similar to the Cisco IP DECT Phone 6825 Handset, except for these differences. The use of keys and display of icons may differ between the two handsets.

Feature	Cisco IP DECT Phone 6825 Handset	Cisco IP DECT Phone 6823 Handset
Screen	Display: 2 inches Resolution: 240 x 320 pixels	Display: 1.7 inches Resolution: 128 x 160 pixels
Emergency button	Present	Not present

Feature	Cisco IP DECT Phone 6825 Handset	Cisco IP DECT Phone 6823 Handset
Bluetooth	Supported	Not supported
Charging cradle	USB port and LED	No USB port or LED

In this document, the term *phone* means the handset and the term *system* means the handset and base station. The following table lists some common terms and their meanings used in this document.

Table 1: Terms

Term	Meaning
<i>Handset or phone</i>	6823 Handset 6825 Handset 6825 Ruggedized Handset
<i>Base station</i>	110 Single-Cell Base Station 210 Multi-Cell Base Station
<i>Repeater</i>	110 Repeater



Note Not all features may be supported by your handset. Contact your service provider for the supported features.

Feature Support

This document describes all the features that the device supports. However, not all features may be supported with your current configuration. For information on supported features, contact your service provider or administrator.

New and Changed Information

New and Changed Information for Firmware Release 5.1(2)

Feature	New or Changed Information
Added new topics for Call transfer, direct transfer, and consult transfer	New section: Call Transfer, on page 42 Transfer a Call Directly (Direct Transfer), on page 42 Consult and Transfer a Call (Consult Transfer), on page 43

New and Changed Information for Firmware Release 5.1(1)

Feature	New or Changed Information
Automatic Handset Registration in HEBU Mode	New section: Add the Handset Automatically in HEBU Mode, on page 30
Call Groups Addition for Intercom Calls	New sections: <ul style="list-style-type: none"> • Make a New Call with Intercom, on page 34 • Hold and Make a New Call with Intercom, on page 41 • Transfer a Call with Intercom, on page 43 • Create a Conference Call with Intercom, on page 42 • Answer a Call within Your Group, on page 40
Dial Plan Enhancement	Updated section: Speed-Dial Numbers, on page 36
Incoming Call Validation Display on the Handset	Updated sections: <ul style="list-style-type: none"> • Answer a Call, on page 38 • View Your Recent Calls, on page 63
Reset Handset Language and Text to Default Settings	New section: Reset the Language and Text to Default in the Handset, on page 31

New and Changed Information for Firmware Release 5.0

Feature	New or Changed Information
Firmware Filename Modification	Updated section: Handset Firmware Upgrades or Downgrades, on page 31
Hungarian Language Addition to Handset	Updated section: Set the Handset Language, on page 81
Loud Ringtone Setting in Handset	New section: Set Ringtone for Loud Environment, on page 77

New and Changed Information for Firmware Release 4.8

Feature	New or Changed Content
110 Single-Cell Base Station and 110 Repeater	Updated sections: <ul style="list-style-type: none"> • Your Handset, on page 1 • Handset Screen Displays "Searching", on page 97
6823 Handset	Updated sections: <ul style="list-style-type: none"> • Your Handset, on page 1 • Report an Emergency Situation, on page 8 • Buttons and Hardware, on page 9 • Header Icons, on page 14 • Set Up the Charging Cradle, on page 27 • Various sections in the chapter Calls, on page 33. • Various sections in the chapter Text Messages, on page 51. • Local Contacts, on page 59 • Add a Recent Caller to Your Contact List, on page 64 • Alarm Clock, on page 67 • Function keys, on page 70 • Various sections in the chapter Settings, on page 75.
Paging	Added new section Paging , on page 48.
Shared Call Enhancements	Updated sections: <ul style="list-style-type: none"> • Answer a Call, on page 38 • BroadWorks Shared Call Appearance, on page 44 New sections: <ul style="list-style-type: none"> • Make a Call on a Shared Line, on page 44 • Join a Shared Call, on page 45 • Hold and Retrieve a Shared Call, on page 45

Feature	New or Changed Content
Swap Call with Navigation Key	Updated the section Swap Between Active and Held Calls , on page 40.
Temporary Handset Addition to Base Station	New sections: <ul style="list-style-type: none"> • Set Up a Handset Automatically with the Username and Password, on page 29 • Set Up a Handset Automatically with a Short Activation Code, on page 29
General Changes	New troubleshooting procedure in Handset Beeps Continuously While in the Charger , on page 97

New and Changed Information for Firmware Release 4.7

Starting with this release:

- The release number scheme changes to conform to the standard Cisco release numbers. Internally, the previous number scheme will display. Firmware Release 4.7 and Firmware Release V470 B6 are the same firmware release.
- All document updates related to the release are clearly marked. For example, if there is a new field added or a field removed, the documentation will indicate the type of change and what release the change applies to.

Feature	New and Changed Information
6825 Ruggedized Handset support	Updated Your Handset , on page 1 Updated Buttons and Hardware , on page 9
User Interface Enhancements	Add information about the out-of-range alert to Your Handset , on page 1. Add information about the Alarm screen display for recurrent alarms to Alarm Clock , on page 67.
Other changes	New troubleshooting procedures Handset Won't Stay On , on page 96 and Handset Won't Turn On , on page 95

New and Changed Information for Firmware Release V460

Feature	New or Updated Sections
Broadsoft All directory	Updated Call a Central Directory Contact , on page 62

Feature	New or Updated Sections
Handset out-of-box enhancements	Updated Automatic Handset Configuration , on page 28 New task Set Up Your Handset Automatically , on page 28
Handset user interface enhancements	Updated Assign a Speed-Dial Number , on page 35 New task Delete a Speed-Dial Number , on page 37 New task Add a Recent Caller to Your Contact List , on page 64 Updated Set the Ringtone For Different Call Types , on page 76
General enhancements	New task Select Your Default Line , on page 85

Getting Started

You must install the battery in the handset and charge the handset battery before you use your handset. For more information, see [Install the Battery in the Handset](#), on page 22 and [Charge the Handset Battery](#), on page 27.

Turn on your handset

Procedure

Press and hold **Power/End**  until the screen turns on.

Turn off your handset

Procedure

Press and hold **Power/End**  until the screen turns off.

Report an Emergency Situation

Your 6825 Handset has an emergency button, located at the top of the handset. If set up by your administrator, you can press this button to raise an alert in an emergency situation. The handset places a call to a predefined emergency number and automatically turns on the speakerphone.



Note The 6823 Handset doesn't have an **Emergency** button.

Procedure

Press and hold **Emergency**  for 3 seconds.

Lock the handset keypad



You can manually lock the keypad to stop accidental dialing.

You can manually lock the keypad to stop accidental dialing. When you lock the keypad, the softkey label doesn't display.



Note When the keypad is locked, you can only dial emergency numbers.

Procedure

Press and hold **Zero (0)**  until the message "Press and hold 0" and the key lock icon ( or ) are displayed on the screen.

Related Topics

[Set the Handset Lock and PIN](#), on page 83

[Set the Timer to Automatically Lock the Handset](#), on page 83

Unlock the handset keypad



If the keypad is locked, you must unlock it before you can place most calls. You may need to input a PIN to unlock the handset.



Note When the keypad is locked, you can only dial emergency numbers.

You must unlock the keypad before you can place most calls. You may need to input a PIN to unlock the handset. The softkey labels appear when you unlock the keypad.

Procedure

Press and hold **Zero (0)**  until the message “Press and hold *” and the key lock icon  or  doesn't display on the screen.

Related Topics

[Set the Handset Lock and PIN](#), on page 83

[Set the Timer to Automatically Lock the Handset](#), on page 83









Buttons and Hardware





Your handset has many buttons and hardware features that you'll use regularly. Use the following figure and table to identify the important button and hardware features. The figure shows the 6823 Handset and 6825 Handset. The 6825 Ruggedized Handset is similar to 6825 Handset in appearance.



Figure 2: 6825 Handset and 6823 Handset Buttons and Hardware



Table 2: 6825 Handset and 6823 Handset Buttons and Hardware

Item	Name or Grouping	Description
1	Indicator light (LED)	Indicator light—Use the light to identify states. You can configure the event that triggers the red, yellow, or green LED.
2	Emergency button	<p>Emergency  Raises an emergency alarm, if configured.</p> <p>This button isn't available in the 6823 Handset.</p>
3	Headset port	<p>Headset port with cover  Remove the protective cover and plug in a headset or ear buds (3.5 mm audio jack).</p>
4	Softkeys, handset control buttons (Speaker , Menu), Navigation cluster, call control buttons (Answer/Send , Power/End).	<p>Softkeys  Activate the option displayed on the screen.</p> <p>Speaker  Toggle the speaker mode on or off for the handset.</p> <p>Menu  Access directories, settings, status, and other information.</p> <p>Navigation cluster  Navigation ring and Select button:</p> <ul style="list-style-type: none"> • Navigation ring (outer ring): Move up, down, left, or right. • Select button  (center of the cluster): select a menu item. <p>Answer/Send  Answer a ringing call or, after dialing a number, press to place the call.</p> <p>Power/End  Turn the handset on or off, or end a connected call. In menus, the button returns you to the previous screen.</p>

Item	Name or Grouping	Description
5	Keypad	<p>Dial numbers and enter letters.</p> <p>One </p> <ul style="list-style-type: none"> • Enter “1” when you dial a number. • Access voicemail Press and hold to automatically dial the voicemail system. • Enter these special text characters: . ! ? , - " @ + ; : <p>Asterisk </p> <ul style="list-style-type: none"> • Press and hold to add the plus (+) symbol at the beginning of a phone number. <p>Zero </p> <ul style="list-style-type: none"> • Enter “0” when you dial a number. • Press and hold to lock or unlock the keypad. • Enter a space. <p>Pound </p> <ul style="list-style-type: none"> • Press and hold to silence the handset ringer. If configured, the handset vibrates instead. • Enter this special text character: # <p>Use the keys 2 through 9 to enter letters and numbers.</p> <p>Note In some languages, additional characters may be present.</p>

Item	Name or Grouping	Description
6	Volume and Mute buttons	 <p>Volume</p> <ul style="list-style-type: none"> • When the handset is idle, change the ring volume or turn off the ringer. • During a call, control the speaker volume for the active handset, headset, or speaker. <p>Mute  Toggle the mute feature on or off.</p>

Navigation

Use the outer ring of the Navigation cluster to scroll through menus and to move between fields. Use the inner **Select** button of the Navigation cluster to select menu items.



Supported Characters

When you input information, the handsets support the following characters:

Figure 3: Supported Characters

	0	1	2	3	4	5	6	7	8	9	A	B	C	D	E	F
0			0	@	P	`	p	€	i	°	À	Ð	à	ð		
1		!	1	A	Q	a	q	ı	'	j	±	Á	Ñ	á	ñ	
2		"	2	B	R	b	r	,	'	ø	Č	Ā	Ò	â	ò	
3		#	3	C	S	c	s	f	"	£	č	Ā	Ó	ã	ó	
4		\$	4	D	T	d	t	„	"	¤	’	Ä	Ô	ä	ô	
5		%	5	E	U	e	u	…	▪	¥	µ	Å	Ö	å	ö	
6		&	6	F	V	f	v	†	-	ı	ŧ	Æ	Ö	æ	ö	
7		'	7	G	W	g	w	‡	—	§	·	Ç	×	ç	÷	
8		(8	H	X	h	x	ˆ	˜	˝	˘	È	Ø	è	ø	
9)	9	I	Y	i	y	Ř	ř	Ů	Đ	É	Ú	é	ù	
A		*	:	J	Z	j	z	Š	š	Ů	d'	Ê	Ú	ê	ú	
B		+	;	K	[k	{	<	>	«	»	Ë	Û	ë	û	
C		,	<	L	\	l		Œ	œ	Ë	Ť	İ	Ü	i	ü	
D		-	=	M]	m	}	Š	š	ě	ı'	Í	Ý	í	ý	
E		.	>	N	^	n	~	Ž	ž	Ň	ň	İ	ı	ı	ı	
F		/	?	O	_	o	ˆ	Ğ	ğ	Ÿ	˘	ı	ı	ı	ı	

Handset Screen Features

The screen shows information about your handset such as directory number, date and time, and softkeys. The screen is made up of three sections: the header row, the middle section, and the footer row.

Figure 4: Handset Screen

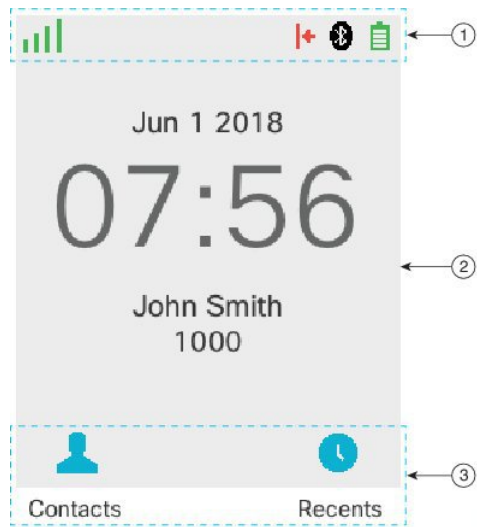

1	<p>At the top of the screen is the header row. The header row displays the radio signal strength and battery charge, as well a number of icons. The icons display when features are active.</p> <p>If your organization uses the BroadWorks Shared Call Appearance feature, a row of boxes displays immediately below the header row. Each box represents a user on a shared line.</p>
---	--

2	The middle of the screen displays the information associated with the handset: date and time, configured handset owner, and handset phone number.
3	The bottom row of the screen contains the softkey labels. Each label indicates the action for the softkey button below the screen. Sometimes, icons are displayed above the softkey labels.







Related Topics

[BroadWorks Shared Call Appearance](#), on page 44

Header Icons





The header icons tell you about the handset state. This section displays the header icons and gives their meaning. The header row icons can be different when do not disturb (DND) is enabled.

Audio Path Icons









Icon	DND Mode Icon	Description
		Speaker is off
		Headset in use.
		Handset is muted.

Bluetooth Icons

The 6823 Handset doesn't support Bluetooth.

Icon	DND Mode Icon	Description
		Bluetooth® is connected.
		Bluetooth® is disconnected.

Network Icons

Icon	DND Mode Icon	Description
		No network connection.
		Weak network connection.
		Good network connection.
		Better network connection.

Icon	DND Mode Icon	Description
		Best network connection

Battery Icons

Icon	DND Mode Icon	Description
		Battery is depleted. Recharge the battery to use the handset.
		Battery is 1% to 24% charged. Recharge the battery as soon as possible.
		Battery is 25% to 49% charged.
		Battery is 50% to 74% charged.
		Battery is 75% to 100% charged.
		Battery is charging.

Call-Related Icons

Icon	DND Mode Icon	Description
		Answered call
		Dialed call
		Do not disturb is enabled.
		Phone is forwarded.
		Voicemail message waiting.
		Missed call

Other Icons

Icon	DND Mode Icon	Description
		Handset keypad is locked.
		Message

Differences Between Phone Calls and Lines

We use the terms *lines* and *calls* in very specific ways to explain how to use your phone.

- Lines—Each line corresponds to a directory number or intercom number that others can use to call you. You have up to four lines.
- Calls—Each line can support up to two calls. However, you can have only two calls on the handset. Only one call can be active at any time; the other call is automatically placed on hold.

Here is an example: If you have four lines and each line supports two calls, then you can have two connected calls at one time. These two calls can be on the same line or on different lines. Only one of those calls is active and the other is a held call.

Phone Batteries

Your phone contains a lithium ion battery. The fully charged battery provides the following hours of service:

- Up to 17 hours of talk time
- Up to 200 hours of standby time

The battery life is reduced when the phone is turned on. Calls, messages, application use, Bluetooth use, and actions like menu navigation use power and reduce the talk time. Your phone screen dims and turns off after a configurable period of inactivity to reduce battery drain.

Related Topics

- [Set the Timer to Turn Off the Screen](#), on page 82
- [Charge the Handset Battery](#), on page 27

You can clean your handset. Make sure you follow our cleaning instructions.

Clean your handset immediately if it comes in contact with anything that may cause stains, or other damage; for example, dirt or sand, ink, makeup, soap, detergent, acids, acidic foods, or lotions.



Caution Do not blow or use compressed air (for example, aerosol cans, low- or high-pressure air nozzles) to clean the openings of the handset.

Do not use a vacuum cleaner or other suction device to clean the openings of the handset.

Do not use pins or other objects to clean the openings of the handset.

Use of air, suction, or mechanical objects to clean the openings can damage the handset and voids the handset warranty.

If you happen to drop the handset into water, or it gets splashed, follow our instructions to dry off the handset. See [If you drop your handset in water](#), on page 18.

Clean the handset screen

Procedure

If your handset screen gets dirty, wipe it with a soft, dry cloth.

Caution Do not use any liquids or powders on the phone because they can contaminate the handset components and cause failures.

Clean the handset exterior

You can clean the handset exterior using a dry, lint-free cloth. For the health-care environment, we recommend that you use Caviwipes™ and Saniwipes™ to thoroughly clean the handset. Caviwipes and Saniwipes contain up to 17% isopropanol.



Caution Excessive use of Caviwipes and Saniwipes more than 3 times a day will damage the handset surface coating and will change the appearance of handset.

Any cleaning solution containing a higher amount of isopropanol, including pure isopropanol, or an alternative alcohol-based liquid could potentially damage the handset. Do not clean the handset with bleach or other caustic products.

Clean your handset immediately if it comes in contact with anything that may cause stains, or other damage; for example, dirt or sand, ink, makeup, soap, detergent, acids, acidic foods, or lotions.



Caution Do not blow or use compressed air (for example, aerosol cans, low- or high-pressure air nozzles) to clean the openings of the handset.

Do not use a vacuum cleaner or other suction device to clean the openings of the handset.

Do not use pins or other objects to clean the openings of the handset.

Use of air, suction, or mechanical objects to clean the openings can damage the handset and voids the handset warranty.

Procedure

Step 1 Remove the handset from the charger.

Step 2 Wipe the handset and screen with a soft, lint-free cloth or with an approved sanitizing wipe.

Step 3 If there are foreign objects (for example, fine sand) in an opening in the handset, tap the handset against your hand to dislodge the objects.

If you drop your handset in water

If you drop your handset in water, here's what you do:

- *Gently* shake the water off the handset.
- Dry the handset with a soft, dry, lint-free cloth.
- Leave your handset in a dry area with some air flow; for example, a fan blowing *cool* air can be directed onto the handset speaker grill to help the handset dry out. Just don't put the fan close to the handset.

Here are some things you don't do:

- Don't open the battery door while the handset is wet.
- Don't use compressed air to blow off the water.
- Don't use a hair dryer to dry off the handset.
- Don't put a cotton swab, paper towel, or cloth into the headset jack or inside the battery compartment.
- Don't tap the handset on a hard surface.
- Don't put a wet handset into the charging cradle. You must wait until the handset is completely dry.



Note The handset warranty does not cover handsets that have been dropped in water or other fluids.



Caution Do not blow or use compressed air (for example, aerosol cans, low- or high-pressure air nozzles) to clean the openings of the handset.

Do not use a vacuum cleaner or other suction device to clean the openings of the handset.

Do not use pins or other objects to clean the openings of the handset.

Use of air, suction, or mechanical objects to clean the openings can damage the handset and voids the handset warranty.

If the sound is muffled after you dry the handset, there may still be water in the microphone or speaker compartments. Place your handset, speaker-side down, on a dry, lint-free cloth to see if water drips out. If there is still water in the handset, allow the handset to completely dry before you use it.

Additional Help and Information

If you have questions about the functions available on your phone, contact your administrator.

The Cisco website (<https://www.cisco.com>) contains more information about the phones and call control systems.

- For quick start guides and end-user guides in English, follow this link:

<https://www.cisco.com/c/en/us/support/collaboration-endpoints/ip-dect-6800-series-multiplatform-firmware/products-user-guide-list.html>

- For guides in languages other than English, follow this link:

<https://www.cisco.com/c/en/us/support/collaboration-endpoints/ip-dect-6800-series-multiplatform-firmware/tsd-products-support-translated-end-user-guides-list.html>

Document Accessibility for Visually-Impaired and Blind Users

The HTML version of this document supports the use of a JAWS® reader.

Cisco IP DECT 6800 Series Documentation

See the publications that are specific to your language and firmware release. Navigate from the following Uniform Resource Locator (URL):

<https://www.cisco.com/c/en/us/support/collaboration-endpoints/ip-dect-6800-series-multiplatform-firmware/tsd-products-support-series-home.html>

Lost Phone Connectivity

Sometimes your phone can lose its connection to the base station, or the base station can lose its connection to the call control system. When this connection is lost, your phone displays a message.

If you are on an active call when either connection is lost, the call ends.

If you lost the connection because you moved out of the base station range, you should add a coverage warning. For more information, see [Set the Coverage Warning, on page 79](#).

When the phone reconnects to the base station or the base station reconnects to the call control system, you'll be able to use your phone normally again.

Cisco One-Year Limited Hardware Warranty Terms

Special terms apply to your hardware warranty and services that you can use during the warranty period.

Your formal Warranty Statement, including the warranties and license agreements applicable to Cisco software, is available at: [Product Warranties](#).



CHAPTER 2

Handset Setup

- [Handset Hardware Installation, on page 21](#)
- [Handset Battery Charging, on page 27](#)
- [Automatic Handset Configuration, on page 28](#)
- [Manual Handset Configuration, on page 31](#)
- [Reset the Language and Text to Default in the Handset, on page 31](#)
- [Handset Firmware Upgrades or Downgrades, on page 31](#)

Handset Hardware Installation

Handset Package Contents

Your handset package has the following contents:

- Handset with attached belt clip. Inside the handset is the battery, with a piece of plastic over the battery contacts.



Note You need to remove the plastic over the battery contacts. For more information, see [Install the Battery in the Handset, on page 22](#).

- Charging cradle with attached USB cable.
- Regional power adapter for the charging cradle.
- Plastic cover to replace the belt clip on the handset.



Note Make sure that you save this small plastic cover, in case you want to use the handset without the belt clip.

- Printed compliance document.

You need the label on the box during handset registration.

Related Topics

[Install the Battery in the Handset](#), on page 22

[Handset Battery Charging](#), on page 27

[Remove the Handset Clip](#), on page 25

Install the Battery in the Handset

The handset battery is shipped inside the handset, but there's a plastic tab over the battery contacts. You need to remove the plastic tab.

Procedure

- Step 1** On the back of the handset, turn the latch counterclockwise to unlock the back, lift the clip, and lift the cover to remove the battery cover.

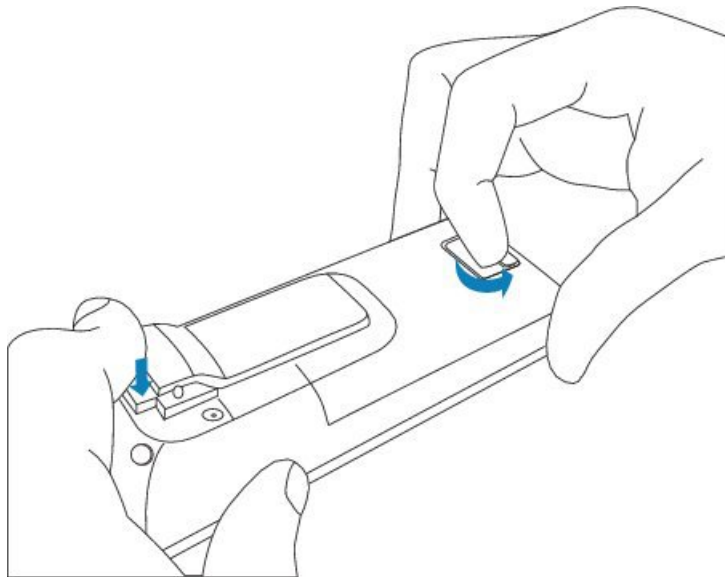

3350881

- Step 2** Remove the battery from the handset.

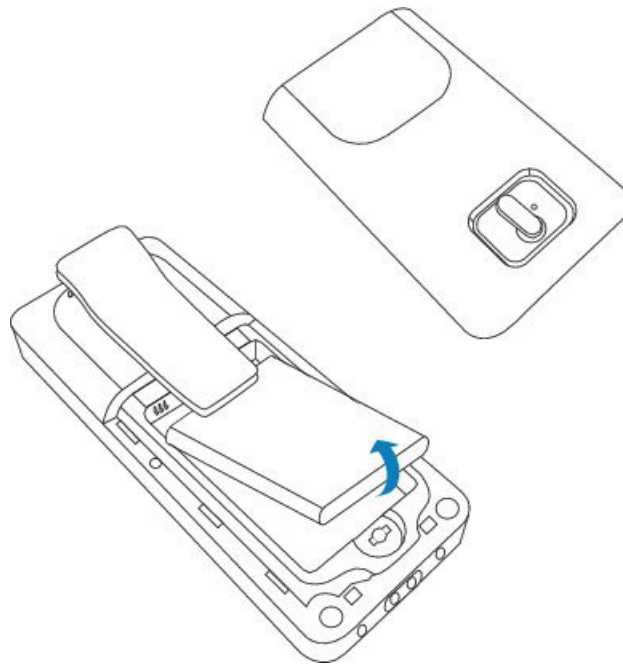

38134108

Step 3 Remove the plastic over the contacts.

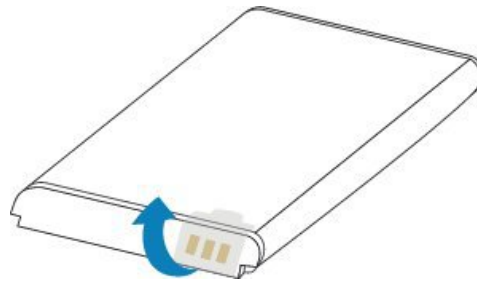

353509

Step 4 Place the battery under the clip and drop it into the compartment.

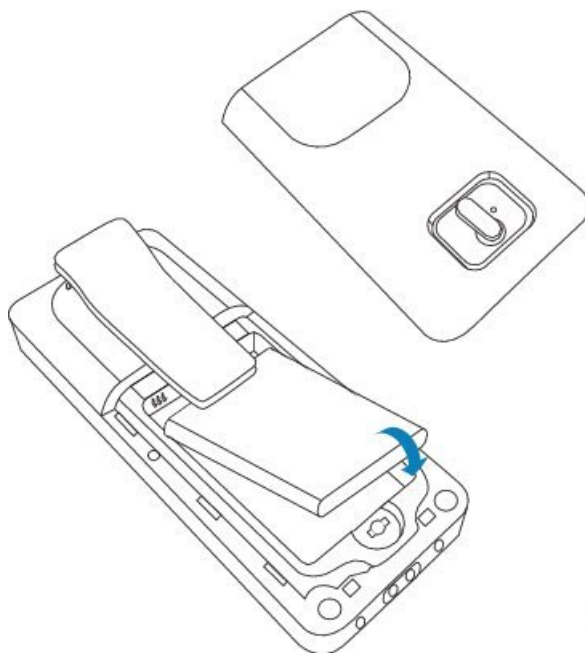

The battery contacts are on the top left edge of the battery and the top left edge of the battery compartment. Ensure that the contacts meet and that the battery is seated in the compartment.

Note The battery fits only one way in the compartment. Don't force the battery in the wrong way in the battery compartment.

Step 5 Replace the battery cover, make sure that the cover is closed, and turn the latch clockwise to the locked position.

Don't force the cover closed. If it doesn't close easily, take it off and check that the battery is completely seated in the battery compartment.

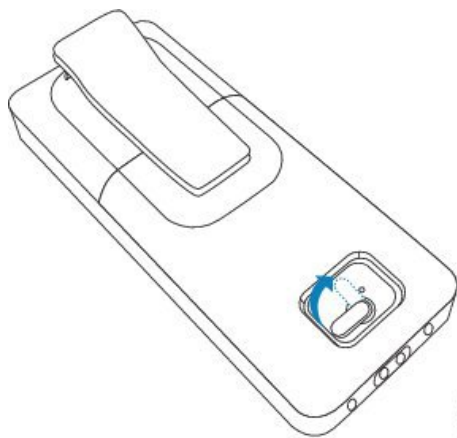

What to do next

Before you use the handset, you need to charge it. See [Charge the Handset Battery, on page 27](#).

Remove the Handset Clip

You can remove the clip from the back of the handset and replace it with a smooth cover that shipped with your handset.

Before you begin

You need:

- #1 Phillips-head screwdriver
- Plastic cover to replace the belt clip on the handset. This cover is shipped to you in the product box.

Procedure

- Step 1** Turn off the handset.
- Step 2** Place the handset face down on a flat, level surface. You may want to place the handset on a large, clean cloth to protect the handset.
- Step 3** Use the screwdriver to remove the screws on the clip. Set the screws aside.

Note The screws are small, so be careful not to lose them.

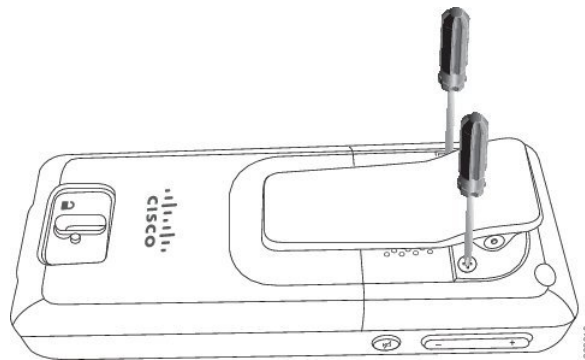

- Step 4** Lift up the loose end of the clip. The clip assembly should come off the handset.

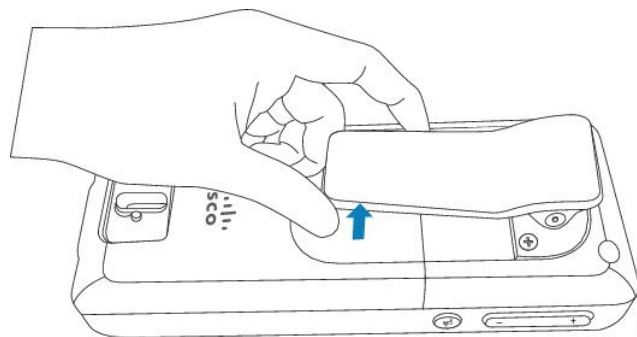

- Step 5** The replacement cover has a hook in the back. Slide the hook into the recessed area of the handset and press it into the handset.

This diagram shows the hook on the back.

Remove the Handset Clip

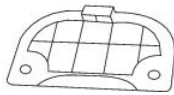
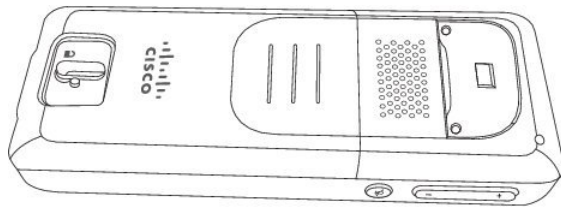

360912

This diagram shows the way you put the hook into the handset.

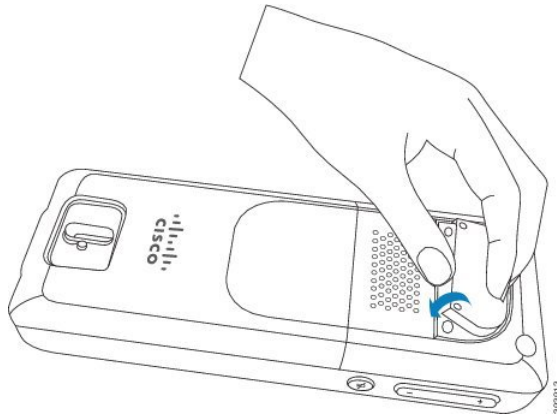

360913

Press down until the clip is in position and the back is flat.

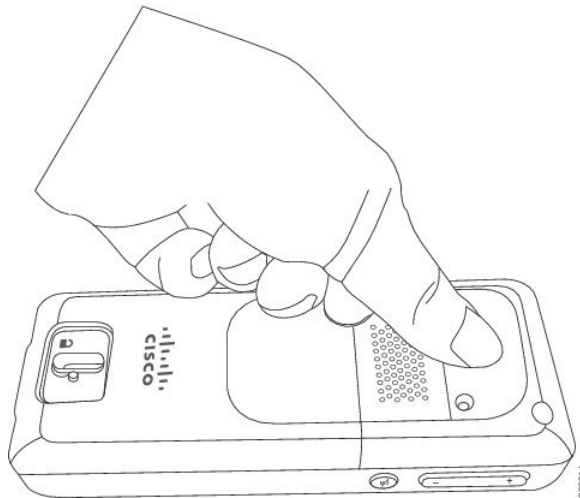

360914

Step 6 Use the screwdriver to screw the screws into the cover and handset.

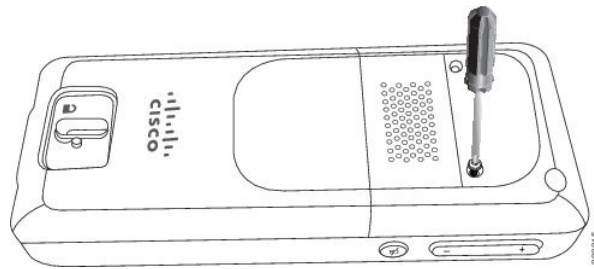

- Step 7** Store the cover with the belt clip, in case you need to use it.
-

Handset Battery Charging

Set Up the Charging Cradle

You use the charging cradle to charge the handset. The cradle has a built-in USB cable that plugs into the power adapter. The power adapter is designed for your country's electrical outlet configuration and power rating.

Procedure

- Step 1** Place the cradle on a level surface.
- Step 2** Plug the USB connector of the power cord into the power adapter.
- Step 3** Plug the power adapter into the electrical outlet.

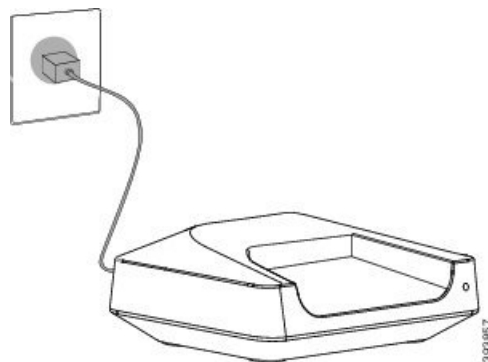

Charge the Handset Battery

You use the handset charger to charge the handset battery.



Note The battery comes partially charged, but you should charge it for a *minimum of 10 hours* before you use it for the first time. If you don't fully charge it, you may decrease the life of the battery.

If you remove and replace the battery from the handset, you need to fully discharge and then fully charge the battery so that the battery indicator is accurate.



Caution Charge the battery with the handset charger provided. If you use another method, you can damage the battery, the handset, or your surrounding area.

Only charge the battery in environments where the temperature is between 32°F (0°C) and 104°F (40°C).



Caution Don't charge the battery in hazardous environments or where there's explosion danger.

When you place the handset into the charger, it turns on (if not already on) and displays a message that the handset is charging. The handset screen dims and turns off at the configured time.

If the LED on the handset starts to flash, the handset is updating its firmware.

Before you begin

Set up the cradle as described in [Set Up the Charging Cradle, on page 27](#).

Ensure that your handset charger is plugged into the electrical outlet.

Procedure

Place the handset in the charger so that the contacts in the handset and the contacts in the charger match.

The handset beeps, screen turns on, and displays a message that the handset is charging. If this doesn't happen, remove the handset from the charger and try again.

Automatic Handset Configuration

Your handset may be set up to automatically configure itself. If your handset doesn't automatically configure, you have to manually configure it, using information provided by your administrator or service provider.

Set Up Your Handset Automatically

In many cases, when you first power-on the handset, it automatically starts to configure itself to communicate with the base station. You may get further instructions if there are choices or additional information.

When your handset successfully registers, you see the `Registered` message, and then the idle screen is displayed.

Procedure

- Step 1** Press and hold **Power/End**  until the screen turns on.
The handset displays `Search for base station`.
- Step 2** If the handset displays a list of base stations, press down on the navigation ring to highlight the base station that you need to connect to and press **Select**.
- Step 3** If the handset displays `Enter the code`, contact your administrator for the base station access code.
- Step 4** If the screen doesn't display the `Registered` message, make note of the error message and contact your administrator or service provider for assistance.
-

Set Up a Handset Automatically with the Username and Password

When you power on a new handset, it automatically registers itself with the base station which is in promiscuous mode. If the server requests authorization, you enter the username and password. When you need to register multiple handsets, we recommend that you power on one handset to enter the credentials. The other handsets don't receive the authorization request when they register.

The username and password can be a combination of letters, numbers, and symbols. The username can be between 1 and 24 characters and password can be between 1 and 128 characters.

If you enter a wrong username or password, an error message displays. You have three attempts to enter the correct username and password. If you fail all the attempts, the handset deregisters from the base station. Restart the handset and enter the correct username and password, or contact your administrator.

Before you begin

Your administrator or service provider gives you the username and password.

Procedure

- Step 1** Press and hold **Power/End**  until the screen turns on.
- Step 2** Enter the **Username** and **Password** in the **Sign in** screen.
- Step 3** Press **Submit**.
-

Set Up a Handset Automatically with a Short Activation Code

When you power on a new handset, it automatically registers itself with the base station which is in promiscuous mode. If the server requests the short activation code, you enter the short activation code. After the short activation code input, if the server requires authentication, you enter the username and password. When you need to register multiple handsets, we recommend that you power on one handset to enter the short activation code. The other handsets won't receive the authorization request when they register.

The short activation code starts with the # and varies between 3 to 16-digit number. The username and password can be a combination of letters, numbers, and symbols. The username can be between 1 and 24 characters and password can be between 1 and 128 characters.

If you enter a wrong short activation code, an error message screen displays. You have three attempts to enter the correct short activation code. If you fail all the attempts, the handset deregisters from the base station. Restart the handset and enter the correct short activation code, or contact your administrator.

Before you begin

Your administrator or service provider gives you the short activation code, username, and password.

Procedure

- Step 1** Press and hold **Power/End**  until the screen turns on.
 - Step 2** Enter the short activation code in the **Enter activation code** screen.
 - Step 3** Press **Submit**.
 - Step 4** (Optional) Enter the **Username** and **Password** in the **Sign in** screen.
 - Step 5** Press **Submit**.
-

Add the Handset Automatically in HEBU Mode

You can SIP register a handset to a base station in the Handset Extension by Username (HEBU) mode. When you power on a handset, a login screen displays to enter the username and password. You may need to enter the access code before this screen displays. If the username and password you enter match with the defined HEBU username and password in the base station, the handset registers to the defined extension.

The username and password can be a combination of letters, numbers, and symbols. The username or password can be from 1 to 40 characters.

If you enter a wrong username or password, an error message displays. You have three attempts to enter the correct username and password. If you fail all the attempts or a timeout occurs, the handset deregisters from the base station.

You can restart the handset and enter the correct username and password, or contact your administrator.

In a dualcell or a multicell system, you can register up to 20 handsets simultaneously with the base station in this mode.

Before you begin

Your administrator or service provider gives you the username and password.

Procedure

- Step 1** Press and hold **Power/End**  until the screen turns on.

- Step 2** Enter the **Username** and **Password** in the **Login** screen.
- Step 3** Press **Submit**.
-

Manual Handset Configuration

Sometimes you have to manually configure your handset. Your administrator will give you the information you need to access the base station web pages, access appropriate web pages, and set various fields.

You can find the manual configuration instructions in the *Cisco IP DECT 6800 Series Administration Guide*.

Reset the Language and Text to Default in the Handset

You can use the handset keys to reset the language and text display on your handset. After the reset, the handset has the default settings. The default settings change when the base station updates the handset.

The language and texts settings reset to default until the handset updates with new settings.

Before you begin

Make sure that your handset is off.

Procedure

Press the keys 3 and 5 until the screen turns on.

What to do next

Verify that the language and the text settings are default on your handset.

Handset Firmware Upgrades or Downgrades

Your administrator may need to upgrade or downgrade the firmware on your handset. The handset downloads the new firmware file from the server.

After the download completes, the handset needs to install the file. You see a message on the handset screen to tell you to put your handset into the charging cradle. When you put the handset in the charging cradle, the LED flashes to alert you that the handset is loading the new firmware. Leave the handset in the charging cradle until the LED stops flashing.



Warning Don't remove the handset from the cradle before the upgrade or downgrade completes to avoid damage to the handset.



CHAPTER 3

Calls

- [Make Calls, on page 33](#)
- [Answer a Call, on page 38](#)
- [End a Call, on page 40](#)
- [Hold and Resume a Call, on page 40](#)
- [Mute Your Call, on page 41](#)
- [Create a Conference Call, on page 41](#)
- [Call Transfer, on page 42](#)
- [BroadWorks Shared Call Appearance, on page 44](#)
- [Star codes, on page 45](#)
- [Use Push to Talk, on page 48](#)
- [Paging, on page 48](#)

Make Calls

Your handset works just like a regular phone. But we make it easier for you to make calls.

Make a Call

Your handset can have more than one line. By default, you place calls on the primary line.

Procedure



Step 1 When your handset is idle, enter the phone number with the keypad. To start the number with plus (+), press and hold **Asterisk**  until the + displays on the screen.

Step 2 Press **Answer/Send** .

Make a New Call with Intercom

You can make a new call with the **Intercom** menu on your handset. You can enter a number or select a number from the handset list to call. The handsets in the list display the intercom ID and the handset number.



Procedure

-
- Step 1** Press **Menu**  > **Intercom** .
- Step 2** Perform any one of the following on the **Intercom** screen:
- Highlight **Enter number** and press **Select**. Enter a number to call.
 - Highlight **Handset list** and press **Select**. Select the number from the list to call.
- Step 3** Press **Call**.
-

Make a Call on a Different Line

You may have more than one line on your handset. By default, your handset selects the first line. But, you can make a call from the second line.



Procedure

-
- Step 1** When your handset is idle, do one of these actions:
- Enter the phone number with the keypad and press **Line** or the center softkey. To start the number with plus (+), press and hold **Asterisk**  until the + displays on the screen.
 - Press **Line** and highlight a line.
- Step 2** Press **Select** or **Call**.
- Step 3** Enter the phone number, if not already entered.
- Step 4** Press **Answer/Send** .
-

Make a Call with the Speakerphone



Procedure

-
- Step 1** When your handset is idle, enter the phone number with the keypad. To start the number with plus (+), press and hold **Asterisk**  until the + displays on the screen.

- Step 2** Press **Speakerphone** .
- Step 3** Press **Answer/Send** .

Make a Call with a Headset

Procedure

- Step 1** When your handset is idle, remove the cover from the headset port and plug in your headset.
- Step 2** Enter the phone number with the keypad. To start the number with plus (+), press and hold **Asterisk**  until the + displays on the screen.
- Step 3** Press **Answer/Send** .

Speed Dial Calls

If you make frequent calls to specific phone numbers, you can set up your handset for speed dials. The speed dials help to press a key instead of entering the phone number. You can set up to 8 speed-dial numbers.





Assign a Speed-Dial Number

You can assign a speed-dial number to a contact. You assign speed dials to entries 2 to 9. Entry 1 is used for your speed dial to voicemail.

Before you begin

You need at least one contact in your Contacts list.

Procedure

- Step 1**
- 6825 Handset: Press **Menu**  > **Contacts**  or **Contacts** .
 - 6823 Handset: Press **Menu**  > **Contacts** .
- Step 2** Highlight the contact.
- Step 3** Press **More**.
- Step 4** Select **Speed Dial**.
- Step 5** If you don't have an empty speed-dial index entries, highlight a number you don't need and perform this action:
- 6825 Handset: Press **Delete** and press **Yes** to confirm the deletion.
 - 6823 Handset: Press **Unassign** and press **Yes** to confirm the deletion.

Step 6 Highlight an empty speed-dial index and press **Add**.

Step 7 Press **Power/End** .

Related Topics

[Add a Local Contact](#), on page 59

Speed-Dial Numbers

When you dial a number on your handset, you enter a series of digits. When you set up a speed-dial number, the speed-dial number must contain all the digits you need to make the call. For example, if you need to dial 9 to get an outside line, you enter the number 9 and then the number you want to dial.

You can also add other dialed digits to the number. Examples of additional digits include a meeting access code, an extension, a voicemail password, an authorization code, and a billing code.

The dial string can contain the following characters:

- 0 to 9
- Pound (#)
- Asterisk (*)
- Comma (,)—This is the pause character, and gives a 2 second delay in the dialing. You can have several commas in a row. For example, two commas (,,) represent a pause of 4 seconds.
- Semi-colon (;)—This is the wait character. Your handset will request confirmation before dialing the number.

The rules for dial strings are:

- Use the comma to separate the parts of the dial string.
- An authorization code must always precede a billing code in the speed-dial string.
- A single comma is required between the authorization code and the billing code in the string.
- A speed-dial label is required for speed dials with authorization codes and additional digits.

Before you configure the speed dial, try to dial the digits manually at least once to ensure that the digit sequence is correct.

Your handset does not save the authorization code, billing code, or extra digits from the speed dial in the call history. If you press **Redial** after you connect to a speed-dial destination, the handset prompts you to enter any required authorization code, billing code, or additional digits manually.

Example

To set up a speed-dial number to call a person at a specific extension, and if you need an authorization code and billing code, consider the following requirements:

- You need to dial **9** for an outside line.
- You want to call **5556543**.
- You need to input the authorization code **1234**.

- You need to input the billing code **9876**.
- You must wait for 4 seconds.
- After the call connects, you must dial the extension **56789#**.

In this scenario, the speed-dial number is **95556543,1234,9876,,56789#**.







Delete a Speed-Dial Number

You can delete a speed-dial number assigned to entries 2 to 9. Entry 1 is used for your speed dial to voicemail.

Before you begin

You need at least one contact in your Speed Dial list.

Procedure

-
- Step 1**
- 6825 Handset: Press **Menu**  > **Contacts**  or **Contacts** .
 - 6823 Handset: Press **Menu**  > **Contacts** .
- Step 2** Press **More**.
- Step 3** Select **Speed Dial**.
- Step 4** Highlight the entry you don't need.
- Step 5**
- 6825 Handset: Press **Delete**.
 - 6823 Handset: Press **Unassign**.
- Step 6** Press **Yes** to confirm the deletion.
- Step 7** Press **Power/End** .
-

Make a Speed Dial Call

After you set up the speed dial, as described in [Assign a Speed-Dial Number, on page 35](#), you can make a speed dial call. Speed-dial indexes are the numbers 2 to 9.

Example

If you have your home number in your local contacts, you can assign it the speed-dial index 9. Then when you press and hold the **9** key, the handset automatically dials your home.

Before you begin

You need the speed-dial index for the contact.

Procedure

-
- Step 1** Press and hold the number on the keypad corresponding to the speed-dial index.
- Step 2** Release the key when the call starts to dial.
-

Answer a Call

If you have multiple or shared lines, your handset displays the line that has the incoming call.

If you have a Bluetooth® headset connected to the handset, the call is answered on the headset or the handset while maintaining the audio path to the handset. If you don't have a Bluetooth headset connected, the call is answered on the handset.





Note The 6823 Handset doesn't support Bluetooth.

Procedure

Press **Answer/Send** .

The validation icon that displays next to the phone number can help you determine whether to answer or decline the incoming call. The validation icon shows if the call is from a valid or unknown source, or if the validation failed. For shared calls, the icon displays next to each phone number. These icons display next to the phone number to provide the validation result:

- —Valid
 - —Failed
 - —Unknown
-

Answer an Alarm (Emergency) Call

If your handset is set up as the recipient of alarm (emergency) calls, you receive alarm calls when someone

presses the **Emergency**  button on their handset. Alarm calls can be set up to ring one handset or a number of handsets.



Note The 6823 Handset doesn't have an **Emergency** button.

When an alarm call rings, you hear a different ringtone and your handset indicates that you have an alarm call. If you accept the call, the alarm is saved in the **Alarms** list. If you reject the call, the alarm isn't saved in the **Alarms** list.

Procedure

Press **Ok** to answer the call or press **Reject**.

Related Topics

[Emergency Alarm List](#), on page 69

Answer Call Waiting

If you are on a call, and another call comes in, you hear the call waiting tone and the incoming call displays on the handset screen.

Procedure

Do one of these actions:

- To accept the call, press **Answer/Send** . Your active call is automatically put on hold.
 - To reject the call, press **Decline**. The call is sent to voicemail, if configured.
-

Silence an Incoming Call

If you don't want to answer a call, you can decline or ignore the calls. If you decline the call, the caller hear less ring cycle. If you ignore the call, the caller hears the complete ring cycle.

The call will transfer to your voicemail, if voicemail is configured.

Procedure

When a call is ringing,

- Press **Decline** to immediately send the call to voicemail (if configured).
 - 6825 Handset only: Press **Ignore** to silence the ringer. If the call is not answered, then it is sent to voicemail (if configured).
-

Answer a Call within Your Group

You can answer a call that rings on another handset within your call group. Your administrator must assign you to at least one call group for you to answer the calls.

When you receive an intercom call, your handset displays the text **Intercom** on the screen.

Procedure

Press **Answer/Send** .

End a Call

Procedure

Press **Power/End** .

Hold and Resume a Call

You can put a call on hold and then resume it.

Procedure

- Step 1** From an active call, press **Hold**.
- Step 2** Press **Resume** to pick the call back up.
-

Swap Between Active and Held Calls

When you have an active call and a held call, you can easily swap the calls. The current active call goes on hold and the previously held call becomes the active call.

Procedure

Perform one of these actions:

- 6823 Handset, 6825 Handset: Press up or down on the navigation ring.

- 6825 Handset: Press **Swap**.
-

Hold and Make a New Call with Intercom

You can put an active call on hold and make a new call with the **Intercom** menu. You can resume the call with the **Resume** option.

Procedure

- Step 1** From an active call, press **Hold**.
- Step 2** Press **New call**.
- Step 3** Perform any one of the following in the **New call** screen:
- Select **Enter number** and enter the number.
 - Select **Contacts** to find the contact from the list.
 - Select **Central Directory** to find the contact from the list.
 - Select **Intercom** and enter the intercom number.
- Step 4** Press **Call**.
-

Mute Your Call

You can mute yourself, so that others on the call can't hear you.

Procedure

- Step 1** Press **Mute** .
- Step 2** To unmute yourself, press **Mute** again.
-

Create a Conference Call

You can add another person into an active call to create a three-way conference call.

Procedure

- Step 1** From an active call,
- 6825 Handset: Press **Conf**.
 - 6823 Handset: Press **More** > **Conference**.
- Step 2** Enter the coworker's number and press **Answer/Send** .
- Step 3** Press **Conf** after the coworker answers.
-

Create a Conference Call with Intercom

You can add another person into an active intercom call to create a three-way conference call. You can also create a three-way conference call between intercom and SIP calls. If the SIP and intercom conference settings don't match, the conference call between them isn't possible.

Procedure

- Step 1** From an active call, press **Conf**.
- Step 2** Perform any one of the following on the **Conference** screen:
- Select **Enter number** and enter the number.
 - Select **Contacts** to find the contact from the list.
 - Select **Central Directory** to find the contact from the list.
 - Select **Intercom** and enter the intercom number.
- Step 3** Press **Call**.
- Step 4** Press **Conf** after the call is answered.
-

Call Transfer

The call transfer feature allows you to redirect a connected call from your phone to another number. After call transfer, your call is disconnected and the transferred call is established as a new call connection.

You can transfer an active call to another number directly or consult before you transfer.

Transfer a Call Directly (Direct Transfer)

You can transfer a call to a coworker. You can transfer the call without waiting for the coworker to answer, or talk with the coworker before you transfer the call.

Procedure

- Step 1** From an active call,
- 6825 Handset: Press **Transfer**.
 - 6823 Handset: Press **More** > **Transfer**.
- Step 2** Enter the coworker's number and press **Answer/Send** .
- Step 3** Press **Transfer** before or after the coworker answers.
-

Related Topics

[Transfer a call with a star code](#), on page 46

Consult and Transfer a Call (Consult Transfer)

Before you transfer a call, you can talk to the person that you're transferring the call to.

Before you begin

You have an active call that needs to be transferred.

Procedure

- Step 1** Put an active call on hold by pressing **Hold**.
- Step 2** Enter the other person's phone number and press **New Call**.
- Step 3** (Optional) When the other person answers, you can talk to them.
- Step 4** After the consultation, press **Transfer** to complete your call transfer.
-

Transfer a Call with Intercom

You can transfer a call to a coworker with the **Intercom** menu. You transfer the call without waiting for the coworker to answer, or talk with the coworker before you transfer the call.

Procedure

- Step 1** From an active call, press **Transfer**.
- Step 2** Perform any one of the following in the **Transfer** screen:
- Select **Enter number** and enter the number.
 - Select **Contacts** to find the contact from the list.
 - Select **Central Directory** to find the contact from the list.

- Step 3** Press **Transfer** before or after the call is answered.
-

BroadWorks Shared Call Appearance

Your organization may use the BroadWorks Shared Call Appearance feature. With this feature, handsets are set up in groups. When enabled, each handset in the group displays as a box immediately below the header row. The color of the box identifies the state of the handset.

For Firmware Release 4.7, the shared line boxes have these states:

- Solid Red: The handset in use.
- Solid green: The handset is idle.
- Flashing green: The handset has an incoming call.

For Firmware Release 4.8, the shared line boxes have these states:

- Solid grey: The handset is idle.
- Solid red: The handset isn't active on the call.
- Pulsing red: The handset isn't active on the call that is on hold.
- Flashing green: The handset has an incoming call.
- Solid green: The handset is active on the call.
- Pulsing green: The handset has put the call on hold.

For details about this and other BroadWorks features, see the Broadworks documentation.

Related Topics

[Answer a Call](#), on page 38

Make a Call on a Shared Line

If you have a shared line, you can use it to make a call. The handset displays a list of shared lines.

The handset uses the primary line to make the call.

Procedure

- Step 1** Press **Line**.
- Step 2** Select a line and press **Call**.
- Step 3** Enter a number and press **Call**.
-

Join a Shared Call

You can join a call on a shared line to create a three-way call.

Procedure

- Step 1** Press **Line** and select the line.
 - Step 2** Press **Barge-in** to join the call.
-

Hold and Retrieve a Shared Call

You can put a call on hold on a handset and retrieve the call with another handset with the shared line.

Procedure

- Step 1** Press **Hold** on the handset you answered the call.
 - Step 2** Press **Line** and select the line.
 - Step 3** Press **Retrieve** to pick the call.
-

Star codes

You can use star codes to quickly access some functions. These codes are made up of the asterisk (*) and a 2-digit code.

For the list of star codes, contact your administrator.

Return a call with a star code

You can call the last person who called you with a star code instead of using the **Recents** list.

Use the star code given to you by your administrator or service provider.

Procedure

While your handset is idle, enter the call return star code.

Related Topics

[Call Someone in Your Recent Calls List](#), on page 64

Transfer a call with a star code

You can immediately transfer a call to a coworker. This type of transfer doesn't allow you to talk with the coworker first.

Use the star code given to you by your administrator or service provider.

Procedure

- Step 1** While on an active call, enter the call transfer star code.
 - Step 2** Enter the number to transfer the call to.
-

Related Topics

[Transfer a Call Directly \(Direct Transfer\)](#), on page 42

Activate and deactivate call forward all with star codes

You can set up your handset to forward all your calls to another coworker or to voicemail with a star code.

Use the star code given to you by your administrator or service provider.

Procedure

- Step 1** While your handset is idle, enter the call forward unconditional star code.
 - Step 2** Enter the number to forward calls to.
 - Step 3** To make calls ring on your handset again, enter the star code to cancel call forward unconditional.
-

Related Topics

[Set Call Forward Unconditional](#), on page 87

Activate and deactivate call waiting with star codes

You can turn off call waiting notification. When you activate call waiting, you don't hear a tone for an incoming call when you are on a call.

Use the star code given to you by your administrator or service provider.

Procedure

- Step 1** While your handset is idle, enter the star code to block call waiting.
 - Step 2** To hear the tone again, enter the star code to enable call waiting.
-

Block and unblock outgoing caller information with a star code

You can stop your handset from sending your caller information. You may need to do this for privacy reasons. Use the star code given to you by your administrator or service provider.

Procedure

- Step 1** While your handset is idle, enter star code to block caller information.
- Step 2** To allow the handset to send caller information, enter the star code to enable caller information.
-

Related Topics

[Hide Your Caller ID When You Make a Call](#), on page 87

Block and unblock anonymous calls with a star code

You can ensure that only calls with a proper caller ID ring on your handset with a star code. Use the star code given to you by your administrator or service provider.

Procedure

- Step 1** While your handset is idle, enter the star code to block anonymous calls.
- Step 2** To allow calls to ring again, enter the star code to allow anonymous calls.
-

Turn do not disturb on and off with a star code

When you don't want to be disturbed by incoming calls, you can turn on do not disturb (DND). When your handset is in DND state, the incoming call is sent to voicemail.

Use the star code given to you by your administrator or service provider.

To use this feature, your administrator must enable DND.

Procedure

- Step 1** While your handset is idle, enter the do not disturb star code.
- Step 2** To deactivate DND, enter code to cancel do not disturb.
-

Related Topics

[Set Do Not Disturb](#), on page 86

Use Push to Talk

You can use the handset as a two-way radio with the Push to Talk feature. The message is played over the handset speaker automatically. Only 1 person at a time can use Push to Talk. If you press **Mute** while you are receiving a Push to Talk message, the handset speaker mutes.

Before you begin

- You need Push to Talk enabled on your handset.
- At least one more handset in the system needs Push to Talk enabled.

Procedure

Step 1

When your handset is idle, push and continue to hold **Mute** .

Step 2

After the connected screen displays, you can talk.

Step 3

When your message is complete, release **Mute**.

Related Topics

[Turn on Push To Talk](#), on page 91

Paging

You can page a group of phones or phone lines. Your administrator can create up to three paging groups. Each paging group has a unique number. Your administrator gives you the configured paging group numbers. When your handset receives a page, you see or hear the notification. You hear a beep or beeps notification which is defined in the Call Progress Tones web page of the base station. You don't have to accept the page.

Here are the paging scenarios when your handset receives a page:

- If the handset is inactive, the page plays through the speakerphone.
- If the handset is active, the priority of the page determines the behavior as described in the following table.

Table 3: Page Priority with Behavior

Priority	Alert	Result
0	See and hear notification	The active call goes on hold and the page plays.
1	See and hear notification	You switch to the page, the active call goes on hold, and the page plays.
2	Hear notification	You see the notification after the call ends and then the page plays.

Priority	Alert	Result
3	No notification	You see the notification after the call ends and then the page plays.

- If the handset receives another page with an active page, the higher priority page interrupts the lower priority page. When both the pages have the same priority, the active page continues to play and the incoming page goes on hold.
- If the system has push to talk and paging configured, a page interrupts a push to talk session.
- If the handset has DND mode set, it blocks the pages of all priorities.

Related links

[Send a Page, on page 49](#)

Send a Page

You can page a person or a group of people with a paging group number. All the handsets configured in the group receive the page, which plays automatically on the speakerphone.

Before you begin

You need a paging group number.

Procedure

Step 1 Dial the paging group number.

Step 2 Press **Answer/Send** .



CHAPTER 4

Text Messages

- [Text Messages](#), on page 51
- [Send a Text Message](#), on page 51
- [Reply to a Text Message Immediately](#), on page 52
- [Add a Text Message Sender to Your Local Contacts](#), on page 53
- [Append a Text Message Sender to a Local Contact](#), on page 53
- [Forward a Text Message](#), on page 54
- [Delete a Text Message Immediately](#), on page 54
- [Delete all Text Messages](#), on page 55
- [View Your Text Message History](#), on page 55
- [Configure Your Text Message Settings](#), on page 57

Text Messages



Your administrator may enable you to send and receive text messages from coworkers on the system. You may also be able to send text messages to people outside the system. Your administrator should tell you the text message constraints.

You can view the history of your text messages and you can set some messaging parameters to suit your needs.

Send a Text Message

You can send a message of up to 160 characters.

Procedure

- Step 1** Press **Menu** .
- Step 2**
- 6825 Handset: Choose **Messaging** .
 - 6823 Handset: Choose **Messaging** .
- Step 3** Press right on the navigation ring to display the **Drafts** screen.

- Step 4** Press **New**.
- Step 5** Use the keypad to type your message. The length of your message displays on the bottom right corner of the screen.
- Step 6** (Optional) If you need special symbols that are not on the keypad, press **Symbol** or the center softkey and choose the symbol you need.
- Step 7** Press **Send**.
- Step 8** Choose the message priority from these options:
- **Normal**: The message is sent in default mode.
 - **Urgent**: The message is sent as urgent. The recipient sees an icon with an exclamation mark on the message in their **Inbox** screen. You see the icon with an exclamation mark on the message in your **Sent messages** screen. Messages sent as Urgent display at the top of the list.
- Step 9** Choose message recipient with one of these options:
- **Contacts**: When you choose this option, your local contacts list is displayed and you can select a contact.
 - **Enter number**: When you choose this option, you enter a phone number in the next screen.
 - **Central Directory**: When you choose this option, the central phone directory is displayed and you can select a contact.
- The full phone number must be used for text messages. For example, if your contact has an internal extension 8902 and an external number of +2345678902, you must use +2345678902.
- Step 10** Press **Send**.
- Step 11** Press **OK**.
-

Reply to a Text Message Immediately

When you receive a text message, you can reply to it quickly from the text message screen. You can also reply later from the text message history.

Procedure

- Step 1** Press **Reply**.
- Step 2** Use the keypad to type your message. The length of your message displays on the bottom right corner of the screen.
- Step 3** (Optional) If you need special symbols that are not on the keypad, press **Symbol** or the center softkey and select the symbol you need.
- Step 4** (Optional) Press **Clear**  or the right softkey to delete the last character of your message.
- Step 5** Press **Send**.
- Step 6** Choose the message priority from these options:
- **Normal**: The message is sent in default mode.
 - **Urgent**: The message is sent as urgent. The recipient sees an icon with an exclamation mark on the message in their **Inbox** screen. You see the icon with an exclamation mark on the message in your **Sent messages** screen. Messages sent as Urgent display at the top of the list.

Step 7 Press **Send**.

Step 8 Press **OK**.

Related Topics

[Reply to a Text Message from Your Text History](#), on page 56

Add a Text Message Sender to Your Local Contacts

When you receive a text message, you can add the person to your local contact list from the text message screen. You can also add the person later from the text message history.

Before you begin

You must be viewing a text message.

Procedure

- Step 1** Press **More**.
 - Step 2** Choose **Save as contact**.
 - Step 3** Press **Select**.
 - Step 4** Enter the name with the keypad and press **Save**.
 - Step 5** Highlight a phone number entry (**Work**, **Mobile**, **Home**, or **Other**) and press **Add**.
 - Step 6** Press **Save** to save the contact number.
 - Step 7** Press **Save** to save the new contact.
-

Append a Text Message Sender to a Local Contact

When you receive a text message, you can append information about the person to an existing local contact from the text message screen. You can also append the information later from the text message history (see [View Your Text Message History, on page 55](#)).

Before you begin

You must be viewing a text message.

Procedure

- Step 1** Press **More**.
- Step 2** Choose **Append to contact**.
- Step 3** Press **Append**.
- Step 4** Highlight a phone number entry (**Work**, **Mobile**, **Home**, or **Other**) and press **Append**.

Step 5 Press **Save** to save the contact number.

Step 6 Press **Yes**.

Forward a Text Message

When you receive a text message, you can forward it quickly from the text message screen.

Before you begin

You must be viewing a text message.

Procedure

Step 1 Press **More**.

Step 2 Select **Forward**.

Step 3 Use the keypad to type your message. The length of your message displays on the bottom right corner of the screen.

Step 4 (Optional) If you need special symbols that are not on the keypad, press **Symbol** or the center softkey and select the symbol you need.

Step 5 (Optional) Press **Clear**  or the right softkey to delete the last character of your message.

Step 6 Press **Send**.

Step 7 Choose the message priority from these options:

- **Normal:** The message is sent in default mode.
- **Urgent:** The message is sent as urgent. The recipient sees an icon with an exclamation mark on the message in their **Inbox** screen. You see the icon with an exclamation mark on the message in your **Sent messages** screen. Messages sent as Urgent display at the top of the list.

Step 8 Choose the message recipient with one of these options:

- **Contacts:** When you choose this option, your local contacts list is displayed and you can select a contact.
- **Enter number:** When you choose this option, you enter a phone number in the next screen.
- **Central Directory:** When you choose this option, the central phone directory is displayed and you can select a contact.

The full phone number must be used for text messages. For example, if your contact has an internal extension 8902 and an external number of +2345678902, you must use +2345678902.

Step 9 Press **Send**.

Step 10 Press **OK**.

Delete a Text Message Immediately

You can delete a text message after you read it.

Before you begin

You must be viewing a text message.

Procedure

- Step 1** Press **More**.
 - Step 2** Choose **Delete message**.
 - Step 3** Press **Yes**.
-

Related Topics

[Delete a Text Message from the Text Message History](#), on page 56

Delete all Text Messages

You can delete all received text messages after you read a message. The messages in your Text message Inbox are deleted.

Before you begin

You must be viewing a text message.

Procedure

- Step 1** Press **More**.
 - Step 2** Choose **Delete all messages**.
 - Step 3** Press **Yes**.
-

Related Topics

[Delete all Text Messages from the Text Message History](#), on page 57

View Your Text Message History



The text message history can contain up to 250 messages. If you have more than this number of messages, the Overwrite old messages field in the messaging settings controls if the handset overwrites old messages. For more information, see [Configure Your Text Message Settings](#), on page 57.

The messages display in different lists: **Inbox**, **Drafts**, **Sent messages**. When you access **Messaging**, the **Inbox** is displayed.

Procedure

- Step 1** Press **Menu** .

Step 2

- 6825 Handset: Select **Messaging** .
- 6823 Handset: Select **Messaging** .

Step 3

Press right on the Navigation ring to access the next screen.

Reply to a Text Message from Your Text History



You can respond to a text message later from the text messaging history.

Procedure

Step 1

Press **Menu** .

Step 2

- 6825 Handset: Select **Messaging** .
- 6823 Handset: Select **Messaging** .

Step 3

Highlight the message.

Step 4

Press **Reply**.

Step 5

Use the keypad to type your message. The length of your message displays on the bottom right corner of the screen.

Step 6

(Optional) If you need special symbols that are not on the keypad, press **Symbol** or the center softkey, and select the symbol you need.

Step 7

(Optional) Press **Clear**  or the right softkey to delete the last character of your message.

Step 8

Press **Send**.

Step 9

Choose the message priority from these options:

- **Normal**: The message is sent in default mode.
- **Urgent**: The message is sent as urgent. The recipient sees an icon with an exclamation mark on the message in their **Inbox** screen. You see the icon with an exclamation mark on the message in your **Sent messages** screen. Messages sent as Urgent display at the top of the list.

Step 10

Press **Send**.

Step 11

Press **OK**.



Related Topics

[Reply to a Text Message Immediately](#), on page 52

Delete a Text Message from the Text Message History

You can delete a text message in the text history from your **Inbox**, **Drafts**, or **Sent messages** folder.

Procedure

- Step 1** Press **Menu** .
- Step 2**
- 6825 Handset: Select **Messaging** .
 - 6823 Handset: Select **Messaging** .
- Step 3** Press right on the navigation ring to display the appropriate folder.
- Step 4** Press **More**.
- Step 5** Choose **Delete Message**.
- Step 6** Press **Yes**.
-



Related Topics

[Delete a Text Message Immediately](#), on page 54

Delete all Text Messages from the Text Message History

You can delete all text messages in the text history in your **Inbox**, **Drafts**, or **Sent messages** folder.

Procedure

- Step 1** Press **Menu** .
- Step 2**
- 6825 Handset: Select **Messaging** .
 - 6823 Handset: Select **Messaging** .
- Step 3** Press right on the navigation ring to display the appropriate folder.
- Step 4** Press **More**.
- Step 5** Choose **Delete all messages**.
- Step 6** Press **Yes**.
-

Related Topics



[Delete all Text Messages](#), on page 55

Configure Your Text Message Settings

You can set up your handset for these actions:

- Overwrite old messages when the text message history reaches the limit. You can keep up to 250 messages. If you don't enable the handset to overwrite old messages, you have to manually delete messages when the text message history is full.
- Save the messages you send in the text message history. By default, your sent messages are saved in the text message history.
- Set how a new message displays when your handset is idle. When you receive a new message, you can set the handset to:
 - Display only that you have a new message.
 - Display the full message immediately. This is the default setting.

Procedure

- Step 1** Press **Menu** .
- Step 2**
- 6825 Handset: Select **Messaging**  > **Settings**.
 - 6823 Handset: Select **Messaging**  > **Settings**.
- Step 3** Choose **Overwrite old** and press **On** or **Off**. By default, this field is set to **Off**.
- Step 4** Choose **Sent Messages** and press **On** or **Off**. By default, this field is set to **On**.
- Step 5** Choose **Display** and press **On** or **Off**. By default, this field is set to **On**.
-



CHAPTER 5

Contacts and Directories

- [Local Contacts](#), on page 59
- [Directories](#), on page 62

Local Contacts

You can create and save information about your contacts in the local contact list. Your local contacts list can contain up to 250 entries in 6825 Handset and 100 entries in 6823 Handset. Each contact can have four phone numbers.

After you add contacts, you can easily call a contact. You can set up speed dials to your local contacts.

Your administrator can also upload a local contacts list to your handset, and export your contacts list.

You access the contact list from the main screen or from the **Menu** .



Related Topics

[Add a Recent Caller to Your Contact List](#), on page 64

Add a Local Contact

You can add a contact to your contact list. You can also add the information from the recent caller to your contact list.

Procedure

- Step 1**
- 6825 Handset: Press left softkey **Contacts** .
 - 6823 Handset: Press **Menu**  > **Contacts** .
- Step 2** Press **More**.
- Step 3** Highlight **Add contact** and press **Select**.
- Step 4** Press **Edit**.
- Step 5** Enter the name of the contact.

- Step 6** Press **Save**.
- Step 7** Highlight **Work**, **Mobile**, **Home**, or **Other**, and press **Edit**.
You need to add at least one phone number.
- Step 8** Enter the contact number and press **Save**.
If you make a mistake, press **Clear**  to delete the last character entered.
- Step 9** (Optional) Add a ringtone to the contact.
- Highlight **Ringtone** and press **Edit**.
 - Choose a melody.
You can use **Play** to hear the ringtone
 - Press **Select**.
- Step 10** Press **Save**.
- Step 11** Press **Yes**.



Related Topics

[Assign a Speed-Dial Number](#), on page 35

Call a Local Contact

You can call a contact from your contact list. If your contact has more than one phone number configured, you can select which number you want to call.



Procedure

- Step 1**
- 6825 Handset: Press left softkey **Contacts** .
 - 6823 Handset: Press **Menu**  > **Contacts** .
- Step 2** Highlight an entry.
- Step 3** (Optional) If your contact has more than one phone number configured, press right or left on the navigation ring to display the number to call.
- Step 4** Press **Call**.
-

Edit a Local Contact

You can edit a contact entry in your contact list.



Procedure

- Step 1**
- 6825 Handset: Press left softkey **Contacts** .
 - 6823 Handset: Press **Menu**  > **Contacts** .
- Step 2** Highlight the contact to edit.
- Step 3** Press **More**.
- Step 4** Choose **Edit contact**.
- Step 5** Highlight the information to change.
- a) Press **Edit**.
 - b) Change the information
 - c) Press **Save**.
- Step 6** Press **Save** to change the contact entry.
-

Delete a Local Contact

You can delete a contact from your contact list.

Procedure

- Step 1**
- 6825 Handset: Press left softkey **Contacts** .
 - 6823 Handset: Press **Menu**  > **Contacts** .
- Step 2** Highlight the contact to delete.
- Step 3** Press **More**.
- Step 4** Choose **Delete contact**.
- Step 5** At the prompt, press **Yes**.
-

Delete all Local Contacts

You can delete all the contacts from your contact list.

Procedure

- Step 1**
- 6825 Handset: Press left softkey **Contacts** .

- 6823 Handset: Press **Menu**  > **Contacts** .

- Step 2** Press **More**.
- Step 3** Choose **Delete all contacts**.
- Step 4** At the prompt, press **Yes**.
-

Directories

Your administrator can set up a central directory for your organization. The directory allows you to search and call any number in the directory.

You can access the directory from the main screen or from the **Menu** .

Call a Central Directory Contact

You can search, view, and call a number in the directory. The type of search you can use depends on the method your administrator used to set up the directory and the availability of subdirectories. For example, you may see an **All** directory for all people in your organization and a separate entry for your department.

Procedure

- Step 1** Press **Directory** .
- Step 2** Do one of these actions:
- Scroll down to highlight an entry.
 - Press **Search**, select a directory, enter part or all of the first name of the user, and press **Search**.
- Step 3** (Optional) Press **Line** and select a line to call on.
- Step 4** Press **Select**.
-



CHAPTER 6

Recent Calls and Voicemail

- [Recent Calls List, on page 63](#)
- [Access Your Voicemail, on page 65](#)

Recent Calls List

Your handset collects information about all calls to and from your handset and saves them in a Recents list. When you view the Recents list, you can:

- View all calls.
- View all answered calls.
- View all dialed calls.
- View all missed calls.

View Your Recent Calls

Your handset keeps a log of all the recent calls. Up to 50 calls are kept in the Recents list. You can view all calls, the calls you answered, the calls you made (dialed calls), and calls you missed.



Procedure

Step 1 Press **Recents** .

Step 2 Press right or left on the Navigation ring  to view different lists.

- **All calls**
- **Answered calls**
- **Dialed calls**
- **Missed calls**

A validation icon that displays next to the phone number shows if the call is from a valid or unknown source, or if the validation failed. The following validation icons provide the validation result:

- —Valid
- —Failed
- —Unknown

Call Someone in Your Recent Calls List

You can call anyone who is displayed in your recent calls list.

Procedure

Step 1

Press **Recents** .

Step 2

Press right or left on the Navigation ring  to view different lists.

Step 3

Highlight an entry and press **Call**.

Related Topics

[Return a call with a star code](#), on page 45

Add a Recent Caller to Your Contact List

You can add the information from a recent caller to your local contacts list.

Procedure

Step 1

Press **Recents**.

Step 2

Highlight the recent caller.

Step 3

Press **More**, highlight **Save as contact**, and press **Select**.

Step 4

Highlight the category for the phone number and press **Select**.

The number the caller used to call you is added to the field.

Step 5

Press **Save** to save the number.

Step 6

(Optional) To add other information, highlight the field, and press **Add**.

Step 7

(Optional) To change other information, highlight the field, and **Replace**.

Step 8

Press **Save** to save the contact.

Step 9

Press **Yes** to confirm.

Access Your Voicemail

You can access your voice messages directly from your handset. But your administrator must set up your voicemail account, and may also set up your handset to access the voicemail system. When set up, you use

One  to access your voicemail.

When you don't have your handset available, you can call from any device to your voicemail system to access your voicemail. Your administrator can give you the voicemail system phone number.

When you have a voicemail, you see the Voicemail icon  on the screen header. You may also hear a stutter tone played from your handset, headset, or speakerphone when you use a phone line. This stutter tone is line-specific. You only hear it when you use a line that has voice messages.



Note Because each voicemail system is different, we can't tell you how to use your voicemail system. For information about your voicemail commands, see the voicemail system user documentation or contact your administrator.

Procedure

- Step 1** Press and hold **One**  until the call dials.
- Step 2** Follow the voice prompts.
-



CHAPTER 7

Alarm Clock, Emergency Alarm List, and Function Keys

- [Alarm Clock](#), on page 67
- [Emergency Alarm List](#), on page 69
- [Function keys](#), on page 70

Alarm Clock

You can use your handset as an alarm clock. When the alarm rings, you can dismiss the alarm or set the handset to ring in a few minutes. You can set a one-time alarm or a recurrent alarm.

The **Alarms** screen displays:

- The one-time **Alarm** entry displays the time of the alarm (if set).
- From Firmware Release 4.7, the **Recurrent alarm** entry displays the time of the alarm and the days selected for the alarm (if set).
- In Firmware Release V450 and V460, the **Recurrent alarm** entry displays the time of the next alarm (if set).
- The Snooze time entry displays the length of time before the alarm rings again.

Set an Alarm

You can set your handset to remind you at a specific time with an alarm timer. When the timer expires and the handset rings, the alarm field returns to **Off**.

You can set only one single-use alarm at a time.

Procedure

Step 1 Press **Menu** .

Step 2 • 6825 Handset: Select **Alarms**  > **Alarm**.

- 6823 Handset: Select **Alarms**  > **Alarm**.

Step 3 Set the time for the alarm.

- Press right or left on the Navigation ring  to move from field to field.
- Press up or down on the Navigation ring to increment or decrement the entry.
- Enter the number with the keypad.

Step 4 Press **Save**.

Set a Recurrent Alarm

You can set your handset to remind you at a specific time each day with a recurrent alarm timer. You can set only one recurrent alarm on the handset.

Procedure

Step 1 Press **Menu** .

Step 2 • 6825 Handset: Select **Alarms**  > **Recurrent alarm**.

- 6823 Handset: Select **Alarms**  > **Recurrent alarm**.

Step 3 Set the time for the alarm.

- Press right or left on the Navigation ring  to move from field to field.
- Press up or down on the Navigation ring to increment or decrement the entry.
- Enter the number with the keypad.

Step 4 Press **Save**.



Step 5 Highlight each day of the week for the alarm and press **Mark**.

Step 6 Press **Ok**.

Set the Snooze Time

When an alarm rings, you can press **Snooze** to make the alarm ring again at the configured time. By default, the delay is 10 minutes, but you can set any delay from 1 minute to 10 minutes.

Procedure

- Step 1** Press **Menu** .
- Step 2**
- 6825 Handset: Select **Alarms**  > **Snooze time**.
 - 6823 Handset: Select **Alarms**  > **Snooze time**.
- Step 3** Choose the snooze time.
- Step 4** Press **Select** .
-

Respond to an Alarm

At the configured alarm time, the handset rings and you respond to the alarm. If you are on a call, the alarm doesn't ring through until you end the call.

Before you begin

You need either a single alarm or a recurrent alarm configured. See [Set an Alarm, on page 67](#) or [Set a Recurrent Alarm, on page 68](#).

Procedure

Do one of the these actions:

- Press **Snooze** to make the alarm ring again at the selected interval (see [Set the Snooze Time, on page 68](#)).
 - Press **Dismiss**.
-

Emergency Alarm List



You can view the list of emergency alarms you received, if emergency alarms are configured to ring on your handset.

Related Topics

[Answer an Alarm \(Emergency\) Call, on page 38](#)

View the Received Emergency Alarms

Procedure

- Step 1** Press **Menu** .
- Step 2** Select **Alarm list** .
- Step 3** If there are alarms, press **Select** to view the alarm information.
-



Function keys

You can set up function keys (known as F-keys or speed dial) to access phone numbers. For example, you can set up an F-key or speed dial to call your security department. After you set up an F-key or speed dial, you can add it to your speed dial list.

The 6825 Handset call these as F-keys, while the 6823 Handset call these as speed dial.

Set up an F-key



Procedure

- Step 1** Press **Menu** .
- Step 2**
- 6825 Handset: Select **F-Keys** .
 - 6823 Handset: Select **Speed Dial** .
- Step 3** Press **More**.
- Step 4**
- 6825 Handset: Select **Add F-Key**.
 - 6823 Handset: Select **Add Speed Dial**.
- Step 5** Highlight the **Name** field and press **Edit**.
- Step 6** Enter a name.
- Step 7** Press **Save**.
- Step 8** Highlight the **Number** field and press **Edit**.
- Step 9** Enter a number.
- Step 10** Press **Save**.
- Step 11** Press **Yes**.
-

Make a call with an F-key or a speed dial

You can call a person from the F-key or speed dial entry.

Procedure

-
- Step 1** Press **Menu** .
- Step 2**
- 6825 Handset: Select **F-Keys** .
 - 6823 Handset: Select **Speed Dial** .
- Step 3** Choose an entry and press **Call**.
-



Add an F-key or a speed dial to your speed dial list

You can add an F-key or a speed dial to your speed dial list.

Before you begin



You need an F-key or a speed dial defined.

Procedure

-
- Step 1** Press **Menu** .
- Step 2**
- 6825 Handset: Select **F-Keys** .
 - 6823 Handset: Select **Speed Dial** .
- Step 3** Highlight an entry.
- Step 4** Press **More**.
- Step 5** Select **Speed dial**.
- Step 6** Do one of these actions.
- Choose an empty entry and press **Add**.
 - Choose an existing speed dial and press **Replace**.
 - Choose an existing speed dial and perform this action:
 - 6825 Handset: Press **Delete** > **Add**.
 - 6823 Handset: Press **Unassign** > **Add**.
-



Delete an F-key or a speed dial

Procedure

- Step 1** Press **Menu** .
- Step 2**
- 6825 Handset: Select **F-Keys** .
 - 6823 Handset: Select **Speed Dial** .
- Step 3** Choose an entry and press **More**.
- Step 4**
- 6825 Handset: Select **Delete F-Key**.
 - 6823 Handset: Select **Delete Speed Dial**.
- Step 5** Press **Yes**.
-

Delete all F-keys or speed dials

Procedure

- Step 1** Press **Menu** .
- Step 2**
- 6825 Handset: Select **F-Keys** .
 - 6823 Handset: Select **Speed Dial** .
- Step 3** Press **More**.
- Step 4**
- 6825 Handset: Select **Delete all F-Keys**.
 - 6823 Handset: Select **Delete all Speed Dials**.
- Step 5** Press **Yes**.
-

View your speed dial list

Procedure

- Step 1** Press **Menu** .

- Step 2**
- 6825 Handset: Select **F-Keys** .
 - 6823 Handset: Select **Speed Dial** .
- Step 3** Press **More**.
- Step 4**
- 6825 Handset: Select **Speed dial**.
 - 6823 Handset: Select **Speed Dial**.
-

View your speed dial list



CHAPTER 8

Settings

- [Settings Menu](#), on page 75
- [Set the Ring Volume for an Incoming Call](#), on page 91
- [Change the Volume on a Call](#), on page 92

Settings Menu

You can customize your handset from the **Settings** menu.



Audio Settings Menu

Set Silent Mode from the Settings Menu

You can stop the handset from ringing where there is an incoming call. This is called silent mode.

When the handset is in silent mode, incoming calls display on the screen, but the handset does not play a ringtone.



Procedure

- Step 1** Press **Menu** .
- Step 2** Select **Settings**  > **Audio settings**.
- Step 3** Highlight **Silent**.
- Step 4** Press **Off** to allow the handset to ring or press **On** to disable ringing.
-

Set the Ring Volume from the Settings Menu

You can change the volume of the ringer. This volume does not impact the volume level when you are on a call.

Procedure

- Step 1** Press **Menu** .
- Step 2** Select **Settings**  > **Audio settings** > **Ring volume**.
- Step 3** Press right or left on the ring of the navigation cluster .
- Step 4** Press **Ok** to save the level.
-

Related Topics



[Set the Ring Volume for an Incoming Call](#), on page 91

Set the Ringtone For Different Call Types

You can set different ring tones for these types of calls:

- Normal call
- Normal message
- Urgent message
- Emergency High, Medium, and Low
- Alert

Procedure

- Step 1** Press **Menu** .
- Step 2** Select **Settings**  > **Audio settings**.
- Step 3** Choose the ringtone you want to change.
- 6823 Handset: Ring melody
 - 6825 Handset:
 - Ring melody
 - Ring normal msg
 - Ring urgent msg
 - Ring emergency
 - Ring emerg. high
 - Ring emerg. med
 - Ring emerg. low



- Alert tone

- Step 4** Press up or down on the ring of the navigation cluster  to highlight a tone.
- Step 5** Press **Play** to hear the tone.
- Step 6** Press **Select** to save the tone.
-

Set Ringtone for Loud Environment

You can set the loud ringtone to hear the handset in a noisy environment. This setting overrides the custom ringtone for a local contact. This setting however allows the handset volume adjustment and the handset in silent mode to ring.



Procedure

- Step 1** Press **Menu** .
- Step 2** Select **Settings**  > **Audio settings** > **Ring melody**.
- Step 3** Press up or down on the ring of the navigation cluster  to highlight **Loud Ringer**.
- Step 4** (Optional) Press **Play** to hear the tone.
- Step 5** Press **Select** to save the tone.
-

Set the Alert Volume

You can change the volume of the tone that you hear when you press **Emergency**  .
 You can't change the alert volume of the 6823 Handset.

Procedure



- Step 1** Press **Menu** .
- Step 2** Select **Settings**  > **Audio settings** > **Alert volume**.
- Step 3** Press right or left on the ring of the navigation cluster .
- Step 4** Press **Ok** to save the level.
-

Set the Handset Vibration Mode

You can set the handset to vibrate when you have an incoming call.

You can't set the 6823 Handset to vibrate mode.



Procedure

- Step 1** Press **Menu** .
- Step 2** Select **Settings**  > **Audio settings** > **Vibrate**.
- Step 3** Highlight your choice.
- **Off** (default): When an incoming call rings on the handset, the handset doesn't vibrate.
 - **Vibrate then ring**: When an incoming call rings on the handset, the handset vibrates and then rings.
 - **Vibrate only**: When an incoming call rings on the handset, the handset vibrates. You do not hear the ringtone.
 - **Vibrate and ring**: When an incoming call rings on the handset, the handset vibrates and rings at the same time.
- Step 4** Press **Select** to save the setting.
-

Set the Tone When a Key is Pressed

You can set the sound you hear when you press a key.



Procedure

- Step 1** Press **Menu** .
- Step 2** Select **Settings**  > **Audio settings** > **Key sound**.
- Step 3** Highlight your choice.
- **Silent** (default): When you press a key, you don't hear anything.
 - **Click**: When you press a key, you hear a click.
 - **Tone**: When you press a key, you hear a tone.
- Step 4** Press **Select** to save the setting.
-

Set the Confirmation Sound

You can set the handset to play a tone when you change a setting on the handset.

Procedure

- Step 1** Press **Menu** .
- Step 2** Select **Settings**  > **Audio Settings**.
- Step 3** Highlight **Confirmation sound**.
- Step 4** Press **Off** to stop the tone or press **On** to make the handset play the tone.
-



Set the Coverage Warning

If you walk while on a call, it's easy to move out of range of the base station or repeater. When you walk out of range, the call drops abruptly.

You can set up your handset to give you a tone when the signal from the base station or repeater becomes too weak. When you hear the tone, you'll know to move closer to the base station or repeater.

If you aren't on a call and walk out of range, you see  on the screen.



Procedure

- Step 1** Press **Menu** .
- Step 2** Select **Settings**  > **Audio Settings**.
- Step 3** Highlight **Coverage warning**.
- Step 4** Press **Off** to stop the tone or press **On** to make the handset play the tone.
-

Set the Charger Warning

You can set the handset to play a tone when you put the handset on the charger.

Procedure



- Step 1** Press **Menu** .
- Step 2** Select **Settings**  > **Audio Settings**.
- Step 3** Highlight **Charger warning**.
- Step 4** Press **Off** to stop the tone or press **On** to make the handset play the tone.
-

Time and Date Menu

Set the Time Format

You can set the way that the time displays on the handset.

Procedure



- Step 1** Press **Menu** .
- Step 2** Select **Settings**  > **Time & date** > **Time**.
- Step 3** Press **Format**.
- Step 4** Highlight your choice.
- **24 hour** (default): Display the time in 24-hour format.
 - **am/pm**: Display the time in 12-hour format.
- Step 5** Press **Select** to save the setting.
-

Set the Date Format

You can set the way the date displays on the handset.

In this procedure, the date August 24, 2018 is used for the choices. The choices display in the date on your handset.

Procedure

- Step 1** Press **Menu** .
- Step 2** Select **Settings**  > **Time & date** > **Date**.
- Step 3** Press **Format**.
- Step 4** Highlight your choice.
- **24-08-2018** (default): Display the date in dd-mm-yyyy format.
 - **08/24/2018**: Display the date in mm/dd/yyyy format.
 - **24-Aug-2018**: Display the date in dd-mmm-yyyy format.
 - **24/08/2018**: Display the date in dd/mm/yyyy format.
 - **24.08.2018**: Display the date in dd.mm.yyyy format.
 - **2018-08-24**: Display the date in yyyy-mm-dd format.
- Step 5** Press **Select** to save the setting.
-

Set the Handset Language

You can set the language for the handset display.



Procedure

- Step 1** Press **Menu** .
- Step 2** Select **Settings**  > **Language**.
- Step 3** Highlight any one of these languages:
- English
 - Español
 - Deutsch
 - Francais
 - Italiano
 - Dutch
 - Português
 - Dansk
 - Svenska
 - Turkece
 - Polski
 - Russian
 - Norsk
 - Slovenian
 - Cestina
 - Hrvatski
 - Srpski
 - Magyar
- Step 4** Press **Select** to save the setting.
-

Set the Handset LED

The LED at the top of the handset can light green, red, or yellow. You can set the color you want for specific situations.



Procedure

- Step 1** Press **Menu** .
- Step 2** Select **Settings**  > **LED signal**.
- Step 3** Select the LED choice.
- **Green LED**
 - **Orange LED**
 - **Red LED**
- Step 4** Highlight the choice for the LED to light.
- **Off**: The LED will not light up.
 - **Missed call**: The LED lights if you missed a call.
 - **Voice message**: The LED lights if you have a voicemail message.
 - **Low battery**: The LED lights if the handset battery is running out of power.
- Step 5** Press **Select** to save the setting.
-

Set the Timer to Turn Off the Screen

You can set the handset to turn off the screen after a specific amount of time. Before the screen turns off, it dims after a specific amount of inactivity.

Procedure

- Step 1** Press **Menu** .
- Step 2** Select **Settings**  > **Power save**.
- Step 3** Highlight your choice.
- **5 seconds**: The screen dims after 2 seconds and turns off after 5 seconds.
 - **10 seconds**: The screen dims after 5 seconds and turns off after 10 seconds.
 - **20 seconds**: The screen dims after 5 seconds and turns off after 20 seconds.
 - **30 seconds**: The screen dims after 10 seconds and turns off after 30 seconds.
 - **45 seconds**: The screen dims after 10 seconds and turns off after 45 seconds.
 - **60 seconds**: The screen dims after 10 seconds and turns off after 60 seconds.
- Step 4** Press **Select** to save the setting.
-

Security Menu

Set the Handset Lock and PIN



You can set up the handset to require a PIN to unlock it.



Note When the keypad is locked, you can only dial emergency numbers.

The default PIN is 0000.

Procedure

- Step 1** Press **Menu** .
- Step 2** Select **Settings**  > **Security** > **Phone lock**.
- Step 3** Enter the PIN and press **OK**.
- Step 4** Highlight **Phone lock**.
- Step 5** Press **Off** to turn off the need for a PIN or **On** to require a PIN.
- Step 6** Select **Change PIN**.
- Step 7** Enter a new PIN and press **OK**.
- You must use four digits for the PIN.
- Step 8** Press **Select** to save the setting.
-

Related Topics

[Lock the handset keypad](#), on page 8

[Unlock the handset keypad](#), on page 8

Set the Timer to Automatically Lock the Handset

You can set the handset to lock the keypad after a specific length of inactivity. When the keypad locks, you need to unlock it before you can use it.



Note When the keypad is locked, you can only dial emergency numbers.

Procedure

- Step 1** Press **Menu** .

- Step 2** Select **Settings**  > **Security** > **Automatic keylock**.
- Step 3** Highlight your choice.
- **Off** (default): The keypad never locks.
 - **15 seconds**: The keypad locks in 15 seconds.
 - **30 seconds**: The keypad locks in 30 seconds.
 - **45 seconds**: The keypad locks in 45 seconds.
 - **1 minute**: The keypad locks in 1 minute.
 - **2 minutes**: The keypad locks in 2 minutes.
 - **3 minutes**: The keypad locks in 3 minutes.
 - **4 minutes**: The keypad locks in 4 minutes.
 - **5 minutes**: The keypad locks in 5 minutes.
- Step 4** Press **Select** to save the setting.

Related Topics

[Lock the handset keypad](#), on page 8



[Unlock the handset keypad](#), on page 8

Change the Settings PIN

You can set the handset to require a PIN before the handset can reset to the default settings.

The default PIN is 0000.



Procedure

- Step 1** Press **Menu** .
- Step 2** Select **Settings**  > **Security** > **Change PIN**.
- Step 3** Enter the current PIN and press **OK**.
- Step 4** Enter a new PIN and press **OK**.
- You must use four digits for the PIN.
- Step 5** Press **Select** to save the setting.
-

Set the Handset Name

You can give the handset a name. The name displays on the main screen of the handset.



Procedure

- Step 1** Press **Menu** .
- Step 2** Select **Settings**  > **Handset name**.
- Step 3** Enter a name using the keypad.
- Step 4** (Optional) If you need special symbols, press **Symbol** or the center softkey, navigate to the required symbol, and press **Select**.
- Step 5** (Optional) If you want to delete the last character, press **Clear** .
- Step 6** Press **Save**.
-

Select Your Default Line

If you have multiple lines, you can select the line that you want to use as your primary line. You can select your secondary line when you need to use it.



Procedure

- Step 1** Press **Menu** .
- Step 2** Select **Settings**  > **Line**.
- Step 3** Highlight the line you want to use as the primary line.
- Step 4** Press **Save**.
-

Set Auto Answer

You can set the way that the handset handles incoming calls.

Procedure

- Step 1** Press **Menu** .
- Step 2** Select **Settings**  > **Auto answer**.
- Step 3** Highlight your choice.
- **Normal** (default): You press **Answer/Send**  to answer the call.
 - **Any key**: You can press any key to answer the call.

- **Automatic:** The incoming call is automatically answered.

Step 4 Press **Select** to save the setting.

Allow the Handset to Ring While Charging

If you don't want the handset to ring while it is charging, you can turn off the ringer. Incoming calls continue to display on the screen.

Procedure

Step 1 Press **Menu** .

Step 2 Select **Settings**  > **Silent charging**.

Step 3 Highlight your choice.

- **Off** (default): The handset will ring while on the charger.
- **Silent:** The handset won't ring will on the charger.

Step 4 Press **Select** to save the setting.

Set Do Not Disturb

You can set the handset to not disturb you when you get an incoming calls. This is called do not disturb (DND) mode. When you are in this mode, you see the DND icon  in the screen headers. If you get a call while DND is active, the call is sent to voicemail.

While in DND, many of the icons that display on the header are different from normal.

To use this feature, your administrator must enable DND.

Procedure

Step 1 Press **Menu** .

Step 2 Select **Settings**  > **Do not disturb**.

Step 3 Highlight your choice.

- **Disabled** (default): DND mode is off.
- **Enabled:** DND mode is on.

Step 4 Press **Select** to save the setting.

Related Topics



[Turn do not disturb on and off with a star code](#), on page 47

[Header Icons](#), on page 14

Hide Your Caller ID When You Make a Call

Under normal circumstances, your handset sends your Caller ID (name and phone number) when you make a call. You can set your handset to make a call without the Caller ID for the next call or for all calls.

Procedure

-
- Step 1** Press **Menu** .
- Step 2** Select **Settings**  > **Hide number**.
- Step 3** Highlight your choice.
- **Off** (default): Your Caller ID is always sent.
 - **On for next call**: Your Caller ID is not sent for the next call. Subsequent calls will have the Caller ID sent.
 - **Always On**: Your handset never sends the Caller ID.
- Step 4** Press **Select** to save the setting.
-

Related Topics



[Block and unblock outgoing caller information with a star code](#), on page 47

Call Forward Menu

Set Call Forward Unconditional

You can set your handset to forward all calls to a specific phone number. When your handset is forwarded, you see the call forward icon  on the screen header.

Procedure

-
- Step 1** Press **Menu** .
- Step 2** Select **Settings**  > **Call Forward** > **Forward Unconditionally**.
- Step 3** Highlight **Forward Unconditionally**.
- Step 4** Press **Off** to turn the feature off or press **On** to turn the feature on.
- Step 5** Highlight **Forward To** and enter the phone number to receive the call.

Step 6 Press **Select** to save the setting.



Related Topics

[Activate and deactivate call forward all with star codes](#), on page 46

Set Call Forward When There is No Answer

You can set your handset to forward unanswered calls to a specific phone number. When your handset is forwarded, you see the call forward icon  on the screen header.



Procedure

- Step 1** Press **Menu** .
- Step 2** Select **Settings**  > **Call Forward** > **Forward No Answer**.
- Step 3** Highlight **Forward No Answer**.
- Step 4** Press **Off** to turn the feature off or press **On** to turn the feature on.
- Step 5** Highlight **Forward To** and enter the phone number to receive the call.
- Step 6** Highlight **Forward After (s)** and enter the time in seconds to wait before the call is forwarded.
- Step 7** Press **Select** to save the setting.
-

Set Call Forward When the Line is Busy

You can set your handset to forward calls to a specific phone number when you are on a call (busy). When your handset is forwarded, you see the call forward icon  on the screen header.



Procedure

- Step 1** Press **Menu** .
- Step 2** Select **Settings**  > **Call Forward** > **Forward Busy**.
- Step 3** Highlight **Forward Busy**.
- Step 4** Press **Off** to turn the feature off or press **On** to turn the feature on.
- Step 5** Highlight **Forward To** and enter the phone number to receive the call.
- Step 6** Press **Select** to save the setting.
-

Set the Idle Screen Saver

When the handset is in the charger, you can control the screen display.



Procedure

- Step 1** Press **Menu** .
- Step 2** Select **Settings**  > **Idle Screen Saver**.
- Step 3** Highlight your choice.
- **Off** (default): The screen turns off at the time set in [Set the Timer to Turn Off the Screen, on page 82](#).
 - **Idle clock (dimmed)**: The screen displays the dimmed clock.
 - **Startup image (dimmed)**: The screen displays the dimmed start up graphic.
- Step 4** Press **Select** to save the setting.
-

Set the Idle Clock

You can control if the time displays on the home screen when the handset is idle.

Procedure

- Step 1** Press **Menu** .
- Step 2** Select **Settings**  > **Idle Clock**.
- Step 3** Highlight your choice.
- **Off**: The time doesn't display on the home screen.
 - **On** (default): The time displays on the home screen.
- Step 4** Press **Select** to save the setting.
-

Bluetooth Menu

You can use a Bluetooth® headset with your handset. To use the headset, you need to turn Bluetooth on and pair (connect) the headset to the handset.

The 6823 Handset doesn't support Bluetooth.

Bluetooth and your handset



Bluetooth connections work best when you're within 3 to 6 feet (1 to 2 meters) from your handset, but you might be able to be as far away as 66 feet (20 meters). The Bluetooth connection can degrade if you have a barrier (wall, door, window), large metal object, or other electronic devices between your handset and the connected device.

Enable Bluetooth

You can use a Bluetooth® headset with your handset. By default, Bluetooth is turned off. When Bluetooth is enabled, the handset uses more battery power.

When Bluetooth is enabled, you see the Bluetooth icon  displayed in the screen header. The icon changes when you have a Bluetooth headset paired to the handset.

Procedure

- Step 1** Press **Menu** .
- Step 2** Select **Settings**  > **Bluetooth** > **Enable/disable**.
- Step 3** Press **Yes** to enable Bluetooth or **No** to disable Bluetooth.
-

Search and pair a Bluetooth device



You can display a list of paired Bluetooth® devices.

Procedure

- Step 1** Press **Menu** .
- Step 2** Select **Settings**  > **Bluetooth** > **Search for devices**.
- Step 3** Highlight your headset in the list and press **Select**.
-

Manage the paired Bluetooth devices

Procedure

- Step 1** Press **Menu** .
- Step 2** Select **Settings**  > **Bluetooth** > **Paired devices**.
- Step 3** Highlight the headset you want to manage and do one of these actions:
- Press **Disconnect** to disconnect the connected headset. The headset remains paired to the handset, but not active. You need to press **Connect** to connect again to the headset.
 - Press **More** and select **Change name** to edit the name of the headset.
 - Press **More** and select **Delete all** to delete (unpair) all the headsets in the list. You need to confirm the deletion.



- Press **More** and select **Delete** to delete (unpair) the headset from the list. You need to confirm the deletion.
- Press **More** and select **Info** to view more information about the headset.

Turn on Push To Talk

You can use the handset as a two-way radio to talk with other active handsets in the system. You press a specific button to start and end a conversation, so the feature is called Push to Talk.

Before you can use the feature, you need to enable it on your handset.

Procedure

- Step 1** Press **Menu** .
- Step 2** Select **Settings**  > **Push to Talk**.
- Step 3** Highlight your choice.
- **Off** (default): You can't use Push to Talk.
 - **On**: You can use Push to Talk.
- Step 4** Press **Select** to save the setting.

Related Topics

[Use Push to Talk](#), on page 48

Set the Ring Volume for an Incoming Call

Procedure



While the handset is ringing, press **Volume** up or down.

Related Topics

[Set the Ring Volume from the Settings Menu](#), on page 75

Change the Volume on a Call

Procedure



While on a call, press **Volume** up or down.



CHAPTER 9

Accessories

- [Supported Headsets](#), on page 93
- [Important Headset Safety Information](#), on page 93
- [Audio Quality](#), on page 94

Supported Headsets

You can use these types of headsets with your handset:

- Headset with a 3.5 mm audio plug
- Bluetooth LE headset



Note The 6823 Handset doesn't support Bluetooth.

Related Topics

[Bluetooth Menu](#), on page 89

Important Headset Safety Information



High Sound Pressure—Avoid listening to high volume levels for long periods to prevent possible hearing damage.

When you plug in your headset, lower the volume of the headset speaker before you put the headset on. If you remember to lower the volume before you take the headset off, the volume will start lower when you plug in your headset again.

Be aware of your surroundings. When you use your headset, it may block out important external sounds, particularly in emergencies or in noisy environments. Don't use the headset while driving. Don't leave your headset or headset cables in an area where people or pets can trip over them. Always supervise children who are near your headset or headset cables.

Audio Quality

Beyond physical, mechanical, and technical performance, the audio portion of a headset must sound good to the user and to the party on the far end. Sound quality is subjective, and we cannot guarantee the performance of any third-party headset. However, various headsets from leading headset manufacturers are reported to perform well with Cisco IP Phones.

Cisco doesn't recommend or test any third-party headsets with their products. For information about third-party headset support for Cisco products, go to the manufacturer's web site.

Cisco does test the Cisco headsets with the Cisco IP Phones. For information about Cisco Headsets and Cisco IP Phone support, see <https://www.cisco.com/c/en/us/products/collaboration-endpoints/headsets/index.html>.



CHAPTER 10

Troubleshooting

- [General Troubleshooting, on page 95](#)
- [View the Handset Status, on page 98](#)
- [Reset the Handset Settings, on page 98](#)

General Troubleshooting

You can use this chapter to troubleshoot common problems that you might encounter.

Handset Won't Turn On



Problem

The handset has a battery installed but won't turn on.

Cause

The battery doesn't have sufficient charge, the plastic tab over the battery contacts aren't removed, or the battery has failed.

Solution

1. Place the handset in the charger and monitor it. If the screen turns on after a few minutes, the battery was depleted and needs to be fully charged. You can confirm the battery level from the **Menu**  > **Settings**  > **Status** screen while the handset is in the charger.

This happens if the handset hasn't been used for a long period of time.

2. If the handset won't turn on after 10 minutes on the charger, remove the battery and replace it with a battery that you know is charged. If the handset now works, the battery may have failed.

Handset Won't Stay On

Problem

The handset won't stay powered on when not in the charging cradle. When in the charging cradle, the handset turns on.

Solution

Check:

- Does the handset have a battery installed? You can use the handset in the cradle with no battery, but it needs the battery as soon as you remove it from the cradle.
- If the handset is new, has the plastic tab over the battery contacts been removed?
- Have you tried to use the handset with a charged battery from another handset?

Handset Doesn't Ring

Problem

The phone can receive calls but no ringtone is heard.

Cause

The phone may be in silent mode and the silent mode icon  is displayed in the screen header.

Solution

- Increase the volume from the **Settings**  menu.
- Press and hold the pound (#) key for two seconds while the phone is idle to disable silent mode.

Handset Doesn't Respond to Key Presses

Problem

Nothing happens when you press a key on the handset.

Cause

The keypad is probably locked.

Solution

Press and hold the star (*) key for 2 seconds to unlock the keypad.

Handset Beeps Continuously While in the Charger

Problem

The handset beeps continuously when placed in the charger.

Solution

Check these scenarios:

- The handset wasn't placed in the charger so that the contacts on the handset and charger touched.
- The handset is new and this is the first time it has been placed on the charger. Check that the plastic on the battery has been removed.

If none of the scenarios apply, the battery may be defective. Put a battery that you know works into the handset and place the handset in the charger. If the handset doesn't beep, then the original battery is defective.

Handset Screen Displays "Searching"

Problem

The handset displays the message `Searching`.

Cause

The handset is too far from the closest base station or the base station isn't active.

Solution

- If the handset has been stationary, the base station may be rebooting or inactive.
 1. Wait a couple of minutes to see if the handset can communicate with the base station.
 2. If the problem persists, check that the base station has power and the LED is green. If the handset power was off while searching for the base station, it takes more time to register after the handset power is on.
- If the handset has been carried around, it may be out of range of the base station.
 - Short term solution: Move the handset closer to the base station.
 - Long term solution for system with one single cell base station:
 - Add another 110 Single-Cell Base Station to set up a dualcell system.
 - Add repeaters to improve coverage.
 - Long term solution for dualcell system: Change the base stations to 210 Multi-Cell Base Station or add repeaters to improve coverage.

View the Handset Status

You can see the status of your handset to assist in troubleshooting problems. Information includes the firmware version installed on the handset as well as information about the connected base station.



Procedure

- Step 1** Press **Menu** .
- Step 2** Select **Settings**  > **Status**.
-

Reset the Handset Settings

Your administrator may ask you to reset your handset. When this happens, your user settings (for example, Setting menu, Local contacts, Speed dials) are deleted, but the handset remains registered with the base station.

Procedure

- Step 1** Press **Menu** .
- Step 2** Select **Settings**  > **Reset settings**.
- Step 3** Press **Yes** to confirm the reset.
- Step 4** If prompted, enter the handset PIN.
- Step 5** Press **Ok**.
-



CHAPTER 11

Product Safety and Security

- [Safety and Performance Information, on page 99](#)
- [Compliance Statements, on page 102](#)
- [Cisco Product Security Overview, on page 105](#)
- [Important Online Information, on page 105](#)

Safety and Performance Information

Read the following safety notices before installing or using your IP phone.



Warning IMPORTANT SAFETY INSTRUCTIONS

This warning symbol means danger. You are in a situation that could cause bodily injury. Before you work on any equipment, be aware of the hazards involved with electrical circuitry and be familiar with standard practices for preventing accidents. Use the statement number provided at the end of each warning to locate its translation in the translated safety warnings that accompanied this device. Statement 1071

SAVE THESE INSTRUCTIONS

To see translations of the warnings that appear in this publication, refer to the statement number in the *Regulatory Compliance and Safety Information—Cisco IP DECT 6800 Series* at the following URL:
https://www.cisco.com/c/dam/en/us/td/docs/voice_ip_comm/cuipph/MPP/6800-DECT/RCSI/RCSI-0366-book.pdf



Warning Read the installation instructions before using, installing, or connecting the system to the power source. Statement 1004

Warning Voice over IP (VoIP) service and the emergency calling service do not function if power fails or is disrupted. After power is restored, you might have to reset or reconfigure equipment to regain access to VoIP and the emergency calling service. In the USA, this emergency number is 911. You need to be aware of the emergency number in your country. Statement 361



Warning Ultimate disposal of this product should be handled according to all national laws and regulations. Statement 1040



Warning The plug-socket combination must be accessible at all times because it serves as the main disconnecting device. Statement 1019

Safety Guidelines

The following are safety guidelines for using the Cisco IP DECT 6800 Series in specific environments:

- Do not use this product as the primary communications tool in healthcare environments, as it may use an unregulated frequency band that is susceptible to interference from other devices or equipment.
- The use of wireless devices in hospitals is restricted to the limits set forth by each hospital.
- The use of wireless devices in hazardous locations is limited to the constraints posed by the safety directors of such environments.
- The use of wireless devices on airplanes is governed by the Federal Aviation Administration (FAA).

Battery Safety Notices

These battery safety notices apply to the batteries that are approved for the Cisco IP DECT 6800 Series.



Warning There is the danger of explosion if the battery is replaced incorrectly. Replace the battery only with the same or equivalent type recommended by the manufacturer. Dispose of used batteries according to the manufacturer's instructions. Statement 1015



Warning Do not touch or bridge the metal contacts on the battery. Unintentional discharge of the batteries can cause serious burns. Statement 341



Warning Explosion Hazard: Do not charge the phone battery in a potentially explosive environment. Statement 431



Warning Lithium ion batteries have limited lifetimes. Any lithium ion battery that shows any signs of damage, including swelling, should be properly discarded immediately.

**Caution**

- Do not dispose of the battery pack in fire or water. The battery may explode if placed in a fire.
- Do not disassemble, crush, puncture, or incinerate the battery pack.
- Handle a damaged or leaking battery with extreme care. If you come in contact with the electrolyte, wash the exposed area with soap and water. If the electrolyte has come in contact with the eye, flush the eye with water for 15 minutes and seek medical attention.
- Do not charge the battery pack if the ambient temperature exceeds 104 degrees Fahrenheit (40 degrees Celsius).
- Do not expose the battery pack to high storage temperatures (above 140 degrees Fahrenheit, 60 degrees Celsius).
- When discarding a battery pack, contact your local waste disposal provider regarding local restrictions on the disposal or recycling of batteries.

To obtain a battery, contact your local dealer. Use only the batteries that have a Cisco part number.

Power Outage

The ability to access emergency service through the phone depends on the base stations being powered. If there is an interruption in the power supply, Service and Emergency Calling Service dialing will not function until power is restored. In the case of a power failure or disruption, you may need to reset or reconfigure equipment before using the Service or Emergency Calling Service dialing.

Regulatory Domains

The radio frequency (RF) for the handset is controlled by the base station. The base station is configured for a specific regulatory domain. If you use this system outside of the specific regulatory domain, the system will not function properly, and you might violate local regulations.

Health-Care Environments

This product is not a medical device and uses an unlicensed frequency band that is susceptible to interference from other devices or equipment.

External Devices Usage

The following information applies when you use external devices with the DECT handset.

Cisco recommends the use of good quality external devices (such as headsets) that are shielded against unwanted radio frequency (RF) and audio frequency (AF) signals.

Depending on the quality of these devices and their proximity to other devices such as mobile phones or two-way radios, some audio noise may still occur. In these cases, Cisco recommends that you take one or more of the following actions:

- Move the external device away from the source of the RF or AF signals.

- Route the external device cables away from the source of the RF or AF signals.
- Use shielded cables for the external device, or use cables with a better shield and connector.
- Shorten the length of the external device cable.
- Apply ferrites or other such devices on the cables for the external device.

Cisco cannot guarantee the performance of the system because Cisco has no control over the quality of external devices, cables, and connectors. The system will perform adequately when suitable devices are attached using good quality cables and connectors.



Caution In European Union countries, use only external headsets that are fully compliant with the EMC Directive [89/336/EC].

System Behavior During Times of Network Congestion

Anything that degrades network performance can affect phone system voice quality, and in some cases, can cause a call to drop. Sources of network degradation can include, but are not limited to, the following activities:

- Administrative tasks, such as an internal port scan or security scan
- Attacks that occur on your network, such as a Denial of Service attack

Product Label

The product label is located in the battery compartment of the device.

Compliance Statements

Compliance Statements for the European Union

CE Marking

The following CE mark is affixed to the equipment and packaging.



RF Exposure Statement for the European Union

This device has been evaluated and found compliant in accordance with EU EMF Directive 2014/53/EU.

Compliance Statements for the USA

General RF Exposure Compliance

This device has been evaluated and found compliant to the ICNIRP (International Committee on Non-Ionizing Radiation Protection) limits for Human Exposure of RF Exposure.

Part 15 Radio Device

**Caution**

The Part 15 radio device operates on a non-interference basis with other devices operating at this frequency. Any changes or modification to said product not expressly approved by Cisco, including the use of non-Cisco antennas, could void the user's authority to operate this device.

Compliance Statements for Canada

This device complies with Industry Canada license-exempt RSS standard(s). Operation is subject to the following two conditions: (1) this device may not cause interference, and (2) this device must accept any interference, including interference that may cause undesired operation of the device. Privacy of communications may not be ensured when using this phone.

This product meets the applicable Innovation, Science and Economic Development Canada technical specifications.

Avis de Conformité Canadien

Cet appareil est conforme aux normes RSS exemptes de licence RSS d'Industry Canada. Le fonctionnement de cet appareil est soumis à deux conditions : (1) ce périphérique ne doit pas causer d'interférence et (2) ce périphérique doit supporter les interférences, y compris celles susceptibles d'entraîner un fonctionnement non souhaitable de l'appareil. La protection des communications ne peut pas être assurée lors de l'utilisation de ce téléphone.

Le présent produit est conforme aux spécifications techniques applicables d'Innovation, Sciences et Développement économique Canada.

Canadian RF Exposure Statement

THIS DEVICE MEETS THE LIMITS AS REFERENCED BY ISED RSS-102 R5 FOR EXPOSURE TO RADIO WAVES

Your device includes a radio transmitter and receiver. It is designed not to exceed the General populace (uncontrolled) limits for exposure to radio waves (radio frequency electromagnetic fields) as referenced in RSS-102 which references Health Canada Safety Code 6 and include a substantial safety margin designed to assure the safety of all persons, regardless of age and health.

As such the systems are designed to be operated as to avoid contact with the antennas by the end user. It is recommended to set the system in a location where the antennas can remain at least a minimum distance as specified from the user in accordance to the regulatory guidelines which are designed to reduce the overall exposure of the user or operator.

The device has been tested and found compliant with the applicable regulations as part of the radio certification process.

Déclaration d'Exposition aux RF Canadienne

CE PÉRIPHÉRIQUE RESPECTE LES LIMITES DÉCRITES PAR LA NORME RSS-102 R5 D'EXPOSITION À DES ONDES RADIO

Votre appareil comprend un émetteur et un récepteur radio. Il est conçu pour ne pas dépasser les limites applicables à la population générale (ne faisant pas l'objet de contrôles périodiques) d'exposition à des ondes radio (champs électromagnétiques de fréquences radio) comme indiqué dans la norme RSS-102 qui sert de référence au règlement de sécurité n°6 sur l'état de santé du Canada et inclut une marge de sécurité importantes conçue pour garantir la sécurité de toutes les personnes, quels que soient leur âge et état de santé.

En tant que tels, les systèmes sont conçus pour être utilisés en évitant le contact avec les antennes par l'utilisateur final. Il est recommandé de positionner le système à un endroit où les antennes peuvent demeurer à au moins une distance minimum préconisée de l'utilisateur, conformément aux instructions des réglementations qui sont conçues pour réduire l'exposition globale de l'utilisateur ou de l'opérateur.

Le périphérique a été testé et déclaré conforme aux réglementations applicables dans le cadre du processus de certification radio.

Compliance Statements for New Zealand

Permit to Connect (PTC) General Warning

The grant of a Telepermit for any item of terminal equipment indicates only that Spark NZ has accepted that the item complies with minimum conditions for connection to its network. It indicates no endorsement of the product by Spark NZ, nor does it provide any sort of warranty. Above all, it provides no assurance that any item will work correctly in all respects with another item of Telepermitted equipment of a different make or model, nor does it imply that any product is compatible with all of Spark NZ network services.

Use of IP Networks with the PSTN

Internet Protocol (IP) by its nature introduces delay into speech signals as each data packet is formulated and addressed. Spark NZ Access Standards recommends that suppliers, designers and installers using this technology for calls to or from the PSTN refer to ITU E Model requirements in the design of their networks. The overall aim is to minimise delay, distortion and other transmission impairments, particularly for those calls involving cellular and international networks, which already suffer extensive delay.

The Use of Voice Compression Through the PSTN

Because of the extensive delay already experienced when calling cellular and international networks, some of which is already caused by their use of voice compression technologies. Spark NZ Access Standards will only approve G711 voice technology for use on the PSTN. G711 is an 'instantaneous speech-encoding technique' whereas G729 and all its variants are considered 'near instantaneous' introducing additional delay into the speech signal.

Echo Cancellation

Echo cancelers are not normally required in the Spark NZ PSTN because geographic delays are acceptable where CPE return loss is maintained within Telepermit limits. However, those private networks that make use of Voice-over-IP (VoIP) technology are required to provide echo cancellation for all voice calls. The combined effect of audio/VoIP conversion delay and IP routing delay can cause the echo cancellation time of 64 ms to be required.

Compliance Statements for Taiwan

DGT Warning Statement

Compliance Statement for Argentina

Advertencia

No utilizar una fuente de alimentación con características distintas a las expresadas ya que podría ser peligroso.

Compliance Statement for Singapore

**Complies with
IMDA Standards
DB101992**

Cisco Product Security Overview

This product contains cryptographic features and is subject to U.S. and local country laws that govern import, export, transfer, and use. Delivery of Cisco cryptographic products does not imply third-party authority to import, export, distribute, or use encryption. Importers, exporters, distributors, and users are responsible for compliance with U.S. and local country laws. By using this product, you agree to comply with applicable laws and regulations. If you are unable to comply with U.S. and local laws, return this product immediately.

Further information regarding U.S. export regulations can be found at <https://www.bis.doc.gov/policiesandregulations/ear/index.htm>.

Important Online Information

End User License Agreement

The End User License Agreement (EULA) is located here: <https://www.cisco.com/go/eula>

Regulatory Compliance and Safety Information

Regulatory Compliance and Safety Information (RCSI) is located here:

https://www.cisco.com/c/dam/en/us/td/docs/voice_ip_comm/cuipph/MPP/6800-DECT/RCSI/RCSI-0366-book.pdf

