

**Jabra** GN

INSTALLATION MANUAL



# PANACAST 50

## Video Bar System

Technology for life's new rhythm

© 2023 GN Audio A/S. All rights reserved. Jabra® is a trademark of GN Audio A/S. The Bluetooth® word mark and logos are registered trademarks owned by the Bluetooth SIG, Inc. and any use of such marks by GN Audio A/S is under license.

---

Made in China

MODEL: VSM040; VTD040



---

**Declaration of Conformity** can be found on [www.jabra.com/doc](http://www.jabra.com/doc)

1. Welcome.....	5	4.4 Installation height	
2. Overview.....	6	5. Cabling.....	20
2.1 Jabra PanaCast 50 Video Bar System Base Unit overview		5.1 Room system cabling	
2.2 Jabra PanaCast Control overview		5.2 Video bar cabling	
2.3 Included accessories - Jabra PanaCast 50 Video Bar System Base Unit		5.3 Touch controller cabling	
2.4 Included accessories - Jabra PanaCast Control		6. Configuring.....	25
2.5 Optional accessories		6.1 Configuration using the touch controller	
2.6 Dimensions - Jabra PanaCast 50 Video Bar System Base Unit		6.2 Configuration using the video bar	
2.7 Dimensions - Jabra PanaCast Control		7. Pairing.....	28
3. Room setup guide.....	15	8. Remote management.....	29
4. Mounting.....	16	9. Software.....	30
4.1 Wall mount installation		9.1 Operating system	
4.2 Screen mount installation		9.2 Microsoft Teams and Teams Rooms	
4.3 Table stand installation		9.3 Zoom and Zoom Rooms	

10.Restart devices.....	31
11.Factory reset .....	34
12.Support .....	37
12.1FAQ and technical specifications	
12.2How to care for your Jabra device	

# 1. Welcome

Thank you for choosing the Jabra PanaCast 50 Video Bar System. We hope you will enjoy it!

Here are some key features you will benefit from by using the Jabra PanaCast 50 Video Bar System:

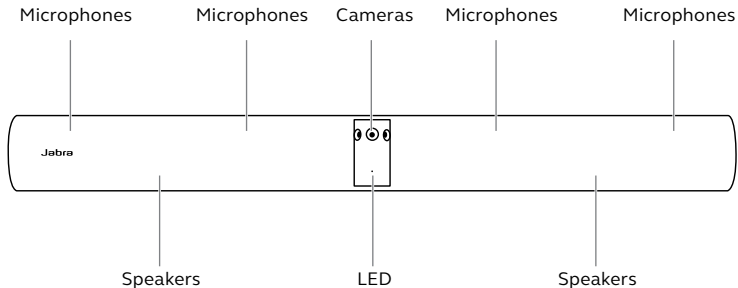
- World-class audio with full duplex and powerful stereo speakers
- Unique 180° full room coverage in high-definition Panoramic-4K for a more natural view of the meeting room
- Access to an easier meeting experience with the touchscreen-activated PanaCast Control
- Certified for the strict requirements of Microsoft Teams Rooms and Zoom Rooms to connect, share, and collaborate seamlessly and securely
- On-device AI that powers a range of intelligent features for immersive and natural virtual collaboration

## 2. Overview

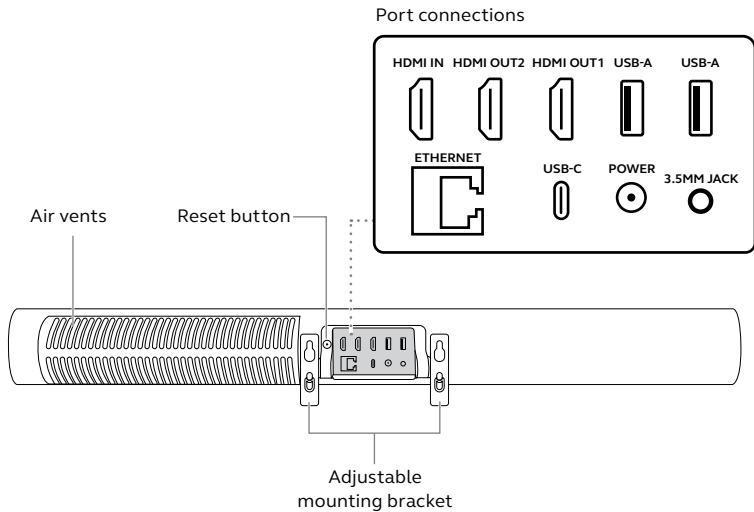
### 2.1 Jabra PanaCast 50 Video Bar System Base Unit overview

---

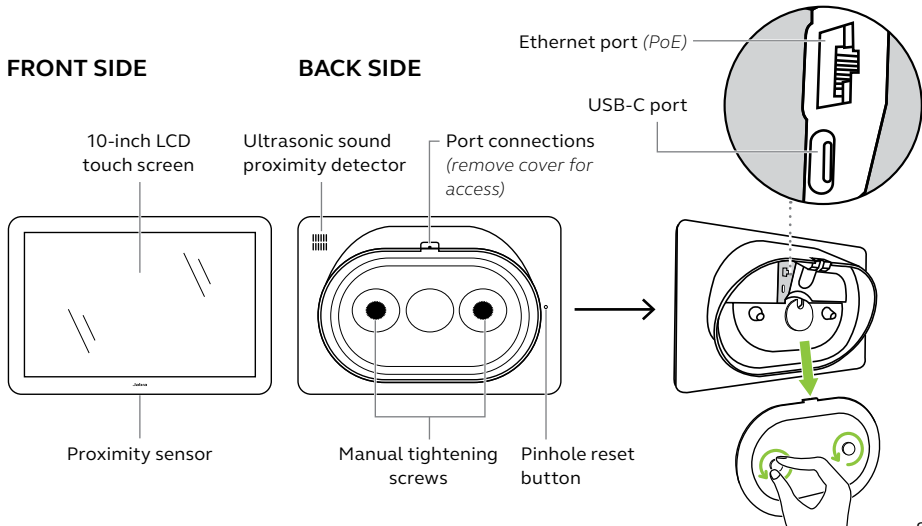
#### FRONT SIDE



## BACK SIDE



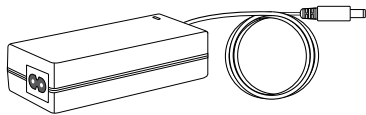
## 2.2 Jabra PanaCast Control overview



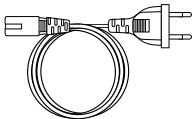


## 2.3 Included accessories - Jabra PanaCast 50 Video Bar System Base Unit

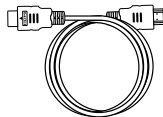
---



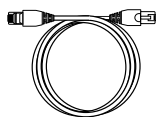
**AC power adapter** (1.83m/6ft)



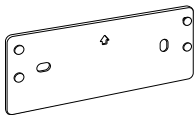
**AC power cable**  
(1m/3.28ft)



**HDMI cable**  
(1.83m/6ft)



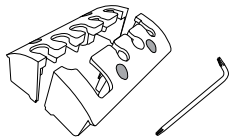
**RJ45 Ethernet cable**  
(4.57m/15ft)



**Wall mount**



**Camera privacy cover**

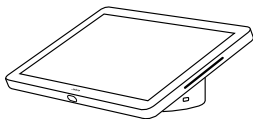


**Cable cover compartment** (2 pcs)  
with embedded screws  
& screwdriver

Additional accessories can be purchased at [jabra.com/accessories](https://jabra.com/accessories).

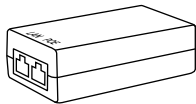
## 2.4 Included accessories - Jabra PanaCast Control

---

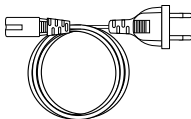


**Jabra PanaCast Control**

### **POWER OVER ETHERNET (PoE) KIT**



**PoE injector**



**AC power cable**  
(1m/3.28ft)



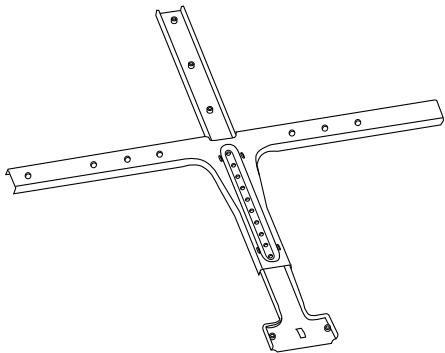
**RJ45 Ethernet cable (2 pcs)**  
(4.57m/15ft)

Additional accessories can be purchased at [jabra.com/accessories](https://jabra.com/accessories).

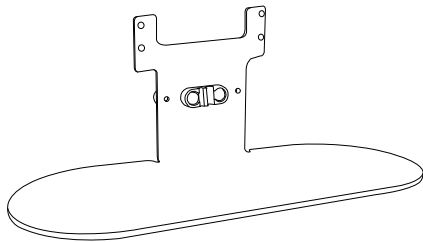
## 2.5 Optional accessories

---

Accessories can be purchased at [jabra.com/accessories](https://www.jabra.com/accessories).

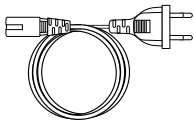


**Screen mount**

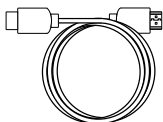


**Table stand**

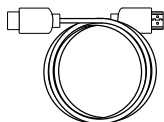
Accessories can be purchased at [jabra.com/accessories](https://jabra.com/accessories).



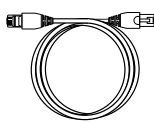
**Regional power  
cords**  
(1m/3.28ft)



**HDMI cable**  
(1.83m/6ft)



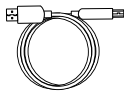
**HDMI ingest  
cable**  
(4.57m/15ft)



**RJ45 Ethernet  
cable**  
(4.57m/15ft)



**USB-A to C cable**  
(4.57m/15ft)

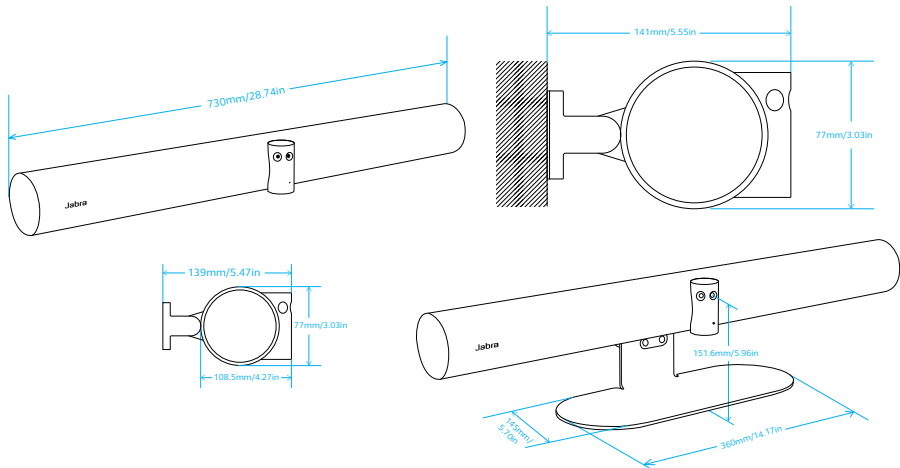


**USB-A to B cable**  
(1.83m/6ft)



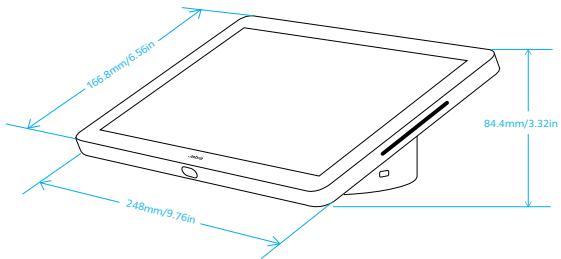
**Jabra PanaCast Control  
table mount**

## 2.6 Dimensions - Jabra PanaCast 50 Video Bar System Base Unit



## 2.7 Dimensions - Jabra PanaCast Control

---



### 3. Room setup guide

The Jabra PanaCast 50 Video Bar System is designed for meeting rooms up to 4.5 meters x 6 meters (15 feet x 20 feet).

View the Room setup guide PDF here: [jabra.com/help/panacast50vbs/getstarted](https://jabra.com/help/panacast50vbs/getstarted)

Below are some typical room setup scenarios.

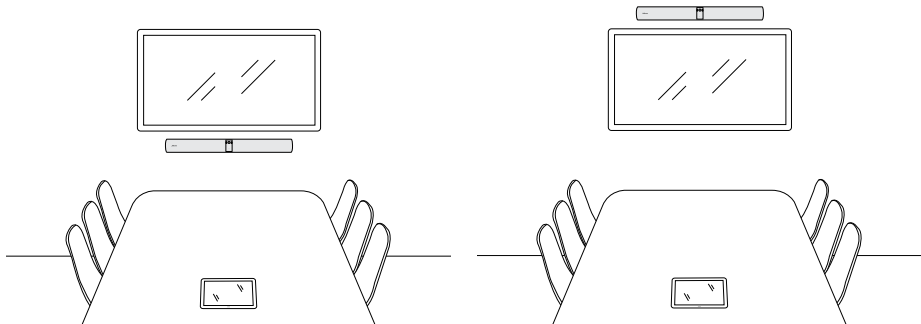


# 4. Mounting

## 4.1 Wall mount installation

---

View the wall mount assembly video and PDF here: [jabra.com/help/panacast50vbs/getstarted](https://jabra.com/help/panacast50vbs/getstarted)



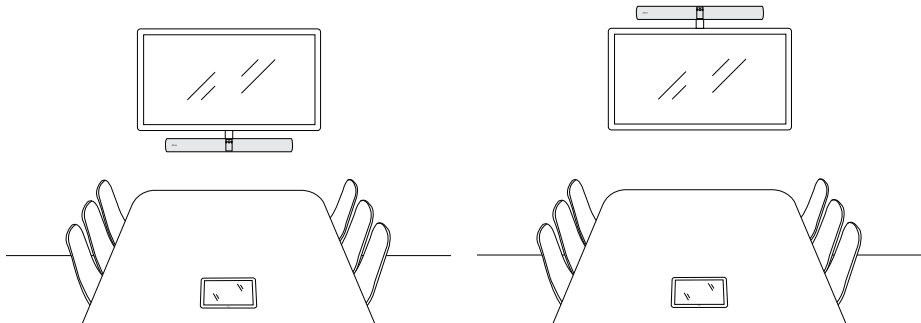


## 4.2 Screen mount installation

---

The screen mount is designed for screens up to 220 centimeters (86 inches) and VESA mounts up to 600 millimeters.

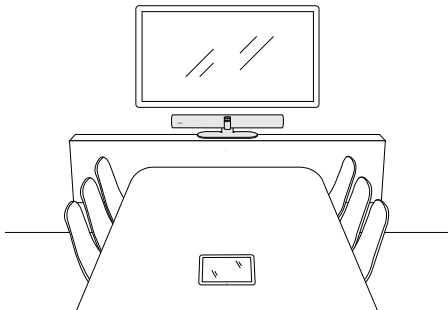
View the screen mount assembly video and PDF here: [jabra.com/help/panacast50vbs/getstarted](https://jabra.com/help/panacast50vbs/getstarted)



## 4.3 Table stand installation

---

View the table stand assembly video and PDF here: [jabra.com/help/panacast50vbs/getstarted](https://jabra.com/help/panacast50vbs/getstarted)

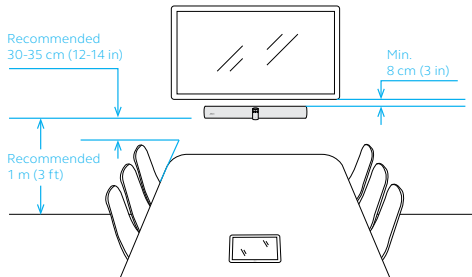


## 4.4 Installation height

---

It is recommended to install the video bar at eye-level of the meeting room participants.

When installing the video bar with the wall mount or screen mount, the camera should be positioned 8 centimeters (3 inches) below the screen and ideally 30-35 centimeters (12-14 inches) above the table top or 100 centimeters (3 feet) from the floor. If this height is not possible, it is recommended to install the video bar above the screen.

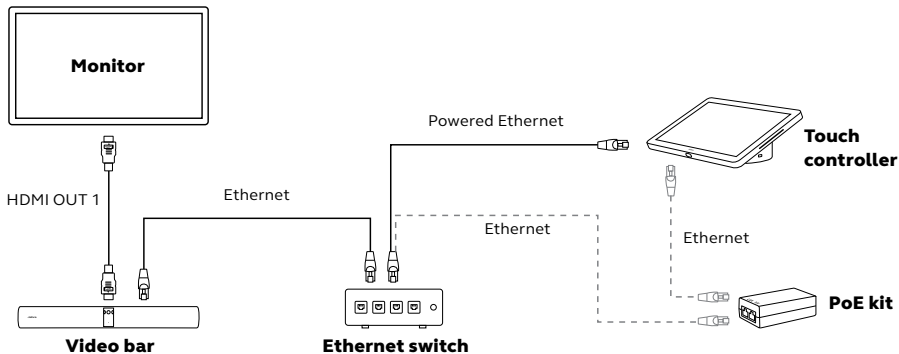


Do not mount the camera facing direct sunlight as this may affect the preset white balance and compromise the image.

# 5. Cabling

## 5.1 Room system cabling

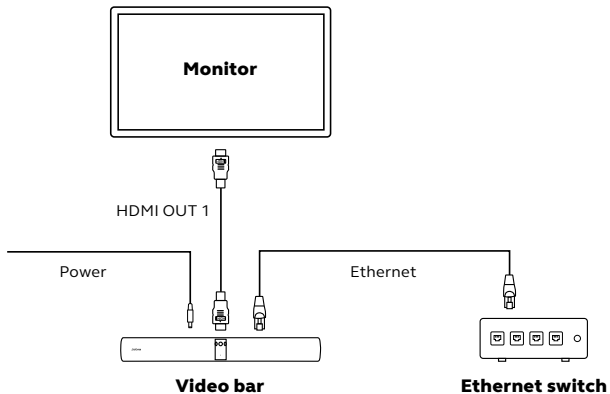
---



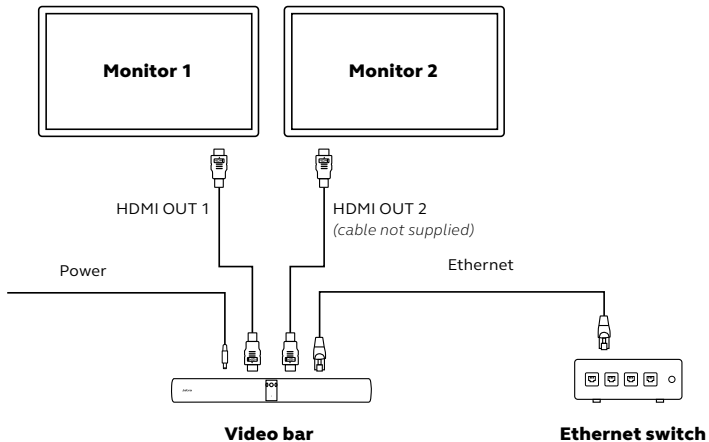
## 5.2 Video bar cabling

---

### VIDEO BAR CONNECTED TO ONE MONITOR

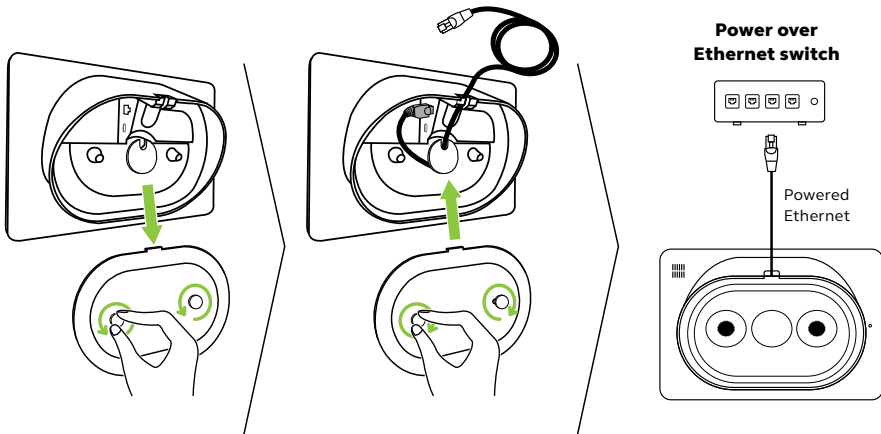


## VIDEO BAR CONNECTED TO TWO MONITORS



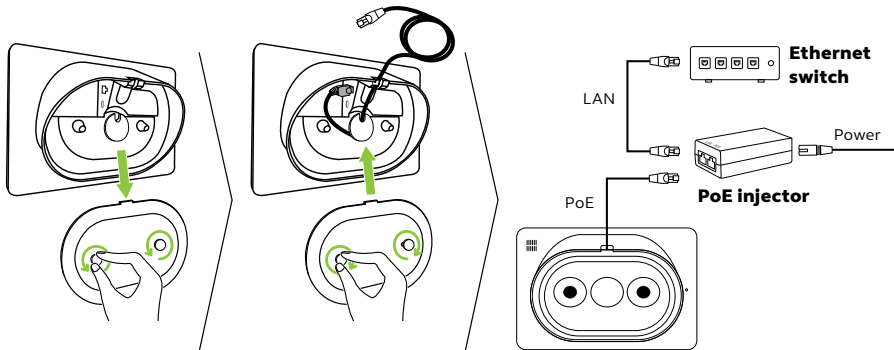
## 5.3 Touch controller cabling

### POWERED ETHERNET



## POWER OVER ETHERNET KIT

If the Ethernet connection does not supply power to the touch controller, the included PoE injector will need to be connected between the Ethernet switch and the touch controller.





## 6. Configuring

Before starting the configuration of the Jabra PanaCast 50 Video Bar System ensure both the video bar and the touch controller are connected to the same local area network (LAN) and powered on.

During the last step of the configuration it is necessary to log into the video conferencing account of your service provider.

The Jabra PanaCast 50 Video Bar System is versatile and can come pre-loaded with native Microsoft Teams Room on Android™ or Zoom Room for Android™\*, or without video conference service provider selected.

\* Android™ is a trademark of Google LLC.

## 6.1 Configuration using the touch controller

---

The Jabra PanaCast 50 Video Bar System is easily configured by following the Setup wizard using the touch controller.

The setup includes:

- Language selection
- Date and time setup
- Pairing between video bar and touch controller, if not already paired
- Automatic firmware update
- Video Service Provider selection, if not preselected



## 6.2 Configuration using the video bar

---

The PanaCast 50 Video Bar System can be configured using just the video bar. This configuration method allows you to set up the system when there is no touch controller available. This configuration method requires either a touch monitor or a wired keyboard and mouse.

The setup includes:

- Language selection
- Date and time setup
- Automatic firmware update
- Video Service Provider selection, if not preselected

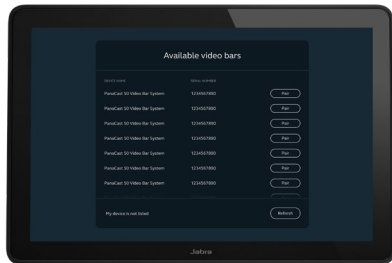


## 7. Pairing

The Jabra PanaCast 50 Video Bar System video bar and touch controller are pre-paired and ready to be configured.

If the video bar and touch controller are bought separately or the pairing has been lost, it is necessary to manually pair them.

1. Ensure both the video bar and touch controller are connected to the same local area network (LAN) and powered on.
2. Follow the Setup wizard using the touch controller.
3. Select the corresponding video bar from the available devices displayed and pair the devices.



## 8. Remote management

The Jabra PanaCast 50 Video Bar System can be remotely managed over an Ethernet connection using the Web Console. The Web Console can be accessed by entering the IP address of the video bar or touch controller into a browser.

If this is the first time you are accessing the Web Console, it is necessary to change the username and password. The default username is **admin** and the password is the **last 6 digits of the serial number of the device used to access the Web Console**.

If the Jabra PanaCast 50 Video Bar System has not been configured, the Web Console will take you through the necessary configuration process.

# 9. Software

## 9.1 Operating system

---

Jabra PanaCast 50 Video Bar System operates on Android™\*.

## 9.2 Microsoft Teams and Teams Rooms

---

Microsoft Teams or Microsoft Teams Rooms will automatically detect and set the Jabra PanaCast 50 Video Bar System as the default video and audio device.

## 9.3 Zoom and Zoom Rooms

---

Zoom or Zoom Rooms will automatically detect and set the Jabra PanaCast 50 Video Bar System as the default video and audio device.

\* Android is a trademark of Google LLC.

## 10. Restart devices

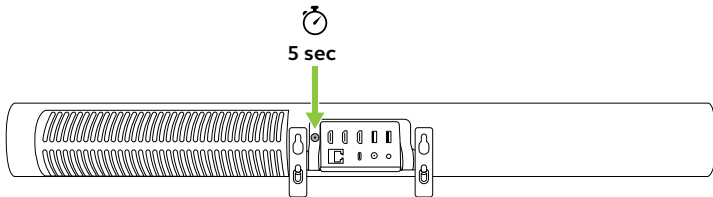
To restart the video bar and touch controller, access the *Device settings* menu on the touch controller and go to the *Restart* section. Both devices will be restarted.

You can also access the Web Console by entering the IP address of the video bar or touch controller in a browser, and go to the System Reset menu.

## Individual restart of the video bar

Press and hold the **Reset** button on the back of the video bar. Release the button after 5 seconds and a 'Restarting' message will be displayed on the monitor.

The video bar will restart and play an audio notification when ready for use. The reboot takes approximately 1 minute.

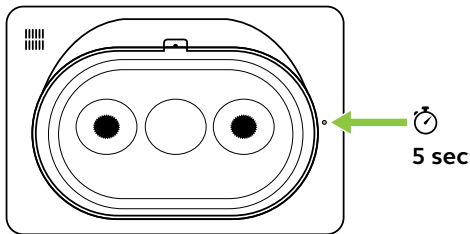




## Individual restart of the touch controller

Use a paperclip to press and hold the **Pinhole reset** button on the back of the touch controller. Release the button after 5 seconds and a 'Restarting' message will be displayed on the monitor.

The touch controller will flash green and restart. The reboot takes approximately 1 minute.



# 11. Factory reset

To factory reset the video bar and touch controller, access the *Device settings* menu on the touch controller and go to the *Restart* section and select *Factory reset*. Both devices will be reset.

You can also access the Web Console by entering the IP address of the video bar or touch controller in a browser, and go to the *System Reset* menu.

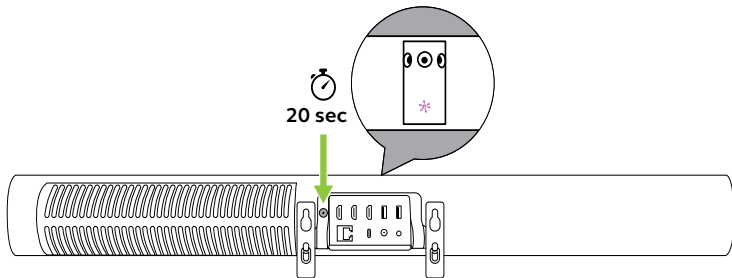
When factory resetting the video bar or touch controller individually, it is necessary to reset the other device to ensure the entire system is completely reset to its factory default settings.

## Individual factory reset of video bar

Resetting will restore the video bar to its factory default settings.

Press and hold the **Reset** button on the back of the video bar for 20 seconds until the LED flashes pink and the 'factory data reset' message is displayed on the monitor.

The video bar will restart and play an audio notification when ready for use. The reboot takes approximately 1 minute.

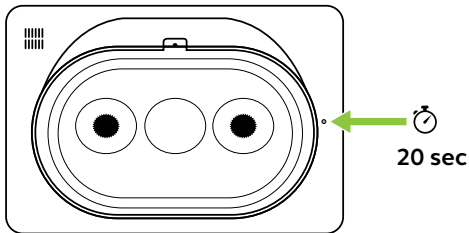


## Individual factory reset of the touch controller

Resetting will restore the touch controller to its factory default settings.

Use a paperclip to press and hold the Pinhole reset button on the back of the touch controller for 20 seconds until the 'factory data reset' message is displayed on the screen.

The reboot takes approximately 1 minute.



# 12.Support

## 12.1 FAQ and technical specifications

---

View the FAQ, certifications, and technical specifications at [jabra.com/help/panacast50vbs](https://jabra.com/help/panacast50vbs)

## 12.2 How to care for your Jabra device

---

The Jabra PanaCast 50 Video Bar System is for indoor use only.

- Avoid direct sunlight and temperatures above 40°C/104°F or below 0°C/32°F.
- Do not expose the camera or cables to rain or other liquids.
- Do not position the devices near the vents of a monitor or TV as this may cause the devices to overheat and malfunction.
- Clean the surface with a cloth dampened with a mild soap solution.

To learn more about the Jabra PanaCast 50 Video Bar System,  
go to **[jabra.com/help/panacast50vbs/getstarted](https://jabra.com/help/panacast50vbs/getstarted)**