

ePOS-Device XML User's Manual

Overview

Describes the features and development environment.

Building Environment

Describes environment building for ePOS-Device Service.

Programming Guide

Describes how to write programs in Web application development.

XML Reference

Describes the ePOS-Device XML.

Device Specifications

Describes the device specifications.

Sample Program

Describes the sample program.

Cautions

- Unauthorized duplication, copying, reproduction, or modification of any part or all of this document is strictly prohibited.
- Contents of this manual are subject to change without prior notice. Contact us directly for the most recent information.
- Every effort is made to ensure that the contents of this manual are without error. Please contact us if any errors or other issues are found.
- The previous statement notwithstanding, we will not be liable for any negative impact as a result of use.
- Epson shall not be liable for any damages caused as a result of using this product incorrectly, failing to comply with the content of this document, or having repair or modifications performed by third parties other than Epson or those specified by Epson.
- Epson shall not be liable for any issues as a result of installing optional parts or consumables that are not genuine Epson parts or parts certified by Epson.

Trademarks

EPSON, EXCEED YOUR VISION, and ESC/POS are registered trademarks of Seiko Epson Corporation.

Windows® registered trademarks of Microsoft Corporation in the United States and other countries.

Android™ is trademark of Google LLC.

Apple, Apple TV, Apple Watch, iPad, iPad Air, iPad Pro, iPhone, and Lightning are trademarks of Apple Inc., registered in the U.S. and other countries. tvOS is a trademark of Apple Inc.

Xcode®, Safari™ and True Type® are trademarks of Apple Inc. registered in the U.S. and other countries.

IOS is a trademark or registered trademark of Cisco in the U.S. and other countries and is used under license.

Java™ is a registered trademark of Oracle Corporation, its subsidiaries, and affiliates in the U.S. and other countries.

Eclipse® is a trademark or registered trademark of Eclipse Foundation, Inc.

QR Code® is a registered trademark of DENSO Wave Incorporated.

All other trademarks are the property of their respective owners and used for identification purpose only.

ESC/POS® Command System



Epson has embarked on a global initiative to develop ESC/POS, a unique POS printer command system. ESC/POS contains a wealth of unique commands, many of which are patent-protected. Our system enables the configuration of versatile POS systems with a high level of scalability. In addition to being compatible with most Epson POS printers and displays, the flexibility provided by this unique control system facilitates ease of future upgrades. This functionality and convenience of use are appreciated around the world.

© Seiko Epson Corporation 2012-2023.

For Safety

Key to Symbols

The symbols in this manual are identified by their level of importance, as defined below. Read the following carefully before handling the product.

	Provides information that must be observed to avoid damage to your equipment or a malfunction.
	Provides important information and useful tips.

Restriction of Use

When this product is used for applications requiring high reliability/safety such as transportation devices related to aviation, rail, marine, automotive etc.; disaster prevention devices; various safety devices etc; or functional/precision devices etc, you should use this product only after giving consideration to including fail-safes and redundancies into your design to maintain safety and total system reliability. Because this product was not intended for use in applications requiring extremely high reliability/safety such as aerospace equipment, main communication equipment, nuclear power control equipment, or medical equipment related to direct medical care etc, please make your own judgment on this product's suitability after a full evaluation.

About this Manual

Aim of the Manual

This manual is intended to provide development engineers with all information necessary for building ePOS-Device systems as well as developing and designing applications.

Manual Content

The manual is made up of the following sections:

Chapter 1	Overview
Chapter 2	Building Environment
Chapter 3	Programming Guide
Chapter 4	XML Reference
Chapter 5	Device Specifications
Chapter 6	Sample Program

Contents

■ For Safety	3
Key to Symbols	3
■ Restriction of Use	3
■ About this Manual	3
Aim of the Manual	3
Manual Content	3
■ Contents	4

Overview 10

■ ePOS-Device XML	10
Features	11
System Configuration Example	12
How to Use the Communication Box	13
Specifying the Print Job ID from the Application	16
Spooler Function	17
■ Operating Environment	19
Application Environment	19
Application Terminal	19
Supported Printers	19
ePOS-Device Service Versions	20
Controllable Peripheral Devices	22
■ Contents in the Package	25
Manual	25
Sample Program	25
Download	25
■ Restrictions	26

Building Environment 27

■ Workflow	27
TM-DT Series	27
TM-T88VI-iHUB	28
Other TM-i Series	28
TM-H6000V	29
■ Registration of Device	30
TM-DT Series	30
TM-T88VI-iHUB	32
Other TM-i Series	33
TM-H6000V	34

Programming Guide 35

■ Programming Flow	35
---------------------------------	-----------

If Reconnecting to the printer when the Network was Cut Off	36
Programming flow for the Communication Box.....	37
Performing check process.....	40
■ Using the Spooler Function	43
■ Service Interface Specifications	44
Format	44
■ Communication Data Example.....	45
Communication Box Message Example.....	47
■ Array of <data> elements in <device_data> message	50

XML Reference 51

■ List of ePOS-Device XMLs.....	51
Message	51
CommunicationBox Messages	52
Device Messages.....	52
DeviceHubTerminal	53
BarcodeScanner.....	53
Printer	54
HybridPrinter.....	54
CustomerDisplay.....	56
Keyboard	56
POSKeyboard	57
MSR	57
SerialDevice	57
Storage	57
OtherPeripheral.....	57
PrinterControl XML	58
CustomerDisplayControl XML.....	63
■ Message	66
<connect>.....	66
<reconnect>.....	67
<disconnect>	68
<admin_info>	69
<open_commbox>.....	70
<close_commbox>	72
<commbox_data>	73
<open_device>	74
<close_device>	76
<device_data>	78
<service_data>.....	80
<error>	82
■ CommunicationBox Messages	84
<type>getcommhistory</type>	84
<type>send</type>.....	86
<type>onreceive</type>.....	87
■ DeviceHubTerminal Messages	88
<type>shutdown</type>	88
<type>onshutdown</type>.....	89
<type>restart</type>	90
<type>onrestart</type>	91

■ BarcodeScanner Messages.....	92
<type>ondata</type>	92
■ Printer Messages.....	93
<type>print</type>	93
<type>onxmlresult</type>	95
■ HybridPrinter Messages.....	97
<type>lock</type>	97
<type>unlock</type>	98
<type>print</type>	99
<type>onxmlresult</type>	100
<type>slipwaitinsertion</type>	101
<type>slipprint2</type>	102
<type>slipcancel</type>	103
<type>endorsewaitinsertion</type>	104
<type>endorseprint2</type>	105
<type>endorsecancel</type>	106
<type>validationwaitinsertion</type>	107
<type>validationprint2</type>	108
<type>validationcancel</type>	109
<type>micrread</type>	110
<type>micrcleaning</type>	111
<type>micrcancel</type>	112
<type>eject</type>	113
<type>onreceive</type>	114
■ PrinterControl XML	117
<epos-print>	117
<response>	118
<text>	121
<feed>	126
<image>	128
<logo>	131
<barcode>	132
<symbol>	137
<hline>	142
<vline-begin>	143
<vline-end>	144
<page>	145
<area>	146
<direction>	148
<position>	149
<line>	150
<rectangle>	152
<cut>	154
<pulse>	155
<sound>	156
<command>	158
<layout>	159
<recovery>	163
<reset>	164
<batch-begin>	165
<batch-end>	167
<rotate-begin>	168
<rotate-end>	170
■ CustomerDisplay Messages	171

<type>display</type>	171
<type>onxmlresult</type>	172
■ CustomerDisplayControl XML	173
<epos-display>	173
<response>	174
<window>	176
<screen>	179
<textarea>	182
<cursor>	184
<text>	186
<marquee>	188
<blink>	190
<brightness>	191
<backgroundcolor>	192
<slideshow>	193
<downloadimage>	194
<registerdownloadimage>	196
<nvimage>	198
<clearimage>	200
<symbol>	201
<clearsymbol>	203
<clock>	204
<clear>	205
<reset>	206
<command>	207
■ Keyboard Messages	208
<type>onkeypress</type>	208
<type>setprefix</type>	209
<type>onstring</type>	210
<type>setMSRPrefix</type>	211
<type>ondata</type>	212
■ POSKeyboard Messages	213
<data>onkeypress</data>	213
■ MSR Messages	214
<data>ondata</data>	214
■ SerialDevice Messages	215
<type>sendcommand</type>	215
<type>oncommandreply</type>	216
■ Storage Messages	217
<type>operate</type>	217
<type>operateresult</type>	218
■ OtherPeripheral Messages	219
<type>User-defined Function</type>	219
<type>User-defined Event</type>	220
■ List of KeyCode	221
<hr/>	
Device Specifications	223
■ Supported Printers by XMLs	223
■ ePOS-Device XML Functions That Can Be Used with TM Printer	225

ePOS-Device XML Functions That Can Be Used	225
Messages That Can Be Used	225
Registration of Device.....	226
Limitations	226
■ List of Supported Elements	227
PrinterControl XML	227
CustomerDisplayControl XML.....	232
■ Printer-specific Support Information	236
TM-T20II-i.....	236
TM-T70-i	241
TM-T82II-i.....	245
TM-T83II-i.....	250
TM-T88V-i.....	255
TM-T88VI-iHUB.....	260
TM-U220-i.....	266
TM-T70II-DT.....	269
TM-T70II-DT2.....	274
TM-T88V-DT	279
TM-T88VI-DT2.....	284
TM-H6000IV-DT	289
TM-H6000V	294
TM-m30.....	300
TM-m30II.....	305
TM-m30II-H.....	310
TM-m30II-NT.....	315
TM-m30II-S.....	320
TM-m30II-SL.....	325
TM-m30III.....	330
TM-m30III-H.....	335
TM-m50.....	340
TM-T88VI	345
TM-T88VII.....	351
TM-L100	357
TM-m10.....	363
TM-P20	368
TM-P60II (Receipt)	374
TM-P60II (Peeler).....	380
TM-P80	386
TM-T20.....	392
TM-T20II.....	397
TM-T70.....	402
TM-T70II.....	406
TM-T82II.....	411
TM-T83II.....	416
TM-T88IV	420
TM-T88V	424
TM-T90.....	429
TM-L90.....	433
TM-U220	437
TM-H6000IV	440
■ Usage restriction by firmware version	444

Sample Program 448

■ Outline 448

■ Building Environment for Android 449

Environment.....	449
Flow of environment construction for TM-DT Series.....	450
Flow of environment construction for TM-T88VI-iHUB.....	452
Flow of environment construction for other TM-i Series.....	453
Installing Java SE Development Kit.....	455
Setting Up Eclipse.....	457
Setting Up Android SDK Manager.....	459
Installing ADT Plugin.....	464
Importing the Sample Program.....	468
Setting the Barcode Scanner.....	470

■ Building Environment for iOS 471

Environment.....	471
Flow of environment construction for TM-DT Series.....	472
Flow of environment construction for TM-T88VI-iHUB.....	473
Flow of environment construction for other TM-i Series.....	474
Setting the Barcode Scanner.....	475
Setting the Sample Program.....	475

■ Executing Sample Program 476

Android.....	476
--------------	-----

■ How to Use the Sample Program..... 481

Overview

This chapter describes the features of and the specifications for ePOS-Device XML.

ePOS-Device XML

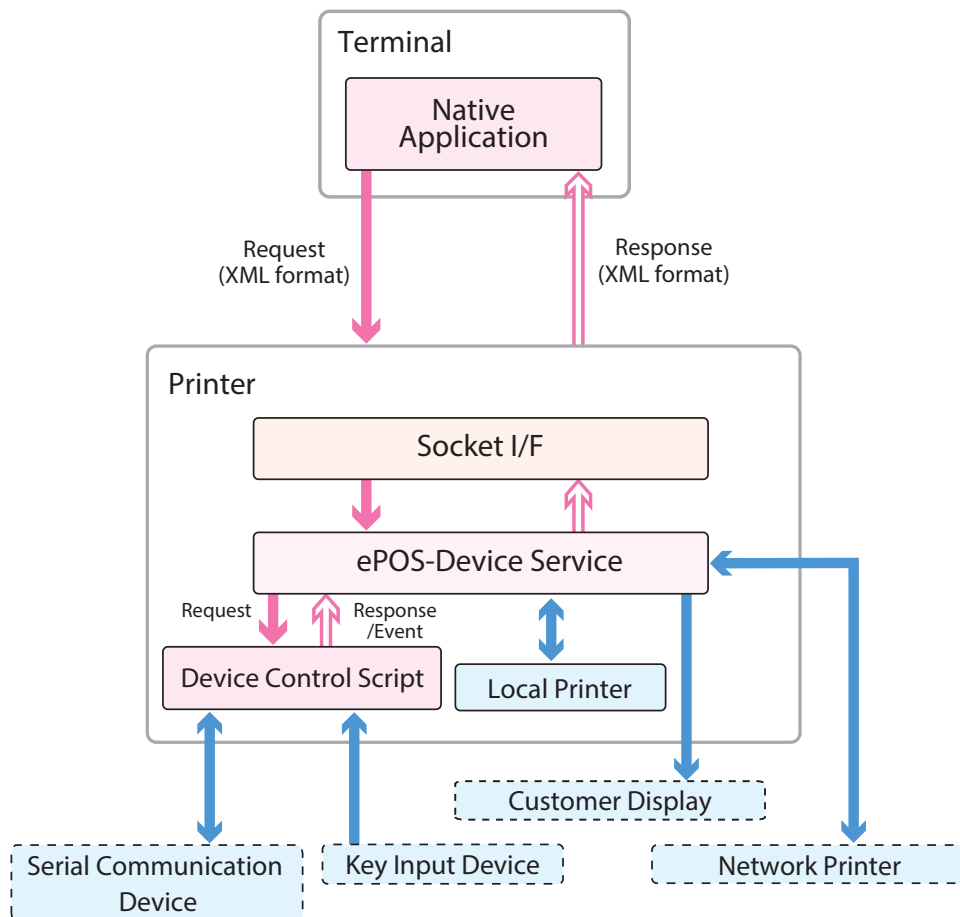

ePOS-Device XML is a command system that defines the function to control various types of peripheral devices (including this product's printer) connected to printer using XML. Application in devices such as personal computers, smartphones, and tablet computers creates a request message in XML format and send it to printer using socket communication. ePOS-Device Service installed in printer executes control over peripheral devices by interrupting a request message and returns a response.

Features

- ❑ No need to prepare any device (such as a PC) to act as a controller to control the peripheral devices.
- ❑ Epson peripheral devices as well as many other peripheral devices can be controlled via device control programs and device control scripts developed exclusively by Epson.
Since the version of the loaded software differs depending on the printer, the controllable peripheral devices also differ.
For details on the controllable peripheral devices, refer to the Technical Reference Guide of the printers.
Device control programs are supported by TM-DT series devices with version 4.0 or later of the TM-DT software.
Refer to the TM-DT Series Peripheral Device Control Guide for more information on device control programs and device control scripts.
- ❑ Accessing a device automatically locks the device exclusively.
Even if accessed from multiple terminals simultaneously, the device is not under multiple controls. When the terminal that has controlled the device releases the device, the device becomes controllable from another terminal.
- ❑ If the network is cut off, you can easily re-establish the connection.
- ❑ Data can be sent and received between web applications.
For details, refer to [How to Use the Communication Box \(p.13\)](#).
- ❑ Printing requests can be made to the printer by specifying the printing job ID. *2
For details, refer to [Specifying the Print Job ID from the Application \(p.16\)](#).
- ❑ Printing data can be sent to the printer without waiting for a printing complete response from the printer. (Spooler) *2
For details, refer to [Spooler Function \(p.17\)](#).
- ❑ Print data can be sent to another printer if the printer sends an error response (PAPER END, COVER OPEN, etc.) or does not return a response. (Print forwarding) *2
For details, refer to [Forwarding \(p.18\)](#).
- ❑ You can shut down the TM-DT from the application. *1
(DeviceHubTerminal object)

*1 TM-DT series is supported only.

*2 ePOS-Device Service Ver.2.6 or later

System Configuration Example

System with Application Installed in Tablet Computer

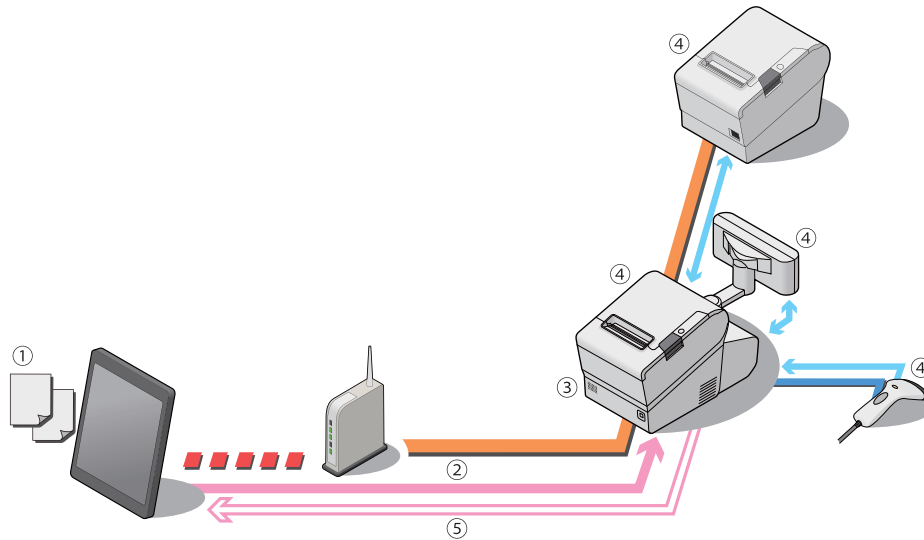

- 1** Place and display the application in the tablet computer.
- 2** The application sends a request message to printer.
- 3** Printer sends data to devices that can be controlled.
- 4** The devices and network printers connected to printer are controlled.
- 5** Printer returns a response to the application.

How to Use the Communication Box

The Communication Box is a virtual data space that is provided by the ePOS-Device Service for sending and receiving data between applications. It is provided in ePOS-Device Service Ver. 2.5 and later.



- The ePOS-Device Service is providing a virtual space and structure for sending and receiving data between applications. Create the data to be sent and received according to your application's specifications.
- TM-H6000V is not supported.

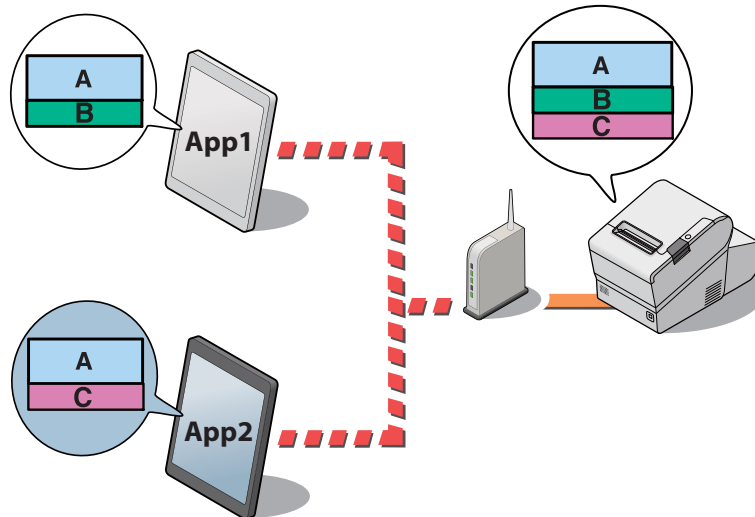

The Communication Box can be used in the following ways.

- Using a tablet terminal as a POS display terminal
- Displaying digital signage
- Using a tablet terminal as an entry terminal

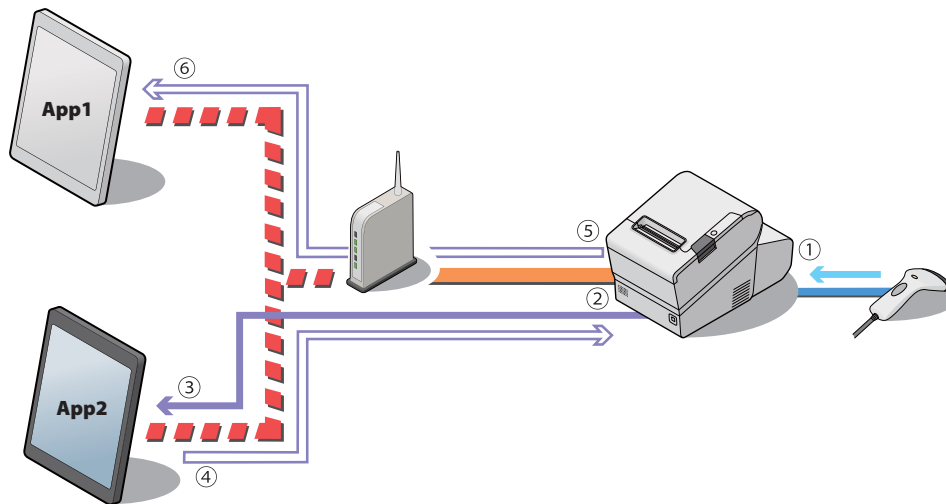
Example of data processing using the Communication Box

- 1** The printer receives the barcode data scanned by the scanner.
- 2** The ePOS-Device Service notifies App2 of the barcode data.
- 3** App2 acquires the barcode data and converts it to POS data.
- 4** App2 sends the display data to the Communication Box of the ePOS-Device Service.
- 5** The ePOS-Device Service notifies App1 that the display data is stored in the Communication Box.
- 6** App1 acquires the display data stored in the Communication Box.

Structure of the Communication Box

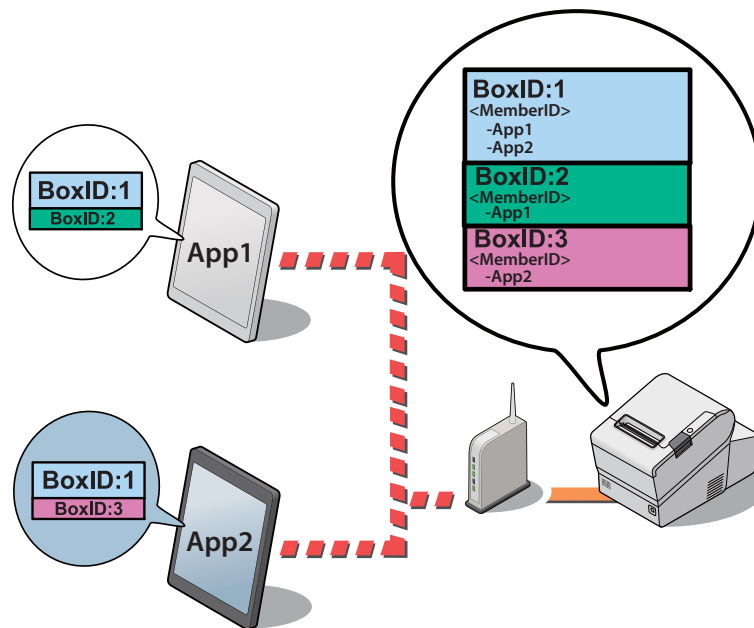

The ePOS-Device Service manages Communication Boxes with Box IDs (BoxID in the figure above).

Data can be sent and received between applications belonging to the Communication Box.

In the figure above, applications App1 and App2 can send and receive data with one another using the BoxID:1 Communication Box.

Specifications of the Communication Box

Maximum number of Communication Boxes that can be created	20
Maximum number of applications that can belong to one Communication Box	20
Space of transfer history that one Communication Box can maintain	10240 Byte
Size of data that can be sent at one time	1024 Byte

Specifying the Print Job ID from the Application

A response containing the specified print job ID will be returned when sending a request from the application by specifying the print job ID. (ePOS-Device Service Ver. 2.6 or later versions)

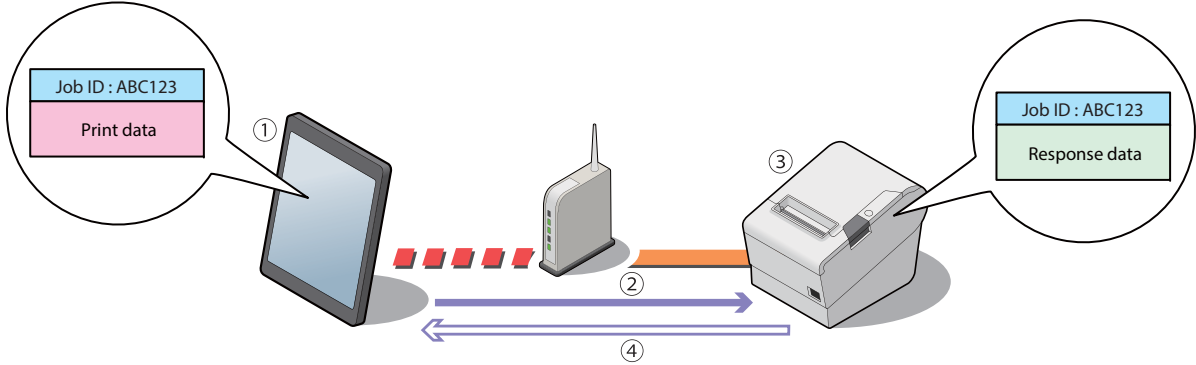

Spooler Function

The spooler function is a function used to temporarily store printing data received from the application in the printer to carry out background printings sequentially. (ePOS-Device Service Ver. 2.6 or later versions)

Printer return response data to the application the moment the printing data enters the spooler to make it possible for applications to proceed to the next process without waiting for a printing complete response.

The application can use the job ID included in the response data to send an inquiry on the printing status.

EPSON TMNet WebConfig is used to configure the spooler.

Perform the following settings. For details, refer to the Technical Reference Guide for each printer.

- Settings to enable the spooler
- Print process retry settings

Forwarding can be used to send a printing job to a different printer if the printer does not respond to retry processing. For details, refer to [Forwarding \(p.18\)](#).



TM-H6000V is not supported.

Example

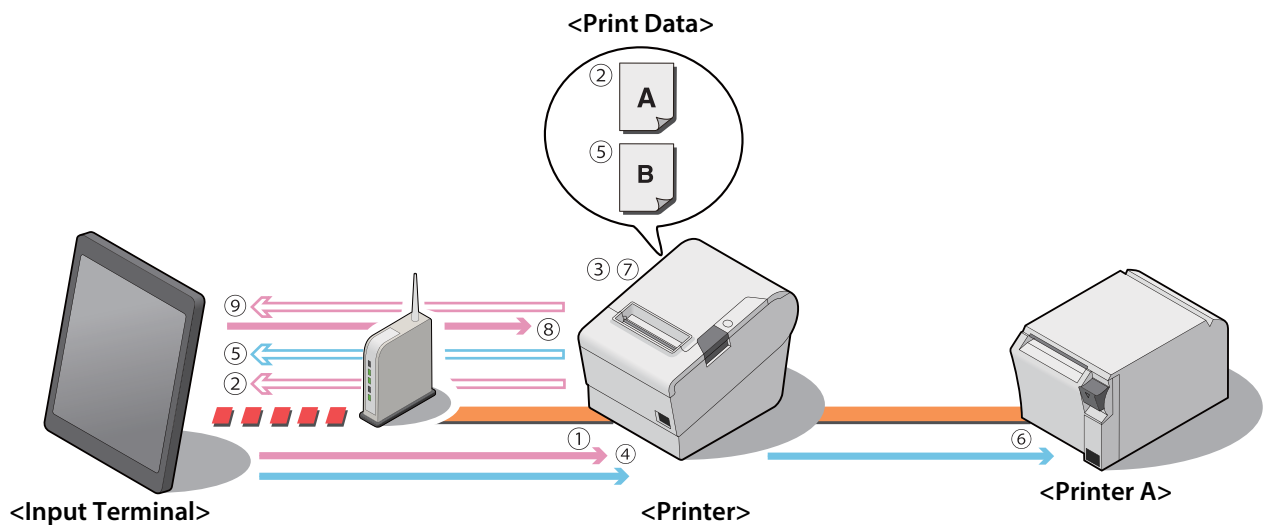

- 1 Send print data A to a printer (ePOS-Device Service) from the input terminal.
- 2 The printer will save the print data A to the spooler and will return response data to the input terminal.
- 3 The printer will retrieve the print data and issue a print command to another printer.
- 4 Print data B will be sent to the printer from the input terminal.

- 5 The printer will save the print data B to the spooler and will return response data to the input terminal.
- 6 The printer will retrieve the print data B and issue a print command to printer A.
- 7 Print data A is complete.
- 8 A query on print data A results will be sent to the printer from the input terminal.
- 9 The printer will return response data back to the input terminal signifying that print data A completed without error.

Forwarding



For instructions on how to make the forwarding settings, see the Technical Reference Guide of the printer.

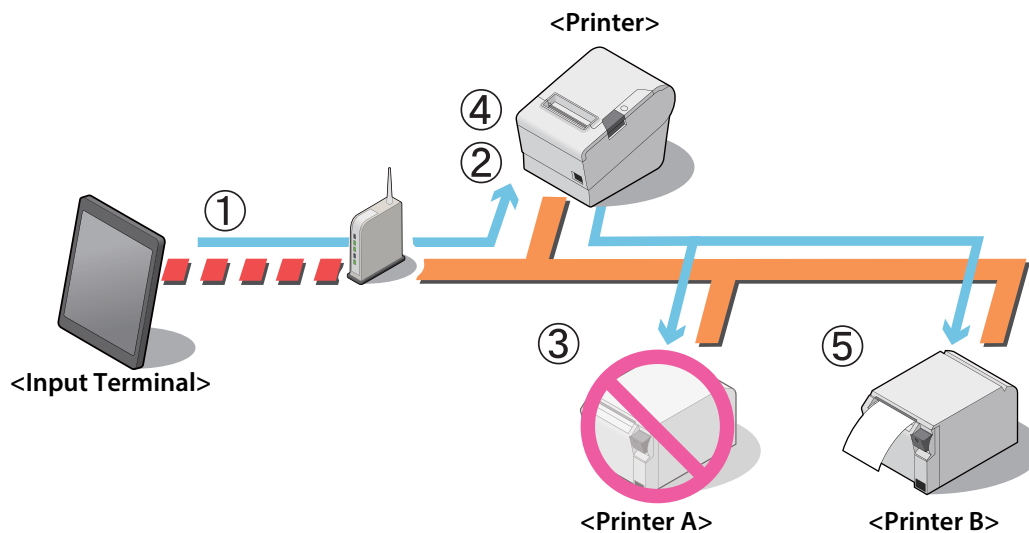

- 1 Send print data to ePOS-Device Service from the input terminal.
- 2 The printer issues a print command to printer A.
- 3 Printer A does not respond.
- 4 The printer reissues a print command to printer A.
If printer A still does not respond to the reissued print command, the print command will be issued to printer B.
- 5 Print data sent from the input terminal will be printed using printer B.

Operating Environment

Application Environment

Environment that allows socket communication and handling of XML documents

- ❑ OS Examples: iOS / Android™ / Windows / Linux / Mac OS

Application Terminal

Devices that allow socket communication as connected to a network

(Example: Smartphones, tablet computers, personal computers)

Supported Printers

TM-DT Series

- ❑ TM-T70II-DT
- ❑ TM-T70II-DT2
- ❑ TM-T88V-DT
- ❑ TM-T88VI-DT2
- ❑ TM-H6000IV-DT

TM-i Series

- ❑ TM-T20II-i
- ❑ TM-T70-i (TM-i firmware Ver.4.0 or later)
- ❑ TM-T82II-i
- ❑ TM-T83II-i
- ❑ TM-T88V-i (TM-i firmware Ver.4.0 or later)
- ❑ TM-T88VI-iHUB
- ❑ TM-U220-i

TM Printer

- ❑ TM-m30 (TM-m30 firmware Ver.1.40ESC/POS or later)
- ❑ TM-m30II
- ❑ TM-m30II-H
- ❑ TM-m30II-NT
- ❑ TM-m30II-S
- ❑ TM-m30II-SL
- ❑ TM-m30III
- ❑ TM-m30III-H
- ❑ TM-m50
- ❑ TM-T88VI (TM-T88VI firmware Ver.40.50 ESC/POS or later)
- ❑ TM-T88VII
- ❑ TM-L100



The ePOS-Device XML functions that can be used with TM Printer differs with the TM-DT series and TM-i series. Refer to [ePOS-Device XML Functions That Can Be Used \(p.225\)](#).

Hybrid Models

□ TM-H6000V



You need to enable the ePOS-Device settings.
Refer to TM-H6000V Utility User's Manual for more information.

ePOS-Device Service Versions

Depending on the version of ePOS-Device Service installed on the printer, some functions does not work with ePOS-Device XML. ([Usage restriction by firmware version \(p.444\)](#))

How to check the version

TM-DT Series/TM-i Series

The ePOS-Device Service for the TM-DT series and TM-i series is included in the TM-DT software and TM-i firmware.

The table below shows which ePOS-Device Service version is included in which TM-DT software/TM-i firmware version.

ePOS-Device Service	TM-DT Software	TM-i Firmware
1.0	1.0	-
2.0	2.0	-
2.2	2.2	-
2.5	2.5	4.0
2.6	-	4.1, 4.3
2.9	-	-
3.0	3.0	-
3.1	-	-
4.0	4.0	-
4.1	4.1	-
5.0	4.1	-
5.1	5.10	-
5.30	5.30	-



For details about how to check the version of TM-i Firmware and of TM-DT Software, refer to the Technical Reference Guide for each printer.

TM-H6000V

Print TM intelligent setting information to check the version.

Follow the procedure below.

- 1 Close the roll paper cover. Hold down the paper feed button and turn on the printer.
Hold the paper feed button down until printing of operating instruction starts.



The operating instruction is printed after the printer status is printed.

- 2 Following the instructions, press the paper feed button six times to select the TM intelligent setting information to be printed.
- 3 Press the paper feed button again and hold it down until the TM intelligent setting information is printed.
The ePOS-Device Service version is indicated as shown below.

```
ePOS Information
  ePOS-Print Version   : 6.00
  ePOS-Device Version  : 3.10
ePOS-Print
  Use                  : Enable
ePOS-Device
  Use                  : Enable
  .
  .
  .
```

- 4 When printing is finished, turn the printer off.

Controllable Peripheral Devices

Control of the following peripheral devices is supported.



- Controllable devices vary by model of printer.
For more information, refer to the Technical Reference Guide of the printer.
- You can control various peripheral devices other than the ones described below using the device control programs and device control scripts.
Refer to TM-DT Series Peripheral Device Control Guide for information on the development.

Epson Products

□ Printer

The following printers can be controlled.

Printer	TM-DT Series	TM-i Series
TM-L90 ^{*1}	✓	✓
TM-m10	✓ ^{*5}	-
TM-m30	✓ ^{*5}	-
TM-P20	✓ ^{*3}	✓ ^{*2}
TM-P60II	✓	✓
TM-P60II Peeler	✓	✓
TM-P80	✓ ^{*3}	✓
TM-T20 ^{*1}	✓	✓
TM-T20II-i	-	✓
TM-T20II ^{*1}	✓ ^{*3}	✓
TM-T20III	✓ ^{*5}	-
TM-T20IIIL	✓ ^{*5}	-
TM-T20X	✓ ^{*5}	-
TM-T70-i (TM-i firmware Ver.4.0 or later)	-	✓
TM-T70II-DT (TM-DT software Ver.4.0 or later)	✓ ^{*4}	-
TM-T70II-DT2	✓ ^{*5}	-
TM-T70 ^{*1}	✓	✓
TM-T70II ^{*1}	✓	✓
TM-T81III	✓ ^{*5}	-
TM-T82II-i	-	✓
TM-T82II ^{*1}	✓ ^{*3}	✓
TM-T82III	✓ ^{*5}	-
TM-T82IIIL	✓ ^{*5}	-
TM-T82X	✓ ^{*5}	-
TM-T83II-i	-	✓ ^{*2}
TM-T83II ^{*1}	-	✓ ^{*2}
TM-T83III	✓ ^{*5}	-
TM-T88IV ^{*1}	-	✓
TM-T88V-i (TM-i firmware Ver.4.0 or later)	-	✓
TM-T88V-DT (TM-DT software Ver.4.0 or later)	✓ ^{*4}	-
TM-T88VI-DT2	✓ ^{*5}	-

Printer	TM-DT Series	TM-i Series
TM-T88V ^{*1}	✓	✓
TM-T88VI-iHUB	-	✓ ^{*6}
TM-T88VI	✓ ^{*5}	✓ ^{*6}
TM-T90 ^{*1}	✓	✓
TM-T100	✓ ^{*5}	-
TM-U220-i	-	✓
TM-U220 ^{*1}	✓	✓
TM-H6000IV-DT (TM-DT software Ver.4.x)	✓ ^{*7}	-
TM-H6000IV ^{*1}	✓ ^{*8}	-

^{*1} Ethernet model (UB-E02/ UB-E03/UB-E04), or wireless LAN model (UB-R03/ UB-R04/UB-R05).

The available Interface board (UB-****) varies depending on the TM printer.

Other interface models are not supported.

^{*2} TM-i firmware Ver.4.1 or later versions supported.

^{*3} TM-DT software Ver.3.0 or later versions supported.

^{*4} TM-DT software Ver.4.0 or later versions supported.

^{*5} TM-DT software Ver.5.0 or later versions supported.

^{*6} TM-T88VI-iHUB only.

^{*7} TM-DT software Ver. 4.x supported.

^{*8} TM-DT software Ver. 2.5 to 4.x supported.

Customer display

The following customer displays can be used.

Customer Display	TM-DT Series	TM-i Series	TM Printer	Hybrid Models
DM-D30	✓ ^{*1}	✓ ^{*5}	✓	-
DM-D70	✓ ^{*2}	-	✓	-
DM-D110SU	-	✓	-	-
DM-D110SD	✓	✓	✓ ^{*6}	✓
DM-D110DT	✓ ^{*3}	-	✓ ^{*6}	-
DM-D110MJ	✓ ^{*4}	-	-	✓
DM-D210	-	-	-	✓

^{*1} TM-DT software Ver.4.0 or later versions supported.

^{*2} TM-T70II-DT2/TM-T88VI-DT2 TM-DT software Ver.5.10 or later versions supported.

^{*3} TM-T88V-DT/TM-T88VI-DT2 only.

^{*4} TM-H6000IV-DT only.

^{*5} TM-T88VI-iHUB only.

^{*6} TM-T88VI only.

Peripheral Devices that can be Controlled by Device Control Programs

Peripheral devices conforming to the OPOS specifications can be controlled using the device control programs that are supported by TM-DT series (TM-DT software version 4.0 or later).

In the categories described below, peripheral devices having a driver that runs in combination with OPOS Common Control Object (OPOS CCO) 1.14.001 can be controlled.

- MSR
- POS keyboard
- Barcode scanner

Peripheral Devices that can be Controlled by Device Control Scripts

The following peripheral devices can be controlled using the device control script supplied with the TM-DT series and TM-i series.

Key input device

- MSR (Hitachi-Omron Terminal Solutions, Corp.)
- Keyboard (Standard HID device)
- Barcode scanner (Standard HID device)

Serial communication device

- Serial communication device
- USB device that can provide a control level equivalent to serial communication devices



Install a dedicated driver for using a USB device that can be controlled in a similar manner as a serial communication device.

You may not be able to use some drivers depending on their specifications.

Contents in the Package

Manual

- ePOS-Device XML User's Manual (This Document)
- TM-DT Series Peripheral Device Control Guide
- Each TM printer Technical Reference Guide
- JSON Specification
- Each customer display Technical Reference Guide

Sample Program

The following files are included in the sample program package (ePOS-Device_Sample_XML_Vx.x.x.zip).

Name	Description
Android	Sample program files for Android environments
iOS	Sample program files for iOS environments
DeviceControlProgram_Sample.zip	Sample program files for device control program development
DeviceControlScript_Sample.zip	Sample program files for device control script development
README.ja.txt	Japanese README file
README.en.txt	English README file



- Refer to [Sample Program \(p.448\)](#) for information on using sample programs for Android and iOS environments.
- Refer to the TM-DT Series Peripheral Device Control Guide for more information on sample programs for device control program and device control script development.

Download

For customers in North America, go to the following web site:

<https://www.epson.com/support/>

For customers in other countries, go to the following web site:

<https://www.epson-biz.com/>

Restrictions

- ❑ The ruled line command is available only when the printer supports the "ruled line command".
- ❑ The drawer and the buzzer cannot be used together.
- ❑ The buzzer function cannot be used if the printer is not provided with the buzzer.
- ❑ When a 2D-code scanner is used, multibyte characters such as Japanese cannot be obtained properly.
- ❑ When 2D-code data contains an ASCII control code (0x00 to 0x1F), control codes cannot be obtained.
- ❑ Set the barcode reader suffix (delimiter) to CR (carriage return code). Data cannot be obtained using any other settings.
- ❑ Keycodes that can be obtained from the keyboard are restricted. For the key codes that can be obtained, refer to [List of KeyCode \(p.221\)](#).
- ❑ Device control program files and device control script files cannot be loaded into TM-i series devices.
- ❑ Serial communication devices cannot be used with a TM-i Series printer with the specification of "without Serial port".
- ❑ The PHP function and print spooler function cannot be used simultaneously on TM-i Series printers except for TM-T88VI-iHUB.
- ❑ Only messages without BOM are supported.
- ❑ Only UTF-8 character encoding is supported.

Building Environment

This chapter describes environment building for ePOS-Device Service.

Workflow

TM-DT Series

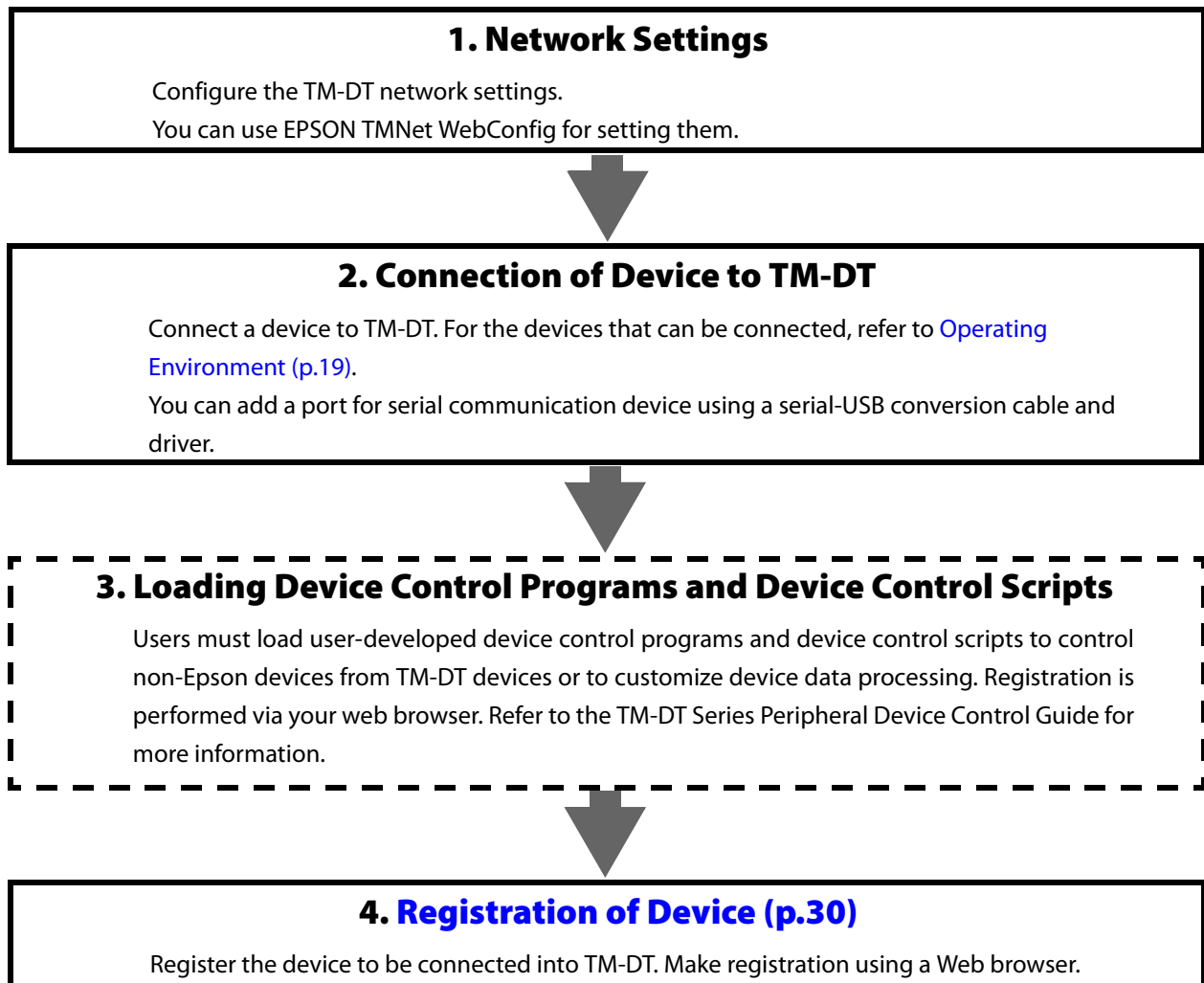

TM-T88VI-iHUB

1. Connection of Device to TM-T88VI-iHUB

Connect a device to TM-T88VI-iHUB. For the devices that can be connected, refer to [Operating Environment \(p.19\)](#).



2. Network Settings

Using TM-T88VI Utility, configure the network settings of TM-T88VI-iHUB. For more details, see the TM-T88VI Utility User's Manual.



3. Registration of Device (p.30)

Using TM-T88VI Utility, register devices to the TM-T88VI-iHUB printer to be connected to the printer.

Other TM-i Series

1. Connection of Device to TM-i

Connect a device to TM-i. For the devices that can be connected, refer to [Operating Environment \(p.19\)](#).



2. Network Settings

Configure the system and TM-i network settings.

- EPSON TMNet WebConfig
- EpsonNet Config



3. Registration of Device (p.30)

Register the device to be connected into TM-i. Make registration using a Web browser.

TM-H6000V**1. Connection of Device to TM-H6000V**

Connect a device to TM-H6000V. For the devices that can be connected, refer to [Operating Environment \(p.19\)](#).

**2. Network Settings**

Using TM-H6000V Utility, configure the network settings of TM-H6000V.
For more details, see the TM-H6000V Utility User's Manual.

**3. ePOS-Device Settings**

Using TM-H6000V Utility, enable ePOS-Device.
For more details, see the TM-H6000V Utility User's Manual.

**4. Registration of Device (p.30)**

Using TM-H6000V Utility, register devices used with TM-H6000V.

Registration of Device

Register the device to be controlled by ePOS-Device XML into printer.

For details, refer to the Technical Reference Guide for each printer.

- ❑ [TM-DT Series \(p.30\)](#)
- ❑ [TM-T88VI-iHUB \(p.32\)](#)
- ❑ [Other TM-i Series \(p.33\)](#)
- ❑ [TM-H6000V \(p.34\)](#)

TM-DT Series

Configure the following settings for each device connected to the TM-DT printer.

Configure the settings using EPSON TMNet WebConfig.

Epson Products

Printer

Setting	Setting Value
Device ID	Enter the ID (any character string) of the printer to be controlled.
Type	Select "Network printer".
Model no.	Select the model of the printer to be controlled.
IP Address	Specify the IP address of the printer for each device ID.
Retry interval	Specify the retry interval after timeout.

Customer Display

Setting	Setting Value
Customer Display	Set whether or not this is used.
Communications settings	Set the communication speed, data bit and parity.
Brightness settings	Set the brightness of the customer display.



The device ID of the customer display is fixed to "local_display".

Peripheral Devices that can be Controlled by Device Control Programs

Refer to the TM-DT Series Peripheral Device Control Guide for more information.

Setting	Setting Value
Device ID	Logical device name
Control program	Select the device control program in accordance with the desired peripheral device.

Peripheral Devices that can be Controlled by Device Control Scripts

Refer to the TM-DT Series Peripheral Device Control Guide for more information.

Key input device

Setting	Setting Value
Device ID	Enter the device ID (any character string).
Device name	Select the device name of the key input device.
Control script	Select the device control script to be used for the key input device.

Serial communications

Setting	Setting Value
Device ID	Enter the device ID (any character string).
Device name	Select the device name of the serial communication device. The name can be selected from the product names and ports.
Control script	Select the device control script to be used for the serial communication device.
Communication speed(bps)	Set the communication speed of the device.
Data bit	Set the data bit.
Parity	Set the parity.
Stop bit	Set the stop bit.
Flow control	Set the flow control.

Other

Setting	Setting Value
Device ID	Enter the device ID (any character string).
Control script	Select the device control script to be used for the connected device.

TM-T88VI-iHUB

Use TM-T88VI Utility to configure device settings.

For more details, see the TM-T88VI Utility User's Manual.

Printer

Setting	Setting Value
Device ID	Enter the ID (any character string) of the printer to be controlled.
Model	Select the model of the printer to be controlled.
IP Address	Specify the IP address of the printer for each device ID.

Customer Display

Setting	Setting Value
Turn Off Backlight *	Specifies the period of time until the backlight turns off. When "0" is specified, the light is always on.
Code-page	Selects the Code Page of the customer display.
International character set	Selects an international character set of the customer display.
Adjust Brightness	Selects the brightness of the backlight. The default is "100%".
Cursor Display	Selects whether to display the cursor on the customer display screen.
Communication Settings for Customer Display	Specifies Communication speed, Parity, and Data Bit settings.

* DM-D30 only.

Key input device

Connecting key input devices to TM-T88VI-iHUB allows them to be automatically registered.

Device IDs are also automatically configured.

Setting	Setting Value
Keyboard Layout	Selects a keyboard type.

Serial communications

Connecting serial communication device to TM-T88VI-iHUB allows them to be automatically registered.

Device IDs are also automatically configured.

Other TM-i Series

Configure the following settings for each device connected to the TM-i printer.

Configure the settings using EPSON TMNet WebConfig.

Printer

Setting	Setting Value
Device ID	Enter the ID (any character string) of the printer to be controlled.
Model	Select the model of the printer to be controlled.
IP Address	Specify the IP address of the printer for each device ID.
Retry interval(ms)	Specify the retry interval after timeout.

Customer Display

Setting	Setting Value
Customer Display	Set whether or not this is used.
Communications settings	Set the communication speed, data bit and parity.
Brightness settings	Set the brightness of the customer display.



The device ID of the customer display is fixed to "local_display".

Key input device

Setting	Setting Value
Device ID	Enter the device ID (any character string).
Device name	Select the device name of the key input device.
Control Script	Select the device control script to be used for the key input device.

Serial communications

Setting	Setting Value
Serial communications	Set whether or not this is used.
Communication speed(bps)	Set the communication speed of the device.
Data bit	Set the data bit.
Parity	Set the parity.
Stop bit	Set the stop bit.
Flow control	Set the flow control.



The device ID of the serial communication device is fixed to "local_serial".

TM-H6000V

Use TM-H6000V Utility to configure device settings.
For more details, see the TM-H6000V Utility User's Manual.

Printer

Setting	Setting Value
Device ID	Enter the ID (any character string) of the printer to be controlled.

Customer Display

Setting	Setting Value
Adjust Brightness	Selects the brightness of the backlight. The default is "100%".

Programming Guide

This chapter describes how to write programs in the application development using ePOS-Device.

Programming Flow

The basic programming sequence of ePOS-Device XML is as follows:

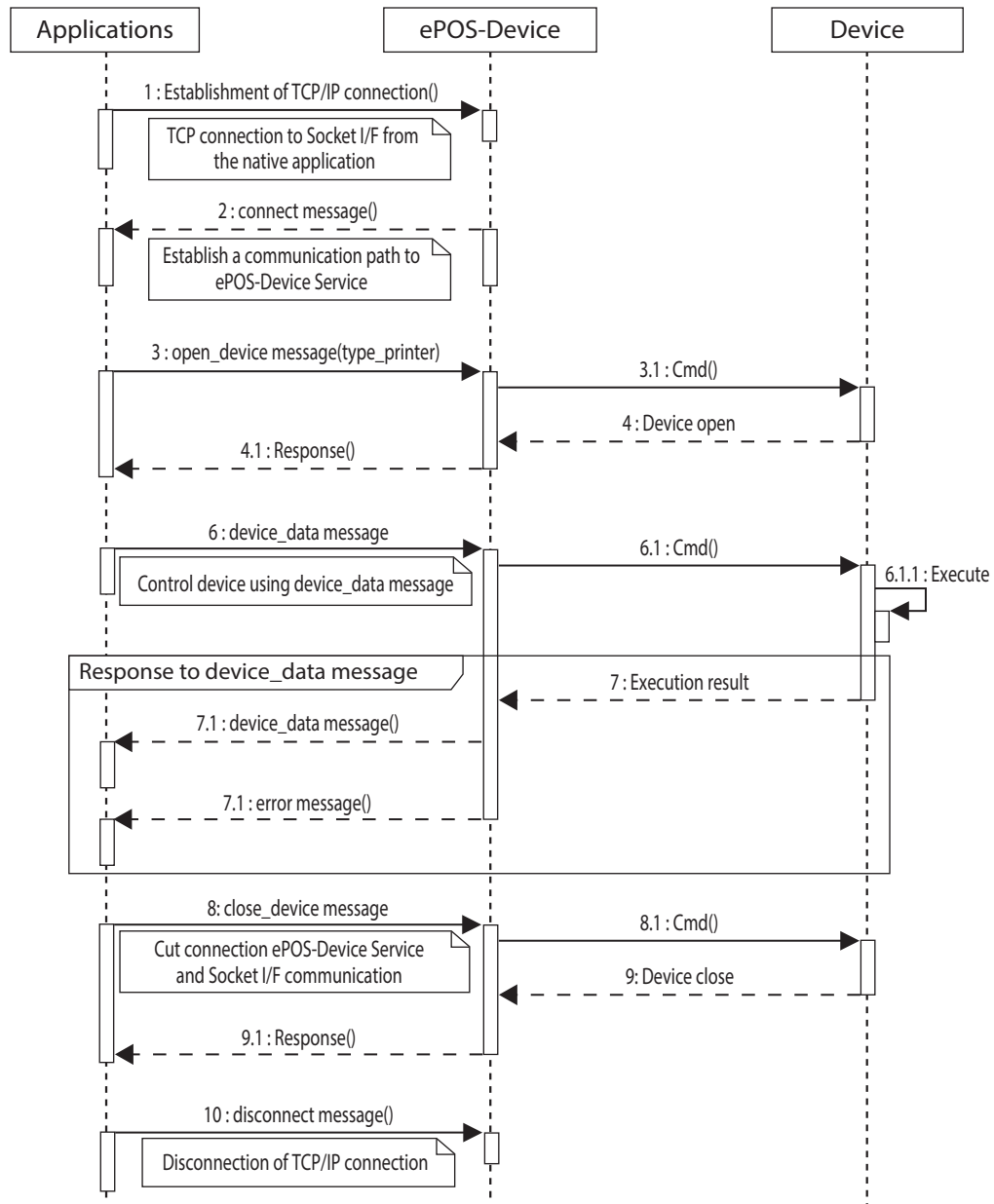

If Reconnecting to the printer when the Network was Cut Off

If network communication with the printer is cut off, the client application will reconnect. By reconnecting, you can use the devices that were open without reopening them. Also, through the settings for opening, the data to be sent to the client application that occurred while the network was cut off can be received upon reconnection. The following sequence explains the message flow necessary upon reconnection and the necessary parameters.

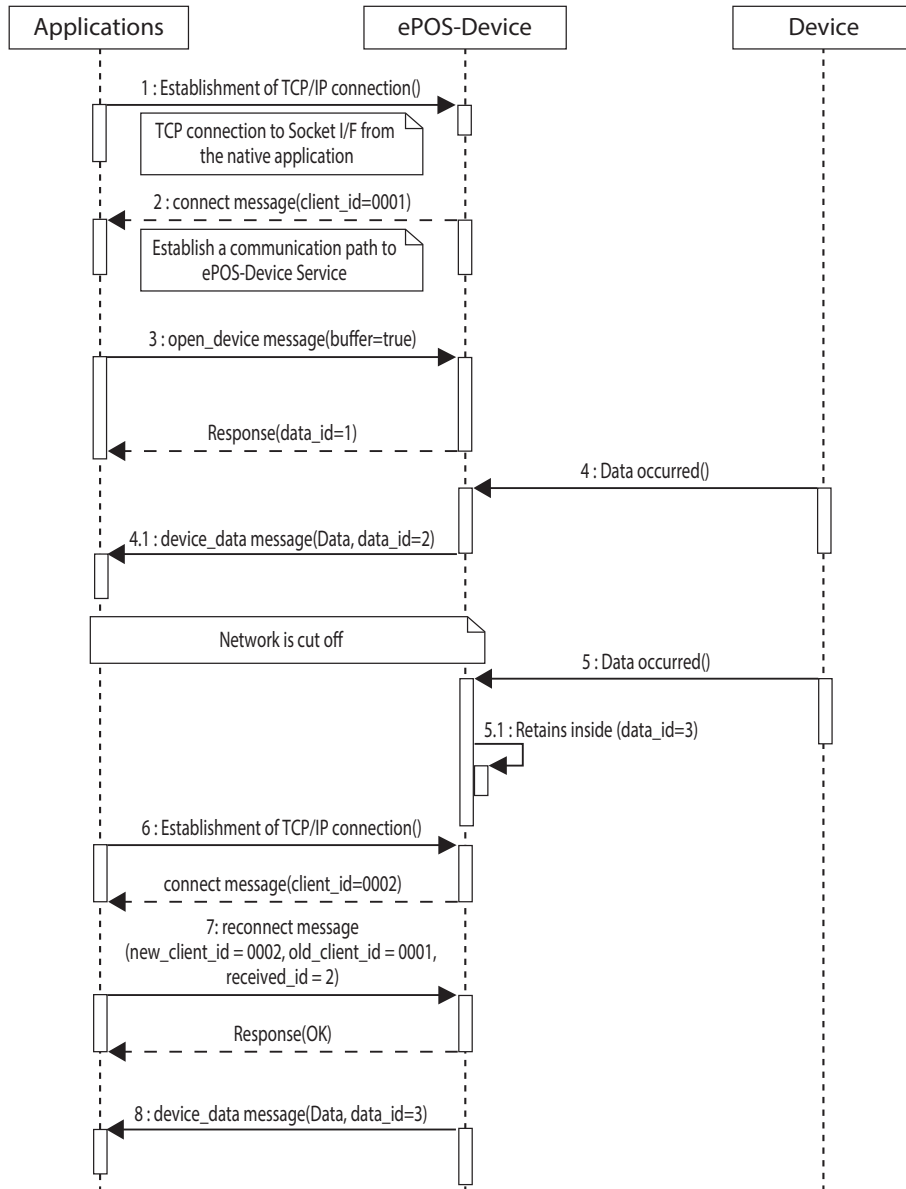

To open an unopen device from the client, be sure to send a <disconnect> message when closing the application. Also, in cases where you cannot send a <disconnect> message when closing the application, store the previous <client_id> in the application's permanent memory beforehand, and upon the next start-up, use the previous <client_id> to send a <disconnect> message.

Programming flow for the Communication Box

The following indicates the basic programming sequence using the Communication Box.

[1/2]

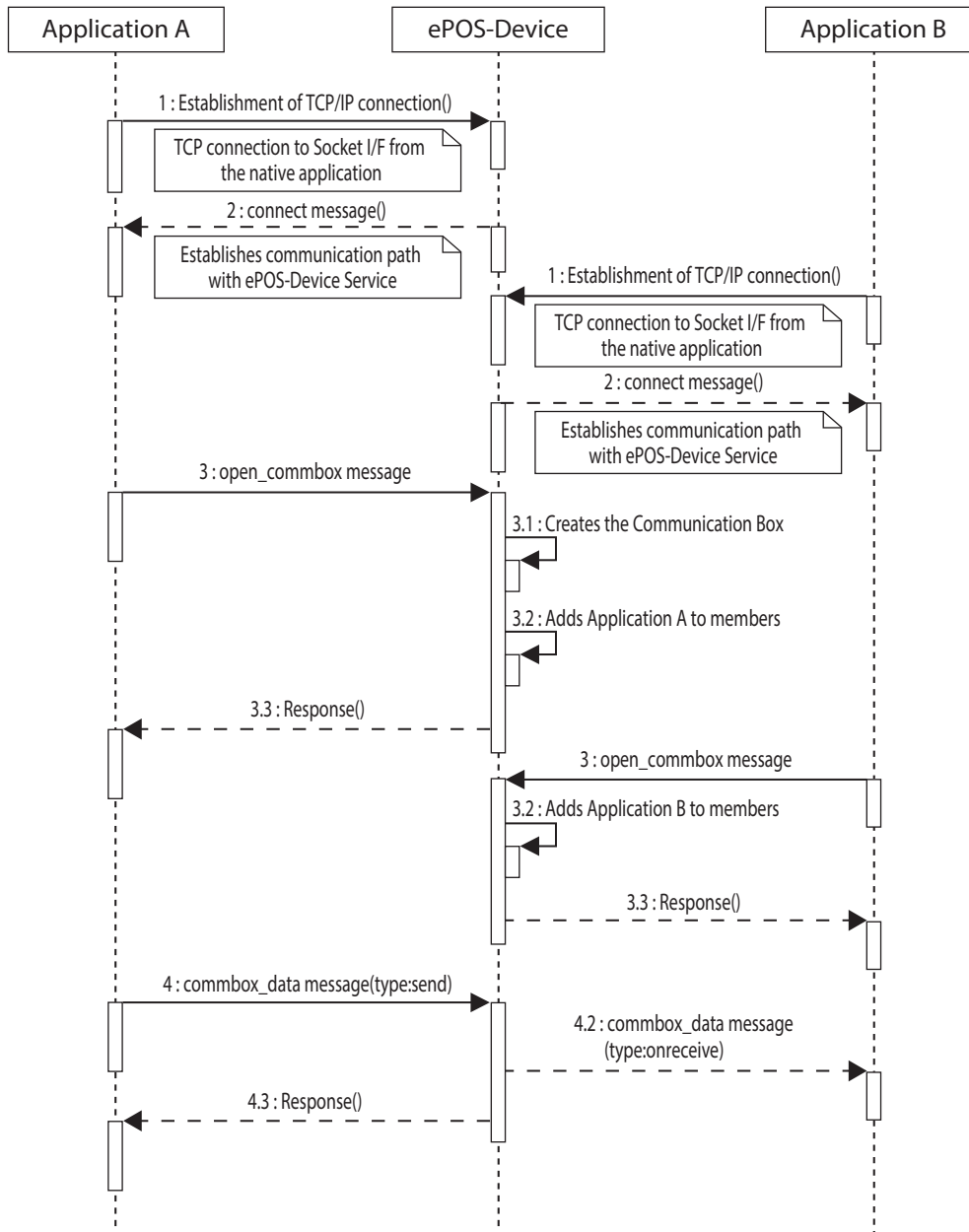

[2/2]

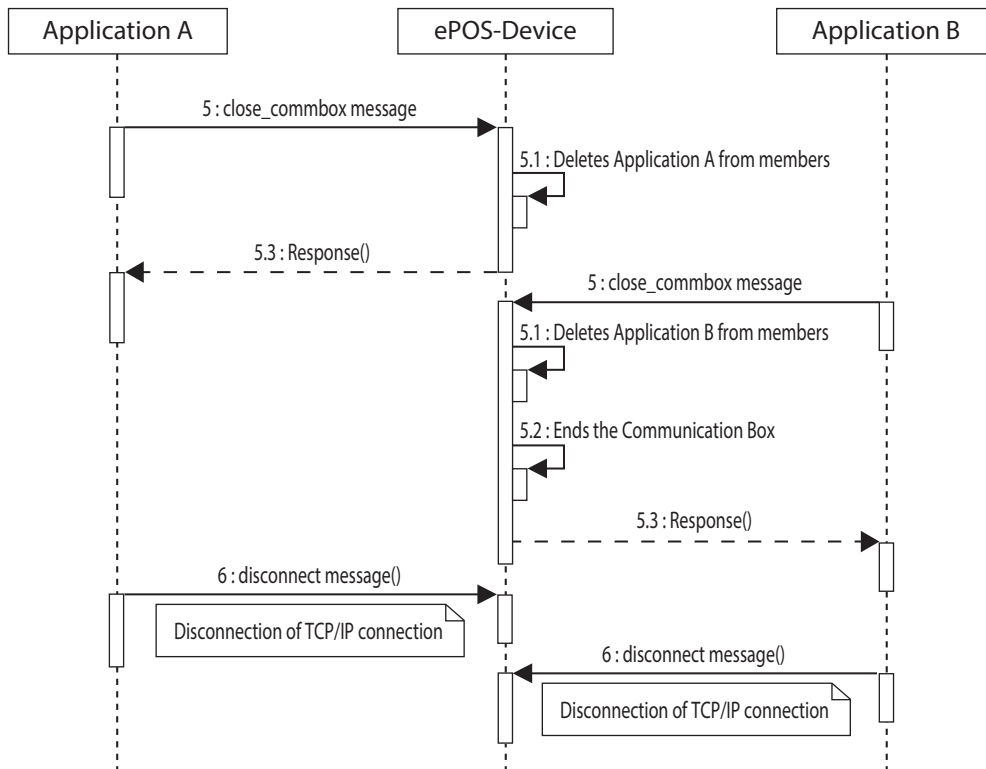

If automatically reconnecting the network

If network communication with the printer was reconnected, the Communication Box sequence is as follows.

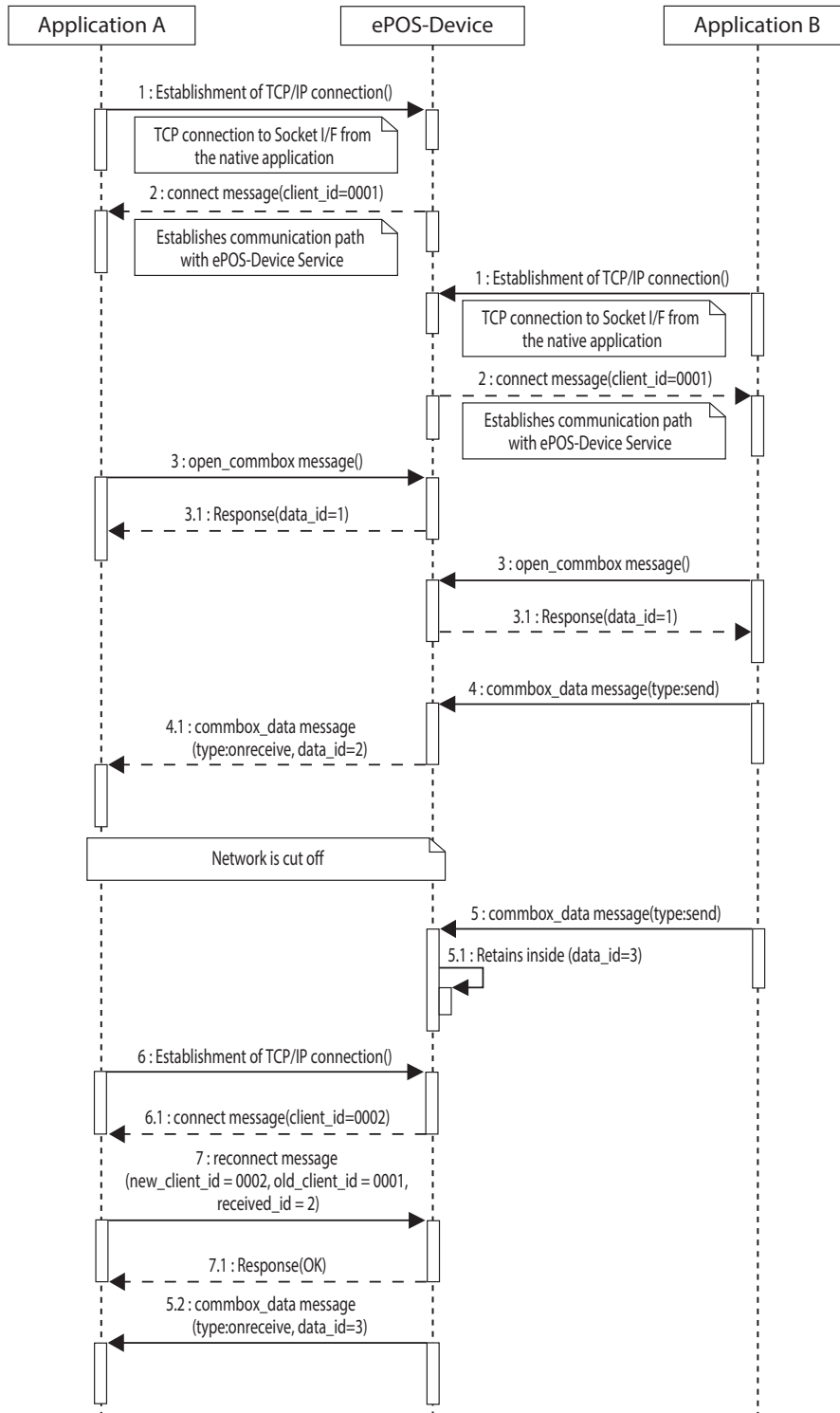

Performing check process

Use HybridPrinter message data to control the printer.

The following sequence diagram shows the flow from endorsement printing after MICR reading to slip printing.

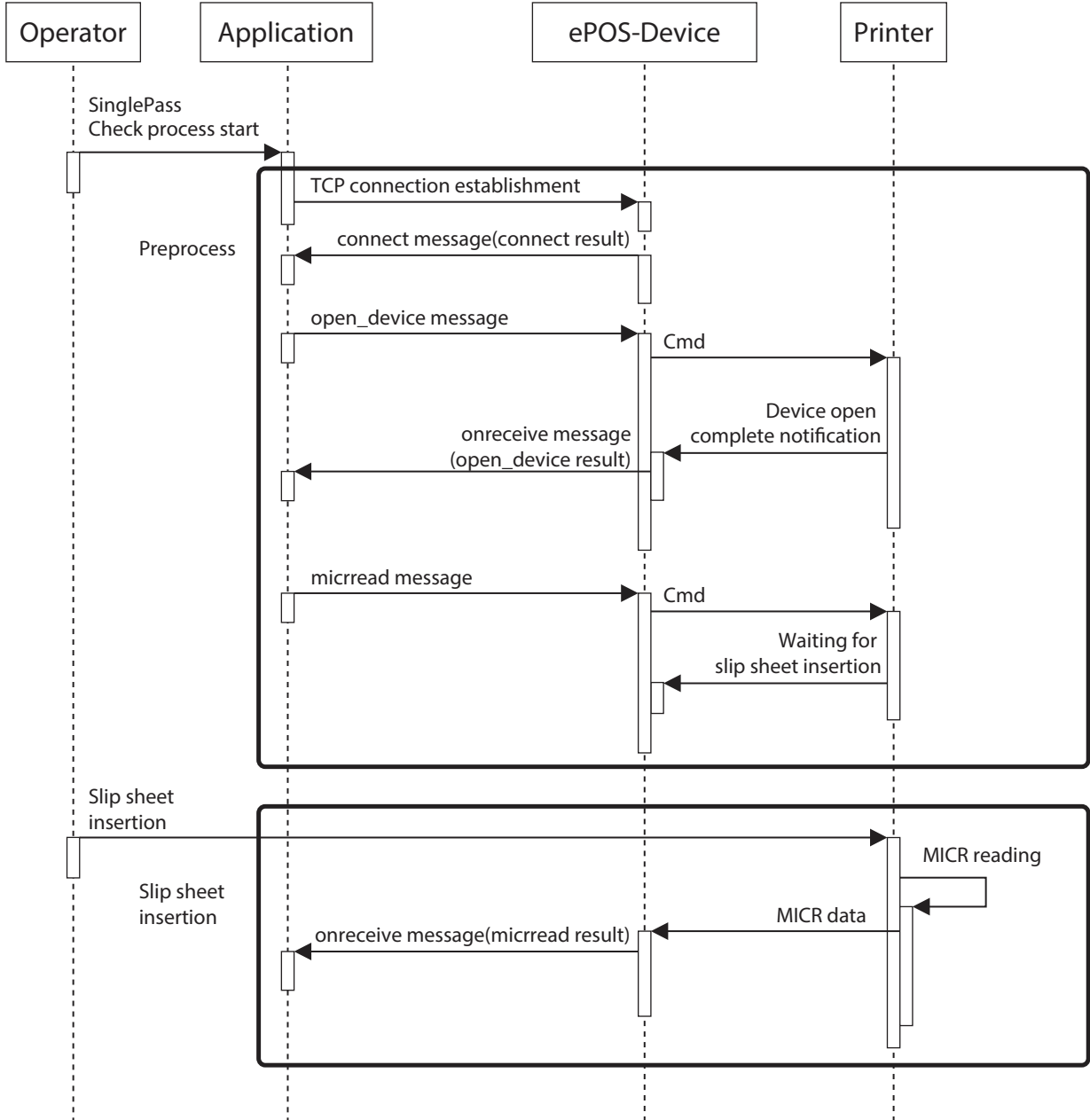

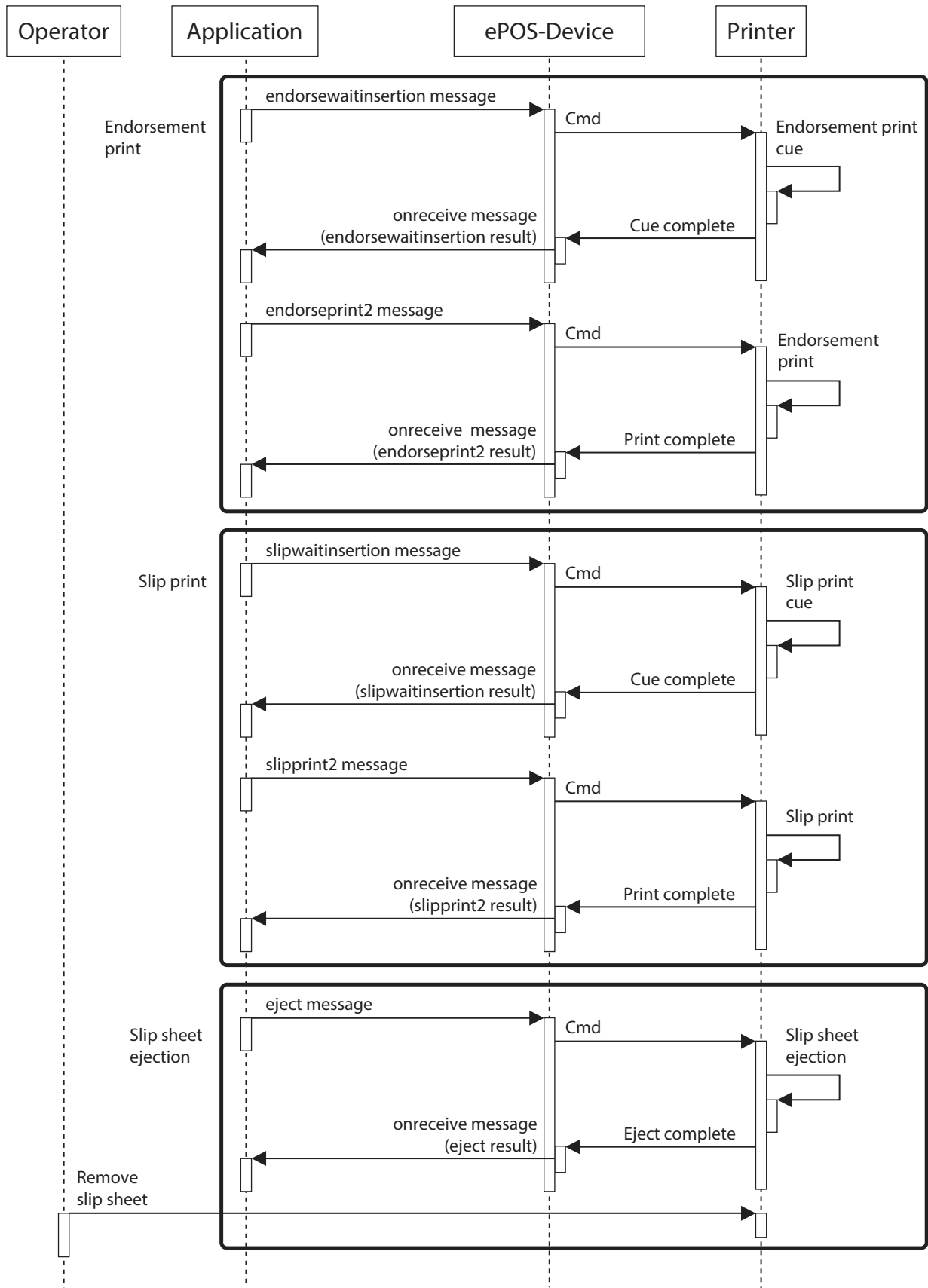

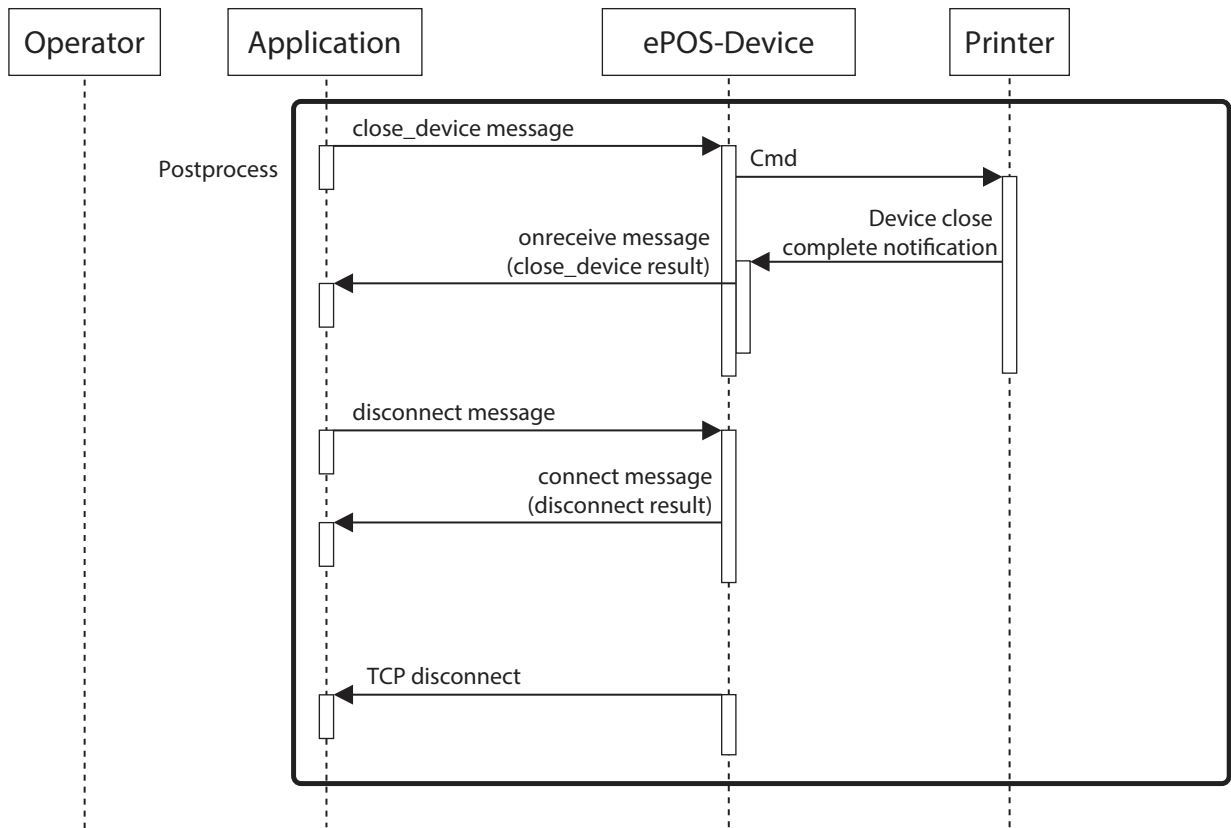

Using the Spooler Function

A printing job will be executed immediately and a response will be returned to the application after printing is complete when sending a printing request to ePOS-Device Service from the application when the spooler function is disabled.

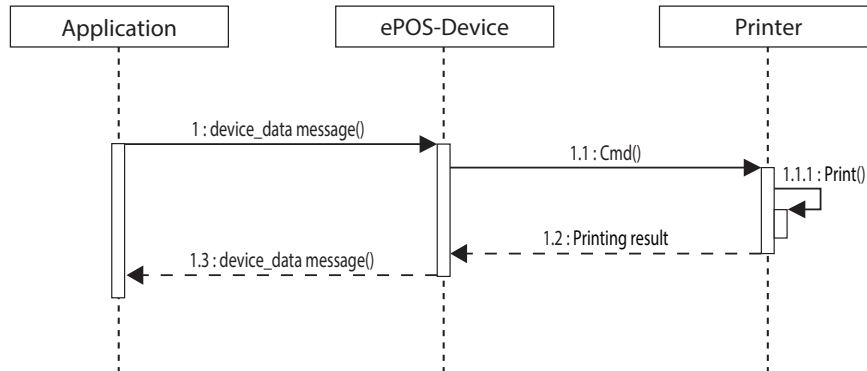

The print data job will be added to the queue and a response will be returned to the application without waiting for printing to complete when sending a printing request to ePOS-Device Service from the application when the spooler function is enabled.

Even if the output printer cannot complete the printing task, ePOS-Device Service does not return an error to the application. Printing on a substitute printer can be done by enabling print forwarding.

The application can obtain printing results at a later time by specifying the print job ID and requesting empty print data. Refer to the sequence diagram below.

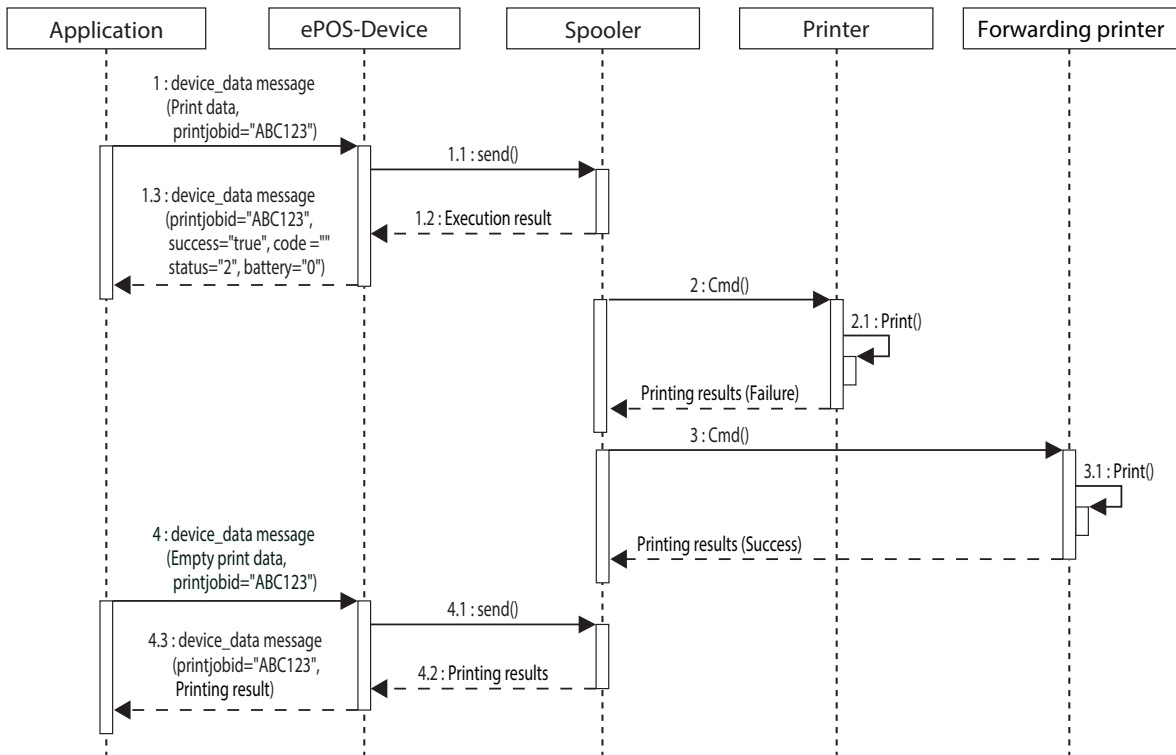

Service Interface Specifications

To enable control using ePOS-Device XML, use the following interface:

Transport layer	Port No.
TCP (non-encrypted)	8009
TCP (encrypted)	8143



The following products support TCP (encrypted).

- TM-DT Series
- TM-T88VI-iHUB
- TM-m30
- TM-H6000V

Format

The format and description of each data item are as follows:

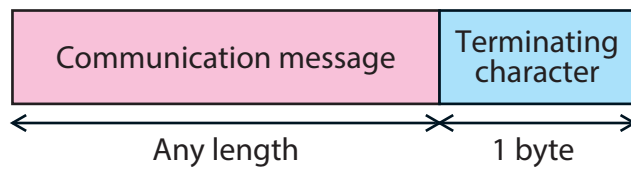

Data name	Description
Communication message	"UTF-8" character string in XML format Any length
Terminating character	NULL character ("\0") 1 byte

Communication Data Example

Examples of communication data between the application and ePOS-Device are as shown below, where the NULL character is indicated as "\0".

Applications		ePOS-Device	Description
Establishment of TCP/IP connection	➔		Establishment of connection
	➔	<pre><connect> <data> <client_id>sock3514555410 </client_id> <protocol_version>2 </protocol_version> </data> </connect>\0"</pre>	
<admin_info></admin_info>\0"	➔		Acquisition of the administrator information.
	➔	<pre><admin_info> <code>OK</code> <data> <admin_name>ep-admin</ admin_name> <location>Counter01</location> </data> </admin_info>\0"</pre>	
<pre><open_device> <device_id>keyboard01</ device_id> <data> <type>type_keyboard</type> <buffer>>true</buffer> </data> </open_device>\0"</pre>	➔		Device open
	➔	<pre><open_device> <device_id>keyboard01</ device_id> <code>OK</code> <data_id>1</data_id> </open_device>\0"</pre>	
<pre><device_data> <device_id>keyboard01</ device_id> <data> <type>setprefix</type> <keycodes array="true">49 </keycodes> <keycodes>50</keycodes> <keycodes>51</keycodes> </data> </device_data>\0"</pre>	➔		Device control

Applications		ePOS-Device	Description
	←	<pre><device_data> <device_id>keyboard01</ device_id> <data> <type>onkeypress</type> <keycode>49</keycode> <ascii>a</ascii> </data> <data_id>2</data_id> </device_data>"\0"</pre> <pre><device_data> <device_id>keyboard01</ device_id> <data> <type>onstring</type> <input>11223344556677</input> <prefix>a</prefix> </data> <data_id>3</data_id> </device_data>"\0"</pre>	Device control
		Key event (data_id=4) occurred	Detect a disconnection
	←	<pre><connect><data> <data> <client_id>sock3514555411 </client_id> <protocol_version>2 </protocol_version> </data></data></connect>"\0"</pre>	Begin reconnection
<pre><data> <old_client_id>sock3514555410 </old_client_id> <new_client_id>sock3514555411 </new_client_id> <received_id>3</received_id> </data> </reconnect></pre>	→		
	←	<pre><reconnect> <code>OK</code> </reconnect>"\0"</pre> <pre><device_data> <device_id>keyboard01</ device_id> <data> <type>onkeypress</type> <keycode>50</keycode > <ascii>b</ascii > </data> <data_id>4</data_id> </device_data>"\0"</pre>	
<pre><close_device> <device_id>keyboard01</ device_id> </close_device>"\0"</pre>	→		Device close
	←	<pre><close_device> <device_id>keyboard01</ device_id> <code>OK</code> <data_id>5</data_id> </close_device>"\0"</pre>	

Applications		ePOS-Device	Description
<pre><disconnect> <data> <client_id>sock3514555411 </client_id> </data> </disconnect></pre>	➔		Disconnection of connection

Communication Box Message Example

Application A		ePOS-Device		Application B
• Opens the Communication Box				
<pre><open_commbox> <sequence>1</sequence> <data> <box_id> box1 </box_id> <member_id> member1 </member_id> </data> </open_commbox>"\0"</pre>	➔			
	➔	<pre><open_commbox> <sequence>1</sequence> <data> <box_id>box1</box_id> <code>OK</code> </data> <data_id>1</data_id> </open_commbox>"\0"</pre>		
			➔	<pre><open_commbox> <sequence>1</sequence> <data> <box_id> box1 </box_id> <member_id> member2 </member_id> </data> </open_commbox>"\0"</pre>
		<pre><open_commbox> <sequence>1</sequence> <data> <box_id>box1</box_id> <code>OK</code> </data> <data_id>1</data_id> </open_commbox>"\0"</pre>	➔	

Application A		ePOS-Device		Application B
• Forwards data to the Communication Box				
<pre><commbox_data> <sequence>2</sequence> <data> <type>send</type> <box_id>box1</box_id> <message> send_message </message> </data> </commbox_data>"\0"</pre>	➔			
		<pre><commbox_data> <sequence>2</sequence> <data> <type>onreceive</type> <box_id>box1</box_id> <sender_id> member1 </sender_id> <receiver_id> </receiver_id> <message> send_message </message> </data> <data_id>2</data_id> </commbox_data>"\0"</pre>	➔	
	➔	<pre><commbox_data> <sequence>2</sequence> <data> <type>send</type> <box_id>box1</box_id> <code>OK</code> <count>1</count> </data> <data_id>2</data_id> </commbox_data>"\0"</pre>		

Application A		ePOS-Device		Application B
<ul style="list-style-type: none"> Acquires the transfer history of the Communication Box 				
			←	<pre><commbox_data> <sequence>2</ sequence> <data> <type> getcommhistory </type> <box_id>box1</ box_id> </data> </commbox_data>"\0"</pre>
		<pre><commbox_data> <sequence>2</sequence> <data> <type> getcommhistory </type> <box_id>box1</box_id> <code>OK</code> <history_list> <senderId> member1 </senderId> <receiverId> </receiverId> <message> send_message </message> </history_list> </data> <data_id>3</data_id> </commbox_data>"\0"</pre>	→	
<ul style="list-style-type: none"> Closes the Communication Box 				
<pre><close_commbox> <sequence>3</ sequence> <data> <box_id>box1</ box_id> </data> </close_commbox>"\0"</pre>	→			
		<pre><close_commbox> <sequence>3</sequence> <data> <box_id>box1</box_id> <code>OK</code> </data> <data_id>3</data_id> </close_commbox>"\0"</pre>	←	
			←	<pre><close_commbox> <sequence>3</ sequence> <data> <box_id>box1</ box_id> </data> </close_commbox>"\0"</pre>

Application A		ePOS-Device		Application B
		<pre><close_commbox> <sequence>3</sequence> <data> <box_id>box1</box_id> <code>OK</code> </data> <data_id>4</data_id> </close_commbox>"\0"</pre>	➔	

Array of <data> elements in <device_data> message

The following programming method is used to describe an array in the <data> tag:

- Specify the attribute array="true" at the beginning of the element to be used for the array.
- After that, specify a value with the same element name.

Example: To express "keycodes=[49, 50, 51, 52];"

```
<data>
<type>setprefix</type>
<keycodes array="true">49</keycodes>
<keycodes>50</keycodes>
<keycodes>51</keycodes>
<keycodes>52</keycodes>
</data>
```

XML Reference

ePOS-Device XML has the following hierarchical structure.

Message

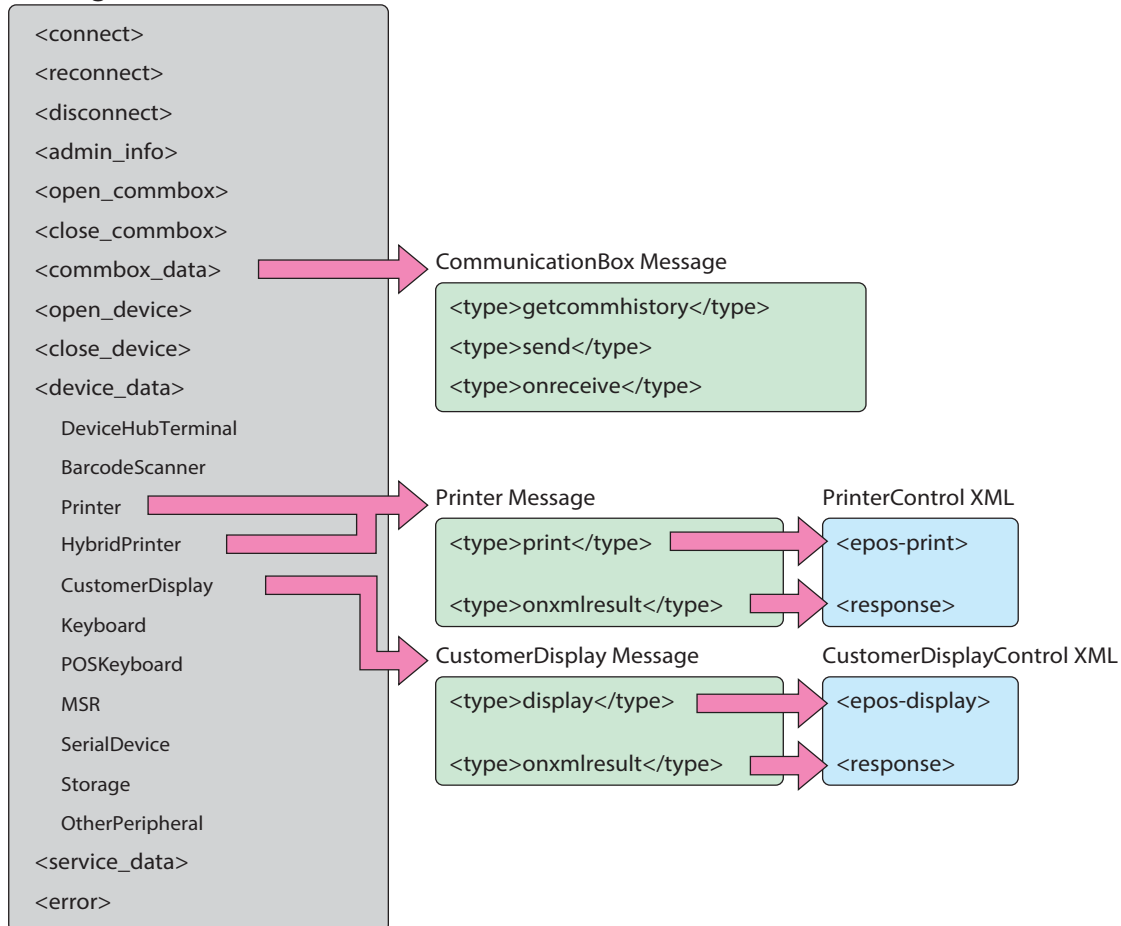

List of ePOS-Device XMLs

The ePOS-Device XMLs provide the following.

Message

These XMLs are messages requested from applications to the printer and returned from the printer to applications.

The number of messages in the data sent in one request from the application is 1.

To send multiple messages, send the data again for the number of times corresponding to the number of messages.

Message		Description
Message data for communication path	<connect>	Establishes the communication path.
	<reconnect>	Reestablishes the communication path.
	<disconnect>	Disconnects the communication path.
Message data for management information	<admin_info>	Acquires the administrator and installation location information.
CommunicationBox Messages	<open_commbox>	Opens the communication box.
	<close_commbox>	Closes the communication box.
	<commbox_data>	Communicates between applications.
Message data for device communication	<open_device>	Opens communication with a device.
	<close_device>	Closes communication with a device.
Device Messages	<device_data>	Requests for device control.
		Responds to device control.
Message data for OFSC-Print Service	<service_data>	Requests for OFSC-Print Service.
		Responds to OFSC-Print Service.
Message data for error notification	<error>	Reports the error contents upon error occurrence.

CommunicationBox Messages

These XMLs are used to communicate data between applications.

This type of XML is a child element of the <data> element of the <commbox_data> message and specifies data for data communication between applications. Specify the type of message data with the <type> element, and then specify data for the child element. Available <type> elements are as listed below.

<type> element		Description
Transmission history	<type>getcommhistory</type>	<Request>/<Response> Acquires the transmission history of the communication box.
Transmission	<type>send</type>	<Request> Transmits data to the communication box.
Reception	<type>onreceive</type>	<Response> Notifies data from the communication box.

Device Messages

These XMLs store request and response data for each device controlled. This type of XML is a child element of the <data> element of the <device_data> message and specifies data to control a device. Components of the message data differs depending on the device type. Specify the type of message data with the <type> element, and then specify data for the child element.

Printers and customer displays can use the control XMLs to control print data and display.

Refer to [Supported Printers by XMLs](#) for the types of devices available for each printer.

Device type	Control XML
DeviceHubTerminal	-
BarcodeScanner	-
Printer	PrinterControl XML
HybridPrinter	PrinterControl XML
CustomerDisplay	CustomerDisplayControl XML
Keyboard	-
POSKeyboard	-
MSR	-
SerialDevice	-
Storage	-
OtherPeripheral	-

DeviceHubTerminal

Controls the TM-DT series.

	<type> element	Description
Shutdown	<type>shutdown</type>	<Request> Shuts down TM-DT.
	<type>onshutdown</type>	<Response> Shut-down result of TM-DT.
Restart	<type>restart</type>	<Request> Restarts TM-DT.
	<type>onrestart</type>	<Response> Restart result of TM-DT.

BarcodeScanner

Controls the scanner to read a barcode.

	<type> element	Description
Data detection	<type>ondata</type>	<Response> Scan data from the barcode scanner.

Printer

Controls printing operation of the printer.

Refer to [PrinterControl XML](#) for details of print data.

	<type> element	Description
Controls a printer.	<type>print</type>	<Request> Print data and configuration data to the printer.
	<type>onxmlresult</type>	<Response> Data from the printer.

HybridPrinter

Controls the hybrid model printers.

Refer to [PrinterControl XML](#) for details of print data.

	<type> element	Description
Device lock	<type>lock</type>	<Request> Locks the device port.
	<type>unlock</type>	<Request> Unlocks the device port.
Receipt printing	<type>print</type>	<Request> Print data and configuration data to the printer.
	<type>onxmlresult</type>	<Response> Data from the printer.
Slip printing	<type>slipwaitinsertion</type>	<Request> Waiting for insertion of a slip sheet for slip printing.
	<type>slipprint2</type>	<Request> Print data and configuration data for slip printing.
	<type>slipcancel</type>	<Request> Cancels the slip sheet insertion wait status for slip printing.
Endorsement printing	<type>endorsewaitinsertion</type>	<Request> Waiting for insertion of a slip sheet for endorsement printing.
	<type>endorseprint2</type>	<Request> Print data and setting data for endorsement printing.
	<type>endorsecancel</type>	<Request> Cancels the slip sheet insertion wait status for endorsement printing.

<type> element		Description
Validation printing	<type>validationwaitinsertion</type>	<Request> Waiting for validation sheet insertion for validation printing.
	<type>validationprint2</type>	<Request> Print data and setting data for validation printing.
	<type>validationcancel</type>	<Request> Cancels the validation sheet insertion wait status for validation printing.
MICR	<type>micread</type>	<Request> Reads MICR.
	<type>micrcleaning</type>	<Request> Cleans the MICR mechanism.
	<type>micrcancel</type>	<Request> Cancels cleaning sheet insertion wait status for cleaning MICR.
Paper eject	<type>eject</type>	<Request> Ejects the paper.
Reception of result	<type>onreceive</type>	<Response> Acquires the execution result of the request to the printer.

List of control operations

<type>element available for HybridPrinter message data depends on the operation to control.

The following lists control operation types and available <type>element.

<type>element	Control operation				
	Receipt	Slip	Endorsement	Validation	MICR
<type>lock</type>	✓	✓	✓	✓	✓
<type>unlock</type>	✓	✓	✓	✓	✓
<type>print</type>	✓	✓	✓	✓	-
<type>onxmlresult</type>	✓	✓	✓	✓	-
<type>slipwaitinsertion</type>	-	✓	-	-	-
<type>slipprint2</type>	-	✓	-	-	-
<type>slipcancel</type>	-	✓	-	-	-
<type>endorsewaitinsertion</type>	-	-	✓	-	-
<type>endorseprint2</type>	-	-	✓	-	-
<type>endorsecancel</type>	-	-	✓	-	-
<type>validationwaitinsertion</type>	-	-	-	✓	-
<type>validationprint2</type>	-	-	-	✓	-
<type>validationcancel</type>	-	-	-	✓	-
<type>micread</type>	-	-	-	-	✓

<type>element	Control operation				
	Receipt	Slip	Endorsement	Validation	MICR
<type>micrcleaning</type>	-	-	-	-	✓
<type>micrcancel</type>	-	-	-	-	✓
<type>eject</type>	-	✓	✓	✓	✓
<type>onreceive</type>	✓	✓	✓	✓	✓

CustomerDisplay

Controls text display on the customer display.

Refer to [CustomerDisplayControl XML](#) for details of display data.

<type> element		Description
Controls a customer display.	<type>display</type>	<Request> Display data and configuration data for the customer display.
	<type>onxmlresult</type>	<Response> Data from the customer display.

Keyboard

Controls character entry from the keyboard.

<type> element		Description
Key detection	<type>onkeypress</type>	<Response> A string input from the keyboard.
String setting	<type>setprefix</type>	<Request> Specifies a key code used to determine the beginning of a string to detect input from the keyboard.
String detection	<type>onstring</type>	<Response> A string input from the keyboard.
Key code setting	<type>setMSRPrefix</type>	<Request> Specifies a key code to used to determine the beginning of reception of card information from a programmable keyboard with MSR.
Data detection	<type>ondata</type>	<Response> Card information from a programmable keyboard with MSR.

POSKeyboard

Controls character entry from the POS keyboard.

<type> element		Description
Data detection	<code><data>onkeypress</data></code>	<Response> A string input from the keyboard.

MSR

Controls card reading by MSR.

<type> element		Description
Data detection	<code><data>ondata</data></code>	<Response> Data from MSR.

SerialDevice

Controls serial communication between the printer and device.

<type> element		Description
String setting	<code><type>sendcommand</type></code>	<Request> Transmits a command to a serial device.
Detects acknowledgment.	<code><type>oncommandreply</type></code>	<Response> Data from the serial device.

Storage

Connects to the German fiscal element (TSE), and controls data read/write operations.

<type> element		Description
Send	<code><type>operate</type></code>	<Request> Sends operational command data to the German fiscal element (TSE).
Reception of result	<code><type>operateresult</type></code>	<Response> Receives data from the operate request.

OtherPeripheral

Controls peripheral devices with a device control program.

<type> element		Description
Send	<code><type>User-defined Function</type></code>	<Request> Sends data to peripheral devices.

<type> element		Description
Reception of result	<type>User-defined Event</type>	<Response> Receives data from peripheral devices.

PrinterControl XML

These XMLs are used to control print operations of a printer. <epos-print> is included in the child element printdata of the <type> element print, while <response> is included in the child element resultdata of the <type> element onxmlresult.

<epos-print> and <response> can be used with the following <type> elements.

Device	<type> element	Child element	XML document
Printer	<type>print</type>	printdata	<epos-print>
	<type>onxmlresult</type>	resultdata	<response>
HybridPrinter	<type>print</type>	printdata	<epos-print>
	<type>onxmlresult</type>	resultdata	<response>
	<type>slipprint2</type>	printdata	<epos-print>
	<type>endorseprint2</type>		
	<type>validationprint2</type>		

Creating print document

These XMLs request the printer to execute a print function specified with <epos-print> and acquires the execution result with <response>.

XML document	Child element	Function
<epos-print>	<text>	Prints text.
	<feed>	Paper feed
	<image>	Prints a raster image.
	<logo>	Prints the NV logo.
	<barcode>	Prints a barcode.
	<symbol>	Prints a 2D symbol.
	<hline>	Prints a horizontal ruled line.
	<vline-begin>	Starts printing a vertical ruled line.
	<vline-end>	Ends printing a vertical ruled line.
	<page>	Switches to the page mode
	<area>	Defines the print area in the page mode.
	<direction>	Specifies the print direction in the page mode.
	<position>	Specifies the print position in the page mode.
<line>	Draws a line in the page mode.	

XML document	Child element	Function
<epos-print>	<rectangle>	Draws a shape in the page mode.
	<cut>	Cuts the sheet.
	<pulse>	Kicks the drawer.
	<sound>	Sounds the buzzer.
	<command>	Inserts a command.
	<layout>	Sets the page layout.
	<recovery>	Recovers from a recoverable error.
	<reset>	Resets the printer.
	<batch-begin>	Starts the batch normal print mode.
	<batch-end>	Ends the batch normal print mode.
	<rotate-begin>	Starts the batch rotate print mode.
	<rotate-end>	Ends the batch rotate print mode.
<response>	Acquires the execution result.	

The print mode includes the standard mode, page mode, batch normal print mode, and the batch rotate print mode.

- Standard mode
Prints data line by line. Line spacing is automatically adjusted according to character size, image size, and barcode height. Suitable for printing receipts whose print length varies by print content.
- Page mode
Prints page by page. Prints characters, images, and/or barcodes on a single page that is defined as a print area.
To print in the page mode, switch to the page mode using <page>.
- Batch normal print mode
This is a print mode in which the range of the print data (such as characters, images, barcodes, etc.) is set, and the print data in the set range is compiled, and then printed.
Unlike the standard mode, printing starts after the entire print data has been received.
When performing the processing in the batch normal print mode, start the batch normal print processing with <batch-begin>, and end the batch normal print processing with <batch-end>.
- Batch rotate print mode
This is a print mode in which the range of the print data (such as characters, images, barcodes, etc.) is set, the print data in the set range is compiled, inverted, and then printed.
When performing the processing in the batch rotate print mode, start the batch rotate print processing with <rotate-begin>, and end the batch rotate print processing with <rotate-end>.

The child elements that can be used in each mode are described in the table below.

XML document	Child element	Standard mode	Page mode	Batch normal print mode	Batch rotate print mode
<epos-print>	<text>	✓	✓	✓	✓
	<feed>	✓	✓	✓	✓

XML document	Child element	Standard mode	Page mode	Batch normal print mode	Batch rotate print mode
<epos-print>	<image>	✓	✓	✓	✓
	<logo>	✓	✓	✓	✓
	<barcode>	✓	✓	✓	✓
	<symbol>	✓	✓	✓	✓
	<hline>	✓	-	✓	✓
	<vline-begin>	✓	-	✓	✓
	<vline-end>	✓	-	✓	✓
	<page>	✓	-	-	-
	<area>	-	✓	-	-
	<direction>	-	✓	-	-
	<position>	-	✓	-	-
	<line>	-	✓	-	-
	<rectangle>	-	✓	-	-
	<cut>	✓	-	-	-
	<pulse>	✓	-	-	-
	<sound>	✓	-	-	-
	<command>	✓	✓	✓	✓
	<layout>	✓	-	✓	✓
	<recovery>	✓	-	-	-
	<reset>	✓	-	-	-
	<batch-begin>	✓	-	-	-
<batch-end>	✓	-	✓	-	
<rotate-begin>	✓	-	-	-	
<rotate-end>	✓	-	-	✓	
<response>		✓	✓	✓	✓

List of support per print method

Child element	Print method				
	Receipt	Slip	Endorsement	Endorsement (40cpl)	Validation
<text>	✓	✓	✓	✓	✓
<feed>	✓	✓	✓	✓	✓
<image>	✓	-	-	-	-
<logo>	✓	-	-	-	-
<barcode>	✓	-	-	-	-

Child element	Print method				
	Receipt	Slip	Endorsement	Endorsement (40cpl)	Validation
<symbol>	✓	-	-	-	-
<hline>	✓	-	-	-	-
<vline-begin>	✓	-	-	-	-
<vline-end>	✓	-	-	-	-
<page>	✓	✓	-	-	✓
<area>	✓	✓	-	-	✓
<direction>	✓	✓	-	-	✓
<position>	✓	✓	-	-	✓
<line>	✓	✓	-	-	-
<rectangle>	✓	✓	-	-	-
<cut>	✓	-	-	-	-
<pulse>	✓	✓	✓	✓	✓
<sound>	✓	-	-	-	-
<command>	✓	✓	✓	✓	✓
<layout>	✓	-	-	-	-
<recovery>	✓	✓	✓	✓	✓
<reset>	✓	✓	✓	✓	✓

List of child element default values

The default values of the child elements are listed below.

These values are effective before executing a child element defined on the printer device.

Child element	Attribute	Default value
<text>	lang	"en"
	font	"font_a"
	smooth	"false" / "0"
	dw	"false" / "0"
	dh	"false" / "0"
	width	"1"
	height	"1"
	reverse	"false" / "0"
	ul	"false" / "0"
	em	"false" / "0"
	color	"color_1"

Child element	Attribute	Default value
<text>	x	"0"
	y	"21"
	align	"left"
	rotate	"false" / "0"
	linespc	Depends on the printer model.
<feed>	linespc	For details, refer to Printer-specific Support Information.
<image>	color	"color_1"
	align	"left"
	mode	"mono"
<logo>	align	"left"
<barcode>	hri	"none"
	font	"font_a"
	width	"3"
	height	"162"
	align	"left"
	rotate	"false" / "0"
<symbol>	level	Depends on the 2D symbol type. Refer to <symbol> for details.
	width	
	hight	
	size	
	align	"left"
	rotate	"false" / "0"
<area>	x	"0"
	y	"0"
	width	Depends on the printer model.
	height	For details, refer to Printer-specific Support Information.
<direction>	dir	"left_to_right"
<position>	x	"0"
	y	"21"

CustomerDisplayControl XML

These XMLs control text display on the customer display. <epos-display> and <response> are XMLs included in the child element displaydata of <type>display</type> and the child element resultdata of <type>onxmlresult</type>, respectively. These XMLs request the customer display to execute a function specified with <epos-display> and acquires the execution result with <response>.

XML document	Child element	Function
<epos-display>	<window>	Configures the window.
	<screen>	Base window settings
	<textarea>	Window settings
	<cursor>	Displays cursor.
	<text>	Displays text.
	<marquee>	Displays a marquee.
	<blink>	Blinks display.
	<brightness>	Changes the display brightness.
	<backgroundcolor>	Sets the background color.
	<slideshow>	Slide show settings
	<downloadimage>	Displays an image.
	<registerdownloadimage>	Registers an image.
	<nvimage>	Displays an NV image.
	<clearimage>	Deletes an image.
	<symbol>	Displays a two-dimensional symbol.
	<clearsymbol>	Deletes a two-dimensional symbol.
	<clock>	Displays the clock.
	<clear>	Clears the current display area.
	<reset>	Reset
<command>	Runs a command.	
<response>		Acquires the execution result of <epos-display>.

The default values of the child elements are listed below.

These values are effective before executing a child element defined on the device.

Child element	Attribute	Default value
<window>	scrollmode	"overwrite"
	destroy	"false" / "0"

Child element	Attribute	Default value
<textarea>	x	"0"
	y	"0"
	width	"0"
	height	"0"
	scrollmode	"overwrite"
	destroy	"false" / "0"
<text>	reverse	"false" / "0"
	lang	"en"
<marquee>	format	"walk"
	repeat	"0"
	lang	"en"
<slideshow>	stop	"false" / "0"
<downloadimage>	x	"0"
	y	"0"
	width	"0"
	height	"0"
<nvimage>	x	"0"
	y	"0"
	width	"0"
	height	"0"
<symbol>	dotx	"0"
	doty	"0"
	quietzone	"false" / "0"

The child elements and attributes that can be used vary depending on the customer display used and its display modes.

The table below shows the child elements that can be used in each customer display and display mode.

Child element	Attribute	DM-D30	DM-D70 (Standard mode)	DM-D70 (Column/row fixed mode)	DM-D110/ DM-D210
<window>		✓	-	✓	✓
<screen>		-	✓	✓	-
<textarea>		-	✓	-	-
<cursor>	x	✓	✓	✓	✓
	y	✓	✓	✓	✓
	moveto	✓	✓	✓	✓
	type	✓	-	-	✓

Child element	Attribute	DM-D30	DM-D70 (Standard mode)	DM-D70 (Column/row fixed mode)	DM-D110/ DM-D210
<text>	x	✓	✓	✓	✓
	y	✓	✓	✓	✓
	reverse	✓	-	-	✓
	lang	✓*	✓	✓	✓*
	color	-	✓	-	-
<marquee>		✓	✓	✓	✓
<blink>		✓	-	-	✓
<brightness>		✓	✓	✓	✓
<backgroundcolor>		-	✓	-	-
<slideshow>		-	✓	-	-
<downloadimage>		-	✓	-	-
<registerdownloadimage>		-	✓	-	-
<nvimage>		-	✓	-	-
<clearimage>		-	✓	-	-
<symbol>		-	✓	-	-
<clearsymbol>		-	✓	-	-
<clock>		-	-	-	✓
<clear>		✓	✓	✓	✓
<reset>		✓	✓	✓	✓
<command>		✓	✓	✓	✓

*: The setting value "mul" cannot be used.

Message

Connects an application to the printer.

The number of messages in the data sent in one request from the application is 1.

To send multiple messages, send the data again for the number of times corresponding to the number of messages.

<connect>

Connects ePOS-Device Service of the printer and an application, and then notifies the application of this connection.

Response

Element	Data type	Description
data	string	Connection information

data

Child element	Data type	Description
client_id	string	ID of the connected application
protocol_version	string	Protocol version of the connected printer

Sample program

```
<connect>
  <data>
    <client_id>1234567890</client_id>
    <protocol_version>2.0</protocol_version>
  </data>
</connect>
```

Supplementary explanation

- Configure an application to send a message upon receipt of the <connect> message.
- Connection is notified to the application only when the connection has been established successfully.

<reconnect>

Requests for reconnection between the printer and the network, and then notifies the application of the acquired result.

Request

Element	Data type	Description
old_client_id	string	Specify the client_id received by <connect> in the previous session.
new_client_id	string	Specify the client_id received by <connect> in the current session.
received_id	int	Specify the last data_id of those received in each data communication.

Sample program

```
<reconnect>
  <data>
    <new_client_id>1234567890</new_client_id>
    <old_client_id>0987654321</old_client_id>
    <received_id>112</received_id>
  </data>
</reconnect>
```

Response

Element	Data type	Description
code	string	Reconnection confirmation result

code

Element value	Description
"OK"	Reconnection succeeded.
"CLIENT_NOT_FOUND"	Connection corresponding to the specified client_id does not exist.
"PARAM_ERROR"	A parameter error occurred.
"SYSTEM_ERROR"	A system error occurred.

Sample program

- Normal case

```
<reconnect>
  <code>OK</code>
</reconnect>
```

- Abnormal case

```
<reconnect>
  <code>PARAM_ERROR</code>
</reconnect>
```

<disconnect>

Requests for disconnection of communication established by [<connect>](#) and notifies the application of the acquired request result.

Request

Element	Data type	Description
data	string	Specifies the application to disconnect.

data

Child element	Data type	Description
client_id	string	Specifies the client_id to disconnect.

Sample program

```
<disconnect>
  <data>
    <client_id>1234567890</client_id>
  </data>
</disconnect>
```

Response

Element	Data type	Description
code	string	Disconnection result

code

Element value	Description
"OK"	Disconnection succeeded.
"PARAM_ERROR"	A parameter error occurred.
"SYSTEM_ERROR"	A system error occurred.

Sample program

- Normal case

```
<disconnect>
  <code>OK</code>
</disconnect>
```

- Abnormal case

```
<disconnect>
  <code>PARAM_ERROR</code>
</disconnect>
```

<admin_info>

Requests for administrator data registered in the printer, and then notifies the application of the acquired result.

Request**Sample program**

```
<admin_info></admin_info>
```

Response

Element	Data type	Description
code	string	Acquisition result of the administrator data.
data	string	Acquired administrator data.

code

Element value	Description
"OK"	Successfully acquired.
"PARAM_ERROR"	A parameter error occurred.
"SYSTEM_ERROR"	A system error occurred.

data

Child element	Data type	Description
admin_name	string	Administrator data
location	string	Installation location data

Sample program

- Normal case

```
<admin_info>
  <code>OK</code>
  <data>
    <admin_name>Administrator A</admin_name>
    <location>Counter1&amp;Counter2</location>
  </data>
</admin_info>
```

- Abnormal case

```
<admin_info>
  <code>PARAM_ERROR</code>
</admin_info>
```

Supplementary explanation

- ❑ Set the administrator information using EPSON TMNet WebConfig.
- ❑ Data is notified to the application only when it has been acquired successfully.

<open_commbox>

Requests for opening the communication box and notifies the application of the acquired request result. ePOS-Device Service creates a communication box and add the application as a member of the communication box.

Request

Element	Data type	Description
sequence	string	Specifies the sequence number.
data	string	Specifies the data of the communication box to open.

data

Child element	Data type	Description
box_id	string	Identifier of the communication box to open
member_id	string	Member ID used by the application to identify itself within the communication box

Sample program

```
<open_commbox>
  <sequence>1</sequence>
  <data>
    <box_id>box1</box_id>
    <member_id>member1</member_id>
  </data>
</open_commbox>
```

Response

Element	Data type	Description
sequence	string	Sequence number specified in the request
data	string	Result of opening the communication box
data_id	string	ID to identify sent data

data

Child element	Data type	Description
box_id	string	Identifier of the opened communication box
code	string	Result of opening the communication box

- code

Element value	Description
"OK"	Communication box opened successfully.

Element value	Description
"ALREADY_OPENED"	Communication box is already open.
"MEMBERID_ALREADY_USED"	Specified member ID is already in use.
"BOX_COUNT_OVER"	The number of created communication boxes has exceeded the upper limit.
"BOX_CLIENT_OVER"	The number of members belong to the communication box has exceeded the upper limit.
"ERROR_NOT_SUPPORTED"	The printer does not support the requested function.
"PARAMETER_ERROR"	A parameter error occurred.
"SYSTEM_ERROR"	A system error occurred.

<close_commbox>

Requests for closing the communication box and notifies the application of the acquired request result. ePOS-Device Service deletes the application from the communication box, and deletes the communication box if there is no member left.

Request

Element	Data type	Description
sequence	string	Specifies the sequence number.
data	string	Specifies the data of the communication box to close.

data

Child element	Data type	Description
box_id	string	Identifier of the communication box to close

Sample program

```
<close_commbox>
  <sequence>2</sequence>
  <data>
    <box_id>box1</box_id>
  </data>
</close_commbox>
```

Response

Element	Data type	Description
sequence	string	Sequence number specified in the request
data	string	Result of closing the communication box
data_id	string	ID to identify sent data

data

Child element	Data type	Description
box_id	string	Identifier of the closed communication box
code	string	Result of closing the communication box

- code

Element value	Description
"OK"	Communication box closed successfully.
"NOT_OPENED"	Communication box is not open.
"SYSTEM_ERROR"	A system error occurred.

<commbox_data>

Requests for inter-application data communication using the communication box and notifies the application of the acquired request result.

Request

Element	Data type	Description
sequence	string	Sequence number
data	string	Specifies data to communicate between applications.

Response

Element	Data type	Description
sequence	string	Sequence number specified in the request
data	string	Data to communicate between applications
data_id	int	ID to identify sent data

Supplementary explanation

- ❑ The contents of the <data> element are defined for each purpose of communication. Refer to [CommunicationBox Messages](#) for details.
- ❑ If <type>onreceive</type> is specified in the data element of the request, 0 will be returned to the sequence element of the response.

<open_device>

Establishes communication between a device connected to the printer and the application to enable to use the device. Requests for using the specified device and notifies the application of the acquired request result.

Request

Element	Data type	Description
device_id	string	Specifies the device ID.
data	string	Specifies the device category name and buffer setting upon disconnection.

data

Child element	Data type	Description
type	string	Specifies the device category name. <ul style="list-style-type: none"> "type_dt": Device hub terminal (TM-DT) "type_scanner": Barcode scanner "type_keyboard": Keyboard "type_poskeyboard": POS keyboard "type_msr": MSR "type_printer": Printer "type_hybrid_printer": Hybrid printer "type_display": Customer display "type_simple_serial": Serial communication device "type_storage": German fiscal element (TSE) "type_other_peripheral": Other peripheral device
buffer	string	Specifies the buffer function upon disconnection. <ul style="list-style-type: none"> "true": Enabled "false": Disabled

Sample program

```
<open_device>
  <device_id>scanner_001</device_id>
  <data>
    <type>type_scanner</type>
  </data>
</open_device>
```

Response

Element	Data type	Description
device_id	string	Device ID specified in the request
code	string	Processing result

Element	Data type	Description
data_id	int	One of the following values is set depending on the value set in <buffer> of the <open_device> message. <ul style="list-style-type: none"> • true: ID of sent data • false: Null string

code

Element value	Description
"OK"	Process succeeded.
"DEVICE_NOT_FOUND"	The specified device does not exist.
"DEVICE_IN_USE"	The specified device is in use.
"DEVICE_OPEN_ERROR"	Failed to open the specified device.
"DRIVER_ERROR"	Error occurred in the device control script.
"SYSTEM_ERROR"	A system error occurred.
"DEVICE_TYPE_INVALID"	The device type of the specified device is different.
"PARAM_ERROR"	A parameter error occurred.

Sample program

- Normal case

```
<open_device>
  <device_id>scanner_001</device_id>
  <code>OK</code>
  <data_id>2</data_id>
</open_device>
```

- Abnormal case

```
<open_device>
  <code>DEVICE_NOT_FOUND</code>
  <device_id>scanner_001</device_id>
  <data_id>2</data_id>
</open_device>
```

Supplementary explanation

- When <open_device> is executed successfully, devices other than the printer are exclusively locked.
- When specifying type_display in the child element type of data, specify local_display in device_id.
- When specifying storage in the child element type of data, specify local_TSE in device_id.
- For the device categories that can be specified with 'data', refer to the [Device Messages](#) list.
- Executing <open_device> again for the same device after <open_device> has already been executed sometimes generates the DEVICE_OPEN_ERROR depending on when processed, which results in termination of the connection with the device. Execute <open_device> again to reestablish the connection.

<close_device>

Close connection with the device opened by [<open_device>](#).

Requests for terminating use of the specified device and notifies the application of the acquired request result.

Request

Element	Data type	Description
device_id	string	Specifies the device ID.

Sample program

```
<close_device>
  <device_id>local_display</device_id>
</close_device>
```

Response

Element	Data type	Description
device_id	string	Device ID specified in the request
code	string	Processing result
data_id	int	One of the following values is set depending on the value set in <buffer> of the <open_device> message. <ul style="list-style-type: none"> • true: ID of sent data • false: Null string

code

Element value	Description
"OK"	Process succeeded.
"DEVICE_NOT_FOUND"	The specified device does not exist.
"DEVICE_NOT_OPEN"	The specified device ID is not open.
"DEVICE_CLOSE_ERROR"	Failed to close the specified device.
"SYSTEM_ERROR"	A system error occurred.
"PARAM_ERROR"	A parameter error occurred.

Sample program

- Normal case

```
<close_device>
  <device_id>local_display</device_id>
  <code>OK</code>
  <data_id>2</data_id>
</close_device>
```

- Abnormal case

```
<close_device>
  <device_id>scanner_001</device_id>
  <code>DEVICE_NOT_FOUND</code>
  <data_id>2</data_id>
</close_device>
```

Supplementary explanation

When specifying type_display in the child element type of [<open_device>](#) data, specify local_display in device_id.

<device_data>

Sends and receives data to and from a device and controls various devices.

Sends device control commands as well as print or display data in requests, acquires device control result, events which occurred, and input data from devices in responses, and notifies the application of the responses.

Request

Element	Data type	Description
sequence	string	Specifies an arbitrary figure used to identify the request message upon a transmission error.
device_id	string	Specifies an opened device ID.
data	string	Specifies data to control the device.

Sample program

```
<device_data>
  <sequence>123</sequence>
  <device_id>poskeyboard001</device_id>
  <data>
    <type>setprefix</type>
    <keycodes array="true">49</keycodes>
    <keycodes>50</keycodes>
    <keycodes>51</keycodes>
    <keycodes>52</keycodes>
  </data>
</device_data>
```

Response

Element	Data type	Description
sequence	string	Fixed to "0"
device_id	string	Device ID which generated data
data	string	Generated data
data_id	int	One of the following values is set depending on the value set in <buffer> of the <open_device> message. <ul style="list-style-type: none"> true: ID of sent data false: Null string

Sample program

```
<device_data>
  <sequence>0</sequence>
  <device_id>poskeyboard001</device_id>
  <data>
    <type>onstring</type>
    <input>&2398749238429</input>
    <prefix>49</prefix>
  </data>
  <data_id>2</data_id>
</device_data>
```

Supplementary explanation

- ❑ The figure specified in the child element sequence will be passed to sequence of the `<error>` message when a transmission error occurs.
- ❑ The contents of the data element are defined for each device type. Refer to [Device Messages](#) for details.
- ❑ When specifying [DeviceHubTerminal](#) in the child element type of data, specify `local_dt` in `device_id`.
- ❑ When specifying [CustomerDisplay](#) in the child element type of data, specify `local_display` in `device_id`.
- ❑ When specifying storage in the child element type of data, specify `local_TSE` in `device_id`.

<service_data>

Sends and receives data to and from the OFSC-Print service to enable the OFSC-Print service to control the printer.

Request

Element	Data type	Description
sequence	string	Specifies an arbitrary figure to identify relationship between the request and response.
service_id	string	Fixed to "OFSC"
data	string	Specifies data to send.

data

Child element	Data type	Description
type	string	Fixed to "print"
timeout	int	Specifies the timeout for the request in milliseconds. Value: 1000 to 60000 (integer)
printdata	string	Specifies XML data for DeviceExecuteRequest of OFSC.

Sample program

```

<service_data>
  <sequence>123</sequence>
  <service_id>OFSC</service_id>
  <data>
    <type>print</type>
    <timeout>10000</timeout>
    <printdata>
      <DeviceExecuteRequest xmlns="http://www.ofsc.org/namespace/Device/2008/11"
FixVersion="0" MajorVersion="1" MinorVersion="0">
        <ARTSHeader>
          <MessageID>0</MessageID>
          <DateTime>2011-03-08T12:34:56+09:00</DateTime>
          <Requestor>Yamada</Requestor>
          <WorkstationID>HT10</WorkstationID>
        </ARTSHeader>
        <Device>
          .
          .
        </DeviceExecuteRequest>
      </printdata>
    </data>
  </service_data>

```

Response

Element	Data type	Description
sequence	string	Sequence value specified in the request
service_id	string	Fixed to "OFSC"

Element	Data type	Description
data	string	XML data of DeviceExecuteResponse

data

Child element	Data type	Description
type	string	Fixed to "service_data"
resultdata	string	Result of OFSC printing

Sample program

```

<service_data>
  <sequence>123</sequence>

  <service_data>
    <sequence>123</sequence>
    <service_id>OFSC</service_id>
    <data>
      <response>
        <DeviceExecuteResponse>
          .
          .
          .
        </DeviceExecuteResponse>
      </response>
    </data>
  </service_data>

```

Supplementary explanation

- ❑ Cannot be used with ePOS-Device XML (English version).
- ❑ OFSC-Print is an XML-based print method designed for POS/Order Entry Systems for the food service industry. It controls devices in accordance with the OFSC (Open Foodservice System Consortium) device connection standard. Refer to the following URL for details of the OFSC device connection standard: <http://www.ofsc.jp/>
- ❑ The figure specified in the sequence element of the request will be passed to sequence of the `<error>` message when the response is generated or a transmission error occurs.
- ❑ Contents of the child element of printdata and resultdata are defined by the OFSC-Print service. Refer to the OFSC-Print User's Manual for the details.

<error>

Acquires a device control command in `<device_data>`, service control command error in `<service_data>`, and other common errors, and then notifies the application of the error.

Response

Element	Data type	Description
sequence	string	ID to identify the message causing the error
device_id	string	Device ID which generated the error
code	string	Displays the error as a code.
data	string	Error details corresponding to the driver upon DRIVER_ERROR occurrence
data_id	int	One of the following values is set depending on the value set in <code><buffer></code> of the <code><open_device></code> message. <ul style="list-style-type: none"> • true: ID of sent data • false: Null string

code

- Error in device_data

Element value	Description
"DEVICE_NOT_FOUND"	The specified device ID does not exist.
"DEVICE_NOT_OPEN"	The specified device is not open.
"SEND_ERROR"	Error occurred when sending data to the corresponding physical device.
"DRIVER_ERROR"	Error was detected in the driver.
"PARAM_ERROR"	A parameter error occurred.
"FUNCTION_NOT_FOUND"	The specified function does not exist in the driver.

- Error in service_data

Element value	Description
"SERVICE_NOT_FOUND"	The specified service ID does not exist.
"SEND_ERROR"	An error occurred while sending data.
"PARAM_ERROR"	A parameter error occurred.

- Other errors

Element value	Description
"COMMAND_ILLEGAL"	The XML contains a syntax error.
"SYSTEM_ERROR"	A system error occurred.

Sample program

```
<error>
  <sequence>123</sequence>
  <device_id>scanner002</device_id>
  <code>DEVICE_NOT_OPEN</code>
  <data></data>
  <data_id>2</data_id>
</error>
```

Supplementary explanation

- The value specified in the sequence element of the `<device_data>` or `<service_data>` request is passed to sequence.
- `device_id` is set for an error in `<device_data>`.

CommunicationBox Messages

Controls data transmission and reception between the communication box and an application.

<type>getcommhistory</type>

Requests for the transmission history of the communication box and notifies the application of the acquired request result.

Request

Child element	Data type	Description
box_id	string	Specifies the identifier of the communication box to acquire.
all_history	boolean	Specifies whether or not to acquire the entire transmission history of the communication box.

all_history

Attribute value	Description
"true" / "1"	Acquires the entire transmission history of the communication box.
"false" / "0"	Acquires the transmission history of data sent to the own member ID only.

Sample program

```
<commbox_data>
  <sequence>4</sequence>
  <data>
    <type>getcommhistory</type>
    <box_id>box1</box_id>
  </data>
</commbox_data>
```

Response

Child element	Data type	Description
box_id	string	Identifier of the acquired communication box
code	string	Result of sent data
history_list	string	Acquired transmission history

code

Attribute value	Description
"OK"	Acquisition of the transmission history of the communication box succeeded.
"NOT_OPENED"	The communication box is not open.

Attribute value	Description
"SYSTEM_ERROR"	A system error occurred.

history_list

Child element	Description
senderId	The member ID of the sender
receiverId	The member ID of the receiver
message	Received message

Sample program

```

<commbbox_data>
  <sequence>4</sequence>
  <data>
    <type>getcommhistory</type>
    <box_id>box1</box_id>
    <code>OK</code>
    <history_list>
      <senderId>member1</senderId>
      <receiverId></receiverId>
      <message>send_message3</message>
    </history_list>
    <history_list>
      <senderId>member1</senderId>
      <receiverId></receiverId>
      <message>send_message2</message>
    </history_list>
    <history_list>
      <senderId>member1</senderId>
      <receiverId></receiverId>
      <message>send_message</message>
    </history_list>
  </data>
  <data_id>10</data_id>
</commbbox_data>

```

Supplementary explanation

- ❑ If the "all_history" child element is omitted, "false"/"0" is specified.
- ❑ <history_list> is notified for the number of transmission histories acquired.
- ❑ The <history_list> child element stores data in the descending order of dates.

<type>send</type>

Sends data to the communication box and notifies the application of the acquired transmission result.

Request

Child element	Data type	Description
box_id	string	Specifies the identifier of the communication box to send the message.
message	string	Specifies the message to send.
member_id	string	Specifies the member ID to send.

Sample program

```
<commbbox_data>
  <sequence>3</sequence>
  <data>
    <type>send</type>
    <box_id>box1</box_id>
    <message>send_message</message>
  </data>
</commbbox_data>
```

Response

Child element	Data type	Description
box_id	string	Identifier of the communication box to which the message was sent
code	string	Message transmission result
count	string	Number of clients which tried to send the message

code

Attribute value	Description
"OK"	Message transmission succeeded.
"NOT_OPENED"	The communication box is not open.
"MEMBER_NOT_FOUND"	The specified member ID cannot be found.
"SYSTEM_ERROR"	A system error occurred.

Supplementary explanation

If a null string is specified in the member_id child element, the message is sent to all the applications belonging to the communication box.

<type>onreceive</type>

Acquires data sent to the communication box and notifies the application of the acquired data.

Response

Child element	Data type	Description
box_id	string	Identifier of the communication box to which the message was sent
sender_id	string	Member ID used to send the message
receiver_id	string	Member ID to acquire the sent message
message	string	Message sent to the communication box

Sample program

```
<commbox_data>
  <sequence>3</sequence>
  <data>
    <type>onreceive</type>
    <box_id>box1</box_id>
    <sender_id>member1</sender_id>
    <receiver_id></receiver_id>
    <message>send_message</message>
  </data>
  <data_id>19</data_id>
</commbox_data>
```

Supplementary explanation

- ❑ When all the applications belonging to the communication box acquires the message, a null string is set.
- ❑ No <type>onreceive</type> is notified if a communication error occurs.
To notify the disconnection event, implement the <reconnect>.
- ❑ If a communication error occurs and it is deemed that no recovery will take place, notify <disconnect>.
Since no <type>onreceive</type> is notified, detect data transmission failures in <disconnect>.

DeviceHubTerminal Messages

<type>shutdown</type>

Requests for shutting down the TM-DT power. The execution result of shutdown is acquired by the [<type>onshutdown</type>](#) element.

Request

Child element	Data type	Description
password	string	Specify the password set in EPSON TMNet WebConfig as a string.

Sample program

```
<device_data>
  <device_id>local_dt</device_id>
  <data>
    <type>shutdown</type>
    <password>epson</password>
  </data>
</device_data>
```

Supplementary explanation

The shutdown setting of TM-DT must be set to "Allowed" by using EPSON TMNet WebConfig. For details, refer to the Technical Reference Guide of the TM-DT.

<type>onshutdown</type>

Acquires the execution result of the [<type>shutdown</type>](#) element and notifies the application of the result.

Response

Child element	Data type	Description
status	string	Execution result of shutdown

status

Attribute value	Description
"SUCCESS"	Shutdown succeeded.
"AUTHENTICATION_ERROR"	Password authentication error
"ACCESS_DENIED"	Shutdown from ePOS-Device XML is not set.
"SYSTEM_ERROR"	A system error occurred.

<type>restart</type>

Requests for restarting TM-DT. The execution result of restart is acquired by the [<type>onrestart</type>](#) element.

Request

Child element	Data type	Description
password	string	Specify the password set in EPSON TMNet WebConfig as a string.

Sample program

```
<device_data>
  <device_id>local_dt</device_id>
  <data>
    <type>restart</type>
    <password>epson</password>
  </data>
</device_data>
```

Supplementary explanation

The shutdown setting of TM-DT must be set to "Allowed" by using EPSON TMNet WebConfig. For details, refer to the Technical Reference Guide of the TM-DT.

<type>onrestart</type>

Acquires the execution result of the [<type>restart</type>](#) element and notifies the application of the result.

Response

Child element	Data type	Description
status	string	Execution result of restart

status

Attribute value	Description
"SUCCESS"	Restart succeeded.
"AUTHENTICATION_ERROR"	Password authentication error
"ACCESS_DENIED"	Shutdown from ePOS-Device XML is not set.
"SYSTEM_ERROR"	A system error occurred.

BarcodeScanner Messages

<type>ondata</type>

Acquires data read from the barcode by the scanner, and notifies the application of the data.

Response

Child element	Data type	Description
input	string	String of received scan data

Sample program

```
<data>
  <type>ondata</type>
  <input>F12345678909123</input>
</data>
```

Printer Messages

<type>print</type>

Sends print data and configuration data to the printer and requests it for printing. The request result is acquired by the <type>onxmlresult</type> element.

Request

Child element	Data type	Description
timeout	int	Specifies the timeout for the request in milliseconds. Value: 1000 to 300000 (integer)
printjobid	string	Specifies the print job ID (optional).
printdata	string	Specifies data to print.

Print data size

The following lists the maximum sizes of the print data that can be sent at one shot.

When sending print data whose size exceeds the limit, separate the data.

- TM-m30: 2MB
- TM-DT Series/TM-i Series:

Version		Printing Speed	
TM-DT Software	TM-i Firmware	300 mm/s	200 mm/s
2.5 or earlier	4.0 or earlier	200 KB	133 KB
-	4.1	400 KB	267 KB
3.0 or later	4.3 or later	4 MB	2.67 MB

Sample program

- Request A: Does not specify the print job ID.

```
<data>
  <type>print</type>
  <timeout>10000</timeout>
  <printdata>
    <!-- Printer Control XML -->
    <epos-print xmlns=
      .
    </epos-print>
  </printdata>
</data>
```

- Request B: Specifies the print job ID.

```
<device_data>
  <device_id>local_printer</device_id>
  <data>
    <type>print</type>
    <timeout>60000</timeout>
    <printjobid>ABC123</printjobid>
    <printdata>
      <epos-print xmlns="http://www.epson-pos.com/schemas/2011/03/epos-print">
        <text>Hello, World!&#10;</text>
        <cut />
      </epos-print>
    </printdata>
  </data>
</device_data>
```

- Request C: Acquires the print result when the spooler function is enabled.

```
<device_data>
  <device_id>local_printer</device_id>
  <data>
    <type>print</type>
    <printjobid>123</printjobid>
    <timeout>60000</timeout>
    <printdata>
      <epos-print xmlns="http://www.epson-pos.com/schemas/2011/03/epos-print"/>
    </printdata>
  </data>
</device_data>
```

Supplementary explanation

- ❑ The print job ID can be specified using alphanumeric characters, underscore, hyphen, and period in 1 to 30 digits.
- ❑ Refer to [PrinterControl XML](#) for details of print data specified in the printdata child element.
- ❑ Blank print data needs to be sent to acquire the print result while the spooler function is enabled. Therefore, the child element of the `<epos-print>` element is not specified.

<type>onxmlresult</type>

Acquires the result of the print request given by the `<type>print</type>` element and notifies the application of the result.

Response

Child element	Data type	Description
printjobid	string	Print job ID
resultdata	string	Print result

Sample program

- Response to Request A

```
<data>
  <type>onxmlresult</type>
  <resultdata>
    <response success="true"/>
  </resultdata>
</data>
```

- Response to Request B

```
<device_data>
  <device_id>local_printer</device_id>
  <data>
    <type>onxmlresult</type>
    <printjobid>ABC123</printjobid>
    <resultdata>
      <response xmlns="http://www.epson-pos.com/schemas/2011/03/epos-print"
        success="true" code="" status="252641302" battery="0" />
    </resultdata>
  </data>
</device_data>
```

- Response to Request A (with spooler function enabled)

```
<device_data>
  <device_id>local_printer</device_id>
  <data>
    <type>onxmlresult</type>
    <printjobid>123</printjobid>
    <resultdata>
      <response xmlns="http://www.epson-pos.com/schemas/2011/03/epos-print"
        success="true" code="" status="2" battery="0" />
    </resultdata>
  </data>
</device_data>
```

- Response to Request C

```

<device_data>
  <device_id>local_printer</device_id>
  <data>
    <type>onxmlresult</type>
    <printjobid>123</printjobid>
    <resultdata>
      <response xmlns="http://www.epson-pos.com/schemas/2011/03/epos-print"
        success="true" code="" status="252641302" battery="0" />
    </resultdata>
  </data>
</device_data>

```

Supplementary explanation

- ❑ Refer to [<response>](#) for details of the print result acquired in the resultdata child element.
- ❑ If the application does not specify the print job ID, the printer issues the print job ID instead.
- ❑ When the spooler function is enabled, the [<response>](#) of this element returns "true" to 'success', "(null string)" to 'code', "0x00000002" or "0x80000000" to 'status', and "0" to 'battery' respectively. The actual print result can be acquired by requesting for it with the print job ID specified.
- ❑ No [<type>onxmlresult</type>](#) is notified if a communication error occurs. To notify the disconnection event, implement the [<reconnect>](#).
- ❑ If a communication error occurs and it is deemed that no recovery will take place, notify [<disconnect>](#). Since no [<type>onxmlresult</type>](#) is notified in this case, detect print failures in [<disconnect>](#).

HybridPrinter Messages

`<type>lock</type>`

Requests for locking the device port. Use this method when, for example, performing MICR control and slip printing sequentially to prevent other processes from interrupting the operation. The request result is acquired by the `<type>onreceive</type>` element.

Request

Sample program

```
<device_data>
  <device_id>local_printer</device_id>
  <data>
    <type>lock</type>
  </data>
</device_data>
```

Supplementary explanation

After executing `<type>lock</type>`, execute the `<type>unlock</type>` element before closing the application.

If you fail to do this, the device port cannot be locked for approximately 5 minutes until ePOSDevice Service unlocks the port and ERROR_DEVICE_BUSY is passed to the `<type>onreceive</type>` element.

<type>unlock</type>

Requests for unlocking the device port. The request result is acquired by the [<type>onreceive</type>](#) element.

Request**Sample program**

```
<device_data>
  <device_id>local_printer</device_id>
  <data>
    <type>unlock</type>
  </data>
</device_data>
```

<type>print</type>

Sends print data and configuration data to the printer and requests it for printing a sales slip. The request result is acquired by the `<type>onxmlresult</type>` element.

Request

Child element	Data type	Description
timeout	int	Specifies the timeout for the request in milliseconds. Value: 1 to 300000 (integer)
printdata	string	Specifies data to print.

Sample program

```
<device_data>
  <device_id>local_printer</device_id>
  <data>
    <type>print</type>
    <timeout>10000</timeout>
    <printdata>
      <!-- Printer Control XML -->
      <epos-print xmlns=
        .
      </epos-print>
    </printdata>
  </data>
</device_data>
```

Supplementary explanation

- ❑ If the "timeout" child element is omitted, "10000" is specified.
- ❑ Refer to [PrinterControl XML](#) for details of print data specified in the printdata child element.

<type>onxmlresult</type>

Acquires the result of the print request given by the [<type>print</type>](#) element and notifies the application of the result.

Response

Child element	Data type	Description
resultdata	string	Print result

Sample program

```
<data>
  <type>onxmlresult</type>
  <resultdata>
    <response success= />
  </resultdata>
</data>
```

Supplementary explanation

Refer to [<response>](#) for details of the print result acquired in the resultdata child element.

<type>slipwaitinsertion</type>

Requests for the slip sheet insertion wait status for slip printing.

After executing this element, insert the slip sheet into the printer.

The request result is acquired by the [<type>onreceive</type>](#) element.

Request

Child element	Data type	Description
timeout	int	Specifies the timeout period for slip sheet insertion wait status in milliseconds. Value: 5000 to 900000 (integer)
waittime	int	Specifies the operation start wait time after insertion of the slip sheet. Value: 0 to 6400 (integer)

Sample program

```
<device_data>
  <device_id>local_printer</device_id>
  <data>
    <type>slipwaitinsertion</type>
    <timeout>60000</timeout>
    <waittime>500</waittime>
  </data>
</device_data>
```

Supplementary explanation

- ❑ If the "timeout" child element is omitted, "60000" is specified.
- ❑ If the "waittime" child element is omitted, "500" is specified.
- ❑ waittime values are rounded down to the nearest 100 milliseconds.
Example: 1 -> 0, 101 -> 100, 150 -> 100
- ❑ When the paper is inserted, it is cued according to the print method.

<type>slipprint2</type>

Transfers print data and setting data and requests the printer for slip printing.

The request result is acquired by the [<type>onreceive</type>](#) element.

Request

Child element	Data type	Description
printdata	string	Specifies data to print.
timeout	int	Specifies the timeout period for slip sheet insertion wait status in milliseconds. Value: 5000 to 1000000 (integer)

Sample program

```

<device_data>
  <device_id>local_printer</device_id>
  <data>
    <type>slipprint2</type>
    <printdata>
      <!-- Printer Control XML -->
      <epos-print xmlns=
        .
      </epos-print>
    </printdata>
    <timeout>10000</timeout>
  </data>
</device_data>

```

Supplementary explanation

- ❑ If the "timeout" child element is omitted, "10000" is specified.
- ❑ Refer to [PrinterControl XML](#) for details of print data specified in the printdata child element.

<type>slipcancel</type>

Requests for canceling slip sheet insertion wait status after executing the [<type>slipwaitinsertion</type>](#). The request result is acquired by the [<type>onreceive</type>](#) element.

Request

```
<device_data>
  <device_id>local_printer</device_id>
  <data>
    <type>slipcancel</type>
  </data>
</device_data>
```

<type>endorsewaitinsertion</type>

Requests for the slip sheet insertion wait status for endorsement printing.

After executing this element, insert the slip sheet into the printer.

The request result is acquired by the [<type>onreceive</type>](#) element.

Request

Child element	Data type	Description
timeout	int	Specifies the timeout period for slip sheet insertion wait status in milliseconds. Value: 5000 to 900000 (integer)
waittime	int	Specifies the operation start wait time after insertion of the slip sheet. Value: 0 to 6400 (integer)

Sample program

```
<device_data>
  <device_id>local_printer</device_id>
  <data>
    <type>endorsewaitinsertion</type>
    <timeout>60000</timeout>
    <waittime>500</waittime>
  </data>
</device_data>
```

Supplementary explanation

- ❑ If the "timeout" child element is omitted, "60000" is specified.
- ❑ If the "waittime" child element is omitted, "500" is specified.
- ❑ waittime values are rounded down to the nearest 100 milliseconds.
Example: 1 -> 0, 101 -> 100, 150 -> 100
- ❑ When the paper is inserted, it is cued according to the print method.

<type>endorseprint2</type>

Transfers print data and setting data and requests the printer for endorsement printing.

The request result is acquired by the [<type>onreceive</type>](#) element.

Request

Child element	Data type	Description
is40cplmode	boolean	Enables or disables the 40cpl mode.
printdata	string	Specifies data to print.
timeout	int	Specifies the timeout period for slip sheet insertion wait status in milliseconds. Value: 5000 to 1000000 (integer)

is40cplmode

Attribute value	Description
"true" / "1"	Enabled
"false" / "0"	Disabled

Sample program

```
<device_data>
  <device_id>local_printer</device_id>
  <data>
    <type>endorseprint2</type>
    <is40cplmode>true</is40cplmode>
    <printdata>
      <!-- Printer Control XML -->
      <epos-print xmlns=
        .
      >
        </epos-print>
      </printdata>
      <timeout>10000</timeout>
    </data>
  </device_data>
```

Supplementary explanation

- ❑ If the "timeout" child element is omitted, "10000" is specified.
- ❑ Refer to [PrinterControl XML](#) for details of print data specified in the printdata child element.

<type>endorsecancel</type>

Requests for canceling slip sheet insertion wait status after executing the [<type>endorsewaitinsertion</type>](#). The request result is acquired by the [<type>onreceive</type>](#) element.

Request**Sample program**

```
<device_data>
  <device_id>local_printer</device_id>
  <data>
    <type>endorsecancel</type>
  </data>
</device_data>
```

<type>validationwaitinsertion</type>

Requests for the validation sheet insertion wait status for validation printing.

After executing this element, insert the validation sheet into the printer.

The request result is acquired by the [<type>onreceive</type>](#) element.

Request

Child element	Data type	Description
timeout	int	Specifies the timeout period for slip sheet insertion wait status in milliseconds. Value: 5000 to 900000 (integer)
waittime	int	Specifies the operation start wait time after insertion of the validation sheet. Value: 0 to 6400 (integer)

Sample program

```
<device_data>
  <device_id>local_printer</device_id>
  <data>
    <type>validationwaitinsertion</type>
    <timeout>60000</timeout>
    <waittime>500</waittime>
  </data>
</device_data>
```

Supplementary explanation

- If the "timeout" child element is omitted, "60000" is specified.
- If the "waittime" child element is omitted, "500" is specified.
- waittime values are rounded down to the nearest 100 milliseconds.
Example: 1 -> 0, 101 -> 100, 150 -> 100
- When the paper is inserted, it is cued according to the print method.

<type>validationprint2</type>

Transfers print data and setting data and requests the printer for validation printing.

The request result is acquired by the [<type>onreceive</type>](#) element.

Request

Child element	Data type	Description
printdata	string	Specifies data to print.
timeout	int	Specifies the timeout period for slip sheet insertion wait status in milliseconds. Value: 5000 to 1000000 (integer)

is40cplmode

Attribute value	Description
"true" / "1"	Enabled
"false" / "0"	Disabled

Sample program

```

<device_data>
  <device_id>local_printer</device_id>
  <data>
    <type>validationprint2</type>
    <printdata>
      <!-- Printer Control XML -->
      <epos-print xmlns=
        .
      </epos-print>
    </printdata>
    <timeout>10000</timeout>
  </data>
</device_data>

```

Supplementary explanation

- If the "timeout" child element is omitted, "10000" is specified.
- Refer to [PrinterControl XML](#) for details of print data specified in the printdata child element.

<type>validationcancel</type>

Requests for canceling validation sheet insertion wait status after executing the [<type>validationwaitinsertion</type>](#).

The request result is acquired by the [<type>onreceive</type>](#) element.

Request**Sample program**

```
<device_data>
  <device_id>local_printer</device_id>
  <data>
    <type>validationcancel</type>
  </data>
</device_data>
```

<type>micread</type>

Requests for reading from the MICR. Inserting a slip sheet after executing <type>micread</type> starts reading from the MICR. The request result is acquired by the <type>onreceive</type> element.

Request

Child element	Data type	Description
ignoreerror	boolean	Specifies how to process illegible text.
font	string	Specifies the MICR read font.
timeout	int	Specifies the timeout period for slip sheet insertion wait status in milliseconds. Value: 5000 to 900000 (integer)
waittime	int	Specifies the operation start wait time after insertion of the slip sheet. Value: 0 to 6400

ignoreerror

Attribute value	Description
"true" / "1"	Continues processing by replacing an illegible character with "?".
"false" / "0"	Stops processing when an illegible character is encountered.

font

Attribute value	Description
"MICR_E13B"	Specifies the read font to E13B.
"MICR_CMC7"	Specifies the read font to CMC7.

Sample program

```
<device_data>
  <device_id>local_printer</device_id>
  <data>
    <type>micread</type>
    <ignoreerror>true</ignoreerror>
    <font>MICR_E13B</font>
    <timeout>60000</timeout>
    <waittime>500</waittime>
  </data>
</device_data>
```

Supplementary explanation

- ❑ If the "timeout" child element is omitted, "60000" is specified.
- ❑ If the "waittime" child element is omitted, "500" is specified.

<type>micrcleaning</type>

Requests for cleaning the MICR mechanism. Inserting a cleaning sheet after executing <type>micrcleaning</type> starts cleaning the MICR mechanism. The request result is acquired by the <type>onreceive</type> element.

Request

Child element	Data type	Description
timeout	int	Specifies the timeout period for cleaning sheet insertion wait status in milliseconds. Value: 5000 to 900000 (integer)
waittime	int	Specifies the operation start wait time after insertion of the cleaning sheet. Value: 0 to 6400

Sample program

```
<device_data>
  <device_id>local_printer</device_id>
  <data>
    <type>micrcleaning</type>
    <timeout>123456</timeout>
    <waittime>500</waittime>
  </data>
</device_data>
```

Supplementary explanation

- If the "timeout" child element is omitted, "60000" is specified.
- If the "waittime" child element is omitted, "500" is specified.

<type>micrcancel</type>

Requests for canceling slip sheet or cleaning sheet insertion wait status after executing [<type>micread</type>](#) or [<type>micrcleaning</type>](#). The request result is acquired by the [<type>onreceive</type>](#) element.

Request**Sample program**

```
<device_data>
  <device_id>local_printer</device_id>
  <data>
    <type>micrcancel</type>
  </data>
</device_data>
```

<type>eject</type>

Requests for ejecting the paper. The request result is acquired by the [<type>onreceive</type>](#) element.

Request**Sample program**

```
<device_data>
  <device_id>local_printer</device_id>
  <data>
    <type>eject</type>
  </data>
</device_data>
```

<type>onreceive</type>

Acquires the result of the request given by the following elements and notifies the application of the result.

- [<type>lock</type>](#) element
- [<type>unlock</type>](#) element
- [<type>slipwaitinsertion</type>](#) element
- [<type>slipprint2</type>](#) element
- [<type>slipcancel</type>](#) element
- [<type>endorsewaitinsertion</type>](#) element
- [<type>endorseprint2</type>](#) element
- [<type>endorsecancel</type>](#) element
- [<type>validationwaitinsertion</type>](#) element
- [<type>validationprint2</type>](#) element
- [<type>validationcancel</type>](#) element
- [<type>micread</type>](#) element
- [<type>micrcleaning</type>](#) element
- [<type>micrcancel</type>](#) element
- [<type>eject</type>](#) element

Response

Child element	Data type	Description
eventtype	string	Name of the element to return the event
success	string	Processing result of the element to return the event
code	string	Execution result of the element to return the event
status	string	Status of the printer
data	string	MICR read result

success

Attribute value	Description
"true" / "1"	Enabled
"false" / "0"	Disabled

code

Attribute value	Description
'SUCCESS'	Success
'CANCEL'	Cancels the paper insertion wait status.
'ERROR_CANCEL_FAILED'	Failed to cancel the paper insertion wait status.

Attribute value	Description
'ERROR_PARAMETER'	A parameter error occurred.
'ERROR_COMMAND'	The paper type in the paper insertion wait unlock command does not match with the type of paper that the printer is waiting to be inserted.
'ERROR_DEVICE_NOT_FOUND'	The device was not found.
'ERROR_DEVICE_BUSY'	<ul style="list-style-type: none"> Failed to open the port. Timeout error for locking the port. The specified device is in process and the process cannot be executed.
'ERROR_NOT_SUPPORTED'	The printer does not support the requested function.
'ERROR_COVER_OPEN'	Cover open error occurred.
'ERROR_TIMEOUT'	Paper insertion wait timeout.
'ERROR_AUTOMATICAL'	Automatic recovery error occurred.
'ERROR_UNRECOVERABLE'	Unrecoverable error occurred.
'ERROR_WAIT_EJECT'	Paper eject error occurred.
'SYSTEM_ERROR'	A system error occurred.
'EPTR_MECHANICAL'	Mechanical error occurred.
'EPTR_SCHEMAERROR'	Error occurred in the requested document syntax.
'EPTR_PAPER_PULLED_OUT'	<ul style="list-style-type: none"> Paper was removed during insertion. Paper was removed after it had been inserted.
'EPTR_CUTTER'	Auto cutter error occurred.
'EPTR_REC_EMPTY'	Roll paper has run out.
'EMICR_ILLEGAL_LENGTH'	Inserted paper is not of an appropriate length.
'EMICR_NO_MICR'	Cannot detect MICR data.
'EMICR_RECOGNITION'	Illegible MICR text was detected.
'EMICR_READ'	Error occurred during MICR read operation.
'EMICR_NOISE_DETECTED'	Noise error was detected.
'EMICR_COVER_OPEN'	Cover was opened during MICR read operation.
'EMICR_PAPER_JAM'	Paper jam error occurred.
'EMICR_PAPER_PULLED_OUT'	Paper was removed during MICR read operation.

status

Acquires the logical OR of the values listed below in decimal value depending on the printer status.

Attribute value	Description
"0x00000001"	TM printer does not respond.

Attribute value	Description
"0x00000002"	Printing completed.
"0x00000004"	Drawer kick connector pin No.3 status = "H"
"0x00000008"	Offline status
"0x00000020"	Cover is open.
"0x00000040"	Paper is being fed by the paper feed switch.
"0x00000200"	Paper feed switch is held depressed.
"0x00000400"	Mechanical error occurred.
"0x00000800"	Auto cutter error occurred.
"0x00002000"	Unrecoverable error occurred.
"0x00004000"	Automatically recoverable error occurred.
"0x00010000"	Waiting for insertion of a slip sheet for slip printing
"0x00020000"	Roll paper has almost run out.
"0x00040000"	Waiting for ejection of a slip sheet for slip printing
"0x00080000"	Roll paper has run out.
"0x00200000"	Slip sheet is not inserted deep enough.
"0x00400000"	Slip sheet is not correctly aligned with the right edge of the paper guide.
"0x01000000"	Slip printing is not selected.
"0x02000000"	Cannot print on the slip sheet.
"0x04000000"	Validation printing is not selected.
"0x08000000"	Cannot print on the validation sheet.
"0x20000000"	Validation sheet is not inserted deep enough.
"0x40000000"	Validation sheet is not correctly aligned with the right edge of the paper guide.
"0x80000000"	Spooler is stopped (not used).

Supplementary explanation

- ❑ A null string (" ") is set to the child element data if an element other than the `<type>micread</type>` is executed.
- ❑ No `<type>onxmlresult</type>` is notified if a communication error occurs.
To notify the disconnection event, implement the `<reconnect>`.
- ❑ If a communication error occurs and it is deemed that no recovery will take place, notify `<disconnect>`.
Since no `<type>onxmlresult</type>` is notified in this case, detect print failures in `<disconnect>`.

PrinterControl XML

<epos-print>

This XML is sent from the application to the printer.

It requests the printer to execute a specified function. <epos-print> has necessary elements to control the printer.

Attribute

xmlns

Declares the name space of epos-print. The name space is as follows:

http://www.epson-pos.com/schemas/2011/03/epos-print

force

Enables the forced transmission mode.

In the forced transmission mode, print commands are forcibly sent to the printer.

Attribute value	Description
"true" / "1"	Enables the forced transmission mode.
"false" / "0"	Enables the normal transmission mode.

Sample program

- Adds a text tag as the child element.

```
<epos-print xmlns="http://www.epson-pos.com/schemas/2011/03/epos-print">
  <text>Hello world!!</text>
</epos-print>
```

Supplementary explanation

- Use the forced transmission mode while the printer is offline.
Enabling it while the printer is online will result in an error.
- The following functions are available in the forced transmission mode:
 - Kicks the drawer (<pulse>)
 - Stops the buzzer (<sound>)
 - Recovers from a recoverable error (<recovery>)
 - Resets the printer (<reset>)
 - Transmits a real-time command (<command>)
- For TM-H6000V, you need to enable the Command execution during offline settings.
Refer to TM-H6000V Utility User's Manual for details.

<response>

This is an XML returned from the printer to the application.

Attribute

Attribute	Description
success	Print result
code	Error code
status	Status
battery	Battery status

success

Attribute value	Description
"true" / "1"	<ul style="list-style-type: none"> Print succeeded. Process succeeded (when the spooler function is enabled).
"false" / "0"	<ul style="list-style-type: none"> Print failed. Process failed (when the spooler function is enabled).

code

Attribute value	Description
'EPTR_AUTOMATICAL'	Automatic recovery error occurred.
'EPTR_BATTERY_LOW'	Battery has run out.
'EPTR_COVER_OPEN'	Cover open error occurred.
'EPTR_CUTTER'	Auto cutter error occurred.
'EPTR_MECHANICAL'	Mechanical error occurred.
'EPTR_REC_EMPTY'	No paper is left in the roll paper end detector.
'EPTR_UNRECOVERABLE'	Unrecoverable error occurred.
'SchemaError'	Error exists in the requested document syntax.
'DeviceNotFound'	Printer specified by the device ID does not exist.
'PrintSystemError'	Error occurred with the printing system.
'EX_BADPORT'	Error detected with the communication port.
'EX_TIMEOUT'	Print timeout occurred.
'EX_SPOOLER'	Print queue is full.
'JobNotFound'	Specified job ID does not exist.
'Printing'	Printing

Attribute value	Description
"JobSpooling"	Spooling
"TooManyRequests"	The number of print jobs sent to the printer has exceeded the allowable limit.
"RequestEntityTooLarge"	The data size of the print job is larger than the allowable limit of the printer.
"ERROR_WAIT_EJECT"	Waiting for paper removal.

status

Acquires the logical OR of the values listed below in decimal value depending on the printer status.

Attribute value	Description
"0x00000001"	TM printer does not respond.
"0x00000002"	Printing completed.
"0x00000004"	<ul style="list-style-type: none"> • Drawer kick connector pin No.3 status = "H" • Offline status due to the battery level
"0x00000008"	Offline status
"0x00000020"	Cover is open.
"0x00000040"	Paper is being fed by the paper feed switch.
"0x00000200"	Paper feed switch is held depressed.
"0x00000400"	Mechanical error occurred.
"0x00000800"	Auto cutter error occurred.
"0x00002000"	Unrecoverable error occurred.
"0x00004000"	Automatically recoverable error occurred.
"0x00010000"	Waiting for insertion of a slip sheet for slip printing
"0x00020000"	Roll paper has almost run out.
"0x00040000"	Waiting for ejection of a slip sheet for slip printing
"0x00080000"	Roll paper has run out.
"0x00200000"	Paper is not inserted deep enough.
"0x00400000"	Paper is not correctly aligned with the right edge of the paper guide.
"0x01000000"	<ul style="list-style-type: none"> • Buzzer is sounding • Slip printing is not selected. • Waiting for labels to be peeled off. (supported model only) • Waiting for paper removal. (supported model only)
"0x02000000"	Cannot print on the paper.

Attribute value	Description
"0x04000000"	<ul style="list-style-type: none"> • There is no labels that are waiting to be peeled off. (supported model only) • There is no paper that is waiting to be removed. (supported model only)
"0x80000000"	Spooler stopped

battery

Acquires the logical OR of the values listed below in decimal value depending on the battery status.

 AC adapter connection status

Attribute value	Description
0x30XX	AC adapter is connected.
0x31XX	AC adapter is not connected.

 Remaining battery capacity

Attribute value	Description
0xXX36	Remaining battery capacity 6
0xXX35	Remaining battery capacity 5
0xXX34	Remaining battery capacity 4
0xXX33	Remaining battery capacity 3
0xXX32	Remaining battery capacity 2
0xXX31	Remaining battery capacity 1 (almost run out)
0xXX30	Remaining battery capacity 0 (run out)

Sample program

- When printing succeeded

```
<response success="true" code="" status=""/>
```

- When printing failed because the printer has run out of paper

```
<response xmlns="http://www.epson-pos.com/schemas/2011/03/epos-print"
  success="false" code="EPTR_REC_EMPTY" status="252641308" />
```

Supplementary explanation

For a model without battery, 0xXX30 is set to the battery constant.

<text>

Specifies text to print, text decoration, print position, line feed quantity, and other print properties.

List of properties available for each print method

Attribute	Description	Print method				
		Receipt	Slip	Endorsement	Endorsement (40cpl)	Validation
lang	Language settings	✓	✓	-	-	✓
font	Font settings	✓	✓	✓	-	✓
smooth	Smoothing settings	✓	-	-	-	-
dw	Double-width printing settings	✓	✓	✓	-	✓
dh	Double-height printing settings	✓	✓	✓	-	✓
width	Horizontal scaling factor	✓	✓	✓	-	✓
height	Vertical scaling factor	✓	✓	✓	-	✓
reverse	Black-and-white characters reversing settings	✓	-	-	-	-
ul	Underscore style settings	✓	✓	✓	-	✓
em	Emphasis style settings	✓	✓	✓	-	✓
color	Color settings	✓	-	-	-	-
x	Horizontal print start position settings	✓	✓	✓	✓	✓
y	Vertical print start position settings	✓	✓	-	-	-
align	Alignment settings	✓	✓	✓	-	✓
rotate	Text rotation settings	✓	✓	✓	✓	✓
linespc	Page feed amount settings	✓	✓	✓	-	✓

Attribute**lang**

Attribute value	Description
"en"	English (ANK specification)
"de"	German (ANK specification)
"fr"	French (ANK specification)
"it"	Italian (ANK specification)

Attribute value	Description
"es"	Spanish (ANK specification)
"ja"	Japanese (International character set is also changed to Japanese.)
"ja-jp"	
"ja-ex"	Japanese JISX0213 (International character set is also changed to Japanese.)
"ko"	Korean (International character set is also changed to Korean.)
"ko-kr"	
"zh-hans"	Simplified Chinese (International character set is also changed to Chinese.)
"zh-cn"	
"zh-hant"	Traditional Chinese
"zh-tw"	
"th"	Thai (South Asian model only)
"mul"	Multiple languages (UTF-8)
Language code other than above	English (ANK specification)

Depending on the specified language, some characters are printed as follows:

Language	Characters \$ (U+0024)	Characters \ (U+005C)
Japanese	\$	¥
Korean	\$	₩
Simplified Chinese	¥	\
Traditional Chinese	\$	\

font

Attribute value	Description
"font_a"	Font A
"font_b"	Font B
"font_c"	Font C
"font_d"	Font D
"font_e"	Font E
"special_a"	Special font A
"special_b"	Special font B

smooth

Attribute value	Description
"true" / "1"	Enables smoothing.
"false" / "0"	Disables smoothing.

dw

Attribute value	Description
"true" / "1"	Enables double-width printing.
"false" / "0"	Disables double-width printing.

dh

Attribute value	Description
"true" / "1"	Enables double-height printing.
"false" / "0"	Disables double-height printing.

width

Attribute value	Description
"1" to "8"	Specifies the horizontal scaling factor.

height

Attribute value	Description
"1" to "8"	Specifies the vertical scaling factor.

reverse

Attribute value	Description
"true" / "1"	Enables the black-and-white reverse style.
"false" / "0"	Disables the black-and-white reverse style.

ul

Attribute value	Description
"true" / "1"	Enables the underscore style.
"false" / "0"	Disables the underscore style.

em

Attribute value	Description
"true" / "1"	Enables text emphasis settings.

Attribute value	Description
"false" / "0"	Disables text emphasis settings.

color

Attribute value	Description
"none"	No printing
"color_1"	First color
"color_2"	Second color
"color_3"	Third color
"color_4"	Fourth color

x

Attribute value	Description
"0" to "65535"	Specifies the horizontal print start position in dots.

y

Attribute value	Description
"0" to "65535"	Specify the horizontal print start position in dots.

align

Attribute value	Description
"left"	Sets the print start position left-aligned.
"center"	Sets the print start position center-aligned.
"right"	Sets the print start position right-aligned.

rotate

Attribute value	Description
"true" / "1"	Enables text rotation.
"false" / "0"	Disables text rotation.

linespc

Attribute value	Description
"0" to "255"	Specifies paper feed amount per line in dots.

Sample program

Prints text with the following setting:

Item	Value
Language	Japanese
Smoothing	Enabled
Alignment	Center alignment
Font	Font B
Double-width	Quadrupling
Underscore	Enabled

```

<text lang="ja" />
<text smooth="true" />
<text align="center" />
<text font="font_a" />
<text dw="true" dh="true" />
<text ul="true" />
<text>Hello, World!&#10;</text>

```

Supplementary explanation

- To print data other than text after printing text, feed a line or page.
- In the page mode, text is printed from the current print position with the base line dot of the characters as the standard. For information on the base line dot, refer to Printer-specific Support Information.
- Fonts not installed on the printer cannot be printed.
- For the character codes and international character set available for printing, refer to the Technical Reference Guide of the printer.
- For information on available fonts, refer to the Technical Reference Guide of the printer.
- If both of the dw attribute and width attribute are specified in a single element, the scaling factor specified with the width attribute is used.
- If both of the dh attribute and height attribute are specified in a single element, the scaling factor specified with the height attribute is used.
- Colors assigned to the first to fourth colors depend on the printer model.
- In the page mode, the "x" attribute works in the same way as [<position>](#) to specify the horizontal print position.
- The "y" attribute does not work in the standard mode.
- The "align" and "rotate" attributes do not work in the page mode.
- Specify the align attribute at the "beginning of the line."
- The align attribute setting in the <text> element also applies to the align attribute in the [<image>](#), [<logo>](#), [<barcode>](#), and [<symbol>](#) elements.
- The rotate attribute setting in the <text> element also applies to the rotate attribute in the [<barcode>](#) and [<symbol>](#) elements.
- Use [<direction>](#) to enable text rotation in the page mode.
- For slip, endorsement, or validation printing, an integer from 1 to 2 can be set for the width and height.
- When specifying the lang attribute, specify it at the beginning of the print request.

<feed>

Specifies the paper feed amount in dots or lines, and specifies line feed amount and paper feed position per line. When the paper feed amount is not specified, the paper is fed by one line.

List of properties available for each print method

Attribute	Description	Print method				
		Receipt	Slip	Endorsement	Endorsement (40cpl)	Validation
unit	Paper feed amount in units of dots	✓	✓	✓	✓	✓
line	Paper feed amount in units of lines	✓	✓	✓	✓	✓
linespc	Paper feed amount per line	✓	✓	✓	✓	✓
pos	Paper feed amount for label sheet/ black mark sheet	✓	-	-	-	-

Attribute***unit***

Attribute value	Description
"0" to "255"	Specifies paper feed amount in dots.

line

Attribute value	Description
"0" to "255"	Specifies paper feed amount in lines.

linespc

Attribute value	Description
"0" to "255"	Specifies paper feed amount per line in dots.

pos

Attribute value	Description
"peeling"	Feed the sheet to the peeling position.
"cutting"	Feed the sheet to the cut position.
"current_tof"	Feed the sheet to the top of the current label.
"next_tof"	Feed the sheet to the top of the next label.

Sample program

- Feeds the sheet by three lines.

```
<feed line="3" />
```

- Prints text and feeds a line.

```
<text>Hello</text><feed />
<text>World</text><feed />
```

- Prints text while peeling off labels one by one.

```
<feed pos="current_tof" />
<barcode type="code39" hri="below">0001</barcode>
<feed pos="peeling" />
```

Supplementary explanation

- The line feed amount for the standard and page modes are stored separately. Specifying the `linespc` attribute influences the `linespc` attribute of the succeeding `<text>` element.
- When the `linespc` attribute is set to 30 dots, up to 240 lines can be specified.
- The `pos` attribute does not work in the page mode.
- If the line spacing for a single line is set smaller than the print character size, paper may be fed for a larger quantity than the set amount to ensure proper printing.

<image>

Specifies image data in the raster format. (Data type xs:base64Binary)

Attribute**width**

Attribute value	Description
"0" to "65535"	Specifies the image width in dots.

height

Attribute value	Description
"0" to "65535"	Specifies the image height in dots.

color

Attribute value	Description
"none"	No printing
"color_1"	First color
"color_2"	Second color
"color_3"	Third color
"color_4"	Fourth color

align

Attribute value	Description
"left"	Left alignment
"center"	Center alignment
"right"	Right alignment

mode

Attribute value	Description
"mono"	Monochrome (2 scales)
"gray16"	Multi-gradation (16 scales)

Sample program

- Prints a raster image filling 8 dots x 8 dots area.

```
<image width="8" height="8">/////////8=</image>
```

Supplementary explanation

- ❑ Multi-gradation printing can be used in the standard mode but not in the page mode.
- ❑ The read quality of a barcode or 2D symbol printed as a multi-gradation raster image is not guaranteed. Use two-scale printing.
- ❑ To print a raster image at a high speed, set the [align](#) attribute to left and the [width](#) attribute value to a multiple of 8 which does not exceed the sheet width of the printer.
- ❑ In the page mode, because image data is printed at the current print position with the lower-left dot of the image data as the reference point, the print position does not move.
- ❑ In the page mode, adjust the print position so that the image data fits within the print area.
- ❑ If a raster image is printed in multi-gradation, it will be printed intermittently due to an increased data quantity and white lines may appear in the printed image.
- ❑ The width and height attributes are mandatory.
- ❑ If the color and mode attributes are omitted, the following values are set:
 - color: color_1
 - mode: mono
- ❑ Colors assigned to the first to fourth colors depend on the printer model.
- ❑ The align attribute does not work in the page mode.
- ❑ Specify the align attribute at the "beginning of the line."
- ❑ The align attribute setting in the <image> element also applies to the align attribute in the <text>, <logo>, <barcode>, and <symbol> elements.
- ❑ Use the ePOS-Print XML generation tool or your own application to create raster image data. Pay attention to the following when using your own application to create raster image data:
 - For two-scale printing: Set the image width to a multiple of 8 or set missing bits to 0.
 - For 16-scale printing: Set the image width to a multiple of 2 or set missing bits to 0.
- ❑ The composition of the image data in raster format is as follows.

When the image is in two colors (black and white)

White: 0, Black: 1

Example:

1	0	1	0	0	0	1	1
0	1	1	1	0	1	1	1
0	0	0	1	1	0	0	0

Step	Description
1	Convert the image to Base64 (byte array) With the upper left as the origin, and with one bit per pixel, pad the data with "0" so that each line data is in bytes. 0xA3 0x77 0x18
2	Encode the image to Base64 o3cy

Step	Description
3	Description <image width="8" height="3" color="color_1" mode="mono">o3cY</image>

When the image is in multiple tones (16 shades)

White: 15 or larger, Black: 0

Example:

15	12	8	4	0	15	12	8
4	0	15	12	8	4	0	15
12	8	4	0	15	12	8	4

Step	Description
1	Convert the image to Base64 (byte array) With the upper left as the origin, and with four bits per pixel, pad the data with "0" so that each line data is in bytes. 0xFC 0x84 0x0F 0xC8 0x40 0xFC 0x84 0x0F 0xC8 0x40 0xFC 0x84
2	Encode the image to Base64 /IQPyED8hA/IQPyE
3	Description <image width="8" height="3" color="color_1" mode="gray16">/IQPyED8hA/IQPyE</image>

<logo>

Specifies the NV logo registered in the NV memory of the printer.

The NV logo needs to be registered to the printer in advance. For how to register the NV logo, refer to the Technical Reference Guide of the printer.

Attribute**key1**

Attribute value	Description
"0" to "255"	Specifies the key code 1 of the NV logo.

key2

Attribute value	Description
"0" to "255"	Specifies the key code 2 of the NV logo.

align

Attribute value	Description
"left"	Left alignment
"center"	Center alignment
"right"	Right alignment

Sample program

- Prints the NV logo with the key codes 1 and 2 registered as "48."

```
<logo key1="48" key2="48" />
```

Supplementary explanation

- Multi-gradation printing can be used in the standard mode but not in the page mode.
- In the page mode, the NV logo is printed at the current print position with the lower-left dot of the NV logo as the reference point.
- The key1 and key2 attributes are mandatory.
- The align attribute setting in the <logo> element also applies to the align attribute in the <text>, <image>, <barcode>, and <symbol> elements.

<barcode>

Specifies barcode data as a text string.

Barcode type

Type	Description
UPC-A	If an 11-digit figure is specified, the check digit is automatically appended. If a 12-digit figure is specified, the 12th digit is used as the check digit but verification is not performed.
UPC-E	Specify 0 in the first digit. Specify the manufacturer code in the 2nd to 6th digits. Specify the item code in right justification in the 7th to 11th digits. The number of digits of the item code depends on the manufacturer code. Specify 0 in each unused data. If an 11-digit figure is specified, the check digit is automatically appended. If a 12-digit figure is specified, the 12th digit is used as the check digit but verification is not performed.
EAN13	If an 12-digit figure is specified, the check digit is automatically appended. If a 13-digit figure is specified, the 13th digit is used as the check digit but verification is not performed.
JAN13	
EAN8	If an 7-digit figure is specified, the check digit is automatically appended. If an 8-digit figure is specified, the 8th digit is used as the check digit but verification is not performed.
JAN8	
CODE39	If the first character is *, this character is processed as the start character. Otherwise, the start character is automatically added.
ITF	The start and stop codes are automatically added. Addition and verification of the check digit are not performed.
CODABAR	Specify the start character (A to D, a to d). Specify the stop character (A to D, a to d). Addition and verification of the check digit are not performed.
CODE93	The start and stop characters are automatically added. The check digit is automatically calculated and added.

Type	Description
CODE128	<p>Specify the start character (CODE A, CODE B, CODE C). The stop character is automatically added. The check digit is automatically calculated and added. To encode the following characters, specify the corresponding 2-digit code starting with { : <ul style="list-style-type: none"> • FNC1: {1 • FNC2: {2 • FNC3: {3 • FNC4: {4 • CODE A: {A • CODE B: {B • CODE C: {C • SHIFT: {S • {: {{ When specifying CODE C, specify the barcode data as the control code of the escape sequence.</p>
CODE128 auto	<p>The start character, check digit, and stop character are automatically added. The character string added to make the overall width of the CODE128 symbol as minimum is automatically converted. In this function, there is no need to specify the code set, and the barcode is printed simply by entering the data to be converted to symbols. Example) When entering numbers: "123", etc. When entering alphabets: "ABCabc", etc. Data from 0 to 255 (control codes and character codes) can be specified. Since the overall width changes automatically, use this function after confirming that the barcode fits into the print area and is printed without any problem. When using FNC1, etc., use CODE128 rather than CODE128 auto.</p>
GS1-128	<p>The start character, FNC1, check digit, and stop characters are automatically added. To automatically calculate and add the application ID (AI) and the following check digit, specify "*" at the check digit position. The application ID (AI) can be put in parentheses. The parentheses are used as print characters for HRI and not encoded as data. A blank space can be inserted between the application ID (AI) and data. The blank space is used as print characters for HRI and not encoded as data. To encode the following characters, specify the corresponding 2-digit code starting with { : <ul style="list-style-type: none"> • FNC1: {1 • FNC3: {3 • (: {(•): {)} • *: {* • {: {{ </p>

Type	Description
GS1 DataBar Omnidirectional,	Specify a 13-digit product ID (GTIN) excluding the application ID (AI) and check digit.
GS1 DataBar Truncated	
GS1 DataBar Limited	
GS1 DataBar Expanded	<p>The application ID (AI) can be put in parentheses. The parentheses are used as print characters for HRI and not encoded as data.</p> <p>To encode the following characters, specify the corresponding 2-digit code starting with {</p> <p>:</p> <ul style="list-style-type: none"> • FNC1: {1 • (: {(•): {}

Attribute**type**

Attribute value	Description
"upc_a"	UPC-A
"upc_e"	UPC-E
"ean13"	EAN13
"jan13"	JAN13
"ean8"	EAN8
"jan8"	JAN8
"code39"	CODE39
"itf"	ITF
"codabar"	CODABAR
"code93"	CODE93
"code128"	CODE128
"code128_auto"	CODE128 auto
"gs1_128"	GS1-128
"gs1_databar_omnidirectional"	GS1 DataBar Omnidirectional
"gs1_databar_truncated"	GS1 DataBar Truncated
"gs1_databar_limited"	GS1 DataBar Limited
"gs1_databar_expanded"	GS1 Databar Expanded

hri

Attribute value	Description
"none"	No printing.
"above"	Above the barcode
"below"	Below the barcode
"both"	Both above and below the barcode

font

Attribute value	Description
"font_a"	Font A
"font_b"	Font B
"font_c"	Font C
"font_d"	Font D
"font_e"	Font E

width

Attribute value	Description
"2" to "6"	Specifies the width of a single module in dots.

height

Attribute value	Description
"1" to "255"	Specify the width of a single module in dots.

align

Attribute value	Description
"left"	Left alignment
"center"	Center alignment
"right"	Right alignment

rotate

Attribute value	Description
"true" / "1"	Enables text rotation.
"false" / "0"	Disables text rotation.

Sample program

- Specifies various types of barcodes.

```

<barcode type="upc_a" width="2" height="64" hri="below">01234567890</barcode>
<barcode type="upc_e">01234500005</barcode>
<barcode type="ean13">201234567890</barcode>
<barcode type="jan13">201234567890</barcode>
<barcode type="ean8">2012345</barcode>
<barcode type="jan8">2012345</barcode>
<barcode type="code39">ABCDE</barcode>
<barcode type="itf">012345</barcode>
<barcode type="codabar">A012345A</barcode>
<barcode type="code93">ABCDE</barcode>
<barcode type="code128">{Babcde</barcode>
<barcode type="gs1_128">(01)201234567890*</barcode>
<barcode type="gs1_databar_omnidirectional">0201234567890</barcode>
<barcode type="gs1_databar_truncated">0201234567890</barcode>
<barcode type="gs1_databar_limited">0201234567890</barcode>
<barcode type="gs1_databar_expanded">(01)2012345678903</barcode>

```

Supplementary explanation

- When Standard mode is selected, this command is enabled only when the print position is at the head of a line or when no data exists in the print buffer.
- If the setting does not conform to the barcode standard or the defined barcode is larger than the print area of the printer, the barcode will not be printed and no error will be returned.
- In the page mode, the barcode is printed at the current position with the lower-left dot (except for HRI) as the standard point.
- Use the following escape sequences to specify binary data which cannot be represented as a string:
 - Control code: \xnn (set nn in hexadecimal)
 - Back slash: \\
- The type attribute is mandatory.
- The "align" and "rotate" attributes do not work in the page mode.
- Specify the "align" and "rotate" attributes at the "beginning of the line."
- The align attribute setting in the <barcode> element also applies to the align attribute in the <text>, <image>, <logo>, and <symbol> elements.
- The rotate attribute setting in the <barcode> element also applies to the rotate attribute in the <text> and <symbol> elements.
- Use <direction> to enable text rotation in the page mode.

<symbol>

Specifies a 2D symbol as a text string.

2D symbol type

Type	Description
PDF417	Converts the string into UTF-8, processes the escape sequence(s), and encodes the data. The maximum number of code words in the data area is 928, the maximum number of code words in a single stage is 30, and the maximum number of stages is 90.
QR Code	Converts the string into JIS, processes the escape sequence(s), and encodes the data by choosing the data type from the following: <ul style="list-style-type: none"> • Numeric data: 0 to 9 • Alphanumeric data: 0 to 9, A to Z, space, \$, %, *, +, -, ., /, : • Kanji data: Shift JIS string • 8-bit byte data: 0x00 to 0xff
Micro QR Code	
MaxiCode	Converts the string into UTF-8, processes the escape sequence(s), and encodes the data. In Mode 2 or 3, if the first data is []>\x1e01\x1dyy ("yy" is a 2-digit figure), this is processed as the message header and the second and succeeding data sequence is processed as the primary message. Otherwise, the first data is processed as the primary message. Specify the primary message in the following format: <ul style="list-style-type: none"> • Mode 2 Zip code: (1- to 9-digit figure) GS: (\x1d) ISO country code: (1- to 3-digit figure) GS: (\x1d) Service class code (1- to 3-digit figure) • Mode 3 Zip code: (Data which can be converted with 1 to 6 code sets A) GS: (\x1d) ISO country code: (1- to 3-digit figure) GS: (\x1d) Service class code (1- to 3-digit figure)
GS1 DataBar Stacked	Converts the string into UTF-8, processes the escape sequence(s), and encodes the data. Specify a 13-digit product ID (GTIN) excluding the application ID (AI) and check digit.
GS1 DataBar Stacked Omnidirectional	
GS1 DataBar Expanded Stacked	Converts the string into UTF-8, processes the escape sequence(s), and encodes the data. The application ID (AI) can be put in parentheses. The parentheses are used as print characters for HRI and not encoded as data. To encode the following characters, specify the corresponding 2-digit code starting with { : <ul style="list-style-type: none"> • FNC1: {1 • (: {(•): {}

Type	Description
Aztec Code	Converts the string into UTF-8, processes the escape sequence(s), and encodes the data.
DataMatrix	Converts the string into UTF-8, processes the escape sequence(s), and encodes the data.

Attribute**type**

Attribute value	Type
"pdf417_standard"	Standard PDF417
"pdf417_truncated"	Truncated PDF417
"qrcode_model_1"	QR Code Model 1
"qrcode_model_2"	QR Code Model 2
"qrcode_micro"	Micro QR Code
"maxicode_mode_2"	MaxiCode Mode 2
"maxicode_mode_3"	MaxiCode Mode 3
"maxicode_mode_4"	MaxiCode Mode 4
"maxicode_mode_5"	MaxiCode Mode 5
"maxicode_mode_6"	MaxiCode Mode 6
"gs1_databar_stacked"	GS1 DataBar Stacked
"gs1_databar_stacked_omnidirectional"	GS1 DataBar Stacked Omnidirectional
"gs1_databar_expanded_stacked"	GS1 DataBar Expanded Stacked
"azteccode_fullrange"	Aztec Code Full-Range mode
"azteccode_compact"	Aztec Code Compact mode
"datamatrix_square"	DataMatrix ECC200 Square
"datamatrix_rectangle_8"	DataMatrix ECC200 Rectangle, 8 lines
"datamatrix_rectangle_12"	DataMatrix ECC200 Rectangle, 12 lines
"datamatrix_rectangle_16"	DataMatrix ECC200 Rectangle, 16 lines

level

□ PDF417

Attribute value	Description
"level_0"	Error correction level 0
"level_1" (default value)	Error correction level 1
"level_2"	Error correction level 2
"level_3"	Error correction level 3

Attribute value	Description
"level_4"	Error correction level 4
"level_5"	Error correction level 5
"level_6"	Error correction level 6
"level_7"	Error correction level 7
"level_8"	Error correction level 8
"default"	Default value (error correction level 1)

QR Code

Attribute value	Description
"level_l"	Error correction level L
"level_m"	Error correction level M
"level_q"	Error correction level Q
"level_h"	Error correction level H
"default"	Default value (error correction level M)

Aztec Code

Attribute value	Description
Integer (5 to 95)	Error correction level
"default"	Default value (error correction level 23)

width

2D symbol type	Valid value	Default value
PDF417	"2" to "8"	"3"
QR Code	"3" to "16"	"3"
MaxiCode	Ignored	
GS1 DataBar	"2" to "8"	"2"
Aztec Code	"2" to "16"	"3"
DataMatrix	"2" to "16"	"3"

height

2D symbol type	Valid value	Default value
PDF417	"2" to "8"	"3"

2D symbol type	Valid value	Default value
QR Code	Ignored	
MaxiCode		
2D GS1 DataBar		
Aztec Code		
DataMatrix		

size

2D symbol type	Default value	Description	
PDF417	"0" (automatic)	Specifies the number of code words per stage.	
QR Code	Ignored		
MaxiCode			
2D GS1 DataBar	Expanded Stacked	"0" (automatic)	Specifies the maximum width of the bar-code (106 or more).
	Other	Ignored	
Aztec Code	Ignored		
DataMatrix			

align

Attribute value	Description
"left"	Left alignment
"center"	Center alignment
"right"	Right alignment

rotate

Attribute value	Description
"true" / "1"	Enables text rotation.
"false" / "0"	Disables text rotation.

Sample program

- Specifies various 2D symbols.

```
<symbol type="pdf417_standard">ABCDE</symbol>
<symbol type="qrcode_model_2" level="level_q">ABCDE</symbol>
<symbol type="maxicode_mode_2">908063840\x1d850\x1d001\x1d\x04</symbol>
<symbol type="gs1_databar_stacked">0201234567890</symbol>
<symbol type="gs1_databar_stacked_omnidirectional">0201234567890</symbol>
<symbol type="gs1_databar_expanded_stacked">(01)02012345678903</symbol>
```

Supplementary explanation

- ❑ If the setting does not conform to the 2D symbol standard or the defined 2D symbol is larger than the print area of the printer, the 2D symbol will not be printed and no error will be returned.
- ❑ In the standard mode, a 2D symbol which vertically exceeds 831 dots in size cannot be printed.
- ❑ In the page mode, the 2D symbol is printed at the current position with the lower-left dot of the 2D symbol as the standard point.
- ❑ Use the following escape sequences to specify binary data which cannot be represented as a string:
 - Control code: \xnn (set nn in hexadecimal)
 - Back slash: \\
- ❑ The type attribute is mandatory.
- ❑ Micro QR Code does not support the level_h of the level attribute.
- ❑ Specify the level attribute value in accordance with the 2D symbol type specified in the type attribute.
- ❑ When MaxiCode or 2D GS1 DataBar are specified in the type attribute, specify the default as the level attribute.
- ❑ The “align” and “rotate” attributes do not work in the page mode.
- ❑ Specify the “align” and “rotate” attributes at the “beginning of the line.”
- ❑ The align attribute setting in the <symbol> element also applies to the align attribute in the <text>, <image>, <logo>, and <barcode> elements.
- ❑ The rotate attribute setting in the <symbol> element also applies to the rotate attribute in the <text> and <barcode> elements.
- ❑ Use <direction> to enable text rotation in the page mode.

<hline>

Specifies a horizontal line.

Attribute**x1**

Attribute value	Description
"0" to "65535"	Specifies the start position to draw a horizontal ruled line in dots.

x2

Attribute value	Description
"0" to "65535"	Specifies the end position to draw a horizontal ruled line in dots.

style

Attribute value	Description
"thin"	Solid line: Fine
"medium"	Solid line: Middle
"thick"	Solid line: Thick
"thin_double"	Double line: Fine
"medium_double"	Double line: Middle
"thick_double"	Double line: Thick

Sample program

- Draws horizontal double lines from the 100th dot to 200th dot and from the 400th dot to 500th dot from the left edge, respectively

```
<hline x1="100" x2="200" style="thin_double" />
<hline x1="400" x2="500" style="thin_double" />
```

Supplementary explanation

- This element does not work in the page mode.
- The x1 and x2 attributes are mandatory.
- If the style attribute is omitted, thin is specified by default.

<vline-begin>

Starts drawing a vertical line.

Attribute**x**

Attribute value	Description
"0" to "65535"	Specifies the start position to draw a vertical ruled line in dots.

style

Attribute value	Description
"thin"	Solid line: Fine
"medium"	Solid line: Middle
"thick"	Solid line: Thick
"thin_double"	Double line: Fine
"medium_double"	Double line: Middle
"thick_double"	Double line: Thick

Sample program

- Draws two lines from the 100th dot and 200th dot from the left edge, respectively

```
<vline-begin x="100" />
<vline-begin x="200" />
<feed unit="100" />
<vline-end x="100" />
<vline-end x="200" />
```

Supplementary explanation

- This element does not work in the page mode.
- Use `<line>` to draw a vertical line in the page mode.
- This element continues drawing a vertical line until stopped by `<vline-end>`. Use the `<vline-begin>` element with `<vline-end>`.
- The `x` attribute is mandatory.
- If the `style` attribute is omitted, thin is specified by default.

<vline-end>

Ends drawing a vertical line.

Attribute**x**

Attribute value	Description
"0" to "65535"	Specifies the end position to draw a vertical ruled line in dots.

style

Attribute value	Description
"thin"	Solid line: Fine
"medium"	Solid line: Middle
"thick"	Solid line: Thick
"thin_double"	Double line: Fine
"medium_double"	Double line: Middle
"thick_double"	Double line: Thick

Sample program

- Draws two lines to the 100th dot and 200th dot from the left edge, respectively.

```
<vline-begin x="100" />
<vline-begin x="200" />
<feed unit="100" />
<vline-end x="100" />
<vline-end x="200" />
```

Supplementary explanation

- This element does not work in the page mode.
- Use [<line>](#) to draw a vertical line in the page mode.
- Use this method together with [<vline-begin>](#).
- The x attribute is mandatory.
- If the style attribute is omitted, thin is specified by default.

<page>

Switches from the standard mode to the page mode.

Elements of <page>

Element	Description
<text>	Prints text.
<feed>	Feeds paper.
<image>	Prints a raster image.
<logo>	Prints the NV logo.
<barcode>	Prints a barcode.
<symbol>	Prints a 2D symbol.
<area>	Sets the print area.
<direction>	Sets the print direction.
<position>	Sets the print position.
<line>	Draws a line.
<rectangle>	Draws a rectangle.
<command>	Inserts a command.

Sample program

- Prints "ABCDE" in the page mode.

```
<page>
  <text>ABCDE</text>
</page>
```

<area>

Sets the print area for the page mode by specifying the origin, width, and height, with the absolute origin as the standard.

The absolute origin is the upper-left dot position of the print area.

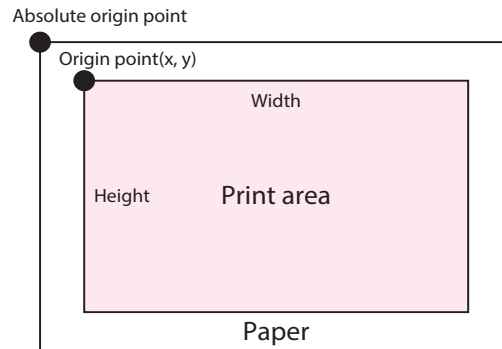
**Attribute****x**

Attribute value	Description
"0" to "65535"	Specifies the horizontal origin in dots.

y

Attribute value	Description
"0" to "65535"	Specifies the vertical origin in dots.

width

Attribute value	Description
"0" to "65535"	Specifies the width in dots.

height

Attribute value	Description
"0" to "65535"	Specifies the height in dots.

Sample program

- Sets the print area with the origin (100,50), width 200 dots, and height 30 dots, and then prints "ABCDE."

```
<page>
<area x="100" y="50" width="200" height="30" />
<text>ABCDE</text>
</page>
```

Supplementary explanation

- ❑ Define the print area in accordance with the contents to print. Any portion of print data outside the print area is not printed.

- ❑ This element does not work in the standard mode.
- ❑ The x, y, width, and height attributes are mandatory.
- ❑ Specify the width and height of the print area in accordance with the print direction setting. If the width and height of the print area do not match the print direction setting, any portion of print data outside the print area will not be printed. The print direction is specified by `<direction>`.

<direction>

Specifies the print direction in the page mode.

It rotates the print area by specifying the print direction. The start point of the print area moves along with rotation.

Attribute**dir**

Attribute value	Description
"left_to_right"	Left to right (Not rotated. Prints rightward from the upper-left point as the origin.)
"bottom_to_top"	Bottom to top (Rotated counterclockwise by 90 degrees. Prints upward from the lower-left point as the origin.)
"right_to_left"	Right to left (Rotated by 180 degrees. Prints leftward from the lower-right point as the origin.)
"top_to_bottom"	Top to bottom (Rotated clockwise by 90 degrees. Prints downward from the upper-right point as the origin.)

Sample program

- Rotates the print area clockwise by 90 degrees and prints "ABCDE."

```
<page>
<direction dir="top_to_bottom" />
<text>ABCDE</text>
</page>
```

Supplementary explanation

- This element does not work in the standard mode.
- The dir attribute is mandatory.

<position>

Specifies the print start position (coordinates) within the print area specified by [<area>](#) with the origin of the print area as the standard.

Attribute**x**

Attribute value	Description
"0" to "65535"	Specify the horizontal print position in dots.

y

Attribute value	Description
"0" to "65535"	Specify the horizontal print position in dots.

Sample program

- Specifies the print start position within the print area specified by the area element to (50,30) and prints "ABCDE."

```
<page>
<area x="100" y="50" width="200" height="100" />
<position x="50" y="30" />
<text>ABCDE</text>
</page>
```

Supplementary explanation

- This element does not work in the standard mode.
- The x and y attributes are mandatory.
- Define the print start position (coordinates) in accordance with the contents to print.

Print data	Description
String	Specify the leftmost position of the baseline for the first character. This can be omitted when printing data with the standard size in left justification. When printing a double-height character, set y to 42 or larger.
Barcode	Specify the lower-left position of the symbol. Specify the height of the barcode in y.
Graphics/logo	Specify the lower-left position of the graphic data. Specify the height of the graphic data in y.
2D symbol	Specify the upper-left position of the symbol. This can be omitted when printing from the upper-left position.

<line>

Draws a line in the page mode.

Attribute**x1**

Attribute value	Description
"0" to "65535"	Specifies the horizontal draw start position in dots.

y1

Attribute value	Description
"0" to "65535"	Specifies the vertical draw start position in dots.

x2

Attribute value	Description
"0" to "65535"	Specifies the horizontal draw end position in dots.

y2

Attribute value	Description
"0" to "65535"	Specifies the vertical draw end position in dots.

style

Attribute value	Description
"thin"	Solid line: Fine
"medium"	Solid line: Middle
"thick"	Solid line: Thick
"thin_double"	Double line: Fine
"medium_double"	Double line: Middle
"thick_double"	Double line: Thick

Sample program

- Draws a thin solid line with the start point (100,0) and end point (500,0).

```
<page>
<line x1="100" y1="0" x2="500" y2="0" style="thin" />
</page>
```

Supplementary explanation

- ❑ This element does not work in the standard mode.

- ❑ A diagonal line cannot be drawn. Specify the attributes so that the line is drawn as a vertical or horizontal line.
- ❑ The x1, y1, x2 and y2 attributes are mandatory.

<rectangle>

Draws a rectangle in the page mode.

Attribute**x1**

Attribute value	Description
"0" to "65535"	Specifies the horizontal draw start position in dots.

y1

Attribute value	Description
"0" to "65535"	Specifies the vertical draw start position in dots.

x2

Attribute value	Description
"0" to "65535"	Specifies the horizontal draw end position in dots.

y2

Attribute value	Description
"0" to "65535"	Specifies the vertical draw end position in dots.

style

Attribute value	Description
"thin"	Solid line: Fine
"medium"	Solid line: Middle
"thick"	Solid line: Thick
"thin_double"	Double line: Fine
"medium_double"	Double line: Middle
"thick_double"	Double line: Thick

Sample program

- Draws a rectangle with the start point (100,0) and end point (500,0) as apexes as a thin double line.

```
<page>
<rectangle x1="100" y1="0" x2="500" y2="200" style="thin_double" />
</page>
```

Supplementary explanation

- This element does not work in the standard mode.
- Use the [<hline>](#), [<vline-begin>](#), and [<vline-end>](#) elements in the standard mode.

- ❑ The x1, y1, x2 and y2 attributes are mandatory.

<cut>

Specifies how to cut paper.

Attribute**type**

Attribute value	Description
"no_feed"	Cut without feed (cut the sheet without feeding paper).
"feed"	Feed cut (cut the sheet after feeding paper).
"reserve"	Cut reservation (print the following texts and cut the sheet at the cutting position).
"feed_fullcut"	Feed full cut (cut the sheet after feeding paper).
"no_feed_fullcut"	Full cut without feed (cut the sheet without feeding paper).
"reserve_fullcut"	Full cut reservation (print the following texts and full cut the sheet at the cutting position).

Sample program

- Performs feed cut.

```
<cut type="feed" />
```

Supplementary explanation

- This element does not work in the page mode.
- Specify the cut attribute at the "beginning of the line."
- If print data is not specified after the cut reservation (reserve), the printer will execute the cut after feeding paper up to the position of the reserved cut.
- Depending on the printer, it may wait approximately 2 seconds for the print data after the cut reservation (reserve) before starting the paper feed operation.
- When using the cut reservation (reserve), set the length of one receipt to at least 20 mm.

<pulse>

Defines signal output to the drawer kick connector.

Attribute**drawer**

Attribute value	Description
"drawer_1"	Drawer kick connector pin No.2
"drawer_2"	Drawer kick connector pin No.5

time

Attribute value	Description
"pulse_100"	100-msec signal
"pulse_200"	200-msec signal
"pulse_300"	300-msec signal
"pulse_400"	400-msec signal
"pulse_500"	500-msec signal

Sample program

- Outputs a 100-msec pulse signal to the drawer kick connector pin No.2.

```
<pulse drawer="drawer_1" time="pulse_100" />
```

Supplementary explanation

- This element does not work in the page mode.
- The drawer function cannot be used with the buzzer function.
- Do not open the drawer repeatedly during short intervals. Doing so places excessive load on the drawer, which may result in damage.

<sound>

Specifies how to sound the buzzer.

Attribute**pattern**

Attribute value	Description
"none"	Stop
"pattern_a"	Pattern A (optional external buzzer)
"pattern_b"	Pattern B (optional external buzzer)
"pattern_c"	Pattern C (optional external buzzer)
"pattern_d"	Pattern D (optional external buzzer)
"pattern_e"	Pattern E (optional external buzzer)
"error"	Error sound pattern (optional external buzzer)
"paper_end"	Paper empty sound pattern (optional external buzzer)
"pattern_1"	Pattern 1 (built-in buzzer)
"pattern_2"	Pattern 2 (built-in buzzer)
"pattern_3"	Pattern 3 (built-in buzzer)
"pattern_4"	Pattern 4 (built-in buzzer)
"pattern_5"	Pattern 5 (built-in buzzer)
"pattern_6"	Pattern 6 (built-in buzzer)
"pattern_7"	Pattern 7 (built-in buzzer)
"pattern_8"	Pattern 8 (built-in buzzer)
"pattern_9"	Pattern 9 (built-in buzzer)
"pattern_10"	Pattern 10 (built-in buzzer)

repeat

Attribute value	Description
"0"	Unlimited
"1" to "255"	1 to 255 times

cycle

Attribute value	Description
"1000" to "25500"	Specifies the buzzer sound cycle in milliseconds.

Sample program

- Sounds the pattern A three times.

```
<sound pattern="pattern_a" repeat="3" />
```

Supplementary explanation

- This element does not work in the page mode.
- The buzzer function cannot be used with the drawer function.
- This element can be used with a model which has the buzzer function.
- To stop the buzzer after specifying "0" in the repeat attribute, issue the request again by specifying "none" in the pattern attribute.
- The cycle attribute is only available when pattern_1 to pattern_10 is specified in the pattern attribute.

<command>

Specifies an ESC/POS command in the hexadecimal encoding format.

Supplementary explanation

- ❑ Refer to the following URL for details of the ESC/POS command.
<https://www.epson-biz.com/pos/reference/>
- ❑ ePOS-Device Service does not check the commands sent by the <command> XML. If the commands interfere with ePOS-Device Service operations, other xml controls may work wrongly or status values may become invalid.
This XML should be used with a full understanding of ESC/POS commands and the receipt printer specifications.

<layout>

Specifies the page layout.

Attribute**type**

Attribute value	Description
"receipt"	Receipt
"receipt_bm"	Receipt (with black mark)
"label"	Label sheet
"label_bm"	Label sheet (with black mark)

width

Attribute value	Description
"290" to "600"	Specifies the paper width in 0.1-mm units.

height

Valid value	Paper type	Description
"0"	Receipt	Specification is not required.
	Receipt (with black mark)	
	Label sheet	
	Label sheet (with black mark)	
"254" to "2540"	Receipt (with black mark)	Specifies the distance between the top edges of two consecutive black marks in 0.1-mm units.
"284" to "-1550"	Receipt (with black mark)	Specifies the distance between the top edges of two consecutive black marks in 0.1-mm units.
	Label sheet	Specifies the distance between the top edges of two consecutive labels in 0.1-mm units.
	Label sheet (with black mark)	Specifies the distance between the bottom edges of two consecutive black marks in 0.1-mm units.

margin-top

Valid value	Paper type	Description
"0"	Receipt	Specification is not required.
"-150" to "1500"	Receipt (with black mark)	Specifies the distance between the top edge of a black mark to the top of the sheet in 0.1-mm units.

Valid value	Paper type	Description
"0" to "1500"	Label sheet	Specifies the distance between the top edge of a label to the top of the sheet in 0.1-mm units.
"-15" to "1500"	Label sheet (with black mark)	Specifies the distance between the bottom edge of a black mark to the top of the sheet in 0.1-mm units.

margin-bottom

Valid value	Paper type	Description
"0"	Receipt	Specification is not required.
	Receipt (with black mark)	
"-15" to "0"	Label sheet	Specifies the distance between the bottom edge of a label to the bottom of the print area in 0.1-mm units. (A positive value widens the margin and a negative value narrows it.)
"-15" to "15"	Label sheet (with black mark)	Specifies the distance between the top edge of a black mark to the bottom of the print area in 0.1-mm units. (A positive value widens the margin and a negative value narrows it.)

offset-cut

Valid value	Paper type	Description
"0"	Receipt	Specification is not required.
"-290" to "50"	Receipt (with black mark)	Specifies the distance between the top edge of a black mark to the cut position in 0.1-mm units.
"0" to "50"	Label sheet	Specifies the distance between the bottom edge of a label to the cut position in 0.1-mm units.
	Label sheet (with black mark)	Specifies the distance between the top edge of a black mark to the cut position in 0.1-mm units.

offset-label

Valid value	Paper type	Description
"0"	Receipt	Specification is not required.
	Receipt (with black mark)	
	Label sheet	
"0" to "15"	Label sheet (with black mark)	Specifies the distance between the top edge of a black mark to the bottom edge of a label in 0.1-mm units.

Sample program

- 58 mm length receipt

```
<sound pattern="pattern_a" repeat="3" />
```

- 58 mm receipt (with black mark)

```
<layout type="receipt_bm" width="580" height="0" margin-top="15" offset-cut="0" />
```

- 58 mm label sheet

```
<layout type="label" width="580" height="0" margin-top="15" margin-bottom="-15" offset-cut="25" />
```

- 58 mm label sheet (with black mark)

```
<layout type="label_bm" width="580" height="0" margin-top="15" margin-bottom="-15" offset-cut="25" offset-label="15" />
```

Detailed description

Refer to the following for the parameter positions available for each type of paper.

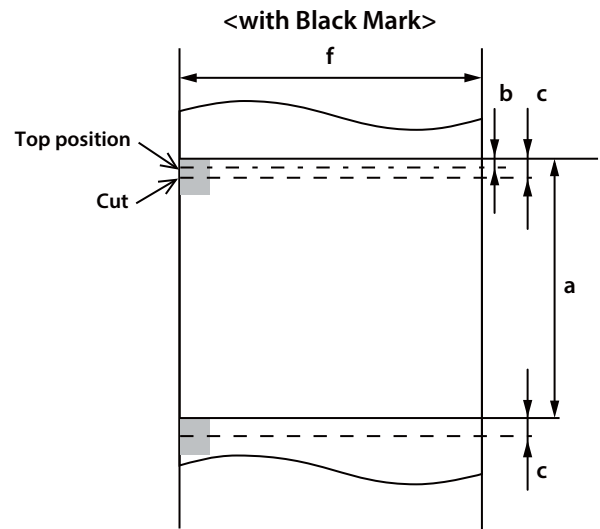
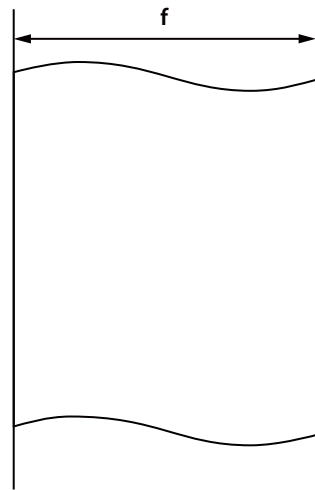
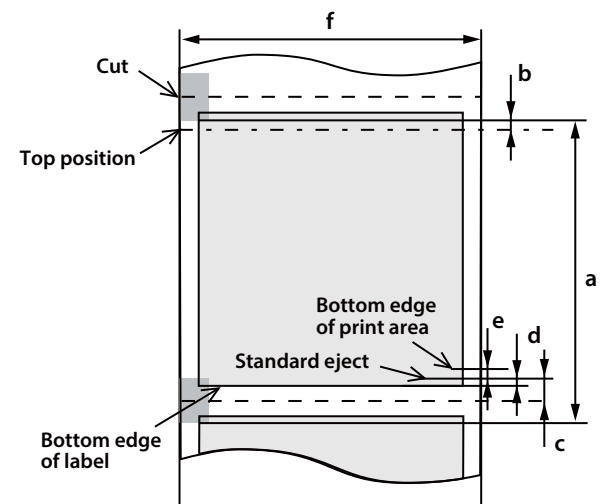
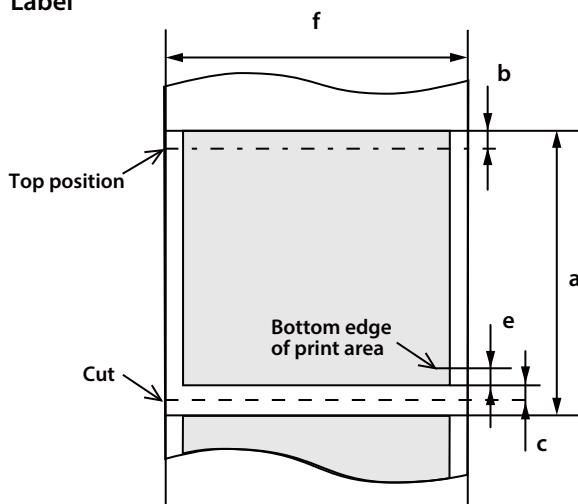
Receipt**Label**

Symbol	Parameter
f	width
a	height
b	margin_top
e	margin_bottom
c	offset_cut
d	offset_label

Supplementary explanation

This element does not work in the page mode.

<recovery>

Recovers the printer from an error condition.

When a recoverable error occurs with the printer, just removing the error cause does not recover the printer from the error. By executing the <recovery> element, the printer recovers from the error and becomes ready for printing.

Sample program

- Recovers from a recoverable error and clears the printer buffer.

```
<recovery />
```

Supplementary explanation

- This element does not work in the page mode.
- Enable the forced transmission mode (<epos-print>) when using this method.
- After recovering from a recoverable error, the buffer of the printer is reset.

<reset>

Resets the printer.

The printer returns to the initialized state and print data remaining in the printer buffer and any other data which is not stored in the printer (e.g., print setting) will be all lost.

Sample program

- Resets the printer.

```
<reset />
```

Supplementary explanation

This element does not work in the page mode.

<batch-begin>

Starts the batch normal print mode.

Sample program

- Prints characters [ABCDE] in the batch normal print mode.

```
<batch-begin>
<text>ABCDE</text>
<batch-end>
```

Supplementary explanation

- This element does not work in the page mode.
- Use the element for batch normal printing (Example: [<text>](#)) by enclosing between this element and [<batch-end>](#).
- Do not use the following elements between this element and [<batch-end>](#).
 - [<page>](#)
 - [<cut>](#)
 - [<pulse>](#)
 - [<sound>](#)
 - [<type>eject</type>](#)
- The data volume that the printer can process in a single batch normal print is as described below.
 - Strings: 80 lines
 - Graphics: 2400 dots
- When you are using an element (Example: [<text>](#)) in the batch normal print mode, you must take care while using certain elements.

Element	Precautions
<text>	<ul style="list-style-type: none"> • If the longitudinal direction is set to triple angle or higher with the height attribute before this element, then this element and the succeeding elements will become double-angled. • If the longitudinal direction is set to triple angle or higher with the height attribute after this element, then the specification in the longitudinal direction will be ignored and become single-angled.
<feed>	The number of paper feed lines varies depending on the line spacing specified in the linespc attribute. If the line spacing is specified as 30 in the linespc attribute, paper feeding can be performed for eight lines with the maximum value of the unit attribute as 255.

Element	Precautions
<image>	<ul style="list-style-type: none">• If the total vertical size of print data exceeds 2400 dots, printing may not be performed as intended. For example, if 500-dot data B is sent to a location in the printer buffer where 2000-dot data A is accumulated, then data B will be accumulated in the printer buffer after data A has been printed.• The multi-gradation (16 scales) maximum size is up to 600 dots vertically. In the case of multi-gradation (16 scales), a data volume that is four times that of monochrome (2 scales) is required.• If the vertical size of one image element exceeds the data volume that can be processed in one go, printing will not be performed. Monochrome (2 scales) maximum value: 2400 dots Multi-gradation (16 scales) maximum value: 600 dots

<batch-end>

Ends the batch normal print mode.

Sample program

- Prints characters [ABCDE] in the batch normal print mode.

```
<batch-begin>  
<text>ABCDE</text>  
<batch-end>
```

Supplementary explanation

- This element does not work in the page mode.
- Use the element for batch normal printing (Example: `<text>`) by enclosing between this element and `<batch-begin>`.

<rotate-begin>

Starts the batch rotate print mode.

Sample program

- Prints characters [ABCDE] in the batch rotate print mode.

```
<rotate-begin>
<text>ABCDE</text>
<rotate-end>
```

Supplementary explanation

- This element does not work in the page mode.
- Use the element for batch rotate printing (Example: [<text>](#)) by enclosing between this element and [<rotate-end>](#).
- Do not use the following elements between this element and [<rotate-end>](#).
 - [<page>](#)
 - [<cut>](#)
 - [<pulse>](#)
 - [<sound>](#)
 - [<type>eject</type>](#)
- The data volume that the printer can process in a single batch rotate printing is as described below.
 - Strings: 80 lines
 - Graphics: 2400 dots
- When you are using an element (Example: [<text>](#)) in the batch rotate print mode, you must take care while using certain elements.

Element	Precautions
<text>	<ul style="list-style-type: none"> • If the longitudinal direction is set to triple angle or higher with the height attribute before this element, then this element and the succeeding elements will become double-angled. • If the longitudinal direction is set to triple angle or higher with the height attribute after this element, then the specification in the longitudinal direction will be ignored and become single-angled.
<feed>	The number of paper feed lines varies depending on the line spacing specified in the linespc attribute. If the line spacing is specified as 30 in the linespc attribute, paper feeding can be performed for eight lines with the maximum value of the unit attribute as 255.

Element	Precautions
<image>	<ul style="list-style-type: none">• If the total vertical size of print data exceeds 2400 dots, printing may not be performed as intended. For example, if 500-dot data B is sent to a location in the printer buffer where 2000-dot data A is accumulated, then data B will be accumulated in the printer buffer after data A has been printed.• The multi-gradation (16 scales) maximum size is up to 600 dots vertically. In the case of multi-gradation (16 scales), a data volume that is four times that of monochrome (2 scales) is required.• If the vertical size of one image element exceeds the data volume that can be processed in one go, printing will not be performed. Monochrome (2 scales) maximum value: 2400 dots Multi-gradation (16 scales) maximum value: 600 dots

<rotate-end>

Ends the batch rotate print mode.

Sample program

- Prints characters [ABCDE] in the batch rotate print mode.

```
<rotate-begin>  
<text>ABCDE</text>  
<rotate-end>
```

Supplementary explanation

- This element does not work in the page mode.
- Use the element for batch rotate printing (Example: `<text>`) by enclosing between this element and `<rotate-begin>`.

CustomerDisplay Messages

`<type>display</type>`

Sends display data and configuration data to the customer display and requests for displaying data on the customer display. The request result is acquired by the `<type>onxmlresult</type>` element.

Request

Child element	Data type	Description
timeout	int	Specifies the timeout for the request in milliseconds. Value: 1000 to 60000 (integer)
displaydata	string	Specifies an XML to control the customer display.

Sample program

```
<data>
  <type>display</type>
  <timeout>10000</timeout>
  <displaydata>
    <!-- CustomerDisplay Control XML -->
    <epos-display xmlns=
      .
    </epos-display>
  </displaydata>
</data>
```

Supplementary explanation

Refer to [CustomerDisplayControl XML](#) for details of display data specified in the displaydata child element.

<type>onxmlresult</type>

Acquires the result of the display request given by the [<type>display</type>](#) element and notifies the application of the result.

Response

Child element	Data type	Description
resultdata	string	Display result

Sample program

```
<data>
  <type>onxmlresult</type>
  <resultdata>
    <response success="true" code="" status="" />
  </resultdata>
</data>
```

Supplementary explanation

- ❑ Refer to [<response>](#) for details of the display result acquired in the resultdata child element.
- ❑ No [<type>onxmlresult</type>](#) is notified if a communication error occurs.
To notify the disconnection event, implement the [<reconnect>](#).
- ❑ If a communication error occurs and it is deemed that no recovery will take place, notify [<disconnect>](#).
Since no [<type>onxmlresult</type>](#) is notified in this case, detect the display failure in [<disconnect>](#).

CustomerDisplayControl XML

<epos-display>

This XML is sent from the application to the customer display.

It requests the customer display to execute a specified function. <epos-display> has child elements necessary to control the customer display.

Attribute

xmlns

Declares the name space of epos-display. The name space is as follows:

`http://www.epson-pos.com/schemas/2012/09/epos-display`

Sample program

- Adds a text tag as the child element.

```
<epos-display xmlns="http://www.epson-pos.com/schemas/2012/09/epos-display">  
  <text>Hello world!!</text>  
</epos-display>
```

<response>

This is an XML returned from the customer display to the application.

Attribute

Attribute	Description
success	Display result
code	Error code
status	Status

success

Attribute value	Description
"true" / "1"	Display succeeded.
"false" / "0"	Display failed.

code

Attribute value	Description
"EDSP_NOT_FOUND"	The device was not found.
"EDSP_NOT_OPEN"	Failed to open the device.
"EDSP_INVALID_WINDOW"	An unregistered window was specified.
"EDSP_SYSTEM_ERROR"	An unexpected error occurred.
"EDSP_SCHEMA_ERROR"	The XML structure is not correct.
"EX_BADPORT"	An internal communication error with the device occurred.
"EX_TIMEOUT"	A timeout error occurred during communication with the device.
"EX_INVALID_VALUE"	An invalid parameter was detected.
"TooManyRequests"	The number of display data sent to the display has exceeded the allowable limit.

status

Attribute value	Description
"0"	Always

Sample program

- When succeeded

```
<response success="true" code="" status="0"/>
```

- When failed

```
<response success="false" code="EDSP_NOT_FOUND" status="0"/>
```

Supplementary explanation

"0" is always set in the status attribute.

<window>

Creates a new window, deletes a specified window, or moves the current window.

- Specifying the number, x, y, width, and height attributes creates a window.
- Specifying the number attribute and specifying "true/1" in the destroy attribute deletes the specified window.
- Specifying the number attribute only moves the current window to the specified window.

Attribute**number**

Attribute value	Description
"1" to "4"	Specifies the window number.

x

Attribute value	Description
"1" to "44"	Specifies the origin of the X coordinate.

y

Attribute value	Description
"1" to "19"	Specifies the origin of the Y coordinate.

width

Attribute value	Description
"1" to "44"	Specifies the window width.

height

Attribute value	Description
"1" to "19"	Specifies the window height.

scrollmode

Attribute value	Description
"overwrite"	<ul style="list-style-type: none"> • When the current display position is at the rightmost position of the upper line, move the display position to the leftmost position of the lower line. • When the current display position is at the rightmost position of the lower line, move the display position to the leftmost position of the upper line. • The character currently displayed at the target position will be overwritten.

Attribute value	Description
"v_scroll"	<ul style="list-style-type: none"> When the current display position is at the rightmost position of the upper line, move the display position to the leftmost position of the lower line. When the current display position is at the rightmost position of the lower line, moves the characters currently on the lower line to the upper line, erases the contents of the lower line, and then moves the display position to the leftmost position of the lower line.
"h_scroll"	<ul style="list-style-type: none"> When a new character is displayed while the current display position is at the rightmost position, shifts the entire line by one character to the left and displays the new character at the rightmost position. Does not feed the line.

destroy

Attribute value	Description
"true" / "1"	Deletes the window specified by number.
"false" / "0"	Does not delete the window.

Error condition

Error value	Description
"EX_INVALID_VALUE"	The x, y, width, and/or height values of the new window coincident with the area of an existing window.
"EDSP_INVALID_WINDOW"	The window specified as the new current window does not exist.

Sample program

- Defines a window "1" of which origin is at the upper-left corner, width is "10," and height is "2" and which scrolls vertically.

```
<window number="1" x="1" y="1" width="10" height="2" scrollmode="v_scroll"/>
```

- Defines a window "2" of which origin is at the center, width is "10," and height is "2" and which scrolls vertically.

```
<window number="2" x="11" y="1" width="10" height="2" scrollmode="v_scroll"/>
```

- Moved the current window to window 1.

```
<window number="1"/>
```

- Deletes window 2.

```
<window number="2" destroy="true"/>
```

Supplementary explanation

- When creating an additional window, pay attention so that the new window does not overlap an existing window on the customer display.

- ❑ If the number, x, y, width, and height elements are specified and the destroy attribute is set to "true/1," no window is created nor deleted.

<screen>

Specifies the base window settings.

Attribute**mode**

Specifies the screen configuration of base window (text/image).

Column/row fixed mode

Attribute value	Installation method	Area (columns × rows)	Screen configuration
"1"	Landscape orientation	20 x 2	"Horizontal split" Divided equally into top and bottom portions. Top: Text, Bottom: Image
"2"	Landscape orientation	20 x 2	"Horizontal split" Divided equally into top and bottom portions. Top: Image, Bottom: Text
"3"	Landscape orientation	20 x 2	"Display in center" Only text is displayed at the center. No division.
"4"	Landscape orientation	32 x 4	"Horizontal split" Divided equally into top and bottom portions. Top: Text, Bottom: Image
"5"	Landscape orientation	32 x 4	"Horizontal split" Divided equally into top and bottom portions. Top: Image, Bottom: Text
"6"	Landscape orientation	32 x 4	"Display in center" Only text is displayed at the center. No division.
"7"	Landscape orientation	42 x 8	"Horizontal split" Divided equally into top and bottom portions. Top: Text, Bottom: Image
"8"	Landscape orientation	42 x 8	"Horizontal split" Divided equally into top and bottom portions. Top: Image, Bottom: Text
"9"	Landscape orientation	42 x 8	"Display in center" Only text is displayed at the center. No division.
"10"	Landscape orientation	32 x 3	"Horizontal split" Divided equally into top and bottom portions. Top: Text, Bottom: Image

Attribute value	Installation method	Area (columns × rows)	Screen configuration
"11"	Landscape orientation	32 x 3	"Horizontal split" Divided equally into top and bottom portions. Top: Image, Bottom: Text
"12"	Landscape orientation	32 x 3	"Display in center" Only text is displayed at the center. No division.
"13"	Landscape orientation	32 x 2	"Horizontal split" Divided equally into top and bottom portions. Top: Text, Bottom: Image
"14"	Landscape orientation	32 x 2	"Horizontal split" Divided equally into top and bottom portions. Top: Image, Bottom: Text
"15"	Landscape orientation	32 x 2	"Display in center" Only text is displayed at the center. No division.

Standard mode

Attribute value	Installation method	Screen configuration
"20"	Landscape orientation	"Full screen" The text/image is displayed on the entire page. No division.
"21"	Portrait orientation	
"22"	Landscape orientation	"Vertical split" Divided equally into left and right portions. Left: Image, Right: Text
"23"	Landscape orientation	"Vertical split" Divided equally into left and right portions. Left: Text, Right: Image
"24"	Landscape orientation	"Horizontal split" Divided equally into top and bottom portions. Top: Text, Bottom: Image
"25"	Landscape orientation	"Horizontal split" Divided equally into top and bottom portions. Top: Image, Bottom: Text
"26"	Portrait orientation	"Horizontal split" Divided equally into top and bottom portions. Top: Text, Bottom: Image

Attribute value	Installation method	Screen configuration
"27"	Portrait orientation	"Horizontal split" Divided equally into top and bottom portions. Top: Image, Bottom: Text
"28"	Portrait orientation	"Horizontal split 1:2" Divided into top and bottom portions in the ratio of 1:2. Top: Text, Bottom: Image
"29"	Portrait orientation	"Horizontal split 2:1" Divided into top and bottom portions in the ratio of 2:1. Top: Image, Bottom: Text
"30"	Portrait orientation	"Horizontal split 2:1" Divided into top and bottom portions in the ratio of 2:1. Top: Text, Bottom: Image
"31"	Portrait orientation	"Horizontal split 1:2" Divided into top and bottom portions in the ratio of 1:2. Top: Image, Bottom: Text

column

Specifies the width (number of columns) of the base window display area.

Attribute value	Description
"1" to "44"	Effective specification range during landscape orientation
"1" to "22"	Effective specification range during portrait orientation

row

Specifies the height (number of rows) of the base window display area.

Attribute value	Description
"1" to "13"	Effective specification range during landscape orientation
"1" to "19"	Effective specification range during portrait orientation

Supplementary explanation

- If this item is executed, all items displayed in customer display are erased.
- This is not activated until values are set in both the column and row attributes.

<textarea>

Creates a new window, deletes a specified window, or moves the current window.

- Specifying the number, x, y, width, and height attributes creates a window.
- Specifying the number attribute and specifying "true/1" in the destroy attribute deletes the specified window.
- Specifying the number attribute only moves the current window to the specified window.

Attribute**number**

Attribute value	Description
"1" to "4"	Specifies the window number.

x

Attribute value	Description
"1" to "44"	Specifies the x-coordinate on the customer display of window origin.

y

Attribute value	Description
"1" to "19"	Specifies the y-coordinate on the customer display of window origin.

width

Attribute value	Description
"1" to "44"	Specifies the window width.

height

Attribute value	Description
"1" to "19"	Specifies the window height.

scrollmode

Attribute value	Description
"overwrite"	<ul style="list-style-type: none"> • When the current display position is at the rightmost position of the upper line, move the display position to the leftmost position of the lower line. • When the current display position is at the rightmost position of the lower line, move the display position to the leftmost position of the upper line. • The character currently displayed at the target position will be overwritten.

Attribute value	Description
"v_scroll"	<ul style="list-style-type: none"> • When the current display position is at the rightmost position of the upper line, move the display position to the leftmost position of the lower line. • When the current display position is at the rightmost position of the lower line, moves the characters currently on the lower line to the upper line, erases the contents of the lower line, and then moves the display position to the leftmost position of the upper line.
"h_scroll"	<ul style="list-style-type: none"> • When a new character is displayed while the current display position is at the rightmost position, shifts the entire line by one character to the left and displays the new character at the rightmost position. • Does not feed the line.

destroy

Attribute value	Description
"true" / "1"	Destroys the window specified by "number"
"false" / "0"	Not destroy

Supplementary explanation

- When the number, x, y, width, and height attributes are specified, and the destroy attribute is set to true/1, window creation processing is not executed, nor is deletion processing.
- After using <textarea>, the origin position of the x and y attributes of <text> and <cursor> appear in the top left of the window set in <textarea>.
- This operation does not occur when column/row fixed mode is set in <screen>.

<cursor>

Specifies the cursor position and display settings.

- Specifying the x and y attributes moves the cursor to the specified coordinates on the customer display.
- Specifying the moveto attribute moves the cursor to the specified position within the current window.

Attribute**x**

Attribute value	Description
"1" to "44"	Specifies the X coordinate.

y

Attribute value	Description
"1" to "19"	Specifies the Y coordinate.

moveto

Attribute value	Description
"top_left"	Moves to the leftmost position on the top line.
"top_right"	Moves to the rightmost position on the top line.
"bottom_left"	Moves to the leftmost position on the bottom line.
"bottom_right"	Moves to the rightmost position on the bottom line.

type

Attribute value	Description
"none"	No cursor display
"underline"	Underscore

Sample program

- Moves the cursor to the upper-left position of the customer display.

```
<cursor x="1" y="1"/>
```

- Moves the cursor to the upper-left position of the current window.

```
<cursor moveto="top_left" type="underline"/>
```

Supplementary explanation

- If the x, y, and moveto attributes are specified at the same time, the cursor does not move.
- In DM-D70 (Standard mode), the cursor position is set in the current window specified in `<textarea>`, with the top left as the origin.

If the window is not specified in `<textarea>`, set the cursor position in the base window, with the top left as the origin.

- ❑ In DM-D70 (Column/row fixed mode), the cursor position is set in the base window, with the top left as the origin.
- ❑ The value that can be specified in the x and y attributes varies depending on the customer display used and its display modes, as well as the installation method.

	x	y
DM-D30	1 to 20	1 to 2
DM-D110		
DM-D210		
DM-D70 (Column/row fixed mode)		
DM-D70 (Standard mode: Landscape orientation)	1 to 44	1 to 13
DM-D70 (Standard mode: Portrait orientation)	1 to 22	1 to 19

<text>

Specifies the display settings of text displayed on the customer display

Attribute**x**

Attribute value	Description
"1" to "44"	Specifies the x coordinate of the display position.

y

Attribute value	Description
"1" to "19"	Specifies the y coordinate of the display position.

reverse

Attribute value	Description
"true" / "1"	Enables the black-and-white reverse style.
"false" / "0"	Disables the reverse style.

lang

Attribute value	Description
"en"	English
"ja"	Japanese (Kana)
"mul"	Multiple languages (UTF-8)

color

Attribute value	Description
"#000000" to "#FFFFFF"	Specifies the color value of the string to be displayed in hexadecimal #RRGGBB

Sample program

- Displays text from the upper-left position.

```
<text x="1" y="1" lang="ja">Carrots \100</text>
```

- Displays text in the black-and-white reverse style from the current cursor position.

```
<text reverse="true">Welcome!!</text>
```

- Changes the current window to window 2 and displays text.

```
<window number="2"/>
<text x="1" y="1" lang="ja">Carrots \100</text>
```

Supplementary explanation

- ❑ If the x and y attributes are omitted, text is displayed at the cursor position at the time when the <text> element is executed.
- ❑ In DM-D70 (Standard mode), the string is displayed at the position coordinates specified, with the top left of the current window specified in <textarea> as the origin.
If the window is not specified in <textarea>, the string is displayed at the position coordinates specified, with the top left of the base window as the origin.
- ❑ In DM-D70 (Column/row fixed mod), the string is displayed at the position coordinates specified, with the top left of the base window as the origin.
- ❑ Refer to <window> for the cursor position after the string is displayed.
- ❑ The value that can be specified in the x and y attributes varies depending on the customer display used and its display modes, as well as the installation method.

	x	y
DM-D30	1 to 20	1 to 2
DM-D110		
DM-D210		
DM-D70 (Column/row fixed mode)		
DM-D70 (Standard mode: Landscape orientation)	1 to 44	1 to 13
DM-D70 (Standard mode: Portrait orientation)	1 to 22	1 to 19

- ❑ Specify the value in both x and y attributes.
If only a single attribute is specified, nothing is displayed.
- ❑ When the color attribute is specified, the font color changes from the position coordinates specified in the x and y attributes.
- ❑ If "mul" is specified in the lang attribute, the font color returns to the default setting of the customer display.
If the color attribute is specified after specifying "mul" in the lang attribute, then color is processed after lang, and therefore, the font color specified in color is applied.

<marquee>

Specifies the marquee display settings.

This element displays characters one by one at the interval specified in `uwait`. After displaying the last character, it waits for the period of time specified in `rwait`, and then restarts displaying from the first character.

Attribute**format**

Attribute value	Description
"walk"	Displays the text from the rightmost position of the window.
"place"	Displays the text from the leftmost position of the window.

repeat

Attribute value	Description
"0"	Repeats display unlimitedly.
"1" to "127"	Specify the display repeat count as an integer.

uwait

Attribute value	Description
"0" to "2000"	Specify the display interval between two successive characters in milliseconds as an integer.

rwait

Attribute value	Description
"100" to "2000"	Specify the wait time after displaying the last character in milliseconds as an integer.

lang

Attribute value	Description
"en"	English
"ja"	Japanese (Kana)

Sample program

- Displays a marquee from the right of the screen at 200 ms/character, then repeats it after waiting for 1000 ms.

```
<marquee uwait="200" rwait="1000">Welcom!!</marquee>
```

- Displays a marquee from the left of the screen at 200 ms/character, then repeats it after waiting for 1000 ms.

```
<marquee uwait="200" rwait="1000" format="place">Welcome!!</marquee>
```

Supplementary explanation

- ❑ For TM-H6000V and DM-D110/DM-D210, "0" is only allowed in repeat.
- ❑ When controlling DM-D30 or DM-D70, due to the characteristics of its LCD, its marquee display may be distorted if the interval for switching text is too short.

It is recommended to set uwait and rwait to the value shown below.

DM-D30: 600 msec or longer

DM-D70: 100 msec or longer

<blink>

Specifies the blink settings of the customer display.

Attribute**interval**

Attribute value	Description
"0"	Stays on (not blinking)
"1" to "12700"	Specify the blink interval in milliseconds.
"12701" to "12750"	Off (Display data is retained.)

Sample program

- Sets the blink interval of the display to 500 ms.

```
<blink interval="500"/>
```

- Cancels blinking of the display.

```
<blink interval="0"/>
```

- Turns off the display. Display data is retained.

```
<blink interval="12750"/>
<cursor moveto="top_left" type="underline"/>
```

Supplementary explanation

The attribute value is rounded up to nearest 50 ms.

Example: 1 => 50, 51 => 100, 101 => 150

<brightness>

Specifies the brightness settings of the customer display.

Attribute

value

Attribute value	Description
"20"	Sets the brightness to 20%.
"40"	Sets the brightness to 40%.
"60"	Sets the brightness to 60%.
"100"	Sets the brightness to 100%.

Sample program

- Sets the brightness to 20%.

```
<brightness value="20"/>
```

- Sets the brightness to 40%.

```
<brightness value="40"/>
```

<backgroundColor>

Specifies the background color.

The background color from the beginning till the end of the row specified in the text area can be changed.

Attribute**color**

Attribute value	Description
"#000000" to "#FFFFFF"	Specifies the color of the background in hexadecimal #RRGGBB

row

Attribute value	Description
"1" to "19"	Changes the background color of the specified row.
"even"	Changes the background color of all even rows.
"odd"	Changes the background color of all odd rows.
"all"	Changes the background color of all rows.

Supplementary explanation

- The background color can be applied only to the text area.
- Attribute color and row are attributes that must be set.
- To apply the background color to a plurality of rows, execute this element a plurality of times.
- To individually specify the background color in a plurality of windows, define the window in [<textarea>](#) before executing this element.
If the window is defined beforehand, the background color can be specified individually for each window.
By dividing the window at the position where the background color is to be changed, the background color can be changed in the middle of the row.
- This operation does not occur when column/row fixed mode is set in [<screen>](#).

<slideshow>

Sets the start or stopping of the slide show.

Attribute**interval**

Attribute value	Description
"200" to "51000"	Specifies the switching period of the slide show in milliseconds.

stop

Attribute value	Description
"true" / "1"	Sets slide show stopping
"false" / "0"	Sets slide show start

Supplementary explanation

Attribute values are rounded up in units of 200 milliseconds.

Example: 1 => 200, 201 => 400, 401 => 600

<downloadimage>

Sets the display of the image registered in [<registerdownloadimage>](#).

Attribute**key1**

Attribute value	Description
"0" to "255"	Specifies keycode 1 indicated in <registerdownloadimage> .

key2

Attribute value	Description
"0" to "255"	Specifies keycode 2 indicated in <registerdownloadimage> .

dotx

Specifies the x-coordinate of the image display position, with the top left of the customer display as the origin.

Attribute value	Description
"0" to "799"	Effective specification range during landscape orientation
"0" to "479"	Effective specification range during portrait orientation

doty

Specifies the y-coordinate of the image display position, with the top left of the customer display as the origin.

Attribute value	Description
"0" to "479"	Effective specification range during landscape orientation
"0" to "799"	Effective specification range during portrait orientation

width

Attribute value	Description
"0" to "1440"	Specifies the width display size (in dots) of the image

height

Attribute value	Description
"0" to "1440"	Specifies the height display size (in dots) of the image

Supplementary explanation

- This can be used when Standard mode is specified in [<screen>](#).
- Attribute key 1 and key 2 are attributes that must be set.

- ❑ To display in the size of the original image, specify 0 in both the width and height attributes.
- ❑ The image is not displayed if it does not fit into the display area.
- ❑ The image specified by this element is displayed in front of the text or image being displayed during the execution.
- ❑ When using a transmission image, use data in the png format.

<registerdownloadimage>

Specifies the raster format image data. (Data format xs:base64Binary)

The specified image data can be registered in the download graphics area of customer display, and can be called by [<downloadimage>](#).

Attribute**key1**

Attribute value	Description
"48" to "57", "65" to "90", "97" to "122"	Specifies keycode 1.

key2

Attribute value	Description
"48" to "57", "65" to "90", "97" to "122"	Specifies keycode 2.

Supplementary explanation

- Attribute key 1 and key 2 are attributes that must be set.
- This element cannot be used simultaneously with other elements.
After executing this element, do not execute any other elements until the callback is returned.
- Execute this element one time only for each [<type>display</type>](#), and register images one at a time.
- If success is not returned in [<type>display</type>](#) by the [<response>](#) execution results, including the results of this element, restart the printer.
Depending on the system environment, it may take some time for the recovery process.
- If the power supply to the customer display is cut off, the registered image is erased.
- As the data size of the image to be registered increases, the processing time becomes longer. (Max. 320 seconds)
- If the data size of the image to be registered is large, and the communication environment is poor, the image may not be registered in this element.
If the image cannot be registered in this element, use dedicated Utility software.
For details on the dedicated Utility software, refer to the Technical Reference Guide of each customer display.
- If an image is registered in the specified keycode, it is overwritten and registered.
- Image data expressed in the pixel format of YCbCr422 or YCbCr420 can be used.
- The image size should be about 100 KB although the upper limit of the image size is 1.5 MB.
- Total size of images that can be registered is 1.5 MB.
This element converts the image format and pixel count so that the customer displays can process the images and then register them. The conversion processing may increase the size of images, so ensure that there is sufficient free space in the download graphics area to accommodate the total size of the images to be registered.
No error is returned when registration was not successful due to insufficient free space in the download graphics area.

- ❑ Use a registration image of 800 x 480 dots or less in size, and ensure that the width is an even number of dots.
- ❑ When using a transmission image, use data in the png format.
- ❑ When using an image in the jpg format, use an image matching the display area of the customer display.

<nvimage>

Specifies the display of the image registered in the NV Graphics area of the customer display.

Attribute**key1**

Attribute value	Description
"0" to "255"	Specifies keycode 1 of NV Graphics.

key2

Attribute value	Description
"0" to "255"	Specifies keycode 2 of NV Graphics.

dotx

Specifies the x-coordinate of the image display position, with the top left of the customer display as the origin.

Attribute value	Description
"0" to "799"	Effective specification range during landscape orientation
"0" to "479"	Effective specification range during portrait orientation

doty

Specifies the y-coordinate of the image display position, with the top left of the customer display as the origin.

Attribute value	Description
"0" to "479"	Effective specification range during landscape orientation
"0" to "799"	Effective specification range during portrait orientation

width

Attribute value	Description
"0" to "1440"	Specifies the width display size (in dots) of the image

height

Attribute value	Description
"0" to "1440"	Specifies the height display size (in dots) of the image

Supplementary explanation

- This can be used when Standard mode is specified in [<screen>](#).
- Attribute key 1 and key 2 are attributes that must be set.

- ❑ To display in the size of the original image, specify 0 in both the width and height attributes.
- ❑ The image is not displayed if it does not fit into the display area.
- ❑ The image specified by this element is displayed in front of the text or image being displayed during the execution.
- ❑ When using a transmission image, use data in the png format.
- ❑ Use the dedicated Utility software for registration of the image to the NV Graphics area of customer display.
For details, refer to the Technical Reference Guide of each customer display.

<clearimage>

Specifies the deletion of the image being displayed.

Supplementary explanation

In this element, the image displayed in the image area is deleted.

To delete the image displayed in the text area, initialize the customer display in [<reset>](#).

<symbol>

Specifies display of the two-dimensional symbol.

Attribute**type**

Attribute value	Description
"qrcode_model_1"	Specifies QR Code Model 1
"qrcode_model_2"	Specifies QR Code Model 2

level

Attribute value	Description
"level_l"	Specifies error revision level L.
"level_m"	Specifies error revision level M.
"level_q"	Specifies error revision level Q.
"level_h"	Specifies error revision level H.
"default"	Specifies the default value (error revision level M).

width

Attribute value	Description
"3" to "16"	Specifies the module size

dotx

Specifies the x-coordinate of the position to display the two-dimensional symbol (in dots).

Attribute value	Description
"0" to "799"	Effective specification range during landscape orientation
"0" to "479"	Effective specification range during portrait orientation

doty

Specifies the y-coordinate of the position to display the two-dimensional symbol (in dots).

Attribute value	Description
"0" to "479"	Effective specification range during landscape orientation
"0" to "799"	Effective specification range during portrait orientation

quietzone

Attribute value	Description
"true" / "1"	Specifies quiet zone assignment as enabled.

Attribute value	Description
"false" / "0"	Specifies quiet zone assignment as disabled.

Supplementary explanation

- ❑ Attribute type is an attribute that must be set.
- ❑ Specify the `<symbol>` element at the "Beginning of the row".
- ❑ This can be used when Standard mode is specified in `<screen>`.
- ❑ In case there is overlapping with the display of text or image, the two-dimensional symbol is displayed right in front.
- ❑ If the string specified within tags is not in accordance with the type of the two-dimensional symbol specified in type, the two-dimensional symbol is not displayed.
- ❑ If quiet zone assignment is enabled, a dot white margin (quiet zone) that is four times the value specified in width is added at the top, bottom, left, and right of the two-dimensional symbol.
- ❑ To enable quiet zone assignment, specify the position coordinates of the top left of the quiet zone as dotx and doty.

<clearsymbol>

Specifies deletion of the two-dimensional symbol being displayed.

Supplementary explanation

If the two-dimensional symbol being displayed overlaps the image, the image at the overlapping portion is erased together with the two-dimensional symbol.

<clock>

Displays the time at the rightmost position on the bottom line of the customer display.
The time displayed is the local time managed by the OS of the printer.

Sample program

```
<clock/>
```

<clear>

Clears the current window.

If no window exists, clears the entire area of the customer display.

Sample program

```
<clear/>
```

<reset>

Resets the customer display. Resetting changes the customer display status as follows:

- Displayed text and registered windows are all discarded.
- Cursor settings are initialized to the default and the cursor position is returned to the origin of the customer display.
- Display blink and brightness settings are initialized to the default.

Sample program

```
<reset/>
```

<command>

Executes an arbitrary ESC/POS command.
The command is specified as a hexadecimal string.

Sample program

```
<command>01025AEF3B405C</command>
```

Supplementary explanation

- ❑ Refer to the following URL for details of the ESC/POS command.
<https://www.epson-biz.com/pos/reference/>
- ❑ ePOS-Device Service does not check the commands sent by the <command> XML. If the commands interfere with ePOS-Device Service operations, other xml controls may work wrongly or status values may become invalid.
This XML should be used with a full understanding of ESC/POS commands and the customer display specifications.

Keyboard Messages

<type>onkeypress</type>

Acquires data input from the keyboard and notifies the application of it.

Response

Child element	Data type	Description
keyCode	int	Decimal value of a key code entered from the keyboard.
ascii	string	Character generated from the key code.

Sample program

```
<data>
  <type>onkeypress</type>
  <keyCode>49</keyCode>
  <ascii>a</ascii>
</data>
```

Supplementary explanation

- ❑ Refer to [List of KeyCode](#) for details of the key code.
- ❑ Depending on the pressing status of the Shift key, a converted character such as an upper case character or symbol is passed to the child element ascii.
- ❑ Depending on the keyboard used, double-byte characters may be included in ascii.

<type>setprefix</type>

Sets a key code which is recognized as the start of a string to accept keyboard input as a sequence of strings. When the key code specified by the <type>setprefix</type> element is entered, the string after it until the Enter key is pressed can be acquired by the <type>onstring</type> element.

Request

Child element	Data type	Description
keycodes	int	Specifies the key code arrangement.

Sample program

```
<data>
  <type>setprefix</type>
  <keycodes array="true">49</keycodes>
  <keycodes>50</keycodes>
  <keycodes>51</keycodes>
  <keycodes>52</keycodes>
</data>
```

Supplementary explanation

- ❑ Use this element for keyboard input as an alternative to a barcode.
- ❑ To finish character entry, execute the <type>setprefix</type> element without specifying the child element keycodes.
- ❑ Refer to [List of KeyCode](#) for details of the key code.

<type>onstring</type>

Acquires a detected string starting with any of the key codes specified by the `<type>setprefix</type>` element and ending with the Enter key, and notifies the application of it. The acquired data also includes the detected key code information.

Response

Child element	Data type	Description
input	string	Detected string
prefix	int	Key code recognized as the start of a string

Sample program

```
<data>
  <type>onstring</type>
  <input>&2398749238429</input>
  <prefix>49</prefix>
</data>
```

Supplementary explanation

- ❑ The key code that is recognized as the start of the string is not included in the string acquired by the input child element.
- ❑ Even if pressing of the Enter key is not detected, string is notified to the application when the number of detected characters exceeds 160.
- ❑ Refer to [List of KeyCode](#) for details of the key code.

<type>setMSRPrefix</type>

Specifies a key code to start using the programmable keyboard with MSR.

When the specified key code is input, the string of the received card information can be acquired by the [<type>ondata</type>](#) element.

Request

Child element	Data type	Description
keycodes	int	Specifies a key code to detect the start of receiving card information.

Sample program

```
<data>
  <type>setMSRPrefix</type>
  <keycode>52</keycode>
</data>
```

Supplementary explanation

- ❑ Cannot be used with ePOS-Device XML (Japanese version).
- ❑ The [<type>setMSRPrefix</type>](#) element is an expansion element for a programmable keyboard with MSR.
It supports the following product:
 - MID-QM128A-GB (TIPRO Ltd.)
- ❑ Refer to [List of KeyCode](#) for details of the key code.

<type>ondata</type>

Acquires the card read information from a programmable keyboard with MSR, and notifies the application of it.

Response

Child element	Data type	Description
track1	string	Entire data of JIS1 track 1
track2	string	Entire data of JIS1 track 2
account_number	string	PAN of JIS 1 track 2
expiration_date	string	Expiration date of JIS1 track 2
surname	string	Gender
first_name	string	First name
middle_initial	string	Middle name/initial
title	string	Title
service_code	string	Service code
track1_dd	string	Arbitrary data of JIS1 track 1
track2_dd	string	Arbitrary data of JIS1 track 2

Sample program

```
<data>
  <track1>B99999999999999999999999999999999^EPSON/TARO ^160410100000 00573000000</
  track1>
  <track2>99999999999999999999999999999999=16041010000057300000</track2>
  <account_number>99999999999999999999999999999999</account_number>
  <expiration_date>1604</expiration_date>
  <surname>EPSON</surname>
  <first_name>TARO</first_name>
  <middle_initial>          </middle_initial>
  <title></title>
  <service_code>101</service_code>
  <track1_dd>00000 00573000000</track1_dd>
  <track2_dd>0000057300000</track2_dd>
</data>
```

Supplementary explanation

- Cannot be used with ePOS-Device XML (Japanese version).
- Even if pressing of the Enter key is not detected, string is notified to the application when the number of detected characters exceeds 160.
- The <type>ondata</type> element is an expansion element for a programmable keyboard with MSR. It supports the following product:
 - MID-QM128A-GB (TIPRO Ltd.)

POSKeyboard Messages

`<data>onkeypress</data>`

The system receives input data from the POS keyboard and notifies applications.

Response

Child element	Data type	Description
poskeycode	int	Keycode configured for a POS key

Sample program

```
<data>
  <type>onkeypress</type>
  <poskeycode>49</poskeycode>
</data>
```

MSR Messages

<data>ondata</data>

Acquires card read information from an MSR device, and notifies the application of it.

Response

Child element	Data type	Description
track1	string	Entire data of JIS1 track 1
track2	string	Entire data of JIS1 track 2
track4	string	Entire data of JIS2 track
account_number	string	PAN of JIS 1 track 2
expiration_date	string	Expiration date of JIS1 track 2
surname	string	Gender
first_name	string	First name
middle_initial	string	Middle name/initial
title	string	Title
service_code	string	Service code
track1_dd	string	Arbitrary data of JIS1 track 1
track2_dd	string	Arbitrary data of JIS1 track 2

Sample program

```
<data>
  <track1>B999999999999999^EPSON/TARO ^160410100000 00573000000</
track1>
  <track2>999999999999999=16041010000057300000</track2>
  <track4>S60000304699992969999770068001604450000160400000000000000000000573
0
  </track4>
  <account_number>999999999999999</account_number>
  <expiration_date>1604</expiration_date>
  <surname>EPSON</surname>
  <first_name>TARO</first_name>
  <middle_initial>          </middle_initial>
  <title></title>
  <service_code>101</service_code>
  <track1_dd>00000 00573000000</track1_dd>
  <track2_dd>0000057300000</track2_dd>
</data>
```

SerialDevice Messages

<type>sendcommand</type>

Sends an arbitrary command to the serial device. The response data from the serial device is acquired by the [<type>oncommandreply</type>](#) element.

Request

Child element	Data type	Description
command	string	Specifies a command as a string.

Sample program

```
<data>
  <type>sendcommand</type>
  <command>1B123344FF1F5D3C</command>
</data>
```

<type>oncommandreply</type>

Acquires the response data to the command sent by the [<type>sendcommand</type>](#) element and notifies the application of it.

Response

Child element	Data type	Description
status	string	Data reception status
data	string	Command string

status

Element value	Description
"SUCCESS"	Data reception succeeded.

Sample program

```
<data>
  <type>oncommandreply</type>
  <status>SUCCESS</status>
  <data>1B123344FF1F5D3C</data>
</data>
```

Supplementary explanation

- ❑ Since data from the device may be divided into multiple responses, be sure to use the [<type>oncommandreply</type>](#) element to confirm that the entire response data has been received. If data is divided into multiple responses, the [<type>oncommandreply</type>](#) element occurs several times. Wait for the succeeding data before proceeding with the process.
- ❑ When a communication error occurs, communication disconnection is not notified. To notify the disconnection event, implement the [<reconnect>](#).

Storage Messages

<type>operate</type>

Sends operational command data to the storage and requests it for processing.

The request result is acquired by the <type>operateresult</type> element.

Request

Child element	Data type	Description
timeout	int	Specifies timeout for the request in milliseconds. Value: 100 to 120000 (integer)
requestdata	string	Specifies JSON data to be processed by storage.

Maximum request data size

64KB

Sample program

Stores the transaction data in the storage.

```
<device_data>
<device_id>local_TSE</device_id>
  <data>
    <type>operate</type>
    <timeout>10000</timeout>
    <requestdata>
      {&quot;storage&quot;:
      {&quot;type&quot;:&quot;TSE&quot;,&quot;vendor&quot;:&quot;TSE1&quot;},
      &quot;function&quot;:&quot;StartTransaction&quot;,&quot;input&quot;:
      {&quot;clientId&quot;:&quot;ClientId_POS1&quot;,
      &quot;processData&quot;:&quot;YXBwbGU=&quot;,
      &quot;processType&quot;:&quot;Start&quot;,
      &quot;additionalData&quot;:&quot;&quot;},
      &quot;compress&quot;:{&quot;required&quot;:false,
      &quot;type&quot;:&quot;&quot;}}
    </requestdata>
  </data>
</device_data>
```

Supplementary explanation

Refer to "Storage Control JSON" for details of requestdata child element.

<type>operateresult</type>

Acquires the result of the operate request given by the `<type>operate</type>` element and notifies the application of the result.

Response

Child Element	Data type	Description
success	bool	true: Success to process. false: Failed to process.
code	string	Specifies the detail. SUCCESS: Successfully processed. ERROR_PARAMETER: Parameter is insufficient or wrong. ERROR_DEVICE_BUSY: Other "operate" request is already processing. ERROR_TIMEOUT: Timeout occurred while processing. ERROR_AUTOMATICAL: Automatical error in printer. ERROR_UNRECOVERABLE: Unrecoverable error in printer. EPTR_CUTTER: Cutter error in printer. EPTR_MECHANICAL: Mechanical error in printer.

Sample program

```
<data>
  <type>operateresult</type>
  <resultdata>
    {&quot;result&quot;:&quot;EXECUTION_OK&quot;,&quot;output&quot;: {}}
  </resultdata>
</data>
```

Supplementary explanation

Refer to "Storage Control JSON" for details of resultdata child element.

OtherPeripheral Messages

<type>User-defined Function</type>

Sends data to device control programs.

The method name is specified by the type element.

Refer to the TM-DT Series Peripheral Device Control Guide for more information.

Request

Child element	Data type	Description
User-defined child element name	User-defined	Specifies data sent to device control programs.

Sample program

```
<data>
  <type>XXX</type>
  <AAA>YYY</AAA>
  <BBB>ZZZ</BBB>
</data>
```

Supplementary explanation

Use the following characters to specify child element values: 0 to 9, a to z, and A to Z.

<type>User-defined Event</type>

This element is used to receive send data and ePOS event names specified by the Send method in device control programs.

The event name is obtained from the value of the type element.

Refer to the TM-DT Series Peripheral Device Control Guide for more information.

Response

Child element	Data type	Description
Element name for send data specified by device control programs	User-defined	Value of element specified by device control programs

Sample program

```
<data>
  <type>xxx</type>
  <bbb>yyy</bbb>
</data>
```

List of KeyCode

Key	KeyCode (Decimal)	Key	KeyCode (Decimal)
Backspace	8	F1	112
Tab	9	F2	113
Enter	13	F3	114
Shift	16	F4	115
Ctrl	17	F5	116
Alt	18	F6	117
Caps Lock	20	F7	118
Esc	27	F8	119
Space	32	F9	120
PageUp	33	F10	121
PageDown	34	F11	122
End	35	F12	123
Home	36	i	161
!	37	£	163
#	38	¤	164
i	39	€	164
\$	40	§	167
Insert	45	¬	172
Delete	46	°	176
0	48	²	178
1	49	³	179
2	50	µ	181
3	51	:	186
4	52	;	187
5	53	,	188
6	54	-	189
7	55	.	190
8	56	/	191
9	57	¿	191
A	65	@	192
B	66	Ä	196
C	67	É	201
D	68	Í	205

Key	KeyCode (Decimal)	Key	KeyCode (Decimal)
E	69	Ñ	209
F	70	Ó	211
G	71	Ö	214
H	72	Ú	218
I	73	[219
J	74	\	220
K	75	Û	220
L	76]	221
M	77	^	222
N	78	ß	223
O	79	à	224
P	80	ä	228
Q	81	ç	231
R	82	è	232
S	83	é	233
T	84	ì	236
U	85	í	237
V	86	Caps Lock	240
W	87	ñ	241
X	88	ò	242
Y	89	ó	243
Z	90	ö	246
*	106	ù	249
+	107	ú	250
/	109	ü	252

Device Specifications

This chapter describes restrictions on using elements and their attributes, which differ depending on the model of printer and customer display.



For more detailed specifications for your printer, refer to the Technical Reference Guide of the printer.

Supported Printers by XMLs

The following is a list of supported printers by XMLs.

Message		Supported Printers
Message data for communication path	<connect>	All Printers
	<reconnect>	
	<disconnect>	
Message data for management information	<admin_info>	All Printers
CommunicationBox Messages	<open_commbox>	<ul style="list-style-type: none"> • TM-DT series • TM-i series
	<close_commbox>	
	<commbox_data>	
Message data for device communication	<open_device>	All Printers
	<close_device>	

Message		Supported Printers	
Device Messages	<device_data>	DeviceHubTerminal	TM-DT series
		BarcodeScanner	<ul style="list-style-type: none"> • TM-DT series • TM-i series • TM Printer
		Printer	All Printers Availability and restriction on the use of PrinterControl XML differs by printers. Refer to List of Supported Elements .
		HybridPrinter	TM-H6000V
		CustomerDisplay	All Printers Availability and restriction on the use of CustomerDisplayControl XML differs by printers. Refer to List of Supported Elements .
		Keyboard	<ul style="list-style-type: none"> • TM-DT series • TM-i series
		POSKeyboard	TM-DT series
		MSR	<ul style="list-style-type: none"> • TM-DT series • TM-T88VI-iHUB
		SerialDevice	<ul style="list-style-type: none"> • TM-DT series • TM-i series (excludes the model without a serial port)
		Storage	<ul style="list-style-type: none"> • TM-m30 • TM-m30II-H • TM-m30II-NT • TM-m30II-S • TM-m30II-SL • TM-m30III • TM-m30III-H • TM-m50 • TM-T88VI-iHUB
	OtherPeripheral	TM-DT series	
Message data for OFSC-Print Service	<service_data>	<ul style="list-style-type: none"> • TM-DT series • TM-i series • TM-T88VI 	
Message data for error notification	<error>	All Printers	

ePOS-Device XML Functions That Can Be Used with TM Printer

The ePOS-Device XML functions can be used with TM-m30 of the following firmware versions.

- ❑ TM-m30 Firmware Ver.1.40 ESC/POS or later

The ePOS-Device XML functions can be used with TM-T88VI of the following firmware versions.

- ❑ TM-T88VI Firmware Ver.40.50 ESC/POS or later

ePOS-Device XML Functions That Can Be Used

	Peripheral devices that can be used				Network printer function	Communication box	Spooler function
	DM-D30	DM-D70	DM-D110	Barcode scanner			
TM-m30	✓	✓	-	✓	-	-	-
TM-m30II	✓	✓	-	✓	-	-	-
TM-m30II-H	✓	✓	-	✓	-	-	-
TM-m30II-NT	✓	✓	-	✓	-	-	-
TM-m30II-S	✓	✓	-	✓	-	-	-
TM-m30II-SL	✓	✓	-	✓	-	-	-
TM-m30III	✓	✓	-	✓	-	-	-
TM-m30III-H	✓	✓	-	✓	-	-	-
TM-m50	✓	✓	-	✓	-	-	-
TM-T88VI	✓	✓	✓	✓	✓	-	✓
TM-T88VII	✓	✓	✓	✓	-	-	-
TM-L100	✓	✓	-	✓	-	-	-

Messages That Can Be Used

The following is a list of the messages that can be used with TM Printer.

	Message	Remarks
Message data for communication path	<connect>	
	<reconnect>	
	<disconnect>	

Message		Remarks	
Message data for device communication	<open_device>		
	<close_device>		
Device Messages	<device_data>	BarcodeScanner	
		Printer	For the usability and usage restrictions of XML for printer control, refer to List of Supported Elements .
		CustomerDisplay	For the usability and usage restrictions of XML for customer display control, refer to List of Supported Elements .
		Storage	TM-m30 firmware Ver. 1.46A ESC/POS or later TM-m30 firmware Ver. 1.46B ESC/POS or later
Message data for error notification	<error>		

Registration of Device

When using ePOS-Device XML with TM Printer, the ePOS-Device settings must be enabled. The ePOS-Device settings must be configured in EpsonNet Config (Web version). Since the device ID is fixed as the following, registration is not required.

Peripheral Devices	Device ID
Printer	local_printer
DM-D30, DM-D70, DM-D110	local_display
Barcode scanner	local_scanner
German fiscal element (TSE)	local_TSE

Limitations

- ❑ When using 2D barcode readers, Japanese and other multi-byte characters cannot be read correctly. However, when combining a TM Printer with a 2D barcode reader that supports UTF-8 to read a QR code, multi-byte characters encoded with UTF-8 can be obtained correctly.
- ❑ Set the barcode reader suffix (delimiter) to CR (carriage return code). Data cannot be obtained using any other settings.
- ❑ Control codes cannot be read from 2D barcode data if it contains ASCII control codes (0x00 through 0x1F).
- ❑ Only messages without BOM are supported.
- ❑ Only UTF-8 character encoding is supported.

List of Supported Elements

The following tables are list of supported elements by printers.

The following is an explanation of the symbol indicated in table:

- ✓: Supported
- ✓*: Supported but has a restriction on the attribute value.
- -: Not supported.

For information on the restrictions indicated with ✓*, refer to Printer-specific Support Information.

PrinterControl XML

Supported printers (1)

Element	TM-T20II-i	TM-T70-i	TM-T82II-i	TM-T83II-i	TM-T88V-i	TM-T88VI-iHUB	TM-U220-i	TM-T70II-DT	TM-T70II-DT2	TM-T88V-DT	TM-T88VI-DT2	TM-H6000IV-DT
<epos-print>	✓	✓	✓	✓	✓	✓	✓	✓	✓	✓	✓	✓
<response>	✓	✓	✓	✓	✓	✓	✓	✓	✓	✓	✓	✓
<text>	✓*	✓*	✓*	✓*	✓*	✓*	✓*	✓*	✓*	✓*	✓*	✓*
<feed>	✓*	✓*	✓*	✓*	✓*	✓*	✓*	✓*	✓*	✓*	✓*	✓*
<image>	✓*	✓*	✓*	✓*	✓*	✓*	✓*	✓*	✓*	✓*	✓*	✓*
<logo>	✓	✓	✓	✓	✓	✓	✓	✓	✓	✓	✓	✓
<barcode>	✓*	✓*	✓*	✓*	✓*	✓*	✓*	✓*	✓*	✓*	✓*	✓*
<symbol>	✓*	✓*	✓*	✓*	✓*	✓*	-	✓*	✓*	✓*	✓*	✓*
<hline>	-	-	-	-	-	-	-	-	-	-	-	-
<vline-begin>	-	-	-	-	-	-	-	-	-	-	-	-
<vline-end>	-	-	-	-	-	-	-	-	-	-	-	-
<page>	✓	✓	✓	✓	✓	✓	-	✓	✓	✓	✓	✓
<area>	✓	✓	✓	✓	✓	✓	-	✓	✓	✓	✓	✓
<direction>	✓	✓	✓	✓	✓	✓	-	✓	✓	✓	✓	✓
<position>	✓	✓	✓	✓	✓	✓	-	✓	✓	✓	✓	✓
<line>	-	-	-	-	-	✓*	-	-	-	-	-	-
<rectangle>	-	-	-	-	-	✓*	-	-	-	-	-	-
<cut>	✓*	✓*	✓*	✓*	✓*	✓*	✓*	✓*	✓*	✓*	✓*	✓*
<pulse>	✓	✓	✓	✓	✓	✓	✓	✓	✓	✓	✓	✓
<sound>	✓*	-	✓*	✓*	✓*	✓*	-	✓*	✓*	✓*	✓*	-
<command>	✓	✓	✓	✓	✓	✓	✓	✓	✓	✓	✓	✓

Element	TM-T20II-i	TM-T70-i	TM-T82II-i	TM-T83II-i	TM-T88V-i	TM-T88VI-iHUB	TM-U220-i	TM-T70II-DT	TM-T70II-DT2	TM-T88V-DT	TM-T88VI-DT2	TM-H6000IV-DT
<layout>	-	-	-	-	-	-	-	-	-	-	-	-
<recovery>	✓	✓	✓	✓	✓	✓	-	✓	✓	✓	✓	✓
<reset>	✓	✓	✓	✓	✓	✓	✓	✓	✓	✓	✓	✓
<batch-begin>	-	-	-	-	-	-	-	-	-	-	-	-
<batch-end>	-	-	-	-	-	-	-	-	-	-	-	-
<rotate-begin>	-	-	-	-	-	-	-	-	-	-	-	-
<rotate-end>	-	-	-	-	-	-	-	-	-	-	-	-

Supported printers (2)

Element	TM-H6000V	TM-m30	TM-m30II	TM-m30II-H	TM-m30II-NT	TM-m30II-S	TM-m30II-SL	TM-m30III	TM-m30III-H	TM-m50	TM-T88VI	TM-T88VII	TM-L100
<epos-print>	✓	✓	✓	✓	✓	✓	✓	✓	✓	✓	✓	✓	✓
<response>	✓	✓	✓	✓	✓	✓	✓	✓	✓	✓	✓	✓	✓
<text>	✓*	✓*	✓*	✓*	✓*	✓*	✓*	✓*	✓*	✓*	✓*	✓*	✓*
<feed>	✓*	✓*	✓*	✓*	✓*	✓*	✓*	✓*	✓*	✓*	✓*	✓*	✓*
<image>	✓*	✓*	✓*	✓*	✓*	✓*	✓*	✓*	✓*	✓*	✓*	✓*	✓*
<logo>	✓	✓	✓	✓	✓	✓	✓	✓	✓	✓	✓	✓	✓
<barcode>	✓*	✓*	✓*	✓*	✓*	✓*	✓*	✓*	✓*	✓*	✓*	✓*	✓*
<symbol>	✓*	✓*	✓*	✓*	✓*	✓*	✓*	✓*	✓*	✓*	✓*	✓*	✓*
<hline>	-	-	-	-	-	-	-	-	-	-	-	-	-
<vline-begin>	-	-	-	-	-	-	-	-	-	-	-	-	-
<vline-end>	-	-	-	-	-	-	-	-	-	-	-	-	-
<page>	✓	✓	✓	✓	✓	✓	✓	✓	✓	✓	✓	✓	✓
<area>	✓	✓	✓	✓	✓	✓	✓	✓	✓	✓	✓	✓	✓
<direction>	✓	✓	✓	✓	✓	✓	✓	✓	✓	✓	✓	✓	✓
<position>	✓	✓	✓	✓	✓	✓	✓	✓	✓	✓	✓	✓	✓
<line>	✓*	-	-	-	-	-	-	-	-	-	✓*	✓*	✓*
<rectangle>	✓*	-	-	-	-	-	-	-	-	-	✓*	✓*	✓*
<cut>	✓*	✓*	✓*	✓*	✓*	✓*	✓*	✓	✓	✓*	✓*	✓*	✓*
<pulse>	✓	✓	✓	✓	✓	✓	✓	✓	✓	✓	✓	✓	✓
<sound>	-	✓*	✓*	✓*	✓*	✓*	✓*	✓*	✓*	✓*	✓*	✓*	✓*

Element	TM-H6000V	TM-m30	TM-m30II	TM-m30II-H	TM-m30II-NT	TM-m30II-S	TM-m30II-SL	TM-m30III	TM-m30III-H	TM-m50	TM-T88VI	TM-T88VII	TM-L100
<command>	✓	✓	✓	✓	✓	✓	✓	✓	✓	✓	✓	✓	✓
<layout>	-	-	-	-	-	-	-	-	-	-	-	-	✓*
<recovery>	✓	✓	✓	✓	✓	✓	✓	✓	✓	✓	✓	✓	✓
<reset>	✓	✓	✓	✓	✓	✓	✓	✓	✓	✓	✓	✓	✓
<batch-begin>	-	-	✓	✓	✓	✓	✓	✓	✓	✓	-	✓	✓
<batch-end>	-	-	✓	✓	✓	✓	✓	✓	✓	✓	-	✓	✓
<rotate-begin>	-	-	✓	✓	✓	✓	✓	✓	✓	✓	-	✓	✓
<rotate-end>	-	-	✓	✓	✓	✓	✓	✓	✓	✓	-	✓	✓

Network Printer (1)

Element	TM-m10	TM-P20	TM-P60II (Receipt)	TM-P60II (Peeler)	TM-P80	TM-T20	TM-T20II	TM-T70	TM-T70II
<epos-print>	✓	✓	✓	✓	✓	✓	✓	✓	✓
<response>	✓	✓	✓	✓	✓	✓	✓	✓	✓
<text>	✓*	✓*	✓*	✓*	✓*	✓*	✓*	✓*	✓*
<feed>	✓*	✓*	✓*	✓	✓*	✓*	✓*	✓*	✓*
<image>	✓*	✓*	✓*	✓*	✓*	✓*	✓*	✓*	✓*
<logo>	✓	✓	✓	✓	✓	✓	✓	✓	✓
<barcode>	✓*	✓*	✓*	✓*	✓*	✓*	✓*	✓*	✓*
<symbol>	✓*	✓*	✓*	✓*	✓*	✓*	✓*	✓*	✓*
<hline>	-	-	-	-	-	-	-	-	-
<vline-begin>	-	-	-	-	-	-	-	-	-
<vline-end>	-	-	-	-	-	-	-	-	-
<page>	✓	✓	✓	✓	✓	✓	✓	✓	✓
<area>	✓	✓	✓	✓	✓	✓	✓	✓	✓
<direction>	✓	✓	✓	✓	✓	✓	✓	✓	✓
<position>	✓	✓	✓	✓	✓	✓	✓	✓	✓
<line>	-	✓*	✓*	✓*	✓*	-	-	-	-
<rectangle>	-	✓*	✓*	✓*	✓*	-	-	-	-
<cut>	✓*	✓*	✓*	✓*	✓*	✓*	✓*	✓*	✓*
<pulse>	✓	-	-	-	-	✓	✓	✓	✓

Element	TM-m10	TM-P20	TM-P60II (Receipt)	TM-P60II (Peeler)	TM-P80	TM-T20	TM-T20II	TM-T70	TM-T70II
<sound>	✓*	✓*	✓*	✓*	✓*	✓*	✓*	-	✓*
<command>	✓	✓	✓	✓	✓	✓	✓	✓	✓
<layout>	-	✓*	-	✓*	✓*	-	-	-	-
<recovery>	✓	✓	✓	✓	✓	✓	✓	✓	✓
<reset>	✓	✓	✓	✓	✓	✓	✓	✓	✓
<batch-begin>	-	-	-	-	-	-	-	-	-
<batch-end>	-	-	-	-	-	-	-	-	-
<rotate-begin>	-	-	-	-	-	-	-	-	-
<rotate-end>	-	-	-	-	-	-	-	-	-

Network Printer (2)

Element	TM-T82II	TM-T83II	TM-T88IV	TM-T88V	TM-T90	TM-L90	TM-U220	TM-H6000IV
<epos-print>	✓	✓	✓	✓	✓	✓	✓	✓
<response>	✓	✓	✓	✓	✓	✓	✓	✓
<text>	✓*	✓*	✓*	✓*	✓*	✓*	✓*	✓*
<feed>	✓*	✓*	✓*	✓*	✓*	✓	✓*	✓*
<image>	✓*	✓*	✓*	✓*	✓*	✓*	✓*	✓*
<logo>	✓	✓	✓	✓	✓	✓	-	✓
<barcode>	✓*	✓*	✓*	✓*	✓*	✓*	✓*	✓*
<symbol>	✓*	✓*	✓*	✓*	✓*	✓*	-	✓*
<hline>	-	-	-	-	-	-	-	-
<vline-begin>	-	-	-	-	-	-	-	-
<vline-end>	-	-	-	-	-	-	-	-
<page>	✓	✓	✓	✓	✓	✓	-	✓
<area>	✓	✓	✓	✓	✓	✓	-	✓
<direction>	✓	✓	✓	✓	✓	✓	-	✓
<position>	✓	✓	✓	✓	✓	✓	-	✓
<line>	-	-	-	-	-	-	-	-
<rectangle>	-	-	-	-	-	-	-	-
<cut>	✓*	✓*	✓*	✓*	✓*	✓*	✓*	✓*

Element	TM-T82II	TM-T83II	TM-T88IV	TM-T88V	TM-T90	TM-L90	TM-U220	TM-H6000IV
<pulse>	✓	✓	✓	✓	✓	✓	✓	✓
<sound>	✓*	✓*	-	✓*	-	-	-	-
<command>	✓	✓	✓	✓	✓	✓	✓	✓
<layout>	-	-	-	-	-	-	-	-
<recovery>	✓	✓	✓	✓	✓	✓	-	✓
<reset>	✓	✓	✓	✓	✓	✓	✓	✓
<batch-begin>	-	-	-	-	-	-	-	-
<batch-end>	-	-	-	-	-	-	-	-
<rotate-begin>	-	-	-	-	-	-	-	-
<rotate-end>	-	-	-	-	-	-	-	-

CustomerDisplayControl XML

Supported printers (1)

Element	TM-T20II-i	TM-T70-i	TM-T82II-i	TM-T83II-i	TM-T88V-i	TM-T88VI-iHUB	TM-U220-i	TM-T70II-DT	TM-T70II-DT2	TM-T88V-DT	TM-T88VI-DT2	TM-H6000IV-DT
<epos-display>	✓	✓	✓	✓	✓	✓	✓	✓	✓	✓	✓	✓
<response>	✓	✓	✓	✓	✓	✓	✓	✓	✓	✓	✓	✓
<window>	✓	✓	✓	✓	✓	✓	✓	✓	✓	✓	✓	✓
<screen>	-	-	-	-	-	-	-	-	✓	-	✓	-
<textarea>	-	-	-	-	-	-	-	-	✓	-	✓	-
<cursor>	✓	✓	✓	✓	✓	✓	✓	✓	✓	✓	✓	✓
<text>	✓*	✓*	✓*	✓*	✓*	✓*	✓*	✓*	✓*	✓*	✓*	✓*
<marquee>	✓	✓	✓	✓	✓	✓	✓	✓	✓	✓	✓	✓
<blink>	✓	✓	✓	✓	✓	✓	✓	✓	✓	✓	✓	✓
<brightness>	✓	✓	✓	✓	✓	✓	✓	✓	✓	✓	✓	✓
<backgroundcolor>	-	-	-	-	-	-	-	-	✓	-	✓	-
<slideshow>	-	-	-	-	-	-	-	-	✓	-	✓	-
<downloadimage>	-	-	-	-	-	-	-	-	✓	-	✓	-
<registerdownloadimage>	-	-	-	-	-	-	-	-	✓	-	✓	-
<nvimage>	-	-	-	-	-	-	-	-	✓	-	✓	-
<clearimage>	-	-	-	-	-	-	-	-	✓	-	✓	-
<symbol>	-	-	-	-	-	-	-	-	✓	-	✓	-
<clearsymbol>	-	-	-	-	-	-	-	-	✓	-	✓	-
<clock>	✓	✓	✓	✓	✓	✓	✓	✓	✓	✓	✓	✓
<clear>	✓	✓	✓	✓	✓	✓	✓	✓	✓	✓	✓	✓
<reset>	✓	✓	✓	✓	✓	✓	✓	✓	✓	✓	✓	✓
<command>	✓	✓	✓	✓	✓	✓	✓	✓	✓	✓	✓	✓

Supported printers (2)

Element	TM-H6000V	TM-m30	TM-m30II	TM-m30II-H	TM-m30II-NT	TM-m30II-S	TM-m30II-SL	TM-m30III	TM-m30III-H	TM-m50	TM-T88VI	TM-T88VII	TM-L100
<epos-display>	✓	✓	✓	✓	✓	✓	✓	✓	✓	✓	✓	✓	✓
<response>	✓	✓	✓	✓	✓	✓	✓	✓	✓	✓	✓	✓	✓

Element	TM-H6000V	TM-m30	TM-m30II	TM-m30II-H	TM-m30II-NT	TM-m30II-S	TM-m30II-SL	TM-m30III	TM-m30III-H	TM-m50	TM-T88VI	TM-T88VII	TM-L100
<window>	✓	✓	✓	✓	✓	✓	✓	✓	✓	✓	✓	✓	✓
<screen>	-	-	-	✓	✓	✓	✓	✓	✓	-	-	✓	✓
<textarea>	-	-	-	✓	✓	✓	✓	✓	✓	-	-	✓	✓
<cursor>	✓	✓	✓	✓	✓	✓	✓	✓	✓	✓	✓	✓	✓
<text>	✓*	✓*	✓*	✓	✓	✓	✓	✓	✓	✓*	✓*	✓	✓
<marquee>	✓	✓	✓	✓	✓	✓	✓	✓	✓	✓	✓	✓	✓
<blink>	✓	✓	✓	✓	✓	✓	✓	✓	✓	✓	✓	✓	✓
<brightness>	✓	✓	✓	✓	✓	✓	✓	✓	✓	✓	✓	✓	✓
<backgroundcolor>	-	-	-	✓	✓	✓	✓	✓	✓	-	-	✓	✓
<slideshow>	-	-	-	✓	✓	✓	✓	✓	✓	-	-	✓	✓
<downloadimage>	-	-	-	✓	✓	✓	✓	✓	✓	-	-	✓	✓
<registerdownloadimage>	-	-	-	✓	✓	✓	✓	✓	✓	-	-	✓	✓
<nvimage>	-	-	-	✓	✓	✓	✓	✓	✓	-	-	✓	✓
<clearimage>	-	-	-	✓	✓	✓	✓	✓	✓	-	-	✓	✓
<symbol>	-	-	-	✓	✓	✓	✓	✓	✓	-	-	✓	✓
<clearsymbol>	-	-	-	✓	✓	✓	✓	✓	✓	-	-	✓	✓
<clock>	-	-	-	-	-	-	-	-	-	-	✓	✓	-
<clear>	✓	✓	✓	✓	✓	✓	✓	✓	✓	✓	✓	✓	✓
<reset>	✓	✓	✓	✓	✓	✓	✓	✓	✓	✓	✓	✓	✓
<command>	✓	✓	✓	✓	✓	✓	✓	✓	✓	✓	✓	✓	✓

Network Printer (1)

Element	TM-m10	TM-P20	TM-P60II (Receipt)	TM-P60II (Peeler)	TM-P80	TM-T20	TM-T20II	TM-T70	TM-T70II
<epos-display>	-	-	-	-	-	-	-	-	-
<response>	-	-	-	-	-	-	-	-	-
<window>	-	-	-	-	-	-	-	-	-
<screen>	-	-	-	-	-	-	-	-	-
<textarea>	-	-	-	-	-	-	-	-	-
<cursor>	-	-	-	-	-	-	-	-	-
<text>	-	-	-	-	-	-	-	-	-

Element	TM-m10	TM-P20	TM-P60II (Receipt)	TM-P60II (Peeler)	TM-P80	TM-T20	TM-T20II	TM-T70	TM-T70II
<marquee>	-	-	-	-	-	-	-	-	-
<blink>	-	-	-	-	-	-	-	-	-
<brightness>	-	-	-	-	-	-	-	-	-
<backgroundcolor>	-	-	-	-	-	-	-	-	-
<slideshow>	-	-	-	-	-	-	-	-	-
<downloadimage>	-	-	-	-	-	-	-	-	-
<registerdownloadimage>	-	-	-	-	-	-	-	-	-
<nvimage>	-	-	-	-	-	-	-	-	-
<clearimage>	-	-	-	-	-	-	-	-	-
<symbol>	-	-	-	-	-	-	-	-	-
<clearsymbol>	-	-	-	-	-	-	-	-	-
<clock>	-	-	-	-	-	-	-	-	-
<clear>	-	-	-	-	-	-	-	-	-
<reset>	-	-	-	-	-	-	-	-	-
<command>	-	-	-	-	-	-	-	-	-

Network Printer (2)

Element	TM-T82II	TM-T83II	TM-T88IV	TM-T88V	TM-T90	TM-L90	TM-U220	TM-H6000IV
<epos-display>	-	-	-	-	-	-	-	-
<response>	-	-	-	-	-	-	-	-
<window>	-	-	-	-	-	-	-	-
<screen>	-	-	-	-	-	-	-	-
<textarea>	-	-	-	-	-	-	-	-
<cursor>	-	-	-	-	-	-	-	-
<text>	-	-	-	-	-	-	-	-
<marquee>	-	-	-	-	-	-	-	-
<blink>	-	-	-	-	-	-	-	-
<brightness>	-	-	-	-	-	-	-	-
<backgroundcolor>	-	-	-	-	-	-	-	-
<slideshow>	-	-	-	-	-	-	-	-

Element	TM-T82II	TM-T83II	TM-T88IV	TM-T88V	TM-T90	TM-L90	TM-U220	TM-H6000IV
<downloadimage>	-	-	-	-	-	-	-	-
<registerdownloadimage>	-	-	-	-	-	-	-	-
<nvimage>	-	-	-	-	-	-	-	-
<clearimage>	-	-	-	-	-	-	-	-
<symbol>	-	-	-	-	-	-	-	-
<clearsymbol>	-	-	-	-	-	-	-	-
<clock>	-	-	-	-	-	-	-	-
<clear>	-	-	-	-	-	-	-	-
<reset>	-	-	-	-	-	-	-	-
<command>	-	-	-	-	-	-	-	-

Printer-specific Support Information

TM-T20II-i

Printer Specifications

Item	58mm Specification	80mm Specification
Amount of initial feed	30 dots	
Initial page mode area	420 x 831 dots	576 x 831 dots
Maximum page mode area	420 x 1662 dots	576 x 1662 dots
Baseline of Font A	21 dots from the top of the character	
Baseline of Font B	16 dots from the top of the character	

Elements for which restricted parameter setting values can be specified

PrinterControl XML

- <text>

Attribute	Specificable Setting Value
lang	<ul style="list-style-type: none"> • "en" • "de" • "fr" • "it" • "es"
font	<ul style="list-style-type: none"> • "font_a" • "font_b"
smooth	<ul style="list-style-type: none"> • "true" / "1" • "false" / "0"
dw	<ul style="list-style-type: none"> • "true" / "1" • "false" / "0"
dh	<ul style="list-style-type: none"> • "true" / "1" • "false" / "0"
width	<ul style="list-style-type: none"> • "1" to "8"
height	<ul style="list-style-type: none"> • "1" to "8"
reverse	<ul style="list-style-type: none"> • "true" / "1" • "false" / "0"
ul	<ul style="list-style-type: none"> • "true" / "1" • "false" / "0"

Attribute	Specificable Setting Value
em	<ul style="list-style-type: none"> • "true" / "1" • "false" / "0"
color	<ul style="list-style-type: none"> • "color_1"
x	<ul style="list-style-type: none"> • "0" to "65535"
y	<ul style="list-style-type: none"> • "0" to "65535"
align	<ul style="list-style-type: none"> • "left" • "center" • "right"
rotate	<ul style="list-style-type: none"> • "true" / "1" • "false" / "0"
linespc	<ul style="list-style-type: none"> • "0" to "255"

- <feed>

Attribute	Specificable Setting Value
unit	<ul style="list-style-type: none"> • "0" to "255"
line	<ul style="list-style-type: none"> • "0" to "255"
linespc	<ul style="list-style-type: none"> • "0" to "255"

- <image>

Attribute	Specificable Setting Value
width	<ul style="list-style-type: none"> • "0" to "65535"
height	<ul style="list-style-type: none"> • "0" to "65535"
color	<ul style="list-style-type: none"> • "color_1"
align	<ul style="list-style-type: none"> • "left" • "center" • "right"
mode	<ul style="list-style-type: none"> • "mono"

- <barcode>

Attribute	Specificable Setting Value
type	<ul style="list-style-type: none"> • "upc_a" • "upc_e" • "ean13" • "jan13" • "ean8" • "jan8" • "code39" • "itf" • "codabar" • "code93" • "code128" • "gs1_128" • "gs1_databar_omnidirectional" • "gs1_databar_truncated" • "gs1_databar_limited" • "gs1_databar_expanded"
hri	<ul style="list-style-type: none"> • "none" • "above" • "below" • "both"
font	<ul style="list-style-type: none"> • "font_a" • "font_b"
width	<ul style="list-style-type: none"> • "2" to "6"
height	<ul style="list-style-type: none"> • "1" to "255"
align	<ul style="list-style-type: none"> • "left" • "center" • "right"
rotate	<ul style="list-style-type: none"> • "true" / "1" • "false" / "0"

• <symbol>

Attribute	Specificable Setting Value
type	<ul style="list-style-type: none"> • "pdf417_standard" • "pdf417_truncated" • "qrcode_model_1" • "qrcode_model_2" • "maxicode_mode_2" • "maxicode_mode_3" • "maxicode_mode_4" • "maxicode_mode_5" • "maxicode_mode_6" • "gs1_databar_stacked" • "gs1_databar_stacked_omnidirectional" • "gs1_databar_expanded_stacked"
level	<ul style="list-style-type: none"> • "level_0" • "level_1" (default value) • "level_2" • "level_3" • "level_4" • "level_5" • "level_6" • "level_7" • "level_8" • "level_l" • "level_m" • "level_q" • "level_h" • "default"
width	-
height	-
size	-
align	<ul style="list-style-type: none"> • "left" • "center" • "right"
rotate	<ul style="list-style-type: none"> • "true" / "1" • "false" / "0"

• <cut>

Attribute	Specificable Setting Value
type	<ul style="list-style-type: none"> • "no_feed" • "feed"

- <sound>

Attribute	Specificable Setting Value
pattern	<ul style="list-style-type: none"> • "none" • "pattern_a" • "pattern_b" • "pattern_c" • "pattern_d" • "pattern_e" • "error" • "paper_end"
repeat	<ul style="list-style-type: none"> • "0" • "1" to "255"

CustomerDisplayControl XML

- <text>

Attribute	Specificable Setting Value
x	<ul style="list-style-type: none"> • "1" to "44"
y	<ul style="list-style-type: none"> • "1" to "19"
reverse	<ul style="list-style-type: none"> • "true" / "1" • "false" / "0"
lang	<ul style="list-style-type: none"> • "en" • "ja"

TM-T70-i

Printer Specifications

Item		58mm Specification	80mm Specification
Amount of initial feed		30 dots	
Initial page mode area	ANK model	416 x 1662 dots	512 x 831 dots
	Multiple languages model	416 x 1662 dots	576 x 1662 dots
Maximum page mode area	ANK model	416 x 1662 dots	512 x 1662 dots
	Multiple languages model	416 x 1662 dots	576 x 1662 dots
Baseline of Font A		21 dots from the top of the character	
Baseline of Font B		16 dots from the top of the character	

Elements for which restricted parameter setting values can be specified

PrinterControl XML

- <text>

Attribute	Specificable Setting Value
lang	<ul style="list-style-type: none"> • "en" • "de" • "fr" • "it" • "es" • "ko" • "ko-kr" • "zh-hans" • "zh-cn" • "zh-hant" • "zh-tw"
font	<ul style="list-style-type: none"> • "font_a" • "font_b"
smooth	<ul style="list-style-type: none"> • "true" / "1" • "false" / "0"
dw	<ul style="list-style-type: none"> • "true" / "1" • "false" / "0"
dh	<ul style="list-style-type: none"> • "true" / "1" • "false" / "0"
width	<ul style="list-style-type: none"> • "1" to "8"

Attribute	Specificable Setting Value
height	<ul style="list-style-type: none"> • "1" to "8"
reverse	<ul style="list-style-type: none"> • "true" / "1" • "false" / "0"
ul	<ul style="list-style-type: none"> • "true" / "1" • "false" / "0"
em	<ul style="list-style-type: none"> • "true" / "1" • "false" / "0"
color	<ul style="list-style-type: none"> • "color_1"
x	<ul style="list-style-type: none"> • "0" to "65535"
y	<ul style="list-style-type: none"> • "0" to "65535"
align	<ul style="list-style-type: none"> • "left" • "center" • "right"
rotate	<ul style="list-style-type: none"> • "true" / "1" • "false" / "0"
linespc	<ul style="list-style-type: none"> • "0" to "255"

- <feed>

Attribute	Specificable Setting Value
unit	<ul style="list-style-type: none"> • "0" to "255"
line	<ul style="list-style-type: none"> • "0" to "255"
linespc	<ul style="list-style-type: none"> • "0" to "255"

- <image>

Attribute	Specificable Setting Value
width	<ul style="list-style-type: none"> • "0" to "65535"
height	<ul style="list-style-type: none"> • "0" to "65535"
color	<ul style="list-style-type: none"> • "color_1"
align	<ul style="list-style-type: none"> • "left" • "center" • "right"
mode	<ul style="list-style-type: none"> • "mono"

- <barcode>

Attribute	Specificable Setting Value
type	<ul style="list-style-type: none"> • "upc_a" • "upc_e" • "ean13" • "jan13" • "ean8" • "jan8" • "code39" • "itf" • "codabar" • "code93" • "code128"
hri	<ul style="list-style-type: none"> • "none" • "above" • "below" • "both"
font	<ul style="list-style-type: none"> • "font_a" • "font_b"
width	<ul style="list-style-type: none"> • "2" to "6"
height	<ul style="list-style-type: none"> • "1" to "255"
align	<ul style="list-style-type: none"> • "left" • "center" • "right"
rotate	<ul style="list-style-type: none"> • "true" / "1" • "false" / "0"

- <symbol>

Attribute	Specificable Setting Value
type	<ul style="list-style-type: none"> • "pdf417_standard" • "pdf417_truncated" • "qrcode_model_1" • "qrcode_model_2"

Attribute	Specificable Setting Value
level	<ul style="list-style-type: none"> • "level_0" • "level_1" (default value) • "level_2" • "level_3" • "level_4" • "level_5" • "level_6" • "level_7" • "level_8" • "level_l" • "level_m" • "level_q" • "level_h" • "default"
width	-
height	-
size	-
align	<ul style="list-style-type: none"> • "left" • "center" • "right"
rotate	<ul style="list-style-type: none"> • "true" / "1" • "false" / "0"

- <cut>

Attribute	Specificable Setting Value
type	<ul style="list-style-type: none"> • "no_feed" • "feed"

CustomerDisplayControl XML

- <text>

Attribute	Specificable Setting Value
x	<ul style="list-style-type: none"> • "1" to "44"
y	<ul style="list-style-type: none"> • "1" to "19"
reverse	<ul style="list-style-type: none"> • "true" / "1" • "false" / "0"
lang	<ul style="list-style-type: none"> • "en" • "ja"

TM-T82II-i

Printer Specifications

Item	Specification
Amount of initial feed	30 dots
Initial page mode area	576 x 831 dots
Maximum page mode area	576 x 1662 dots
Baseline of Font A	21 dots from the top of the character
Baseline of Font B	16 dots from the top of the character

Elements for which restricted parameter setting values can be specified

PrinterControl XML

- <text>

Attribute	Specificable Setting Value
lang	<ul style="list-style-type: none"> • "en" • "de" • "fr" • "it" • "es" • "zh-hans" • "zh-cn" • "zh-hant" • "zh-tw" • "th"
font	<ul style="list-style-type: none"> • "font_a" • "font_b" • "special_a" • "special_b"
smooth	<ul style="list-style-type: none"> • "true" / "1" • "false" / "0"
dw	<ul style="list-style-type: none"> • "true" / "1" • "false" / "0"
dh	<ul style="list-style-type: none"> • "true" / "1" • "false" / "0"
width	<ul style="list-style-type: none"> • "1" to "8"
height	<ul style="list-style-type: none"> • "1" to "8"

Attribute	Specificable Setting Value
reverse	<ul style="list-style-type: none"> • "true" / "1" • "false" / "0"
ul	<ul style="list-style-type: none"> • "true" / "1" • "false" / "0"
em	<ul style="list-style-type: none"> • "true" / "1" • "false" / "0"
color	<ul style="list-style-type: none"> • "color_1"
x	<ul style="list-style-type: none"> • "0" to "65535"
y	<ul style="list-style-type: none"> • "0" to "65535"
align	<ul style="list-style-type: none"> • "left" • "center" • "right"
rotate	<ul style="list-style-type: none"> • "true" / "1" • "false" / "0"
linespc	<ul style="list-style-type: none"> • "0" to "255"

- <feed>

Attribute	Specificable Setting Value
unit	<ul style="list-style-type: none"> • "0" to "255"
line	<ul style="list-style-type: none"> • "0" to "255"
linespc	<ul style="list-style-type: none"> • "0" to "255"

- <image>

Attribute	Specificable Setting Value
width	<ul style="list-style-type: none"> • "0" to "65535"
height	<ul style="list-style-type: none"> • "0" to "65535"
color	<ul style="list-style-type: none"> • "color_1"
align	<ul style="list-style-type: none"> • "left" • "center" • "right"
mode	<ul style="list-style-type: none"> • "mono"

- <barcode>

Attribute	Specificable Setting Value
type	<ul style="list-style-type: none"> • "upc_a" • "upc_e" • "ean13" • "jan13" • "ean8" • "jan8" • "code39" • "itf" • "codabar" • "code93" • "code128" • "gs1_128" • "gs1_databar_omnidirectional" • "gs1_databar_truncated" • "gs1_databar_limited" • "gs1_databar_expanded"
hri	<ul style="list-style-type: none"> • "none" • "above" • "below" • "both"
font	<ul style="list-style-type: none"> • "font_a" • "font_b"
width	<ul style="list-style-type: none"> • "2" to "6"
height	<ul style="list-style-type: none"> • "1" to "255"
align	<ul style="list-style-type: none"> • "left" • "center" • "right"
rotate	<ul style="list-style-type: none"> • "true" / "1" • "false" / "0"

- <symbol>

Attribute	Specificable Setting Value
type	<ul style="list-style-type: none"> • "pdf417_standard" • "pdf417_truncated" • "qrcode_model_1" • "qrcode_model_2" • "maxicode_mode_2" • "maxicode_mode_3" • "maxicode_mode_4" • "maxicode_mode_5" • "maxicode_mode_6" • "gs1_databar_stacked" • "gs1_databar_stacked_omnidirectional" • "gs1_databar_expanded_stacked"
level	<ul style="list-style-type: none"> • "level_0" • "level_1" (default value) • "level_2" • "level_3" • "level_4" • "level_5" • "level_6" • "level_7" • "level_8" • "level_l" • "level_m" • "level_q" • "level_h" • "default"
width	-
height	-
size	-
align	<ul style="list-style-type: none"> • "left" • "center" • "right"
rotate	<ul style="list-style-type: none"> • "true" / "1" • "false" / "0"

- <cut>

Attribute	Specificable Setting Value
type	<ul style="list-style-type: none"> • "no_feed" • "feed"

- <sound>

Attribute	Specificable Setting Value
pattern	<ul style="list-style-type: none"> • "none" • "pattern_a" • "pattern_b" • "pattern_c" • "pattern_d" • "pattern_e" • "error" • "paper_end"
repeat	<ul style="list-style-type: none"> • "0" • "1" to "255"

CustomerDisplayControl XML

- <text>

Attribute	Specificable Setting Value
x	<ul style="list-style-type: none"> • "1" to "44"
y	<ul style="list-style-type: none"> • "1" to "19"
reverse	<ul style="list-style-type: none"> • "true" / "1" • "false" / "0"
lang	<ul style="list-style-type: none"> • "en" • "ja"

TM-T83II-i

Printer Specifications

Item		Specification
Amount of initial feed		30 dots
Initial page mode area		512 x 1662 dots
Maximum page mode area		512 x 1662 dots
Baseline of Font A		21 dots from the top of the character
Baseline of Font B	ANK	16 dots from the top of the character
	Chinese characters	15 dots from the top of the character

Elements for which restricted parameter setting values can be specified

PrinterControl XML

- <text>

Attribute	Specificable Setting Value
lang	<ul style="list-style-type: none"> • "en" • "de" • "fr" • "it" • "es" • "ko" • "ko-kr"
font	<ul style="list-style-type: none"> • "font_a" • "font_b"
smooth	<ul style="list-style-type: none"> • "true" / "1" • "false" / "0"
dw	<ul style="list-style-type: none"> • "true" / "1" • "false" / "0"
dh	<ul style="list-style-type: none"> • "true" / "1" • "false" / "0"
width	• "1" to "8"
height	• "1" to "8"
reverse	<ul style="list-style-type: none"> • "true" / "1" • "false" / "0"
ul	<ul style="list-style-type: none"> • "true" / "1" • "false" / "0"

Attribute	Specificable Setting Value
em	<ul style="list-style-type: none"> • "true" / "1" • "false" / "0"
color	<ul style="list-style-type: none"> • "color_1"
x	<ul style="list-style-type: none"> • "0" to "65535"
y	<ul style="list-style-type: none"> • "0" to "65535"
align	<ul style="list-style-type: none"> • "left" • "center" • "right"
rotate	<ul style="list-style-type: none"> • "true" / "1" • "false" / "0"
linespc	<ul style="list-style-type: none"> • "0" to "255"

- <feed>

Attribute	Specificable Setting Value
unit	<ul style="list-style-type: none"> • "0" to "255"
line	<ul style="list-style-type: none"> • "0" to "255"
linespc	<ul style="list-style-type: none"> • "0" to "255"

- <image>

Attribute	Specificable Setting Value
width	<ul style="list-style-type: none"> • "0" to "65535"
height	<ul style="list-style-type: none"> • "0" to "65535"
color	<ul style="list-style-type: none"> • "color_1"
align	<ul style="list-style-type: none"> • "left" • "center" • "right"
mode	<ul style="list-style-type: none"> • "mono"

- <barcode>

Attribute	Specificable Setting Value
type	<ul style="list-style-type: none"> • "upc_a" • "upc_e" • "ean13" • "jan13" • "ean8" • "jan8" • "code39" • "itf" • "codabar" • "code93" • "code128" • "gs1_128" • "gs1_databar_omnidirectional" • "gs1_databar_truncated" • "gs1_databar_limited" • "gs1_databar_expanded"
hri	<ul style="list-style-type: none"> • "none" • "above" • "below" • "both"
font	<ul style="list-style-type: none"> • "font_a" • "font_b"
width	<ul style="list-style-type: none"> • "2" to "6"
height	<ul style="list-style-type: none"> • "1" to "255"
align	<ul style="list-style-type: none"> • "left" • "center" • "right"
rotate	<ul style="list-style-type: none"> • "true" / "1" • "false" / "0"

- <symbol>

Attribute	Specificable Setting Value
type	<ul style="list-style-type: none"> • "pdf417_standard" • "pdf417_truncated" • "qrcode_model_1" • "qrcode_model_2" • "maxicode_mode_2" • "maxicode_mode_3" • "maxicode_mode_4" • "maxicode_mode_5" • "maxicode_mode_6" • "gs1_databar_stacked" • "gs1_databar_stacked_omnidirectional" • "gs1_databar_expanded_stacked"
level	<ul style="list-style-type: none"> • "level_0" • "level_1" (default value) • "level_2" • "level_3" • "level_4" • "level_5" • "level_6" • "level_7" • "level_8" • "level_l" • "level_m" • "level_q" • "level_h" • "default"
width	-
height	-
size	-
align	<ul style="list-style-type: none"> • "left" • "center" • "right"
rotate	<ul style="list-style-type: none"> • "true" / "1" • "false" / "0"

- <cut>

Attribute	Specificable Setting Value
type	<ul style="list-style-type: none"> • "no_feed" • "feed"

- <sound>

Attribute	Specificable Setting Value
pattern	<ul style="list-style-type: none"> • "none" • "pattern_a" • "pattern_b" • "pattern_c" • "pattern_d" • "pattern_e" • "error" • "paper_end"
repeat	<ul style="list-style-type: none"> • "0" • "1" to "255"

CustomerDisplayControl XML

- <text>

Attribute	Specificable Setting Value
x	<ul style="list-style-type: none"> • "1" to "44"
y	<ul style="list-style-type: none"> • "1" to "19"
reverse	<ul style="list-style-type: none"> • "true" / "1" • "false" / "0"
lang	<ul style="list-style-type: none"> • "en" • "ja"

TM-T88V-i

Printer Specifications

Item		58mm Specification	80mm Specification
Amount of initial feed		30 dots	
Initial page mode area		360 x 831 dots	512 x 831 dots
Maximum page mode area		360 x 1662 dots	512 x 1662 dots
Baseline of Font A		21 dots from the top of the character	
Baseline of Font B	ANK	16 dots from the top of the character	
	Chinese characters	15 dots from the top of the character	

Elements for which restricted parameter setting values can be specified

PrinterControl XML

- <text>

Attribute	Specificable Setting Value
lang	<ul style="list-style-type: none"> • "en" • "de" • "fr" • "it" • "es" • "ko" • "ko-kr" • "zh-hans" • "zh-cn" • "zh-hant" • "zh-tw"
font	<ul style="list-style-type: none"> • "font_a" • "font_b" • "special_a" • "special_b"
smooth	<ul style="list-style-type: none"> • "true" / "1" • "false" / "0"
dw	<ul style="list-style-type: none"> • "true" / "1" • "false" / "0"
dh	<ul style="list-style-type: none"> • "true" / "1" • "false" / "0"
width	<ul style="list-style-type: none"> • "1" to "8"

Attribute	Specificable Setting Value
height	<ul style="list-style-type: none"> • "1" to "8"
reverse	<ul style="list-style-type: none"> • "true" / "1" • "false" / "0"
ul	<ul style="list-style-type: none"> • "true" / "1" • "false" / "0"
em	<ul style="list-style-type: none"> • "true" / "1" • "false" / "0"
color	<ul style="list-style-type: none"> • "color_1"
x	<ul style="list-style-type: none"> • "0" to "65535"
y	<ul style="list-style-type: none"> • "0" to "65535"
align	<ul style="list-style-type: none"> • "left" • "center" • "right"
rotate	<ul style="list-style-type: none"> • "true" / "1" • "false" / "0"
linespc	<ul style="list-style-type: none"> • "0" to "255"

- <feed>

Attribute	Specificable Setting Value
unit	<ul style="list-style-type: none"> • "0" to "255"
line	<ul style="list-style-type: none"> • "0" to "255"
linespc	<ul style="list-style-type: none"> • "0" to "255"

- <image>

Attribute	Specificable Setting Value
width	<ul style="list-style-type: none"> • "0" to "65535"
height	<ul style="list-style-type: none"> • "0" to "65535"
color	<ul style="list-style-type: none"> • "color_1"
align	<ul style="list-style-type: none"> • "left" • "center" • "right"
mode	<ul style="list-style-type: none"> • "mono" • "gray16"

- <barcode>

Attribute	Specificable Setting Value
type	<ul style="list-style-type: none"> • "upc_a" • "upc_e" • "ean13" • "jan13" • "ean8" • "jan8" • "code39" • "itf" • "codabar" • "code93" • "code128" • "gs1_128" • "gs1_databar_omnidirectional" • "gs1_databar_truncated" • "gs1_databar_limited" • "gs1_databar_expanded"
hri	<ul style="list-style-type: none"> • "none" • "above" • "below" • "both"
font	<ul style="list-style-type: none"> • "font_a" • "font_b"
width	<ul style="list-style-type: none"> • "2" to "6"
height	<ul style="list-style-type: none"> • "1" to "255"
align	<ul style="list-style-type: none"> • "left" • "center" • "right"
rotate	<ul style="list-style-type: none"> • "true" / "1" • "false" / "0"

- <symbol>

Attribute	Specificable Setting Value
type	<ul style="list-style-type: none"> • "pdf417_standard" • "pdf417_truncated" • "qrcode_model_1" • "qrcode_model_2" • "maxicode_mode_2" • "maxicode_mode_3" • "maxicode_mode_4" • "maxicode_mode_5" • "maxicode_mode_6" • "gs1_databar_stacked" • "gs1_databar_stacked_omnidirectional" • "gs1_databar_expanded_stacked"
level	<ul style="list-style-type: none"> • "level_0" • "level_1" (default value) • "level_2" • "level_3" • "level_4" • "level_5" • "level_6" • "level_7" • "level_8" • "level_l" • "level_m" • "level_q" • "level_h" • "default"
width	-
height	-
size	-
align	<ul style="list-style-type: none"> • "left" • "center" • "right"
rotate	<ul style="list-style-type: none"> • "true" / "1" • "false" / "0"

- <cut>

Attribute	Specificable Setting Value
type	<ul style="list-style-type: none"> • "no_feed" • "feed"

- <sound>

Attribute	Specificable Setting Value
pattern	<ul style="list-style-type: none"> • "none" • "pattern_a" • "pattern_b" • "pattern_c" • "pattern_d" • "pattern_e" • "error" • "paper_end"
repeat	<ul style="list-style-type: none"> • "0" • "1" to "255"

CustomerDisplayControl XML

- <text>

Attribute	Specificable Setting Value
x	<ul style="list-style-type: none"> • "1" to "44"
y	<ul style="list-style-type: none"> • "1" to "19"
reverse	<ul style="list-style-type: none"> • "true" / "1" • "false" / "0"
lang	<ul style="list-style-type: none"> • "en" • "ja"

TM-T88VI-iHUB

Printer Specifications

Item		58mm Specification	80mm Specification
Amount of initial feed		30 dots	
Initial page mode area		360 x 831 dots	512 x 831 dots
Maximum page mode area		360 x 1662 dots	512 x 1662 dots
Baseline of Font A		21 dots from the top of the character	
Baseline of Font B	ANK	16 dots from the top of the character	
	Chinese characters	15 dots from the top of the character	

Elements for which restricted parameter setting values can be specified

PrinterControl XML

- <text>

Attribute	Specificable Setting Value
lang	<ul style="list-style-type: none"> • "en" • "de" • "fr" • "it" • "es" • "ko" • "ko-kr" • "zh-hans" • "zh-cn" • "zh-hant" • "zh-tw" • "th"
font	<ul style="list-style-type: none"> • "font_a" • "font_b" • "special_a" • "special_b"
smooth	<ul style="list-style-type: none"> • "true" / "1" • "false" / "0"
dw	<ul style="list-style-type: none"> • "true" / "1" • "false" / "0"
dh	<ul style="list-style-type: none"> • "true" / "1" • "false" / "0"
width	<ul style="list-style-type: none"> • "1" to "8"

Attribute	Specificable Setting Value
height	<ul style="list-style-type: none"> • "1" to "8"
reverse	<ul style="list-style-type: none"> • "true" / "1" • "false" / "0"
ul	<ul style="list-style-type: none"> • "true" / "1" • "false" / "0"
em	<ul style="list-style-type: none"> • "true" / "1" • "false" / "0"
color	<ul style="list-style-type: none"> • "color_1"
x	<ul style="list-style-type: none"> • "0" to "65535"
y	<ul style="list-style-type: none"> • "0" to "65535"
align	<ul style="list-style-type: none"> • "left" • "center" • "right"
rotate	<ul style="list-style-type: none"> • "true" / "1" • "false" / "0"
linespc	<ul style="list-style-type: none"> • "0" to "255"

- <feed>

Attribute	Specificable Setting Value
unit	<ul style="list-style-type: none"> • "0" to "255"
line	<ul style="list-style-type: none"> • "0" to "255"
linespc	<ul style="list-style-type: none"> • "0" to "255"

- <image>

Attribute	Specificable Setting Value
width	<ul style="list-style-type: none"> • "0" to "65535"
height	<ul style="list-style-type: none"> • "0" to "65535"
color	<ul style="list-style-type: none"> • "color_1"
align	<ul style="list-style-type: none"> • "left" • "center" • "right"
mode	<ul style="list-style-type: none"> • "mono"

- <barcode>

Attribute	Specificable Setting Value
type	<ul style="list-style-type: none"> • "upc_a" • "upc_e" • "ean13" • "jan13" • "ean8" • "jan8" • "code39" • "itf" • "codabar" • "code93" • "code128" • "gs1_128" • "gs1_databar_omnidirectional" • "gs1_databar_truncated" • "gs1_databar_limited" • "gs1_databar_expanded"
hri	<ul style="list-style-type: none"> • "none" • "above" • "below" • "both"
font	<ul style="list-style-type: none"> • "font_a" • "font_b"
width	<ul style="list-style-type: none"> • "2" to "6"
height	<ul style="list-style-type: none"> • "1" to "255"
align	<ul style="list-style-type: none"> • "left" • "center" • "right"
rotate	<ul style="list-style-type: none"> • "true" / "1" • "false" / "0"

- <symbol>

Attribute	Specificable Setting Value
type	<ul style="list-style-type: none"> • "pdf417_standard" • "pdf417_truncated" • "qrcode_model_1" • "qrcode_model_2" • "maxicode_mode_2" • "maxicode_mode_3" • "maxicode_mode_4" • "maxicode_mode_5" • "maxicode_mode_6" • "gs1_databar_stacked" • "gs1_databar_stacked_omnidirectional" • "gs1_databar_expanded_stacked"
level	<ul style="list-style-type: none"> • "level_0" • "level_1" (default value) • "level_2" • "level_3" • "level_4" • "level_5" • "level_6" • "level_7" • "level_8" • "level_l" • "level_m" • "level_q" • "level_h" • "default"
width	-
height	-
size	-
align	<ul style="list-style-type: none"> • "left" • "center" • "right"
rotate	<ul style="list-style-type: none"> • "true" / "1" • "false" / "0"

- <line>

Attribute	Specificable Setting Value
x1	<ul style="list-style-type: none"> • "0" to "65535"
y1	<ul style="list-style-type: none"> • "0" to "65535"

Attribute	Specificable Setting Value
x2	<ul style="list-style-type: none"> • "0" to "65535"
y2	<ul style="list-style-type: none"> • "0" to "65535"
style	<ul style="list-style-type: none"> • "thin" • "medium" • "thick"

- <rectangle>

Attribute	Specificable Setting Value
x1	<ul style="list-style-type: none"> • "0" to "65535"
y1	<ul style="list-style-type: none"> • "0" to "65535"
x2	<ul style="list-style-type: none"> • "0" to "65535"
y2	<ul style="list-style-type: none"> • "0" to "65535"
style	<ul style="list-style-type: none"> • "thin" • "medium" • "thick"

- <cut>

Attribute	Specificable Setting Value
type	<ul style="list-style-type: none"> • "no_feed" • "feed"

- <sound>

Attribute	Specificable Setting Value
pattern	<ul style="list-style-type: none"> • "none" • "pattern_a" • "pattern_b" • "pattern_c" • "pattern_d" • "pattern_e" • "error" • "paper_end"
repeat	<ul style="list-style-type: none"> • "1" to "255"

CustomerDisplayControl XML

- <text>

Attribute	Specificable Setting Value
x	<ul style="list-style-type: none"> • "1" to "44"
y	<ul style="list-style-type: none"> • "1" to "19"

Attribute	Specifiable Setting Value
reverse	<ul style="list-style-type: none">• "true" / "1"• "false" / "0"
lang	<ul style="list-style-type: none">• "en"• "ja"

TM-U220-i

Printer Specifications

Item	76mm Specification	69.5mm Specification	57.5mm Specification
Amount of initial feed	12 dots		

Elements for which restricted parameter setting values can be specified

PrinterControl XML

- <text>

Attribute	Specifiable Setting Value
lang	<ul style="list-style-type: none"> • "en" • "de" • "fr" • "it" • "es" • "ko" • "ko-kr" • "zh-hans" • "zh-cn" • "zh-hant" • "zh-tw"
font	<ul style="list-style-type: none"> • "font_a" • "font_b"
smooth	<ul style="list-style-type: none"> • "true" / "1" • "false" / "0"
dw	<ul style="list-style-type: none"> • "true" / "1" • "false" / "0"
dh	<ul style="list-style-type: none"> • "true" / "1" • "false" / "0"
width	<ul style="list-style-type: none"> • "1" to "8"
height	<ul style="list-style-type: none"> • "1" to "8"
ul	<ul style="list-style-type: none"> • "true" / "1" • "false" / "0"
em	<ul style="list-style-type: none"> • "true" / "1" • "false" / "0"
color	<ul style="list-style-type: none"> • "color_1" • "color_2"

Attribute	Specificable Setting Value
align	<ul style="list-style-type: none"> • "left" • "center" • "right"
rotate	<ul style="list-style-type: none"> • "true" / "1" • "false" / "0"
linespc	<ul style="list-style-type: none"> • "0" to "255"

- <feed>

Attribute	Specificable Setting Value
unit	<ul style="list-style-type: none"> • "0" to "255"
line	<ul style="list-style-type: none"> • "0" to "255"
linespc	<ul style="list-style-type: none"> • "0" to "255"

- <image>

Attribute	Specificable Setting Value
width	<ul style="list-style-type: none"> • "0" to "65535"
height	<ul style="list-style-type: none"> • "0" to "65535"
color	<ul style="list-style-type: none"> • "color_1" • "color_2"
align	<ul style="list-style-type: none"> • "left" • "center" • "right"
mode	<ul style="list-style-type: none"> • "mono"

- <barcode>

Attribute	Specificable Setting Value
type	<ul style="list-style-type: none"> • "upc_a" • "upc_e" • "ean13" • "jan13" • "ean8" • "jan8" • "code39" • "itf" • "codabar" • "code93" • "code128"

- <cut>

Attribute	Specificable Setting Value
type	<ul style="list-style-type: none"> • "no_feed" • "feed"

CustomerDisplayControl XML

- <text>

Attribute	Specificable Setting Value
x	<ul style="list-style-type: none"> • "1" to "44"
y	<ul style="list-style-type: none"> • "1" to "19"
reverse	<ul style="list-style-type: none"> • "true" / "1" • "false" / "0"
lang	<ul style="list-style-type: none"> • "en" • "ja"

TM-T70II-DT

Printer Specifications

Item		58mm Specification	80mm Specification
Amount of initial feed		30 dots	
Initial page mode area	ANK model	416 x 1662 dots	512 x 1662 dots
	Multiple languages model	416 x 1662 dots	576 x 1662 dots
Maximum page mode area	ANK model	416 x 1662 dots	512 x 1662 dots
	Multiple languages model	416 x 1662 dots	576 x 1662 dots
Baseline of Font A		21 dots from the top of the character	
Baseline of Font B		16 dots from the top of the character	

Elements for which restricted parameter setting values can be specified

PrinterControl XML

- <text>

Attribute	Specificable Setting Value
lang	<ul style="list-style-type: none"> • "en" • "de" • "fr" • "it" • "es" • "ko" • "ko-kr" • "zh-hans" • "zh-cn" • "zh-hant" • "zh-tw"
font	<ul style="list-style-type: none"> • "font_a" • "font_b"
smooth	<ul style="list-style-type: none"> • "true" / "1" • "false" / "0"
dw	<ul style="list-style-type: none"> • "true" / "1" • "false" / "0"
dh	<ul style="list-style-type: none"> • "true" / "1" • "false" / "0"
width	<ul style="list-style-type: none"> • "1" to "8"

Attribute	Specificable Setting Value
height	<ul style="list-style-type: none"> • "1" to "8"
reverse	<ul style="list-style-type: none"> • "true" / "1" • "false" / "0"
ul	<ul style="list-style-type: none"> • "true" / "1" • "false" / "0"
em	<ul style="list-style-type: none"> • "true" / "1" • "false" / "0"
color	<ul style="list-style-type: none"> • "color_1"
x	<ul style="list-style-type: none"> • "0" to "65535"
y	<ul style="list-style-type: none"> • "0" to "65535"
align	<ul style="list-style-type: none"> • "left" • "center" • "right"
rotate	<ul style="list-style-type: none"> • "true" / "1" • "false" / "0"
linespc	<ul style="list-style-type: none"> • "0" to "255"

- <feed>

Attribute	Specificable Setting Value
unit	<ul style="list-style-type: none"> • "0" to "255"
line	<ul style="list-style-type: none"> • "0" to "255"
linespc	<ul style="list-style-type: none"> • "0" to "255"

- <image>

Attribute	Specificable Setting Value
width	<ul style="list-style-type: none"> • "0" to "65535"
height	<ul style="list-style-type: none"> • "0" to "65535"
color	<ul style="list-style-type: none"> • "color_1"
align	<ul style="list-style-type: none"> • "left" • "center" • "right"
mode	<ul style="list-style-type: none"> • "mono" • "gray16"

- <barcode>

Attribute	Specificable Setting Value
type	<ul style="list-style-type: none"> • "upc_a" • "upc_e" • "ean13" • "jan13" • "ean8" • "jan8" • "code39" • "itf" • "codabar" • "code93" • "code128" • "gs1_128" • "gs1_databar_omnidirectional" • "gs1_databar_truncated" • "gs1_databar_limited" • "gs1_databar_expanded"
hri	<ul style="list-style-type: none"> • "none" • "above" • "below" • "both"
font	<ul style="list-style-type: none"> • "font_a" • "font_b"
width	<ul style="list-style-type: none"> • "2" to "6"
height	<ul style="list-style-type: none"> • "1" to "255"
align	<ul style="list-style-type: none"> • "left" • "center" • "right"
rotate	<ul style="list-style-type: none"> • "true" / "1" • "false" / "0"

- <symbol>

Attribute	Specificable Setting Value
type	<ul style="list-style-type: none"> • "pdf417_standard" • "pdf417_truncated" • "qrcode_model_1" • "qrcode_model_2" • "maxicode_mode_2" • "maxicode_mode_3" • "maxicode_mode_4" • "maxicode_mode_5" • "maxicode_mode_6" • "gs1_databar_stacked" • "gs1_databar_stacked_omnidirectional" • "gs1_databar_expanded_stacked"
level	<ul style="list-style-type: none"> • "level_0" • "level_1" (default value) • "level_2" • "level_3" • "level_4" • "level_5" • "level_6" • "level_7" • "level_8" • "level_l" • "level_m" • "level_q" • "level_h" • "default"
width	-
height	-
size	-
align	<ul style="list-style-type: none"> • "left" • "center" • "right"
rotate	<ul style="list-style-type: none"> • "true" / "1" • "false" / "0"

- <cut>

Attribute	Specificable Setting Value
type	<ul style="list-style-type: none"> • "no_feed" • "feed"

- <sound>

Attribute	Specificable Setting Value
pattern	<ul style="list-style-type: none"> • "none" • "pattern_a" • "pattern_b" • "pattern_c" • "pattern_d" • "pattern_e" • "error" • "paper_end"
repeat	<ul style="list-style-type: none"> • "0" • "1" to "255"

CustomerDisplayControl XML

- <text>

Attribute	Specificable Setting Value
x	<ul style="list-style-type: none"> • "1" to "44"
y	<ul style="list-style-type: none"> • "1" to "19"
reverse	<ul style="list-style-type: none"> • "true" / "1" • "false" / "0"
lang	<ul style="list-style-type: none"> • "en" • "ja"

TM-T70II-DT2

Printer Specifications

Item		58mm Specification	80mm Specification
Amount of initial feed		30 dots	
Initial page mode area	ANK model	416 x 1662 dots	512 x 1662 dots
	Multiple languages model	416 x 1662 dots	576 x 1662 dots
Maximum page mode area	ANK model	416 x 1662 dots	512 x 1662 dots
	Multiple languages model	416 x 1662 dots	576 x 1662 dots
Baseline of Font A		21 dots from the top of the character	
Baseline of Font B		16 dots from the top of the character	

Elements for which restricted parameter setting values can be specified

PrinterControl XML

- <text>

Attribute	Specificable Setting Value
lang	<ul style="list-style-type: none"> • "en" • "de" • "fr" • "it" • "es" • "ko" • "ko-kr" • "zh-hans" • "zh-cn" • "zh-hant" • "zh-tw"
font	<ul style="list-style-type: none"> • "font_a" • "font_b"
smooth	<ul style="list-style-type: none"> • "true" / "1" • "false" / "0"
dw	<ul style="list-style-type: none"> • "true" / "1" • "false" / "0"
dh	<ul style="list-style-type: none"> • "true" / "1" • "false" / "0"
width	<ul style="list-style-type: none"> • "1" to "8"

Attribute	Specificable Setting Value
height	<ul style="list-style-type: none"> • "1" to "8"
reverse	<ul style="list-style-type: none"> • "true" / "1" • "false" / "0"
ul	<ul style="list-style-type: none"> • "true" / "1" • "false" / "0"
em	<ul style="list-style-type: none"> • "true" / "1" • "false" / "0"
color	<ul style="list-style-type: none"> • "color_1"
x	<ul style="list-style-type: none"> • "0" to "65535"
y	<ul style="list-style-type: none"> • "0" to "65535"
align	<ul style="list-style-type: none"> • "left" • "center" • "right"
rotate	<ul style="list-style-type: none"> • "true" / "1" • "false" / "0"
linespc	<ul style="list-style-type: none"> • "0" to "255"

- <feed>

Attribute	Specificable Setting Value
unit	<ul style="list-style-type: none"> • "0" to "255"
line	<ul style="list-style-type: none"> • "0" to "255"
linespc	<ul style="list-style-type: none"> • "0" to "255"

- <image>

Attribute	Specificable Setting Value
width	<ul style="list-style-type: none"> • "0" to "65535"
height	<ul style="list-style-type: none"> • "0" to "65535"
color	<ul style="list-style-type: none"> • "color_1"
align	<ul style="list-style-type: none"> • "left" • "center" • "right"
mode	<ul style="list-style-type: none"> • "mono" • "gray16"

- <barcode>

Attribute	Specificable Setting Value
type	<ul style="list-style-type: none"> • "upc_a" • "upc_e" • "ean13" • "jan13" • "ean8" • "jan8" • "code39" • "itf" • "codabar" • "code93" • "code128" • "gs1_128" • "gs1_databar_omnidirectional" • "gs1_databar_truncated" • "gs1_databar_limited" • "gs1_databar_expanded"
hri	<ul style="list-style-type: none"> • "none" • "above" • "below" • "both"
font	<ul style="list-style-type: none"> • "font_a" • "font_b"
width	<ul style="list-style-type: none"> • "2" to "6"
height	<ul style="list-style-type: none"> • "1" to "255"
align	<ul style="list-style-type: none"> • "left" • "center" • "right"
rotate	<ul style="list-style-type: none"> • "true" / "1" • "false" / "0"

- <symbol>

Attribute	Specificable Setting Value
type	<ul style="list-style-type: none"> • "pdf417_standard" • "pdf417_truncated" • "qrcode_model_1" • "qrcode_model_2" • "maxicode_mode_2" • "maxicode_mode_3" • "maxicode_mode_4" • "maxicode_mode_5" • "maxicode_mode_6" • "gs1_databar_stacked" • "gs1_databar_stacked_omnidirectional" • "gs1_databar_expanded_stacked"
level	<ul style="list-style-type: none"> • "level_0" • "level_1" (default value) • "level_2" • "level_3" • "level_4" • "level_5" • "level_6" • "level_7" • "level_8" • "level_l" • "level_m" • "level_q" • "level_h" • "default"
width	-
height	-
size	-
align	<ul style="list-style-type: none"> • "left" • "center" • "right"
rotate	<ul style="list-style-type: none"> • "true" / "1" • "false" / "0"

- <cut>

Attribute	Specificable Setting Value
type	<ul style="list-style-type: none"> • "no_feed" • "feed"

- <sound>

Attribute	Specificable Setting Value
pattern	<ul style="list-style-type: none"> • "none" • "pattern_a" • "pattern_b" • "pattern_c" • "pattern_d" • "pattern_e" • "error" • "paper_end"
repeat	<ul style="list-style-type: none"> • "0" • "1" to "255"

CustomerDisplayControl XML

- <text>

Attribute	Specificable Setting Value
x	<ul style="list-style-type: none"> • "1" to "44"
y	<ul style="list-style-type: none"> • "1" to "19"
reverse	<ul style="list-style-type: none"> • "true" / "1" • "false" / "0"
lang	<ul style="list-style-type: none"> • "en" • "ja"
color	<ul style="list-style-type: none"> • "#000000" to "#FFFFFF"

TM-T88V-DT

Printer Specifications

Item		58mm Specification	80mm Specification
Amount of initial feed		30 dots	
Initial page mode area		360 x 831 dots	512 x 831 dots
Maximum page mode area		360 x 1662 dots	512 x 1662 dots
Baseline of Font A		21 dots from the top of the character	
Baseline of Font B	ANK	16 dots from the top of the character	
	Chinese characters	15 dots from the top of the character	

Elements for which restricted parameter setting values can be specified

PrinterControl XML

- <text>

Attribute	Specificable Setting Value
lang	<ul style="list-style-type: none"> • "en" • "de" • "fr" • "it" • "es" • "ko" • "ko-kr" • "zh-hans" • "zh-cn" • "zh-hant" • "zh-tw" • "th"
font	<ul style="list-style-type: none"> • "font_a" • "font_b" • "special_a" • "special_b"
smooth	<ul style="list-style-type: none"> • "true" / "1" • "false" / "0"
dw	<ul style="list-style-type: none"> • "true" / "1" • "false" / "0"
dh	<ul style="list-style-type: none"> • "true" / "1" • "false" / "0"
width	<ul style="list-style-type: none"> • "1" to "8"

Attribute	Specificable Setting Value
height	<ul style="list-style-type: none"> • "1" to "8"
reverse	<ul style="list-style-type: none"> • "true" / "1" • "false" / "0"
ul	<ul style="list-style-type: none"> • "true" / "1" • "false" / "0"
em	<ul style="list-style-type: none"> • "true" / "1" • "false" / "0"
color	<ul style="list-style-type: none"> • "color_1"
x	<ul style="list-style-type: none"> • "0" to "65535"
y	<ul style="list-style-type: none"> • "0" to "65535"
align	<ul style="list-style-type: none"> • "left" • "center" • "right"
rotate	<ul style="list-style-type: none"> • "true" / "1" • "false" / "0"
linespc	<ul style="list-style-type: none"> • "0" to "255"

- <feed>

Attribute	Specificable Setting Value
unit	<ul style="list-style-type: none"> • "0" to "255"
line	<ul style="list-style-type: none"> • "0" to "255"
linespc	<ul style="list-style-type: none"> • "0" to "255"

- <image>

Attribute	Specificable Setting Value
width	<ul style="list-style-type: none"> • "0" to "65535"
height	<ul style="list-style-type: none"> • "0" to "65535"
color	<ul style="list-style-type: none"> • "color_1"
align	<ul style="list-style-type: none"> • "left" • "center" • "right"
mode	<ul style="list-style-type: none"> • "mono" • "gray16"

- <barcode>

Attribute	Specificable Setting Value
type	<ul style="list-style-type: none"> • "upc_a" • "upc_e" • "ean13" • "jan13" • "ean8" • "jan8" • "code39" • "itf" • "codabar" • "code93" • "code128" • "gs1_128" • "gs1_databar_omnidirectional" • "gs1_databar_truncated" • "gs1_databar_limited" • "gs1_databar_expanded"
hri	<ul style="list-style-type: none"> • "none" • "above" • "below" • "both"
font	<ul style="list-style-type: none"> • "font_a" • "font_b"
width	<ul style="list-style-type: none"> • "2" to "6"
height	<ul style="list-style-type: none"> • "1" to "255"
align	<ul style="list-style-type: none"> • "left" • "center" • "right"
rotate	<ul style="list-style-type: none"> • "true" / "1" • "false" / "0"

- <symbol>

Attribute	Specificable Setting Value
type	<ul style="list-style-type: none"> • "pdf417_standard" • "pdf417_truncated" • "qrcode_model_1" • "qrcode_model_2" • "maxicode_mode_2" • "maxicode_mode_3" • "maxicode_mode_4" • "maxicode_mode_5" • "maxicode_mode_6" • "gs1_databar_stacked" • "gs1_databar_stacked_omnidirectional" • "gs1_databar_expanded_stacked"
level	<ul style="list-style-type: none"> • "level_0" • "level_1" (default value) • "level_2" • "level_3" • "level_4" • "level_5" • "level_6" • "level_7" • "level_8" • "level_l" • "level_m" • "level_q" • "level_h" • "default"
width	-
height	-
size	-
align	<ul style="list-style-type: none"> • "left" • "center" • "right"
rotate	<ul style="list-style-type: none"> • "true" / "1" • "false" / "0"

- <cut>

Attribute	Specificable Setting Value
type	<ul style="list-style-type: none"> • "no_feed" • "feed"

- <sound>

Attribute	Specificable Setting Value
pattern	<ul style="list-style-type: none"> • "none" • "pattern_a" • "pattern_b" • "pattern_c" • "pattern_d" • "pattern_e" • "error" • "paper_end"
repeat	<ul style="list-style-type: none"> • "0" • "1" to "255"

CustomerDisplayControl XML

- <text>

Attribute	Specificable Setting Value
x	<ul style="list-style-type: none"> • "1" to "44"
y	<ul style="list-style-type: none"> • "1" to "19"
reverse	<ul style="list-style-type: none"> • "true" / "1" • "false" / "0"
lang	<ul style="list-style-type: none"> • "en" • "ja"

TM-T88VI-DT2

Printer Specifications

Item		58mm Specification	80mm Specification
Amount of initial feed		30 dots	
Initial page mode area		360 x 831 dots	512 x 831 dots
Maximum page mode area		360 x 1662 dots	512 x 1662 dots
Baseline of Font A		21 dots from the top of the character	
Baseline of Font B	ANK	16 dots from the top of the character	
	Chinese characters	15 dots from the top of the character	

Elements for which restricted parameter setting values can be specified

PrinterControl XML

- <text>

Attribute	Specificable Setting Value
lang	<ul style="list-style-type: none"> • "en" • "de" • "fr" • "it" • "es" • "ko" • "ko-kr" • "zh-hans" • "zh-cn" • "zh-hant" • "zh-tw" • "th"
font	<ul style="list-style-type: none"> • "font_a" • "font_b" • "special_a" • "special_b"
smooth	<ul style="list-style-type: none"> • "true" / "1" • "false" / "0"
dw	<ul style="list-style-type: none"> • "true" / "1" • "false" / "0"
dh	<ul style="list-style-type: none"> • "true" / "1" • "false" / "0"
width	<ul style="list-style-type: none"> • "1" to "8"

Attribute	Specificable Setting Value
height	<ul style="list-style-type: none"> • "1" to "8"
reverse	<ul style="list-style-type: none"> • "true" / "1" • "false" / "0"
ul	<ul style="list-style-type: none"> • "true" / "1" • "false" / "0"
em	<ul style="list-style-type: none"> • "true" / "1" • "false" / "0"
color	<ul style="list-style-type: none"> • "color_1"
x	<ul style="list-style-type: none"> • "0" to "65535"
y	<ul style="list-style-type: none"> • "0" to "65535"
align	<ul style="list-style-type: none"> • "left" • "center" • "right"
rotate	<ul style="list-style-type: none"> • "true" / "1" • "false" / "0"
linespc	<ul style="list-style-type: none"> • "0" to "255"

- <feed>

Attribute	Specificable Setting Value
unit	<ul style="list-style-type: none"> • "0" to "255"
line	<ul style="list-style-type: none"> • "0" to "255"
linespc	<ul style="list-style-type: none"> • "0" to "255"

- <image>

Attribute	Specificable Setting Value
width	<ul style="list-style-type: none"> • "0" to "65535"
height	<ul style="list-style-type: none"> • "0" to "65535"
color	<ul style="list-style-type: none"> • "color_1"
align	<ul style="list-style-type: none"> • "left" • "center" • "right"
mode	<ul style="list-style-type: none"> • "mono" • "gray16"

- <barcode>

Attribute	Specificable Setting Value
type	<ul style="list-style-type: none"> • "upc_a" • "upc_e" • "ean13" • "jan13" • "ean8" • "jan8" • "code39" • "itf" • "codabar" • "code93" • "code128" • "gs1_128" • "gs1_databar_omnidirectional" • "gs1_databar_truncated" • "gs1_databar_limited" • "gs1_databar_expanded"
hri	<ul style="list-style-type: none"> • "none" • "above" • "below" • "both"
font	<ul style="list-style-type: none"> • "font_a" • "font_b"
width	<ul style="list-style-type: none"> • "2" to "6"
height	<ul style="list-style-type: none"> • "1" to "255"
align	<ul style="list-style-type: none"> • "left" • "center" • "right"
rotate	<ul style="list-style-type: none"> • "true" / "1" • "false" / "0"

- <symbol>

Attribute	Specificable Setting Value
type	<ul style="list-style-type: none"> • "pdf417_standard" • "pdf417_truncated" • "qrcode_model_1" • "qrcode_model_2" • "maxicode_mode_2" • "maxicode_mode_3" • "maxicode_mode_4" • "maxicode_mode_5" • "maxicode_mode_6" • "gs1_databar_stacked" • "gs1_databar_stacked_omnidirectional" • "gs1_databar_expanded_stacked" • "azteccode_fullrange" • "azteccode_compact" • "datamatrix_square" • "datamatrix_rectangle_8" • "datamatrix_rectangle_12" • "datamatrix_rectangle_16"
level	<ul style="list-style-type: none"> • "level_0" • "level_1" (default value) • "level_2" • "level_3" • "level_4" • "level_5" • "level_6" • "level_7" • "level_8" • "level_l" • "level_m" • "level_q" • "level_h" • "default"
width	-
height	-
size	-
align	<ul style="list-style-type: none"> • "left" • "center" • "right"
rotate	<ul style="list-style-type: none"> • "true" / "1" • "false" / "0"

- <cut>

Attribute	Specificable Setting Value
type	<ul style="list-style-type: none"> • "no_feed" • "feed"

- <sound>

Attribute	Specificable Setting Value
pattern	<ul style="list-style-type: none"> • "none" • "pattern_a" • "pattern_b" • "pattern_c" • "pattern_d" • "pattern_e" • "error" • "paper_end"
repeat	<ul style="list-style-type: none"> • "0" • "1" to "255"

CustomerDisplayControl XML

- <text>

Attribute	Specificable Setting Value
x	<ul style="list-style-type: none"> • "1" to "44"
y	<ul style="list-style-type: none"> • "1" to "19"
reverse	<ul style="list-style-type: none"> • "true" / "1" • "false" / "0"
lang	<ul style="list-style-type: none"> • "en" • "ja"
color	<ul style="list-style-type: none"> • "#000000" to "#FFFFFF"

TM-H6000IV-DT

Printer Specifications

Item	58mm Specification	80mm Specification
Amount of initial feed	30 dots	
Initial page mode area	360 x 831 dots	512 x 831 dots
Maximum page mode area	360 x 1662 dots	512 x 1662 dots
Baseline of Font A	21 dots from the top of the character	
Baseline of Font B	16 dots from the top of the character	

Elements for which restricted parameter setting values can be specified

PrinterControl XML

- <text>

Attribute	Specifiable Setting Value
lang	<ul style="list-style-type: none"> • "en" • "de" • "fr" • "it" • "es" • "zh-hans" • "zh-cn" • "zh-hant" • "zh-tw"
font	<ul style="list-style-type: none"> • "font_a" • "font_b"
smooth	<ul style="list-style-type: none"> • "true" / "1" • "false" / "0"
dw	<ul style="list-style-type: none"> • "true" / "1" • "false" / "0"
dh	<ul style="list-style-type: none"> • "true" / "1" • "false" / "0"
width	<ul style="list-style-type: none"> • "1" to "8"
height	<ul style="list-style-type: none"> • "1" to "8"
reverse	<ul style="list-style-type: none"> • "true" / "1" • "false" / "0"
ul	<ul style="list-style-type: none"> • "true" / "1" • "false" / "0"

Attribute	Specificable Setting Value
em	<ul style="list-style-type: none"> • "true" / "1" • "false" / "0"
color	<ul style="list-style-type: none"> • "color_1"
x	<ul style="list-style-type: none"> • "0" to "65535"
y	<ul style="list-style-type: none"> • "0" to "65535"
align	<ul style="list-style-type: none"> • "left" • "center" • "right"
rotate	<ul style="list-style-type: none"> • "true" / "1" • "false" / "0"
linespc	<ul style="list-style-type: none"> • "0" to "255"

- <feed>

Attribute	Specificable Setting Value
unit	<ul style="list-style-type: none"> • "0" to "255"
line	<ul style="list-style-type: none"> • "0" to "255"
linespc	<ul style="list-style-type: none"> • "0" to "255"

- <image>

Attribute	Specificable Setting Value
width	<ul style="list-style-type: none"> • "0" to "65535"
height	<ul style="list-style-type: none"> • "0" to "65535"
color	<ul style="list-style-type: none"> • "color_1"
align	<ul style="list-style-type: none"> • "left" • "center" • "right"
mode	<ul style="list-style-type: none"> • "mono"

- <barcode>

Attribute	Specificable Setting Value
type	<ul style="list-style-type: none"> • "upc_a" • "upc_e" • "ean13" • "jan13" • "ean8" • "jan8" • "code39" • "itf" • "codabar" • "code93" • "code128" • "gs1_128" • "gs1_databar_omnidirectional" • "gs1_databar_truncated" • "gs1_databar_limited" • "gs1_databar_expanded"
hri	<ul style="list-style-type: none"> • "none" • "above" • "below" • "both"
font	<ul style="list-style-type: none"> • "font_a" • "font_b"
width	<ul style="list-style-type: none"> • "2" to "6"
height	<ul style="list-style-type: none"> • "1" to "255"
align	<ul style="list-style-type: none"> • "left" • "center" • "right"
rotate	<ul style="list-style-type: none"> • "true" / "1" • "false" / "0"

- <symbol>

Attribute	Specificable Setting Value
type	<ul style="list-style-type: none"> • "pdf417_standard" • "pdf417_truncated" • "qrcode_model_1" • "qrcode_model_2" • "maxicode_mode_2" • "maxicode_mode_3" • "maxicode_mode_4" • "maxicode_mode_5" • "maxicode_mode_6" • "gs1_databar_stacked" • "gs1_databar_stacked_omnidirectional" • "gs1_databar_expanded_stacked"
level	<ul style="list-style-type: none"> • "level_0" • "level_1" (default value) • "level_2" • "level_3" • "level_4" • "level_5" • "level_6" • "level_7" • "level_8" • "level_l" • "level_m" • "level_q" • "level_h" • "default"
width	-
height	-
size	-
align	<ul style="list-style-type: none"> • "left" • "center" • "right"
rotate	<ul style="list-style-type: none"> • "true" / "1" • "false" / "0"

- <cut>

Attribute	Specificable Setting Value
type	<ul style="list-style-type: none"> • "no_feed" • "feed"

CustomerDisplayControl XML

- <text>

Attribute	Specificable Setting Value
x	• "1" to "44"
y	• "1" to "19"
reverse	• "true" / "1" • "false" / "0"
lang	• "en" • "ja"

TM-H6000V

Printer Specifications

Item	Receipt	Slip	Validation	Endorsment	Endorsment (40cpl)
Amount of initial feed	30 dots	24 dots			18 dots
Initial page mode area	512 x 1662 dots	540 x 1408 dots		-	
Maximum page mode area	512 x 2400 dots	540 x 1408 dots		-	
Baseline of Font A	21 dots from the top of the character	9 dots from the top of the character			7 dots from the top of the character
Baseline of Font B	21 dots from the top of the character	9 dots from the top of the character			-
Baseline of Font C	18 dots from the top of the character	-			

Elements for which restricted parameter setting values can be specified

PrinterControl XML

- <text>

Attribute	Specificable Setting Value
lang	<ul style="list-style-type: none"> • "en" • "de" • "fr" • "it" • "es" • "zh-hant" • "zh-tw"

Attribute	Specificable Setting Value
font	<ul style="list-style-type: none"> • "font_a" • "font_b" • "font_c" • "special_a" • "special_b"
smooth	<ul style="list-style-type: none"> • "true" / "1" • "false" / "0"
dw	<ul style="list-style-type: none"> • "true" / "1" • "false" / "0"
dh	<ul style="list-style-type: none"> • "true" / "1" • "false" / "0"
width	<ul style="list-style-type: none"> • "1" to "8"
height	<ul style="list-style-type: none"> • "1" to "8"
reverse	<ul style="list-style-type: none"> • "true" / "1" • "false" / "0"
ul	<ul style="list-style-type: none"> • "true" / "1" • "false" / "0"
em	<ul style="list-style-type: none"> • "true" / "1" • "false" / "0"
color	<ul style="list-style-type: none"> • "color_1"
x	<ul style="list-style-type: none"> • "0" to "65535"
y	<ul style="list-style-type: none"> • "0" to "65535"
align	<ul style="list-style-type: none"> • "left" • "center" • "right"
rotate	<ul style="list-style-type: none"> • "true" / "1" • "false" / "0"
linespc	<ul style="list-style-type: none"> • "0" to "255"

- <feed>

Attribute	Specificable Setting Value
unit	<ul style="list-style-type: none"> • "0" to "255"
line	<ul style="list-style-type: none"> • "0" to "255"
linespc	<ul style="list-style-type: none"> • "0" to "255"

- <image>

Attribute	Specificable Setting Value
width	<ul style="list-style-type: none"> • "0" to "65535"
height	<ul style="list-style-type: none"> • "0" to "65535"
color	<ul style="list-style-type: none"> • "color_1"
align	<ul style="list-style-type: none"> • "left" • "center" • "right"
mode	<ul style="list-style-type: none"> • "mono" • "gray16"

- <barcode>

Attribute	Specificable Setting Value
type	<ul style="list-style-type: none"> • "upc_a" • "upc_e" • "ean13" • "jan13" • "ean8" • "jan8" • "code39" • "itf" • "codabar" • "code93" • "code128" • "gs1_128" • "gs1_databar_omnidirectional" • "gs1_databar_truncated" • "gs1_databar_limited" • "gs1_databar_expanded"
hri	<ul style="list-style-type: none"> • "none" • "above" • "below" • "both"
font	<ul style="list-style-type: none"> • "font_a" • "font_b" • "font_c"
width	<ul style="list-style-type: none"> • "2" to "6"
height	<ul style="list-style-type: none"> • "1" to "255"

Attribute	Specificable Setting Value
align	<ul style="list-style-type: none"> • "left" • "center" • "right"
rotate	<ul style="list-style-type: none"> • "true" / "1" • "false" / "0"

- <symbol>

Attribute	Specificable Setting Value
type	<ul style="list-style-type: none"> • "pdf417_standard" • "pdf417_truncated" • "qrcode_model_1" • "qrcode_model_2" • "maxicode_mode_2" • "maxicode_mode_3" • "maxicode_mode_4" • "maxicode_mode_5" • "maxicode_mode_6" • "gs1_databar_stacked" • "gs1_databar_stacked_omnidirectional" • "gs1_databar_expanded_stacked" • "azteccode_fullrange" • "azteccode_compact" • "datamatrix_square" • "datamatrix_rectangle_8" • "datamatrix_rectangle_12" • "datamatrix_rectangle_16"
level	<ul style="list-style-type: none"> • "level_0" • "level_1" (default value) • "level_2" • "level_3" • "level_4" • "level_5" • "level_6" • "level_7" • "level_8" • "level_l" • "level_m" • "level_q" • "level_h" • Integer (5 to 95) • "default"
width	-

Attribute	Specificable Setting Value
height	-
size	-
align	<ul style="list-style-type: none"> • "left" • "center" • "right"
rotate	<ul style="list-style-type: none"> • "true" / "1" • "false" / "0"

- <line>

Attribute	Specificable Setting Value
x1	• "0" to "65535"
y1	• "0" to "65535"
x2	• "0" to "65535"
y2	• "0" to "65535"
style	<ul style="list-style-type: none"> • "thin" • "medium" • "thick"

- <rectangle>

Attribute	Specificable Setting Value
x1	• "0" to "65535"
y1	• "0" to "65535"
x2	• "0" to "65535"
y2	• "0" to "65535"
style	<ul style="list-style-type: none"> • "thin" • "medium" • "thick"

- <cut>

Attribute	Specificable Setting Value
type	<ul style="list-style-type: none"> • "no_feed" • "feed"

CustomerDisplayControl XML

- <text>

Attribute	Specificable Setting Value
x	• "1" to "44"

Attribute	Specificable Setting Value
y	<ul style="list-style-type: none">• "1" to "19"
reverse	<ul style="list-style-type: none">• "true" / "1"• "false" / "0"
lang	<ul style="list-style-type: none">• "en"• "ja"

TM-m30

Printer Specifications

Item	58mm Specification	80mm Specification
Amount of initial feed	30 dots	
Initial page mode area	420 x 2400 dots	576 x 2400 dots
Maximum page mode area	420 x 2400 dots	576 x 2400 dots
Baseline of Font A	21 dots from the top of the character	
Baseline of Font B	21 dots from the top of the character	
Baseline of Font C	16 dots from the top of the character	

Elements for which restricted parameter setting values can be specified

PrinterControl XML

- <text>

Attribute	Specificable Setting Value
lang	<ul style="list-style-type: none"> • "en" • "de" • "fr" • "it" • "es" • "ko" • "ko-kr" • "zh-hans" • "zh-cn" • "zh-hant" • "zh-tw" • "th"
font	<ul style="list-style-type: none"> • "font_a" • "font_b" • "font_c" • "special_a" • "special_b"
smooth	<ul style="list-style-type: none"> • "true" / "1" • "false" / "0"
dw	<ul style="list-style-type: none"> • "true" / "1" • "false" / "0"
dh	<ul style="list-style-type: none"> • "true" / "1" • "false" / "0"

Attribute	Specificable Setting Value
width	<ul style="list-style-type: none"> • "1" to "8"
height	<ul style="list-style-type: none"> • "1" to "8"
reverse	<ul style="list-style-type: none"> • "true" / "1" • "false" / "0"
ul	<ul style="list-style-type: none"> • "true" / "1" • "false" / "0"
em	<ul style="list-style-type: none"> • "true" / "1" • "false" / "0"
color	<ul style="list-style-type: none"> • "color_1"
x	<ul style="list-style-type: none"> • "0" to "65535"
y	<ul style="list-style-type: none"> • "0" to "65535"
align	<ul style="list-style-type: none"> • "left" • "center" • "right"
rotate	<ul style="list-style-type: none"> • "true" / "1" • "false" / "0"
linespc	<ul style="list-style-type: none"> • "0" to "255"

- <feed>

Attribute	Specificable Setting Value
unit	<ul style="list-style-type: none"> • "0" to "255"
line	<ul style="list-style-type: none"> • "0" to "255"
linespc	<ul style="list-style-type: none"> • "0" to "255"

- <image>

Attribute	Specificable Setting Value
width	<ul style="list-style-type: none"> • "0" to "65535"
height	<ul style="list-style-type: none"> • "0" to "65535"
color	<ul style="list-style-type: none"> • "color_1"
align	<ul style="list-style-type: none"> • "left" • "center" • "right"
mode	<ul style="list-style-type: none"> • "mono"

- <barcode>

Attribute	Specificable Setting Value
type	<ul style="list-style-type: none"> • "upc_a" • "upc_e" • "ean13" • "jan13" • "ean8" • "jan8" • "code39" • "itf" • "codabar" • "code93" • "code128" • "gs1_128" • "gs1_databar_omnidirectional" • "gs1_databar_truncated" • "gs1_databar_limited" • "gs1_databar_expanded"
hri	<ul style="list-style-type: none"> • "none" • "above" • "below" • "both"
font	<ul style="list-style-type: none"> • "font_a" • "font_b" • "font_c"
width	<ul style="list-style-type: none"> • "2" to "6"
height	<ul style="list-style-type: none"> • "1" to "255"
align	<ul style="list-style-type: none"> • "left" • "center" • "right"
rotate	<ul style="list-style-type: none"> • "true" / "1" • "false" / "0"

- <symbol>

Attribute	Specifiable Setting Value
type	<ul style="list-style-type: none"> • "pdf417_standard" • "pdf417_truncated" • "qrcode_model_1" • "qrcode_model_2" • "maxicode_mode_2" • "maxicode_mode_3" • "maxicode_mode_4" • "maxicode_mode_5" • "maxicode_mode_6" • "gs1_databar_stacked" • "gs1_databar_stacked_omnidirectional" • "gs1_databar_expanded_stacked" • "azteccode_fullrange" • "azteccode_compact" • "datamatrix_square" • "datamatrix_rectangle_8" • "datamatrix_rectangle_12" • "datamatrix_rectangle_16"
level	<ul style="list-style-type: none"> • "level_0" • "level_1" (default value) • "level_2" • "level_3" • "level_4" • "level_5" • "level_6" • "level_7" • "level_8" • "level_l" • "level_m" • "level_q" • "level_h" • Integer (5 to 95) • "default"
width	-
height	-
size	-
align	<ul style="list-style-type: none"> • "left" • "center" • "right"

Attribute	Specificable Setting Value
rotate	<ul style="list-style-type: none"> • "true" / "1" • "false" / "0"

- <cut>

Attribute	Specificable Setting Value
type	<ul style="list-style-type: none"> • "no_feed" • "feed"

- <sound>

Attribute	Specificable Setting Value
pattern	<ul style="list-style-type: none"> • "none" • "pattern_a" • "pattern_b" • "pattern_c" • "pattern_d" • "pattern_e" • "error" • "paper_end"
repeat	<ul style="list-style-type: none"> • "1" to "255"

CustomerDisplayControl XML

- <text>

Attribute	Specificable Setting Value
x	<ul style="list-style-type: none"> • "1" to "44"
y	<ul style="list-style-type: none"> • "1" to "19"
reverse	<ul style="list-style-type: none"> • "true" / "1" • "false" / "0"
lang	<ul style="list-style-type: none"> • "en" • "ja"

TM-m30II

Printer Specifications

Item	58mm Specification	80mm Specification
Amount of initial feed	30 dots	
Initial page mode area	420 x 4800 dots	576 x 4800 dots
Maximum page mode area	420 x 4800 dots	576 x 4800 dots
Baseline of Font A	21 dots from the top of the character	
Baseline of Font B	21 dots from the top of the character	
Baseline of Font C	16 dots from the top of the character	

Elements for which restricted parameter setting values can be specified

PrinterControl XML

- <text>

Attribute	Specificable Setting Value
lang	<ul style="list-style-type: none"> • "en" • "de" • "fr" • "it" • "es" • "ko" • "ko-kr" • "zh-hans" • "zh-cn" • "zh-hant" • "zh-tw" • "th" • "mul"
font	<ul style="list-style-type: none"> • "font_a" • "font_b" • "font_c" • "special_a" • "special_b"
smooth	<ul style="list-style-type: none"> • "true" / "1" • "false" / "0"
dw	<ul style="list-style-type: none"> • "true" / "1" • "false" / "0"

Attribute	Specificable Setting Value
dh	<ul style="list-style-type: none"> • "true" / "1" • "false" / "0"
width	<ul style="list-style-type: none"> • "1" to "8"
height	<ul style="list-style-type: none"> • "1" to "8"
reverse	<ul style="list-style-type: none"> • "true" / "1" • "false" / "0"
ul	<ul style="list-style-type: none"> • "true" / "1" • "false" / "0"
em	<ul style="list-style-type: none"> • "true" / "1" • "false" / "0"
color	<ul style="list-style-type: none"> • "color_1"
x	<ul style="list-style-type: none"> • "0" to "65535"
y	<ul style="list-style-type: none"> • "0" to "65535"
align	<ul style="list-style-type: none"> • "left" • "center" • "right"
rotate	<ul style="list-style-type: none"> • "true" / "1" • "false" / "0"
linespc	<ul style="list-style-type: none"> • "0" to "255"

- <feed>

Attribute	Specificable Setting Value
unit	<ul style="list-style-type: none"> • "0" to "255"
line	<ul style="list-style-type: none"> • "0" to "255"
linespc	<ul style="list-style-type: none"> • "0" to "255"

- <image>

Attribute	Specificable Setting Value
width	<ul style="list-style-type: none"> • "0" to "65535"
height	<ul style="list-style-type: none"> • "0" to "65535"
color	<ul style="list-style-type: none"> • "color_1"
align	<ul style="list-style-type: none"> • "left" • "center" • "right"
mode	<ul style="list-style-type: none"> • "mono"

- <barcode>

Attribute	Specificable Setting Value
type	<ul style="list-style-type: none"> • "upc_a" • "upc_e" • "ean13" • "jan13" • "ean8" • "jan8" • "code39" • "itf" • "codabar" • "code93" • "code128" • "code128_auto" • "gs1_128" • "gs1_databar_omnidirectional" • "gs1_databar_truncated" • "gs1_databar_limited" • "gs1_databar_expanded"
hri	<ul style="list-style-type: none"> • "none" • "above" • "below" • "both"
font	<ul style="list-style-type: none"> • "font_a" • "font_b" • "font_c"
width	<ul style="list-style-type: none"> • "2" to "6"
height	<ul style="list-style-type: none"> • "1" to "255"
align	<ul style="list-style-type: none"> • "left" • "center" • "right"
rotate	<ul style="list-style-type: none"> • "true" / "1" • "false" / "0"

- <symbol>

Attribute	Specifiable Setting Value
type	<ul style="list-style-type: none"> • "pdf417_standard" • "pdf417_truncated" • "qrcode_model_1" • "qrcode_model_2" • "maxicode_mode_2" • "maxicode_mode_3" • "maxicode_mode_4" • "maxicode_mode_5" • "maxicode_mode_6" • "gs1_databar_stacked" • "gs1_databar_stacked_omnidirectional" • "gs1_databar_expanded_stacked" • "azteccode_fullrange" • "azteccode_compact" • "datamatrix_square" • "datamatrix_rectangle_8" • "datamatrix_rectangle_12" • "datamatrix_rectangle_16"
level	<ul style="list-style-type: none"> • "level_0" • "level_1" (default value) • "level_2" • "level_3" • "level_4" • "level_5" • "level_6" • "level_7" • "level_8" • "level_l" • "level_m" • "level_q" • "level_h" • Integer (5 to 95) • "default"
width	-
height	-
size	-
align	<ul style="list-style-type: none"> • "left" • "center" • "right"

Attribute	Specificable Setting Value
rotate	<ul style="list-style-type: none"> • "true" / "1" • "false" / "0"

- <cut>

Attribute	Specificable Setting Value
type	<ul style="list-style-type: none"> • "no_feed" • "feed"

- <sound>

Attribute	Specificable Setting Value
pattern	<ul style="list-style-type: none"> • "none" • "pattern_a" • "pattern_b" • "pattern_c" • "pattern_d" • "pattern_e" • "error" • "paper_end"
repeat	<ul style="list-style-type: none"> • "1" to "255"

CustomerDisplayControl XML

- <text>

Attribute	Specificable Setting Value
x	<ul style="list-style-type: none"> • "1" to "44"
y	<ul style="list-style-type: none"> • "1" to "19"
reverse	<ul style="list-style-type: none"> • "true" / "1" • "false" / "0"
lang	<ul style="list-style-type: none"> • "en" • "ja" • "mul"

TM-m30II-H

Printer Specifications

Item	58mm Specification	80mm Specification
Amount of initial feed	30 dots	
Initial page mode area	420 x 4800 dots	576 x 4800 dots
Maximum page mode area	420 x 4800 dots	576 x 4800 dots
Baseline of Font A	21 dots from the top of the character	
Baseline of Font B	21 dots from the top of the character	
Baseline of Font C	16 dots from the top of the character	

Elements for which restricted parameter setting values can be specified

PrinterControl XML

- <text>

Attribute	Specificable Setting Value
lang	<ul style="list-style-type: none"> • "en" • "de" • "fr" • "it" • "es" • "ko" • "ko-kr" • "zh-hans" • "zh-cn" • "zh-hant" • "zh-tw" • "th" • "mul"
font	<ul style="list-style-type: none"> • "font_a" • "font_b" • "font_c" • "special_a" • "special_b"
smooth	<ul style="list-style-type: none"> • "true" / "1" • "false" / "0"
dw	<ul style="list-style-type: none"> • "true" / "1" • "false" / "0"

Attribute	Specificable Setting Value
dh	<ul style="list-style-type: none"> • "true" / "1" • "false" / "0"
width	<ul style="list-style-type: none"> • "1" to "8"
height	<ul style="list-style-type: none"> • "1" to "8"
reverse	<ul style="list-style-type: none"> • "true" / "1" • "false" / "0"
ul	<ul style="list-style-type: none"> • "true" / "1" • "false" / "0"
em	<ul style="list-style-type: none"> • "true" / "1" • "false" / "0"
color	<ul style="list-style-type: none"> • "color_1"
x	<ul style="list-style-type: none"> • "0" to "65535"
y	<ul style="list-style-type: none"> • "0" to "65535"
align	<ul style="list-style-type: none"> • "left" • "center" • "right"
rotate	<ul style="list-style-type: none"> • "true" / "1" • "false" / "0"
linespc	<ul style="list-style-type: none"> • "0" to "255"

- <feed>

Attribute	Specificable Setting Value
unit	<ul style="list-style-type: none"> • "0" to "255"
line	<ul style="list-style-type: none"> • "0" to "255"
linespc	<ul style="list-style-type: none"> • "0" to "255"

- <image>

Attribute	Specificable Setting Value
width	<ul style="list-style-type: none"> • "0" to "65535"
height	<ul style="list-style-type: none"> • "0" to "65535"
color	<ul style="list-style-type: none"> • "color_1"
align	<ul style="list-style-type: none"> • "left" • "center" • "right"
mode	<ul style="list-style-type: none"> • "mono"

- <barcode>

Attribute	Specificable Setting Value
type	<ul style="list-style-type: none"> • "upc_a" • "upc_e" • "ean13" • "jan13" • "ean8" • "jan8" • "code39" • "itf" • "codabar" • "code93" • "code128" • "code128_auto" • "gs1_128" • "gs1_databar_omnidirectional" • "gs1_databar_truncated" • "gs1_databar_limited" • "gs1_databar_expanded"
hri	<ul style="list-style-type: none"> • "none" • "above" • "below" • "both"
font	<ul style="list-style-type: none"> • "font_a" • "font_b" • "font_c"
width	<ul style="list-style-type: none"> • "2" to "6"
height	<ul style="list-style-type: none"> • "1" to "255"
align	<ul style="list-style-type: none"> • "left" • "center" • "right"
rotate	<ul style="list-style-type: none"> • "true" / "1" • "false" / "0"

- <symbol>

Attribute	Specifiable Setting Value
type	<ul style="list-style-type: none"> • "pdf417_standard" • "pdf417_truncated" • "qrcode_model_1" • "qrcode_model_2" • "maxicode_mode_2" • "maxicode_mode_3" • "maxicode_mode_4" • "maxicode_mode_5" • "maxicode_mode_6" • "gs1_databar_stacked" • "gs1_databar_stacked_omnidirectional" • "gs1_databar_expanded_stacked" • "azteccode_fullrange" • "azteccode_compact" • "datamatrix_square" • "datamatrix_rectangle_8" • "datamatrix_rectangle_12" • "datamatrix_rectangle_16"
level	<ul style="list-style-type: none"> • "level_0" • "level_1" (default value) • "level_2" • "level_3" • "level_4" • "level_5" • "level_6" • "level_7" • "level_8" • "level_l" • "level_m" • "level_q" • "level_h" • Integer (5 to 95) • "default"
width	-
height	-
size	-
align	<ul style="list-style-type: none"> • "left" • "center" • "right"

Attribute	Specificable Setting Value
rotate	<ul style="list-style-type: none"> • "true" / "1" • "false" / "0"

- <cut>

Attribute	Specificable Setting Value
type	<ul style="list-style-type: none"> • "no_feed" • "feed"

- <sound>

Attribute	Specificable Setting Value
pattern	<ul style="list-style-type: none"> • "none" • "pattern_a" • "pattern_b" • "pattern_c" • "pattern_d" • "pattern_e" • "error" • "paper_end"
repeat	<ul style="list-style-type: none"> • "1" to "255"

TM-m30II-NT

Printer Specifications

Item	58mm Specification	80mm Specification
Amount of initial feed	30 dots	
Initial page mode area	420 x 4800 dots	576 x 4800 dots
Maximum page mode area	420 x 4800 dots	576 x 4800 dots
Baseline of Font A	21 dots from the top of the character	
Baseline of Font B	21 dots from the top of the character	
Baseline of Font C	16 dots from the top of the character	

Elements for which restricted parameter setting values can be specified

PrinterControl XML

- <text>

Attribute	Specificable Setting Value
lang	<ul style="list-style-type: none"> • "en" • "de" • "fr" • "it" • "es" • "ko" • "ko-kr" • "zh-hans" • "zh-cn" • "zh-hant" • "zh-tw" • "th" • "mul"
font	<ul style="list-style-type: none"> • "font_a" • "font_b" • "font_c" • "special_a" • "special_b"
smooth	<ul style="list-style-type: none"> • "true" / "1" • "false" / "0"
dw	<ul style="list-style-type: none"> • "true" / "1" • "false" / "0"

Attribute	Specificable Setting Value
dh	<ul style="list-style-type: none"> • "true" / "1" • "false" / "0"
width	<ul style="list-style-type: none"> • "1" to "8"
height	<ul style="list-style-type: none"> • "1" to "8"
reverse	<ul style="list-style-type: none"> • "true" / "1" • "false" / "0"
ul	<ul style="list-style-type: none"> • "true" / "1" • "false" / "0"
em	<ul style="list-style-type: none"> • "true" / "1" • "false" / "0"
color	<ul style="list-style-type: none"> • "color_1"
x	<ul style="list-style-type: none"> • "0" to "65535"
y	<ul style="list-style-type: none"> • "0" to "65535"
align	<ul style="list-style-type: none"> • "left" • "center" • "right"
rotate	<ul style="list-style-type: none"> • "true" / "1" • "false" / "0"
linespc	<ul style="list-style-type: none"> • "0" to "255"

- <feed>

Attribute	Specificable Setting Value
unit	<ul style="list-style-type: none"> • "0" to "255"
line	<ul style="list-style-type: none"> • "0" to "255"
linespc	<ul style="list-style-type: none"> • "0" to "255"

- <image>

Attribute	Specificable Setting Value
width	<ul style="list-style-type: none"> • "0" to "65535"
height	<ul style="list-style-type: none"> • "0" to "65535"
color	<ul style="list-style-type: none"> • "color_1"
align	<ul style="list-style-type: none"> • "left" • "center" • "right"
mode	<ul style="list-style-type: none"> • "mono"

- <barcode>

Attribute	Specificable Setting Value
type	<ul style="list-style-type: none"> • "upc_a" • "upc_e" • "ean13" • "jan13" • "ean8" • "jan8" • "code39" • "itf" • "codabar" • "code93" • "code128" • "code128_auto" • "gs1_128" • "gs1_databar_omnidirectional" • "gs1_databar_truncated" • "gs1_databar_limited" • "gs1_databar_expanded"
hri	<ul style="list-style-type: none"> • "none" • "above" • "below" • "both"
font	<ul style="list-style-type: none"> • "font_a" • "font_b" • "font_c"
width	<ul style="list-style-type: none"> • "2" to "6"
height	<ul style="list-style-type: none"> • "1" to "255"
align	<ul style="list-style-type: none"> • "left" • "center" • "right"
rotate	<ul style="list-style-type: none"> • "true" / "1" • "false" / "0"

- <symbol>

Attribute	Specifiable Setting Value
type	<ul style="list-style-type: none"> • "pdf417_standard" • "pdf417_truncated" • "qrcode_model_1" • "qrcode_model_2" • "maxicode_mode_2" • "maxicode_mode_3" • "maxicode_mode_4" • "maxicode_mode_5" • "maxicode_mode_6" • "gs1_databar_stacked" • "gs1_databar_stacked_omnidirectional" • "gs1_databar_expanded_stacked" • "azteccode_fullrange" • "azteccode_compact" • "datamatrix_square" • "datamatrix_rectangle_8" • "datamatrix_rectangle_12" • "datamatrix_rectangle_16"
level	<ul style="list-style-type: none"> • "level_0" • "level_1" (default value) • "level_2" • "level_3" • "level_4" • "level_5" • "level_6" • "level_7" • "level_8" • "level_l" • "level_m" • "level_q" • "level_h" • Integer (5 to 95) • "default"
width	-
height	-
size	-
align	<ul style="list-style-type: none"> • "left" • "center" • "right"

Attribute	Specificable Setting Value
rotate	<ul style="list-style-type: none"> • "true" / "1" • "false" / "0"

- <cut>

Attribute	Specificable Setting Value
type	<ul style="list-style-type: none"> • "no_feed" • "feed"

- <sound>

Attribute	Specificable Setting Value
pattern	<ul style="list-style-type: none"> • "none" • "pattern_a" • "pattern_b" • "pattern_c" • "pattern_d" • "pattern_e" • "error" • "paper_end"
repeat	<ul style="list-style-type: none"> • "1" to "255"

TM-m30II-S

Printer Specifications

Item	58mm Specification	80mm Specification
Amount of initial feed	30 dots	
Initial page mode area	420 x 4800 dots	576 x 4800 dots
Maximum page mode area	420 x 4800 dots	576 x 4800 dots
Baseline of Font A	21 dots from the top of the character	
Baseline of Font B	21 dots from the top of the character	
Baseline of Font C	16 dots from the top of the character	

Elements for which restricted parameter setting values can be specified

PrinterControl XML

- <text>

Attribute	Specificable Setting Value
lang	<ul style="list-style-type: none"> • "en" • "de" • "fr" • "it" • "es" • "mul"
font	<ul style="list-style-type: none"> • "font_a" • "font_b" • "font_c" • "special_a" • "special_b"
smooth	<ul style="list-style-type: none"> • "true" / "1" • "false" / "0"
dw	<ul style="list-style-type: none"> • "true" / "1" • "false" / "0"
dh	<ul style="list-style-type: none"> • "true" / "1" • "false" / "0"
width	<ul style="list-style-type: none"> • "1" to "8"
height	<ul style="list-style-type: none"> • "1" to "8"
reverse	<ul style="list-style-type: none"> • "true" / "1" • "false" / "0"

Attribute	Specifiable Setting Value
ul	<ul style="list-style-type: none"> • "true" / "1" • "false" / "0"
em	<ul style="list-style-type: none"> • "true" / "1" • "false" / "0"
color	<ul style="list-style-type: none"> • "color_1"
x	<ul style="list-style-type: none"> • "0" to "65535"
y	<ul style="list-style-type: none"> • "0" to "65535"
align	<ul style="list-style-type: none"> • "left" • "center" • "right"
rotate	<ul style="list-style-type: none"> • "true" / "1" • "false" / "0"
linespc	<ul style="list-style-type: none"> • "0" to "255"

- <feed>

Attribute	Specifiable Setting Value
unit	<ul style="list-style-type: none"> • "0" to "255"
line	<ul style="list-style-type: none"> • "0" to "255"
linespc	<ul style="list-style-type: none"> • "0" to "255"

- <image>

Attribute	Specifiable Setting Value
width	<ul style="list-style-type: none"> • "0" to "65535"
height	<ul style="list-style-type: none"> • "0" to "65535"
color	<ul style="list-style-type: none"> • "color_1"
align	<ul style="list-style-type: none"> • "left" • "center" • "right"
mode	<ul style="list-style-type: none"> • "mono"

- <barcode>

Attribute	Specificable Setting Value
type	<ul style="list-style-type: none"> • "upc_a" • "upc_e" • "ean13" • "jan13" • "ean8" • "jan8" • "code39" • "itf" • "codabar" • "code93" • "code128" • "code128_auto" • "gs1_128" • "gs1_databar_omnidirectional" • "gs1_databar_truncated" • "gs1_databar_limited" • "gs1_databar_expanded"
hri	<ul style="list-style-type: none"> • "none" • "above" • "below" • "both"
font	<ul style="list-style-type: none"> • "font_a" • "font_b" • "font_c"
width	<ul style="list-style-type: none"> • "2" to "6"
height	<ul style="list-style-type: none"> • "1" to "255"
align	<ul style="list-style-type: none"> • "left" • "center" • "right"
rotate	<ul style="list-style-type: none"> • "true" / "1" • "false" / "0"

- <symbol>

Attribute	Specificable Setting Value
type	<ul style="list-style-type: none"> • "pdf417_standard" • "pdf417_truncated" • "qrcode_model_1" • "qrcode_model_2" • "maxicode_mode_2" • "maxicode_mode_3" • "maxicode_mode_4" • "maxicode_mode_5" • "maxicode_mode_6" • "gs1_databar_stacked" • "gs1_databar_stacked_omnidirectional" • "gs1_databar_expanded_stacked" • "azteccode_fullrange" • "azteccode_compact" • "datamatrix_square" • "datamatrix_rectangle_8" • "datamatrix_rectangle_12" • "datamatrix_rectangle_16"
level	<ul style="list-style-type: none"> • "level_0" • "level_1" (default value) • "level_2" • "level_3" • "level_4" • "level_5" • "level_6" • "level_7" • "level_8" • "level_l" • "level_m" • "level_q" • "level_h" • Integer (5 to 95) • "default"
width	-
height	-
size	-
align	<ul style="list-style-type: none"> • "left" • "center" • "right"

Attribute	Specificable Setting Value
rotate	<ul style="list-style-type: none"> • "true" / "1" • "false" / "0"

- <cut>

Attribute	Specificable Setting Value
type	<ul style="list-style-type: none"> • "no_feed" • "feed"

- <sound>

Attribute	Specificable Setting Value
pattern	<ul style="list-style-type: none"> • "none" • "pattern_a" • "pattern_b" • "pattern_c" • "pattern_d" • "pattern_e" • "error" • "paper_end"
repeat	<ul style="list-style-type: none"> • "1" to "255"

TM-m30II-SL

Printer Specifications

Item	58mm Specification	80mm Specification
Amount of initial feed	30 dots	
Initial page mode area	420 x 4800 dots	576 x 4800 dots
Maximum page mode area	420 x 4800 dots	576 x 4800 dots
Baseline of Font A	21 dots from the top of the character	
Baseline of Font B	21 dots from the top of the character	
Baseline of Font C	16 dots from the top of the character	

Elements for which restricted parameter setting values can be specified

PrinterControl XML

- <text>

Attribute	Specificable Setting Value
lang	<ul style="list-style-type: none"> • "en" • "de" • "fr" • "it" • "es" • "mul"
font	<ul style="list-style-type: none"> • "font_a" • "font_b" • "font_c" • "special_a" • "special_b"
smooth	<ul style="list-style-type: none"> • "true" / "1" • "false" / "0"
dw	<ul style="list-style-type: none"> • "true" / "1" • "false" / "0"
dh	<ul style="list-style-type: none"> • "true" / "1" • "false" / "0"
width	<ul style="list-style-type: none"> • "1" to "8"
height	<ul style="list-style-type: none"> • "1" to "8"
reverse	<ul style="list-style-type: none"> • "true" / "1" • "false" / "0"

Attribute	Specificable Setting Value
ul	<ul style="list-style-type: none"> • "true" / "1" • "false" / "0"
em	<ul style="list-style-type: none"> • "true" / "1" • "false" / "0"
color	<ul style="list-style-type: none"> • "color_1"
x	<ul style="list-style-type: none"> • "0" to "65535"
y	<ul style="list-style-type: none"> • "0" to "65535"
align	<ul style="list-style-type: none"> • "left" • "center" • "right"
rotate	<ul style="list-style-type: none"> • "true" / "1" • "false" / "0"
linespc	<ul style="list-style-type: none"> • "0" to "255"

- <feed>

Attribute	Specificable Setting Value
unit	<ul style="list-style-type: none"> • "0" to "255"
line	<ul style="list-style-type: none"> • "0" to "255"
linespc	<ul style="list-style-type: none"> • "0" to "255"

- <image>

Attribute	Specificable Setting Value
width	<ul style="list-style-type: none"> • "0" to "65535"
height	<ul style="list-style-type: none"> • "0" to "65535"
color	<ul style="list-style-type: none"> • "color_1"
align	<ul style="list-style-type: none"> • "left" • "center" • "right"
mode	<ul style="list-style-type: none"> • "mono"

- <barcode>

Attribute	Specificable Setting Value
type	<ul style="list-style-type: none"> • "upc_a" • "upc_e" • "ean13" • "jan13" • "ean8" • "jan8" • "code39" • "itf" • "codabar" • "code93" • "code128" • "code128_auto" • "gs1_128" • "gs1_databar_omnidirectional" • "gs1_databar_truncated" • "gs1_databar_limited" • "gs1_databar_expanded"
hri	<ul style="list-style-type: none"> • "none" • "above" • "below" • "both"
font	<ul style="list-style-type: none"> • "font_a" • "font_b" • "font_c"
width	<ul style="list-style-type: none"> • "2" to "6"
height	<ul style="list-style-type: none"> • "1" to "255"
align	<ul style="list-style-type: none"> • "left" • "center" • "right"
rotate	<ul style="list-style-type: none"> • "true" / "1" • "false" / "0"

- <symbol>

Attribute	Specifiable Setting Value
type	<ul style="list-style-type: none"> • "pdf417_standard" • "pdf417_truncated" • "qrcode_model_1" • "qrcode_model_2" • "maxicode_mode_2" • "maxicode_mode_3" • "maxicode_mode_4" • "maxicode_mode_5" • "maxicode_mode_6" • "gs1_databar_stacked" • "gs1_databar_stacked_omnidirectional" • "gs1_databar_expanded_stacked" • "azteccode_fullrange" • "azteccode_compact" • "datamatrix_square" • "datamatrix_rectangle_8" • "datamatrix_rectangle_12" • "datamatrix_rectangle_16"
level	<ul style="list-style-type: none"> • "level_0" • "level_1" (default value) • "level_2" • "level_3" • "level_4" • "level_5" • "level_6" • "level_7" • "level_8" • "level_l" • "level_m" • "level_q" • "level_h" • Integer (5 to 95) • "default"
width	-
height	-
size	-
align	<ul style="list-style-type: none"> • "left" • "center" • "right"

Attribute	Specificable Setting Value
rotate	<ul style="list-style-type: none"> • "true" / "1" • "false" / "0"

- <cut>

Attribute	Specificable Setting Value
type	<ul style="list-style-type: none"> • "no_feed" • "feed"

- <sound>

Attribute	Specificable Setting Value
pattern	<ul style="list-style-type: none"> • "none" • "pattern_a" • "pattern_b" • "pattern_c" • "pattern_d" • "pattern_e" • "error" • "paper_end"
repeat	<ul style="list-style-type: none"> • "1" to "255"

TM-m30III

Printer Specifications

Item	58mm Specification	80mm Specification
Amount of initial feed	30 dots	
Initial page mode area	420 x 4800 dots	576 x 4800 dots
Maximum page mode area	420 x 4800 dots	576 x 4800 dots
Baseline of Font A	21 dots from the top of the character	
Baseline of Font B	21 dots from the top of the character	
Baseline of Font C	16 dots from the top of the character	

Elements for which restricted parameter setting values can be specified

PrinterControl XML

- <text>

Attribute	Specificable Setting Value
lang	<ul style="list-style-type: none"> • "en" • "de" • "fr" • "it" • "es" • "ko" • "ko-kr" • "zh-hans" • "zh-cn" • "zh-hant" • "zh-tw" • "th" • "mul"
font	<ul style="list-style-type: none"> • "font_a" • "font_b" • "font_c" • "special_a" • "special_b"
smooth	<ul style="list-style-type: none"> • "true" / "1" • "false" / "0"
dw	<ul style="list-style-type: none"> • "true" / "1" • "false" / "0"

Attribute	Specificable Setting Value
dh	<ul style="list-style-type: none"> • "true" / "1" • "false" / "0"
width	<ul style="list-style-type: none"> • "1" to "8"
height	<ul style="list-style-type: none"> • "1" to "8"
reverse	<ul style="list-style-type: none"> • "true" / "1" • "false" / "0"
ul	<ul style="list-style-type: none"> • "true" / "1" • "false" / "0"
em	<ul style="list-style-type: none"> • "true" / "1" • "false" / "0"
color	<ul style="list-style-type: none"> • "color_1"
x	<ul style="list-style-type: none"> • "0" to "65535"
y	<ul style="list-style-type: none"> • "0" to "65535"
align	<ul style="list-style-type: none"> • "left" • "center" • "right"
rotate	<ul style="list-style-type: none"> • "true" / "1" • "false" / "0"
linespc	<ul style="list-style-type: none"> • "0" to "255"

- <feed>

Attribute	Specificable Setting Value
unit	<ul style="list-style-type: none"> • "0" to "255"
line	<ul style="list-style-type: none"> • "0" to "255"
linespc	<ul style="list-style-type: none"> • "0" to "255"

- <image>

Attribute	Specificable Setting Value
width	<ul style="list-style-type: none"> • "0" to "65535"
height	<ul style="list-style-type: none"> • "0" to "65535"
color	<ul style="list-style-type: none"> • "color_1"
align	<ul style="list-style-type: none"> • "left" • "center" • "right"
mode	<ul style="list-style-type: none"> • "mono"

- <barcode>

Attribute	Specificable Setting Value
type	<ul style="list-style-type: none"> • "upc_a" • "upc_e" • "ean13" • "jan13" • "ean8" • "jan8" • "code39" • "itf" • "codabar" • "code93" • "code128" • "code128_auto" • "gs1_128" • "gs1_databar_omnidirectional" • "gs1_databar_truncated" • "gs1_databar_limited" • "gs1_databar_expanded"
hri	<ul style="list-style-type: none"> • "none" • "above" • "below" • "both"
font	<ul style="list-style-type: none"> • "font_a" • "font_b" • "font_c"
width	<ul style="list-style-type: none"> • "2" to "6"
height	<ul style="list-style-type: none"> • "1" to "255"
align	<ul style="list-style-type: none"> • "left" • "center" • "right"
rotate	<ul style="list-style-type: none"> • "true" / "1" • "false" / "0"

- <symbol>

Attribute	Specificable Setting Value
type	<ul style="list-style-type: none"> • "pdf417_standard" • "pdf417_truncated" • "qrcode_model_1" • "qrcode_model_2" • "maxicode_mode_2" • "maxicode_mode_3" • "maxicode_mode_4" • "maxicode_mode_5" • "maxicode_mode_6" • "gs1_databar_stacked" • "gs1_databar_stacked_omnidirectional" • "gs1_databar_expanded_stacked" • "azteccode_fullrange" • "azteccode_compact" • "datamatrix_square" • "datamatrix_rectangle_8" • "datamatrix_rectangle_12" • "datamatrix_rectangle_16"
level	<ul style="list-style-type: none"> • "level_0" • "level_1" (default value) • "level_2" • "level_3" • "level_4" • "level_5" • "level_6" • "level_7" • "level_8" • "level_l" • "level_m" • "level_q" • "level_h" • Integer (5 to 95) • "default"
width	-
height	-
size	-
align	<ul style="list-style-type: none"> • "left" • "center" • "right"

Attribute	Specificable Setting Value
rotate	<ul style="list-style-type: none"> • "true" / "1" • "false" / "0"

- <sound>

Attribute	Specificable Setting Value
pattern	<ul style="list-style-type: none"> • "none" • "pattern_a" • "pattern_b" • "pattern_c" • "pattern_d" • "pattern_e" • "error" • "paper_end"
repeat	<ul style="list-style-type: none"> • "1" to "255"

TM-m30III-H

Printer Specifications

Item	58mm Specification	80mm Specification
Amount of initial feed	30 dots	
Initial page mode area	420 x 4800 dots	576 x 4800 dots
Maximum page mode area	420 x 4800 dots	576 x 4800 dots
Baseline of Font A	21 dots from the top of the character	
Baseline of Font B	21 dots from the top of the character	
Baseline of Font C	16 dots from the top of the character	

Elements for which restricted parameter setting values can be specified

PrinterControl XML

- <text>

Attribute	Specificable Setting Value
lang	<ul style="list-style-type: none"> • "en" • "de" • "fr" • "it" • "es" • "ko" • "ko-kr" • "zh-hans" • "zh-cn" • "zh-hant" • "zh-tw" • "th" • "mul"
font	<ul style="list-style-type: none"> • "font_a" • "font_b" • "font_c" • "special_a" • "special_b"
smooth	<ul style="list-style-type: none"> • "true" / "1" • "false" / "0"
dw	<ul style="list-style-type: none"> • "true" / "1" • "false" / "0"

Attribute	Specificable Setting Value
dh	<ul style="list-style-type: none"> • "true" / "1" • "false" / "0"
width	<ul style="list-style-type: none"> • "1" to "8"
height	<ul style="list-style-type: none"> • "1" to "8"
reverse	<ul style="list-style-type: none"> • "true" / "1" • "false" / "0"
ul	<ul style="list-style-type: none"> • "true" / "1" • "false" / "0"
em	<ul style="list-style-type: none"> • "true" / "1" • "false" / "0"
color	<ul style="list-style-type: none"> • "color_1"
x	<ul style="list-style-type: none"> • "0" to "65535"
y	<ul style="list-style-type: none"> • "0" to "65535"
align	<ul style="list-style-type: none"> • "left" • "center" • "right"
rotate	<ul style="list-style-type: none"> • "true" / "1" • "false" / "0"
linespc	<ul style="list-style-type: none"> • "0" to "255"

- <feed>

Attribute	Specificable Setting Value
unit	<ul style="list-style-type: none"> • "0" to "255"
line	<ul style="list-style-type: none"> • "0" to "255"
linespc	<ul style="list-style-type: none"> • "0" to "255"

- <image>

Attribute	Specificable Setting Value
width	<ul style="list-style-type: none"> • "0" to "65535"
height	<ul style="list-style-type: none"> • "0" to "65535"
color	<ul style="list-style-type: none"> • "color_1"
align	<ul style="list-style-type: none"> • "left" • "center" • "right"
mode	<ul style="list-style-type: none"> • "mono"

- <barcode>

Attribute	Specificable Setting Value
type	<ul style="list-style-type: none"> • "upc_a" • "upc_e" • "ean13" • "jan13" • "ean8" • "jan8" • "code39" • "itf" • "codabar" • "code93" • "code128" • "code128_auto" • "gs1_128" • "gs1_databar_omnidirectional" • "gs1_databar_truncated" • "gs1_databar_limited" • "gs1_databar_expanded"
hri	<ul style="list-style-type: none"> • "none" • "above" • "below" • "both"
font	<ul style="list-style-type: none"> • "font_a" • "font_b" • "font_c"
width	<ul style="list-style-type: none"> • "2" to "6"
height	<ul style="list-style-type: none"> • "1" to "255"
align	<ul style="list-style-type: none"> • "left" • "center" • "right"
rotate	<ul style="list-style-type: none"> • "true" / "1" • "false" / "0"

- <symbol>

Attribute	Specificable Setting Value
type	<ul style="list-style-type: none"> • "pdf417_standard" • "pdf417_truncated" • "qrcode_model_1" • "qrcode_model_2" • "maxicode_mode_2" • "maxicode_mode_3" • "maxicode_mode_4" • "maxicode_mode_5" • "maxicode_mode_6" • "gs1_databar_stacked" • "gs1_databar_stacked_omnidirectional" • "gs1_databar_expanded_stacked" • "azteccode_fullrange" • "azteccode_compact" • "datamatrix_square" • "datamatrix_rectangle_8" • "datamatrix_rectangle_12" • "datamatrix_rectangle_16"
level	<ul style="list-style-type: none"> • "level_0" • "level_1" (default value) • "level_2" • "level_3" • "level_4" • "level_5" • "level_6" • "level_7" • "level_8" • "level_l" • "level_m" • "level_q" • "level_h" • Integer (5 to 95) • "default"
width	-
height	-
size	-
align	<ul style="list-style-type: none"> • "left" • "center" • "right"

Attribute	Specificable Setting Value
rotate	<ul style="list-style-type: none"> • "true" / "1" • "false" / "0"

- <sound>

Attribute	Specificable Setting Value
pattern	<ul style="list-style-type: none"> • "none" • "pattern_a" • "pattern_b" • "pattern_c" • "pattern_d" • "pattern_e" • "error" • "paper_end"
repeat	<ul style="list-style-type: none"> • "1" to "255"

TM-m50

Printer Specifications

Item	58mm Specification	80mm Specification
Amount of initial feed	30 dots	
Initial page mode area	360 x 4800 dots	512 x 4800 dots
Maximum page mode area	360 x 4800 dots	512 x 4800 dots
Baseline of Font A	21 dots from the top of the character	
Baseline of Font B	16 dots from the top of the character	

Elements for which restricted parameter setting values can be specified

PrinterControl XML

- <text>

Attribute	Specificable Setting Value
lang	<ul style="list-style-type: none"> • "en" • "de" • "fr" • "it" • "es" • "ko" • "ko-kr" • "zh-hans" • "zh-cn" • "zh-hant" • "zh-tw" • "th" • "mul"
font	<ul style="list-style-type: none"> • "font_a" • "font_b" • "special_a" • "special_b"
smooth	<ul style="list-style-type: none"> • "true" / "1" • "false" / "0"
dw	<ul style="list-style-type: none"> • "true" / "1" • "false" / "0"
dh	<ul style="list-style-type: none"> • "true" / "1" • "false" / "0"
width	<ul style="list-style-type: none"> • "1" to "8"

Attribute	Specificable Setting Value
height	<ul style="list-style-type: none"> • "1" to "8"
reverse	<ul style="list-style-type: none"> • "true" / "1" • "false" / "0"
ul	<ul style="list-style-type: none"> • "true" / "1" • "false" / "0"
em	<ul style="list-style-type: none"> • "true" / "1" • "false" / "0"
color	<ul style="list-style-type: none"> • "color_1"
x	<ul style="list-style-type: none"> • "0" to "65535"
y	<ul style="list-style-type: none"> • "0" to "65535"
align	<ul style="list-style-type: none"> • "left" • "center" • "right"
rotate	<ul style="list-style-type: none"> • "true" / "1" • "false" / "0"
linespc	<ul style="list-style-type: none"> • "0" to "255"

- <feed>

Attribute	Specificable Setting Value
unit	<ul style="list-style-type: none"> • "0" to "255"
line	<ul style="list-style-type: none"> • "0" to "255"
linespc	<ul style="list-style-type: none"> • "0" to "255"

- <image>

Attribute	Specificable Setting Value
width	<ul style="list-style-type: none"> • "0" to "65535"
height	<ul style="list-style-type: none"> • "0" to "65535"
color	<ul style="list-style-type: none"> • "color_1"
align	<ul style="list-style-type: none"> • "left" • "center" • "right"
mode	<ul style="list-style-type: none"> • "mono"

- <barcode>

Attribute	Specificable Setting Value
type	<ul style="list-style-type: none"> • "upc_a" • "upc_e" • "ean13" • "jan13" • "ean8" • "jan8" • "code39" • "itf" • "codabar" • "code93" • "code128" • "code128_auto" • "gs1_128" • "gs1_databar_omnidirectional" • "gs1_databar_truncated" • "gs1_databar_limited" • "gs1_databar_expanded"
hri	<ul style="list-style-type: none"> • "none" • "above" • "below" • "both"
font	<ul style="list-style-type: none"> • "font_a" • "font_b"
width	<ul style="list-style-type: none"> • "2" to "6"
height	<ul style="list-style-type: none"> • "1" to "255"
align	<ul style="list-style-type: none"> • "left" • "center" • "right"
rotate	<ul style="list-style-type: none"> • "true" / "1" • "false" / "0"

- <symbol>

Attribute	Specificable Setting Value
type	<ul style="list-style-type: none"> • "pdf417_standard" • "pdf417_truncated" • "qrcode_model_1" • "qrcode_model_2" • "maxicode_mode_2" • "maxicode_mode_3" • "maxicode_mode_4" • "maxicode_mode_5" • "maxicode_mode_6" • "gs1_databar_stacked" • "gs1_databar_stacked_omnidirectional" • "gs1_databar_expanded_stacked" • "azteccode_fullrange" • "azteccode_compact" • "datamatrix_square" • "datamatrix_rectangle_8" • "datamatrix_rectangle_12" • "datamatrix_rectangle_16"
level	<ul style="list-style-type: none"> • "level_0" • "level_1" (default value) • "level_2" • "level_3" • "level_4" • "level_5" • "level_6" • "level_7" • "level_8" • "level_l" • "level_m" • "level_q" • "level_h" • Integer (5 to 95) • "default"
width	-
height	-
size	-
align	<ul style="list-style-type: none"> • "left" • "center" • "right"

Attribute	Specificable Setting Value
rotate	<ul style="list-style-type: none"> • "true" / "1" • "false" / "0"

- <cut>

Attribute	Specificable Setting Value
type	<ul style="list-style-type: none"> • "no_feed" • "feed"

- <sound>

Attribute	Specificable Setting Value
pattern	<ul style="list-style-type: none"> • "none" • "pattern_a" • "pattern_b" • "pattern_c" • "pattern_d" • "pattern_e" • "error" • "paper_end"
repeat	<ul style="list-style-type: none"> • "1" to "255"

CustomerDisplayControl XML

- <text>

Attribute	Specificable Setting Value
x	<ul style="list-style-type: none"> • "1" to "44"
y	<ul style="list-style-type: none"> • "1" to "19"
reverse	<ul style="list-style-type: none"> • "true" / "1" • "false" / "0"
lang	<ul style="list-style-type: none"> • "en" • "ja"

TM-T88VI

Printer Specifications

Item		58mm Specification	80mm Specification
Amount of initial feed		30 dots	
Initial page mode area		360 x 831 dots	512 x 831 dots
Maximum page mode area		360 x 1662 dots	512 x 1662 dots
Baseline of Font A		21 dots from the top of the character	
Baseline of Font B	ANK	16 dots from the top of the character	
	Chinese characters	15 dots from the top of the character	

Elements for which restricted parameter setting values can be specified

PrinterControl XML

- <text>

Attribute	Specificable Setting Value
lang	<ul style="list-style-type: none"> • "en" • "de" • "fr" • "it" • "es" • "ko" • "ko-kr" • "zh-hans" • "zh-cn" • "zh-hant" • "zh-tw" • "th"
font	<ul style="list-style-type: none"> • "font_a" • "font_b" • "special_a" • "special_b"
smooth	<ul style="list-style-type: none"> • "true" / "1" • "false" / "0"
dw	<ul style="list-style-type: none"> • "true" / "1" • "false" / "0"
dh	<ul style="list-style-type: none"> • "true" / "1" • "false" / "0"
width	<ul style="list-style-type: none"> • "1" to "8"

Attribute	Specificable Setting Value
height	<ul style="list-style-type: none"> • "1" to "8"
reverse	<ul style="list-style-type: none"> • "true" / "1" • "false" / "0"
ul	<ul style="list-style-type: none"> • "true" / "1" • "false" / "0"
em	<ul style="list-style-type: none"> • "true" / "1" • "false" / "0"
color	<ul style="list-style-type: none"> • "color_1"
x	<ul style="list-style-type: none"> • "0" to "65535"
y	<ul style="list-style-type: none"> • "0" to "65535"
align	<ul style="list-style-type: none"> • "left" • "center" • "right"
rotate	<ul style="list-style-type: none"> • "true" / "1" • "false" / "0"
linespc	<ul style="list-style-type: none"> • "0" to "255"

- <feed>

Attribute	Specificable Setting Value
unit	<ul style="list-style-type: none"> • "0" to "255"
line	<ul style="list-style-type: none"> • "0" to "255"
linespc	<ul style="list-style-type: none"> • "0" to "255"

- <image>

Attribute	Specificable Setting Value
width	<ul style="list-style-type: none"> • "0" to "65535"
height	<ul style="list-style-type: none"> • "0" to "65535"
color	<ul style="list-style-type: none"> • "color_1"
align	<ul style="list-style-type: none"> • "left" • "center" • "right"
mode	<ul style="list-style-type: none"> • "mono"

- <barcode>

Attribute	Specificable Setting Value
type	<ul style="list-style-type: none"> • "upc_a" • "upc_e" • "ean13" • "jan13" • "ean8" • "jan8" • "code39" • "itf" • "codabar" • "code93" • "code128" • "gs1_128" • "gs1_databar_omnidirectional" • "gs1_databar_truncated" • "gs1_databar_limited" • "gs1_databar_expanded"
hri	<ul style="list-style-type: none"> • "none" • "above" • "below" • "both"
font	<ul style="list-style-type: none"> • "font_a" • "font_b"
width	<ul style="list-style-type: none"> • "2" to "6"
height	<ul style="list-style-type: none"> • "1" to "255"
align	<ul style="list-style-type: none"> • "left" • "center" • "right"
rotate	<ul style="list-style-type: none"> • "true" / "1" • "false" / "0"

- <symbol>

Attribute	Specifiable Setting Value
type	<ul style="list-style-type: none"> • "pdf417_standard" • "pdf417_truncated" • "qrcode_model_1" • "qrcode_model_2" • "maxicode_mode_2" • "maxicode_mode_3" • "maxicode_mode_4" • "maxicode_mode_5" • "maxicode_mode_6" • "gs1_databar_stacked" • "gs1_databar_stacked_omnidirectional" • "gs1_databar_expanded_stacked" • "azteccode_fullrange" • "azteccode_compact" • "datamatrix_square" • "datamatrix_rectangle_8" • "datamatrix_rectangle_12" • "datamatrix_rectangle_16"
level	<ul style="list-style-type: none"> • "level_0" • "level_1" (default value) • "level_2" • "level_3" • "level_4" • "level_5" • "level_6" • "level_7" • "level_8" • "level_l" • "level_m" • "level_q" • "level_h" • Integer (5 to 95) • "default"
width	-
height	-
size	-
align	<ul style="list-style-type: none"> • "left" • "center" • "right"

Attribute	Specificable Setting Value
rotate	<ul style="list-style-type: none"> • "true" / "1" • "false" / "0"

- <line>

Attribute	Specificable Setting Value
x1	• "0" to "65535"
y1	• "0" to "65535"
x2	• "0" to "65535"
y2	• "0" to "65535"
style	<ul style="list-style-type: none"> • "thin" • "medium" • "thick"

- <rectangle>

Attribute	Specificable Setting Value
x1	• "0" to "65535"
y1	• "0" to "65535"
x2	• "0" to "65535"
y2	• "0" to "65535"
style	<ul style="list-style-type: none"> • "thin" • "medium" • "thick"

- <cut>

Attribute	Specificable Setting Value
type	<ul style="list-style-type: none"> • "no_feed" • "feed"

- <sound>

Attribute	Specificable Setting Value
pattern	<ul style="list-style-type: none"> • "none" • "pattern_a" • "pattern_b" • "pattern_c" • "pattern_d" • "pattern_e" • "error" • "paper_end"

Attribute	Specificable Setting Value
repeat	<ul style="list-style-type: none"> • "1" to "255"

CustomerDisplayControl XML

- <text>

Attribute	Specificable Setting Value
x	<ul style="list-style-type: none"> • "1" to "44"
y	<ul style="list-style-type: none"> • "1" to "19"
reverse	<ul style="list-style-type: none"> • "true" / "1" • "false" / "0"
lang	<ul style="list-style-type: none"> • "en" • "ja"

TM-T88VII

Printer Specifications

Item		58mm Specification	80mm Specification
Amount of initial feed		30 dots	
Initial page mode area	Standard mode	360 x 1662 dots	512 x 1662 dots
	48 column mode	360 x 1662 dots	480 x 1662 dots
Maximum page mode area	Standard mode	360 x 4800 dots	512 x 4800 dots
	48 column mode	360 x 4800 dots	480 x 4800 dots
Baseline of Font A		21 dots from the top of the character	
Baseline of Font B		16 dots from the top of the character	

Elements for which restricted parameter setting values can be specified

PrinterControl XML

- <text>

Attribute	Specificable Setting Value
lang	<ul style="list-style-type: none"> • "en" • "de" • "fr" • "it" • "es" • "ko" • "ko-kr" • "zh-hans" • "zh-cn" • "zh-hant" • "zh-tw" • "th" • "mul"
font	<ul style="list-style-type: none"> • "font_a" • "font_b" • "special_a" • "special_b"
smooth	<ul style="list-style-type: none"> • "true" / "1" • "false" / "0"
dw	<ul style="list-style-type: none"> • "true" / "1" • "false" / "0"

Attribute	Specificable Setting Value
dh	<ul style="list-style-type: none"> • "true" / "1" • "false" / "0"
width	<ul style="list-style-type: none"> • "1" to "8"
height	<ul style="list-style-type: none"> • "1" to "8"
reverse	<ul style="list-style-type: none"> • "true" / "1" • "false" / "0"
ul	<ul style="list-style-type: none"> • "true" / "1" • "false" / "0"
em	<ul style="list-style-type: none"> • "true" / "1" • "false" / "0"
color	<ul style="list-style-type: none"> • "color_1"
x	<ul style="list-style-type: none"> • "0" to "65535"
y	<ul style="list-style-type: none"> • "0" to "65535"
align	<ul style="list-style-type: none"> • "left" • "center" • "right"
rotate	<ul style="list-style-type: none"> • "true" / "1" • "false" / "0"
linespc	<ul style="list-style-type: none"> • "0" to "255"

- <feed>

Attribute	Specificable Setting Value
unit	<ul style="list-style-type: none"> • "0" to "255"
line	<ul style="list-style-type: none"> • "0" to "255"
linespc	<ul style="list-style-type: none"> • "0" to "255"

- <image>

Attribute	Specificable Setting Value
width	<ul style="list-style-type: none"> • "0" to "65535"
height	<ul style="list-style-type: none"> • "0" to "65535"
color	<ul style="list-style-type: none"> • "color_1"
align	<ul style="list-style-type: none"> • "left" • "center" • "right"
mode	<ul style="list-style-type: none"> • "mono"

- <barcode>

Attribute	Specificable Setting Value
type	<ul style="list-style-type: none"> • "upc_a" • "upc_e" • "ean13" • "jan13" • "ean8" • "jan8" • "code39" • "itf" • "codabar" • "code93" • "code128" • "code128_auto" • "gs1_128" • "gs1_databar_omnidirectional" • "gs1_databar_truncated" • "gs1_databar_limited" • "gs1_databar_expanded"
hri	<ul style="list-style-type: none"> • "none" • "above" • "below" • "both"
font	<ul style="list-style-type: none"> • "font_a" • "font_b"
width	<ul style="list-style-type: none"> • "2" to "6"
height	<ul style="list-style-type: none"> • "1" to "255"
align	<ul style="list-style-type: none"> • "left" • "center" • "right"
rotate	<ul style="list-style-type: none"> • "true" / "1" • "false" / "0"

- <symbol>

Attribute	Specificable Setting Value
type	<ul style="list-style-type: none"> • "pdf417_standard" • "pdf417_truncated" • "qrcode_model_1" • "qrcode_model_2" • "maxicode_mode_2" • "maxicode_mode_3" • "maxicode_mode_4" • "maxicode_mode_5" • "maxicode_mode_6" • "gs1_databar_stacked" • "gs1_databar_stacked_omnidirectional" • "gs1_databar_expanded_stacked" • "azteccode_fullrange" • "azteccode_compact" • "datamatrix_square" • "datamatrix_rectangle_8" • "datamatrix_rectangle_12" • "datamatrix_rectangle_16"
level	<ul style="list-style-type: none"> • "level_0" • "level_1" (default value) • "level_2" • "level_3" • "level_4" • "level_5" • "level_6" • "level_7" • "level_8" • "level_l" • "level_m" • "level_q" • "level_h" • Integer (5 to 95) • "default"
width	-
height	-
size	-
align	<ul style="list-style-type: none"> • "left" • "center" • "right"

Attribute	Specificable Setting Value
rotate	<ul style="list-style-type: none"> • "true" / "1" • "false" / "0"

- <line>

Attribute	Specificable Setting Value
x1	• "0" to "65535"
y1	• "0" to "65535"
x2	• "0" to "65535"
y2	• "0" to "65535"
style	<ul style="list-style-type: none"> • "thin" • "medium" • "thick"

- <rectangle>

Attribute	Specificable Setting Value
x1	• "0" to "65535"
y1	• "0" to "65535"
x2	• "0" to "65535"
y2	• "0" to "65535"
style	<ul style="list-style-type: none"> • "thin" • "medium" • "thick"

- <cut>

Attribute	Specificable Setting Value
type	<ul style="list-style-type: none"> • "no_feed" • "feed"

- <sound>

Attribute	Specificable Setting Value
pattern	<ul style="list-style-type: none"> • "none" • "pattern_a" • "pattern_b" • "pattern_c" • "pattern_d" • "pattern_e" • "error" • "paper_end"

Attribute	Specifiable Setting Value
repeat	• "1" to "255"

TM-L100

Printer Specifications

Item	40mm Specification	58mm Specification	80mm Specification (42 column)	80mm Specification (48 column)
Amount of initial feed	30 dots			
Initial page mode area	280 x 4800 dots	400 x 4800 dots	552 x 4800 dots	576 x 4800 dots
Maximum page mode area	280 x 4800 dots	420 x 4800 dots	576 x 4800 dots	
Baseline of Font A	21 dots from the top of the character			
Baseline of Font B	21 dots from the top of the character			

Elements for which restricted parameter setting values can be specified

PrinterControl XML

- <text>

Attribute	Specificable Setting Value
lang	<ul style="list-style-type: none"> • "en" • "de" • "fr" • "it" • "es" • "ko" • "ko-kr" • "zh-hans" • "zh-cn" • "zh-hant" • "zh-tw" • "mul"
font	<ul style="list-style-type: none"> • "font_a" • "font_b" • "special_a" • "special_b"
smooth	<ul style="list-style-type: none"> • "true" / "1" • "false" / "0"
dw	<ul style="list-style-type: none"> • "true" / "1" • "false" / "0"

Attribute	Specificable Setting Value
dh	<ul style="list-style-type: none"> • "true" / "1" • "false" / "0"
width	<ul style="list-style-type: none"> • "1" to "8"
height	<ul style="list-style-type: none"> • "1" to "8"
reverse	<ul style="list-style-type: none"> • "true" / "1" • "false" / "0"
ul	<ul style="list-style-type: none"> • "true" / "1" • "false" / "0"
em	<ul style="list-style-type: none"> • "true" / "1" • "false" / "0"
color	<ul style="list-style-type: none"> • "color_1"
x	<ul style="list-style-type: none"> • "0" to "65535"
y	<ul style="list-style-type: none"> • "0" to "65535"
align	<ul style="list-style-type: none"> • "left" • "center" • "right"
rotate	<ul style="list-style-type: none"> • "true" / "1" • "false" / "0"
linespc	<ul style="list-style-type: none"> • "0" to "255"

- <feed>

Attribute	Specificable Setting Value
unit	<ul style="list-style-type: none"> • "0" to "255"
line	<ul style="list-style-type: none"> • "0" to "255"
linespc	<ul style="list-style-type: none"> • "0" to "255"
pos	<ul style="list-style-type: none"> • "cutting"

- <image>

Attribute	Specificable Setting Value
width	<ul style="list-style-type: none"> • "0" to "65535"
height	<ul style="list-style-type: none"> • "0" to "65535"
color	<ul style="list-style-type: none"> • "color_1"
align	<ul style="list-style-type: none"> • "left" • "center" • "right"

Attribute	Specificable Setting Value
mode	<ul style="list-style-type: none"> • "mono" • "gray16"

- <barcode>

Attribute	Specificable Setting Value
type	<ul style="list-style-type: none"> • "upc_a" • "upc_e" • "ean13" • "jan13" • "ean8" • "jan8" • "code39" • "itf" • "codabar" • "code93" • "code128" • "code128_auto" • "gs1_128" • "gs1_databar_omnidirectional" • "gs1_databar_truncated" • "gs1_databar_limited" • "gs1_databar_expanded"
hri	<ul style="list-style-type: none"> • "none" • "above" • "below" • "both"
font	<ul style="list-style-type: none"> • "font_a" • "font_b"
width	<ul style="list-style-type: none"> • "2" to "6"
height	<ul style="list-style-type: none"> • "1" to "255"
align	<ul style="list-style-type: none"> • "left" • "center" • "right"
rotate	<ul style="list-style-type: none"> • "true" / "1" • "false" / "0"

- <symbol>

Attribute	Specificable Setting Value
type	<ul style="list-style-type: none"> • "pdf417_standard" • "pdf417_truncated" • "qrcode_model_1" • "qrcode_model_2" • "maxicode_mode_2" • "maxicode_mode_3" • "maxicode_mode_4" • "maxicode_mode_5" • "maxicode_mode_6" • "gs1_databar_stacked" • "gs1_databar_stacked_omnidirectional" • "gs1_databar_expanded_stacked" • "azteccode_fullrange" • "azteccode_compact" • "datamatrix_square" • "datamatrix_rectangle_8" • "datamatrix_rectangle_12" • "datamatrix_rectangle_16"
level	<ul style="list-style-type: none"> • "level_0" • "level_1" (default value) • "level_2" • "level_3" • "level_4" • "level_5" • "level_6" • "level_7" • "level_8" • "level_l" • "level_m" • "level_q" • "level_h" • Integer (5 to 95) • "default"
width	-
height	-
size	-
align	<ul style="list-style-type: none"> • "left" • "center" • "right"

Attribute	Specificable Setting Value
rotate	<ul style="list-style-type: none"> • "true" / "1" • "false" / "0"

- <line>

Attribute	Specificable Setting Value
x1	• "0" to "65535"
y1	• "0" to "65535"
x2	• "0" to "65535"
y2	• "0" to "65535"
style	<ul style="list-style-type: none"> • "thin" • "medium" • "thick"

- <rectangle>

Attribute	Specificable Setting Value
x1	• "0" to "65535"
y1	• "0" to "65535"
x2	• "0" to "65535"
y2	• "0" to "65535"
style	<ul style="list-style-type: none"> • "thin" • "medium" • "thick"

- <cut>

Attribute	Specificable Setting Value
type	<ul style="list-style-type: none"> • "no_feed" • "feed"

- <sound>

Attribute	Specificable Setting Value
pattern	<ul style="list-style-type: none"> • "none" • "pattern_a" • "pattern_b" • "pattern_c" • "pattern_d" • "pattern_e" • "error" • "paper_end"

Attribute	Specificable Setting Value
repeat	<ul style="list-style-type: none"> • "1" to "255"

- <layout>

Attribute	Specificable Setting Value
type	<ul style="list-style-type: none"> • "receipt_bm"
height	<ul style="list-style-type: none"> • "0" • "254" to "2540"

Reference information

Restrictions when the waiting for paper removal function is enabled

The following controls may stop when the printer is waiting for paper removal (ERROR_WAIT_EJECT).

- Ringing control of built-in buzzer
- Ringing control of optional external buzzer
- Control of customer display
- Control of barcode scanner

Recovered when the paper has been removed and the printer is no longer waiting for paper removal.

The built-in buzzer and optional external buzzer can be caused to ring while the printer is waiting for paper removal by making the settings for ringing while waiting for paper removal in the software settings of the printer.

For details, refer to the Technical Reference Guide.

TM-m10

Printer Specifications

Item	Specification
Amount of initial feed	30 dots
Initial page mode area	420 x 2400 dots
Maximum page mode area	420 x 2400 dots
Baseline of Font A	21 dots from the top of the character
Baseline of Font B	21 dots from the top of the character
Baseline of Font C	16 dots from the top of the character

Elements for which restricted parameter setting values can be specified

PrinterControl XML

- <text>

Attribute	Specificable Setting Value
lang	<ul style="list-style-type: none"> • "en" • "de" • "fr" • "it" • "es" • "zh-hant" • "zh-tw"
font	<ul style="list-style-type: none"> • "font_a" • "font_b" • "font_c"
smooth	<ul style="list-style-type: none"> • "true" / "1" • "false" / "0"
dw	<ul style="list-style-type: none"> • "true" / "1" • "false" / "0"
dh	<ul style="list-style-type: none"> • "true" / "1" • "false" / "0"
width	<ul style="list-style-type: none"> • "1" to "8"
height	<ul style="list-style-type: none"> • "1" to "8"
reverse	<ul style="list-style-type: none"> • "true" / "1" • "false" / "0"
ul	<ul style="list-style-type: none"> • "true" / "1" • "false" / "0"

Attribute	Specificable Setting Value
em	<ul style="list-style-type: none"> • "true" / "1" • "false" / "0"
color	<ul style="list-style-type: none"> • "color_1"
x	<ul style="list-style-type: none"> • "0" to "65535"
y	<ul style="list-style-type: none"> • "0" to "65535"
align	<ul style="list-style-type: none"> • "left" • "center" • "right"
rotate	<ul style="list-style-type: none"> • "true" / "1" • "false" / "0"
linespc	<ul style="list-style-type: none"> • "0" to "255"

- <feed>

Attribute	Specificable Setting Value
unit	<ul style="list-style-type: none"> • "0" to "255"
line	<ul style="list-style-type: none"> • "0" to "255"
linespc	<ul style="list-style-type: none"> • "0" to "255"

- <image>

Attribute	Specificable Setting Value
width	<ul style="list-style-type: none"> • "0" to "65535"
height	<ul style="list-style-type: none"> • "0" to "65535"
color	<ul style="list-style-type: none"> • "color_1"
align	<ul style="list-style-type: none"> • "left" • "center" • "right"
mode	<ul style="list-style-type: none"> • "mono"

- <barcode>

Attribute	Specificable Setting Value
type	<ul style="list-style-type: none"> • "upc_a" • "upc_e" • "ean13" • "jan13" • "ean8" • "jan8" • "code39" • "itf" • "codabar" • "code93" • "code128" • "gs1_128" • "gs1_databar_omnidirectional" • "gs1_databar_truncated" • "gs1_databar_limited" • "gs1_databar_expanded"
hri	<ul style="list-style-type: none"> • "none" • "above" • "below" • "both"
font	<ul style="list-style-type: none"> • "font_a" • "font_b" • "font_c"
width	<ul style="list-style-type: none"> • "2" to "6"
height	<ul style="list-style-type: none"> • "1" to "255"
align	<ul style="list-style-type: none"> • "left" • "center" • "right"
rotate	<ul style="list-style-type: none"> • "true" / "1" • "false" / "0"

- <symbol>

Attribute	Specificable Setting Value
type	<ul style="list-style-type: none"> • "pdf417_standard" • "pdf417_truncated" • "qrcode_model_1" • "qrcode_model_2" • "maxicode_mode_2" • "maxicode_mode_3" • "maxicode_mode_4" • "maxicode_mode_5" • "maxicode_mode_6" • "gs1_databar_stacked" • "gs1_databar_stacked_omnidirectional" • "gs1_databar_expanded_stacked" • "azteccode_fullrange" • "azteccode_compact" • "datamatrix_square" • "datamatrix_rectangle_8" • "datamatrix_rectangle_12" • "datamatrix_rectangle_16"
level	<ul style="list-style-type: none"> • "level_0" • "level_1" (default value) • "level_2" • "level_3" • "level_4" • "level_5" • "level_6" • "level_7" • "level_8" • "level_l" • "level_m" • "level_q" • "level_h" • Integer (5 to 95) • "default"
width	-
height	-
size	-
align	<ul style="list-style-type: none"> • "left" • "center" • "right"

Attribute	Specificable Setting Value
rotate	<ul style="list-style-type: none"> • "true" / "1" • "false" / "0"

- <cut>

Attribute	Specificable Setting Value
type	<ul style="list-style-type: none"> • "no_feed" • "feed"

- <sound>

Attribute	Specificable Setting Value
pattern	<ul style="list-style-type: none"> • "none" • "pattern_a" • "pattern_b" • "pattern_c" • "pattern_d" • "pattern_e" • "error" • "paper_end"
repeat	<ul style="list-style-type: none"> • "1" to "255"

TM-P20

Printer Specifications

Item	Specification
Amount of initial feed	30 dots
Initial page mode area	384 x 2400 dots
Maximum page mode area	384 x 2400 dots
Baseline of Font A	21 dots from the top of the character
Baseline of Font B	21 dots from the top of the character
Baseline of Font C	16 dots from the top of the character
Baseline of Font D	21 dots from the top of the character
Baseline of Font E	15 dots from the top of the character

Elements for which restricted parameter setting values can be specified

PrinterControl XML

- <text>

Attribute	Specificable Setting Value
lang	<ul style="list-style-type: none"> • "en" • "de" • "fr" • "it" • "es" • "ko" • "ko-kr" • "zh-hans" • "zh-cn" • "zh-hant" • "zh-tw" • "th"
font	<ul style="list-style-type: none"> • "font_a" • "font_b" • "font_c" • "font_d" • "font_e" • "special_a" • "special_b"
smooth	<ul style="list-style-type: none"> • "true" / "1" • "false" / "0"

Attribute	Specificable Setting Value
dw	<ul style="list-style-type: none"> • "true" / "1" • "false" / "0"
dh	<ul style="list-style-type: none"> • "true" / "1" • "false" / "0"
width	<ul style="list-style-type: none"> • "1" to "8"
height	<ul style="list-style-type: none"> • "1" to "8"
reverse	<ul style="list-style-type: none"> • "true" / "1" • "false" / "0"
ul	<ul style="list-style-type: none"> • "true" / "1" • "false" / "0"
em	<ul style="list-style-type: none"> • "true" / "1" • "false" / "0"
color	<ul style="list-style-type: none"> • "color_1"
x	<ul style="list-style-type: none"> • "0" to "65535"
y	<ul style="list-style-type: none"> • "0" to "65535"
align	<ul style="list-style-type: none"> • "left" • "center" • "right"
rotate	<ul style="list-style-type: none"> • "true" / "1" • "false" / "0"
linespc	<ul style="list-style-type: none"> • "0" to "255"

- <feed>

Attribute	Specificable Setting Value
unit	<ul style="list-style-type: none"> • "0" to "255"
line	<ul style="list-style-type: none"> • "0" to "255"
linespc	<ul style="list-style-type: none"> • "0" to "255"
pos	<ul style="list-style-type: none"> • "cutting" • "current_tof" • "next_tof"

- <image>

Attribute	Specificable Setting Value
width	<ul style="list-style-type: none"> • "0" to "65535"
height	<ul style="list-style-type: none"> • "0" to "65535"
color	<ul style="list-style-type: none"> • "color_1"

Attribute	Specificable Setting Value
align	<ul style="list-style-type: none"> • "left" • "center" • "right"
mode	<ul style="list-style-type: none"> • "mono"

- <barcode>

Attribute	Specificable Setting Value
type	<ul style="list-style-type: none"> • "upc_a" • "upc_e" • "ean13" • "jan13" • "ean8" • "jan8" • "code39" • "itf" • "codabar" • "code93" • "code128" • "gs1_128" • "gs1_databar_omnidirectional" • "gs1_databar_truncated" • "gs1_databar_limited" • "gs1_databar_expanded"
hri	<ul style="list-style-type: none"> • "none" • "above" • "below" • "both"
font	<ul style="list-style-type: none"> • "font_a" • "font_b" • "font_c"
width	<ul style="list-style-type: none"> • "2" to "6"
height	<ul style="list-style-type: none"> • "1" to "255"
align	<ul style="list-style-type: none"> • "left" • "center" • "right"
rotate	<ul style="list-style-type: none"> • "true" / "1" • "false" / "0"

- <symbol>

Attribute	Specifiable Setting Value
type	<ul style="list-style-type: none"> • "pdf417_standard" • "pdf417_truncated" • "qrcode_model_1" • "qrcode_model_2" • "maxicode_mode_2" • "maxicode_mode_3" • "maxicode_mode_4" • "maxicode_mode_5" • "maxicode_mode_6" • "gs1_databar_stacked" • "gs1_databar_stacked_omnidirectional" • "gs1_databar_expanded_stacked" • "azteccode_fullrange" • "azteccode_compact" • "datamatrix_square" • "datamatrix_rectangle_8" • "datamatrix_rectangle_12" • "datamatrix_rectangle_16"
level	<ul style="list-style-type: none"> • "level_0" • "level_1" (default value) • "level_2" • "level_3" • "level_4" • "level_5" • "level_6" • "level_7" • "level_8" • "level_l" • "level_m" • "level_q" • "level_h" • Integer (5 to 95) • "default"
width	-
height	-
size	-
align	<ul style="list-style-type: none"> • "left" • "center" • "right"

Attribute	Specificable Setting Value
rotate	<ul style="list-style-type: none"> • "true" / "1" • "false" / "0"

- <line>

Attribute	Specificable Setting Value
x1	• "0" to "65535"
y1	• "0" to "65535"
x2	• "0" to "65535"
y2	• "0" to "65535"
style	<ul style="list-style-type: none"> • "thin" • "medium" • "thick"

- <rectangle>

Attribute	Specificable Setting Value
x1	• "0" to "65535"
y1	• "0" to "65535"
x2	• "0" to "65535"
y2	• "0" to "65535"
style	<ul style="list-style-type: none"> • "thin" • "medium" • "thick"

- <cut>

Attribute	Specificable Setting Value
type	<ul style="list-style-type: none"> • "no_feed" • "feed"

- <sound>

Attribute	Specificable Setting Value
pattern	<ul style="list-style-type: none"> • "none" • "pattern_1" • "pattern_2" • "pattern_3" • "pattern_4" • "pattern_5" • "pattern_6" • "pattern_7" • "pattern_8" • "pattern_9" • "pattern_10"
repeat	<ul style="list-style-type: none"> • "1" to "255"
cycle	<ul style="list-style-type: none"> • "1000" to "25500"

- <layout>

Attribute	Specificable Setting Value
type	<ul style="list-style-type: none"> • "receipt" • "receipt_bm"
width	<ul style="list-style-type: none"> • "290" to "600"
height	<ul style="list-style-type: none"> • "0" • "284" to "-1550"
margin-top	<ul style="list-style-type: none"> • "0" • "-150" to "1500"
margin-bottom	<ul style="list-style-type: none"> • "0"
offset-cut	<ul style="list-style-type: none"> • "0" • "-290" to "50"
offset-label	<ul style="list-style-type: none"> • "0"

TM-P60II (Receipt)

Printer Specifications

Item	Receipt Specification	Die-cut Label Specification
Amount of initial feed	30 dots	
Initial page mode area	432 x 1624 dots	400 x 1624 dots
Maximum page mode area	432 x 1624 dots	400 x 1624 dots
Baseline of Font A	21 dots from the top of the character	
Baseline of Font B	16 dots from the top of the character	
Baseline of Font C	15 dots from the top of the character	

Elements for which restricted parameter setting values can be specified

PrinterControl XML

- <text>

Attribute	Specificable Setting Value
lang	<ul style="list-style-type: none"> • "en" • "de" • "fr" • "it" • "es" • "zh-hant" • "zh-tw"
font	<ul style="list-style-type: none"> • "font_a" • "font_b" • "font_c"
smooth	<ul style="list-style-type: none"> • "true" / "1" • "false" / "0"
dw	<ul style="list-style-type: none"> • "true" / "1" • "false" / "0"
dh	<ul style="list-style-type: none"> • "true" / "1" • "false" / "0"
width	<ul style="list-style-type: none"> • "1" to "8"
height	<ul style="list-style-type: none"> • "1" to "8"
reverse	<ul style="list-style-type: none"> • "true" / "1" • "false" / "0"

Attribute	Specificable Setting Value
ul	<ul style="list-style-type: none"> • "true" / "1" • "false" / "0"
em	<ul style="list-style-type: none"> • "true" / "1" • "false" / "0"
color	<ul style="list-style-type: none"> • "color_1"
x	<ul style="list-style-type: none"> • "0" to "65535"
y	<ul style="list-style-type: none"> • "0" to "65535"
align	<ul style="list-style-type: none"> • "left" • "center" • "right"
rotate	<ul style="list-style-type: none"> • "true" / "1" • "false" / "0"
linespc	<ul style="list-style-type: none"> • "0" to "255"

- <feed>

Attribute	Specificable Setting Value
unit	<ul style="list-style-type: none"> • "0" to "255"
line	<ul style="list-style-type: none"> • "0" to "255"
linespc	<ul style="list-style-type: none"> • "0" to "255"

- <image>

Attribute	Specificable Setting Value
width	<ul style="list-style-type: none"> • "0" to "65535"
height	<ul style="list-style-type: none"> • "0" to "65535"
color	<ul style="list-style-type: none"> • "color_1"
align	<ul style="list-style-type: none"> • "left" • "center" • "right"
mode	<ul style="list-style-type: none"> • "mono"

- <barcode>

Attribute	Specificable Setting Value
type	<ul style="list-style-type: none"> • "upc_a" • "upc_e" • "ean13" • "jan13" • "ean8" • "jan8" • "code39" • "itf" • "codabar" • "code93" • "code128" • "gs1_128" • "gs1_databar_omnidirectional" • "gs1_databar_truncated" • "gs1_databar_limited" • "gs1_databar_expanded"
hri	<ul style="list-style-type: none"> • "none" • "above" • "below" • "both"
font	<ul style="list-style-type: none"> • "font_a" • "font_b" • "font_c"
width	<ul style="list-style-type: none"> • "2" to "6"
height	<ul style="list-style-type: none"> • "1" to "255"
align	<ul style="list-style-type: none"> • "left" • "center" • "right"
rotate	<ul style="list-style-type: none"> • "true" / "1" • "false" / "0"

- <symbol>

Attribute	Specifiable Setting Value
type	<ul style="list-style-type: none"> • "pdf417_standard" • "pdf417_truncated" • "qrcode_model_1" • "qrcode_model_2" • "maxicode_mode_2" • "maxicode_mode_3" • "maxicode_mode_4" • "maxicode_mode_5" • "maxicode_mode_6" • "gs1_databar_stacked" • "gs1_databar_stacked_omnidirectional" • "gs1_databar_expanded_stacked" • "azteccode_fullrange" • "azteccode_compact" • "datamatrix_square" • "datamatrix_rectangle_8" • "datamatrix_rectangle_12" • "datamatrix_rectangle_16"
level	<ul style="list-style-type: none"> • "level_0" • "level_1" (default value) • "level_2" • "level_3" • "level_4" • "level_5" • "level_6" • "level_7" • "level_8" • "level_l" • "level_m" • "level_q" • "level_h" • Integer (5 to 95) • "default"
width	-
height	-
size	-
align	<ul style="list-style-type: none"> • "left" • "center" • "right"

Attribute	Specificable Setting Value
rotate	<ul style="list-style-type: none"> • "true" / "1" • "false" / "0"

- <line>

Attribute	Specificable Setting Value
x1	• "0" to "65535"
y1	• "0" to "65535"
x2	• "0" to "65535"
y2	• "0" to "65535"
style	<ul style="list-style-type: none"> • "thin" • "medium" • "thick"

- <rectangle>

Attribute	Specificable Setting Value
x1	• "0" to "65535"
y1	• "0" to "65535"
x2	• "0" to "65535"
y2	• "0" to "65535"
style	<ul style="list-style-type: none"> • "thin" • "medium" • "thick"

- <cut>

Attribute	Specificable Setting Value
type	<ul style="list-style-type: none"> • "no_feed" • "feed"

- <sound>

Attribute	Specificable Setting Value
pattern	<ul style="list-style-type: none"> • "none" • "pattern_1" • "pattern_2" • "pattern_3" • "pattern_4" • "pattern_5" • "pattern_6" • "pattern_7" • "pattern_8" • "pattern_9" • "pattern_10"
repeat	<ul style="list-style-type: none"> • "1" to "255"
cycle	<ul style="list-style-type: none"> • "1000" to "25500"

TM-P60II (Peeler)

Printer Specifications

Item	Receipt Specification	Die-cut Label Specification
Amount of initial feed	30 dots	
Initial page mode area	432 x 1624 dots	400 x 1624 dots
Maximum page mode area	432 x 1624 dots	400 x 1624 dots
Baseline of Font A	21 dots from the top of the character	
Baseline of Font B	16 dots from the top of the character	
Baseline of Font C	15 dots from the top of the character	

Elements for which restricted parameter setting values can be specified

PrinterControl XML

- <text>

Attribute	Specificable Setting Value
lang	<ul style="list-style-type: none"> • "en" • "de" • "fr" • "it" • "es" • "zh-hant" • "zh-tw"
font	<ul style="list-style-type: none"> • "font_a" • "font_b" • "font_c"
smooth	<ul style="list-style-type: none"> • "true" / "1" • "false" / "0"
dw	<ul style="list-style-type: none"> • "true" / "1" • "false" / "0"
dh	<ul style="list-style-type: none"> • "true" / "1" • "false" / "0"
width	<ul style="list-style-type: none"> • "1" to "8"
height	<ul style="list-style-type: none"> • "1" to "8"
reverse	<ul style="list-style-type: none"> • "true" / "1" • "false" / "0"

Attribute	Specificable Setting Value
ul	<ul style="list-style-type: none"> • "true" / "1" • "false" / "0"
em	<ul style="list-style-type: none"> • "true" / "1" • "false" / "0"
color	<ul style="list-style-type: none"> • "color_1"
x	<ul style="list-style-type: none"> • "0" to "65535"
y	<ul style="list-style-type: none"> • "0" to "65535"
align	<ul style="list-style-type: none"> • "left" • "center" • "right"
rotate	<ul style="list-style-type: none"> • "true" / "1" • "false" / "0"
linespc	<ul style="list-style-type: none"> • "0" to "255"

- <image>

Attribute	Specificable Setting Value
width	<ul style="list-style-type: none"> • "0" to "65535"
height	<ul style="list-style-type: none"> • "0" to "65535"
color	<ul style="list-style-type: none"> • "color_1"
align	<ul style="list-style-type: none"> • "left" • "center" • "right"
mode	<ul style="list-style-type: none"> • "mono"

- <barcode>

Attribute	Specificable Setting Value
type	<ul style="list-style-type: none"> • "upc_a" • "upc_e" • "ean13" • "jan13" • "ean8" • "jan8" • "code39" • "itf" • "codabar" • "code93" • "code128" • "gs1_128" • "gs1_databar_omnidirectional" • "gs1_databar_truncated" • "gs1_databar_limited" • "gs1_databar_expanded"
hri	<ul style="list-style-type: none"> • "none" • "above" • "below" • "both"
font	<ul style="list-style-type: none"> • "font_a" • "font_b" • "font_c"
width	<ul style="list-style-type: none"> • "2" to "6"
height	<ul style="list-style-type: none"> • "1" to "255"
align	<ul style="list-style-type: none"> • "left" • "center" • "right"
rotate	<ul style="list-style-type: none"> • "true" / "1" • "false" / "0"

- <symbol>

Attribute	Specificable Setting Value
type	<ul style="list-style-type: none"> • "pdf417_standard" • "pdf417_truncated" • "qrcode_model_1" • "qrcode_model_2" • "maxicode_mode_2" • "maxicode_mode_3" • "maxicode_mode_4" • "maxicode_mode_5" • "maxicode_mode_6" • "gs1_databar_stacked" • "gs1_databar_stacked_omnidirectional" • "gs1_databar_expanded_stacked" • "azteccode_fullrange" • "azteccode_compact" • "datamatrix_square" • "datamatrix_rectangle_8" • "datamatrix_rectangle_12" • "datamatrix_rectangle_16"
level	<ul style="list-style-type: none"> • "level_0" • "level_1" (default value) • "level_2" • "level_3" • "level_4" • "level_5" • "level_6" • "level_7" • "level_8" • "level_l" • "level_m" • "level_q" • "level_h" • Integer (5 to 95) • "default"
width	-
height	-
size	-
align	<ul style="list-style-type: none"> • "left" • "center" • "right"

Attribute	Specificable Setting Value
rotate	<ul style="list-style-type: none"> • "true" / "1" • "false" / "0"

- <line>

Attribute	Specificable Setting Value
x1	• "0" to "65535"
y1	• "0" to "65535"
x2	• "0" to "65535"
y2	• "0" to "65535"
style	<ul style="list-style-type: none"> • "thin" • "medium" • "thick"

- <rectangle>

Attribute	Specificable Setting Value
x1	• "0" to "65535"
y1	• "0" to "65535"
x2	• "0" to "65535"
y2	• "0" to "65535"
style	<ul style="list-style-type: none"> • "thin" • "medium" • "thick"

- <cut>

Attribute	Specificable Setting Value
type	<ul style="list-style-type: none"> • "no_feed" • "feed"

- <sound>

Attribute	Specificable Setting Value
pattern	<ul style="list-style-type: none"> • "none" • "pattern_1" • "pattern_2" • "pattern_3" • "pattern_4" • "pattern_5" • "pattern_6" • "pattern_7" • "pattern_8" • "pattern_9" • "pattern_10"
repeat	<ul style="list-style-type: none"> • "1" to "255"
cycle	<ul style="list-style-type: none"> • "1000" to "25500"

- <layout>

Attribute	Specificable Setting Value
type	<ul style="list-style-type: none"> • "receipt" • "receipt_bm" • "label" • "label_bm"
width	<ul style="list-style-type: none"> • "290" to "600"
height	<ul style="list-style-type: none"> • "0" • "284" to "-1550"
margin-top	<ul style="list-style-type: none"> • "0" • "-150" to "1500" • "0" to "1500" • "-15" to "1500"
margin-bottom	<ul style="list-style-type: none"> • "0" • "-15" to "0" • "-15" to "15"
offset-cut	<ul style="list-style-type: none"> • "0" • "-290" to "50" • "0" to "50"
offset-label	<ul style="list-style-type: none"> • "0" • "0" to "15"

TM-P80**Printer Specifications**

Item	Specification
Amount of initial feed	30 dots
Initial page mode area	576 x 1662 dots
Maximum page mode area	576 x 1662 dots
Baseline of Font A	21 dots from the top of the character
Baseline of Font B	15 dots from the top of the character

Elements for which restricted parameter setting values can be specified**PrinterControl XML**

- <text>

Attribute	Specificable Setting Value
lang	<ul style="list-style-type: none"> • "en" • "de" • "fr" • "it" • "es"
font	<ul style="list-style-type: none"> • "font_a" • "font_b"
smooth	<ul style="list-style-type: none"> • "true" / "1" • "false" / "0"
dw	<ul style="list-style-type: none"> • "true" / "1" • "false" / "0"
dh	<ul style="list-style-type: none"> • "true" / "1" • "false" / "0"
width	• "1" to "8"
height	• "1" to "8"
reverse	<ul style="list-style-type: none"> • "true" / "1" • "false" / "0"
ul	<ul style="list-style-type: none"> • "true" / "1" • "false" / "0"
em	<ul style="list-style-type: none"> • "true" / "1" • "false" / "0"
color	• "color_1"

Attribute	Specificable Setting Value
x	<ul style="list-style-type: none"> • "0" to "65535"
y	<ul style="list-style-type: none"> • "0" to "65535"
align	<ul style="list-style-type: none"> • "left" • "center" • "right"
rotate	<ul style="list-style-type: none"> • "true" / "1" • "false" / "0"
linespc	<ul style="list-style-type: none"> • "0" to "255"

- <feed>

Attribute	Specificable Setting Value
unit	<ul style="list-style-type: none"> • "0" to "255"
line	<ul style="list-style-type: none"> • "0" to "255"
linespc	<ul style="list-style-type: none"> • "0" to "255"
pos	<ul style="list-style-type: none"> • "cutting" • "current_tof" • "next_tof"

- <image>

Attribute	Specificable Setting Value
width	<ul style="list-style-type: none"> • "0" to "65535"
height	<ul style="list-style-type: none"> • "0" to "65535"
color	<ul style="list-style-type: none"> • "color_1"
align	<ul style="list-style-type: none"> • "left" • "center" • "right"
mode	<ul style="list-style-type: none"> • "mono"

- <barcode>

Attribute	Specificable Setting Value
type	<ul style="list-style-type: none"> • "upc_a" • "upc_e" • "ean13" • "jan13" • "ean8" • "jan8" • "code39" • "itf" • "codabar" • "code93" • "code128" • "gs1_128" • "gs1_databar_omnidirectional" • "gs1_databar_truncated" • "gs1_databar_limited" • "gs1_databar_expanded"
hri	<ul style="list-style-type: none"> • "none" • "above" • "below" • "both"
font	<ul style="list-style-type: none"> • "font_a" • "font_b"
width	<ul style="list-style-type: none"> • "2" to "6"
height	<ul style="list-style-type: none"> • "1" to "255"
align	<ul style="list-style-type: none"> • "left" • "center" • "right"
rotate	<ul style="list-style-type: none"> • "true" / "1" • "false" / "0"

- <symbol>

Attribute	Specifiable Setting Value
type	<ul style="list-style-type: none"> • "pdf417_standard" • "pdf417_truncated" • "qrcode_model_1" • "qrcode_model_2" • "maxicode_mode_2" • "maxicode_mode_3" • "maxicode_mode_4" • "maxicode_mode_5" • "maxicode_mode_6" • "gs1_databar_stacked" • "gs1_databar_stacked_omnidirectional" • "gs1_databar_expanded_stacked" • "azteccode_fullrange" • "azteccode_compact" • "datamatrix_square" • "datamatrix_rectangle_8" • "datamatrix_rectangle_12" • "datamatrix_rectangle_16"
level	<ul style="list-style-type: none"> • "level_0" • "level_1" (default value) • "level_2" • "level_3" • "level_4" • "level_5" • "level_6" • "level_7" • "level_8" • "level_l" • "level_m" • "level_q" • "level_h" • Integer (5 to 95) • "default"
width	-
height	-
size	-
align	<ul style="list-style-type: none"> • "left" • "center" • "right"

Attribute	Specificable Setting Value
rotate	<ul style="list-style-type: none"> • "true" / "1" • "false" / "0"

- <line>

Attribute	Specificable Setting Value
x1	• "0" to "65535"
y1	• "0" to "65535"
x2	• "0" to "65535"
y2	• "0" to "65535"
style	<ul style="list-style-type: none"> • "thin" • "medium" • "thick"

- <rectangle>

Attribute	Specificable Setting Value
x1	• "0" to "65535"
y1	• "0" to "65535"
x2	• "0" to "65535"
y2	• "0" to "65535"
style	<ul style="list-style-type: none"> • "thin" • "medium" • "thick"

- <cut>

Attribute	Specificable Setting Value
type	<ul style="list-style-type: none"> • "no_feed" • "feed"

- <sound>

Attribute	Specificable Setting Value
pattern	<ul style="list-style-type: none"> • "none" • "pattern_1" • "pattern_2" • "pattern_3" • "pattern_4" • "pattern_5" • "pattern_6" • "pattern_7" • "pattern_8" • "pattern_9" • "pattern_10"
repeat	<ul style="list-style-type: none"> • "1" to "255"
cycle	<ul style="list-style-type: none"> • "1000" to "25500"

- <layout>

Attribute	Specificable Setting Value
type	<ul style="list-style-type: none"> • "receipt" • "receipt_bm"
width	<ul style="list-style-type: none"> • "290" to "600"
height	<ul style="list-style-type: none"> • "0" • "284" to "-1550"
margin-top	<ul style="list-style-type: none"> • "0" • "-150" to "1500"
margin-bottom	<ul style="list-style-type: none"> • "0"
offset-cut	<ul style="list-style-type: none"> • "0" • "-290" to "50"
offset-label	<ul style="list-style-type: none"> • "0"

TM-T20

Printer Specifications

Item	58mm Specification	80mm Specification
Amount of initial feed	30 dots	
Initial page mode area	420 x 831 dots	576 x 831 dots
Maximum page mode area	420 x 1662 dots	576 x 1662 dots
Baseline of Font A	21 dots from the top of the character	
Baseline of Font B	16 dots from the top of the character	

Elements for which restricted parameter setting values can be specified

PrinterControl XML

- <text>

Attribute	Specificable Setting Value
lang	<ul style="list-style-type: none"> • "en" • "de" • "fr" • "it" • "es"
font	<ul style="list-style-type: none"> • "font_a" • "font_b"
smooth	<ul style="list-style-type: none"> • "true" / "1" • "false" / "0"
dw	<ul style="list-style-type: none"> • "true" / "1" • "false" / "0"
dh	<ul style="list-style-type: none"> • "true" / "1" • "false" / "0"
width	<ul style="list-style-type: none"> • "1" to "8"
height	<ul style="list-style-type: none"> • "1" to "8"
reverse	<ul style="list-style-type: none"> • "true" / "1" • "false" / "0"
ul	<ul style="list-style-type: none"> • "true" / "1" • "false" / "0"
em	<ul style="list-style-type: none"> • "true" / "1" • "false" / "0"
color	<ul style="list-style-type: none"> • "color_1"

Attribute	Specificable Setting Value
x	<ul style="list-style-type: none"> • "0" to "65535"
y	<ul style="list-style-type: none"> • "0" to "65535"
align	<ul style="list-style-type: none"> • "left" • "center" • "right"
rotate	<ul style="list-style-type: none"> • "true" / "1" • "false" / "0"
linespc	<ul style="list-style-type: none"> • "0" to "255"

- <feed>

Attribute	Specificable Setting Value
unit	<ul style="list-style-type: none"> • "0" to "255"
line	<ul style="list-style-type: none"> • "0" to "255"
linespc	<ul style="list-style-type: none"> • "0" to "255"

- <image>

Attribute	Specificable Setting Value
width	<ul style="list-style-type: none"> • "0" to "65535"
height	<ul style="list-style-type: none"> • "0" to "65535"
color	<ul style="list-style-type: none"> • "color_1"
align	<ul style="list-style-type: none"> • "left" • "center" • "right"
mode	<ul style="list-style-type: none"> • "mono"

- <barcode>

Attribute	Specificable Setting Value
type	<ul style="list-style-type: none"> • "upc_a" • "upc_e" • "ean13" • "jan13" • "ean8" • "jan8" • "code39" • "itf" • "codabar" • "code93" • "code128" • "gs1_128" • "gs1_databar_omnidirectional" • "gs1_databar_truncated" • "gs1_databar_limited" • "gs1_databar_expanded"
hri	<ul style="list-style-type: none"> • "none" • "above" • "below" • "both"
font	<ul style="list-style-type: none"> • "font_a" • "font_b"
width	<ul style="list-style-type: none"> • "2" to "6"
height	<ul style="list-style-type: none"> • "1" to "255"
align	<ul style="list-style-type: none"> • "left" • "center" • "right"
rotate	<ul style="list-style-type: none"> • "true" / "1" • "false" / "0"

- <symbol>

Attribute	Specificable Setting Value
type	<ul style="list-style-type: none"> • "pdf417_standard" • "pdf417_truncated" • "qrcode_model_1" • "qrcode_model_2" • "maxicode_mode_2" • "maxicode_mode_3" • "maxicode_mode_4" • "maxicode_mode_5" • "maxicode_mode_6" • "gs1_databar_stacked" • "gs1_databar_stacked_omnidirectional" • "gs1_databar_expanded_stacked"
level	<ul style="list-style-type: none"> • "level_0" • "level_1" (default value) • "level_2" • "level_3" • "level_4" • "level_5" • "level_6" • "level_7" • "level_8" • "level_l" • "level_m" • "level_q" • "level_h" • "default"
width	-
height	-
size	-
align	<ul style="list-style-type: none"> • "left" • "center" • "right"
rotate	<ul style="list-style-type: none"> • "true" / "1" • "false" / "0"

- <cut>

Attribute	Specificable Setting Value
type	<ul style="list-style-type: none"> • "no_feed" • "feed"

- <sound>

Attribute	Specificable Setting Value
pattern	<ul style="list-style-type: none">• "none"• "pattern_a"• "pattern_b"• "pattern_c"• "pattern_d"• "pattern_e"• "error"• "paper_end"
repeat	<ul style="list-style-type: none">• "1" to "255"

TM-T20II

Printer Specifications

Item	58mm Specification	80mm Specification
Amount of initial feed	30 dots	
Initial page mode area	420 x 831 dots	576 x 831 dots
Maximum page mode area	420 x 1662 dots	576 x 1662 dots
Baseline of Font A	21 dots from the top of the character	
Baseline of Font B	16 dots from the top of the character	

Elements for which restricted parameter setting values can be specified

PrinterControl XML

- <text>

Attribute	Specifiable Setting Value
lang	<ul style="list-style-type: none"> • "en" • "de" • "fr" • "it" • "es"
font	<ul style="list-style-type: none"> • "font_a" • "font_b"
smooth	<ul style="list-style-type: none"> • "true" / "1" • "false" / "0"
dw	<ul style="list-style-type: none"> • "true" / "1" • "false" / "0"
dh	<ul style="list-style-type: none"> • "true" / "1" • "false" / "0"
width	• "1" to "8"
height	• "1" to "8"
reverse	<ul style="list-style-type: none"> • "true" / "1" • "false" / "0"
ul	<ul style="list-style-type: none"> • "true" / "1" • "false" / "0"
em	<ul style="list-style-type: none"> • "true" / "1" • "false" / "0"
color	• "color_1"

Attribute	Specificable Setting Value
x	<ul style="list-style-type: none"> • "0" to "65535"
y	<ul style="list-style-type: none"> • "0" to "65535"
align	<ul style="list-style-type: none"> • "left" • "center" • "right"
rotate	<ul style="list-style-type: none"> • "true" / "1" • "false" / "0"
linespc	<ul style="list-style-type: none"> • "0" to "255"

- <feed>

Attribute	Specificable Setting Value
unit	<ul style="list-style-type: none"> • "0" to "255"
line	<ul style="list-style-type: none"> • "0" to "255"
linespc	<ul style="list-style-type: none"> • "0" to "255"

- <image>

Attribute	Specificable Setting Value
width	<ul style="list-style-type: none"> • "0" to "65535"
height	<ul style="list-style-type: none"> • "0" to "65535"
color	<ul style="list-style-type: none"> • "color_1"
align	<ul style="list-style-type: none"> • "left" • "center" • "right"
mode	<ul style="list-style-type: none"> • "mono"

- <barcode>

Attribute	Specificable Setting Value
type	<ul style="list-style-type: none"> • "upc_a" • "upc_e" • "ean13" • "jan13" • "ean8" • "jan8" • "code39" • "itf" • "codabar" • "code93" • "code128" • "gs1_128" • "gs1_databar_omnidirectional" • "gs1_databar_truncated" • "gs1_databar_limited" • "gs1_databar_expanded"
hri	<ul style="list-style-type: none"> • "none" • "above" • "below" • "both"
font	<ul style="list-style-type: none"> • "font_a" • "font_b"
width	<ul style="list-style-type: none"> • "2" to "6"
height	<ul style="list-style-type: none"> • "1" to "255"
align	<ul style="list-style-type: none"> • "left" • "center" • "right"
rotate	<ul style="list-style-type: none"> • "true" / "1" • "false" / "0"

• <symbol>

Attribute	Specificable Setting Value
type	<ul style="list-style-type: none"> • "pdf417_standard" • "pdf417_truncated" • "qrcode_model_1" • "qrcode_model_2" • "maxicode_mode_2" • "maxicode_mode_3" • "maxicode_mode_4" • "maxicode_mode_5" • "maxicode_mode_6" • "gs1_databar_stacked" • "gs1_databar_stacked_omnidirectional" • "gs1_databar_expanded_stacked"
level	<ul style="list-style-type: none"> • "level_0" • "level_1" (default value) • "level_2" • "level_3" • "level_4" • "level_5" • "level_6" • "level_7" • "level_8" • "level_l" • "level_m" • "level_q" • "level_h" • "default"
width	-
height	-
size	-
align	<ul style="list-style-type: none"> • "left" • "center" • "right"
rotate	<ul style="list-style-type: none"> • "true" / "1" • "false" / "0"

• <cut>

Attribute	Specificable Setting Value
type	<ul style="list-style-type: none"> • "no_feed" • "feed"

- <sound>

Attribute	Specificable Setting Value
pattern	<ul style="list-style-type: none">• "none"• "pattern_a"• "pattern_b"• "pattern_c"• "pattern_d"• "pattern_e"• "error"• "paper_end"
repeat	<ul style="list-style-type: none">• "1" to "255"

TM-T70

Printer Specifications

Item		58mm Specification	80mm Specification
Amount of initial feed		30 dots	
Initial page mode area	ANK model	416 x 1662 dots	512 x 831 dots
	Multiple languages model	416 x 1662 dots	576 x 1662 dots
Maximum page mode area	ANK model	416 x 1662 dots	512 x 1662 dots
	Multiple languages model	576 x 1662 dots	
Baseline of Font A		21 dots from the top of the character	
Baseline of Font B		16 dots from the top of the character	

Elements for which restricted parameter setting values can be specified

PrinterControl XML

- <text>

Attribute	Specificable Setting Value
lang	<ul style="list-style-type: none"> • "en" • "de" • "fr" • "it" • "es" • "ko" • "ko-kr" • "zh-hans" • "zh-cn" • "zh-hant" • "zh-tw"
font	<ul style="list-style-type: none"> • "font_a" • "font_b"
smooth	<ul style="list-style-type: none"> • "true" / "1" • "false" / "0"
dw	<ul style="list-style-type: none"> • "true" / "1" • "false" / "0"
dh	<ul style="list-style-type: none"> • "true" / "1" • "false" / "0"
width	<ul style="list-style-type: none"> • "1" to "8"

Attribute	Specificable Setting Value
height	<ul style="list-style-type: none"> • "1" to "8"
reverse	<ul style="list-style-type: none"> • "true" / "1" • "false" / "0"
ul	<ul style="list-style-type: none"> • "true" / "1" • "false" / "0"
em	<ul style="list-style-type: none"> • "true" / "1" • "false" / "0"
color	<ul style="list-style-type: none"> • "color_1"
x	<ul style="list-style-type: none"> • "0" to "65535"
y	<ul style="list-style-type: none"> • "0" to "65535"
align	<ul style="list-style-type: none"> • "left" • "center" • "right"
rotate	<ul style="list-style-type: none"> • "true" / "1" • "false" / "0"
linespc	<ul style="list-style-type: none"> • "0" to "255"

- <feed>

Attribute	Specificable Setting Value
unit	<ul style="list-style-type: none"> • "0" to "255"
line	<ul style="list-style-type: none"> • "0" to "255"
linespc	<ul style="list-style-type: none"> • "0" to "255"

- <image>

Attribute	Specificable Setting Value
width	<ul style="list-style-type: none"> • "0" to "65535"
height	<ul style="list-style-type: none"> • "0" to "65535"
color	<ul style="list-style-type: none"> • "color_1"
align	<ul style="list-style-type: none"> • "left" • "center" • "right"
mode	<ul style="list-style-type: none"> • "mono"

- <barcode>

Attribute	Specificable Setting Value
type	<ul style="list-style-type: none"> • "upc_a" • "upc_e" • "ean13" • "jan13" • "ean8" • "jan8" • "code39" • "itf" • "codabar" • "code93" • "code128"
hri	<ul style="list-style-type: none"> • "none" • "above" • "below" • "both"
font	<ul style="list-style-type: none"> • "font_a" • "font_b"
width	<ul style="list-style-type: none"> • "2" to "6"
height	<ul style="list-style-type: none"> • "1" to "255"
align	<ul style="list-style-type: none"> • "left" • "center" • "right"
rotate	<ul style="list-style-type: none"> • "true" / "1" • "false" / "0"

- <symbol>

Attribute	Specificable Setting Value
type	<ul style="list-style-type: none"> • "pdf417_standard" • "pdf417_truncated" • "qrcode_model_1" • "qrcode_model_2"

Attribute	Specificable Setting Value
level	<ul style="list-style-type: none"> • "level_0" • "level_1" (default value) • "level_2" • "level_3" • "level_4" • "level_5" • "level_6" • "level_7" • "level_8" • "level_l" • "level_m" • "level_q" • "level_h" • "default"
width	-
height	-
size	-
align	<ul style="list-style-type: none"> • "left" • "center" • "right"
rotate	<ul style="list-style-type: none"> • "true" / "1" • "false" / "0"

- <cut>

Attribute	Specificable Setting Value
type	<ul style="list-style-type: none"> • "no_feed" • "feed"

TM-T70II

Printer Specifications

Item		58mm Specification	80mm Specification
Amount of initial feed		30 dots	
Initial page mode area	ANK model	416 x 1662 dots	512 x 1662 dots
	Multiple languages model	416 x 1662 dots	576 x 1662 dots
Maximum page mode area	ANK model	416 x 1662 dots	512 x 1662 dots
	Multiple languages model	576 x 1662 dots	
Baseline of Font A		21 dots from the top of the character	
Baseline of Font B		16 dots from the top of the character	

Elements for which restricted parameter setting values can be specified

PrinterControl XML

- <text>

Attribute	Specificable Setting Value
lang	<ul style="list-style-type: none"> • "en" • "de" • "fr" • "it" • "es" • "ko" • "ko-kr" • "zh-hans" • "zh-cn" • "zh-hant" • "zh-tw" • "th"
font	<ul style="list-style-type: none"> • "font_a" • "font_b" • "special_a" • "special_b"
smooth	<ul style="list-style-type: none"> • "true" / "1" • "false" / "0"
dw	<ul style="list-style-type: none"> • "true" / "1" • "false" / "0"

Attribute	Specificable Setting Value
dh	<ul style="list-style-type: none"> • "true" / "1" • "false" / "0"
width	<ul style="list-style-type: none"> • "1" to "8"
height	<ul style="list-style-type: none"> • "1" to "8"
reverse	<ul style="list-style-type: none"> • "true" / "1" • "false" / "0"
ul	<ul style="list-style-type: none"> • "true" / "1" • "false" / "0"
em	<ul style="list-style-type: none"> • "true" / "1" • "false" / "0"
color	<ul style="list-style-type: none"> • "color_1"
x	<ul style="list-style-type: none"> • "0" to "65535"
y	<ul style="list-style-type: none"> • "0" to "65535"
align	<ul style="list-style-type: none"> • "left" • "center" • "right"
rotate	<ul style="list-style-type: none"> • "true" / "1" • "false" / "0"
linespc	<ul style="list-style-type: none"> • "0" to "255"

- <feed>

Attribute	Specificable Setting Value
unit	<ul style="list-style-type: none"> • "0" to "255"
line	<ul style="list-style-type: none"> • "0" to "255"
linespc	<ul style="list-style-type: none"> • "0" to "255"

- <image>

Attribute	Specificable Setting Value
width	<ul style="list-style-type: none"> • "0" to "65535"
height	<ul style="list-style-type: none"> • "0" to "65535"
color	<ul style="list-style-type: none"> • "color_1"
align	<ul style="list-style-type: none"> • "left" • "center" • "right"
mode	<ul style="list-style-type: none"> • "mono" • "gray16"

- <barcode>

Attribute	Specificable Setting Value
type	<ul style="list-style-type: none"> • "upc_a" • "upc_e" • "ean13" • "jan13" • "ean8" • "jan8" • "code39" • "itf" • "codabar" • "code93" • "code128" • "gs1_128" • "gs1_databar_omnidirectional" • "gs1_databar_truncated" • "gs1_databar_limited" • "gs1_databar_expanded"
hri	<ul style="list-style-type: none"> • "none" • "above" • "below" • "both"
font	<ul style="list-style-type: none"> • "font_a" • "font_b"
width	<ul style="list-style-type: none"> • "2" to "6"
height	<ul style="list-style-type: none"> • "1" to "255"
align	<ul style="list-style-type: none"> • "left" • "center" • "right"
rotate	<ul style="list-style-type: none"> • "true" / "1" • "false" / "0"

- <symbol>

Attribute	Specificable Setting Value
type	<ul style="list-style-type: none"> • "pdf417_standard" • "pdf417_truncated" • "qrcode_model_1" • "qrcode_model_2" • "maxicode_mode_2" • "maxicode_mode_3" • "maxicode_mode_4" • "maxicode_mode_5" • "maxicode_mode_6" • "gs1_databar_stacked" • "gs1_databar_stacked_omnidirectional" • "gs1_databar_expanded_stacked"
level	<ul style="list-style-type: none"> • "level_0" • "level_1" (default value) • "level_2" • "level_3" • "level_4" • "level_5" • "level_6" • "level_7" • "level_8" • "level_l" • "level_m" • "level_q" • "level_h" • "default"
width	-
height	-
size	-
align	<ul style="list-style-type: none"> • "left" • "center" • "right"
rotate	<ul style="list-style-type: none"> • "true" / "1" • "false" / "0"

- <cut>

Attribute	Specificable Setting Value
type	<ul style="list-style-type: none"> • "no_feed" • "feed"

- <sound>

Attribute	Specificable Setting Value
pattern	<ul style="list-style-type: none">• "none"• "pattern_a"• "pattern_b"• "pattern_c"• "pattern_d"• "pattern_e"• "error"• "paper_end"
repeat	<ul style="list-style-type: none">• "1" to "255"

TM-T82II

Printer Specifications

Item	Specification
Amount of initial feed	30 dots
Initial page mode area	576 x 831 dots
Maximum page mode area	576 x 1662 dots
Baseline of Font A	21 dots from the top of the character
Baseline of Font B	16 dots from the top of the character

Elements for which restricted parameter setting values can be specified

PrinterControl XML

- <text>

Attribute	Specificable Setting Value
lang	<ul style="list-style-type: none"> • "en" • "de" • "fr" • "it" • "es" • "zh-hans" • "zh-cn" • "zh-hant" • "zh-tw" • "th"
font	<ul style="list-style-type: none"> • "font_a" • "font_b" • "special_a" • "special_b"
smooth	<ul style="list-style-type: none"> • "true" / "1" • "false" / "0"
dw	<ul style="list-style-type: none"> • "true" / "1" • "false" / "0"
dh	<ul style="list-style-type: none"> • "true" / "1" • "false" / "0"
width	<ul style="list-style-type: none"> • "1" to "8"
height	<ul style="list-style-type: none"> • "1" to "8"

Attribute	Specificable Setting Value
reverse	<ul style="list-style-type: none"> • "true" / "1" • "false" / "0"
ul	<ul style="list-style-type: none"> • "true" / "1" • "false" / "0"
em	<ul style="list-style-type: none"> • "true" / "1" • "false" / "0"
color	<ul style="list-style-type: none"> • "color_1"
x	<ul style="list-style-type: none"> • "0" to "65535"
y	<ul style="list-style-type: none"> • "0" to "65535"
align	<ul style="list-style-type: none"> • "left" • "center" • "right"
rotate	<ul style="list-style-type: none"> • "true" / "1" • "false" / "0"
linespc	<ul style="list-style-type: none"> • "0" to "255"

- <feed>

Attribute	Specificable Setting Value
unit	<ul style="list-style-type: none"> • "0" to "255"
line	<ul style="list-style-type: none"> • "0" to "255"
linespc	<ul style="list-style-type: none"> • "0" to "255"

- <image>

Attribute	Specificable Setting Value
width	<ul style="list-style-type: none"> • "0" to "65535"
height	<ul style="list-style-type: none"> • "0" to "65535"
color	<ul style="list-style-type: none"> • "color_1"
align	<ul style="list-style-type: none"> • "left" • "center" • "right"
mode	<ul style="list-style-type: none"> • "mono"

- <barcode>

Attribute	Specificable Setting Value
type	<ul style="list-style-type: none"> • "upc_a" • "upc_e" • "ean13" • "jan13" • "ean8" • "jan8" • "code39" • "itf" • "codabar" • "code93" • "code128" • "gs1_128" • "gs1_databar_omnidirectional" • "gs1_databar_truncated" • "gs1_databar_limited" • "gs1_databar_expanded"
hri	<ul style="list-style-type: none"> • "none" • "above" • "below" • "both"
font	<ul style="list-style-type: none"> • "font_a" • "font_b"
width	<ul style="list-style-type: none"> • "2" to "6"
height	<ul style="list-style-type: none"> • "1" to "255"
align	<ul style="list-style-type: none"> • "left" • "center" • "right"
rotate	<ul style="list-style-type: none"> • "true" / "1" • "false" / "0"

- <symbol>

Attribute	Specificable Setting Value
type	<ul style="list-style-type: none"> • "pdf417_standard" • "pdf417_truncated" • "qrcode_model_1" • "qrcode_model_2" • "maxicode_mode_2" • "maxicode_mode_3" • "maxicode_mode_4" • "maxicode_mode_5" • "maxicode_mode_6" • "gs1_databar_stacked" • "gs1_databar_stacked_omnidirectional" • "gs1_databar_expanded_stacked"
level	<ul style="list-style-type: none"> • "level_0" • "level_1" (default value) • "level_2" • "level_3" • "level_4" • "level_5" • "level_6" • "level_7" • "level_8" • "level_l" • "level_m" • "level_q" • "level_h" • "default"
width	-
height	-
size	-
align	<ul style="list-style-type: none"> • "left" • "center" • "right"
rotate	<ul style="list-style-type: none"> • "true" / "1" • "false" / "0"

- <cut>

Attribute	Specificable Setting Value
type	<ul style="list-style-type: none"> • "no_feed" • "feed"

- <sound>

Attribute	Specificable Setting Value
pattern	<ul style="list-style-type: none">• "none"• "pattern_a"• "pattern_b"• "pattern_c"• "pattern_d"• "pattern_e"• "error"• "paper_end"
repeat	<ul style="list-style-type: none">• "1" to "255"

TM-T83II

Printer Specifications

Item	Specification
Amount of initial feed	30 dots
Initial page mode area	512 x 1662 dots
Maximum page mode area	512 x 1662 dots
Baseline of Font A	21 dots from the top of the character
Baseline of Font B	16 dots from the top of the character

Elements for which restricted parameter setting values can be specified

PrinterControl XML

- <text>

Attribute	Specificable Setting Value
lang	<ul style="list-style-type: none"> • "en" • "de" • "fr" • "it" • "es" • "ko" • "ko-kr"
font	<ul style="list-style-type: none"> • "font_a" • "font_b"
smooth	<ul style="list-style-type: none"> • "true" / "1" • "false" / "0"
dw	<ul style="list-style-type: none"> • "true" / "1" • "false" / "0"
dh	<ul style="list-style-type: none"> • "true" / "1" • "false" / "0"
width	<ul style="list-style-type: none"> • "1" to "8"
height	<ul style="list-style-type: none"> • "1" to "8"
reverse	<ul style="list-style-type: none"> • "true" / "1" • "false" / "0"
ul	<ul style="list-style-type: none"> • "true" / "1" • "false" / "0"
em	<ul style="list-style-type: none"> • "true" / "1" • "false" / "0"

Attribute	Specificable Setting Value
color	• "color_1"
x	• "0" to "65535"
y	• "0" to "65535"
align	• "left" • "center" • "right"
rotate	• "true" / "1" • "false" / "0"
linespc	• "0" to "255"

- <feed>

Attribute	Specificable Setting Value
unit	• "0" to "255"
line	• "0" to "255"
linespc	• "0" to "255"

- <image>

Attribute	Specificable Setting Value
width	• "0" to "65535"
height	• "0" to "65535"
color	• "color_1"
align	• "left" • "center" • "right"
mode	• "mono"

- <barcode>

Attribute	Specificable Setting Value
type	<ul style="list-style-type: none"> • "upc_a" • "upc_e" • "ean13" • "jan13" • "ean8" • "jan8" • "code39" • "itf" • "codabar" • "code93" • "code128" • "gs1_128" • "gs1_databar_omnidirectional" • "gs1_databar_truncated" • "gs1_databar_limited" • "gs1_databar_expanded"
hri	<ul style="list-style-type: none"> • "none" • "above" • "below" • "both"
font	<ul style="list-style-type: none"> • "font_a" • "font_b"
width	<ul style="list-style-type: none"> • "2" to "6"
height	<ul style="list-style-type: none"> • "1" to "255"
align	<ul style="list-style-type: none"> • "left" • "center" • "right"
rotate	<ul style="list-style-type: none"> • "true" / "1" • "false" / "0"

- <symbol>

Attribute	Specificable Setting Value
type	<ul style="list-style-type: none"> • "pdf417_standard" • "pdf417_truncated" • "qrcode_model_1" • "qrcode_model_2"

Attribute	Specificable Setting Value
level	<ul style="list-style-type: none"> • "level_0" • "level_1" (default value) • "level_2" • "level_3" • "level_4" • "level_5" • "level_6" • "level_7" • "level_8" • "level_l" • "level_m" • "level_q" • "level_h" • "default"
width	-
height	-
size	-
align	<ul style="list-style-type: none"> • "left" • "center" • "right"
rotate	<ul style="list-style-type: none"> • "true" / "1" • "false" / "0"

- <cut>

Attribute	Specificable Setting Value
type	<ul style="list-style-type: none"> • "no_feed" • "feed"

- <sound>

Attribute	Specificable Setting Value
pattern	<ul style="list-style-type: none"> • "none" • "pattern_a" • "pattern_b" • "pattern_c" • "pattern_d" • "pattern_e" • "error" • "paper_end"
repeat	<ul style="list-style-type: none"> • "1" to "255"

TM-T88IV

Printer Specifications

Item		58mm Specification	80mm Specification
Amount of initial feed		30 dots	
Initial page mode area	Monochrome printing	360 x 831 dots	512 x 831 dots
	Two-color printing	360 x 415 dots	512 x 415 dots
Maximum page mode area	Monochrome printing	360 x 1662 dots	512 x 1662 dots
	Two-color printing	360 x 831 dots	512 x 831 dots
Baseline of Font A		21 dots from the top of the character	
Baseline of Font B		16 dots from the top of the character	

Elements for which restricted parameter setting values can be specified

PrinterControl XML

- <text>

Attribute	Specificable Setting Value
lang	<ul style="list-style-type: none"> • "en" • "de" • "fr" • "it" • "es" • "ko" • "ko-kr" • "zh-hans" • "zh-cn" • "zh-hant" • "zh-tw"
font	<ul style="list-style-type: none"> • "font_a" • "font_b"
smooth	<ul style="list-style-type: none"> • "true" / "1" • "false" / "0"
dw	<ul style="list-style-type: none"> • "true" / "1" • "false" / "0"
dh	<ul style="list-style-type: none"> • "true" / "1" • "false" / "0"
width	<ul style="list-style-type: none"> • "1" to "8"

Attribute	Specificable Setting Value
height	<ul style="list-style-type: none"> • "1" to "8"
reverse	<ul style="list-style-type: none"> • "true" / "1" • "false" / "0"
ul	<ul style="list-style-type: none"> • "true" / "1" • "false" / "0"
em	<ul style="list-style-type: none"> • "true" / "1" • "false" / "0"
color	<ul style="list-style-type: none"> • "color_1" • "color_2"
x	<ul style="list-style-type: none"> • "0" to "65535"
y	<ul style="list-style-type: none"> • "0" to "65535"
align	<ul style="list-style-type: none"> • "left" • "center" • "right"
rotate	<ul style="list-style-type: none"> • "true" / "1" • "false" / "0"
linespc	<ul style="list-style-type: none"> • "0" to "255"

- <feed>

Attribute	Specificable Setting Value
unit	<ul style="list-style-type: none"> • "0" to "255"
line	<ul style="list-style-type: none"> • "0" to "255"
linespc	<ul style="list-style-type: none"> • "0" to "255"

- <image>

Attribute	Specificable Setting Value
width	<ul style="list-style-type: none"> • "0" to "65535"
height	<ul style="list-style-type: none"> • "0" to "65535"
color	<ul style="list-style-type: none"> • "color_1" • "color_2"
align	<ul style="list-style-type: none"> • "left" • "center" • "right"
mode	<ul style="list-style-type: none"> • "mono"

- <barcode>

Attribute	Specificable Setting Value
type	<ul style="list-style-type: none"> • "upc_a" • "upc_e" • "ean13" • "jan13" • "ean8" • "jan8" • "code39" • "itf" • "codabar" • "code93" • "code128"
hri	<ul style="list-style-type: none"> • "none" • "above" • "below" • "both"
font	<ul style="list-style-type: none"> • "font_a" • "font_b"
width	<ul style="list-style-type: none"> • "2" to "6"
height	<ul style="list-style-type: none"> • "1" to "255"
align	<ul style="list-style-type: none"> • "left" • "center" • "right"
rotate	<ul style="list-style-type: none"> • "true" / "1" • "false" / "0"

- <symbol>

Attribute	Specificable Setting Value
type	<ul style="list-style-type: none"> • "pdf417_standard" • "pdf417_truncated" • "qrcode_model_1" • "qrcode_model_2" • "maxicode_mode_2" • "maxicode_mode_3" • "maxicode_mode_4" • "maxicode_mode_5" • "maxicode_mode_6" • "gs1_databar_stacked" • "gs1_databar_stacked_omnidirectional" • "gs1_databar_expanded_stacked"

Attribute	Specificable Setting Value
level	<ul style="list-style-type: none"> • "level_0" • "level_1" (default value) • "level_2" • "level_3" • "level_4" • "level_5" • "level_6" • "level_7" • "level_8" • "level_l" • "level_m" • "level_q" • "level_h" • "default"
width	-
height	-
size	-
align	<ul style="list-style-type: none"> • "left" • "center" • "right"
rotate	<ul style="list-style-type: none"> • "true" / "1" • "false" / "0"

- <cut>

Attribute	Specificable Setting Value
type	<ul style="list-style-type: none"> • "no_feed" • "feed"

TM-T88V

Printer Specifications

Item		58mm Specification	80mm Specification
Amount of initial feed		30 dots	
Initial page mode area		360 x 831 dots	512 x 831 dots
Maximum page mode area		360 x 1662 dots	512 x 1662 dots
Baseline of Font A		21 dots from the top of the character	
Baseline of Font B	ANK	16 dots from the top of the character	
	Chinese characters	15 dots from the top of the character	

Elements for which restricted parameter setting values can be specified

PrinterControl XML

- <text>

Attribute	Specificable Setting Value
lang	<ul style="list-style-type: none"> • "en" • "de" • "fr" • "it" • "es" • "ko" • "ko-kr" • "zh-hans" • "zh-cn" • "zh-hant" • "zh-tw"
font	<ul style="list-style-type: none"> • "font_a" • "font_b"
smooth	<ul style="list-style-type: none"> • "true" / "1" • "false" / "0"
dw	<ul style="list-style-type: none"> • "true" / "1" • "false" / "0"
dh	<ul style="list-style-type: none"> • "true" / "1" • "false" / "0"
width	<ul style="list-style-type: none"> • "1" to "8"
height	<ul style="list-style-type: none"> • "1" to "8"

Attribute	Specificable Setting Value
reverse	<ul style="list-style-type: none"> • "true" / "1" • "false" / "0"
ul	<ul style="list-style-type: none"> • "true" / "1" • "false" / "0"
em	<ul style="list-style-type: none"> • "true" / "1" • "false" / "0"
color	<ul style="list-style-type: none"> • "color_1"
x	<ul style="list-style-type: none"> • "0" to "65535"
y	<ul style="list-style-type: none"> • "0" to "65535"
align	<ul style="list-style-type: none"> • "left" • "center" • "right"
rotate	<ul style="list-style-type: none"> • "true" / "1" • "false" / "0"
linespc	<ul style="list-style-type: none"> • "0" to "255"

- <feed>

Attribute	Specificable Setting Value
unit	<ul style="list-style-type: none"> • "0" to "255"
line	<ul style="list-style-type: none"> • "0" to "255"
linespc	<ul style="list-style-type: none"> • "0" to "255"

- <image>

Attribute	Specificable Setting Value
width	<ul style="list-style-type: none"> • "0" to "65535"
height	<ul style="list-style-type: none"> • "0" to "65535"
color	<ul style="list-style-type: none"> • "color_1"
align	<ul style="list-style-type: none"> • "left" • "center" • "right"
mode	<ul style="list-style-type: none"> • "mono" • "gray16"

- <barcode>

Attribute	Specificable Setting Value
type	<ul style="list-style-type: none"> • "upc_a" • "upc_e" • "ean13" • "jan13" • "ean8" • "jan8" • "code39" • "itf" • "codabar" • "code93" • "code128" • "gs1_128" • "gs1_databar_omnidirectional" • "gs1_databar_truncated" • "gs1_databar_limited" • "gs1_databar_expanded"
hri	<ul style="list-style-type: none"> • "none" • "above" • "below" • "both"
font	<ul style="list-style-type: none"> • "font_a" • "font_b"
width	<ul style="list-style-type: none"> • "2" to "6"
height	<ul style="list-style-type: none"> • "1" to "255"
align	<ul style="list-style-type: none"> • "left" • "center" • "right"
rotate	<ul style="list-style-type: none"> • "true" / "1" • "false" / "0"

- <symbol>

Attribute	Specificable Setting Value
type	<ul style="list-style-type: none"> • "pdf417_standard" • "pdf417_truncated" • "qrcode_model_1" • "qrcode_model_2" • "maxicode_mode_2" • "maxicode_mode_3" • "maxicode_mode_4" • "maxicode_mode_5" • "maxicode_mode_6" • "gs1_databar_stacked" • "gs1_databar_stacked_omnidirectional" • "gs1_databar_expanded_stacked"
level	<ul style="list-style-type: none"> • "level_0" • "level_1" (default value) • "level_2" • "level_3" • "level_4" • "level_5" • "level_6" • "level_7" • "level_8" • "level_l" • "level_m" • "level_q" • "level_h" • "default"
width	-
height	-
size	-
align	<ul style="list-style-type: none"> • "left" • "center" • "right"
rotate	<ul style="list-style-type: none"> • "true" / "1" • "false" / "0"

- <cut>

Attribute	Specificable Setting Value
type	<ul style="list-style-type: none"> • "no_feed" • "feed"

• <sound>

Attribute	Specificable Setting Value
pattern	<ul style="list-style-type: none">• "none"• "pattern_a"• "pattern_b"• "pattern_c"• "pattern_d"• "pattern_e"• "error"• "paper_end"
repeat	<ul style="list-style-type: none">• "1" to "255"

TM-T90

Printer Specifications

Item		58mm Specification	60mm Specification	80mm Specification
Amount of initial feed		30 dots		
Initial page mode area	Monochrome printing	420 x 738 dots	384 x 831 dots	576 x 738 dots
	Two-color printing	420 x 369 dots	384 x 415 dots	576 x 369 dots
Maximum page mode area	Monochrome printing	420 x 1476 dots	384 x 1662 dots	576 x 1476 dots
	Two-color printing	420 x 738 dots	384 x 831 dots	576 x 738 dots
Baseline of Font A		21 dots from the top of the character		
Baseline of Font B		16 dots from the top of the character		

Elements for which restricted parameter setting values can be specified**PrinterControl XML**

- <text>

Attribute	Specificable Setting Value
lang	<ul style="list-style-type: none"> • "en" • "de" • "fr" • "it" • "es" • "ko" • "ko-kr" • "zh-hans" • "zh-cn" • "zh-hant" • "zh-tw"
font	<ul style="list-style-type: none"> • "font_a" • "font_b" • "font_c"
smooth	<ul style="list-style-type: none"> • "true" / "1" • "false" / "0"
dw	<ul style="list-style-type: none"> • "true" / "1" • "false" / "0"

Attribute	Specificable Setting Value
dh	<ul style="list-style-type: none"> • "true" / "1" • "false" / "0"
width	<ul style="list-style-type: none"> • "1" to "8"
height	<ul style="list-style-type: none"> • "1" to "8"
reverse	<ul style="list-style-type: none"> • "true" / "1" • "false" / "0"
ul	<ul style="list-style-type: none"> • "true" / "1" • "false" / "0"
em	<ul style="list-style-type: none"> • "true" / "1" • "false" / "0"
color	<ul style="list-style-type: none"> • "color_1" • "color_2"
x	<ul style="list-style-type: none"> • "0" to "65535"
y	<ul style="list-style-type: none"> • "0" to "65535"
align	<ul style="list-style-type: none"> • "left" • "center" • "right"
rotate	<ul style="list-style-type: none"> • "true" / "1" • "false" / "0"
linespc	<ul style="list-style-type: none"> • "0" to "255"

- <feed>

Attribute	Specificable Setting Value
unit	<ul style="list-style-type: none"> • "0" to "255"
line	<ul style="list-style-type: none"> • "0" to "255"
linespc	<ul style="list-style-type: none"> • "0" to "255"

- <image>

Attribute	Specificable Setting Value
width	<ul style="list-style-type: none"> • "0" to "65535"
height	<ul style="list-style-type: none"> • "0" to "65535"
color	<ul style="list-style-type: none"> • "color_1" • "color_2"
align	<ul style="list-style-type: none"> • "left" • "center" • "right"

Attribute	Specificable Setting Value
mode	<ul style="list-style-type: none"> • "mono"

- <barcode>

Attribute	Specificable Setting Value
type	<ul style="list-style-type: none"> • "upc_a" • "upc_e" • "ean13" • "jan13" • "ean8" • "jan8" • "code39" • "itf" • "codabar" • "code93" • "code128"
hri	<ul style="list-style-type: none"> • "none" • "above" • "below" • "both"
font	<ul style="list-style-type: none"> • "font_a" • "font_b" • "font_c"
width	<ul style="list-style-type: none"> • "2" to "6"
height	<ul style="list-style-type: none"> • "1" to "255"
align	<ul style="list-style-type: none"> • "left" • "center" • "right"
rotate	<ul style="list-style-type: none"> • "true" / "1" • "false" / "0"

- <symbol>

Attribute	Specificable Setting Value
type	<ul style="list-style-type: none"> • "pdf417_standard" • "pdf417_truncated"

Attribute	Specificable Setting Value
level	<ul style="list-style-type: none"> • "level_0" • "level_1" (default value) • "level_2" • "level_3" • "level_4" • "level_5" • "level_6" • "level_7" • "level_8" • "default"
width	-
height	-
size	-
align	<ul style="list-style-type: none"> • "left" • "center" • "right"
rotate	<ul style="list-style-type: none"> • "true" / "1" • "false" / "0"

- <cut>

Attribute	Specificable Setting Value
type	<ul style="list-style-type: none"> • "no_feed" • "feed"

TM-L90

Printer Specifications

Item		Receipt Specification	Die-cut Label Specification
Amount of initial feed		30 dots	
Initial page mode area	Monochrome printing	576 x 738 dots	560 x 738 dots
	Two-color printing	576 x 369 dots	560 x 369 dots
Maximum page mode area	Monochrome printing	576 x 1476 dots	560 x 1476 dots
	Two-color printing	576x 738 dots	560 x 738 dots
Baseline of Font A		21 dots from the top of the character	
Baseline of Font B		ANK: 16 Chinese characters: 15 dots from the top of the character	

Elements for which restricted parameter setting values can be specified**PrinterControl XML**

- <text>

Attribute	Specificable Setting Value
lang	<ul style="list-style-type: none"> • "en" • "de" • "fr" • "it" • "es" • "ko" • "ko-kr" • "zh-hans" • "zh-cn" • "zh-hant" • "zh-tw" • "th"
font	<ul style="list-style-type: none"> • "font_a" • "font_b" • "font_c"
smooth	<ul style="list-style-type: none"> • "true" / "1" • "false" / "0"
dw	<ul style="list-style-type: none"> • "true" / "1" • "false" / "0"

Attribute	Specificable Setting Value
dh	<ul style="list-style-type: none"> • "true" / "1" • "false" / "0"
width	<ul style="list-style-type: none"> • "1" to "8"
height	<ul style="list-style-type: none"> • "1" to "8"
reverse	<ul style="list-style-type: none"> • "true" / "1" • "false" / "0"
ul	<ul style="list-style-type: none"> • "true" / "1" • "false" / "0"
em	<ul style="list-style-type: none"> • "true" / "1" • "false" / "0"
color	<ul style="list-style-type: none"> • "color_1" • "color_2"
x	<ul style="list-style-type: none"> • "0" to "65535"
y	<ul style="list-style-type: none"> • "0" to "65535"
align	<ul style="list-style-type: none"> • "left" • "center" • "right"
rotate	<ul style="list-style-type: none"> • "true" / "1" • "false" / "0"
linespc	<ul style="list-style-type: none"> • "0" to "255"

- <image>

Attribute	Specificable Setting Value
width	<ul style="list-style-type: none"> • "0" to "65535"
height	<ul style="list-style-type: none"> • "0" to "65535"
color	<ul style="list-style-type: none"> • "color_1" • "color_2"
align	<ul style="list-style-type: none"> • "left" • "center" • "right"
mode	<ul style="list-style-type: none"> • "mono"

- <barcode>

Attribute	Specificable Setting Value
type	<ul style="list-style-type: none"> • "upc_a" • "upc_e" • "ean13" • "jan13" • "ean8" • "jan8" • "code39" • "itf" • "codabar" • "code93" • "code128"
hri	<ul style="list-style-type: none"> • "none" • "above" • "below" • "both"
font	<ul style="list-style-type: none"> • "font_a" • "font_b" • "font_c"
width	<ul style="list-style-type: none"> • "2" to "6"
height	<ul style="list-style-type: none"> • "1" to "255"
align	<ul style="list-style-type: none"> • "left" • "center" • "right"
rotate	<ul style="list-style-type: none"> • "true" / "1" • "false" / "0"

- <symbol>

Attribute	Specificable Setting Value
type	<ul style="list-style-type: none"> • "pdf417_standard" • "pdf417_truncated" • "qrcode_model_1" • "qrcode_model_2" • "maxicode_mode_2" • "maxicode_mode_3" • "maxicode_mode_4" • "maxicode_mode_5" • "maxicode_mode_6"

Attribute	Specificable Setting Value
level	<ul style="list-style-type: none"> • "level_0" • "level_1" (default value) • "level_2" • "level_3" • "level_4" • "level_5" • "level_6" • "level_7" • "level_8" • "level_l" • "level_m" • "level_q" • "level_h" • "default"
width	-
height	-
size	-
align	<ul style="list-style-type: none"> • "left" • "center" • "right"
rotate	<ul style="list-style-type: none"> • "true" / "1" • "false" / "0"

- <cut>

Attribute	Specificable Setting Value
type	<ul style="list-style-type: none"> • "no_feed" • "feed"

TM-U220

Printer Specifications

Item	76mm Specification	69.5mm Specification	57.5mm Specification
Amount of initial feed	12 dots		

Elements for which restricted parameter setting values can be specified

PrinterControl XML

- <text>

Attribute	Specifiable Setting Value
lang	<ul style="list-style-type: none"> • "en" • "de" • "fr" • "it" • "es" • "ko" • "ko-kr" • "zh-hans" • "zh-cn" • "zh-hant" • "zh-tw"
font	<ul style="list-style-type: none"> • "font_a" • "font_b"
smooth	<ul style="list-style-type: none"> • "true" / "1" • "false" / "0"
dw	<ul style="list-style-type: none"> • "true" / "1" • "false" / "0"
dh	<ul style="list-style-type: none"> • "true" / "1" • "false" / "0"
width	<ul style="list-style-type: none"> • "1" to "8"
height	<ul style="list-style-type: none"> • "1" to "8"
ul	<ul style="list-style-type: none"> • "true" / "1" • "false" / "0"
em	<ul style="list-style-type: none"> • "true" / "1" • "false" / "0"
color	<ul style="list-style-type: none"> • "color_1" • "color_2"

Attribute	Specificable Setting Value
align	<ul style="list-style-type: none"> • "left" • "center" • "right"
rotate	<ul style="list-style-type: none"> • "true" / "1" • "false" / "0"
linespc	<ul style="list-style-type: none"> • "0" to "255"

• <feed>

Attribute	Specificable Setting Value
unit	<ul style="list-style-type: none"> • "0" to "255"
line	<ul style="list-style-type: none"> • "0" to "255"
linespc	<ul style="list-style-type: none"> • "0" to "255"

• <image>

Attribute	Specificable Setting Value
width	<ul style="list-style-type: none"> • "0" to "65535"
height	<ul style="list-style-type: none"> • "0" to "65535"
color	<ul style="list-style-type: none"> • "color_1" • "color_2"
align	<ul style="list-style-type: none"> • "left" • "center" • "right"
mode	<ul style="list-style-type: none"> • "mono"

• <barcode>

Attribute	Specificable Setting Value
type	<ul style="list-style-type: none"> • "upc_a" • "upc_e" • "ean13" • "jan13" • "ean8" • "jan8" • "code39" • "itf" • "codabar" • "code93" • "code128"

- <cut>

Attribute	Specifiable Setting Value
type	<ul style="list-style-type: none">• "no_feed"• "feed"

TM-H6000IV**Printer Specifications**

Item	58mm Specification	80mm Specification
Amount of initial feed	30 dots	
Initial page mode area	360 x 831 dots	512 x 831 dots
Maximum page mode area	360 x 1662 dots	512 x 1662 dots
Baseline of Font A	21 dots from the top of the character	
Baseline of Font B	16 dots from the top of the character	

Elements for which restricted parameter setting values can be specified**PrinterControl XML**

- <text>

Attribute	Specifiable Setting Value
lang	<ul style="list-style-type: none"> • "en" • "de" • "fr" • "it" • "es" • "zh-hans" • "zh-cn" • "zh-hant" • "zh-tw"
font	<ul style="list-style-type: none"> • "font_a" • "font_b"
smooth	<ul style="list-style-type: none"> • "true" / "1" • "false" / "0"
dw	<ul style="list-style-type: none"> • "true" / "1" • "false" / "0"
dh	<ul style="list-style-type: none"> • "true" / "1" • "false" / "0"
width	<ul style="list-style-type: none"> • "1" to "8"
height	<ul style="list-style-type: none"> • "1" to "8"
reverse	<ul style="list-style-type: none"> • "true" / "1" • "false" / "0"
ul	<ul style="list-style-type: none"> • "true" / "1" • "false" / "0"

Attribute	Specificable Setting Value
em	<ul style="list-style-type: none"> • "true" / "1" • "false" / "0"
color	<ul style="list-style-type: none"> • "color_1"
x	<ul style="list-style-type: none"> • "0" to "65535"
y	<ul style="list-style-type: none"> • "0" to "65535"
align	<ul style="list-style-type: none"> • "left" • "center" • "right"
rotate	<ul style="list-style-type: none"> • "true" / "1" • "false" / "0"
linespc	<ul style="list-style-type: none"> • "0" to "255"

- <feed>

Attribute	Specificable Setting Value
unit	<ul style="list-style-type: none"> • "0" to "255"
line	<ul style="list-style-type: none"> • "0" to "255"
linespc	<ul style="list-style-type: none"> • "0" to "255"

- <image>

Attribute	Specificable Setting Value
width	<ul style="list-style-type: none"> • "0" to "65535"
height	<ul style="list-style-type: none"> • "0" to "65535"
color	<ul style="list-style-type: none"> • "color_1"
align	<ul style="list-style-type: none"> • "left" • "center" • "right"
mode	<ul style="list-style-type: none"> • "mono"

- <barcode>

Attribute	Specificable Setting Value
type	<ul style="list-style-type: none"> • "upc_a" • "upc_e" • "ean13" • "jan13" • "ean8" • "jan8" • "code39" • "itf" • "codabar" • "code93" • "code128" • "gs1_128" • "gs1_databar_omnidirectional" • "gs1_databar_truncated" • "gs1_databar_limited" • "gs1_databar_expanded"
hri	<ul style="list-style-type: none"> • "none" • "above" • "below" • "both"
font	<ul style="list-style-type: none"> • "font_a" • "font_b"
width	<ul style="list-style-type: none"> • "2" to "6"
height	<ul style="list-style-type: none"> • "1" to "255"
align	<ul style="list-style-type: none"> • "left" • "center" • "right"
rotate	<ul style="list-style-type: none"> • "true" / "1" • "false" / "0"

- <symbol>

Attribute	Specificable Setting Value
type	<ul style="list-style-type: none"> • "pdf417_standard" • "pdf417_truncated" • "qrcode_model_1" • "qrcode_model_2" • "maxicode_mode_2" • "maxicode_mode_3" • "maxicode_mode_4" • "maxicode_mode_5" • "maxicode_mode_6" • "gs1_databar_stacked" • "gs1_databar_stacked_omnidirectional" • "gs1_databar_expanded_stacked"
level	<ul style="list-style-type: none"> • "level_0" • "level_1" (default value) • "level_2" • "level_3" • "level_4" • "level_5" • "level_6" • "level_7" • "level_8" • "level_l" • "level_m" • "level_q" • "level_h" • "default"
width	-
height	-
size	-
align	<ul style="list-style-type: none"> • "left" • "center" • "right"
rotate	<ul style="list-style-type: none"> • "true" / "1" • "false" / "0"

- <cut>

Attribute	Specificable Setting Value
type	<ul style="list-style-type: none"> • "no_feed" • "feed"

Usage restriction by firmware version

Availability and restrictions on using the elements and attributes differ by the version of firmware of the printer. For how to check or update the version of the firmware, refer to the Technical Reference Guide of the printer.

❑ Supported with ePOS-Device Service Ver.2.2 or later

Message	Element	Child element	Attribute	Value
<device_data>	<type>print</type>	<epos-print>	force	-
		<text>	lang	"zh-hans"
				"zh-hant"
		<symbol>	type	"azteccode_fullrange"
				"azteccode_compact"
				"datamatrix_square"
				"datamatrix_rectangle_8"
				"datamatrix_rectangle_12"
				"datamatrix_rectangle_16"
			level	Integer (5 to 95)
		<sound>	pattern	"pattern_1"
				"pattern_2"
				"pattern_3"
				"pattern_4"
				"pattern_5"
				"pattern_6"
				"pattern_7"
				"pattern_8"
				"pattern_9"
				"pattern_10"
	cycle	-		
<layout>	-	-		
<recovery>	-	-		
<reset>	-	-		

❑ Supported with ePOS-Device Service Ver.2.5 or later

Message	Element	Child element	Attribute	Value
<open_commbox>	-	-	-	-
<close_commbox>	-	-	-	-
<commbox_data>	<type>getcommhistory</type>	-	-	-

Message	Element	Child element	Attribute	Value
<open_device>	data	type	-	"type_dt"
<device_data>	<type>shutdown</type>	-	-	-
	<type>onshutdown</type>	-	-	-
	<type>lock</type>	-	-	-
	<type>unlock</type>	-	-	-
	<type>print</type>	-	-	-
	<type>onxmlresult</type>	-	-	-
	<type>slipcancel</type>	-	-	-
	<type>endorsecancel</type>	-	-	-
	<type>micread</type>	-	-	-
	<type>micrcleaning</type>	-	-	-
	<type>micrcancel</type>	-	-	-
	<type>eject</type>	-	-	-
<type>onreceive</type>	-	-	-	

❑ Supported with ePOS-Device Service Ver.2.6 or later

Message	Element	Child element	Attribute	Value	
<device_data>	<type>print</type>	printjobid	-	-	
	<type>onxmlresult</type>	printjobid	-	-	
	<type>print</type>	<response>	success	-	-
			code	'EX_SPOOLER'	
				'JobNotFound'	
				'Printing'	
		status	"0x80000000"		
<symbol>	type	"qrcode_micro"			

❑ Supported with ePOS-Device Service Ver.3.0 or later

Message	Element	Child element	Attribute	Value
<commbbox_data>	<type>getcommhistory</type>	all_history	-	-
<device_data>	<type>restart</type>	-	-	-
	<type>onrestart</type>	-	-	-

❑ Supported with ePOS-Device Service Ver.4.0 or later

Message	Element	Child element	Attribute	Value
<open_device>	data	type	-	"type_poskeyboard"
				"type_otherperipheral"

Message	Element	Child element	Attribute	Value
<device_data> POSKeyboard	-	-	-	-
<device_data> OtherPeripheral	-	-	-	-

❑ Supported with ePOS-Device Service Ver.3.1 or later

Message	Element	Child element	Attribute	Value
<device_data>	<type>slipwaitinsertion</type>	-	-	-
	<type>slipprint2</type>	-	-	-
	<type>endorsewaitinsertion</type>	-	-	-
	<type>endorseprint2</type>	-	-	-
	<type>validationwaitinsertion</type>	-	-	-
	<type>validationprint2</type>	-	-	-
	<type>validationcancel</type>	-	-	-
	<type>micread</type>	waittime	-	-
	<type>miccleaning</type>	waittime	-	-
	<type>onreceive</type>		code	-
-				'ERROR_CANCEL_- FAILED'
-				'ERROR_NOT_SUP- PORTED'
-				'ERROR_WAIT_EJECT'
-				'EPTR_SCHEMAERROR'
-				'EPTR_PA- PER_PULLED_OUT'
-				'EPTR_CUTTER'
-				'EPTR_REC_EMPTY'
<device_data>	<type>onreceive</type>	status	-	"0x04000000"
			-	"0x08000000"
			-	"0x20000000"
			-	"0x40000000"

❑ Supported with ePOS-Device Service Ver.2.9 or later, but earlier than 3.0.

Message	Element	Child element	Attribute	Value
<device_data> Storage	-	-	-	-

❑ Supported with ePOS-Device Service Ver.5.1 or later

Message	Element	Child element	Attribute	Value
<device_data>	<type>display</type>	<screen>	-	-
		<screen>	-	-
		<textarea>	-	-
		<text>	lang	"mul"
			color	-
		<backgroundcolor>	-	-
		<slideshow>	-	-
		<downloadimage>	-	-
		<registerdownloadimage>	-	-
		<nvimage>	-	-
		<clearimage>	-	-
		<symbol>	-	-
		<clearsymbol>	-	-

Sample Program

This chapter describes the sample program.



A sample program for an Android/ iOS environment is provided in the ePOS-Device XML.

Outline

The sample program provides the function to scan data with the barcode scanner and print this data.

<Android>

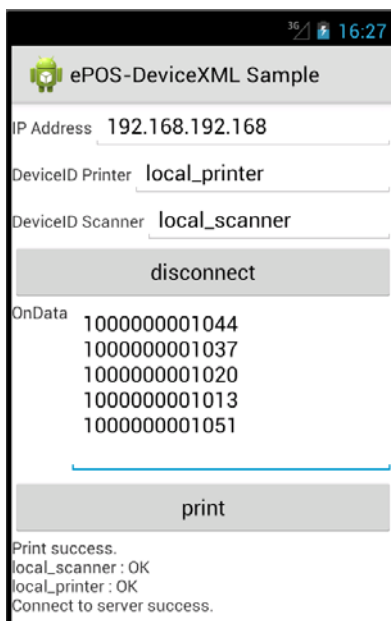

ePOS-DeviceXML Sample

IP Address 192.168.192.168

DeviceID Printer local_printer

DeviceID Scanner local_scanner

disconnect

OnData

1000000001044

1000000001037

1000000001020

1000000001013

1000000001051

print

Print success.
local_scanner : OK
local_printer : OK
Connect to server success.

<iOS>

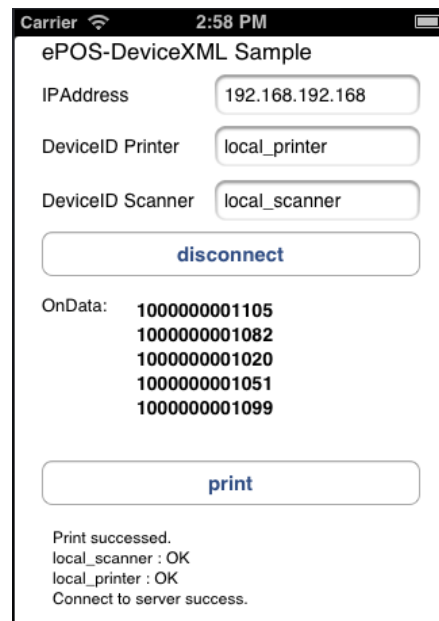

ePOS-DeviceXML Sample

IPAddress 192.168.192.168

DeviceID Printer local_printer

DeviceID Scanner local_scanner

disconnect

OnData:

1000000001105

1000000001082

1000000001020

1000000001051

1000000001099

print

Print succeeded.
local_scanner : OK
local_printer : OK
Connect to server success.

Building Environment for Android

Environment

Device

- Printer
 - TM-DT Series
 - TM-i Series (TM-i firmware Ver.4.0 or later)
 - Barcode Scanner
-

Execution environment

This section explains the following environments. Information such as the webpage URLs and versions of files to download is current as of February, 2013. Read the information you need depending on your environment.

- Java SE Development Kit 6 Update 37
 - Eclipse Classic 4.2.1
 - Android SDK Tools
 - ADT Plugin 20.0.3
 - Sample Program(ePOS-Device_Sample_XML_Vx.x.x.zip)
-

Flow of environment construction

- [Flow of environment construction for TM-DT Series \(p.450\)](#)
- [Flow of environment construction for TM-T88VI-iHUB \(p.452\)](#)
- [Flow of environment construction for other TM-i Series \(p.453\)](#)

Flow of environment construction for TM-DT Series

The following illustrates the flow of constructing the environment for the sample program.

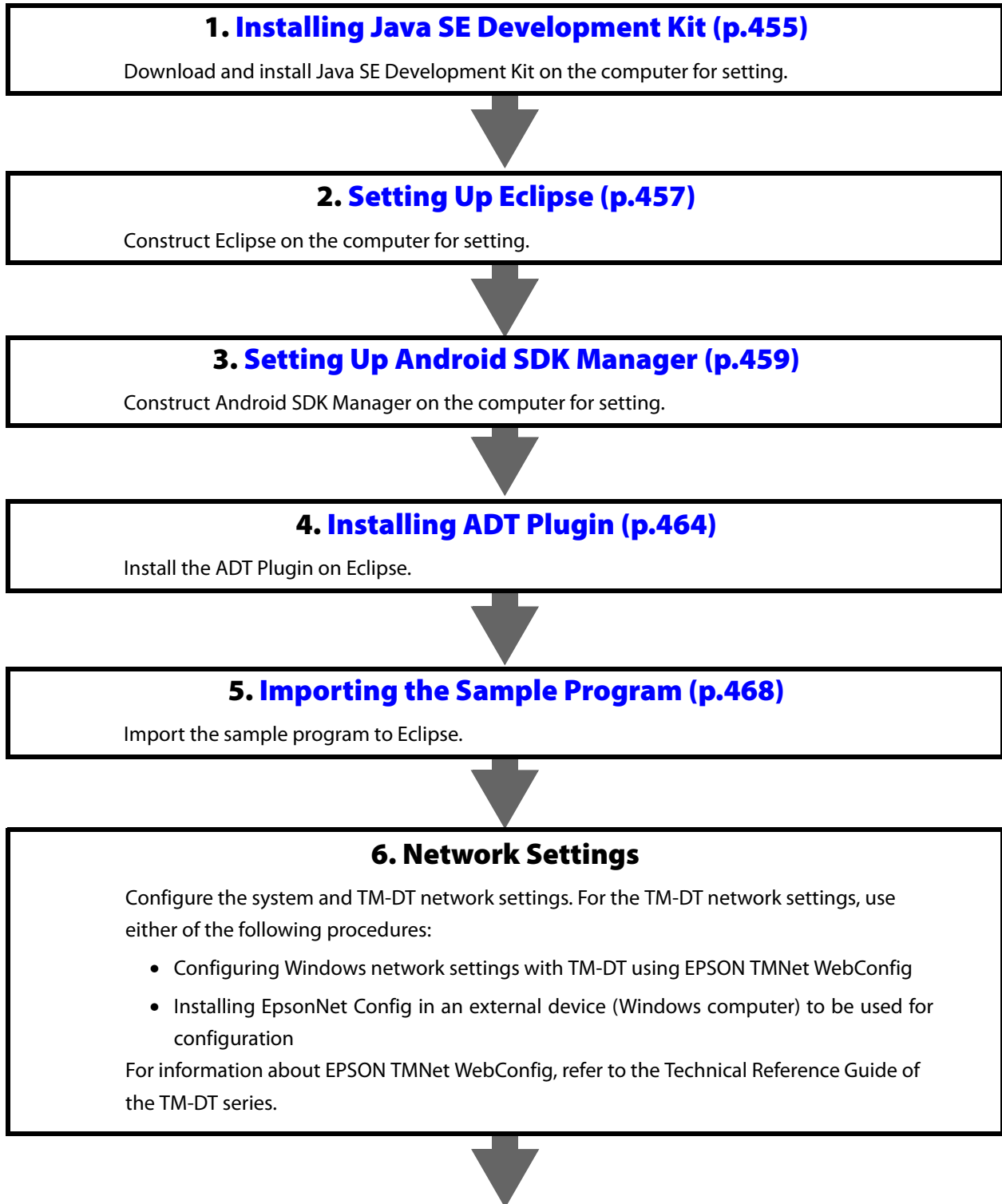

7. Connection of barcode scanner to TM-DT

Connect a barcode scanner to TM-DT.



8. [Setting the Barcode Scanner \(p.470\)](#)

Register the barcode scanner to be connected into TM-DT. Make registration using an EPSON TMNet WebConfig.

Flow of environment construction for TM-T88VI-iHUB

The following illustrates the flow of constructing the environment for the sample program.

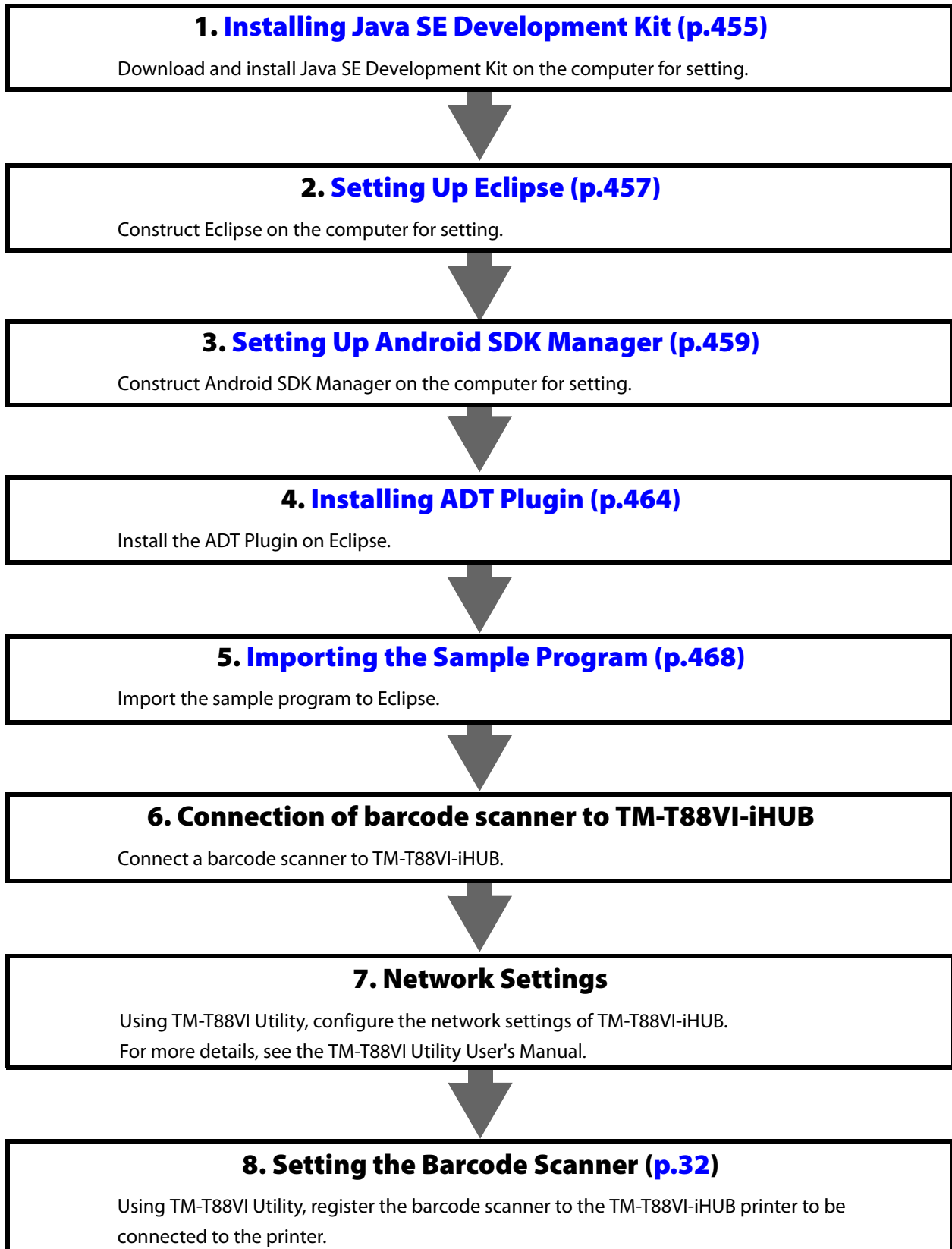

Flow of environment construction for other TM-i Series

The following illustrates the flow of constructing the environment for the sample program.

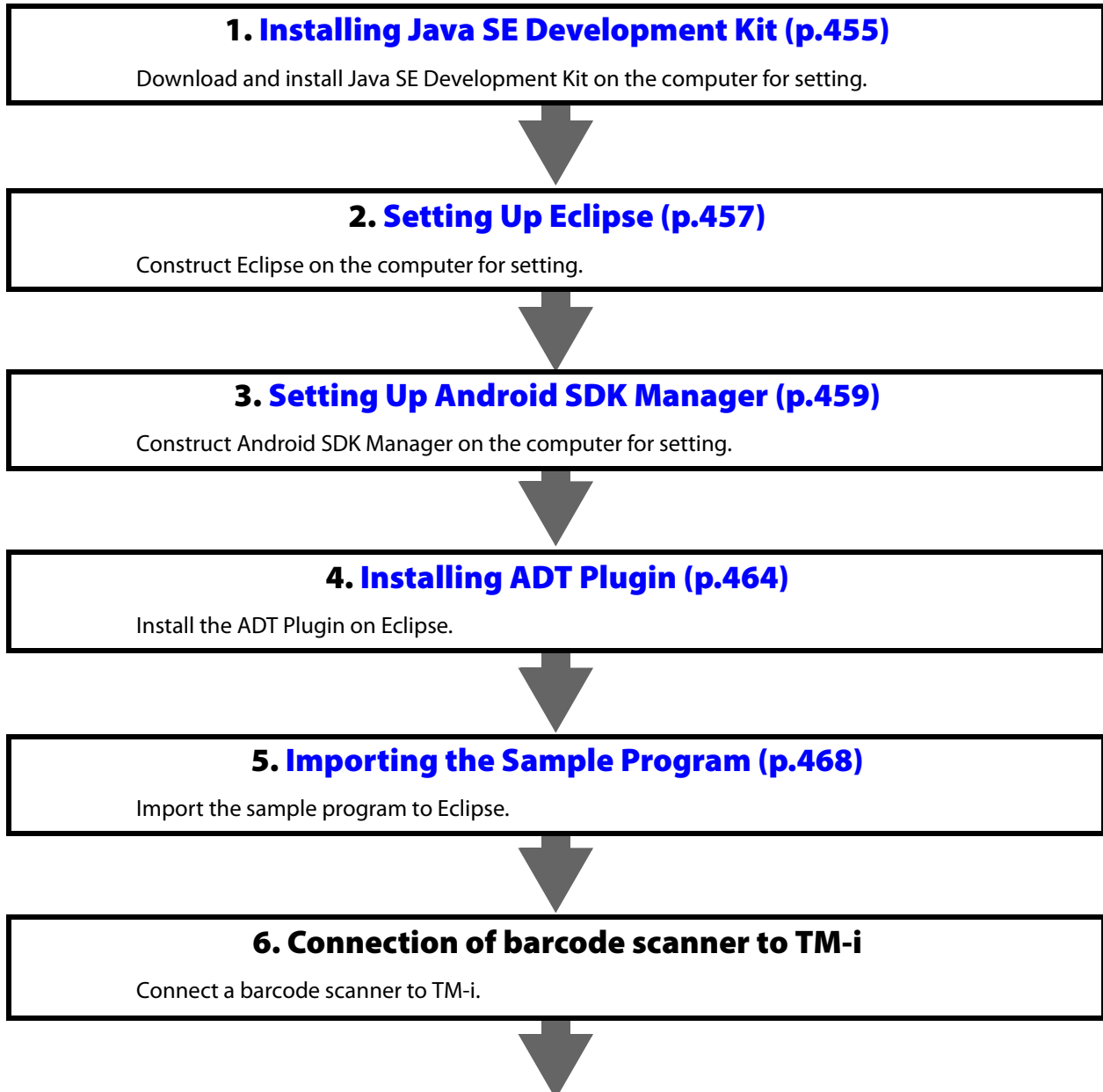

7. Network Settings

Make the network settings for the TM-i, using EPSON TMNet WebConfig.



8. Setting the Barcode Scanner (p.470)

Register the barcode scanner to be connected into TM-i. Make registration using an EPSON TMNet WebConfig.

Installing Java SE Development Kit

Download and install JDK (Java Development Kit).

Downloading JDK

- 1 Access the following URL and download Java SE 6 JDK.
<http://www.oracle.com/technetwork/java/javase/downloads/index.html>

Java SE 6 Update 37
This release addresses security concerns. Oracle strongly recommends that all Java SE 6 users upgrade to this release. [Learn more](#) ▶

JDK
DOWNLOAD ↓

JRE
DOWNLOAD ↓

JDK 6 Docs

- Installation Instructions
- ReadMe
- ReleaseNotes
- Oracle License
- Java SE Products
- Third Party Licenses
- Certified System Configurations

JRE 6 Docs

- Installation Instructions
- ReadMe
- ReleaseNotes
- Oracle License
- Java SE Products
- Third Party Licenses
- Certified System Configurations

- 2 The Java SE Downloads window appears. Select [Accept License Agreement] and select the file to be installed. Save the file to a desired location.
(In this manual, download Windows x86 to construct the environment.)

Overview Downloads Documentation Community Technologies Training

Java SE Downloads

Thank you for downloading this release of the Java™ Platform, Standard Edition Development Kit (JDK™). The JDK is a development environment for building applications, applets, and components using the Java programming language.

The JDK includes tools useful for developing and testing programs written in the Java programming language and running on the Java™ platform.

[Looking for the JavaFX SDK?](#)
The JavaFX SDK is available [here](#)

Java SE Development Kit 6 Update 37

You must accept the Oracle Binary Code License Agreement for Java SE to download this software.

Accept License Agreement Decline License Agreement

Product / File Description	File Size	Download
Linux x86	65.43 MB	jdk-6u37-linux-i586-rpm.bin
Linux x86	68.44 MB	jdk-6u37-linux-i586.bin
Linux x64	65.65 MB	jdk-6u37-linux-x64-rpm.bin
Linux x64	68.71 MB	jdk-6u37-linux-x64.bin
Linux Intel Itanium	53.95 MB	jdk-6u37-linux-ia64-rpm.bin
Linux Intel Itanium	60.67 MB	jdk-6u37-linux-ia64.bin
Solaris x86	68.35 MB	jdk-6u37-solaris-i586.sh
Solaris x86	119.94 MB	jdk-6u37-solaris-i586.tar.Z
Solaris SPARC	73.36 MB	jdk-6u37-solaris-sparc.sh
Solaris SPARC	124.71 MB	jdk-6u37-solaris-sparc.tar.Z
Solaris SPARC 64-bit	12.13 MB	jdk-6u37-solaris-sparcv9.sh
Solaris SPARC 64-bit	15.42 MB	jdk-6u37-solaris-sparcv9.tar.Z
Solaris x64	8.45 MB	jdk-6u37-solaris-x64.sh
Solaris x64	12.18 MB	jdk-6u37-solaris-x64.tar.Z
Windows x86	69.72 MB	jdk-6u37-windows-i586.exe
Windows x64	59.73 MB	jdk-6u37-windows-x64.exe

Installing JDK

- 1 Start the downloaded file. The following window appears. Click the [Next] button.

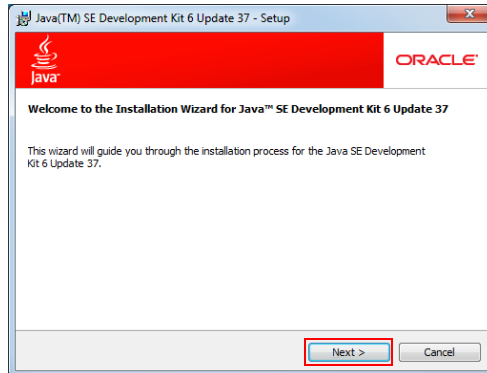

- 2 Select the function to install and click the [Next] button. To change the installation destination, click the [Change] button and change the destination. (In this manual, the default destination is used.)

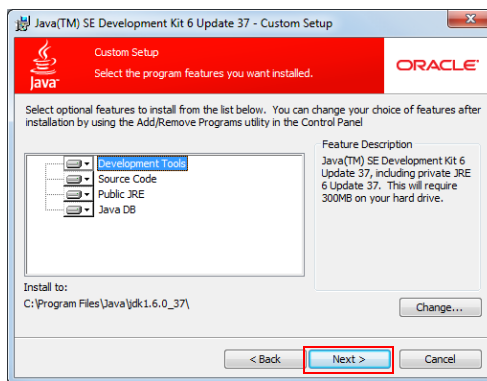

- 3 Installation starts.
- 4 When installation completes, the following window appears. Click the [Finish] button.

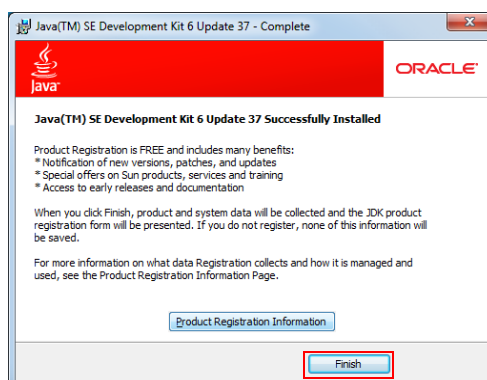

Setting Up Eclipse

Download, install and set up Eclipse.

Downloading Eclipse

Access the following URL and download Eclipse. Save the file to a desired location.

(In this manual, download and set up Eclipse Classic)

<http://www.eclipse.org/downloads/>



Installing Eclipse and Configuring Initial Settings

- 1 Extract the downloaded file to a desired location.
(In this manual, extract the file under "C:".)
- 2 Double-click "eclipse.exe" to start Eclipse.
- 3 Set up the work folder during Eclipse startup process. Click the [OK] button.
(In this manual, the default settings are used.)

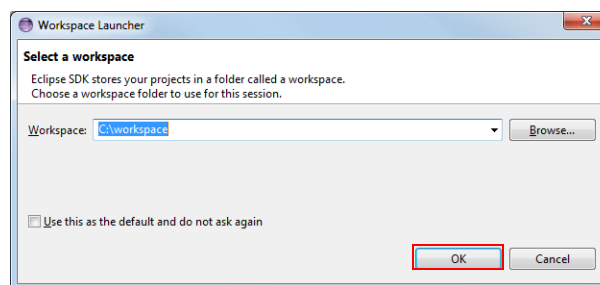

Setting Proxy for Eclipse

Use this operation when proxy setting is required for Internet connection. If not required, this operation is unnecessary.

- 1 Select [Window] - [Preferences].

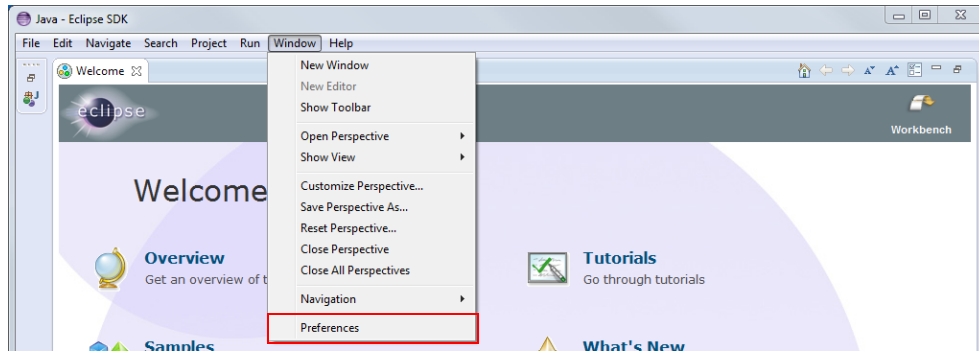

- 2 Select [General]-[Network Connections] from the left column. Set the proxy and click the [OK] button.

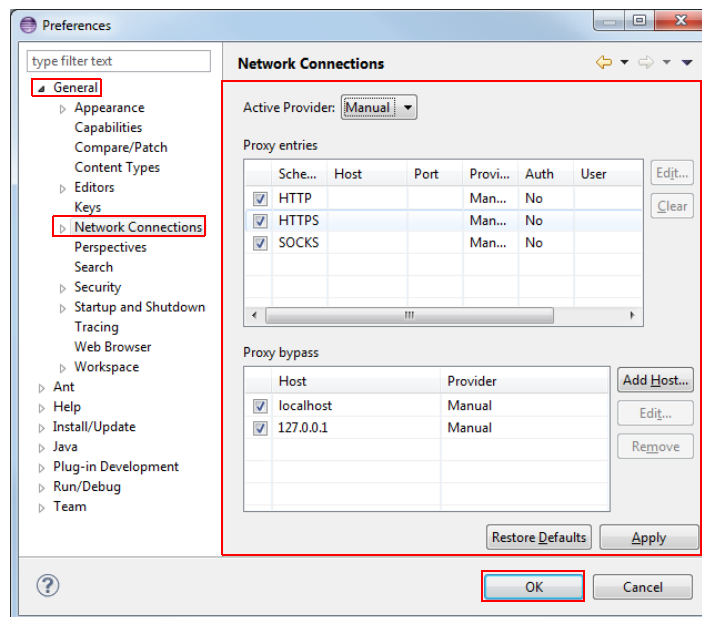

Setting Up Android SDK Manager

Download and install Android SDK Manager. Create Android Virtual Device.

Downloading Android SDK Manager

Access the following URL and download Android SDK Manager.

(In this manual, download the installer for Windows.)

<http://developer.android.com/sdk/index.html>

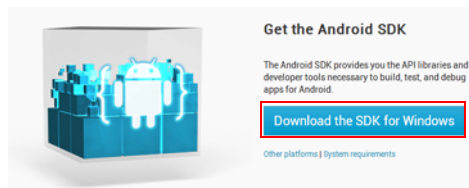

Installing Android SDK Manager

- 1 Start the downloaded file. The following window appears. Click the [Next] button.

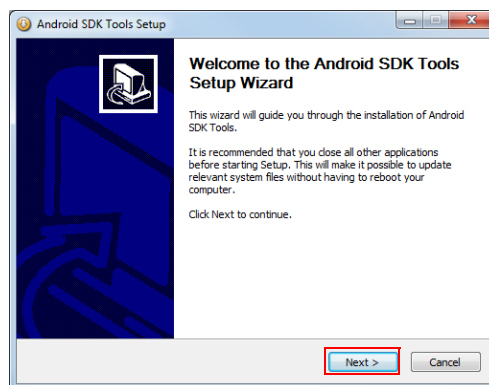

- 2 Click the [Next] button.



If JDK is not installed, it is notified at this point.

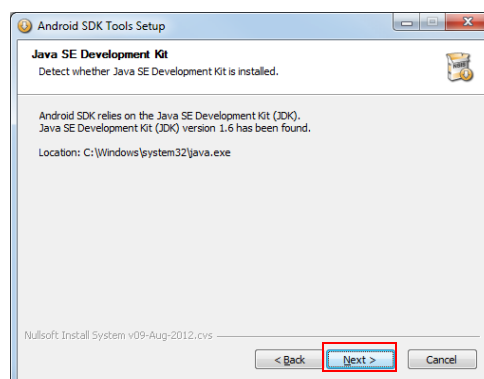

- 3** Specify the user destination. Click the [Next] button.
(In this manual, the default settings are used.)

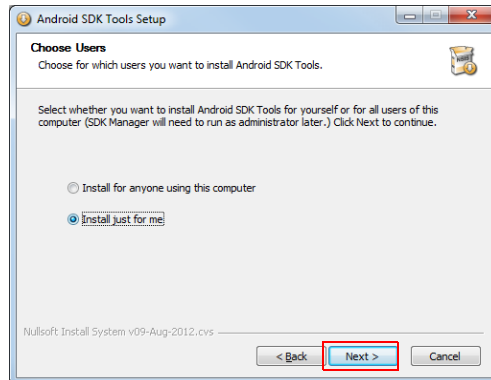

- 4** Specify the Install location destination. Click the [Next] button.
(In this manual, the default settings are used.)

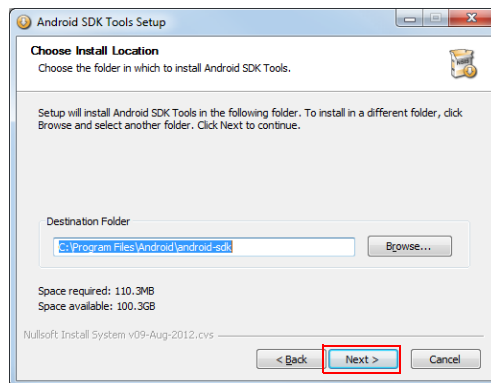

- 5** Specify the name to be registered to Start Menu. Click the [Install] button.

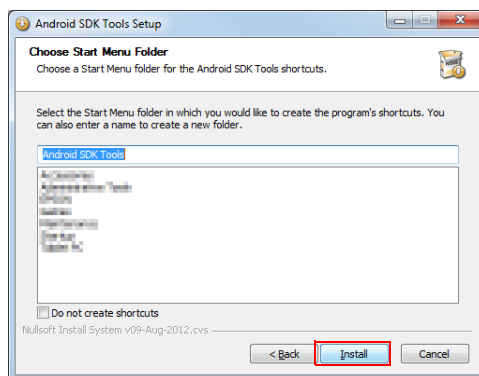

6 When installation completes, click the [Next] button.

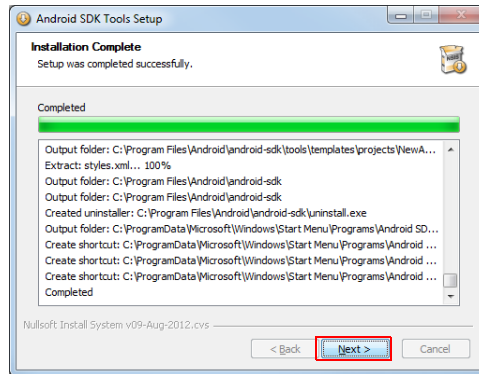

7 Clear the [Start SDK Manager] checkbox. Click the [Finish] button.

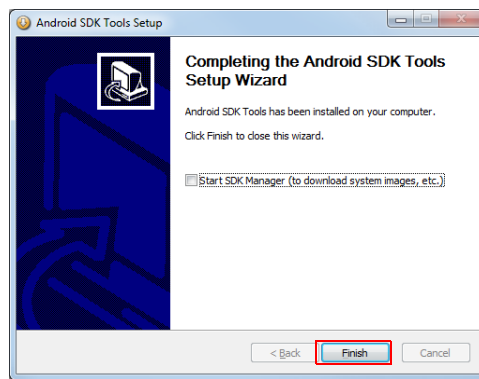

Setting Android SDK Manager

1 Start Android SDK Manager.

[Start]-[All Programs]-[Android SDK Tools]-[SDK Manager]



On Windows Vista or later, it is required to run Android SDK Manager as the administrator. To run as the administrator, right-click Android SDK Manager and select [Run as administrator]. If Android SDK Manager is not run as the administrator, package download will fail.

2 When the proxy setting is required, select [Tools]-[Options].

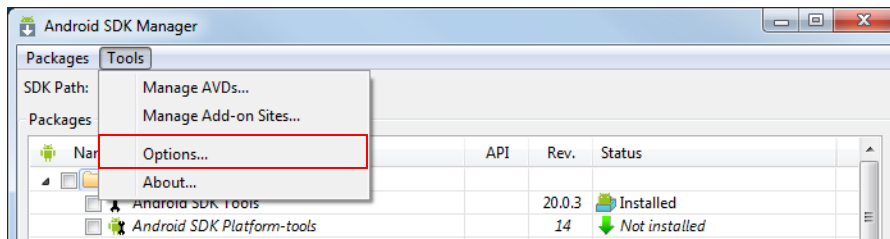

3 The proxy setting window appears. Set the proxy and click the [Close] button.

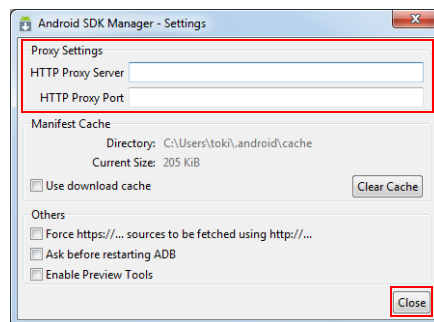

4 Select the version of the device to develop and [Android Support Library] inside [Extras], then click [Install XX packages...].

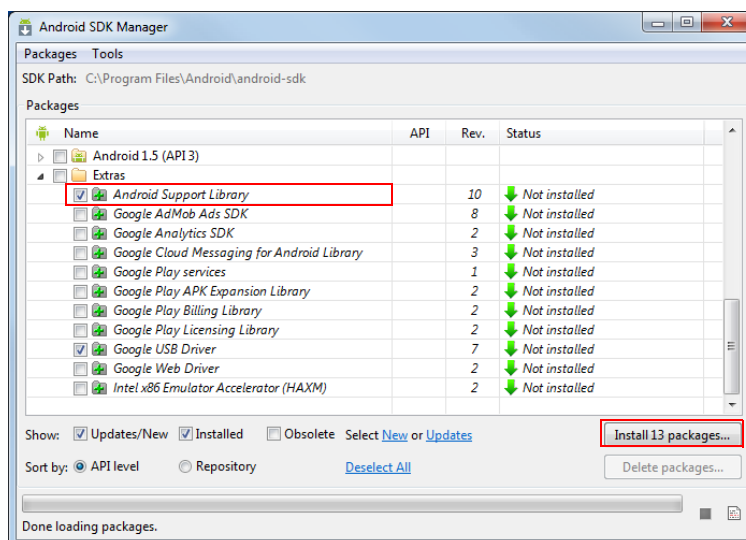

5 Select [Accept All] and click the [Install] button. Installation of Virtual Device starts.

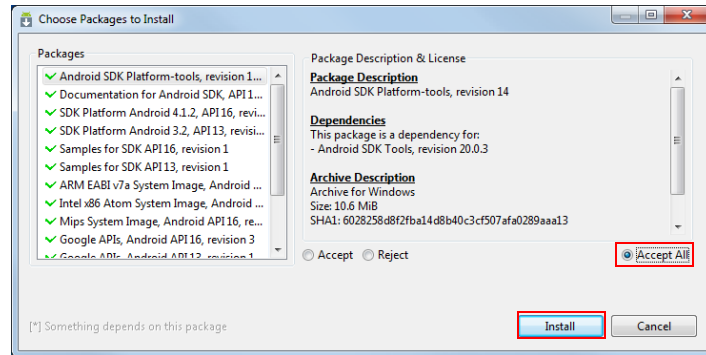

Installing ADT Plugin

install ADT (Android Development Tools) Plugin.



To execute this operation, the computer must be connected to the Internet. If the proxy setting is required for Internet connection, refer to [Setting Proxy for Eclipse \(p.458\)](#).

1 Start Eclipse. Select [Help]-[Install New Software].

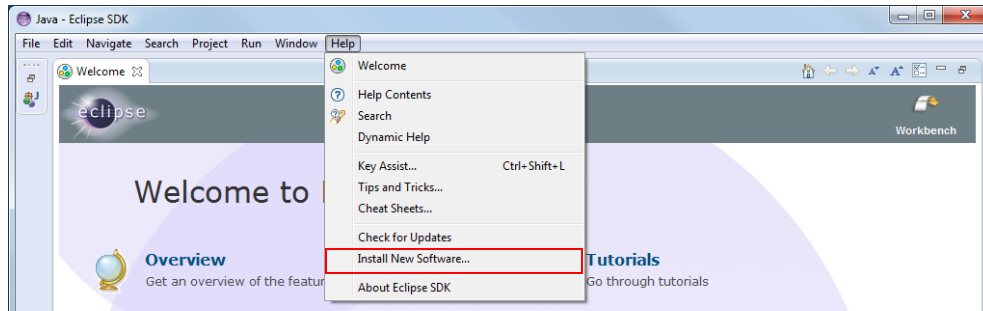

2 Click the [Add] button.

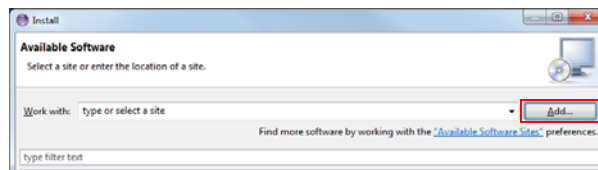

3 Enter [Name] and [Location], and click the [OK] button.

Item	Description
Name	ADT Plugin
Location	https://dl-ssl.google.com/android/eclipse/

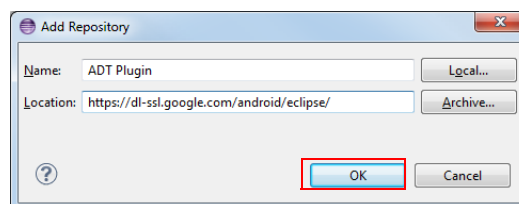

- 4 Select the [Developer Tools] checkbox and click the [Next] button.

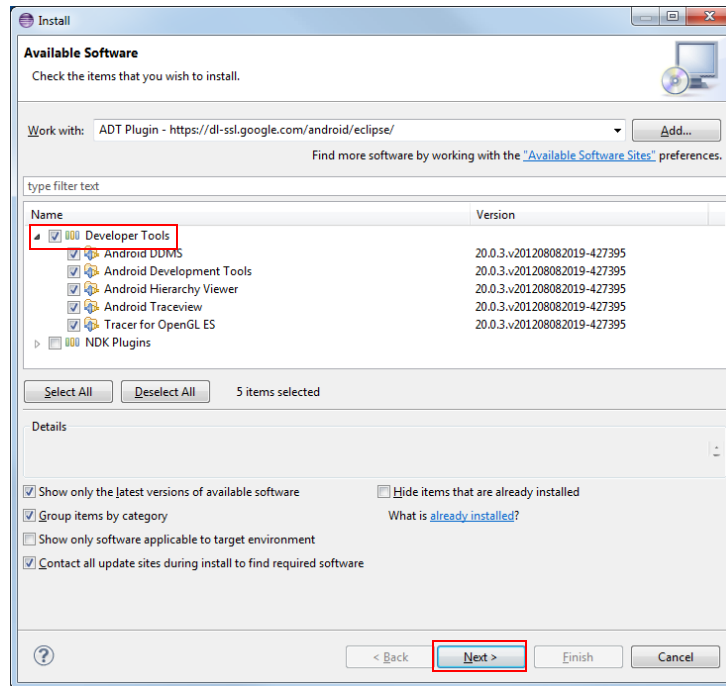

- 5 Confirm the plugin to be installed, and click the [Next] button.

- 6 After confirming the terms of the license agreement, select the [I accept...] checkbox and click the [Finish] button.

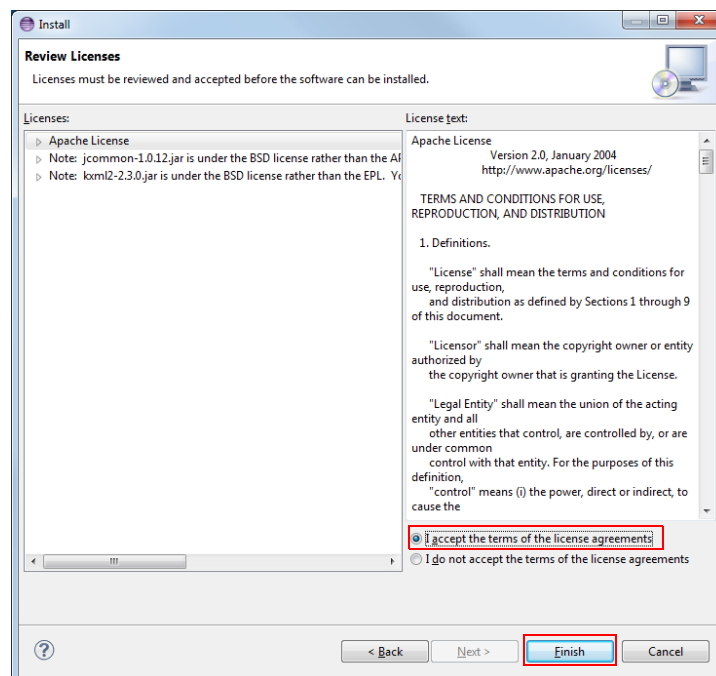

7 Installation starts. If the following window appears, click the [OK] button.

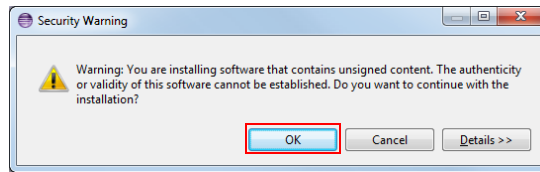

8 Click the [Yes] button to restart Eclipse.

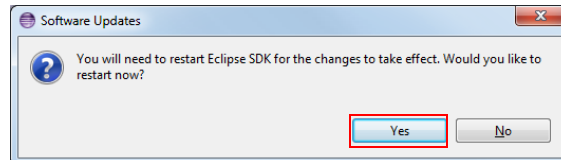

9 Select [Window] - [Preferences].

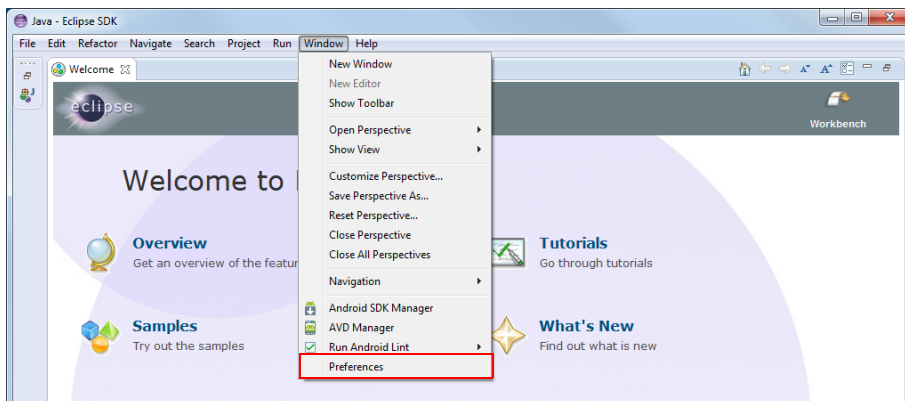

10 Select [Android] from the left column. Click the [Browse...] button to display the Android folder where SDK Manager is installed.

(In this manual, display "C:\Program Files\Android\android-sdk".)

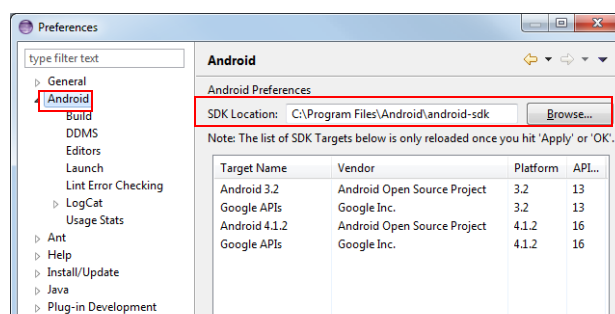

11 Click the [Apply] button. Confirm that the installed package is displayed.

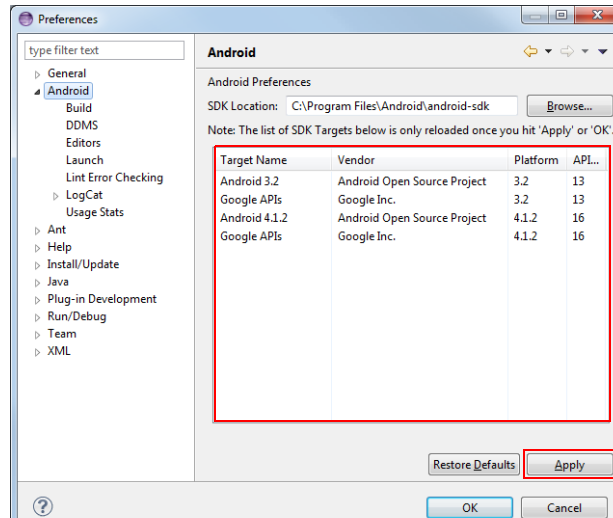

Importing the Sample Program

Import the sample program to Eclipse.

- 1 Extract ePOS-Device_Sample_XML_Vx.x.x.zip, and save it to any folder.
- 2 Start Eclipse. Select [File]-[Import].

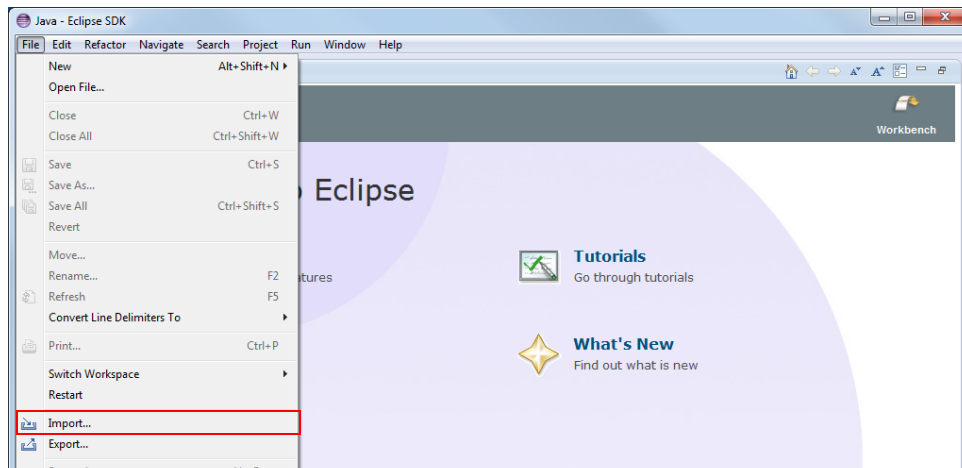

- 3 Select [General]-[Existing Projects into Workspace]. Click the [Next] button.

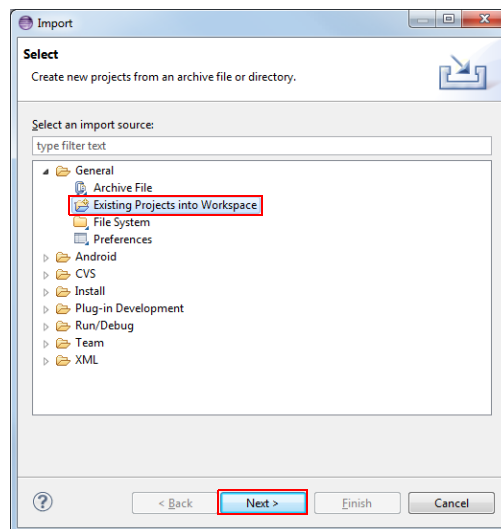

- 4 Click the [Browse...] button to display the saved sample program. Select the [Copy projects into workspace] checkbox and click the [Finish] button.

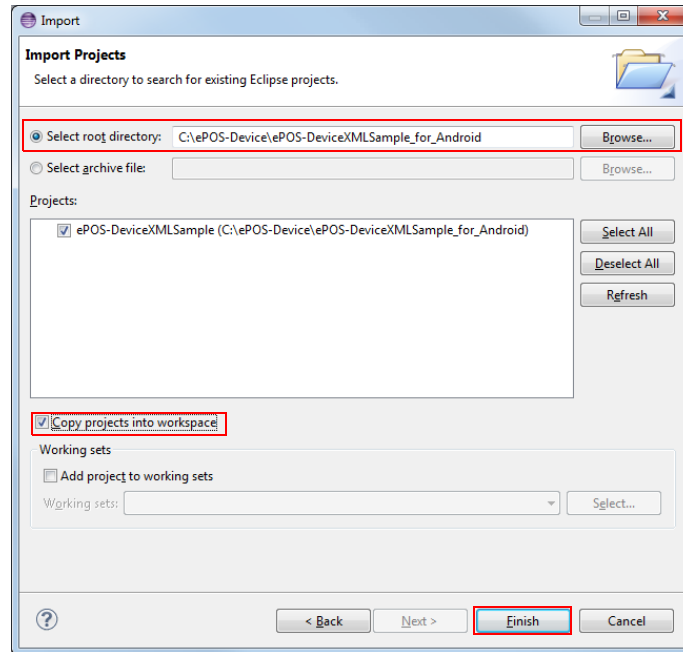

- 5 Confirm that the application has been properly imported.

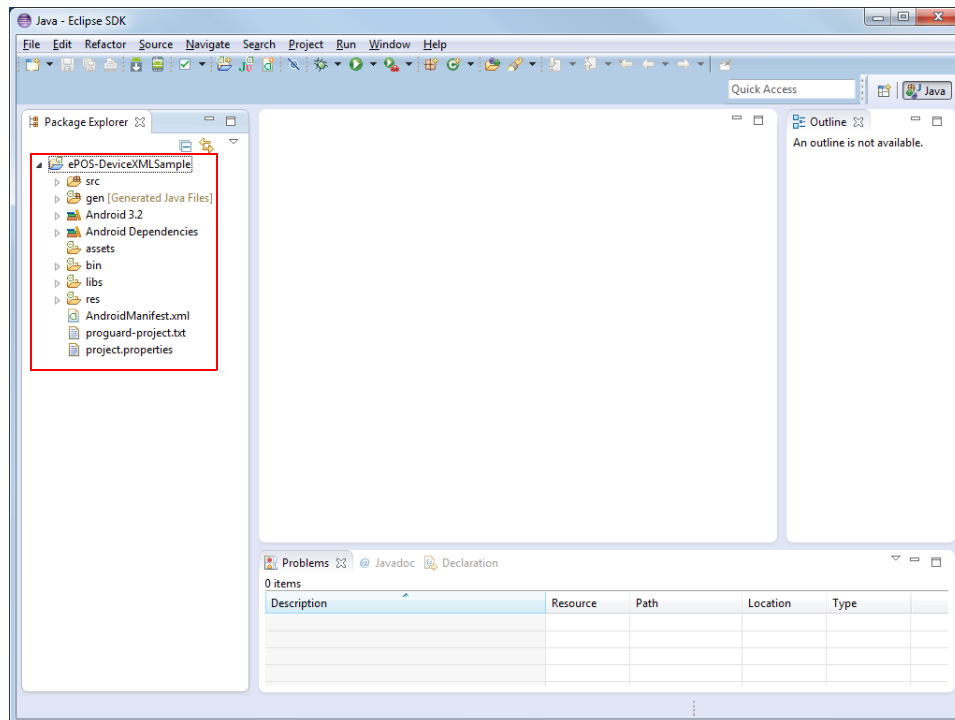

Setting the Barcode Scanner

Register the barcode scanner to be controlled by ePOS-Device XML into printer. Configure the settings using EPSON TMNet WebConfig.

EPSON TMNet WebConfig can be launched from your web browser.



For details on settings used, refer to the Technical Reference Guide for each printer.

Set the following.

Setting	Setting Value
Device ID	local_scanner
Device name	Select the relevant device from the list.
Control Script	Scanner_Generic.js

Building Environment for iOS

Environment

Device

- Printer
 - TM-DT Series
 - TM-i Series (TM-i firmware Ver.4.0 or later)
 - Barcode Scanner
-

Execution environment

This section explains the following environments. Information such as the webpage URLs and versions of files to download is current as of February, 2013. Read the information you need depending on your environment.

- Mac OS X 10.7.5
 - Apple Xcode 4.5.2
 - iOS SDK 6.0
 - Sample Program(ePOS-Device_Sample_XML_Vx.x.x.zip)
-

Flow of environment construction

- [Flow of environment construction for TM-DT Series \(p.472\)](#)
- [Flow of environment construction for TM-T88VI-iHUB \(p.473\)](#)
- [Flow of environment construction for other TM-i Series \(p.474\)](#)

Flow of environment construction for TM-DT Series

The following illustrates the flow of constructing the environment for the sample program.

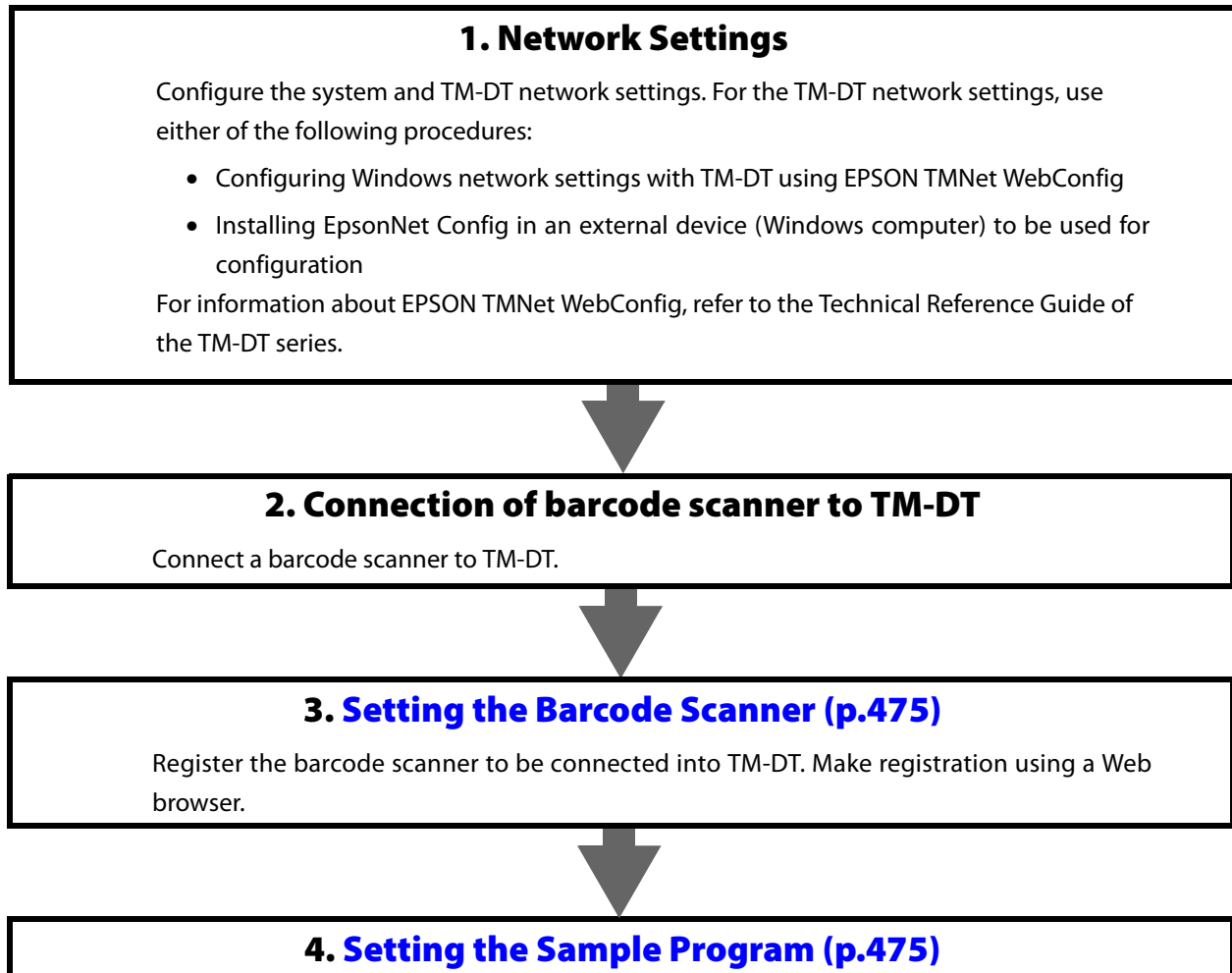

Flow of environment construction for TM-T88VI-iHUB

The following illustrates the flow of constructing the environment for the sample program.

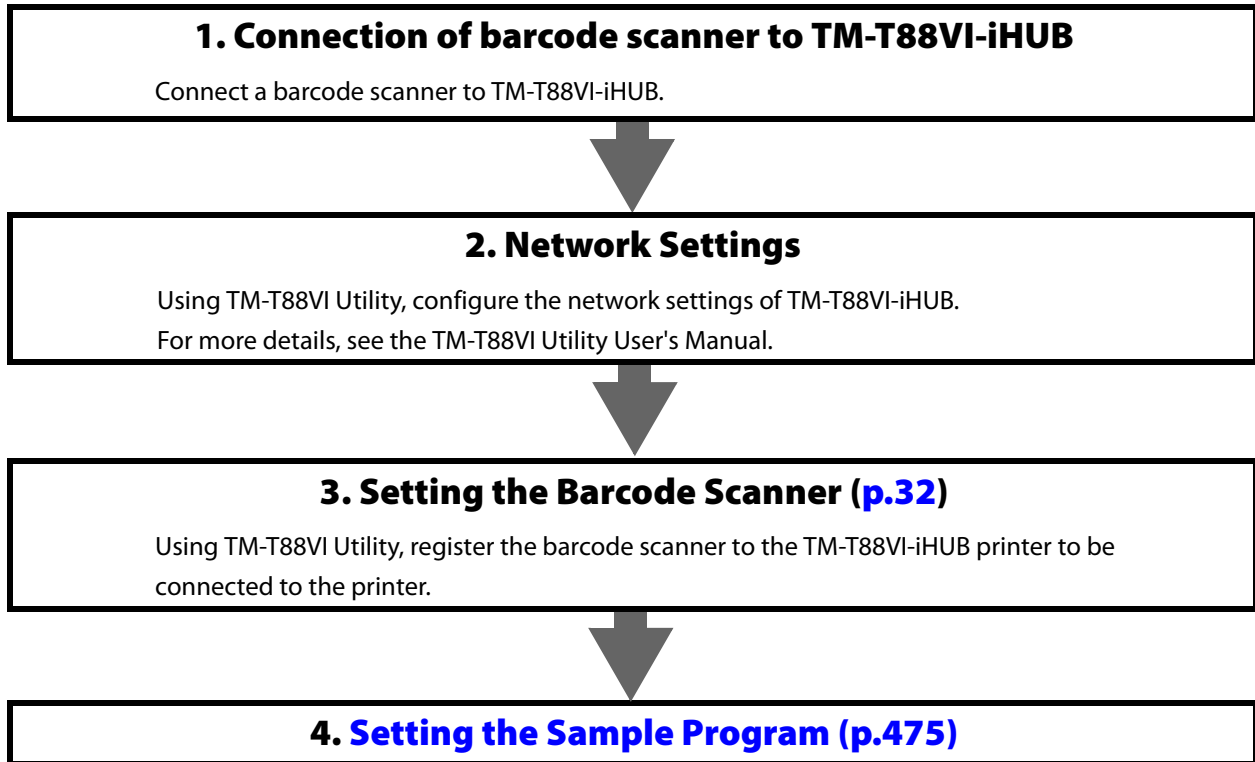

Flow of environment construction for other TM-i Series

The following illustrates the flow of constructing the environment for the sample program.

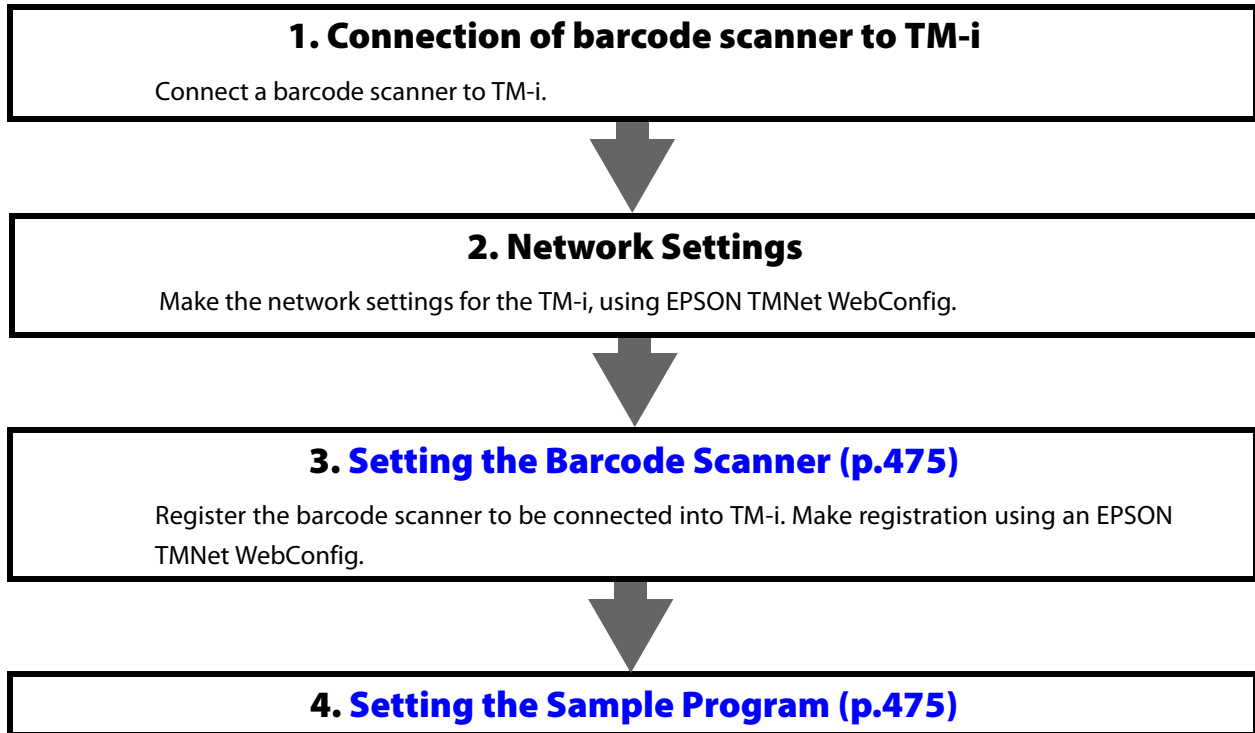

Setting the Barcode Scanner

Register the barcode scanner to be controlled by ePOS-Device XML into printer. Configure the settings using EPSON TMNet WebConfig.

EPSON TMNet WebConfig can be launched from your web browser.



For details on settings used, refer to the Technical Reference Guide for each printer.

Set the following.

Setting	Setting Value
Device ID	local_scanner
Device name	Select the relevant device from the list.
Control Script	Scanner_Generic.js

Setting the Sample Program

Configure the settings in the following procedure:

- 1** Expand ePOS-Device_Sample_XML_Vx.x.x.zip.
- 2** Start XCode and open the [ePOS-DeviceXMLSample.xcodeproj] project file.
- 3** When the project is opened, the project settings and source files will be displayed.
- 4** From the options displayed when [Set Active Executable] is selected, select an iPhone or iPad file.

Executing Sample Program



The iOS can be run with iOS Simulator.

Android

You can execute the sample program using the following methods.

- Executing with an emulator([p.476](#))
- Executing with an Android device([p.479](#))

Executing with an emulator

Execute the program using the following procedure.

- 1** Start Android Virtual Device Manager. After it starts, click the [New...] button.
[Start]-[All Programs]-[Android SDK Tools]-[AVD Manager]

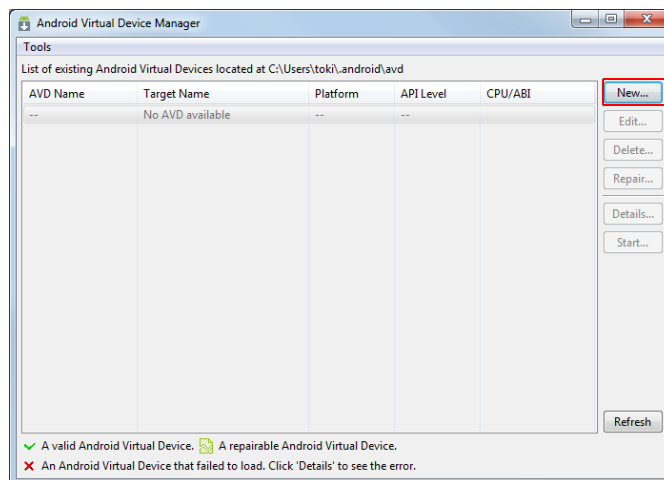

- 2** Select the name of the virtual device to create and the OS version of the virtual device. Input any value for [Name], and make selections for [Target] and [CPU/ABI]. Then click the [Create AVD] button.

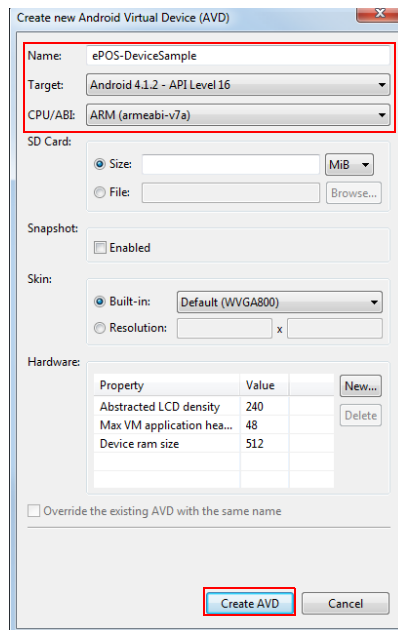

- 3** The created virtual device is displayed.

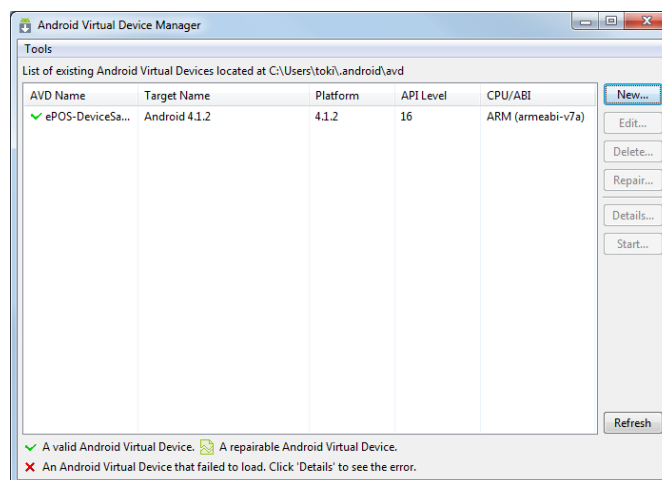

- 4** Click the button to run Eclipse.

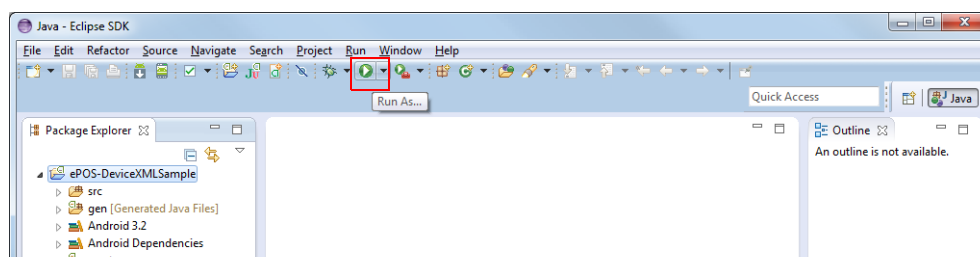

- 5 For the initial startup, the window to confirm the execution type appears. Select [Android Application] and click the [OK] button.

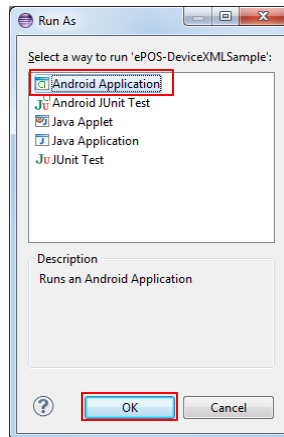

- 6 The emulator starts and the application is executed.

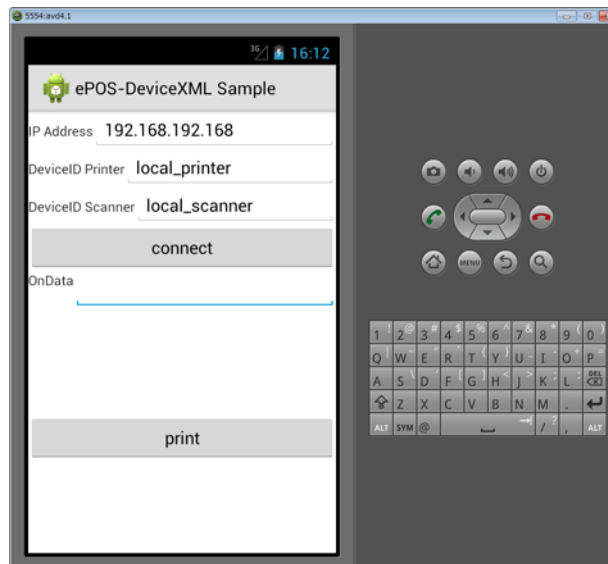

Executing with an Android device

Execute the program using the following procedure.

- 1 Install the USB driver for the Android Debug Bridge (ADB) for the Android device you are using. For more information about USB drivers for Android devices and their installation, see the site at the following URL. <http://developer.android.com/tools/extras/oem-usb.html>



If you are unable to find an ADB USB driver for the device you are using at the site linked to above, search the website of the manufacturer of your device.

- 2 Make the following settings on your Android device:
 - Go to [Settings] - [Applications] , and enable [Unknown sources].
 - Select [Settings] - [Applications] - [Development] , and enable [USB debugging].
- 3 Connect the Android device to your computer via USB.
- 4 Enable the AndroidManifest.xml debugging file in the sample application. Double-click [AndroidManifest.xml]. On the [Application] tab, set [Debuggable] to "true", and save the settings.

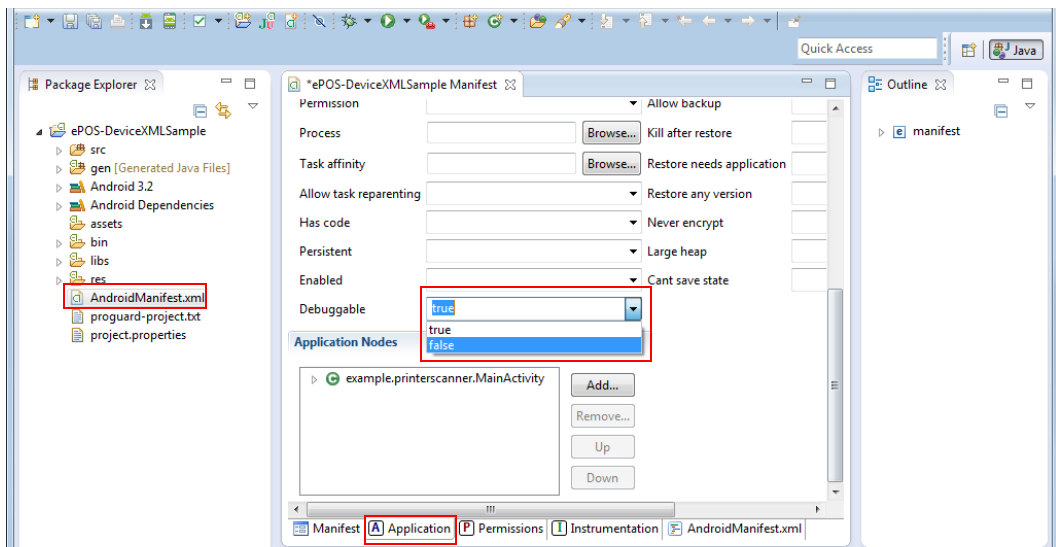

- 5** Click the Run button in Eclipse.
If it is being run for the first time, the following window will appear. Select [Android Application], and click the [OK] button.

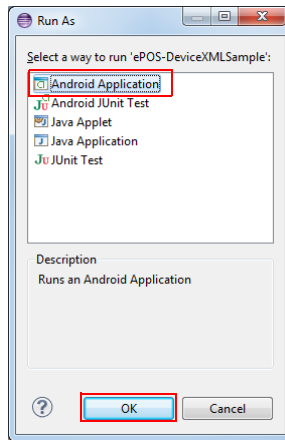

- 6** The sample application is installed and run on the Android device.

How to Use the Sample Program

Use the sample program using the following procedure.

- 1 Perform application settings.

Set as follows.

Setting Item	Description
IP Address	Input the printer's IP address.
DeviceID Printer	Input "local_printer".
DeviceID Scanner	Input "local_scanner".

- 2 Click or tap [connect].
- 3 Confirm that "Connect to server success" is displayed on the bottom of the screen.

- 4 Scan a barcode using the barcode scanner.

- 5 If the barcode is properly scanned, the scan result is displayed in [OnData].

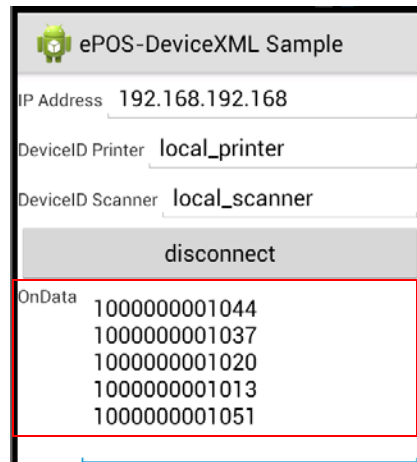

- 6 Click or tap [print] to print the scan result.

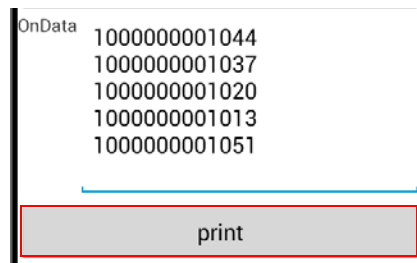

- 7 If it is printed properly, "Print success" is displayed on the bottom of the screen.

