

# TC78 Touch Computer



**ZEBRA**

## **Quick Start Guide**

2023/02/22

ZEBRA and the stylized Zebra head are trademarks of Zebra Technologies Corporation, registered in many jurisdictions worldwide. All other trademarks are the property of their respective owners. ©2023 Zebra Technologies Corporation and/or its affiliates. All rights reserved.

Information in this document is subject to change without notice. The software described in this document is furnished under a license agreement or nondisclosure agreement. The software may be used or copied only in accordance with the terms of those agreements.

For further information regarding legal and proprietary statements, please go to:

SOFTWARE: [zebra.com/linkoslegal](https://zebra.com/linkoslegal).

COPYRIGHTS: [zebra.com/copyright](https://zebra.com/copyright).

PATENTS: [ip.zebra.com](https://ip.zebra.com).

WARRANTY: [zebra.com/warranty](https://zebra.com/warranty).

END USER LICENSE AGREEMENT: [zebra.com/eula](https://zebra.com/eula).

## Terms of Use

### Proprietary Statement

This manual contains proprietary information of Zebra Technologies Corporation and its subsidiaries ("Zebra Technologies"). It is intended solely for the information and use of parties operating and maintaining the equipment described herein. Such proprietary information may not be used, reproduced, or disclosed to any other parties for any other purpose without the express, written permission of Zebra Technologies.

### Product Improvements

Continuous improvement of products is a policy of Zebra Technologies. All specifications and designs are subject to change without notice.

### Liability Disclaimer

Zebra Technologies takes steps to ensure that its published Engineering specifications and manuals are correct; however, errors do occur. Zebra Technologies reserves the right to correct any such errors and disclaims liability resulting therefrom.

### Limitation of Liability

In no event shall Zebra Technologies or anyone else involved in the creation, production, or delivery of the accompanying product (including hardware and software) be liable for any damages whatsoever (including, without limitation, consequential damages including loss of business profits, business interruption, or loss of business information) arising out of the use of, the results of use of, or inability to use such product, even if Zebra Technologies has been advised of the possibility of such damages. Some jurisdictions do not allow the exclusion or limitation of incidental or consequential damages, so the above limitation or exclusion may not apply to you.

## Features

This section lists the features of the TC78 touch computer.

**Figure 1** Front and Side Views

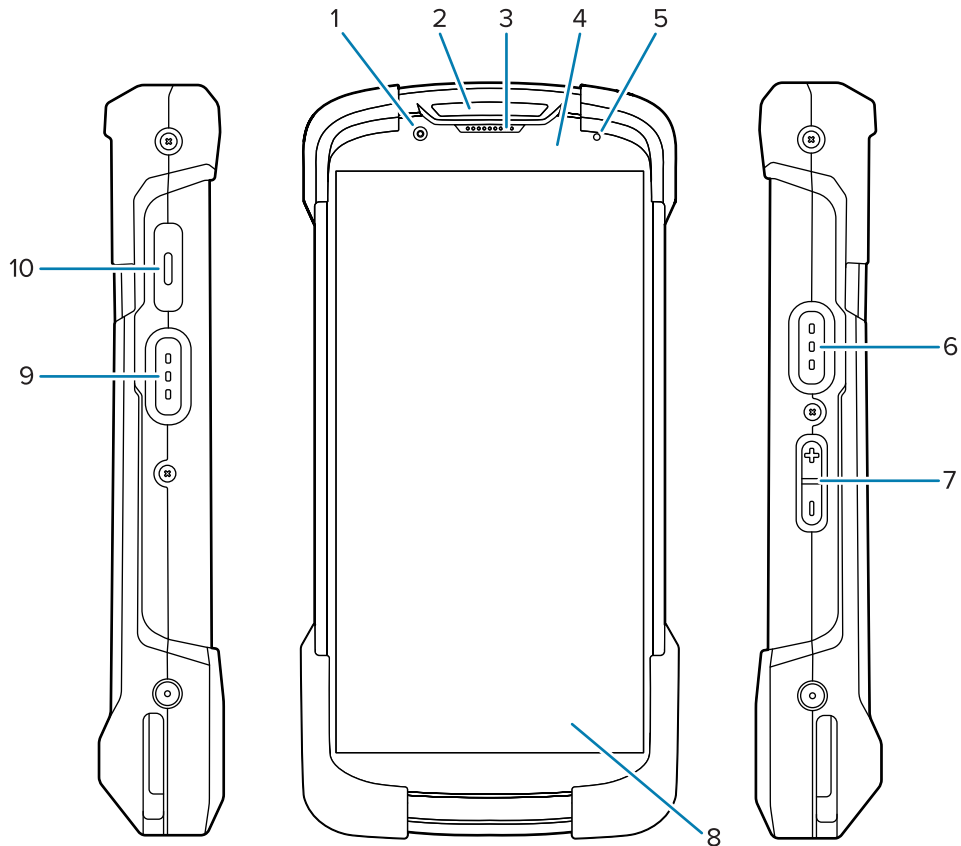

Number	Item	Description
1	8 MP front camera	Takes photos and videos.
2	Scan LED	Indicates data capture status.
3	Receiver	Use for audio playback in Handset mode.
4	Proximity/light sensor	Determines proximity and ambient light for controlling display backlight intensity.
5	Battery status LED	Indicates battery charging status while charging and application-generated notifications.
6, 9	Scan button	Initiates data capture (programmable).
7	Volume up/down button	Increase and decrease audio volume (programmable).
8	6 in. touch screen	Displays all information needed to operate the device.
10	PTT button	Typically used for PTT communications. User reprogrammable to generate other keycodes or to launch applications.

**Figure 2** Back, Top, and Bottom View

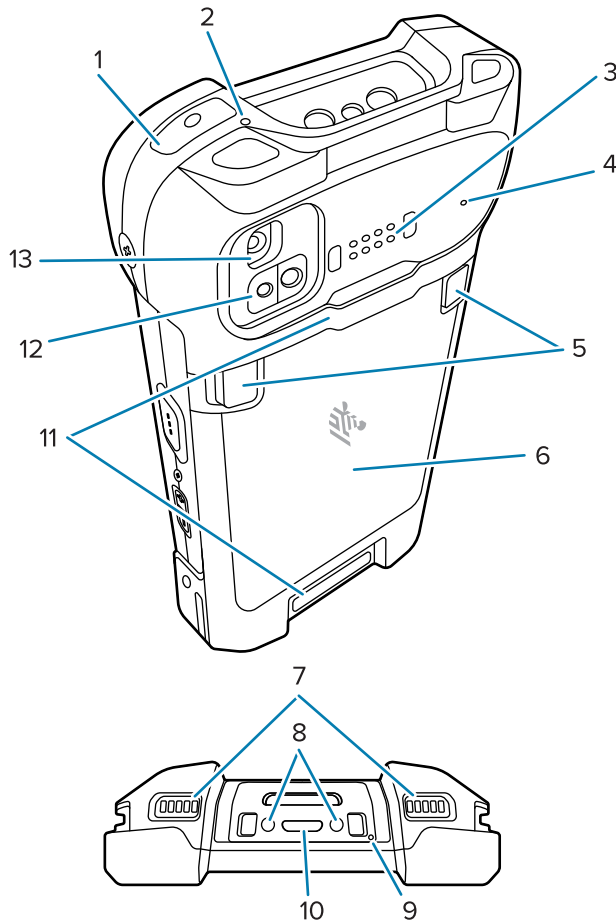

Number	Item	Description
1	Power button	Turns the display on and off. Press and hold to reset the device, to power it off, or to swap the battery.
2, 4, 9	Microphone	Use for noise cancellation.
3	Back common I/O 8 pins	Provides host communications, audio, device charging via cables, and accessories.
5	Battery release latches	Pinch both latches in and lift up to remove the battery.
6	Battery	Provides power to the device.
7	Speaker	Provides audio output for video and music playback. Provides audio in speakerphone mode.
8	DC input pins	Power/ground for charging (5V through 9V).
10	USB Type C receptacle	Provides power and communications via standard USB-C cable.
11	Hand strap attachment points	Attachment points for the hand strap.

Number	Item	Description
12	ToF module	Employs time of flight techniques to resolve distance between the camera and subject.  <b>NOTE:</b> The ToF feature is available only in premium configurations.
13	16 MP rear camera with flash	Takes photos and videos with flash to provide illumination for the camera.

## Installing a microSD Card

The microSD card slot provides secondary non-volatile storage. The slot is located under the battery pack. Refer to the documentation provided with the card for more information, and follow the manufacturer's recommendations for use.



**CAUTION—ESD:** Follow proper electrostatic discharge (ESD) precautions to avoid damaging the microSD card. Proper ESD precautions include, but are not limited to, working on an ESD mat and ensuring the operator is properly grounded.

1. Remove the access cover.

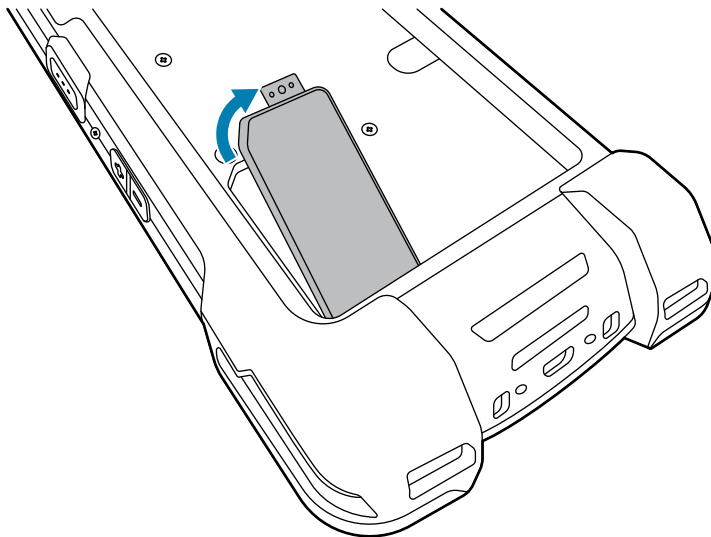

**NOTE:** Some devices have a locking cover that secures with a special screw to prevent unauthorized access to the compartment.

2. Slide the microSD card holder to the Open position.

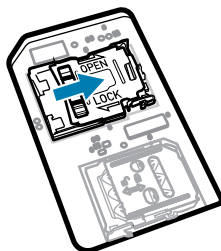

3. Lift the microSD card holder door.

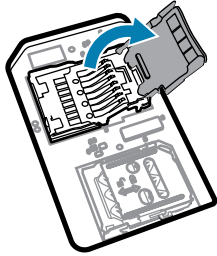

4. Insert the microSD card into the card holder, ensuring that the card slides into the holding tabs on each side of the door.

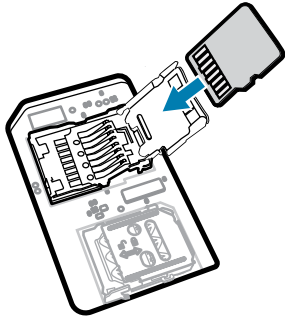

5. Close the microSD card holder door.

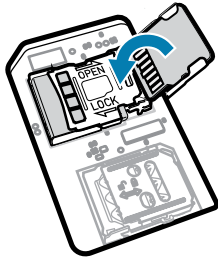

6. Slide the microSD card holder door to the Lock position.

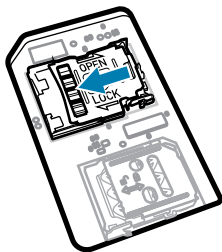

**IMPORTANT:** The access cover must be replaced and securely seated to ensure proper device sealing.

7. Reinstall the access cover.

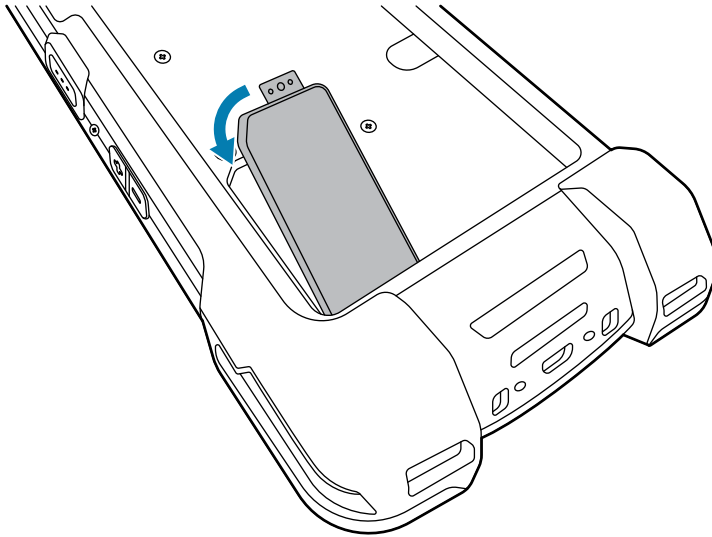

## Installing the SIM Card



**CAUTION—ESD:** Follow proper electrostatic discharge (ESD) precautions to avoid damaging the SIM card. Proper ESD precautions include, but are not limited to, working on an ESD mat and ensuring the operator is properly grounded.

1. Remove the access cover.

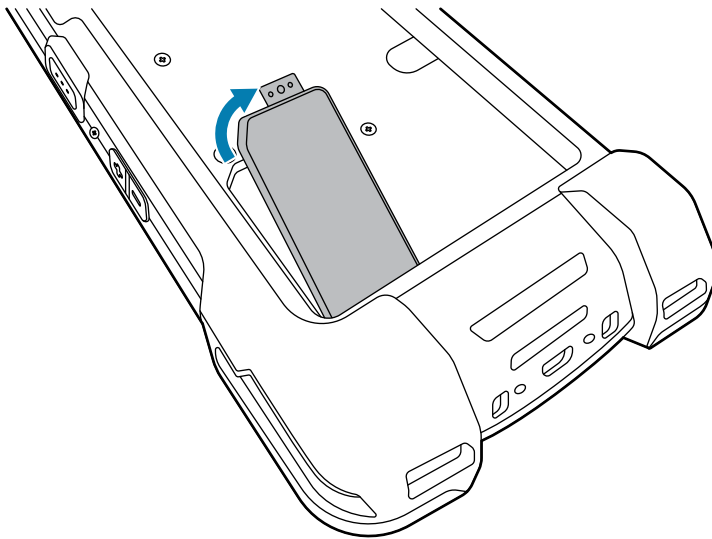

**NOTE:** Some devices have a locking cover that secures with a special screw to prevent unauthorized access to the compartment.

2. Slide the SIM card holder to the unlock position.

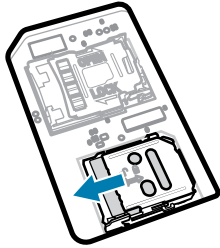

3. Lift the SIM card holder door.

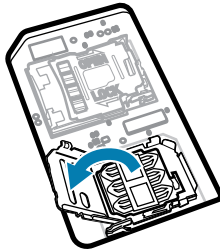

4. Place the SIM card into the card holder with contacts facing down.

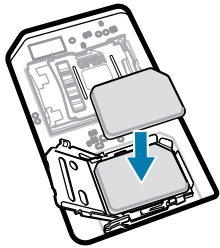

5. Close the SIM card holder door.

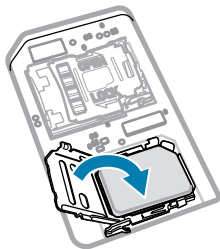

6. Slide to SIM card holder door to the lock position.

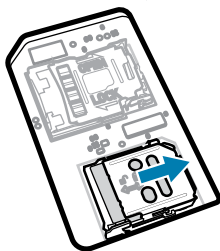

**IMPORTANT:** The access cover must be replaced and securely seated to ensure proper device sealing.



7. Reinstall the access cover. If you removed a screw previously, reinstall it.

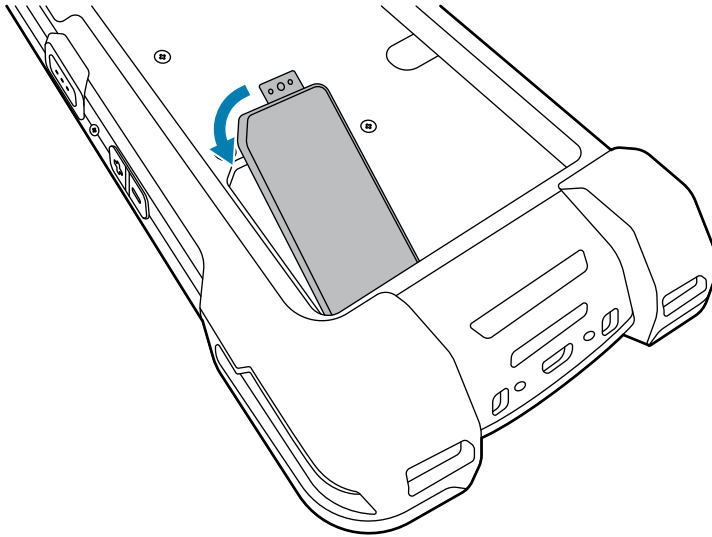

## Installing or Removing a Battery

This section describes how to install a battery into the device and how to remove it.



**NOTE:** Do not put any labels, asset tags, engravings, stickers, or other objects in the battery well. Doing so may compromise the intended performance of the device or accessories. Performance levels such as sealing (Ingress Protection (IP)), impact performance (drop and tumble), functionality, or temperature resistance could be affected.

1. To install a battery:
  - a) Insert the battery, bottom first, into the battery compartment in the back of the device.
  - b) Press the battery down until it snaps into place.

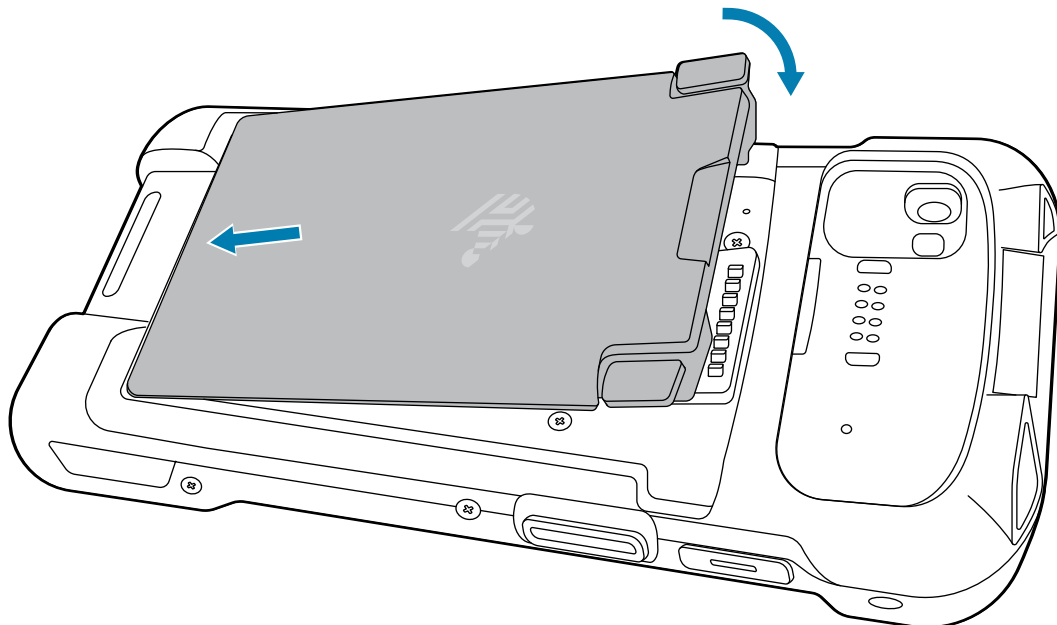

**2.** To remove a battery:

- a)** Press the two release tabs inward.

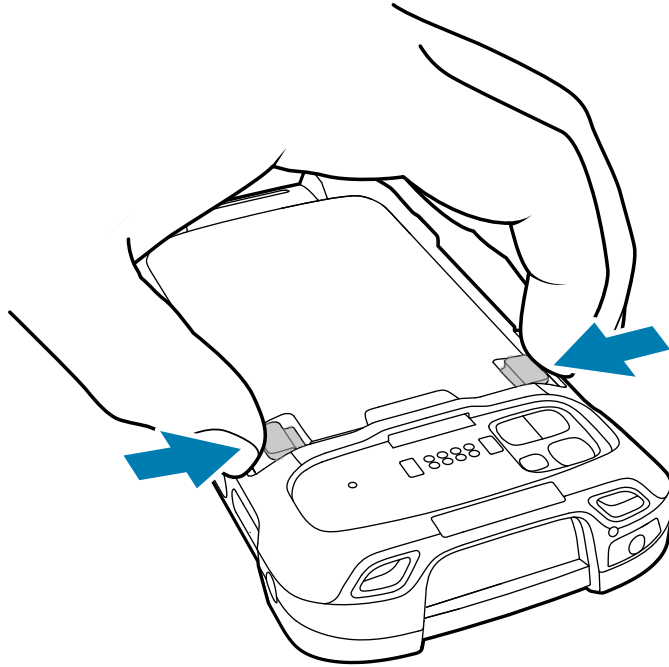

- b)** Lift the battery from the device.

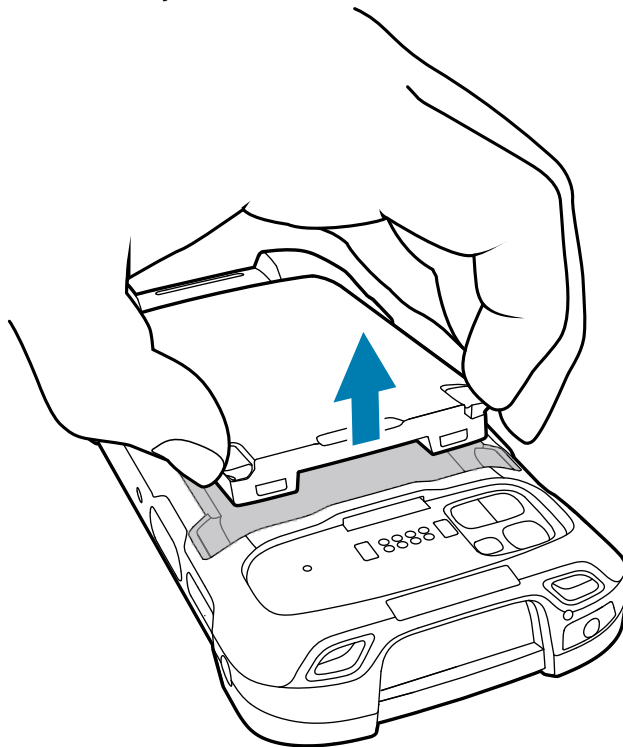

## Using the Rechargeable Li-Ion Battery with BLE Beacon

This device utilizes a rechargeable Li-Ion battery to facilitate BLE Beacon. When BLE Beacon is enabled, the battery transmits a BLE signal for up to 7 days while the device is powered off due to battery depletion.



**NOTE:** The device transmits a Bluetooth beacon only when the device is powered off or in Airplane Mode.

For additional information on configuring the Secondary BLE settings, see [techdocs.zebra.com/emdk-for-android/11-0/mx/beaconmgr/](https://techdocs.zebra.com/emdk-for-android/11-0/mx/beaconmgr/).

## Charging the Device

To achieve optimal charging results, use only Zebra charging accessories and batteries. Charge batteries at room temperature with the device in sleep mode.

A standard battery charges from fully depleted to 90% in approximately 2 hours and from fully depleted to 100% in approximately 3 hours. In many cases, a 90% charge provides enough charge for daily use. Depending on the usage profile, a full 100% charge may last for approximately 14 hours of use.



**IMPORTANT:** Follow the guidelines for battery safety described in the Battery Best Practices file available at [zebra.com/batteries](https://zebra.com/batteries).

The device or accessory always performs battery charging in a safe and intelligent manner. The device or accessory indicates when charging is disabled due to abnormal temperatures via its LED, and a notification appears on the device display.

Temperature	Battery Charging Behavior
20 to 45°C (68°F to 113°F)	Optimal charging range.
0 to 20°C (32 to 68°F) 45 to 50°C (113 to 122°F)	Charging slows to optimize the JEITA requirements of the cell.
Below 0°C (32°F) Above 50°C (122°F)	Charging stops.
Above 58°C (136°F)	The device shuts down.

To charge the device using a cradle:

1. Connect the charging accessory to the appropriate power source.

2. Insert the device into a slot to begin charging. Ensure that the device is properly seated.

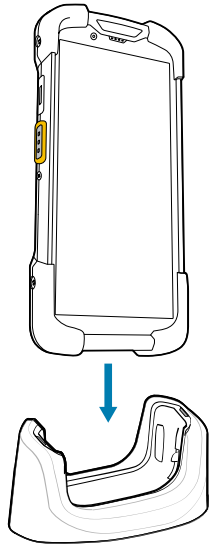

The device turns on and begins charging. The Charging/Notification LED blinks amber while the device is charging and then turns solid green when the device is fully charged.

**See Also**

[Charging Indicators](#)

## Charging the Spare Battery

This section provides information on charging a spare battery. To achieve optimal charging results, use only Zebra charging accessories and batteries.

1. Insert a spare battery into the spare battery slot.
2. Ensure the battery is seated properly.

The Spare Battery Charging LED blinks indicating charging.

The battery charges from fully depleted to 90% in approximately 2.5 hours and from fully depleted to 100% in approximately 3.5 hours. In many cases, the 90% charge provides plenty of charge for daily use. Depending on the usage profile, a full 100% charge may last for approximately 14 hours of use.







## Charging Indicators

The charging/notification LED on the device indicates the charging status.

**Table 1** Charging/Notification LED Charging Indicators

State	LED Color	Indications
Off	○	The device is not charging. <ul style="list-style-type: none"> <li>• The device is not inserted correctly in the cradle or connected to a power source.</li> <li>• The charger/cradle is not powered.</li> </ul>

**Table 1** Charging/Notification LED Charging Indicators (Continued)

State	LED Color	Indications
Slow Blinking Amber (1 blink every 4 seconds)		The device is charging.
Slow Blinking Red (1 blink every 4 seconds)		The device is charging, but the battery is at the end of its useful life.
Solid Green		Charging is complete.
Solid Red		Charging is complete, but the battery is at the end of its useful life.
Fast Blinking Amber (2 blinks/second)		Charging error, such as: <ul style="list-style-type: none"> <li>• Temperature is too low or too high.</li> <li>• Charging has gone on too long without completion (typically twelve hours).</li> </ul>
Fast Blinking Red (2 blinks/second)		Charging error, and the battery is at the end of its useful life. For example: <ul style="list-style-type: none"> <li>• The temperature is too low or too high.</li> <li>• Charging has gone on too long without completion (typically 12 hours).</li> </ul>

## Accessories for Charging

Use one of the following accessories to charge the device and/or spare battery.

### Charging and Communication

Description	Part Number	Charging		Communication	
		Battery (In device)	Spare Battery	USB	Ethernet
1-Slot Charge Only Cradle	CRD-NGTC7-2SC1B	Yes	Yes	No	No
1 Slot Ethernet Cradle	CRD-NGTC7-2SE1B	Yes	Yes	Yes	Yes
5-Slot Charging Cradle	CRD-NGTC7-5SC5D	Yes	No	No	No
5-Slot Ethernet Cradle	CRD-NGTC7-5SE5D	Yes	No	No	Yes
4-Slot Charge Only Cradle with Battery Charger	CRD-NGTC7-5SC4B	Yes	Yes	No	No
Charge/USB Cable	CBL-TC5X-USBC2A-01	Yes	No	Yes	No

### 1-Slot Charge Only Cradle

This USB cradle provides power and host communications.



**CAUTION:** Ensure that you follow the guidelines for battery safety described in [Battery Safety Guidelines](#).

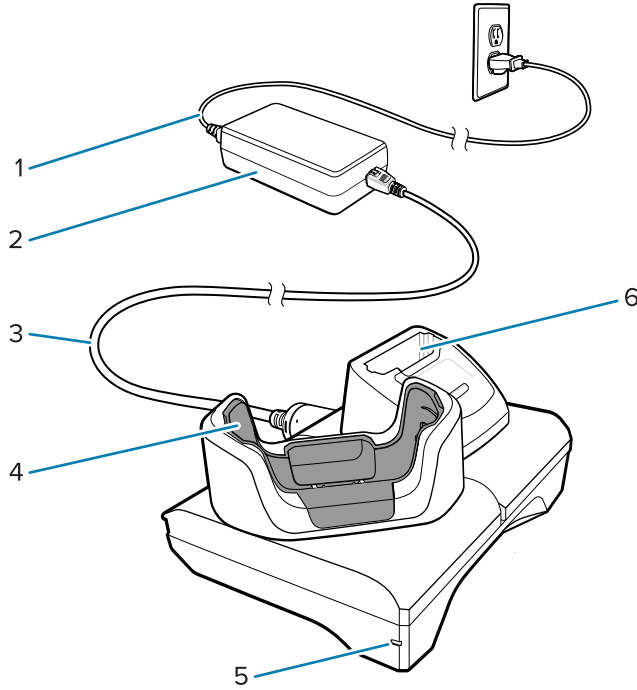

1	AC line cord
2	Power supply
3	DC line cord
4	Device charging slot
5	Power LED
6	Spare battery charging slot

### 1-Slot USB-Ethernet Cradle

This Ethernet cradle provides power and host communications.



**CAUTION:** Ensure that you follow the guidelines for battery safety described in [Battery Safety Guidelines](#).

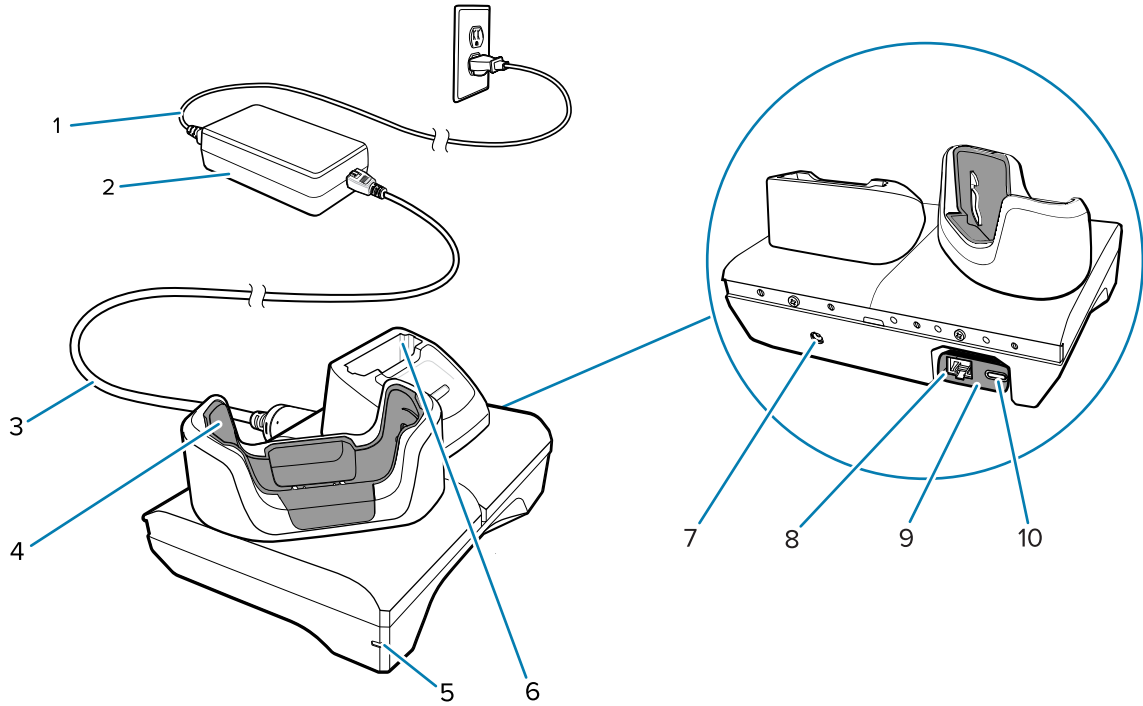

1	AC line cord
2	Power supply
3	DC line cord
4	Device charging slot
5	Power LED
6	Spare battery charging slot
7	DC line cord input
8	Ethernet port (on USB to Ethernet module kit)
9	USB to Ethernet module kit
10	USB port (on USB to Ethernet module kit)

### 5-Slot Charge Only Cradle



**CAUTION:** Ensure that you follow the guidelines for battery safety described in [Battery Safety Guidelines](#).

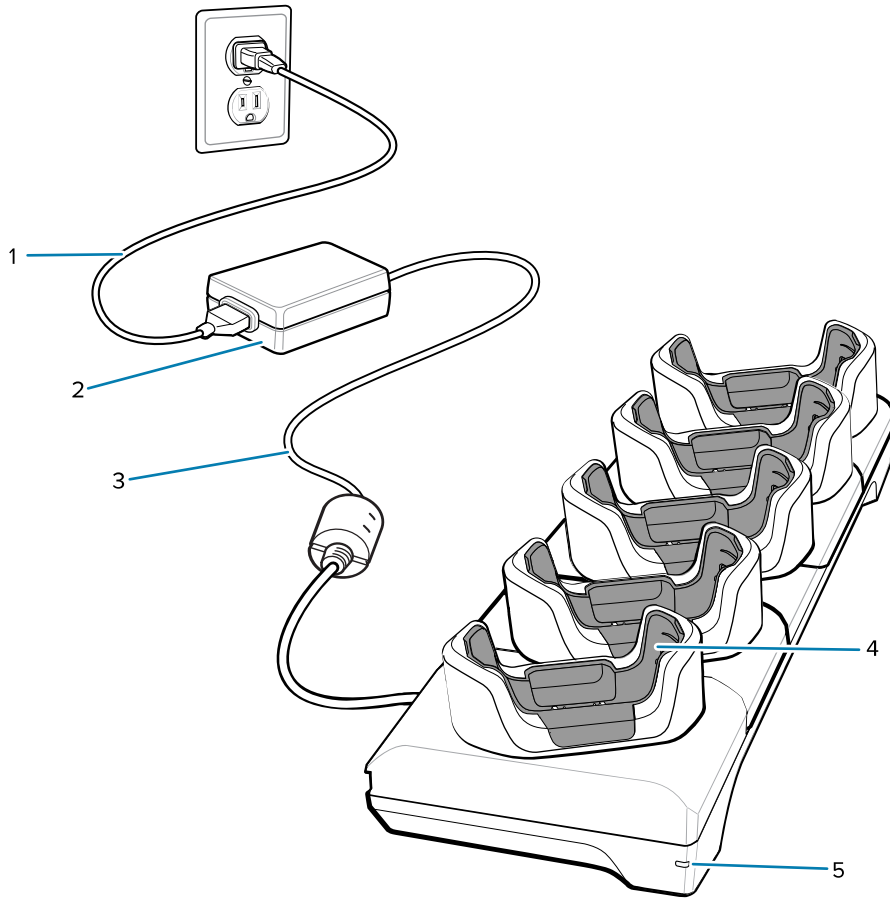

1	AC line cord
2	Power supply
3	DC line cord
4	Device charging slot
5	Power LED

### 5-Slot Ethernet Cradle



**CAUTION:** Ensure that you follow the guidelines for battery safety described in [Battery Safety Guidelines](#).



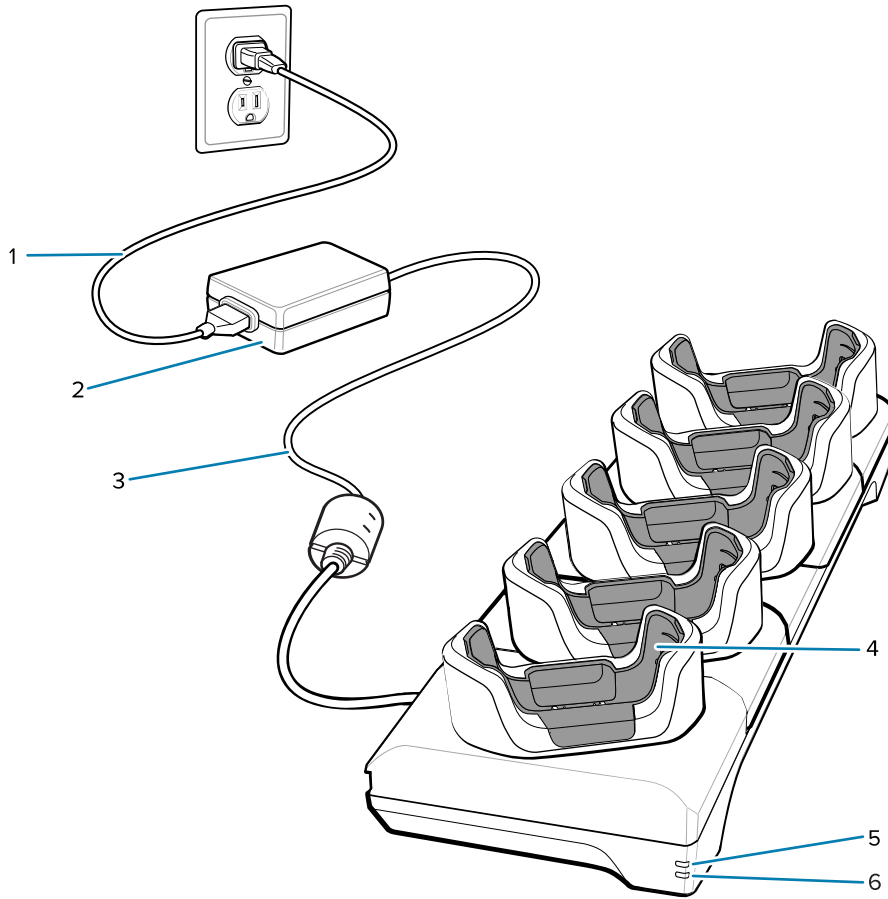

1	AC line cord
2	Power supply
3	DC line cord
4	Device charging slot
5	1000 LED
6	100/100 LED

#### 4-Slot Charge Only Cradle with Battery Charger



**CAUTION:** Ensure that you follow the guidelines for battery safety described in [Battery Safety Guidelines](#).

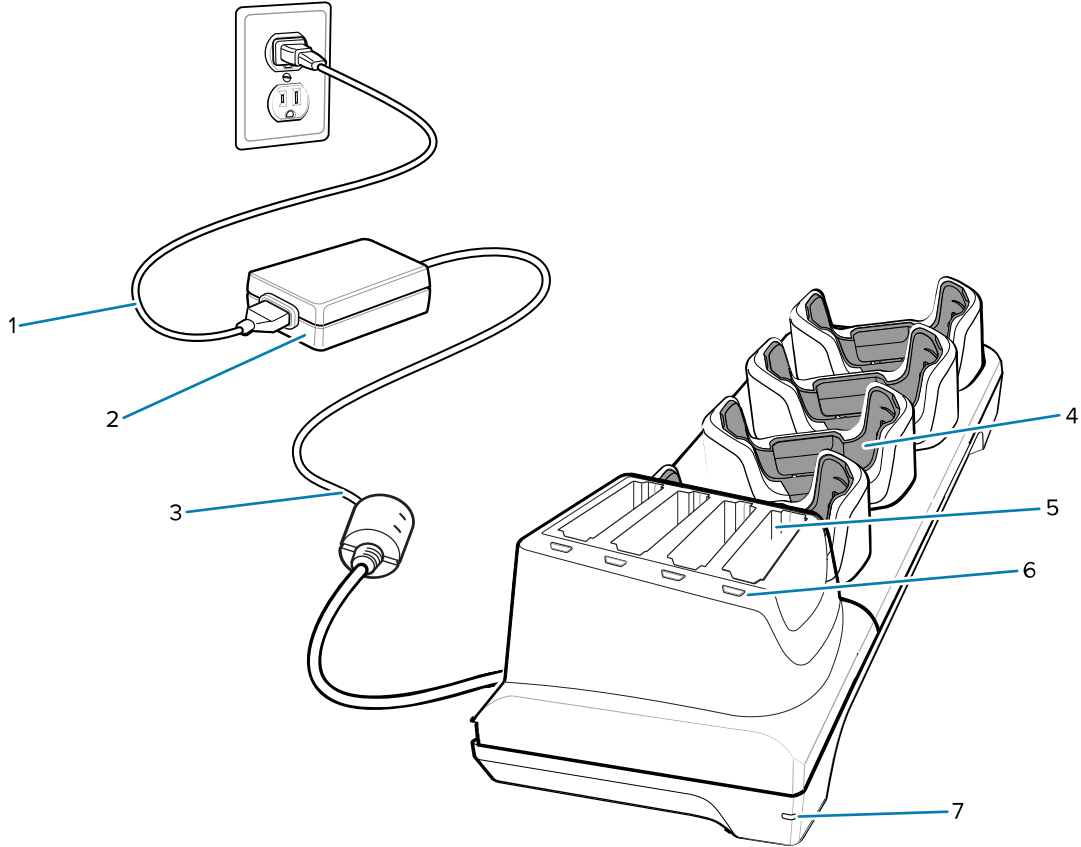

1	AC line cord
2	Power supply
3	DC line cord
4	Device charging slot
5	Spare battery charging slot
6	Spare battery charging LED
7	Power LED

### Charge/USB-C Cable

The USB-C Cable snaps onto the bottom of the device and removes easily when not in use. When attached to the device, it provides charging and allows the device to transfer data to a host computer.



**CAUTION:** Ensure that you follow the guidelines for battery safety described in [Battery Safety Guidelines](#).

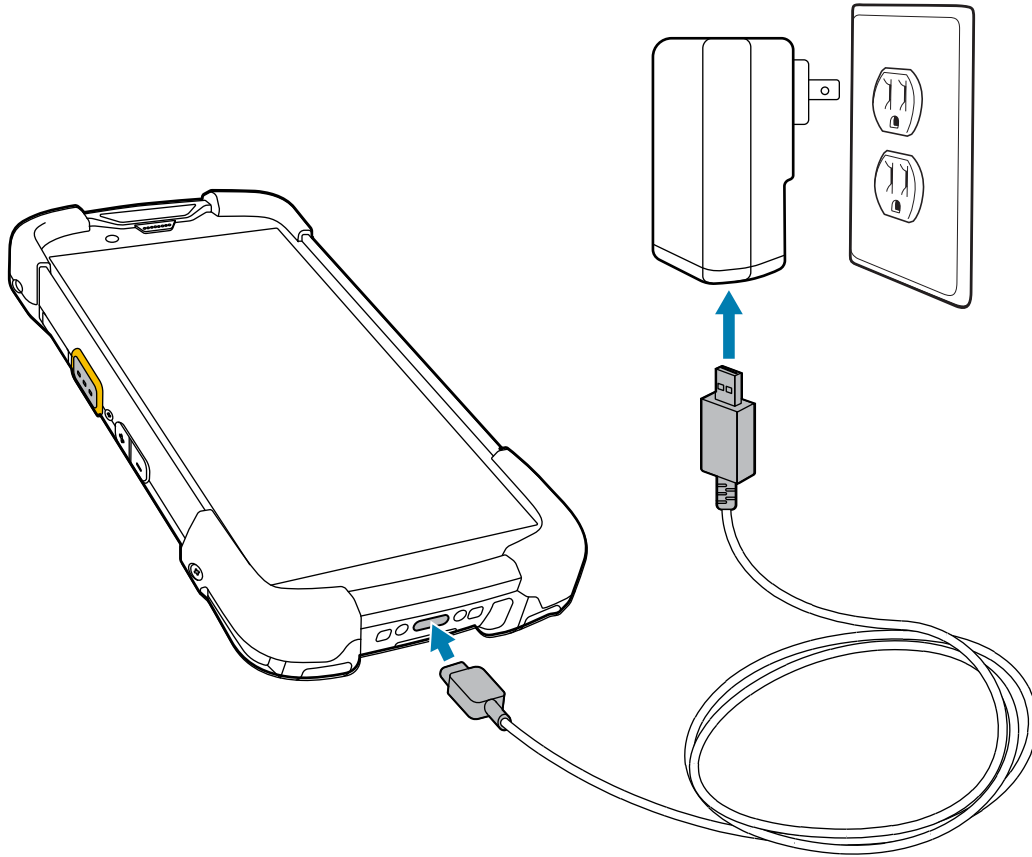

## Scanning with the Internal Imager

To read a barcode, a scan-enabled application is required. The device contains the DataWedge application, which allows you to enable the imager, decode the barcode data, and display the barcode content.



**NOTE:** The SE55 displays a green dash-dot-dash aimer. The SE4770 imager displays a red crosshair aimer.

1. Ensure that an application is open on the device and a text field is in focus (text cursor in text field).
2. Point the exit window on the top of the device at a barcode or QR code.

3. Press and hold the scan button.

The device projects the aiming pattern.

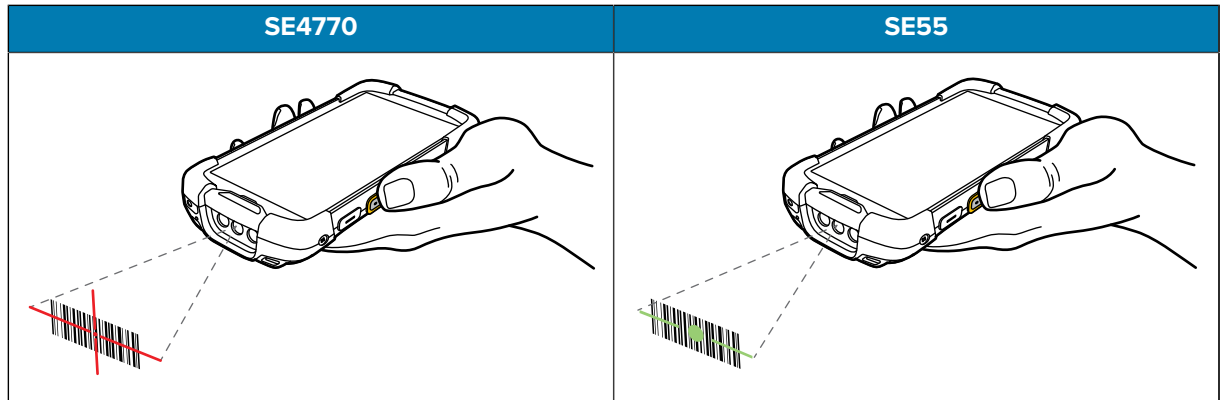

**NOTE:** Imager decoding usually occurs instantaneously. When the device is in Picklist mode, the imager does not decode the barcode until the red crosshair or green dash-dot-dash touches the barcode.

- Ensure that the barcode is within the area formed in the aiming pattern.

**Figure 3** Aiming Patterns

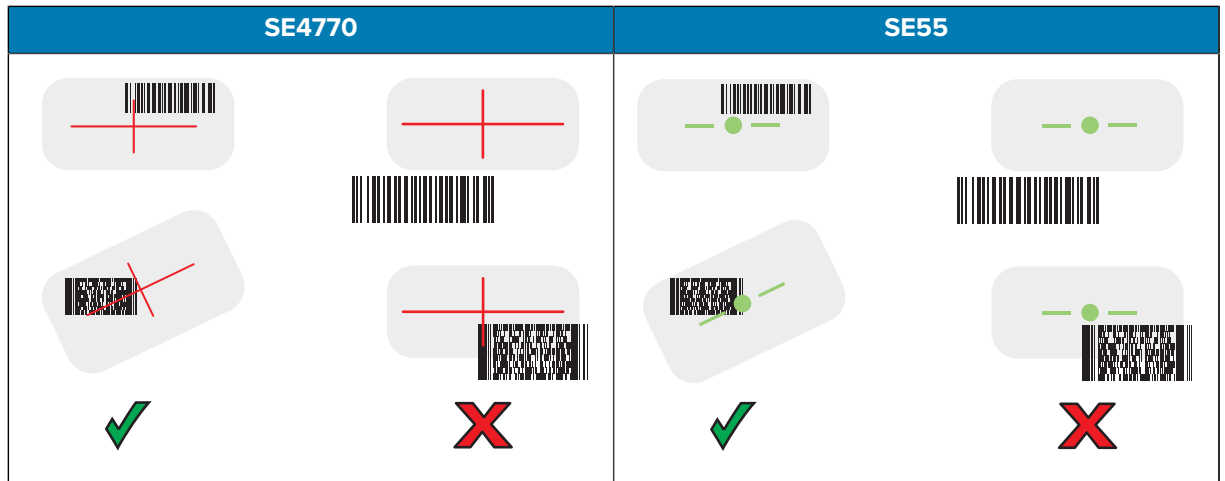

**Figure 4** Picklist Mode with Multiple Barcodes in Aiming Pattern

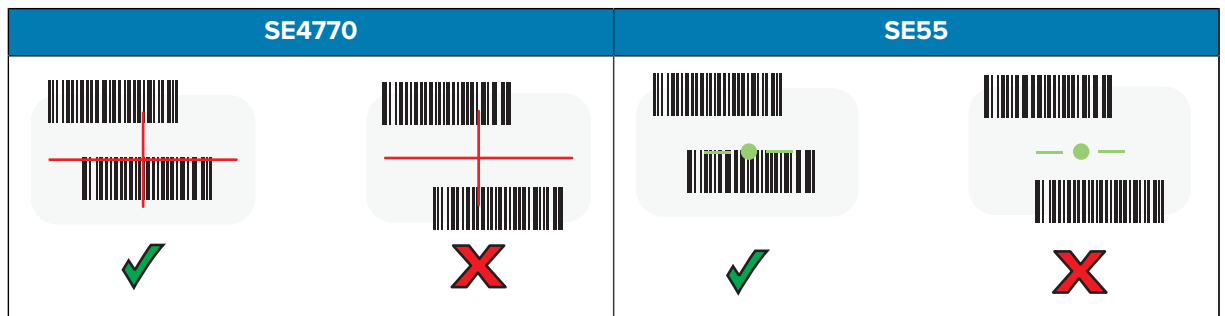

The Data Capture LED lights green, and the device beeps, by default, to indicate that the barcode or QR code was decoded successfully.



**NOTE:** The device repeats the steps required to take a digital picture (image) of a poor or difficult barcode as long as the scan button remains pressed.

- Release the scan button.

The device displays the barcode or QR code data in the text field.

## Ergonomic Considerations

Avoid extreme wrist angles such as these when using the device.

