

# MC3300x

## Mobile Computer

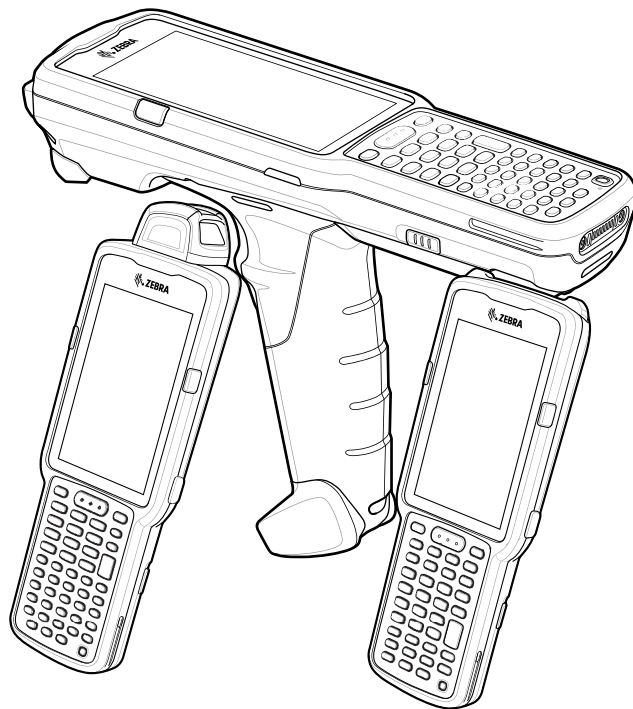

## Product Reference Guide for Android™ 11



**ZEBRA**

ZEBRA and the stylized Zebra head are trademarks of Zebra Technologies Corporation, registered in many jurisdictions worldwide. Google, Android, Google Play and other marks are trademarks of Google LLC. All other trademarks are the property of their respective owners.

© 2021 Zebra Technologies Corporation and/or its affiliates. All rights reserved.

For further information regarding legal and proprietary statements, go to:

COPYRIGHTS: [zebra.com/copyright](https://zebra.com/copyright)

WARRANTY: [zebra.com/warranty](https://zebra.com/warranty)

END USER LICENSE AGREEMENT: [zebra.com/eula](https://zebra.com/eula)

## Terms of Use

### Proprietary Statement

This manual contains proprietary information of Zebra Technologies Corporation and its subsidiaries (“Zebra Technologies”). It is intended solely for the information and use of parties operating and maintaining the equipment described herein. Such proprietary information may not be used, reproduced, or disclosed to any other parties for any other purpose without the express, written permission of Zebra Technologies.

### Product Improvements

Continuous improvement of products is a policy of Zebra Technologies. All specifications and designs are subject to change without notice.

### Liability Disclaimer

Zebra Technologies takes steps to ensure that its published Engineering specifications and manuals are correct; however, errors do occur. Zebra Technologies reserves the right to correct any such errors and disclaims liability resulting therefrom.

### Limitation of Liability

In no event shall Zebra Technologies or anyone else involved in the creation, production, or delivery of the accompanying product (including hardware and software) be liable for any damages whatsoever (including, without limitation, consequential damages including loss of business profits, business interruption, or loss of business information) arising out of the use of, the results of use of, or inability to use such product, even if Zebra Technologies has been advised of the possibility of such damages. Some jurisdictions do not allow the exclusion or limitation of incidental or consequential damages, so the above limitation or exclusion may not apply to you.

# Contents

<b>About This Guide</b> .....	<b>13</b>
Configurations .....	13
Notational Conventions .....	15
Icon Conventions .....	16
Service Information .....	16
Determining Software Versions.....	17
Determining the Serial Number .....	17
<b>Getting Started</b> .....	<b>18</b>
Unpacking .....	18
MC3300x-G Features.....	19
Front View .....	19
Back View.....	20
MC3300x-R Features.....	21
Rotating Scan Turret .....	21
Front View .....	21
Back View.....	22
MC3300x-S Features .....	23
Front View .....	23
Back View.....	24
Setting Up the Device .....	25
Installing a microSD Card .....	25
Installing the MC3300x-G Battery.....	27
Installing the MC3300x-R/S Battery .....	28
Charging the Battery.....	29
Charging Indicators .....	30
Charging Temperature .....	30
Charging Spare Batteries.....	31
Hot Swap Mode/Backup Power .....	31
Real-Time Clock Backup.....	31
Replacing the Battery in the MC3300x-G.....	32

Replacing the Battery in the MC3300x-R/S .....	33
<b>Using the Device.....</b>	<b>36</b>
Home Screen .....	36
Setting Home Screen Rotation .....	37
Status Bar .....	37
Notification Icons .....	38
Status Icons .....	39
Managing Notifications .....	40
Opening the Quick Access Panel .....	40
Quick Access Panel Icons.....	41
Editing Icons on the Quick Settings Bar .....	42
Battery Management.....	42
Checking Battery Status .....	42
Monitoring Battery Usage .....	42
Low Battery Notification .....	43
Interactive Sensor Technology.....	43
Waking the Device .....	43
USB Communication.....	43
Transferring Files.....	44
Transferring Photos .....	44
Disconnect from the Host Computer .....	44
<b>Settings.....</b>	<b>45</b>
Accessing Settings.....	45
Display Settings .....	45
Setting the Screen Brightness Manually.....	45
Setting Night Light .....	45
Setting Screen Rotation.....	46
Setting Screen Timeout .....	46
Setting Font Size .....	46
Touch Panel Mode .....	47
Setting the Date and Time .....	47
General Sound Setting.....	47
Sound Options .....	48
Setting Wake-Up Sources.....	48
Remapping a Button .....	49
Remappable Keys.....	50
UI Listed Keys .....	50
Other Remappable Keys .....	50
Non-Remappable Keys .....	51

Keyboards .....	51
Keyboard Configuration .....	51
Enabling Keyboards .....	51
Switching Between Keyboards.....	51
Using the Android and Gboard Keyboards .....	51
Edit Text .....	52
Entering Numbers, Symbols, and Special Characters .....	52
Using the Enterprise Keyboard .....	52
Numeric Tab.....	52
Alpha Tab.....	52
Additional Character Tab .....	52
Scan Tab.....	52
Language Usage.....	53
Changing the Language Setting .....	53
Adding Words to the Dictionary .....	53
Notifications.....	53
Setting App Notifications .....	53
Viewing Notification Settings for All Apps .....	54
Controlling Lock Screen Notifications .....	54
Blink Light.....	55
<b>Applications .....</b>	<b>56</b>
Accessing Apps.....	57
Switching Between Recent Apps.....	57
Battery Manager.....	57
Opening Battery Manager .....	58
Battery Manager Information Tab.....	58
Camera .....	60
Taking Photos.....	60
Recording Videos .....	61
Camera Settings.....	62
DataWedge Demonstration.....	63
Scanner Selection .....	63
PTT Express Voice Client .....	65
PTT Express User Interface .....	65
PTT Audible Indicator .....	66
PTT Notification Icons .....	66
Enabling PTT Communication.....	67
Selecting a Talk Group .....	67
PTT Communication.....	67
Creating a Group Call .....	67
Responding with a Private Response .....	67

Disabling PTT Communication .....	68
RxLogger.....	69
RxLogger Configuration.....	69
Configuration File .....	69
Enabling Logging.....	69
Disabling Logging .....	69
Extracting Log Files .....	69
Backing Up .....	69
RxLogger Utility .....	70
Initiating the Main Chat Head.....	70
Removing the Main Chat Head .....	70
Viewing Logs.....	70
Removing a Sub Chat Head Icon.....	70
Backing Up In Overlay View.....	70
<b>Data Capture .....</b>	<b>71</b>
Laser Scanning .....	71
Imaging .....	71
Operational Modes .....	71
Scanning Considerations .....	72
Scanning with Internal Imager.....	73
Scanning with Laser Scanner .....	74
Scanning with RS5100 Ring Scanner.....	74
Scanning with the RS6000 Bluetooth Ring Scanner.....	76
Scanning with RS507/RS507X Hands-Free Imager .....	78
Scanning with the DS2278 Digital Scanner .....	79
Scanning with the DS3678 Digital Scanner .....	80
Scanning with the DS3608 USB Scanner or DS3678 Bluetooth Scanner .....	82
Scanning with the LI3678 Linear Scanner .....	83
Pairing the Bluetooth Ring Scanner.....	84
Pairing in SSI Mode Using Near Field Communication .....	84
Pairing in HID Mode Using Near Field Communication.....	85
Pairing Using Simple Serial Interface .....	86
Pairing Using Bluetooth Human Interface Device .....	87
Pairing a Bluetooth Scanner .....	88
Pairing Using Simple Serial Interface .....	88
Pairing Using Bluetooth Human Interface Device .....	89
DataWedge .....	90
Enabling DataWedge.....	90
Disabling DataWedge.....	90
Supported Decoders.....	90

<b>Wireless</b> .....	<b>93</b>
Wireless Local Area Networks .....	93
Connecting to a Wi-Fi Network .....	94
Removing a Wi-Fi Network .....	94
WLAN Configuration .....	94
Configuring a Secure Wi-Fi Network .....	94
Manually Adding a Wi-Fi Network .....	95
Configuring for a Proxy Server .....	96
Configuring the Device to Use a Static IP Address .....	96
Wi-Fi Preferences .....	97
Additional Wi-Fi Settings .....	97
Wi-Fi Direct .....	98
Bluetooth .....	98
Adaptive Frequency Hopping .....	98
Security .....	99
Bluetooth Profiles .....	99
Bluetooth Power States .....	100
Bluetooth Radio Power .....	100
Enabling Bluetooth .....	101
Disabling Bluetooth .....	101
Discovering Bluetooth Device(s) .....	101
Changing the Bluetooth Name .....	101
Connecting to a Bluetooth Device .....	101
Selecting Profiles on the Bluetooth Device .....	102
Unpairing a Bluetooth Device .....	102
Using a Bluetooth Headset .....	102
Cast .....	102
Near Field Communications .....	102
Reading NFC Cards .....	103
Sharing Information Using NFC .....	104
Enterprise NFC Settings .....	105
<b>Accessories</b> .....	<b>106</b>
Introduction .....	106
MC3300x Accessories .....	106
Battery Charging .....	112
Main Battery Charging .....	112
Spare Battery Charging .....	112
Charging Temperature .....	113
1-Slot USB Charge Cradle .....	114
Setup .....	115

Charging the MC3300x Battery .....	115
Charging an MC3300x Spare Battery.....	115
Battery Charging in 1- Slot USB Charge Cradle.....	116
5-Slot Charge Only ShareCradle .....	117
Setup .....	118
Charging the MC3300x Battery .....	118
Battery Charging in the 5-Slot Charge Only ShareCradle .....	118
5-Slot Ethernet ShareCradle .....	119
Setup .....	120
Charging the MC3300x Battery .....	120
Battery Charging in the 5-Slot Ethernet ShareCradle.....	120
Daisy-chaining Ethernet ShareCradles .....	120
Ethernet Settings.....	121
Configuring Ethernet Proxy Settings .....	121
Configuring Ethernet Static IP Address.....	122
Establishing Ethernet Connection .....	123
LED Indicators .....	124
5-Slot ShareCradle with 4-Slot Battery Charger .....	125
Setup .....	126
Charging the MC3300x Battery .....	126
Charging Spare Batteries .....	126
Battery Charging in the 5-Slot ShareCradle with 4-Slot Battery Charger .....	126
5-Slot Ethernet ShareCradle with 4-Slot Battery Charger .....	127
Setup .....	128
Charging the MC3300x Battery .....	128
Charging Spare Batteries .....	128
Battery Charging in the 5-Slot Ethernet ShareCradle with 4-Slot Battery Charger.....	128
Daisy-chaining Ethernet Cradles .....	129
Ethernet Settings.....	129
Configuring Ethernet Proxy Settings .....	130
Configuring Ethernet Static IP Address.....	130
Establishing Ethernet Connection .....	131
LED Indicators .....	131
4-Slot Spare Battery Charger .....	133
Setup .....	133
Charging Spare Batteries .....	133
20-Slot Spare Battery Charger.....	135
Setup .....	135
Charging Spare Batteries .....	135
USB Charge Cable.....	137
Connecting the USB Charge Cable to Device.....	137



Connecting the USB Charge Cable to Host Computer.....	138
Main Battery Charging .....	138
Charging the Device .....	139
Main Battery Charging .....	139
Disconnecting the USB Charge Cable .....	139
MC33XX Charge Only Adapter .....	141
MC33XX Charge Only Adapter Installation .....	141
MC3300x-G Rubber Boot.....	143
MC3300x-R Rubber Boot.....	144
MC3300x-S Rubber Boot.....	145
Rigid Holster.....	146
MC3300x-G Fabric Holster .....	148
Belt Strap.....	148
Shoulder Strap.....	148
Using the Belt Strap.....	149
Using the Shoulder Strap .....	150
MC3300x-R/S Fabric Holster .....	152
Belt Clip .....	152
Shoulder Strap.....	152
Using the Belt Clip .....	153
Using the Shoulder Strap .....	154
Un-powered Forklift Mount.....	155
Replacement Hand Strap for MC3300x-G .....	157
Replacement Hand Strap for MC3300x-R/S .....	158
<b>Application Deployment.....</b>	<b>160</b>
Security .....	160
Secure Certificates.....	160
Installing a Secure Certificate .....	160
Configuring Credential Storage Settings .....	161
Development Tools .....	161
Android Application Development .....	161
Development Workstation .....	161
Enabling Developer Options .....	161
EMDK for Android.....	162
StageNow .....	162
GMS Restricted.....	162
ADB USB Setup .....	162
Enabling USB Debugging.....	162
Entering Android Recovery Manually .....	163
Application Installation .....	163

Installing Applications Using the USB Connection .....	164
Installing Applications Using the Android Debug Bridge .....	164
Installing Applications Using the Wireless Android Debug Bridge.....	165
Installing Applications Using a microSD Card .....	166
Uninstalling an Application .....	166
Performing a System Update .....	166
Downloading the System Update Package .....	167
Performing a System Update Using microSD Card.....	167
Performing a System Update Using ADB.....	167
Verifying System Update Installation.....	168
Enterprise Reset .....	168
Performing an Enterprise Reset From Device Settings.....	168
Downloading the Enterprise Reset Package .....	168
Performing an Enterprise Reset Using microSD Card .....	169
Performing an Enterprise Reset Using ADB.....	169
Performing a Factory Reset .....	170
Downloading the Factory Reset Package .....	170
Performing a Factory Reset Using microSD Card.....	170
Performing a Factory Reset Using ADB .....	171
Storage.....	171
Random Access Memory .....	172
Viewing Memory.....	172
Internal Storage.....	172
Viewing Internal Storage .....	172
External Storage.....	172
Viewing External Storage .....	172
Formatting a microSD Card or USB Drive as Portable Storage.....	173
Formatting a microSD Card as Internal Memory.....	173
Enterprise Folder .....	173
Managing Apps .....	173
App Details .....	173
Managing Downloads.....	174
<b>Maintenance and Troubleshooting .....</b>	<b>175</b>
Maintaining the Device.....	175
Battery Safety Guidelines.....	175
Cleaning Instructions.....	176
Approved Cleanser Active Ingredients .....	176
Harmful Ingredients .....	177
Device Cleaning Instructions .....	177
Special Cleaning Notes .....	177

Cleaning Materials Required .....	177
Cleaning Frequency .....	178
Cleaning the Device .....	178
Housing .....	178
Display .....	178
Camera and Exit Window .....	178
Cleaning Battery Connectors.....	178
Cleaning Cradle Connectors .....	178
Troubleshooting .....	179
Resetting the Device .....	179
Performing a Soft Reset.....	179
Performing a Hard Reset .....	179
MC3300x .....	180
1-Slot USB Charge Cradle .....	181
5-Slot Charge Only ShareCradle.....	183
5-Slot Ethernet ShareCradle .....	184
5-Slot ShareCradle with 4-Slot Battery Charger.....	184
5-Slot Ethernet ShareCradle with 4-Slot Battery Charger .....	185
4-Slot Spare Battery Charger .....	186
20-Slot Spare Battery Charger .....	187
USB Charge Cable .....	188
<b>Technical Specifications.....</b>	<b>189</b>
Introduction .....	189
Data Capture Supported Symbologies.....	189
SE965 Decode Zone .....	189
SE4770/SE4720 Decode Zone .....	190
SE4770/SE4720 Decode Zone Dark Room .....	191
SE4850-ER Decode Zone .....	191
MC3300x Accessory Technical Specifications.....	192
MC3300x Connector Pin-Out .....	192
1-Slot USB Charge Cradle with Spare Battery Charger Technical Specifications .....	193
5-Slot Charge Only ShareCradle Technical Specifications .....	193
5-Slot Ethernet ShareCradle Technical Specifications.....	194
5-Slot Charge ShareCradle with 4-Slot Battery Charger Technical Specifications .....	194
5-Slot Ethernet ShareCradle with 4-Slot Battery Charger Technical Specifications .....	195
4-Slot Spare Battery Charger Technical Specifications.....	195
20-Slot Spare Battery Charger Technical Specifications.....	196

USB Charge Cable Technical Specifications .....	197
<b>Keypads</b> .....	<b>198</b>
Introduction .....	198
MC3300x 29-Key Keypad .....	198
MC3300x 38-Key Keypad .....	201
MC3300x 47-Key Keypad .....	205
<b>Index</b> .....	<b>209</b>

# About This Guide

## Configurations

MC3300x used in this guide refers to all configurations, except where noted. MC3300x-G refers to the Trigger configuration. MC3300x-R refers to the Rotate configuration. MC3300x-S refers to the Straight configuration. MC3300x-S45 refers to the 45 degree angle Straight configuration.

This guide covers the following configurations:

**Table 1** Configurations

Form Factor	Radios	Display	Memory	Data Capture Options	Camera	USB Cable & Power Adapter	Operating System
Gun	WLAN: IEEE® 802.11a/b/g/n/ac WPAN: Bluetooth V5.0, V2.1 + EDR w/ Bluetooth Low Energy (BLE) NFC	4.0" WVGA Color	4 GB RAM / 16 GB Flash	SE965 1D Laser SE4720 1D/2D Imager	No	Yes	Android-based AOSP 11
Gun	WLAN: IEEE® 802.11a/b/g/n/ac WPAN: Bluetooth V5.0, V2.1 + EDR w/ Bluetooth Low Energy (BLE) NFC	4.0" WVGA Color	4 GB RAM / 32 GB Flash	SE965, 1D Laser SE4770 1D/2D Imager SE4850 1D/2D ERI	No	No	Android-based AOSP 11
Gun	WLAN: IEEE® 802.11a/b/g/n/ac WPAN: Bluetooth V5.0, V2.1 + EDR w/ Bluetooth Low Energy (BLE) NFC	4.0" WVGA Color	4 GB RAM / 32 GB Flash	SE965 1D Laser SE4770 1D/2D Imager SE4850 1D/2D ERI	No	No	Android-based GMS 11

## About This Guide

**Table 1** Configurations (Continued)

Form Factor	Radios	Display	Memory	Data Capture Options	Camera	USB Cable & Power Adapter	Operating System
Rotate	WLAN: IEEE® 802.11a/b/g/n/ac WPAN: Bluetooth V5.0, V2.1 + EDR w/ Bluetooth Low Energy (BLE) NFC	4.0" WVGA Color	4 GB RAM / 32 GB Flash	SE965 1D Laser	No	No	Android-based AOSP 11
Rotate	WLAN: IEEE® 802.11a/b/g/n/ac WPAN: Bluetooth V5.0, V2.1 + EDR w/ Bluetooth Low Energy (BLE) NFC	4.0" WVGA Color	4 GB RAM / 32 GB Flash	SE965 1D Laser	No	No	Android-based GMS 11
Rotate	WLAN: IEEE® 802.11a/b/g/n/ac WPAN: Bluetooth V5.0, V2.1 + EDR w/ Bluetooth Low Energy (BLE) NFC	4.0" WVGA Color	4 GB RAM / 32 GB Flash	SE965 1D Laser	Yes	No	Android-based GMS 11
Straight	WLAN: IEEE® 802.11a/b/g/n/ac WPAN: Bluetooth V5.0, V2.1 + EDR w/ Bluetooth Low Energy (BLE) NFC	4.0" WVGA Color	4 GB RAM / 16 GB Flash	SE965 1D Laser SE4720 1D/2D Imager	No	Yes	Android-based AOSP 11
Straight	WLAN: IEEE® 802.11a/b/g/n/ac WPAN: Bluetooth V5.0, V2.1 + EDR w/ Bluetooth Low Energy (BLE) NFC	4.0" WVGA Color	4 GB RAM / 32 GB Flash	SE4770 1D/2D Imager SE4850 1D/2D ERI	No	No	Android-based AOSP 11
Straight	WLAN: IEEE® 802.11a/b/g/n/ac WPAN: Bluetooth V5.0, V2.1 + EDR w/ Bluetooth Low Energy (BLE) NFC	4.0" WVGA Color	4 GB RAM / 32 GB Flash	SE4770 1D/2D Imager SE4850 1D/2D ERI	Yes	No	Android-based AOSP 11

**Table 1** Configurations (Continued)

Form Factor	Radios	Display	Memory	Data Capture Options	Camera	USB Cable & Power Adapter	Operating System
Straight	WLAN: IEEE® 802.11a/b/g/n/ac WPAN: Bluetooth V5.0, V2.1 + EDR w/ Bluetooth Low Energy (BLE) NFC	4.0" WVGA Color	4 GB RAM / 32 GB Flash	SE965 1D Laser SE4770 1D/2D Imager SE4850 1D/2D ERI	No	No	Android-based GMS 11
Straight	WLAN: IEEE® 802.11a/b/g/n/ac WPAN: Bluetooth V5.0, V2.1 + EDR w/ Bluetooth Low Energy (BLE) NFC	4.0" WVGA Color	4 GB RAM / 32 GB Flash	SE965 1D Laser SE4770 1D/2D Imager SE4850 1D/2D ERI	Yes	No	Android-based GMS 11
Straight @45	WLAN: IEEE® 802.11a/b/g/n/ac WPAN: Bluetooth V5.0, V2.1 + EDR w/ Bluetooth Low Energy (BLE) NFC	4.0" WVGA Color	4 GB RAM / 32 GB Flash	SE4770 1D/2D Imager SE4850 1D/2D ERI	No	No	Android-based AOSP 11
Straight @45	WLAN: IEEE® 802.11a/b/g/n/ac WPAN: Bluetooth V5.0, V2.1 + EDR w/ Bluetooth Low Energy (BLE) NFC	4.0" WVGA Color	4 GB RAM / 32 GB Flash	SE4770 1D/2D Imager	No	No	Android-based GMS 11
Straight @ 45	WLAN: IEEE® 802.11a/b/g/n/ac WPAN: Bluetooth V5.0, V2.1 + EDR w/ Bluetooth Low Energy (BLE) NFC	4.0" WVGA Color	4 GB RAM / 32 GB Flash	SE4770 1D/2D Imager	Yes	No	Android-based GMS 11

## Notational Conventions

Notational conventions are used to highlight important information.

- **Bold** text is used to highlight the following:
  - Dialog box, window and screen names
  - Drop-down list and list box names
  - Check box and radio button names
  - Icons on a screen

- Key names on a keypad
- Button names on a screen
- Bullets (•) indicate:
  - Action items
  - Lists of alternatives
  - Lists of required steps that are not necessarily sequential.
- Sequential lists (for example, those that describe step-by-step procedures) appear as numbered lists.

## Icon Conventions

The following icons are used throughout the document. The icons and their associated meanings are described below.



**NOTE:** The text here indicates information that is supplemental for the user to know and that is not required to complete a task.



**IMPORTANT:** The text here indicates information that is important for the user to know.



**CAUTION:** If the precaution is not heeded, the user could receive minor or moderate injury.



**WARNING:** If danger is not avoided, the user CAN be seriously injured or killed.



**DANGER:** If danger is not avoided, the user WILL be seriously injured or killed.

## Service Information

If you have a problem with your equipment, contact Customer Support for your region. Contact information is available at: [zebra.com/support](http://zebra.com/support).

When contacting support, please have the following information available:

- Serial number of the unit (found on manufacturing label)
- Model number or product name (found on manufacturing label)
- Software type and version number

Customer Support responds to calls by email or telephone within the time limits set forth in support agreements.

If the problem cannot be solved by Customer Support, the user may need to return the equipment for servicing and will be given specific directions. We are not responsible for any damages incurred during shipment if the approved shipping container is not used. Shipping the units improperly can possibly void the warranty. If applicable, remove the microSD card from the device before shipping for service.

If the device was purchased from a business partner, contact that business partner for support.



## Determining Software Versions

Before contacting Customer Support, determine the current software version on your device.

1. Swipe down from the Status bar with two fingers to open the Quick Access panel, and then touch .
2. Touch **About phone**.
3. Scroll to view the following information:
  - **Android security update**
  - **Google Play system update**
  - **Kernel version**
  - **Build number**

## Determining the Serial Number

Before contacting Customer Support, determine the serial number of your device.

1. Swipe down from the Status bar with two fingers to open the Quick Access panel, and then touch .
2. Touch **About phone > Model & hardware > Serial number**.

# Getting Started

## Unpacking

1. Carefully remove all protective material from the device and save the shipping container for later storage and shipping.
2. Verify that the following are included:
  - Mobile computer
  - Lithium-ion battery
  - Regulatory Guide.
3. Inspect the equipment for damage. If any equipment is missing or damaged, contact the Global Customer Support center immediately.

## MC3300x-G Features

### Front View

Figure 1 MC3300x-G Front View

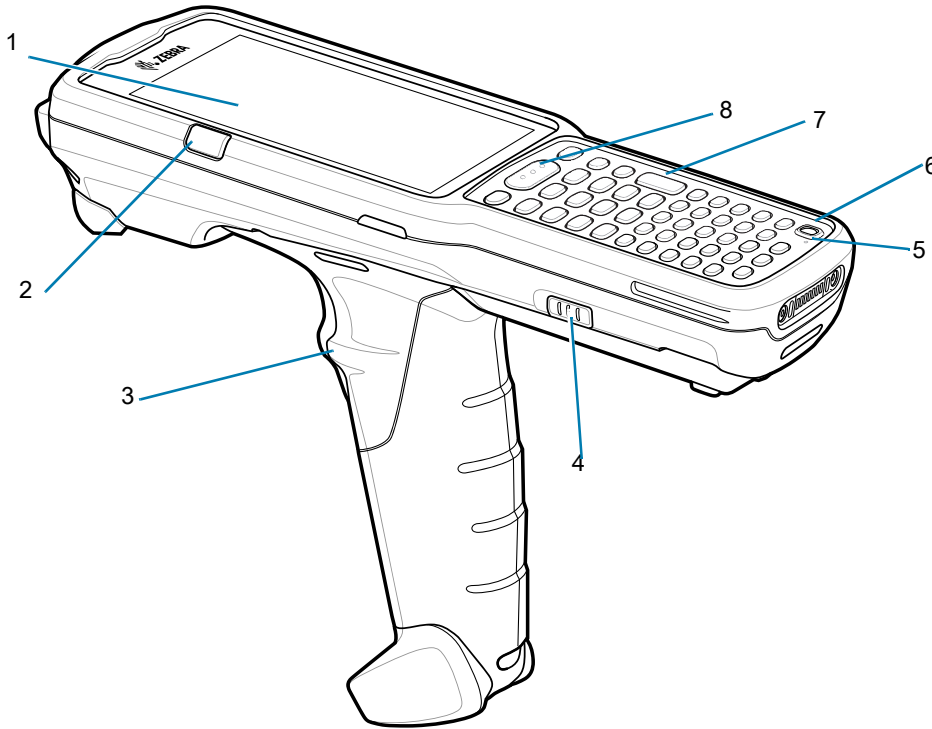

**NOTE:** The MC3300x-G does not ship with a pre-installed hand strap. However, one can be purchased separately as a standalone accessory (SG-MC33-HDSTPG-01) if required.

Table 2 MC3300x-G Features - Front View

Number	Item	Function
1	Display	Displays all information needed to operate the device.
2	Charge /Application Notification LED or Scan/Decode Status	Indicates the battery charge state while charging, an application notification was received, or the scan/decode status.
3	Trigger	Initiates data capture when a scan application is enabled.
4	Battery Release Latch	Release the battery from the device.
5	Microphone	Use for communications in Handset mode.

**Table 2** MC3300x-G Features - Front View (Continued)

Number	Item	Function
6	Power Key	Press to suspend and resume device. Long press provides the following options: <b>Power off</b> - Turn off the device. <b>Restart</b> - Reboot the device when software stops responding.
7	Keypad	Use to enter data and navigate on screen functions.
8	Scan Button	Initiates data capture when a scan application is enabled.

## Back View

**Figure 2** MC3300x-G Back View

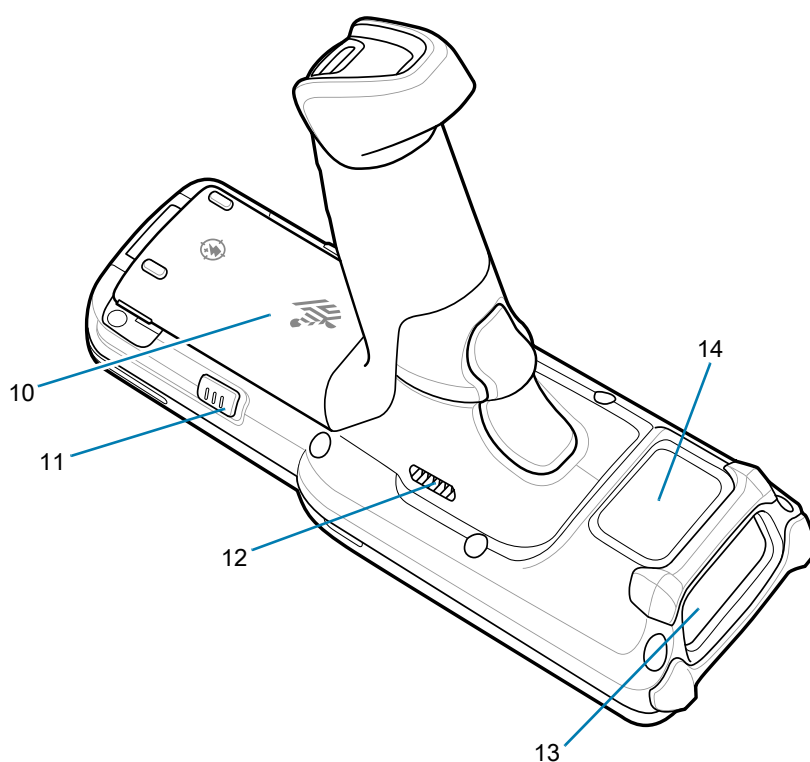

**Table 3** MC3300x-G Features - Back View

Number	Item	Function
10	Battery	Provides power for operating the device.
11	Battery Release Latch	Release the battery from the device.
12	Speaker	Provides audio output for video and music playback.
13	Scanner Exit Window	Provides data capture using integrated scanner/imager option.
14	NFC Antenna	Provides communication with other NFC-enabled devices.

## MC3300x-R Features

### Rotating Scan Turret

The MC3300x-R features a Rotating Turret with three position stops. This feature offers greater scanning flexibility.



**CAUTION:** Do not try to rotate the turret past the side position stops. Damage to device may occur.

Figure 3 MC3300x-R Rotating Turret

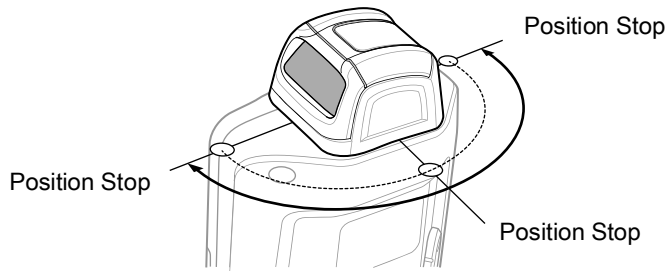

### Front View

Figure 4 MC3300x-R Front View

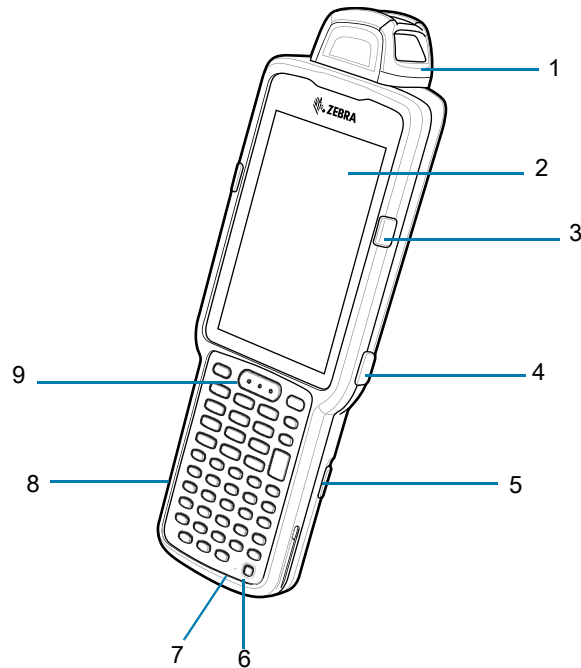
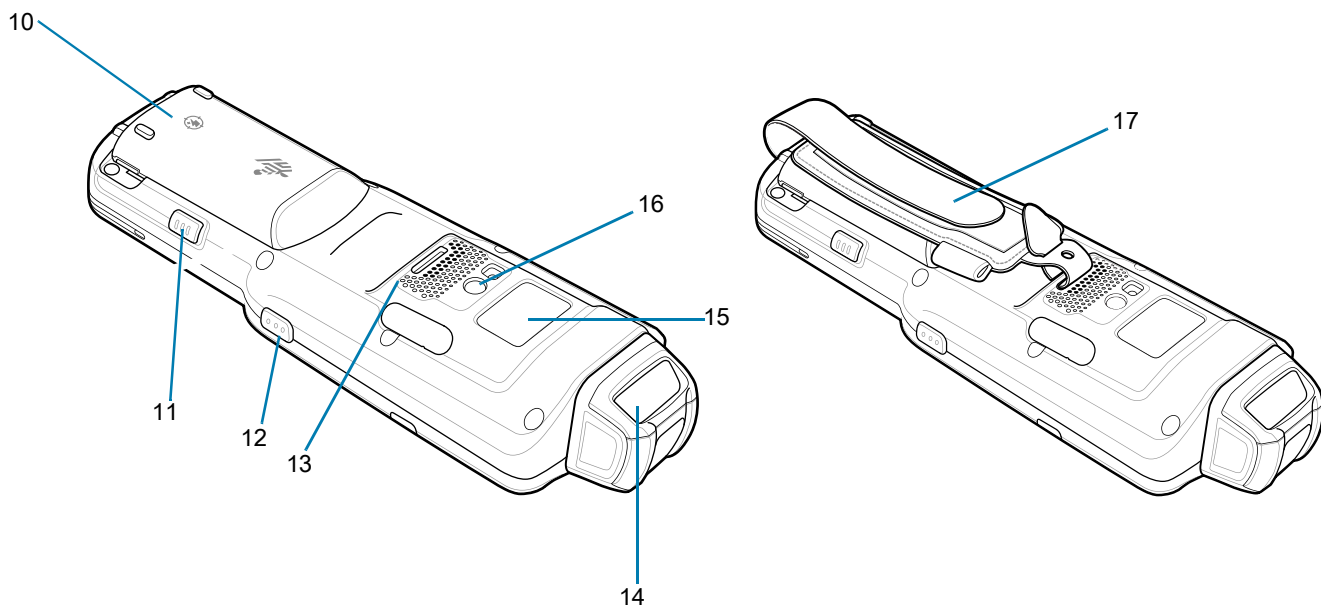

**Table 4** MC3300x-R Features - Front View

Number	Item	Function
1	Rotating Turret	Rotates for easy scanning positions.
2	Display	Displays all information needed to operate the device.
3	Charge /Application Notification LED or Scan/Decode Status	Indicates the battery charge state while charging, an application notification was received, or the scan/decode status.
4	Side Key Scan Button	Initiates data capture when a scan application is enabled.
5	Battery Release Latch	Release the battery from the device.
6	Power Key	Press to suspend and resume device. Long press provides the following options: <b>Power off</b> - Turn off the device. <b>Restart</b> - Reboot the device when software stops responding.
7	Microphone	Use for communications in Handset mode.
8	Keypad	Use to enter data and navigate on screen functions.
9	Scan Button	Initiates data capture when a scan application is enabled.

## Back View

**Figure 5** MC3300x-R Back View



**Table 5** MC3300x-R Features - Back View

Number	Item	Function
10	Battery	Provides power for operating the device.
11	Battery Release Latch	Release the battery from the device.
12	Side Key Scan Button	Initiates data capture when a scan application is enabled.
13	Speaker	Provides audio output for video and music playback.
14	Scanner Exit Window	Provides data capture using the scanner.
15	NFC Antenna	Provides communication with other NFC-enabled devices.
16	Camera/Flash	Provides image capture capability with LED illumination.
17	Hand Strap	Use for securely holding the device. Comes pre-installed on every MC3300x-S & MC3300x-R device.

## MC3300x-S Features

### Front View

**Figure 6** MC3300x-S Front View

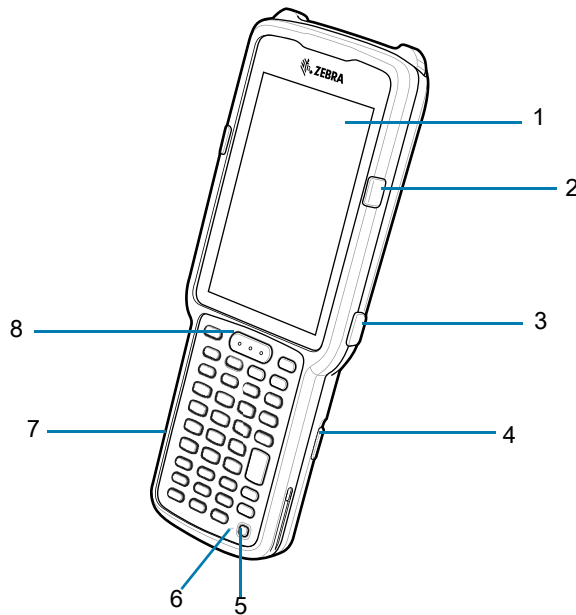
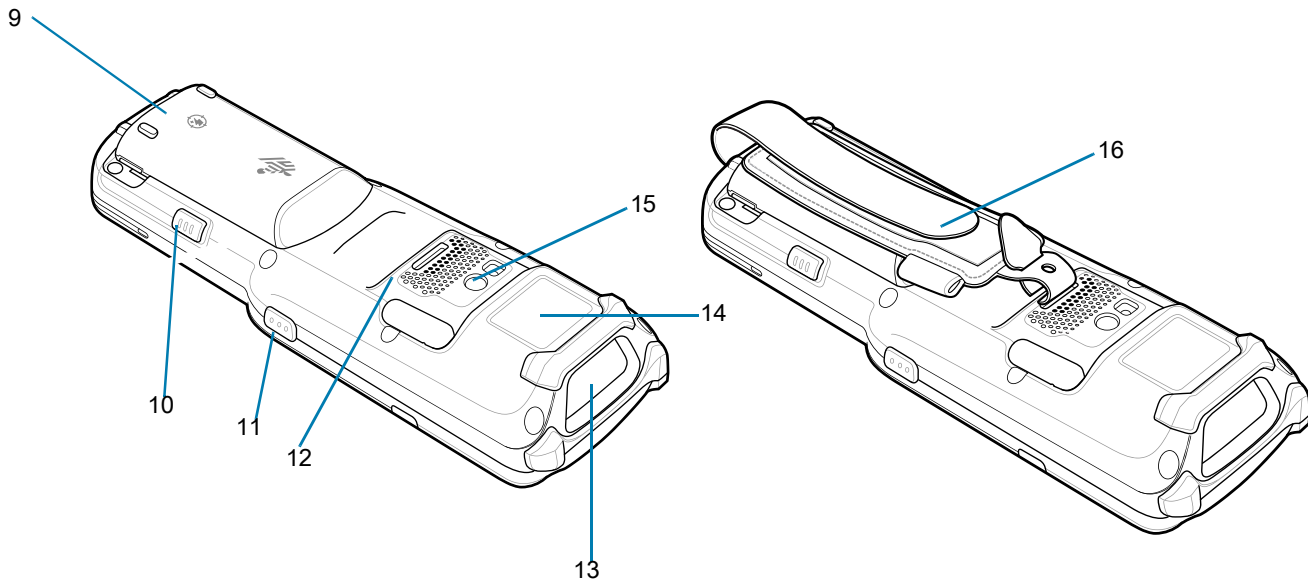

**Table 6** MC3300x-S Features - Front View

Number	Item	Function
1	Display	Displays all information needed to operate the device.
2	Charge /Application Notification LED or Scan/Decode Status	Indicates the battery charge state while charging, an application notification was received, or the scan/decode status.
3	Side Key Scan Button	Initiates data capture when a scan application is enabled.
4	Battery Release Latch	Release the battery from the device.
5	Power Key	Press to suspend and resume device. Long press provides the following options: <b>Power off</b> - Turn off the device. <b>Restart</b> - Reboot the device when software stops responding.
6	Microphone	Use for communications in Handset mode.
7	Keypad	Use to enter data and navigate on screen functions.
8	Scan Button	Initiates data capture when a scan application is enabled.

## Back View

**Figure 7** MC3300x-S Back View





**Table 7** MC3300x-S Features - Back View

Number	Item	Function
9	Battery	Provides power for operating the device.
10	Battery Release Latch	Release the battery from the device.
11	Side Key Scan Button	Initiates data capture when a scan application is enabled.
12	Speaker	Provides audio output for video and music playback.
13	Scanner Exit Window	Provides data capture using the scanner.
14	NFC Antenna	Provides communication with other NFC-enabled devices.
15	Camera/Flash	Provides image capture capability with LED illumination.
16	Hand Strap	Use for securely holding the device. Comes pre-installed on every MC3300x-S & MC3300x-R device.

## Setting Up the Device

To start using the device for the first time:

- Install a micro secure digital (SD) card (optional)
- Install the battery
- Charge the device
- Power on the device.

### Installing a microSD Card

The microSD card slot provides secondary non-volatile storage. The slot is located under the battery pack. Refer to the documentation provided with the card for more information, and follow the manufacturer's recommendations for use.



**CAUTION:** Follow proper electrostatic discharge (ESD) precautions to avoid damaging the microSD card. Proper ESD precautions include, but are not limited to, working on an ESD mat and ensuring that the operator is properly grounded.

1. Using a coin or finger, remove the microSD card cover.

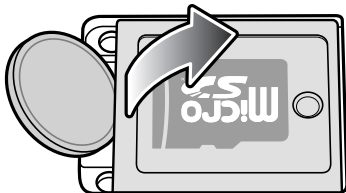

2. Slide the microSD card holder to the Open position.

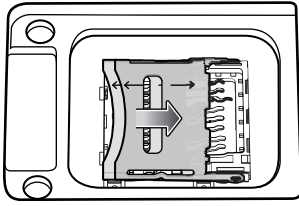

3. Lift the microSD card holder.

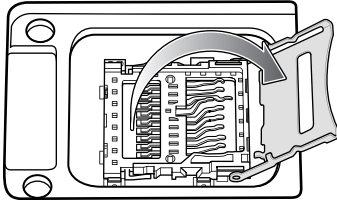

4. Place the microSD card into the contact area with the contacts facing down.

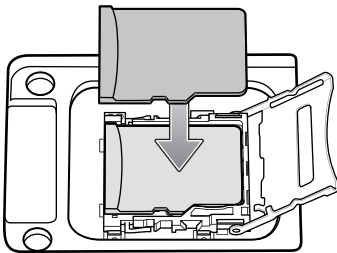

5. Close the microSD card holder and slide the microSD card holder to the Lock position.

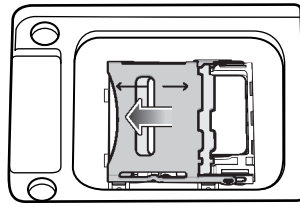
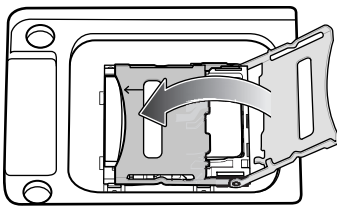

6. Replace the microSD card cover and ensure that it is installed properly.

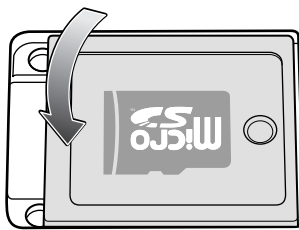
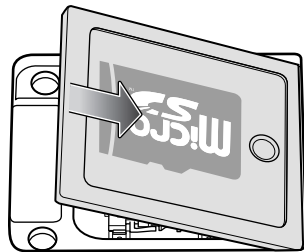

## Installing the MC3300x-G Battery

The MC3300x-G is compatible with the following batteries:

- MC3300x 7000 mAh PowerPrecision+ extended battery
- MC33XX 5200 mAh PowerPrecision+ high capacity battery

To install the battery:

1. Loosen the hand strap (if installed).
2. Align the battery into the battery compartment.

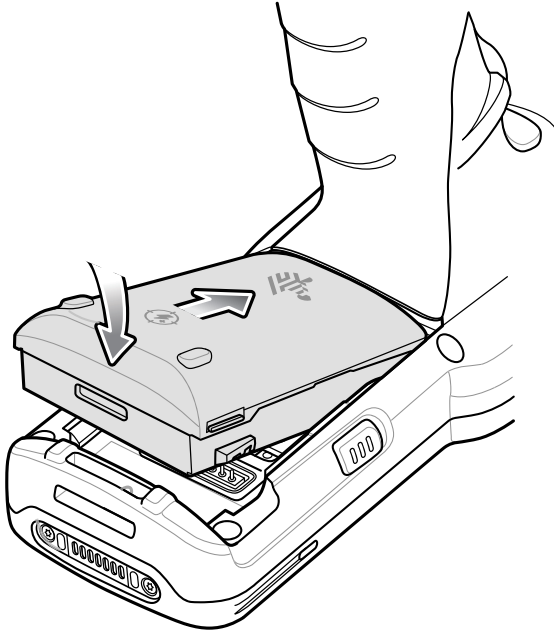

3. Slide the front of the battery into the battery compartment.
4. Press battery down firmly. Ensure that both battery release buttons on the sides of the MC3300x-G return to the home position.

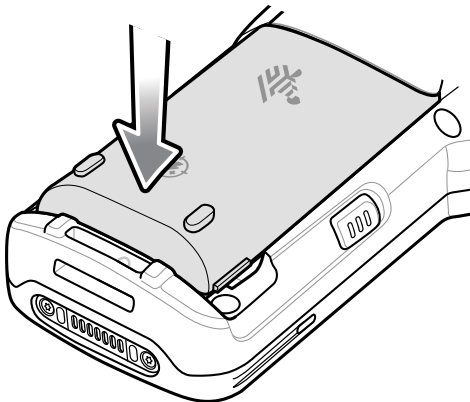

5. Tighten the hand strap (if installed).
6. Press and hold the Power key (until you see a Zebra splash screen) to turn on the device.

## Installing the MC3300x-R/S Battery

The MC3300x-R/S is compatible with the following batteries:

- MC3300x 7000 mAh PowerPrecision+ extended battery
- MC33XX 5200 mAh PowerPrecision+ high capacity battery
- MC33XX 2740 mAh PowerPrecision+ standard battery

To install the battery:

1. Loosen the hand strap, if needed.
2. Align the top of the battery into the battery compartment.

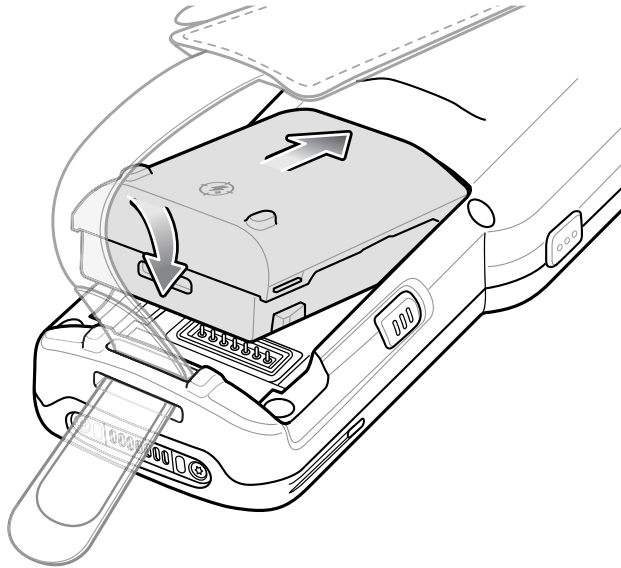

3. Slide the front of the battery into the battery compartment.
4. Press battery down firmly. Ensure that both battery release buttons on the sides of the MC3300x-R/S return to the home position.

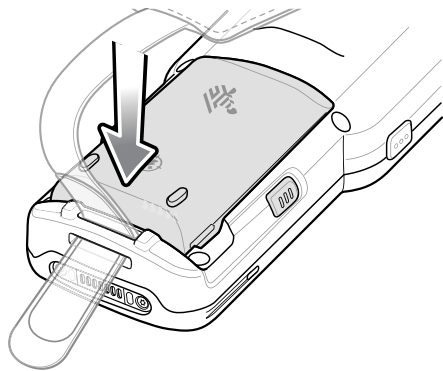

5. Tighten the hand strap, if needed.
6. Press and hold the Power key (until you see a Zebra splash screen) to turn on the device.

## Charging the Battery



**CAUTION:** Ensure that you follow the guidelines for battery safety described in [Battery Safety Guidelines on page 213](#).

Use the mobile computer cradles, cables and spare battery chargers to charge the mobile computer main battery. The main battery can be charged before insertion into the mobile computer or after it is installed.

The main battery that ships with the MC3300x device is the 7000 mAh PowerPrecision+ extended capacity battery pack (2.5X). The two legacy MC33 PowerPrecision+ batteries; 5200 mAh high capacity battery pack (2X) and the 2740 mAh standard capacity battery pack (1X) can be purchased separately for the MC3300x device.

The MC3300x-G is only compatible with the 7000 mAh (2.5X) and the 5200 mAh (2X) PowerPrecision+ batteries.

The MC3300x-R/S is compatible with all three PowerPrecision+ battery packs; 7000 mAh (2.5X), 5200 mAh (2X) and 2740 mAh (1X).

Use one of the spare battery chargers to charge the main battery (out of the mobile computer) or one of the cradles to charge the main battery while it is installed in the mobile computer.

Before using the mobile computer for the first time, fully charge the main battery until the green Charge LED indicator remains lit and charge the battery using a cable or a cradle with the appropriate power supply. For information about the accessories available for the MC3300x, see [Accessories](#).

The MC3300x retains data in memory for at least five minutes when the mobile computer's main battery is removed.

When the main battery reaches a critical battery level state (6%), the device shuts down.

Batteries must be charged within the 0° to +40° C (32° to 104° F) ambient temperature range.

The following accessories can be used to charge batteries:

- Cradles (and a power supply):
  - 1-Slot USB Charge Cradle
  - 5-Slot Charge Only ShareCradle
  - 5-Slot Ethernet ShareCradle
  - 5-Slot Charge ShareCradle + 4-Slot Spare Battery Charger
  - 5-Slot Ethernet ShareCradle + 4-Slot Spare Battery Charger.
- Cables (and a power supply):
  - USB Charge Cable.
- Spare Battery Chargers (and a power supply):
  - 4-Slot Spare Battery Charger
  - 20-Slot Spare Battery Charger.



**NOTE:** It is safe to leave the mobile computer and/or batteries on the charger for prolong durations. Both the spare and terminal-based chargers stop charging when they detect that the battery is fully charged. Upon stopping, the batteries will slowly self-discharge, and if left on the charger long enough, will eventually fall to a point where the charger re-initiates a charge until the batteries are fully charged again.

To charge the mobile computer using the cradles:

1. Insert the mobile computer into a cradle. See [Accessories](#) for accessory setup.

2. The mobile computer starts to charge automatically. The Charge LED Indicator indicates the charge status. See the table below for charging indications.

To charge the mobile computer using the cables:

1. Connect the MC3300x Communication/Charge Cable to the appropriate power source and connect to the mobile computer. See [Accessories](#) for accessory setup.
2. The mobile computer starts to charge automatically. The Charge LED Indicator indicates the charge status.



**NOTE:** To function properly, ensure that the MC3300x hand strap, if attached, does not interfere with the charging contacts when the MC3300x is inserted into a charging cradle or cable.

## Charging Indicators

**Table 8** LED Charge Indicators

Status	Indications
Off	<ul style="list-style-type: none"> <li>• The battery is not charging.</li> <li>• The battery is not inserted correctly in the cradle or connected to a power source.</li> <li>• Cradle is not powered.</li> </ul>
Blinking Amber	<ul style="list-style-type: none"> <li>• Active wireless connectivity session during battery hot swap.</li> </ul>
Solid Amber	<ul style="list-style-type: none"> <li>• Battery is charging.</li> </ul>
Solid Green	<ul style="list-style-type: none"> <li>• Battery charging is complete.</li> </ul>
Fast Blinking Red 2 blinks/second	Charging error, e.g.: <ul style="list-style-type: none"> <li>• Temperature is too low or too high.</li> <li>• Charging has gone on too long without completion (typically eight hours).</li> </ul>

The MC3300x 7000 mAh PowerPrecision+ extended battery charges from 0% to 90% in less than 5.2 hours at room temperature.

The MC33XX 5200 mAh PowerPrecision+ high capacity battery charges from 0% to 90% in less than 3.8 hours at room temperature.

The MC33XX 2740 mAh PowerPrecision+ standard battery charges from 0% to 90% in less than 2.2 hours at room temperature.

## Charging Temperature

Charge batteries in ambient temperatures from 0°C to 40°C (32°F to 104°F). To view battery temperature, go to **Settings > About phone > Battery information**.

The device or cradle always performs battery charging in a safe and intelligent manner. At higher temperatures (for example, approximately +37°C (+98°F)) the device or cradle may for small periods of time alternately enable and disable battery charging to keep the battery at acceptable temperatures. The device and cradle indicates when charging is disabled due to abnormal temperatures via its LED.

### Charging Spare Batteries

See [Accessories](#) for information on using accessories to charge spare batteries.

### Hot Swap Mode/Backup Power

The device provides a Hot Swap mode where you can replace the battery without powering off the device. When you remove the battery, the display turns off and the device enters the Hot Swap mode. WLAN and Bluetooth connectivity are retained for the first 30 seconds (indicated by a flashing amber LED). After 30 seconds, the device enters a critical suspend mode with RAM data persistence for approximately five minutes. In the critical suspend mode, WLAN and Bluetooth radios are disabled and will only resume if you insert a battery with sufficient charge into the device.



**IMPORTANT:** The supercap requires time to recharge after performing a Hot Swap or after the main battery is fully depleted. It can take up to 10 minutes to fully charge the supercap. Hot Swap mode will not retain data unless the supercap is fully charged.

### Real-Time Clock Backup

The device provides a Real-time Clock (RTC) backup feature. After boot-up, the device saves the system time in a file in persistent storage. When the device re-boots, it compares the system time to the time saved in a file. If the system time is not the latest, it restores the time from the file.

## Replacing the Battery in the MC3300x-G

To replace the battery:

1. Push in the two Battery Release buttons.

The battery ejects slightly. With Hot Swap mode, when the user removes the battery, the display turns off and the device enters low power state. The MC3300x-G supports wireless connectivity persistence for 30 sec (indicated by flashing Amber LEDs), followed by RAM data persistence for approximately five minutes. Replace the battery within five minutes to preserve memory persistence.

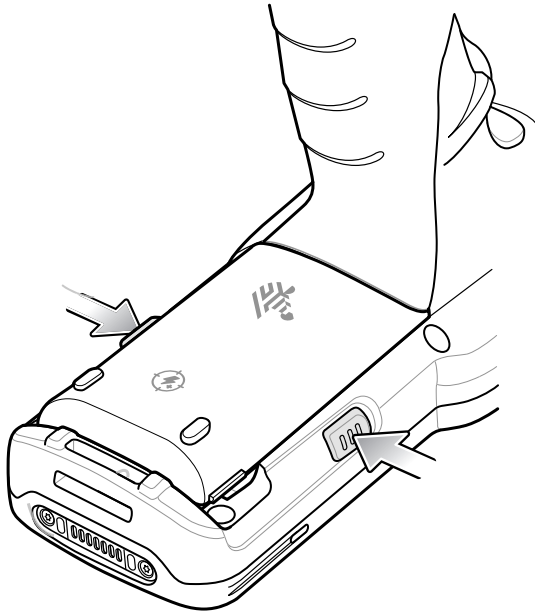

2. Remove the battery from the battery compartment.

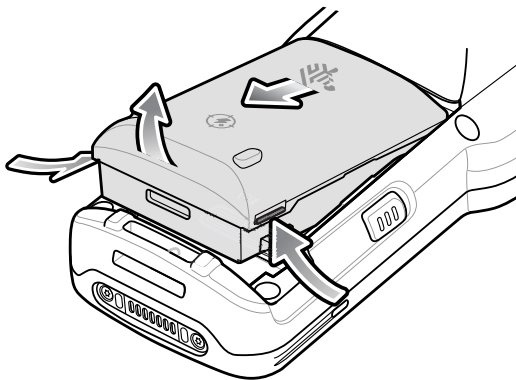



3. Align the battery into the battery compartment.

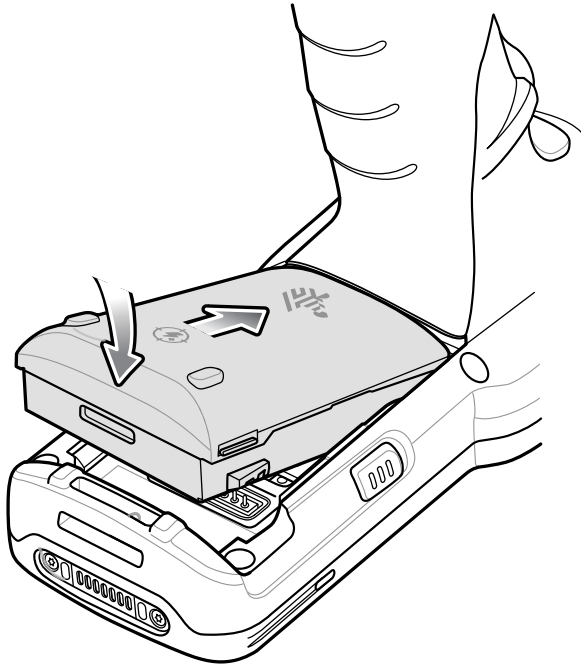

4. Slide the front of the battery into the battery compartment.
5. Press battery down firmly. Ensure that both battery release buttons on the sides of the MC3300x-G return to the home position.

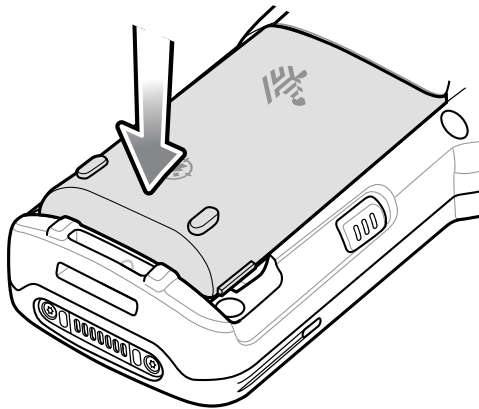

6. The device automatically resumes after a battery removal and installation (in a hot swap change). The only time the Power key needs to be pressed is if the device has been powered off or left for a prolonged duration without a battery pack.

## Replacing the Battery in the MC3300x-R/S

To replace the battery:

1. Push in the two Battery Release buttons.

The battery ejects slightly. With Hot Swap mode, when the user removes the battery, the display turns off and the device enters low power state. The MC3300x-R/S supports wireless connectivity persistence for 30 sec (indicated by flashing Amber LEDs), followed by RAM data persistence for approximately five minutes. Replace the battery within five minutes to preserve memory persistence.

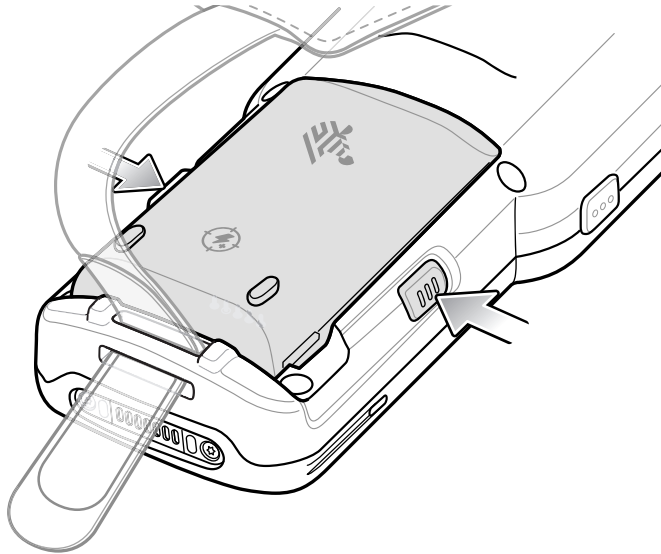

2. Remove the battery from the battery compartment.

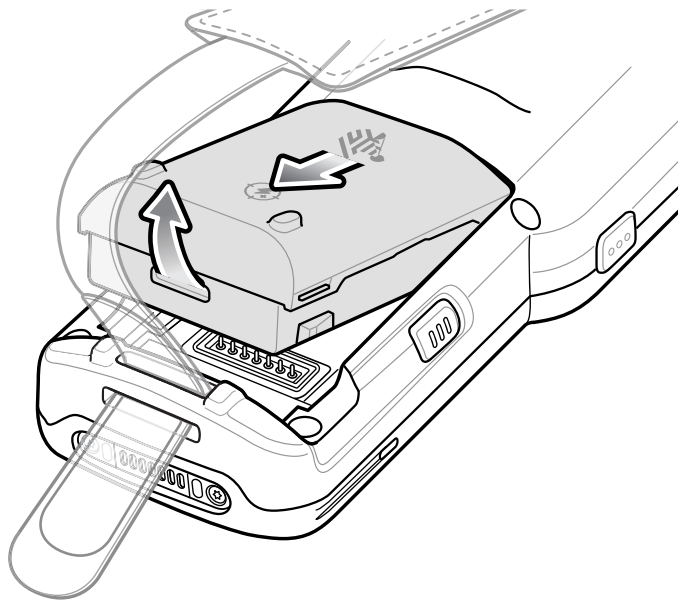

3. Align the battery into the battery compartment.

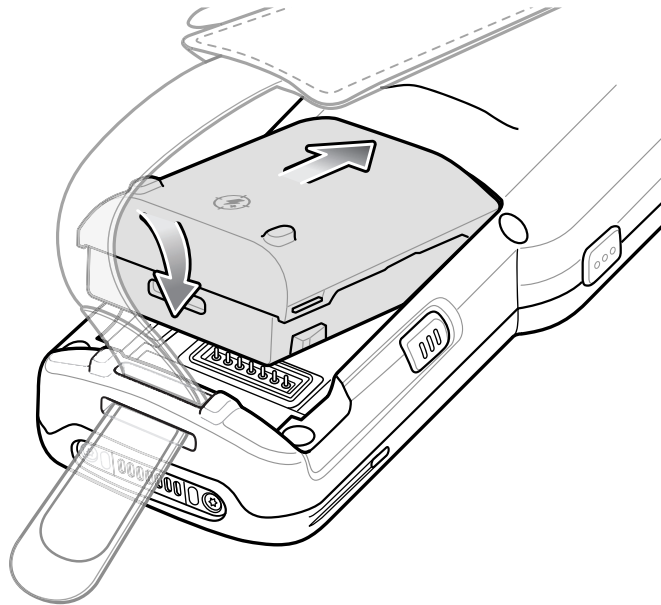

4. Slide the front of the battery into the battery compartment.
5. Press battery down firmly. Ensure that both battery release buttons on the sides of the MC3300x-R/S return to the home position.

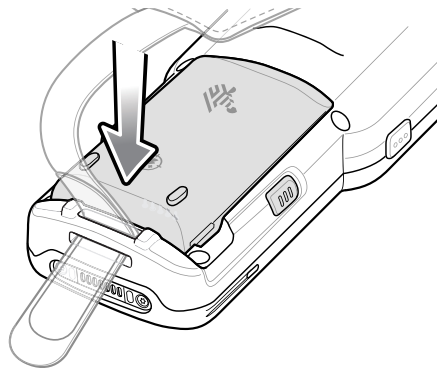

6. The device automatically resumes after a battery removal and installation (in a hot swap change). The only time the Power key needs to be pressed is if the device has been powered off or left for a prolonged duration without a battery pack.

# Using the Device

## Home Screen

Turn on the device to display the Home screen. Depending on how your system administrator configured your device, your Home screen may appear differently than the graphics in this section.

After a suspend or screen time-out, the Home screen displays with the lock slider. Touch the screen and slide up to unlock.

The Home screen provides four additional screens to place widgets and shortcuts. Swipe the screen left or right to view the additional screens.



**NOTE:** By default, AOSP devices do not have the same icons on the Home screen as GMS devices. Icons are shown below for example only.

Home screen icons can be configured by the user and may look different than shown.

**Figure 8** Home Screen

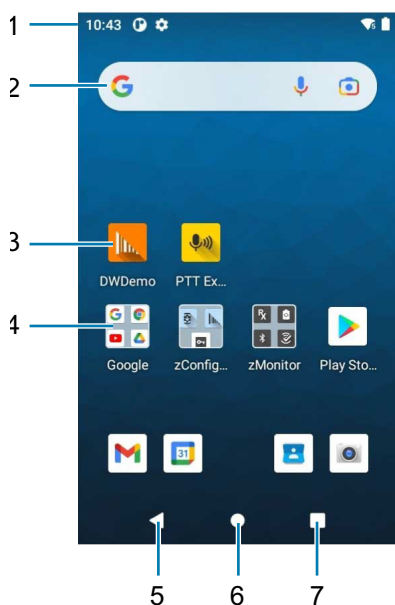

1	Status Bar	Displays the time, status icons (right side), and notification icons (left side). For more information see <a href="#">Notification Icons on page 38</a> and <a href="#">Managing Notifications on page 40</a> .
2	Widgets	Launches stand-alone apps that run on the Home screen.
3	Shortcut Icons	Opens apps installed on the device.
4	Folder	Contains apps.
5	Back	Displays the previous screen.
6	Home	Displays the Home screen.
7	Recent	Displays recently used applications.

## Setting Home Screen Rotation

By default, the Home screen rotation is disabled.

1. Touch and hold anywhere on the Home screen until the options appear.
2. Touch **Home settings**.
3. Touch the **Allow Home screen rotation** switch.
4. Touch the Home button.
5. Rotate the device.



**NOTE:** Auto-rotate needs to be enabled in the Quick Access panel or in Settings before the Home Screen Rotation setting can be used to enable or disable Home Screen Rotation.

## Status Bar

The Status bar displays the time, notification icons (left side), and status icons (right side).

If there are more notifications than can fit in the Status bar, a dot displays indicating that more notifications exist. Swipe down from the Status bar to open the Notification panel and view all notifications and status.

**Figure 9** Notification and Status Icons





















1	Notification Icons. See <a href="#">Notification Icons on page 38</a> .
2	Status Icons. See <a href="#">Status Icons on page 39</a> .

## Notification Icons

Notification icons indicate app events and messages.





















**Table 9** Notification Icons

Icon	Description
	Main battery is low.
	More notifications are available for viewing.
	Data is syncing.
	Indicates an upcoming event. AOSP devices only.
	Indicates an upcoming event. GMS devices only.
	Open Wi-Fi network is available.
	Audio is playing.
	Problem with sign-in or sync has occurred.
	Device is uploading data.
	Animated: the device is downloading data. Static: the download is complete.
	Device is connected to or disconnected from a virtual private network (VPN).
	Preparing internal storage by checking it for errors.
	USB debugging is enabled on the device.
	Wired headset with a boom module is connected to the device.
	Wired headset without a boom module is connected to the device.
	PTT Express Voice client status. See the PTT Express PTT Notification Icons for a complete list.
	Indicates the RxLogger app is running.
	Indicates the Bluetooth scanner is connected to the device.
	Indicates the ring scanner is connected to the device in HID mode.



## Status Icons

Status icons display system information for the device.

**Table 10** Status Icons

Icon	Description
	Alarm is active.
	Main battery is fully charged.
	Main battery is partially drained.
	Main battery charge is low.
	Main battery charge is very low.
	Main battery is charging.
	Indicates that all sounds except media and alarms are muted.
	Do Not Disturb mode active.
	Airplane Mode is active. All radios are turned off.
	Bluetooth is on.
	The device is connected to a Bluetooth device.
	Connected to a Wi-Fi network. Indicates the Wi-Fi version number.
	Not connected to a Wi-Fi network or no Wi-Fi signal.
	Connected to an Ethernet network.
	Speakerphone enabled.
	Indicates that the Orange key is locked.
	Indicates that the Blue key is pressed.
	Indicates that the Blue key is locked.
	Indicates that the ALT key is pressed.
	Indicates that the CTRL key is pressed.
	Indicates that the Shift key is pressed.

**Table 10** Status Icons (Continued)

Icon	Description
	Indicates that the Shift key is locked.
	Indicates that the diamond key is pressed.
	Indicates that a BT headset is connected to the device.

## Managing Notifications

Notification icons report the arrival of new messages, calendar events, alarms, and ongoing events. When a notification occurs, an icon appears in the Status bar with a brief description. See [Notification Icons on page 38](#) for a list of possible notification icons and their description.

- To view a list of all notifications, open the Notification panel by dragging the Status bar down from the top of the screen.

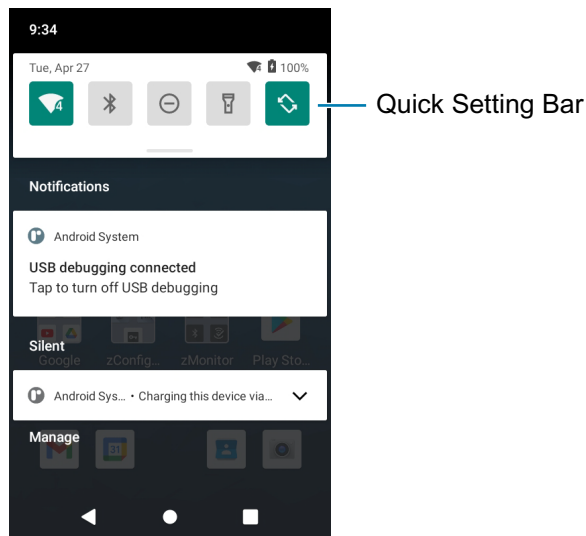
**Figure 10** Notification Panel

- To respond to a notification, open the Notification panel and then touch a notification. The Notification panel closes and the corresponding app opens.
- To manage recent or frequently used notifications, open the Notification panel and then touch **Manage notifications**. Touch the toggle switch next to an app to turn off all notifications, or touch an app for more notification options.
- To clear all notifications, open the Notification panel and then touch **CLEAR ALL**. All event-based notifications are removed. Ongoing notifications remain in the list.
- To close the Notification panel, swipe the Notification panel up.

## Opening the Quick Access Panel

Use the Quick Access panel to access frequently used settings (for example, Airplane mode). To get to the Quick Access Panel:

- If the device is locked, swipe down once.



- If the device is unlocked, swipe down once with two fingers, or twice with one finger.
- If the Notification panel is open, swipe down from the Quick Settings bar.

**Figure 11** Quick Access Panel

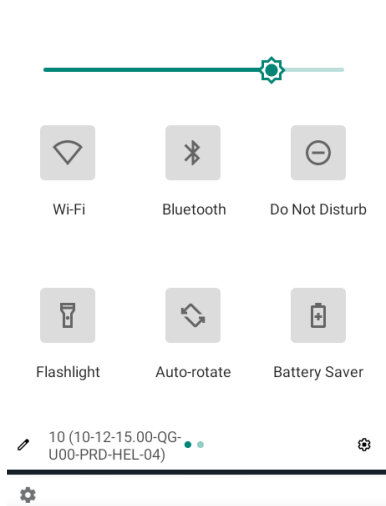

**NOTE:** Not all icons are pictured. Icons may vary.

### Quick Access Panel Icons

- Display brightness - Use the slider to decrease or increase the brightness of the screen.
- Wi-Fi network - Turn Wi-Fi on or off. To open Wi-Fi settings, touch the Wi-Fi network name.
- Bluetooth settings - Turn Bluetooth on or off. To open Bluetooth settings, touch **Bluetooth**.
- Battery saver - Turn Battery saver mode on or off. When Battery saver mode is on the performance of the device is reduced to preserve battery power.
- Invert colors - Invert the display colors.
- Do not disturb - Control how and when to receive notifications.
- Airplane mode - Turn Airplane mode on or off. When Airplane mode is on the device does not connect to Wi-Fi or Bluetooth.
- Auto-rotate - Lock the device's orientation in portrait or landscape mode or set to automatically rotate.
- Flashlight - Turn flashlight on or off. Turn camera flash on or off.
- Night Light - Tint the screen amber to make it easier to look at the screen in dim light. Set Night Light to turn on automatically from sunset to sunrise, or at other times.
- Screen Cast - Share phone content on Chromecast or a television with Chromecast built-in. Touch cast screen to display a list of devices, then touch a device to begin casting.
- Dark Theme - Toggles dark theme on and off. Dark themes reduce the luminance emitted by the screen, while meeting minimum color contrast ratios. It helps improve visual ergonomics by reducing eye strain, adjusting brightness to current lighting conditions, and facilitating screen use in dark environments, while conserving battery power.
- Focus mode - Turn on to pause distracting apps. To open Focus mode settings, touch and hold.
- Bedtime mode - Turn grayscale on and off. Grayscale turns the screen black and white, reducing phone distractions and improving battery life.

- Nearby Share - Helps find and interact with services and devices close to the device. To open Nearby Share settings, touch and hold.
- Screen Record - Turn on to record your phone screen. Tap the toggle switches to record audio or show touches on the screen.

## Editing Icons on the Quick Settings Bar

The first several setting tiles from the Quick Access panel become the Quick Settings bar.

Open the Quick Access panel and touch  to edit, add, or remove settings tiles.

## Battery Management

Observe the recommended battery optimization tips for your device.

- Set the screen to turn off after a short period of non-use.
- Reduce screen brightness.
- Turn off all wireless radios when not in use.
- Turn off automatic syncing for Email, Calendar, Contacts, and other apps.
- Minimize use of apps that keep the device from suspending, for example, music and video apps.



**NOTE:** Before checking the battery charge level, remove the device from any AC power source (cradle or cable).

## Checking Battery Status



**IMPORTANT:** At temperatures below 0°C, the Battery level may report a reduced value. This is normal due to temperature compensation.

- Open **Settings** and touch **About phone** > **Battery Information**.

Or, swipe up from the bottom of the screen and touch  to open the **Battery Manager** app. See [Battery Manager on page 57](#).

- **Battery present status** indicates if the battery is present.
- **Battery level** lists the battery charge (as a percentage of fully charged).
- Swipe down with two fingers from the status bar to open the quick access panel.
  - Battery percentage is displayed next to the battery icon.

## Monitoring Battery Usage

The **Battery** screen provides battery charge details and power management options to extend battery life.

1. Go to **Settings**.
2. Touch **Battery**.

Display battery information and power management options for a specific app.

1. Go to **Settings**.
2. Touch **Apps & notifications**.
3. Touch an app.

#### 4. Touch **Advanced > Battery**.

Different apps display different information. Some apps include buttons that open screens with settings to adjust power use. Use the **DISABLE** or **FORCE CLOSE** buttons to turn off apps that consume too much power.

### Low Battery Notification

When the battery charge level drops below 15%, the device displays a notice to connect the device to power. The user should charge the battery using one of the charging accessories.

When the battery charge drops below 8%, the device displays a notice to connect the device to power. The user must charge the battery using one of the charging accessories.

When the battery charge drops below 6%, the device turns off. The user must charge the battery using one of the charging accessories.

### Interactive Sensor Technology

The device contains sensors that monitor movement and orientation.

- Gyroscope - Measures angular rotational velocity to detect rotation of the device.
- Accelerometer - Measures the linear acceleration of movement to detect the orientation of the device.

In order to take advantage of these sensors, applications use API commands. Refer to the Google Android Sensor APIs for more information. For information on the Zebra Android EMDK, go to: [techdocs.zebra.com](http://techdocs.zebra.com).

### Waking the Device

The device goes into Suspend mode when you press the Power button or after a period of inactivity (set in the Display settings window).

1. To wake the device from Suspend mode, press the Power button.

The Lock screen displays.

2. Swipe the screen up to unlock.

- If the Pattern screen unlock feature is enabled, the Pattern screen appears instead of the Lock screen.
- If the PIN or Password screen unlock feature is enabled, enter the PIN or password after unlocking the screen.



**NOTE:** If you enter the PIN, password, or pattern incorrectly five times, you must wait 30 seconds before trying again.

If you forget the PIN, password, or pattern contact your system administrator.

### USB Communication

Connect the device to a host computer to transfer files between the device and the host computer.

When connecting the device to a host computer, follow the host computer's instructions for connecting and disconnecting USB devices, to avoid damaging or corrupting files.

### Transferring Files

Use **Transfer files** to copy files between the device and the host computer.

1. Connect the device to a host computer using a USB accessory.
2. On the device, pull down the Notification panel and touch **Charging this device via USB**.  
By default, **No data transfer** is selected.
3. Touch **File Transfer**.
4. On the host computer, open a file explorer application.
5. Locate the **device** as a portable device.
6. Open the SD card or the Internal storage folder.
7. Copy files to and from the device or delete files as required.

### Transferring Photos

Use **PTP** to copy photos from the device to the host computer.

1. Connect the device to a host computer using a USB accessory.
2. On the device, pull down the Notification panel and touch **Charging this device via USB**.
3. Touch **PTP**.
4. On the host computer, open a file explorer application.
5. Open the SD card or the Internal storage folder.
6. Copy or delete photos as required.

### Disconnect from the Host Computer



**CAUTION:** Carefully follow the host computer's instructions to unmount the microSD card and disconnect USB devices correctly to avoid losing information.



To disconnect the device from the host computer:

1. On the host computer, unmount the device.
2. Remove the device from the USB accessory.

# Settings

## Accessing Settings

There are multiple ways to access settings on a device.

- Swipe down with two fingers from the top of the Home screen to open the Quick Access panel and touch .
- Double-swipe down from the top of the Home screen to open the Quick Access panel and touch .
- Swipe up from the bottom of the Home screen to open APPS and touch  **Settings**.

## Display Settings

Use Display settings to change the screen brightness, enable night light, change the background image, enable screen rotation, set sleep time, and change font size.

### Setting the Screen Brightness Manually

Manually set the screen brightness using the touchscreen.

1. Swipe down with two fingers from the Status bar to open the Quick Access panel.
2. Slide the icon to adjust the screen brightness level.

### Setting Night Light

The Night Light setting tints the screen amber, making the screen easier to look at in low light.

1. Go to **Settings**.
2. Touch **Display**.
3. Touch **Night Light**.
4. Touch **Schedule**.
5. Select one of the schedule values:
  - **None** (default)
  - **Turns on at custom time**
  - **Turns on from sunset to sunrise**.
6. By default, **Night Light** is disabled. Touch **TURN ON NOW** to enable.
7. Adjust the tint using the **Intensity** slider.

8. Touch the Home button.

## Setting Screen Rotation

By default, screen rotation is enabled.

1. Go to **Settings**.
2. Touch **Display > Advanced**.
3. Touch **Auto-rotate screen**.



**NOTE:** To change the Home screen rotation, see [Setting Home Screen Rotation on page 37](#).

4. Touch the Home button.

## Setting Screen Timeout

Set the screen sleep time.

1. Go to **Settings**.
2. Touch **Display > Screen timeout**.
3. Select one of the sleep values.
  - **15 seconds**
  - **30 seconds**
  - **1 minute**
  - **2 minutes**
  - **5 minutes**
  - **10 minutes**
  - **30 minutes** (default)
  - **Never**
4. Touch the Home button.

## Setting Font Size

Set the size of the font in system apps.

1. Go to **Settings**.
2. Touch **Display > Advanced**.
3. Touch **Font size**.
4. Select one of the font size values.
  - Small
  - Default
  - Large
  - Largest.
5. Touch the Home button.

## Touch Panel Mode

The device display is able to detect touches using a finger, a conductive-tip stylus, or gloved finger.



**NOTE:** A glove can be made of medical latex, leather, cotton, or wool. For optimal performance use a Zebra certified stylus.

1. Go to **Settings**.
2. Touch **Display > Advanced**.
3. Touch **TouchPanelUI**.
4. Select:
  - **Stylus and Finger (Screen Protector OFF)** to use a finger or a stylus on the screen without a screen protector.
  - **Glove and Finger (Screen Protector OFF)** to use a finger or a gloved finger on the screen without a screen protector.
5. Touch the Home button.

## Setting the Date and Time

You are only required to set the time zone or set the date and time if the wireless LAN does not support Network Time Protocol (NTP)

1. Go to **Settings**.
2. Touch **System > Date & time**.
3. Touch **Use network-provided time** to disable automatic date and time synchronization.
4. Touch **Date**.
5. In the calendar, set today's date.
6. Touch **OK**.
7. Touch **Time**.
8. Touch the green circle, drag to the current hour and then release.
9. Touch the green circle, drag to the current minute and then release.
10. Touch **AM** or **PM**.
11. Touch **OK**.
12. Touch **Time zone > Time zone** and select the current time zone from the list. This option may not be available in some locations.
13. Touch **Time zone > Region** and select the current region from the list.
14. Touch **Update Interval** to select interval to synchronize the system time from the network.
15. In **TIME FORMAT**, choose either **Use local default** or **Use 24-hour format**.
16. Touch the Home button.

## General Sound Setting

Use the **Sound** settings to configure media and alarm volumes.

1. Go to **Settings**.
2. Touch **Sound**.
3. Touch an option to set sounds.

## Sound Options



\* **NOTE:** The device does not support haptic feedback, so it will not vibrate.

- **Media volume** - Controls the music, games, and media volume.
- **Alarm volume** - Controls the alarm clock volume.
- **Notification volume** - Controls the notification volume.
- **Do Not Disturb** - Mutes some or all sounds and vibrations.
- **Media** - Enable or disable to show media controls in Quick Access Panel.
- \* **Shortcut to prevent ringing** - Select how the shortcut method prevents ringing.
- **Default notification sound** - Select a sound to play for all system notifications.
- **Default alarm sound** - Select a sound to play for alarms.
- **Other sounds and vibrations**
  - **Screen locking sounds** - Play a sound when locking and unlocking the screen (default – enabled).
  - \* **Charging sounds** - Plays a sound when power is applied to the device (default - enabled).
  - **Touch sounds** - Play a sound when making screen selections (default – enabled).

## Setting Wake-Up Sources

By default the device wakes from suspend mode when the user presses the Power button or Gun Trigger on the MC3300x-G or the Power button or Center Scan key on the MC3300x-S or MC3300x-R.



**NOTE:** There is no dedicated PTT key on the MC3300x. Any physical key or trigger can be programmed as the PTT key including either of the Programmable P1 or Diamond keys.

1. Go to **Settings**.
2. Touch **Wake-Up Sources**.
  - **GUN\_TRIGGER** - Programmable button on the Trigger Handle accessory.
  - **LEFT\_TRIGGER\_1** - Left scan button.
  - **RIGHT\_TRIGGER\_1** - Right scan button.
  - **SCAN** - Left scan button.
3. Touch a checkbox. A check appears in the checkbox.
4. Touch the Home button.

## Remapping a Button

Buttons on the device can be programmed to perform different functions or as shortcuts to installed apps. For a list of key names and descriptions, refer to: [techdocs.zebra.com](http://techdocs.zebra.com).





**NOTE:** It is not recommended to remap the scan button.

1. Go to **Settings**.
2. Touch **Key Programmer**. A list of programmable buttons displays.
3. Select the button to remap.
4. Touch the **Shortcut**, the **Keys and Buttons**, or the **Trigger** tab that lists the available functions, applications, and triggers.

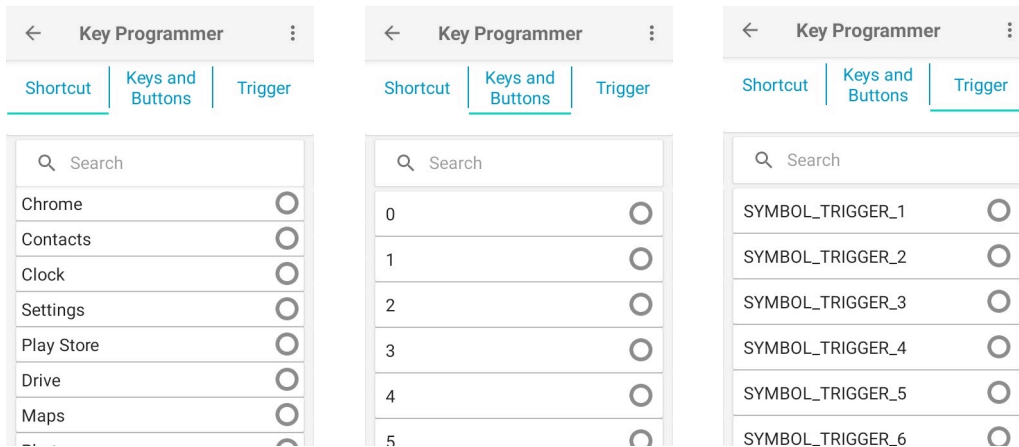

5. Touch a function or application shortcut to map to the button.



**NOTE:** If you select an application shortcut, the application icon appears next to the button on the Key Programmer screen.

6. Touch the Home button.

## Remappable Keys

Figure 12 Key Positions

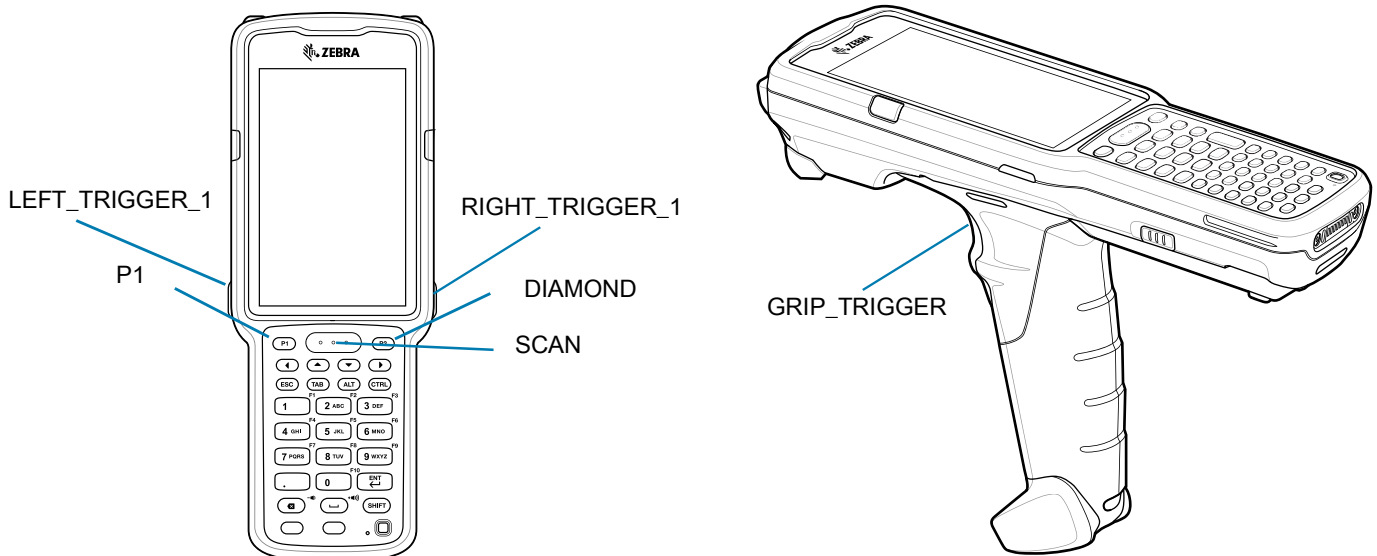

## UI Listed Keys

- GRIP\_TRIGGER
- SCAN
- P1
- DIAMOND
- LEFT\_TRIGGER\_1
- RIGHT\_TRIGGER\_1

## Other Remappable Keys

- 0-9
- A-Z
- F1-F10
- LEFT
- UP
- DOWN
- RIGHT
- ENTER
- SPACE
- ESC
- DOT (via XML only, not StageNow)
- TAB
- DELETE
- COMMA
- SHIFT
- CTRL
- ALT
- BLUE
- ORANGE

## Non-Remappable Keys

- POWER
- BACK (Not a physical key)
- HOME (Not a physical key)
- RECENT (Not a physical key)

## Keyboards

The device provides multiple keyboard options.

- Android Keyboard - AOSP devices only
- Gboard - GMS devices only
- Enterprise Keyboard- Not pre-installed on the device. Contact Zebra Support for more information.





**NOTE:** By default the Enterprise and Virtual Keyboards are disabled.

## Keyboard Configuration

### Enabling Keyboards

1. Go to **Settings**.
2. Touch **System > Languages & input > Virtual keyboard > Manage keyboards**.
3. Touch a keyboard to enable.

### Switching Between Keyboards

- To switch between keyboards, touch in a text box to display the current keyboard.
  - On the Gboard keyboard, touch and hold  (GMS devices only).
  - On the Android keyboard, touch and hold  (AOSP devices only).
  - On the Enterprise keyboard, touch . Only available with Mobility DNA Enterprise License. Not pre-installed on the device. Contact Zebra Support for more information.

## Using the Android and Gboard Keyboards

Use the Android or Gboard keyboards to enter text in a text field.

To configure the keyboard settings, touch and hold **the comma** and then slide your finger to .

### Edit Text

Edit entered text and use menu commands to cut, copy, and paste text within or across apps. Some apps do not support editing some or all of the text they display; others may offer their own way to select text.

### Entering Numbers, Symbols, and Special Characters

1. Enter numbers and symbols.
  - Touch and hold one of the top-row keys until a menu appears then select a number or special character.
  - Touch the Shift key once for a single capital letter. Touch the Shift key twice to lock in uppercase. Touch the Shift key a third time to unlock Capslock.
  - Touch **?123** to switch to the numbers and symbols keyboard.
  - Touch the **=\<** key on the numbers and symbols keyboard to view additional symbols.
2. Enter special characters.

- Touch and hold a number or symbol key to open a menu of additional symbols. A larger version of the key displays briefly over the keyboard.

### Using the Enterprise Keyboard

The Enterprise Keyboard contains multiple keyboard types.

- Numeric
- Alpha
- Special characters
- Data capture.

#### Numeric Tab

The numeric keyboard is labeled **123**. The keys displayed vary on the app being used. For example, an arrow displays in **Contacts**, however **Done** displays in **Email** account setup.

#### Alpha Tab

The alpha keyboard is labeled using the language code. For English, the alpha keyboard is labeled **EN**.

#### Additional Character Tab

The additional characters keyboard is labeled **#\*/**.

Touch 😊 to enter emoji icons in a text message.

Touch **ABC** to return to the Symbols keyboard.

#### Scan Tab

The Scan tab provides an easy data capture feature for scanning barcodes.

## Language Usage

Use the **Language & input** settings to change the device's language, including words added to the dictionary.

### Changing the Language Setting

1. Go to **Settings**.
2. Touch **System > Languages & input**.
3. Touch **Languages**. A list of available languages displays.
4. If the desired language is not listed, touch **Add a language** and select a language from the list.
5. Touch and hold ≡ to the right of the desired language, then drag it to the top of the list.
6. The operating system text changes to the selected language.

### Adding Words to the Dictionary

1. Go to **Settings**.
2. Touch **System > Languages & input > Advanced > Personal dictionary**.

3. If prompted, select the language where this word or phrase is stored.
4. Touch **+** to add a new word or phrase to the dictionary.
5. Enter the word or phrase.
6. In the **Shortcut** text box, enter a shortcut for the word or phrase.
7. Touch the Home button.

## Notifications

### Setting App Notifications

To set notification settings for a specific app:

1. Go to **Settings**.
2. Touch **Apps & notifications**.
3. Under Recently opened apps, touch **SEE ALL XX APPS**. The **App info** screen displays.  
If there are no recently opened apps, touch **App info** to open the **App Info** screen.
4. Select an app. Options vary depending on the app selected.
5. Select an available option:
  - **Open** - Opens the app.
  - **Disable** - Turn the app off and hide it. The app no longer appears in the All Apps list. You must re-enable the app to use it.
  - **Force Stop** - Turn off the app.
  - **Notifications**
    - **All app notifications** - Select to turn all notifications from this app on (default) or off.  
Touch a specific notification category to display additional options.
    - **Default** - Allow notifications from this app to make sound.
    - **Silent** - Do not allow notifications from this app to make sound.
    - **Minimize** - In the Notification panel, collapse notifications to one line.
    - **Advanced** - Touch for additional options.
      - **Allow notification dot** - Do not allow this app to add a notification dot to the app icon.
      - **Additional settings in the app** - Open the app settings.
  - **Permissions** - Configure which permissions are allowed or denied for this app.
  - **Storage & cache** - View the amount of storage and cache space used for this app. You can choose to **Clear Storage** and **Clear Cache** for the app to free up storage space on the device.
  - **Mobile data & Wi-Fi** - View the data usage for this app. You can choose to enable **Background data** usage or allow **Unrestricted data usage** by this app.
  - **Advanced** - Touch for additional options.
  - **Screen time** - Touch for options to set an **App timer** that limits the amount of time you can use this app and to **Manage notifications**.
  - **Battery** - Set **Background restriction** and **Battery optimization** for this app.

- **Open by default** - Modify which links or files the app opens by default.
- **Advanced**
  - **Picture-in-picture** - Allow this app to create a picture-in-picture window when the app is running in the background.
  - **Install unknown apps** - Allow this app to install unknown apps.
  - **Display over other apps** - Allow this app to display over other apps.
  - **Modify system settings** - Allow this app to modify system settings.
- **Store**
  - **App details** - Opens Google Play to display information about the app.

### Viewing Notification Settings for All Apps

To view the notification settings for all apps:

1. Go to **Settings**.
2. Touch **Apps & Notifications**.
3. Scroll down to **Notifications** to view how many apps have notifications turned off.
4. To set or view notifications settings for a specific app, see [Setting App Notifications on page 53](#).

### Controlling Lock Screen Notifications

To control whether notifications can be seen when the device is locked:

1. Go to **Settings**.
2. Touch **Apps & notifications > Notifications**.
3. Touch **Notifications on lockscreen** and select one of the following:
  - **Show conversations, default, and silent** (default)
  - **Hide silent conversations and notifications**
  - **Don't show any notifications**.

### Blink Light

The Notification LED lights blue when an app, such as email and VoIP, generates a programmable notification or to indicate when the device is connected to a Bluetooth device. By default, LED notifications are enabled.

To change the notification setting:

1. Go to **Settings**.
2. Touch **Apps & notifications > Notifications > Advanced**.
3. Touch **Blink light** to toggle the notification on or off.

# Applications









The **APPS** screen displays icons for all installed apps. See [Application Deployment](#) for information on installing and uninstalling apps. For information on standard Android apps, go to [Google Play](#).

The following table describes the apps installed on the device.









**NOTE:** Not all apps are available on all devices.

**Table 1** Apps

Icon	Description
	<b>Battery Manager</b> - Displays battery information, including charge level, status, health and wear level.
	<b>Bluetooth Pairing Utility</b> – Use to pair a Zebra Bluetooth scanner with the device by scanning a barcode.
	<b>Camera</b> - Take photos or record videos. For more information, see <a href="#">Camera on page 60</a> .
	<b>DataWedge</b> - Enables data capture using the imager. For more information, see <a href="#">DataWedge Demonstration on page 63</a> .
	<b>DisplayLink Presenter</b> - Use to present the device screen onto a connected monitor.
	<b>DWDemo</b> - Provides a way to demonstrate the data capture features using the imager. For more information, see <a href="#">DataWedge Demonstration on page 63</a> .
	<b>License Manager</b> - Use to manage software licenses on the device.
	<b>PTT Express</b> - Use to launch PTT Express client for VoIP communication.
	<b>RxLogger</b> - Use to diagnose device and app issues. For more information, see <a href="#">RxLogger on page 69</a> .

**Table 1** Apps (Continued)

Icon	Description
	<b>Settings</b> - Use to configure the device.
	<b>StageNow</b> - Allows the device to stage a device for initial use by initiating the deployment of settings, firmware, and software.
	<b>Velocity</b> - Opens the Ivanti (formerly Wavelink) terminal emulation app.
	<b>VoD</b> - The Video on Device basic app provides a how-to video for proper device cleaning. For Video on Device licensing information, go to <a href="https://learning.zebra.com">learning.zebra.com</a> .
	<b>Worry Free Wifi Analyzer</b> - A diagnostic intelligent app. Use to diagnose surrounding area and display network stats, such as coverage hole detection, or AP in vicinity. Refer to the Worry Free Wi-Fi Analyzer Administrator Guide for Android.
	<b>Zebra Bluetooth Settings</b> - Use to configure Bluetooth logging.
	<b>Zebra Data Services</b> - Use to enable or disable Zebra Data Services. Some options are set by the system administrator.

## Accessing Apps

All apps installed on the device are accessed using the **APPS** window.

1. On the Home screen, swipe up from the bottom of the screen.
2. Slide the **APPS** window up or down to view more app icons.
3. Touch an icon to open the app.

## Switching Between Recent Apps

Use the Recent button to switch between recently used apps.

1. Touch Recent button.  
A window appears on the screen with icons of recently used apps.
2. Slide the apps displayed up and down to view all recently used apps.
3. Swipe left or right to remove app from the list and force close the app.
4. Touch an icon to open an app or touch Back button to return to the current screen.

## Battery Manager

The **Battery Manager** provides detailed information about the battery and battery swap procedures on supported devices.





## Opening Battery Manager

To open the Battery Manager app, swipe up from the bottom of the Home screen, and then touch .

## Battery Manager Information Tab

The Battery Manager displays detailed information about battery charging, health, and status.

**Table 2** Battery Icon Description

Battery Icon	Description
	Battery charge level is between 85% and 100%.
	Battery charge level is between 19% and 84%.
	Battery charge level is between 0% and 18%.

- **Level** - The current battery charge level as a percentage. Displays **-%** when level is unknown.
- **Wear** - The health of the battery in graphical form. When the wear level exceeds 80%, the bar color changes to red.
- **Health** - The health of the battery. If a critical error occurs,  appears. Touch to view the error description.
  - **Decommission** - The battery is past its useful life and should be replaced. See system administrator.
  - **Good** - The battery is good.
  - **Charge error** - An error occurred while charging. See system administrator.
  - **Over Current** - An over-current condition occurred. See system administrator.
  - **Dead** - The battery has no charge. Replace the battery.
  - **Over Voltage** - An over-voltage condition occurred. See system administrator.
  - **Below Temperature** - The battery temperature is below the operating temperature. See system administrator.
  - **Failure Detected** - A failure has been detected in the battery. See system administrator.
  - **Unknown** - See system administrator.
- **Charge Status**
  - **Not charging** - The device is not connected to AC power.
  - **Charging-AC** - The device is connected to AC power and charging.
  - **Charging-USB** - The device is connected to a host computer with a USB cable and charging.
  - **Discharging** - The battery is discharging.
  - **Full** - That the battery is fully charged.

- **Unknown** - The battery status is unknown.
- **Time until empty** - The amount of time until the battery is empty.
- **Advanced info** - Touch to view additional battery information.
  - **Battery present status** - Indicates that the battery is present.
  - **Battery level** - The battery charge level as a percentage of scale.
  - **Battery scale** - The battery scale level used to determine battery level (100).
  - **Battery voltage** - The current battery voltage in millivolts.
  - **Battery temperature** - The current battery temperature in degrees Centigrade.
  - **Battery technology** - The type of battery.
  - **Battery current** - The average current into or out of the battery over the last second in mAh.
  - **Battery manufacture date** - The date of manufacture.
  - **Battery serial number** - The battery serial number. The number matches the serial number printed on the battery label.
  - **Battery part number** - The battery part number.
  - **Battery decommission status** - Indicates if the battery is past its life span.
    - **Battery Good** - The battery is in good health.
    - **Decommissioned Battery** - The battery is past its useful life and should be replaced.
  - **Base cumulative charge** - Cumulative charge using Zebra charging equipment only.
  - **Battery present capacity** - Maximum amount of charge that could be pulled from the battery under the present discharge conditions if the battery were fully charged.
  - **Battery health percentage** - With a range from **0** to **100**, this is the ratio of “present\_capacity” to “design\_capacity” at a discharge rate of “design\_capacity”.
  - **% decommission threshold** - The default % decommission threshold for a gifted battery as 80%.
  - **Battery present charge** - Amount of usable charge remaining in the battery at present under the current discharge conditions.
  - **Battery total cumulative charge** - The total accumulated charge in all chargers.
  - **Battery time since first use** - The time passed since the battery was placed in a Zebra terminal for the first time.
  - **Battery error status** - The error status of the battery.
  - **App version** - The application version number.

## Camera



**NOTE:** The Camera app is only available on MC3300x-S/R configurations.



**NOTE:** The device saves photos and videos on the microSD card, if installed and the storage path is changed manually. By default, or if a microSD card is not installed, the device saves photos and videos on the internal storage.



**NOTE:** It is recommended to install a microSD card in devices with 2 GB RAM / 16 GB Flash due to limited internal storage.

On camera only devices without an internal scan engine, the back camera is used for barcode scanning.

This section provides information for taking photos and recording videos using the integrated digital cameras.

## Taking Photos



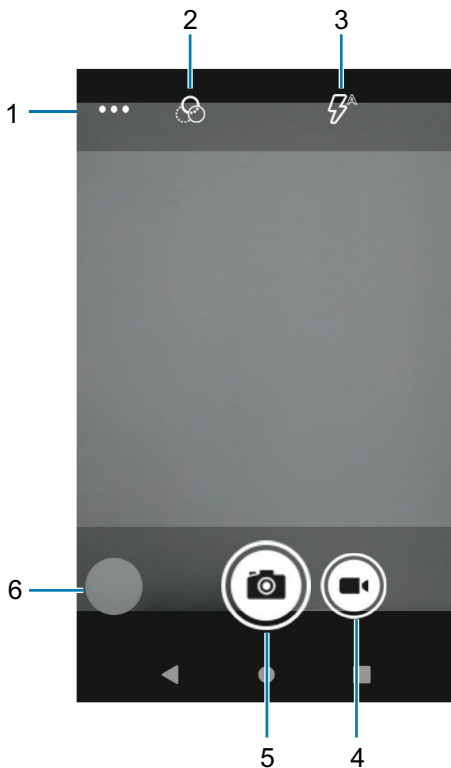

**NOTE:** See [Camera Settings on page 62](#) for camera setting descriptions.



1	Scene Mode and Settings
2	Filters
3	Flash



4	Video Recording Button
5	Camera Shutter Button
6	Gallery

1. Swipe up from the bottom of the Home screen and touch **Camera**.
  2. If necessary, touch the Camera Mode icon and touch .
  3. Frame the subject on the screen.
  4. To zoom in or out, press two fingers on the display and pinch or expand fingers. The zoom controls appear on the screen.
  5. Touch an area on the screen to focus. The focus circle appears. The two bars turn green when in focus.
  6. Touch .
- The camera takes a photo and a shutter sound plays.
- The photo momentarily displays as a thumbnail in the lower left corner.

## Recording Videos

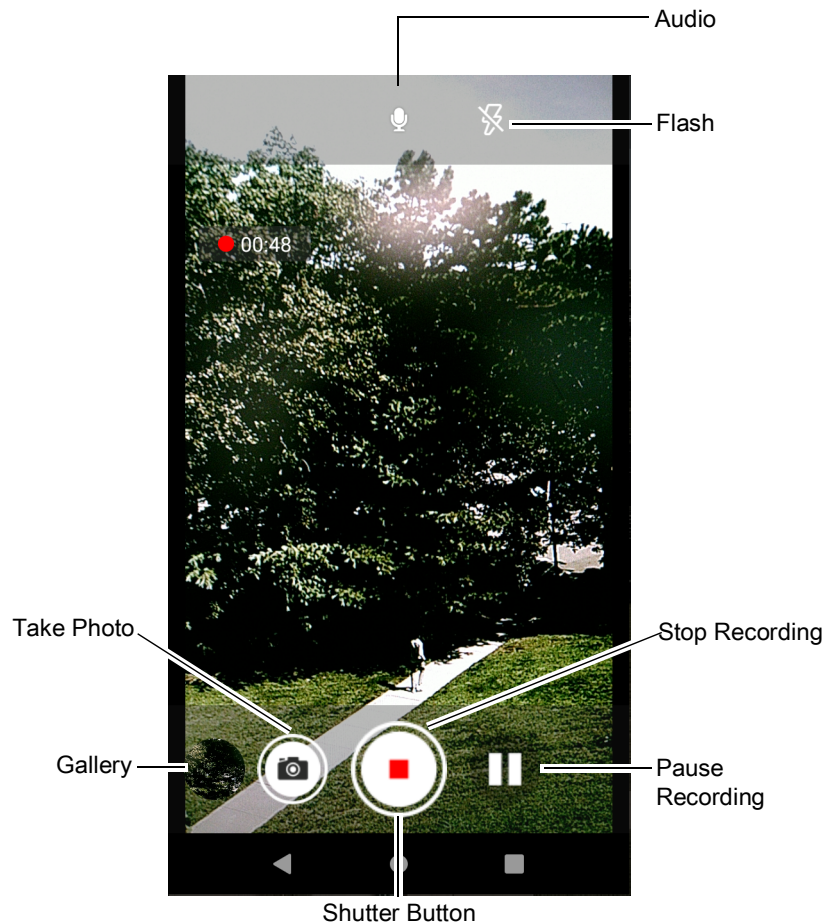
1. Swipe up from the bottom of the Home screen and touch **Camera**.
2. Touch the camera mode menu and touch .



3. Point the camera and frame the scene.
4. To zoom in or out, press two fingers on the display and pinch or expand fingers. The zoom controls appear on the screen.
5. Touch  to start recording.  
The video time remaining appears in the top left of the screen.
6. Touch  to end the recording.  
The video momentarily displays as a thumbnail in the lower left corner.

## Camera Settings

In Photo mode, photo settings appear on screen. Touch  >  to display the photo settings options.

- **General** - These settings apply to both the still camera and video camera.
  - **Face Detection** - Select to turn face detection Off (default) or On.
  - **Storage** - Set the location to store the photo to: Phone or SD Card.
- **Still Camera** - These settings apply only to the still camera.
  - **Countdown timer** - Select **Off** (default), **2 seconds**, **5 seconds** or **10 seconds**.
  - **Continuous Shot** - Select to take a series of photos quickly while holding the capture button. Off (default) or On.
  - **Picture size** - The size (in pixels) of the photo to: **13M pixels** (default), **8M pixels**, **5M pixels**, **3M pixels**, **HD1080**, **2M pixels**, **HD720**, **1M pixels**, **WVGA**, **VGA**, or **QVGA**.
  - **Picture quality** - Set the picture quality setting to: **Low**, **Standard**, or **High** (default).
  - **Redeye reduction** - Helps eliminate redeye effect. Options: Disabled (default), or Enable.
  - **Exposure** - Set the exposure settings to: **-2**, **-1**, **0** (default), **+1**, **+2**.
  - **White balance** - Select how the camera adjusts colors in different kinds of light, to achieve the most natural-looking colors:
    - **Incandescent** - Adjust the white balance for incandescent lighting.
    - **Fluorescent** - Adjust the white balance for florescent lighting.
    - **Auto** - Adjust the white balance automatically (default).
    - **Daylight** - Adjust the white balance for daylight.
    - **Cloudy** - Adjust the white balance for a cloudy environment.
  - **Shutter Sound** - Select to play a shutter sound when taking a photo. Options: Disable or Enable (default).
  - **AF Animation** - Select to enable or disable the camera focus ring in the camera preview. Options: Disable (default) or Enable.
  - **Picture Format** - All still images are saved in JPEG format.
- **Video Camera** - These settings apply only to the video camera.
  - **Video quality** - Set video quality to: **HD 1080p** (default), **HD 720p**, **SD 480p**, **CIF**, or **QVGA**.
  - **Video duration** - Set to: **30 seconds (MMS)**, **10 minutes**, **30 minutes** (default), or **no limit**.
  - **Image Stabilization** - Set to reduce blurry videos due to device movement. Options: On or Off (default).

- **Noise Reduction** - **Off** (default), **Fast**, **High Quality**
- **Video Encoder** - Set the video encoder to: **MPEG4**, **H264** (default), **H265**.
- **Audio Encoder** - Set the audio encoder to: **AMRNB**, or **AAC** (default).
- **Video Rotation** - Set the rotation of the video to: **0** (default), **90**, **180**, or **270**.
- **Time Lapse** - Set the time lapse interval to: **Off** (default), or a time between **0.5 seconds** and **24 hours**.
- **System**
  - **Restore default** - Select to restore all settings to the default values.
  - **Version Info** - Displays the software version of the camera app.

## DataWedge Demonstration

Use **DataWedge Demonstration** (DWDemo) to demonstrate data capture functionality. To configure DataWedge, refer to [techdocs.zebra.com/datawedge/](http://techdocs.zebra.com/datawedge/).



**NOTE:** DataWedge is enabled on the Home screen. To disable this feature, go to the DataWedge settings and disable the **Launcher** profile.

**Table 3** DataWedge Demonstration Icons

	Icon	Description
Illumination		Imager illumination is on. Touch to turn illumination off.
		Imager illumination is off. Touch to turn illumination on.
Data Capture		The data capture function is through the internal imager.
		An RS507 or RS6000 Bluetooth imager is connected.
		An RS507 or RS6000 Bluetooth imager is not connected.
		The data capture function is through the rear camera. Only available on MC3300x-S/R devices configured with the camera option.
Scan Mode		Imager is in picklist mode. Touch to change to normal scan mode.
		Imager is in normal scan mode. Touch to change to picklist mode.
Menu		Opens a menu to view the application information or to set the application DataWedge profile.

## Scanner Selection

To select a scanner, touch > **Settings** > **Scanner selection**.

See the Data Capture section for more information.

Press the programmable button or touch the yellow scan button to capture data. The data appears in the text field below the yellow button.

## PTT Express Voice Client



**NOTE:** Requires a PTT Express License.

PTT Express Voice Client enables Push-To-Talk (PTT) communication between disparate enterprise devices. Leveraging existing Wireless Local Area Network (WLAN) infrastructure, PTT Express delivers simple PTT communication without requiring a voice communication server.

- **Group Call:** Press and hold the PTT (Talk) button to start communicating with other voice client users.
- **Private Response:** Double-press the PTT button to respond to the originator of the last broadcast or to make a Private Response.

## PTT Express User Interface

**Figure 1** PTT Express Default User Interface

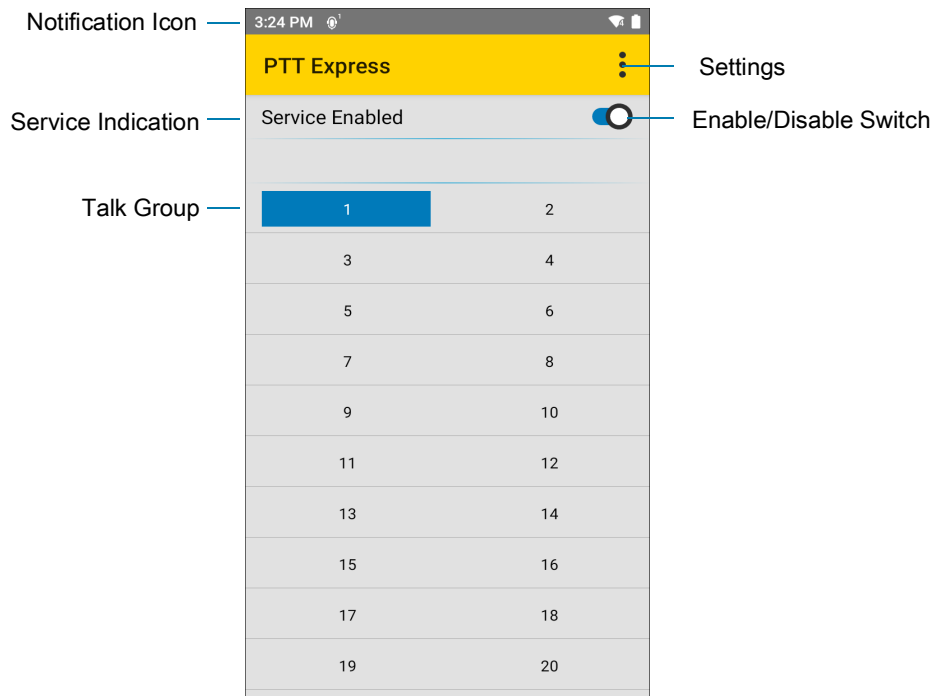



## PTT Audible Indicator

**Table 4** PTT Express Default User Interface Descriptions

Item	Description
Notification Icon	Indicates the current state of the PTT Express client.
Service Indication	Indicates the status of the PTT Express client. Options: <b>Service Enabled</b> , <b>Service Disabled</b> or <b>Service Unavailable</b> .
Talk Groups	Lists all 32 Talk Groups available for PTT communication.
Settings	Opens the PTT Express Settings screen.
Enable/Disable Switch	Turns the PTT service on and off.





The following tones provide helpful cues when using the voice client.

- **Talk Tone:** Double chirp. Plays when the Talk button is depressed. This is a prompt for you to start talking.
- **Access Tone:** Single beep. Plays when another user just finished a broadcast or response. You can now initiate a Group Broadcast or Private Response.
- **Busy Tone:** Continuous tone. Plays when the Talk button is depressed and another user is already communicating on the same talkgroup. Plays after the maximum allowed talk time is reached (60 seconds).
- **Network Tone:**
  - Three increasing pitch beeps. Plays when PTT Express acquires the WLAN connection and the service is enabled.
  - Three decreasing pitch beeps. Plays when PTT Express loses the WLAN connection or the service is disabled.



## PTT Notification Icons

Notification icons indicate the current state of the PTT Express Voice client.

**Table 5** PTT Express Icon Descriptions

Status Icon	Description
	The PTT Express Voice client is disabled.
	The PTT Express Voice client is enabled but not connected to a WLAN.
	The PTT Express Voice client is enabled, connected to a WLAN, and listening on the Talk Group indicated by the number next to the icon.
	The PTT Express Voice client is enabled, connected to a WLAN, and communicating on the Talk Group indicated by the number next to the icon.

**Table 5** PTT Express Icon Descriptions (Continued)

Status Icon	Description
	The PTT Express Voice client is enabled, connected to a WLAN, and in a private response.
	The PTT Express Voice client is enabled and muted.
	The PTT Express Voice client is enabled but it is not able to communicate due to a VoIP telephony call in progress.

## Enabling PTT Communication

1. Swipe up from the bottom of the Home screen and touch .
2. Slide the **Enable/Disable Switch** to the **ON** position. The button changes to **ON**.

## Selecting a Talk Group

One of 32 Talk Groups can be selected by PTT Express users. However, only one talk group may be enabled at a time on the device. Touch one of the 32 Talk Groups. The selected Talk Group is highlighted.

## PTT Communication



**NOTE:** This section describes the default PTT Express client configuration. Refer to the PTT Express V1.2 User Guide for detailed information on using the client.

In order to use a PTT Key with PTT Express, remap BUTTON\_L2 key to any available physical key, such as LEFT\_TRIGGER\_1, RIGHT\_TRIGGER\_1, SCAN, P1 or DIAMOND. By default, a PTT button is not assigned. For information on how to remap a key, refer to the Settings chapter.

PTT communication may be established as a Group Call.

### Creating a Group Call

1. Press and hold the PTT button (or the Talk button on the headset) and listen for the talk tone.
  - If you hear a busy tone, release the button and wait a moment before making another attempt. Ensure that PTT Express and the WLAN are enabled.
2. Start talking after hearing the talk tone.



**NOTE:** Holding the button for more than 60 seconds (default) drops the call, allowing others to make Group calls. Release the button when finished talking to allow others to make calls.

### Responding with a Private Response

The Private Response can only be initiated once a Group Call has been established. The initial Private Response is made to the originator of the Group Call.

1. Wait for an access tone.
2. Within 10 seconds, double-press the PTT button, and listen for the talk tone.
3. If you hear a busy tone, release the button and wait a moment before making another attempt. Ensure that PTT Express and the WLAN are enabled.

4. Start talking after the talk tone plays.
5. Release the button when finished talking.

### Disabling PTT Communication

1. Swipe up from the bottom of the Home screen and touch .
2. Slide the **Enable/Disable Switch** to the **OFF** position. The button changes to **OFF**.
3. Touch the Home button.

## RxLogger

RxLogger is a comprehensive diagnostic tool that provides application and system metrics, and diagnoses device and application issues. RxLogger logs the following information: CPU load, memory load, memory snapshots, battery consumption, power states, wireless logging, cellular logging, TCP dumps, Bluetooth logging, GPS logging, logcat, FTP push/pull, ANR dumps, etc. All generated logs and files are saved onto flash storage on the device (internal or external).

### RxLogger Configuration

RxLogger is built with an extensible plug-in architecture and comes packaged with a number of plug-ins already built-in. For information on configuring RxLogger, refer to [techdocs.zebra.com/rxlogger/](http://techdocs.zebra.com/rxlogger/).

To open the configuration screen, from the RxLogger home screen touch **Settings**.

### Configuration File

RxLogger configuration can be set using an XML file. The `config.xml` configuration file is located on the microSD card in the `RxLogger\config` folder. Copy the file from the device to a host computer using a USB connection. Edit the configuration file and then replace the XML file on the device. There is no need to stop and restart the RxLogger service since the file change is automatically detected.

### Enabling Logging

To enable logging:

1. Swipe the screen up and select .
2. Touch **Start**.
3. Touch the Home button.

### Disabling Logging

To disable logging:

1. Swipe the screen up and select .
2. Touch **Stop**.
3. Touch the Home button.

### Extracting Log Files

1. Connect the device to a host computer using an USB connection.
2. Using a file explorer, navigate to the `RxLogger` folder.
3. Copy the file from the device to the host computer.
4. Disconnect the device from the host computer.

### Backing Up

RxLogger Utility allows the user to make a zip file of the `RxLogger` folder in the device, which by default contains all the RxLogger logs stored in the device.

To save the backup data, touch  > **BackupNow**.

### RxLogger Utility

RxLogger Utility is a data monitoring application for viewing logs in the device while RxLogger is running. Logs and RxLogger Utility features are accessed using Main Chat Head.

#### Initiating the Main Chat Head

To initiate the Main Chat Head:

1. Open **RxLogger**.
2. Touch  > **Toggle Chat Head**. The Main Chat Head icon appears on the screen.
3. Touch and drag the Main Chat head icon to move it around the screen.

#### Removing the Main Chat Head

To remove the Main Chat Head icon:

1. Touch and drag the icon. A circle with an X appears.
2. Move the icon over the circle and then release.

#### Viewing Logs

To view logs:

1. Touch the Main Chat Head icon. The RxLogger Utility screen appears.
2. Touch a log to open it. The user can open many logs with each displaying a new sub Chat Head.
3. If necessary, scroll left or right to view additional Sub Chat Head icons.
4. Touch a Sub Chat Head to display the log contents.

#### Removing a Sub Chat Head Icon

To remove a sub chat Head icon, press and hold the icon until it disappears.

#### Backing Up In Overlay View

RxLogger Utility allows the user to make a zip file of the **RxLogger** folder in the device, which by default contains all the RxLogger logs stored in the device.

The Backup icon is always available in Overlay View.

1. Touch . The Backup dialog box appears.
2. Touch **Yes** to create the back up.

# Data Capture

The device supports data capture using:

- Internal Laser Scanner (SE965 1D)
- Imager (SE4720 1D/2D, SE4770 1D/2D, and SE4850-ER 1D/2D)
- RS5100 Bluetooth Ring Scanner
- RS6000 Bluetooth Ring Scanner
- RS507/RS507X Bluetooth Hands-free imager
- DS2278 Digital Barcode Scanner
- DS3678 Digital Barcode Scanner
- LI3678 Linear Scanner.

## Laser Scanning

The device with a laser scanner has the following features:

- Reading of a variety of barcode symbologies, including the most popular linear, postal, and 1D code types.
- Intuitive laser aiming for easy point-and-shoot operation.

## Imaging

The device with an integrated 2D imager has the following features:

- Omnidirectional reading of a variety of barcode symbologies, including the most popular linear, postal, PDF417, Digimarc, and 2D matrix code types.
- Advanced intuitive laser aiming cross-hair and dot aiming for easy point-and-shoot operation.

The imager uses imaging technology to take a picture of a barcode, stores the resulting image in memory, and executes state-of-the-art software decoding algorithms to extract the barcode data from the image.

## Operational Modes

The device with an integrated imager supports two modes of operation, listed below. Activate each mode by pressing the Scan button.

- Decode mode - The device attempts to locate and decode enabled barcodes within its field of view. The imager remains in this mode as long as you hold the scan button, or until it decodes a barcode.



**NOTE:** To enable Pick List Mode, configure in DataWedge or set in an application using a API command.

- Pick List mode - Selectively decode a barcode when more than one barcode is in the device's field of view by moving the aiming crosshair or dot over the required barcode. Use this feature for pick lists containing multiple barcodes and manufacturing or transport labels containing more than one barcode type (either 1D or 2D).



**NOTE:** To enable Basic MultiBarcode Mode, configure in DataWedge or set in an application using a API command.

- **Basic MultiBarcode Mode:** In this mode, the device attempts to locate and decode a specific number of unique barcodes within its field of view. The device remains in this mode as long as the user holds the scan button, or until it decodes all the barcodes. Available on integrated SE4720, SE4770, or SE4850 imagers only.
  - The device attempts to scan the programmed number of unique barcodes (from 2 through 100).
  - If there are duplicate barcodes (same symbology type and data), only one of the duplicate barcodes is decoded and the remainder are ignored. If the label has two duplicate barcodes plus another two different barcodes, a maximum of three barcodes will be decoded from that label; one will be ignored as a duplicate.
  - Barcodes can be of multiple symbology types and still be acquired together. For example, if the specified quantity for a Basic MultiBarcode scan is four, two barcodes can be symbology type Code 128 and the other two can be symbology type Code 39.
  - If the specified number of unique barcodes is not initially in view of the device, the device will not decode any data until the device is moved to capture the additional barcode(s) or time out occurs. If the device field of view contains a number of barcodes greater than the specified quantity, the device randomly decodes barcode(s) until the specified number of unique barcodes is reached. For example, if the count is set to two and eight barcodes are in the field of view, the device decodes the first two unique barcodes it sees, returning the data in random order.
- Basic MultiBarcode Mode does not support concatenated barcodes.

## Scanning Considerations

Typically, scanning is a simple matter of aim, scan, and decode, with a few quick trial efforts to master it. However, consider the following to optimize scanning performance:

- **Range:** Scanners decode best over a particular working range — minimum and maximum distances from the barcode. This range varies according to barcode density and scanning device optics. Scan within range for quick and constant decodes; scanning too close or too far away prevents decodes. Move the scanner closer and further away to find the right working range for the barcodes being scanned.
- **Angle:** Scanning angle is important for quick decodes. When the illumination/flash reflects directly back into the imager, the specular reflection can blind/saturate the imager. To avoid this, scan the barcode so that the beam does not bounce directly back. Do not scan at too sharp an angle; the scanner needs to collect scattered reflections from the scan to make a successful decode. Practice quickly shows what tolerances to work within.
- Hold the device farther away for larger symbols.
- Move the device closer for symbols with bars that are close together.



**NOTE:** Scanning procedures depend on the app and device configuration. An app may use different scanning procedures from the one listed above.

## Scanning with Internal Imager

To capture barcode data:

1. Ensure that an application is open on the device and a text field is in focus (text cursor in text field).
2. Point the top of the device at a barcode.

**Figure 2** Barcode Scanning – MC3300x–G

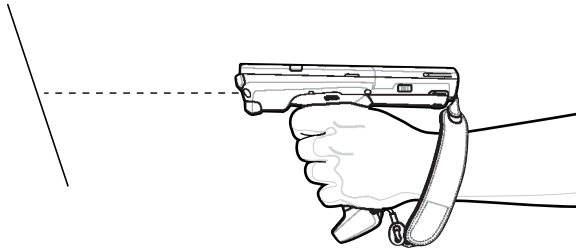

**Figure 3** Barcode Scanning – MC3300x–S

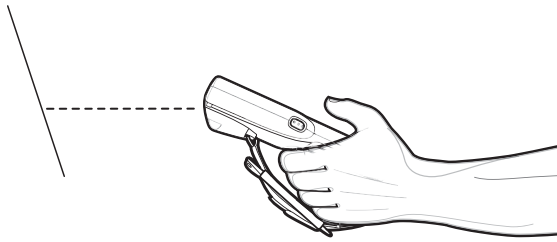

3. Press and hold the Scan button or Trigger.

The red laser aiming pattern turns on to assist in aiming.

4. Ensure the barcode is within the area formed by the cross-hairs in the aiming pattern. The aiming dot is used for increased visibility in bright lighting conditions.

The Scan LEDs light green and a beep sounds, by default, to indicate the barcode was decoded successfully. Note that when the device is in Pick List Mode, the device does not decode the barcode until the center of the crosshair touches the barcode.

**Figure 4** Aiming Pattern: Standard and Extended Range

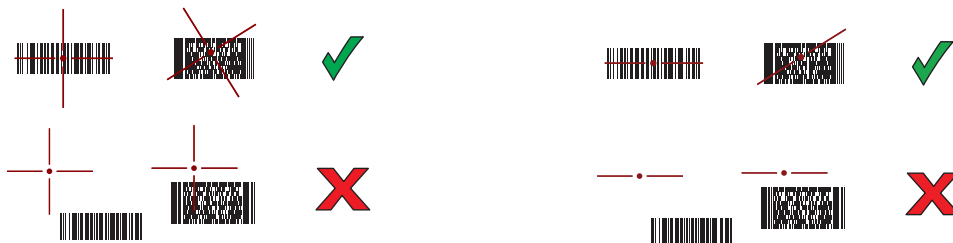



**Figure 5** Pick List Mode with Multiple Barcodes in Aiming Pattern: Standard and Extended Range



5. Release the scan button or Trigger.
6. The barcode content data appears in the text field.

## Scanning with Laser Scanner

To capture barcode data:

1. Ensure that an application is open on the device and a text field is in focus (text cursor in text field).
2. Point the top of the device at a barcode.
3. On the MC3300x-R, rotate the Turret for optimal scanning position.
4. Point the scan exit window at a barcode.

**Figure 6** Barcode Scanning – MC3300x-G

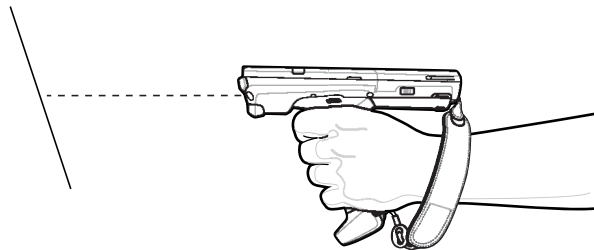

5. Press and hold the Scan button.

The red scan line turns on to assist in aiming. Ensure that the scan line crosses every bar and space of the barcode.

The Scan LEDs light green and a beep sounds, by default, to indicate the barcode was decoded successfully.

**Figure 7** Linear Scanner Aiming Pattern



6. Release the scan button.
7. The captured data appears in the text field.

## Scanning with RS5100 Ring Scanner

Use the RS5100 Ring Scanner to capture barcode data.

**Figure 8** RS5100 Ring Scanner

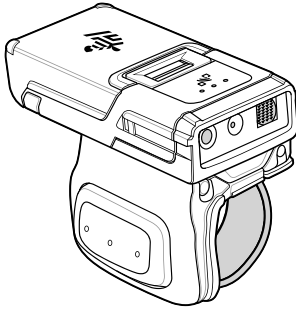

Refer to the RS5100 Ring Scanner Product Reference Guide for more information.



**NOTE:** To read a barcode, a scan-enabled app is required. The device contains the DataWedge app that allows you to enable the scanner to decode barcode data and display the barcode content.

To scan with the RS5100:

1. Pair the RS5100 with the device. See [Pairing Using Simple Serial Interface](#) or [Pairing Using Bluetooth Human Interface Device](#) for more information.
2. Ensure that an app is open on the device and a text field is in focus (text cursor in text field).
3. Point the RS5100 at a barcode.

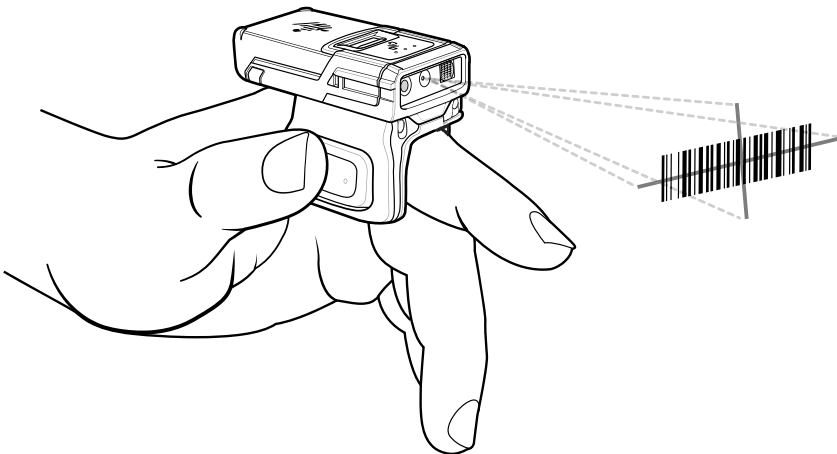

4. Press and hold the trigger.

The red laser aiming pattern turns on to assist in aiming. Ensure the barcode is within the area formed by the cross-hairs in the aiming pattern. The aiming dot increases visibility in bright lighting conditions.

**Figure 9** RS5100 Aiming Pattern

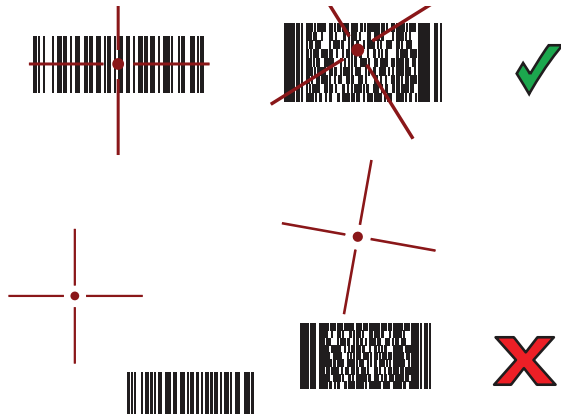

When the RS5100 is in Pick List mode, the RS5100 does not decode the barcode until the center of the crosshair touches the barcode.

**Figure 10** RS5100 Pick List Mode with Multiple Barcodes in Aiming Pattern



The RS5100 LEDs light green and a beep sounds to indicate the barcode was decoded successfully. The captured data appears in the text field.

## Scanning with the RS6000 Bluetooth Ring Scanner

Use the RS5000 Corded Imager to capture barcode data.

**Figure 11** RS6000 Bluetooth Ring Scanner

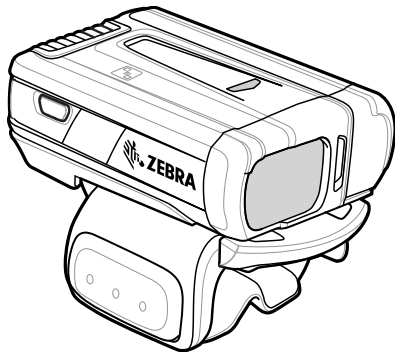

Refer to the RS6000 Bluetooth Ring Scanner Product Reference Guide for more information.



**NOTE:** To read a barcode, a scan-enabled app is required. The device contains the DataWedge app that allows you to enable the scanner to decode barcode data and display the barcode content.

To scan with the RS6000:

1. Pair the RS6000 with the device. See Pairing Using Bluetooth Human Interface Device for more information.
2. Ensure that an app is open on the device and a text field is in focus (text cursor in text field).
3. Point the RS6000 at a barcode.

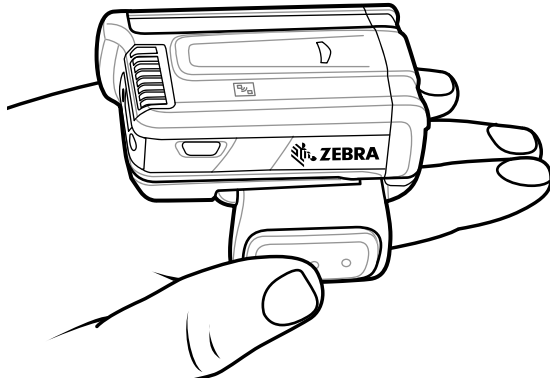

4. Press and hold the trigger.

The red laser aiming pattern turns on to assist in aiming. Ensure the barcode is within the area formed by the cross-hairs in the aiming pattern. The aiming dot increases visibility in bright lighting conditions.

**Figure 12** RS6000 Aiming Pattern

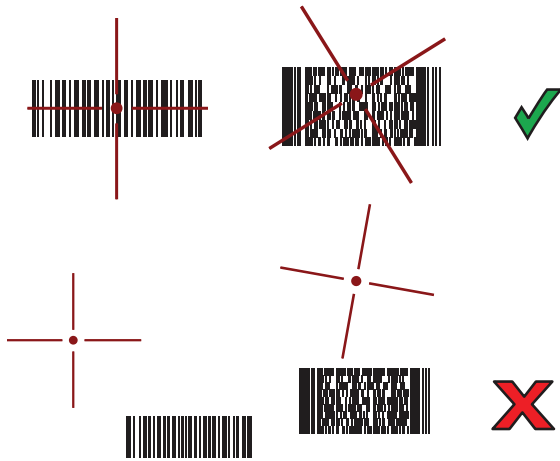

When the RS6000 is in Pick List mode, the RS6000 does not decode the barcode until the center of the crosshair touches the barcode.

**Figure 13** RS6000 Pick List Mode with Multiple Barcodes in Aiming Pattern



The RS6000 LEDs light green and a beep sounds to indicate the barcode was decoded successfully. The captured data appears in the text field.

## Scanning with RS507/RS507X Hands-Free Imager

Use the RS507/RS507X Hands-Free Imager to capture barcode data.

**Figure 14** RS507/RS507X Hands-Free Imager



Refer to the RS507/RS507X Hands-free Imager Product Reference Guide for more information.



**NOTE:** To read a barcode, a scan-enabled app is required. The device contains the DataWedge app that allows you to enable the scanner to decode barcode data and display the barcode content.

To scan with the RS507/RS507X:

1. Pair the RS507/RS507X with the device. See [Pairing the Bluetooth Ring Scanner on page 84](#) for more information.
2. Ensure that an app is open on the device and a text field is in focus (text cursor in text field).
3. Point the RS507/RS507X at a barcode.

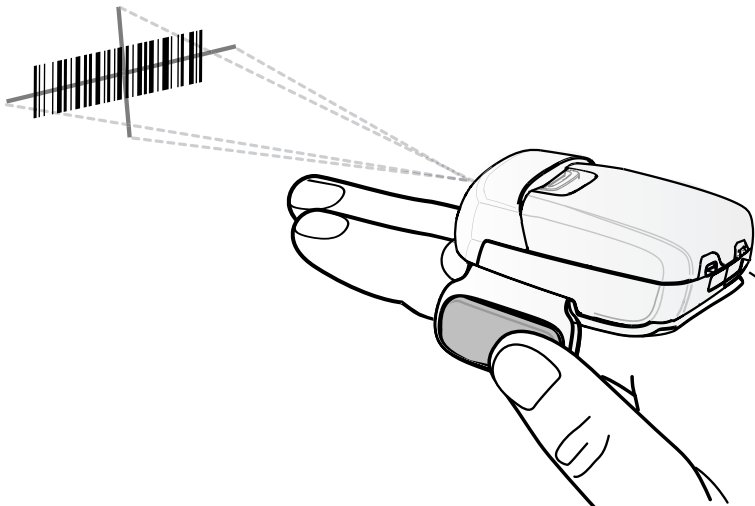

4. Press and hold the trigger.

The red laser aiming pattern turns on to assist in aiming. Ensure the barcode is within the area formed by the cross-hairs in the aiming pattern. The aiming dot increases visibility in bright lighting conditions.

**Figure 15** RS507/RS507X Aiming Pattern

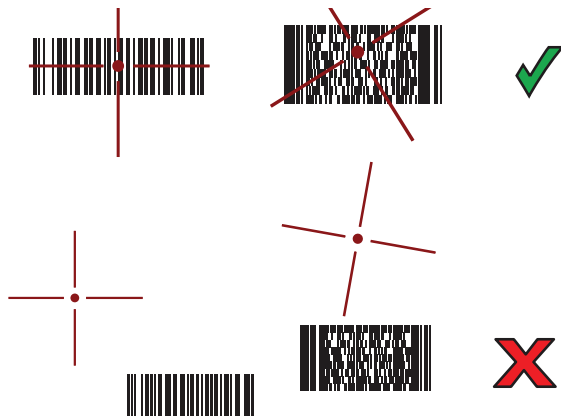

When the RS507/RS507X is in Pick List mode, the RS507/RS507X does not decode the barcode until the center of the crosshair touches the barcode.

**Figure 16** RS507/RS507X Pick List Mode with Multiple Barcodes in Aiming Pattern



The RS507/RS507X LEDs light green and a beep sounds to indicate the barcode was decoded successfully.

The captured data appears in the text field.

## Scanning with the DS2278 Digital Scanner

Use the DS2278 Digital Scanner to capture barcode data.

**Figure 17** DS2278 Digital Scanner

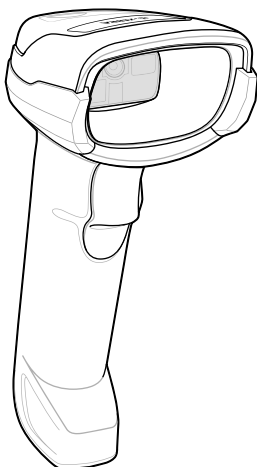

Refer to the DS2278 Digital Scanner Product Reference Guide for more information.



**NOTE:** To read a barcode, a scan-enabled app is required. The device contains the DataWedge app that allows you to enable the scanner to decode barcode data and display the barcode content.

To scan with the DS2278:

1. Pair the DS2278 with the device. See [Pairing a Bluetooth Scanner on page 88](#) for more information.
2. Ensure that an app is open on the device and a text field is in focus (text cursor in text field).
3. Point the scanner at a barcode.

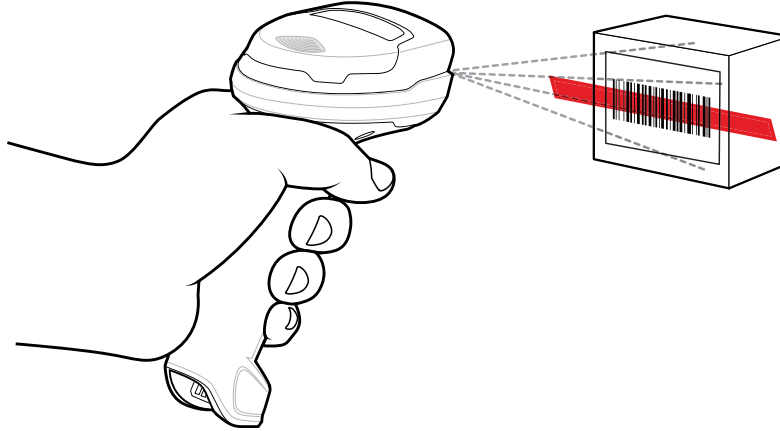

4. Press and hold the trigger.
5. Ensure the aiming pattern covers the barcode.



Upon successful decode, the scanner beeps and the LED flashes, and the scan line turns off.

The captured data appears in the text field.

## Scanning with the DS3678 Digital Scanner

Use the DS3678 Bluetooth Scanner to capture barcode data.

**Figure 18** DS3678 Digital Scanner

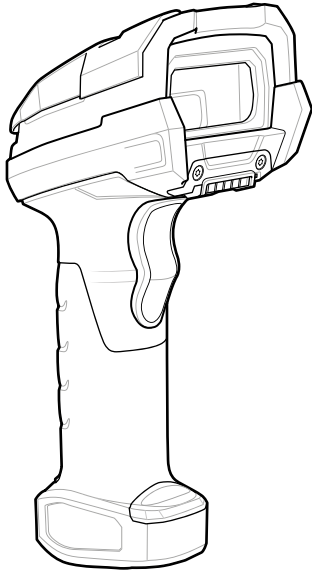

Refer to the DS36X8 Digital Scanner Product Reference Guide for more information.



**NOTE:** To read a barcode, a scan-enabled app is required. The device contains the DataWedge app that allows you to enable the scanner to decode barcode data and display the barcode content.

To scan with the DS3678:

1. Pair the scanner with the device. For more information, see [Pairing Bluetooth Scanners](#).
2. Ensure that an app is open on the device and a text field is in focus (text cursor in text field).
3. Point the scanner at a barcode.

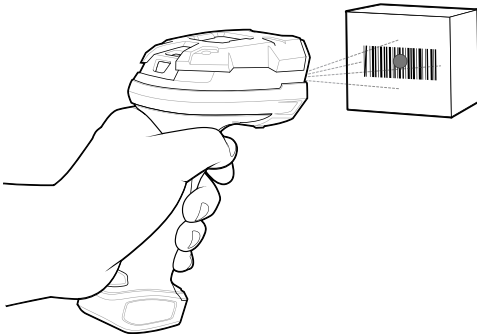



4. Press and hold the trigger.

Ensure the barcode is within the area formed by the aiming pattern. The aiming dot increases visibility in bright lighting conditions.

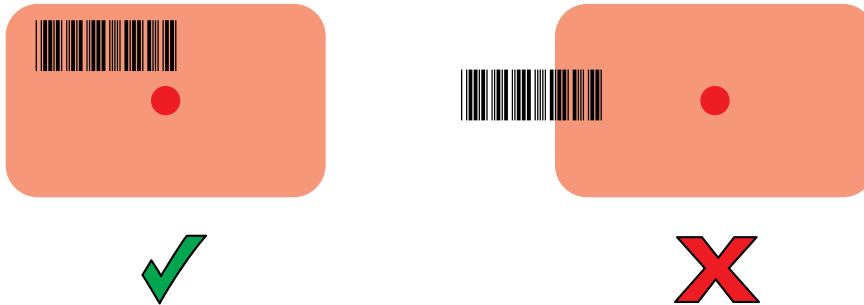

The captured data appears in the text field.

## Scanning with the DS3608 USB Scanner or DS3678 Bluetooth Scanner

To scan with the DS3608 or DS3678:

1. Pair the scanner with the device. For more information, see [Connecting a USB Scanner for the DS3608](#) or [Pairing Bluetooth Scanners for the DS3678](#).
2. Ensure that an app is open on the device and a text field is in focus (text cursor in text field).
3. Point the scanner at a barcode.

**Figure 19** Barcode Scanning (DS3678 shown)

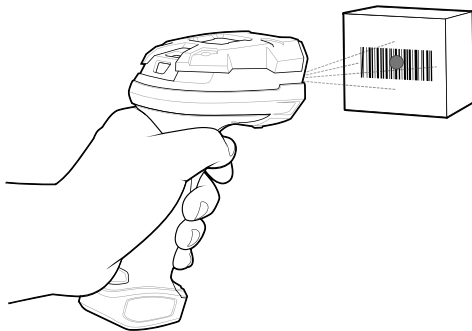

4. Press and hold the trigger.

Ensure the barcode is within the area formed by the aiming pattern. The aiming dot increases visibility in bright lighting conditions.

Figure 20 DS3608/DS3678 Aiming Pattern

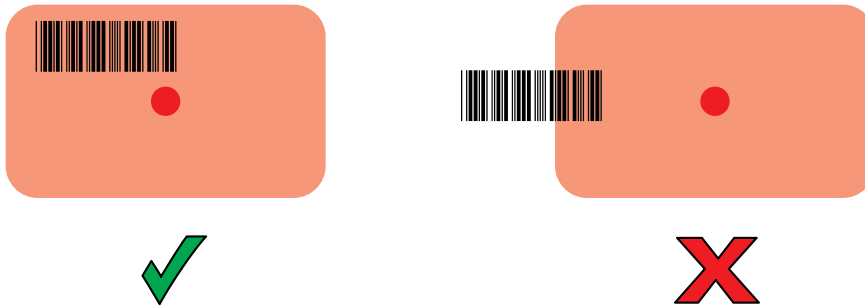
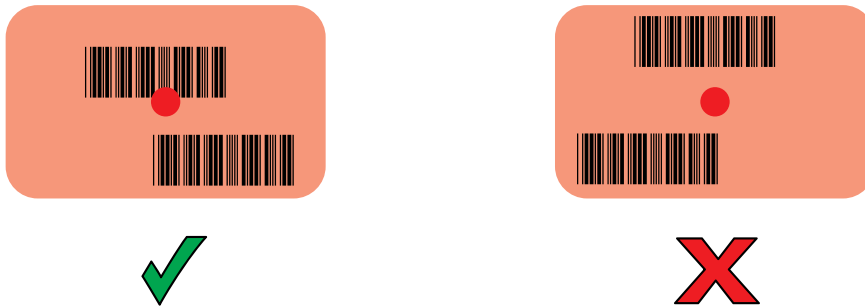

Figure 21 DS3608/DS3678 Pick List Mode with Multiple Barcodes in Aiming Pattern



5. The captured data appears in the text field.

## Scanning with the LI3678 Linear Scanner

Use the LI3678 linear imager to capture barcode data.

Figure 22 LI3678 Linear Scanner

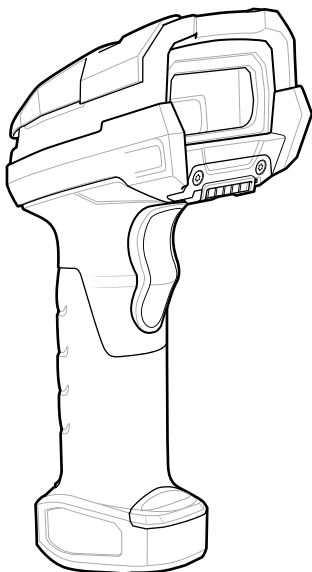

Refer to the LI36X8 Linear Scanner Product Reference Guide for more information.



**NOTE:** To read a barcode, a scan-enabled app is required. The device contains the DataWedge app that allows you to enable the scanner to decode barcode data and display the barcode content.

To scan with the LI3678:

1. Pair the LI3678 with the device. See [Pairing a Bluetooth Scanner on page 88](#) for more information.
2. Ensure that an app is open on the device and a text field is in focus (text cursor in text field).
3. Point the LI3678 at a barcode.
4. Press and hold the trigger.

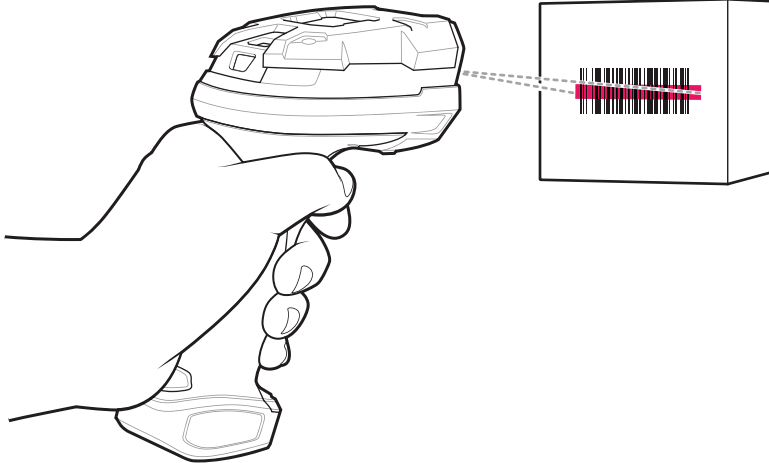

5. Ensure the aiming pattern covers the barcode.

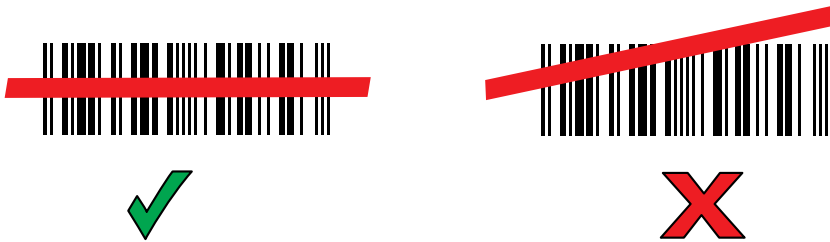

Upon successful decode, the scanner beeps and the LED displays a single green flash.  
The captured data appears in the text field.

## Pairing the Bluetooth Ring Scanner

To connect the Bluetooth Ring Scanner to the device, use one of the following methods:

- Near Field Communication (NFC) (RS5100/RS6000 only)
- Simple Serial Interface (SSI)
- Bluetooth Human Interface Device (HID) Mode.

### Pairing in SSI Mode Using Near Field Communication

The device provides the ability to pair the Ring Scanner in SSI mode using NFC.



**NOTE:** RS5100 and RS6000 only.

1. Ensure that the Ring Scanner is in SSI mode. Refer to the Ring Scanner User Guide for more information.
2. Ensure that NFC is enabled on the device.

3. Align the NFC icon on the Ring Scanner with the NFC antenna on the device.

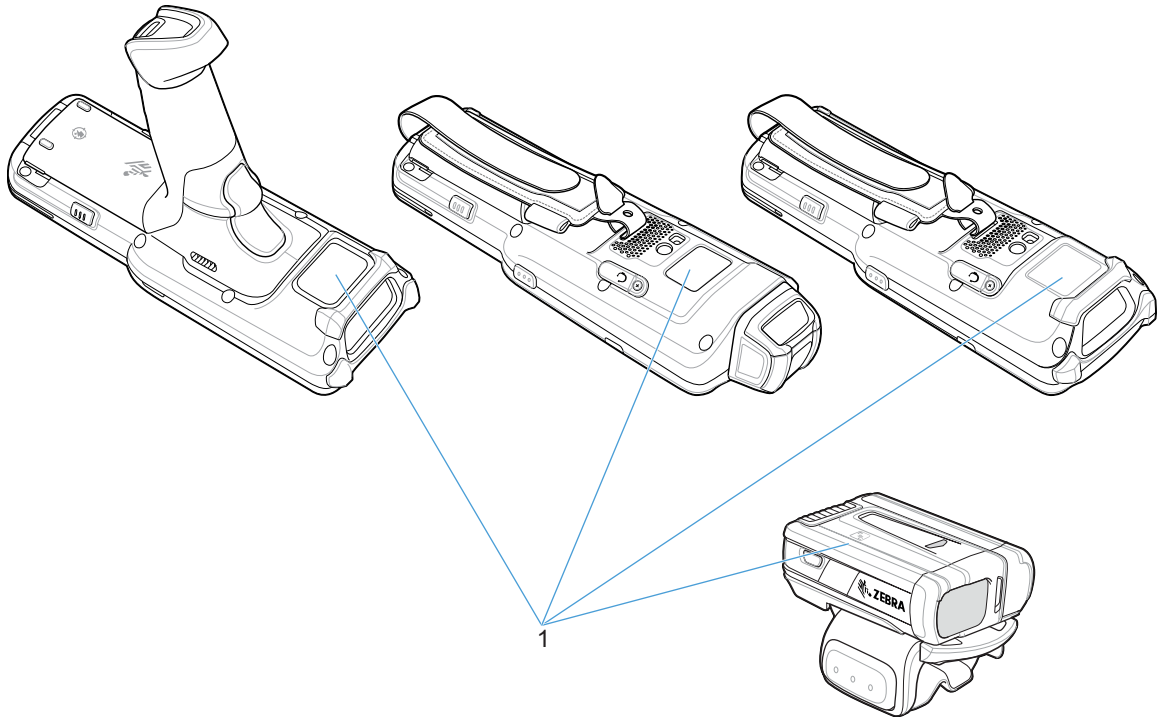

The Status LED blinks blue indicating that the Ring Scanner is attempting to establish connection with the device. When connection is established, the Status LED turns off and the Ring Scanner emits a single string of low/high beeps.

A notification appears on the device screen and the  icon appears in the Status bar.

### Pairing in HID Mode Using Near Field Communication

The device provides the ability to pair the Ring Scanner in HID mode using NFC.



**NOTE:** RS5100 and RS6000 only.

1. Ensure that NFC is enabled on the device.
2. Ensure that Bluetooth is enabled on the device.
3. Ensure that the Bluetooth device to discover is in discoverable mode.
4. Place the Ring Scanner in Human Interface Device (HID) mode. If the Ring Scanner is already in HID mode, skip to step 4.
  - a. Remove the battery from the Ring Scanner.
  - b. Press and hold the Restore key.
  - c. Install the battery onto the Ring Scanner.
  - d. Keep holding the Restore key for about five seconds until a chirp is heard and the Scan LEDs flash green.
  - e. Scan the barcode below to place the Ring Scanner in HID mode.



5. Remove the battery from the Ring Scanner.
6. Re-install the battery into the Ring Scanner.
7. Align the NFC icon on the Ring Scanner with the NFC antenna on the device.

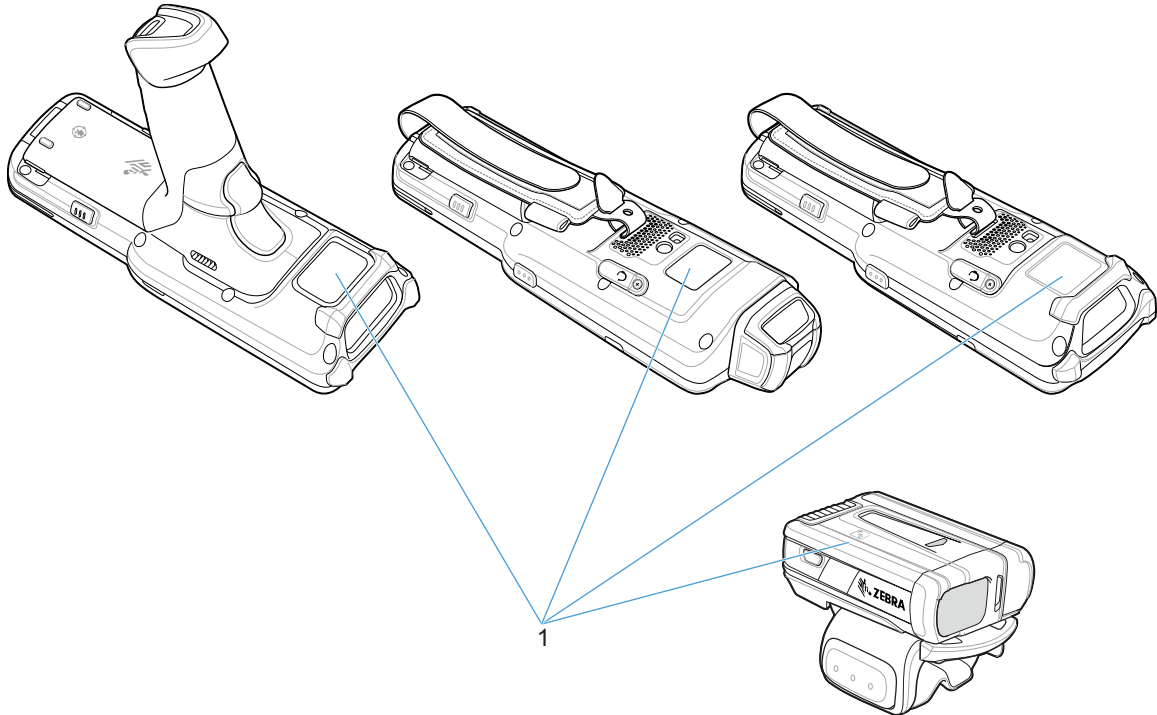

1	NFC Logo
---	----------

The Ring Scanner Status LED blinks blue indicating that the Ring Scanner is attempting to establish connection with the device. When connection is established, the Status LED turns off and the Ring Scanner emits a single string of low/high beeps.

A notification appears on the device screen and the **A** icon appears in the Status bar.

## Pairing Using Simple Serial Interface

Pair the Ring Scanner with the device using SSI.

1. Swipe up from the bottom of the Home screen and touch .

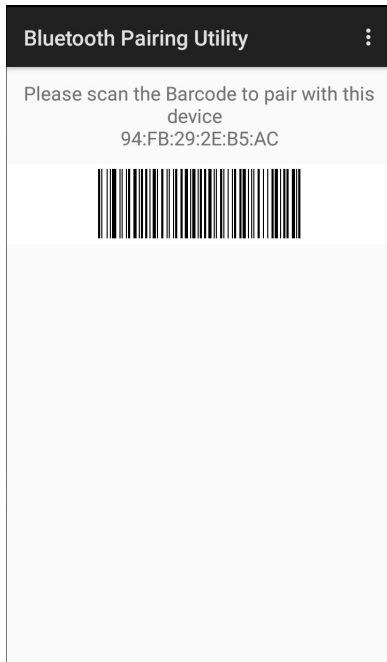

2. Using the Ring Scanner, scan the barcode on the screen.

The Ring Scanner emits a string of high/low/high/low beeps. The Scan LED flashes green indicating that the Ring Scanner is attempting to establish connection with the device. When connection is established, the Scan LED turns off and the Ring Scanner emits one string of low/high beeps.

A notification appears on the Notification panel and the  icon appears in the Status bar.

## Pairing Using Bluetooth Human Interface Device

Pair the Ring Scanner with the device using Human Interface Device (HID).

1. Ensure that Bluetooth is enabled on both devices.
2. Ensure that the Bluetooth device to discover is in discoverable mode.
3. Ensure that the two devices are within 10 meters (32.8 feet) of one another.
4. Place the Ring Scanner in HID mode. If the Ring Scanner is already in HID mode, skip to step 5.
  - a. Remove the battery from the Ring Scanner.
  - b. Press and hold the Restore key.
  - c. Install the battery onto the Ring Scanner.
  - d. Keep holding the Restore key for about five seconds until a chirp is heard and the Scan LEDs flash green.
  - e. Scan the barcode below to place the Ring Scanner in HID mode.

**Figure 23** RS507/RS507x Ring Scanner Bluetooth HID Barcode

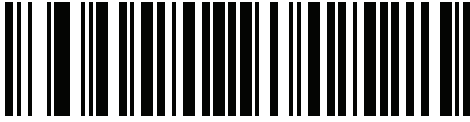

**Figure 24** RS5100 / RS6000 Ring Scanner Bluetooth HID Barcode

5. Remove the battery from the Ring Scanner.
6. Re-install the battery into the Ring Scanner.
7. Swipe down from the Status bar to open the Quick Access panel and then touch .
8. Touch **Bluetooth**.
9. Touch **Pair new device**. The device begins searching for discoverable Bluetooth devices in the area and displays them under **Available devices**.
10. Scroll through the list and select Ring Scanner.

The device connects to the Ring Scanner and **Connected** appears below the device name. The Bluetooth device is added to the **Paired devices** list and a trusted (“paired”) connection is established.

A notification appears on Notification panel and the  icon appears in the Status bar.

## Pairing a Bluetooth Scanner

Connect the scanner to the device using one of the following methods:

- Simple Serial Interface (SSI) mode
- Bluetooth Human Interface Device (HID) mode.

### Pairing Using Simple Serial Interface

To pair the scanner with the device using SSI:

1. Ensure that the two devices are within 10 meters (32.8 feet) of one another.
2. Install the battery into the scanner.
3. On the device swipe up from the bottom of the Home screen and touch .

Figure 25 Bluetooth Pairing Utility



4. Using the scanner, scan the barcode on the screen.

The scanner emits a high/low/high/low beeps. The Scan LED flashes green indicating that the scanner is attempting to establish connection with the device. When connection is established, the Scan LED turns off and the scanner emits one string of low/high beeps.

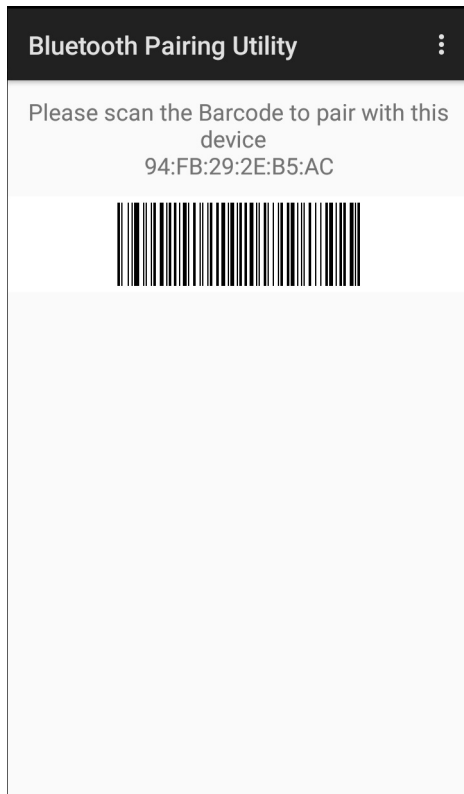
5. On the device touch the Home button.

## Pairing Using Bluetooth Human Interface Device

To pair the scanner with the device using HID:

1. Remove the battery from the scanner.
2. Replace the battery.
3. After the scanner reboots, scan the barcode below to place the scanner in HID mode.

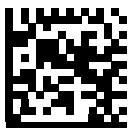

4. On the device, swipe down from the Status bar to open the Quick Access panel and then touch .
5. Touch **Bluetooth**.
6. Touch **Pair new device**. The device begins searching for discoverable Bluetooth devices in the area and displays them under **Available devices**.



7. Scroll through the list and select XXXXX xxxxxx, where XXXXX is the scanner and xxxxxx is the serial number.

The device connects to the scanner, the scanner beeps once and **Connected** appears below the device name. The Bluetooth device is added to the **Paired devices** list and a trusted (“paired”) connection is established.

## DataWedge

DataWedge is a utility that adds advanced barcode scanning capability to any application without writing code. It runs in the background and handles the interface to built-in barcode scanners. The captured barcode data is converted to keystrokes and sent to the target application as if it was typed on the keypad.

DataWedge allows any app on the device to get data from input sources such as a barcode scanner, MSR, RFID, voice, or serial port and manipulate the data based on options or rules.

Configure DataWedge to:

- Provide data capture services from any app.
- Use a particular scanner, reader or other peripheral device.
- Properly format and transmit data to a specific app.

To configure DataWedge refer to [techdocs.zebra.com/datawedge/](http://techdocs.zebra.com/datawedge/).

## Enabling DataWedge

1. Swipe up from the bottom of the Home screen and touch .
2. Touch **:** > **Settings**.
3. Touch the **DataWedge enabled** checkbox. A blue checkmark appears in the checkbox indicating that DataWedge is enabled.
4. Touch the Home button.

## Disabling DataWedge

1. Touch **:**.
2. Touch **Settings**.
3. Touch **DataWedge enabled**.

The blue check disappears from the checkbox indicating that DataWedge is disabled.

## Supported Decoders



**NOTE:** DataWedge supports the decoders listed below but not all are validated on this device.

**Table 6** Supported Decoders

Decoders	Internal Laser Scanner SE965	Internal Imager SE4720	Internal Imager SE4770	Internal Imager SE4850-ER	RS5100	RS6000	RS507/RS507X	DS2278	DS3678	LI3678
Australian Postal	--	O	O	O	O	O	O	O	O	--
Aztec	--	X	X	X	X	X	X	X	X	--
Canadian Postal	--	O	O	O	O	O	--	--	--	--
Chinese 2 of 5	O	O	O	O	O	O	O	O	O	O
Codabar	X	X	X	X	X	X	X	X	X	X
Code 11	O	O	O	O	O	O	O	O	O	O
Code 128	X	X	X	X	X	X	X	X	X	X
Code 39	X	X	X	X	X	X	X	X	X	X
Code 93	O	O	O	O	O	O	O	O	O	O
Composite AB	--	O	O	O	O	O	O	O	O	--
Composite C	--	O	O	O	O	O	O	O	O	--
Discrete 2 of 5	O	O	O	O	O	O	O	O	O	O
Datamatrix	--	X	X	X	X	X	X	X	X	--
Dutch Postal	--	O	O	O	O	O	O	O	O	--
DotCode	O	O	O	O	O	O	O	O	O	O
EAN13	X	X	X	X	X	X	X	X	X	X
EAN8	X	X	X	X	X	X	X	X	X	X
Grid Matrix	O	O	O	O	O	O	O	O	O	O
GS1 DataBar	X	X	X	X	X	X	X	X	X	X
GS1 DataBar Expanded	X	X	X	X	X	X	X	X	X	X
GS1 DataBar Limited	O	O	O	O	O	O	O	O	O	O
GS1 Datamatrix	--	O	O	O	O	O	--	O	O	--
GS1 QRCode	--	O	O	O	O	O	--	O	O	--
HAN XIN	--	O	O	O	O	O	--	--	O	O
Interleaved 2 of 5	O	O	O	O	O	O	O	O	O	O

**Table 6** Supported Decoders (Continued)

Decoders	Internal Laser Scanner SE965	Internal Imager SE4720	Internal Imager SE4770	Internal Imager SE4850-ER	RS5100	RS6000	RS507/RS507X	DS2278	DS3678	LI3678
Japanese Postal	--	O	O	O	O	O	O	O	O	--
Korean 3 of 5	O	O	O	O	O	O	O	O	O	O
MAIL MARK	--	X	X	X	X	X	--	X	X	--
Matrix 2 of 5	O	O	O	O	O	O	O	O	O	O
Maxicode	--	X	X	X	X	X	X	X	X	--
MicroPDF	--	O	O	O	O	O	O	O	O	--
MicroQR	--	O	O	O	O	O	O	O	O	--
MSI	O	O	O	O	O	O	O	O	O	O
PDF417	--	X	X	X	X	X	X	X	X	--
QR Code	--	X	X	X	X	X	X	X	X	--
Decoder Signature	--	O	O	O	O	O	O	O	--	--
TLC 39	O	O	O	O	O	O	O	O	O	O
Trioptic 39	O	O	O	O	O	O	O	O	O	O
UK Postal	--	O	O	O	O	O	O	O	O	--
UPCA	X	X	X	X	X	X	X	X	X	X
UPCE0	X	X	X	X	X	X	X	X	X	X
UPCE1	O	O	O	O	O	O	O	O	O	O
US4state	--	O	O	O	O	O	O	O	O	--
US4state FICS	--	O	O	O	O	O	O	O	O	--
US Planet	--	O	O	O	O	O	O	O	O	--
US Postnet	--	O	O	O	O	O	O	O	O	--

**Key**

X = Enabled

O = Disabled

-- = Not Supported

Touch the Back button to return to the previous screen.

# Wireless

This section provides information on the following wireless features:

- Wireless Local Area Network (WLAN)
- Bluetooth
- Cast
- Near Field Communications (NFC)

## Wireless Local Area Networks

Wireless local area networks (WLANs) allow the device to communicate wirelessly inside a building. Before using the device on a WLAN, the facility must be set up with the required hardware to run the WLAN (sometimes known as infrastructure). The infrastructure and the device must both be properly configured to enable this communication.

Refer to the documentation provided with the infrastructure (access points (APs), access ports, switches, Radius servers, etc.) for instructions on how to set up the infrastructure.

Once the infrastructure is set up to enforce the chosen WLAN security scheme, use the **Wireless & networks** settings configure the device to match the security scheme.

The device supports the following WLAN security options:

- Open
- Wireless Equivalent Privacy (WEP)
- Wi-Fi Protected Access (WPA)/WPA2 Personal (PSK)
- WPA/WPA2/WPA3 Enterprise (EAP)
  - Protected Extensible Authentication Protocol (PEAP) - with MSCHAPV2 and GTC authentication.
  - Transport Layer Security (TLS)
  - Tunneled Transport Layer Security (TTLS) - with Password Authentication Protocol (PAP), MSCHAP, MSCHAPv2, and GTC authentication
  - Flexible Authentication via Secure Tunneling (EAP-FAST) - with MSCHAPV2 and GTC authentication

The **Status** bar displays icons that indicate Wi-Fi network availability and Wi-Fi status.



**NOTE:** To extend the life of the battery, turn off Wi-Fi when not in use.

## Connecting to a Wi-Fi Network

To connect to a Wi-Fi network:

1. Go to **Settings > Network & Internet**.
2. Touch **Wi-Fi** to open the **Wi-Fi** screen. The device searches for WLANs in the area and lists them.
3. Scroll through the list and select the desired WLAN network.
4. For open networks, touch profile once or press and hold and then select **Connect** or for secure networks enter the required password or other credentials then touch **Connect**. See the system administrator for more information.

The device obtains a network address and other required information from the network using the dynamic host configuration protocol (DHCP) protocol. To configure the device with a fixed internet protocol (IP) address, see [Configuring the Device to Use a Static IP Address on page 96](#).

5. In the Wi-Fi setting field, **Connected** appears indicating that the device is connected to the WLAN.

## Removing a Wi-Fi Network

To remove a remembered or connected network:

1. Go to **Settings**.
2. Touch **Network & Internet > W-Fi**.
3. Scroll down to the bottom of the list and touch **Saved networks**.
4. Touch the name of the network.
5. Touch **FORGET**.
6. Touch the Home button.

## WLAN Configuration

This section provides information on configuring Wi-Fi settings.

### Configuring a Secure Wi-Fi Network

1. Go to **Settings**.
2. Touch **Network & Internet > Wi-Fi**.
3. Slide the switch to the **ON** position.
4. The device searches for WLANs in the area and lists them on the screen.
5. Scroll through the list and select the desired WLAN network.
6. Touch the desired network. If the network security is **Open**, the device automatically connects to the network. For all other network security a dialog box appears.
7. If the network security is WPA/WPA2-Personal, or WEP, enter the required password and then touch **Connect**.
8. If the network security is WPA/WPA2/WPA3 Enterprise:
  - a. Touch the **EAP method** drop-down list and select one of the following:
    - **TTLS**

- **LEAP.**
- b. Fill in the appropriate information. Options vary depending on the EAP method chosen.
    - Certification Authority (CA) certificates are installed using the **Security** settings.
    - When using the EAP methods PEAP, TLS, or TTLS you must specify a domain.
    - Touch **Advanced options** to display additional network options.



**NOTE:** By default, the network Proxy is set to **None** and the IP settings is set to **DHCP**. See [Configuring for a Proxy Server](#) for setting connection to a proxy server and see [Configuring the Device to Use a Static IP Address](#) for setting the device to use a static IP address.

9. Touch **Connect**.
10. Touch the Home button.

## Manually Adding a Wi-Fi Network

Manually add a Wi-Fi network if the network does not broadcast its name (SSID) or to add a Wi-Fi network when out of range.

1. Go to **Settings**.
2. Touch **Network & Internet > Wi-Fi**.
3. Slide the Wi-Fi switch to the **On** position.
4. Scroll to the bottom of the list and select **Add network**.
5. In the **Network name** text box, enter the name of the Wi-Fi network.
6. In the **Security** drop-down list, set the type of security to:
  - **None**
  - **WEP**
  - **WPA/WPA2-Personal**
  - **WPA/WPA2/WPA3-Enterprise**
7. If the network security is **None**, touch **Save**.
8. If the network security is **WEP** or **WPA/WPA2-Personal**, enter the required password and then touch **Save**.
9. If the network security is WPA/WPA2/WPA3 Enterprise:
  - a. Touch the **EAP method** drop-down list and select one of the following:
    - **TTLS**
    - **LEAP.**
  - b. Fill in the appropriate information. Options vary depending on the EAP method chosen.
    - Certification Authority (CA) certificates are installed using the **Security** settings.
    - When using the EAP methods PEAP, TLS, or TTLS you must specify a domain.
    - Touch **Advanced options** to display additional network options.



**NOTE:** By default, the network Proxy is set to **None** and the IP settings is set to **DHCP**. See [Configuring for a Proxy Server on page 96](#) for setting connection to a proxy server and see [Configuring the Device to Use a Static IP Address on page 96](#) for setting the device to use a static IP address.

10. Touch **Save**. To connect to the saved network, touch and hold on the saved network and select **Connect to network**.
11. Touch the Home button.

## Configuring for a Proxy Server

A proxy server is a server that acts as an intermediary for requests from clients seeking resources from other servers. A client connects to the proxy server and requests some service, such as a file, connection, web page, or other resource, available from a different server. The proxy server evaluates the request according to its filtering rules. For example, it may filter traffic by IP address or protocol. If the request is validated by the filter, the proxy provides the resource by connecting to the relevant server and requesting the service on behalf of the client.

It is important for enterprise customers to be able to set up secure computing environments within their companies, making proxy configuration essential. Proxy configuration acts as a security barrier ensuring that the proxy server monitors all traffic between the Internet and the intranet. This is normally an integral part of security enforcement in corporate firewalls within intranets.

1. Go to **Settings**.
2. Touch **Network & Internet > Wi-Fi**.
3. Slide the Wi-Fi switch to the **On** position.
4. In the network dialog box, select and touch a network.
5. To edit a connected network, touch  and then touch the down arrow to hide the keyboard.
6. Touch **Advanced options**.
7. Touch **Proxy** and select **Manual**.
8. In the **Proxy hostname** text box, enter the address of the proxy server.
9. In the **Proxy port** text box, enter the port number for the proxy server.
10. In the **Bypass proxy for** text box, enter addresses for web sites that are not required to go through the proxy server. Use a comma “,” between addresses. Do not use spaces or carriage returns between addresses.
11. If editing a connected network, touch **Save**, otherwise, touch **Connect**.
12. Touch the Home button.

## Configuring the Device to Use a Static IP Address

By default, the device is configured to use Dynamic Host Configuration Protocol (DHCP) to assign an Internet protocol (IP) address when connecting to a wireless network.

1. Go to **Settings**.
2. Touch **Network & Internet > Wi-Fi**.
3. Slide the Wi-Fi switch to the **On** position.
4. In the network dialog box, select and touch a network.
5. To edit a connected network, touch  and then touch the down arrow to hide the keyboard.
6. Touch **Advanced options**.
7. Touch **IP settings** and select **Static**.
8. In the **IP address** text box, enter an IP address for the device.

9. If required, in the **Gateway** text box, enter a gateway address for the device.
10. If required, in the **Network prefix length** text box, enter the prefix length.
11. If required, in the **DNS 1** text box, enter a Domain Name System (DNS) address.
12. If required, in the **DNS 2** text box, enter a DNS address.
13. In the **Privacy** drop-down, the default **Use randomized MAC (default)** provides enhanced privacy, or you can choose **Use device MAC**.
14. If editing a connected network, touch **Save**, otherwise, touch **Connect**.
15. Touch the Home button.

## Wi-Fi Preferences

Use the **Wi-Fi preferences** to configure advanced Wi-Fi settings. From the Wi-Fi screen scroll down to the bottom of the screen and touch **Wi-Fi preferences**.

- **Turn on Wi-Fi automatically** - When enabled, Wi-Fi automatically turns back on when near high quality saved networks.
- **Notify for public networks** - Notifies you when a high-quality public network is available.
- **Advanced** - Touch to expand options.
  - **Additional settings** - See [Additional Wi-Fi Settings](#).
  - **Install Certificates** – Touch to install certificates.
  - **Network rating provider** - Disabled (AOSP devices). To help determine what constitutes a good Wi-Fi network, Android supports external Network rating providers that provide information about the quality of open Wi-Fi networks. Select one of the providers listed or **None**. If none are available or selected, the Connect to open networks feature is disabled.
  - **Wi-Fi Direct** - Displays a list of devices available for a direct Wi-Fi connection.

## Additional Wi-Fi Settings



**NOTE:** Additional Wi-Fi settings are for the device, not for a specific wireless network.

Use the **Additional Settings** to configure additional Wi-Fi settings. To view the additional Wi-Fi settings, scroll to the bottom of the **Wi-Fi** screen and touch **Wi-Fi Preferences > Advanced > Additional settings**.

- **Regulatory**
  - **Country Selection** - Displays the acquired country code if 802.11d is enabled, else it displays the currently selected country code.
  - **Region code** - Displays the current region code.
- **Band and Channel Selection**
  - **Wi-Fi frequency band** - Set the frequency band to: **Auto** (default), **5 GHz only** or **2.4 GHz only**.
  - **Available channels (2.4 GHz)** - Touch to display the **Available channels** menu. Select specific channels and touch **OK**.
  - **Available channels (5 GHz)** - Touch to display the **Available channels** menu. Select specific channels and touch **OK**.
- **Logging**
  - **Advanced Logging** – Touch to enable advanced logging or change the log directory.



- **Wireless logs** - Use to capture Wi-Fi log files.
  - **Fusion Logger** - Touch to open the **Fusion Logger** application. This application maintains a history of high level WLAN events which helps to understand the status of connectivity.
  - **Fusion Status** - Touch to display live status of WLAN state. Also provides information about the device and connected profile.
- **About**
  - **Version** - Displays the current Fusion information.

## Wi-Fi Direct

Wi-Fi Direct devices can connect to each other without having to go through an access point. Wi-Fi Direct devices establish their own ad-hoc network when required, letting you see which devices are available and choose which one you want to connect to.

1. Go to **Settings**.
2. Touch **Wi-Fi > Wi-Fi preferences > Advanced > Wi-Fi Direct**. The device begins searching for another Wi-Fi Direct device.
3. Under **Peer devices**, touch the other device name.
4. On the other device, select **Accept**.

**Connected** appears on the device. On both devices, in their respective Wi-Fi Direct screens, the other device name appears in the list.

## Bluetooth

Bluetooth devices can communicate without wires, using frequency-hopping spread spectrum (FHSS) radio frequency (RF) to transmit and receive data in the 2.4 GHz Industry Scientific and Medical (ISM) band (802.15.1). Bluetooth wireless technology is specifically designed for short-range (10 m (32.8 ft)) communication and low power consumption.

Devices with Bluetooth capabilities can exchange information (for example, files, appointments, and tasks) with other Bluetooth enabled devices such as printers, access points, and other mobile devices.

The device supports Bluetooth Low Energy. Bluetooth Low Energy is targeted at applications in the healthcare, fitness, security, and home entertainment industries. It provides reduced power consumption and cost while maintaining standard Bluetooth range.

## Adaptive Frequency Hopping

Adaptive Frequency Hopping (AFH) is a method of avoiding fixed frequency interferers, and can be used with Bluetooth voice. All devices in the piconet (Bluetooth network) must be AFH-capable in order for AFH to work. There is no AFH when connecting and discovering devices. Avoid making Bluetooth connections and discoveries during critical 802.11b communications. AFH for Bluetooth consists of four main sections:

- **Channel Classification** - A method of detecting an interference on a channel-by-channel basis, or pre-defined channel mask.
- **Link Management** - Coordinates and distributes the AFH information to the rest of the Bluetooth network.
- **Hop Sequence Modification** - Avoids interference by selectively reducing the number of hopping channels.

- Channel Maintenance - A method for periodically re-evaluating the channels.

When AFH is enabled, the Bluetooth radio “hops around” (instead of through) the 802.11b high-rate channels. AFH coexistence allows enterprise devices to operate in any infrastructure.



**NOTE:** It is not recommended to perform Bluetooth wireless technology inquiry when high rate 802.11b operation is required.

## Security

The current Bluetooth specification defines security at the link level. Application-level security is not specified. This allows application developers to define security mechanisms tailored to their specific need. Link-level security occurs between devices, not users, while application-level security can be implemented on a per-user basis. The Bluetooth specification defines security algorithms and procedures required to authenticate devices, and if needed, encrypt the data flowing on the link between the devices. Device authentication is a mandatory feature of Bluetooth while link encryption is optional.

Pairing of Bluetooth devices is accomplished by creating an initialization key used to authenticate the devices and create a link key for them. Entering a common personal identification number (PIN) in the devices being paired generates the initialization key. The PIN is never sent over the air. By default, the Bluetooth stack responds with no key when a key is requested (it is up to user to respond to the key request event). Authentication of Bluetooth devices is based-upon a challenge-response transaction. Bluetooth allows for a PIN or passkey used to create other 128-bit keys used for security and encryption. The encryption key is derived from the link key used to authenticate the pairing devices. Also worthy of note is the limited range and fast frequency hopping of the Bluetooth radios that makes long-distance eavesdropping difficult.

Recommendations are:

- Perform pairing in a secure environment
- Keep PIN codes private and do not store the PIN codes in the device
- Implement application-level security.

## Bluetooth Profiles

The device supports the Bluetooth services listed.

**Table 7** Bluetooth Profiles

Profile	Description
Service Discovery Protocol (SDP)	Handles the search for known and specific services as well as general services.
Serial Port Profile (SPP)	Allows use of RFCOMM protocol to emulate serial cable connection between two Bluetooth peer devices. For example, connecting the device to a printer.
Object Push Profile (OPP)	Allows the device to push and pull objects to and from a push server.
Advanced Audio Distribution Profile (A2DP)	Allows the device to stream stereo-quality audio to a wireless headset or wireless stereo speakers.
Audio/Video Remote Control Profile (AVRCP)	Allows the device to control A/V equipment to which a user has access. It may be used in concert with A2DP.

**Table 7** Bluetooth Profiles (Continued)

Profile	Description
Personal Area Network (PAN)	Allows the use of Bluetooth Network Encapsulation Protocol to provide L3 networking capabilities over a Bluetooth link. Only PANU role is supported.
Human Interface Device Profile (HID)	Allows Bluetooth keyboards, pointing devices, gaming devices and remote monitoring devices to connect to the device.
Headset Profile (HSP)	Allows a hands-free device, such as a Bluetooth headset, to place and receive calls on the device.
Hands-Free Profile (HFP)	Allows car hands-free kits to communicate with the device in the car.
Phone Book Access Profile (PBAP)	Allows exchange of Phone Book Objects between a car kit and a mobile device to allow the car kit to display the name of the incoming caller; allow the car kit to download the phone book so you can initiate a call from the car display.
Out of Band (OOB)	Allows exchange of information used in the pairing process. Pairing is completed using the Bluetooth radio, but requires information from the OOB mechanism. Using OOB with NFC enables pairing when devices simply get close, rather than requiring a lengthy discovery process.
Symbol Serial Interface (SSI)	Allows for communication with Bluetooth Imager.
Generic Attribute Profile (GATT)	Provides profile discovery and description services for Bluetooth Low Energy protocol. It defines how attributes are grouped together into sets to form services.
Dial Up Networking (DUN)	Provides a standard to access the Internet and other dial-up services over Bluetooth.
OBject EXchange (OBEX)	Facilitates the exchange of binary objects between devices.

## Bluetooth Power States

The Bluetooth radio is off by default.

- Suspend - When the device goes into suspend mode, the Bluetooth radio stays on.
- Airplane Mode - When the device is placed in Airplane Mode, the Bluetooth radio turns off. When Airplane mode is disabled, the Bluetooth radio returns to the prior state. When in Airplane Mode, the Bluetooth radio can be turned back on if desired.

## Bluetooth Radio Power

Turn off the Bluetooth radio to save power or if entering an area with radio restrictions (for example, an airplane). When the radio is off, other Bluetooth devices cannot see or connect to the device. Turn on the Bluetooth radio to exchange information with other Bluetooth devices (within range). Communicate only with Bluetooth radios in close proximity.



**NOTE:** To achieve the best battery life, turn off radios when not in use.

## Enabling Bluetooth

1. Swipe down from the Status bar to open the Notification panel.
2. Touch  to turn Bluetooth on.
3. Touch the Home button.

## Disabling Bluetooth

1. Swipe down from the Status bar to open the Notification panel.
2. Touch  to turn Bluetooth off.
3. Touch the Home button.

## Discovering Bluetooth Device(s)

The device can receive information from discovered devices without pairing. However, once paired, the device and a paired device exchange information automatically when the Bluetooth radio is on.

1. Ensure that Bluetooth is enabled on both devices.
2. Ensure that the Bluetooth device to discover is in discoverable mode.
3. Ensure that the two devices are within 10 meters (32.8 feet) of one another.
4. Swipe down from the Status bar to open the Quick Access panel.
5. Touch and hold **Bluetooth**.
6. Touch **Pair new device**. The device begins searching for discoverable Bluetooth devices in the area and displays them under **Available devices**.
7. Scroll through the list and select a device. The Bluetooth pairing request dialog box appears.
8. Touch **Pair** on both devices.
9. The Bluetooth device is added to the **Paired devices** list and a trusted (“paired”) connection is established.

## Changing the Bluetooth Name

By default, the device has a generic Bluetooth name that is visible to other devices when connected.

1. Go to **Settings**.
2. Touch **Connected devices > Connection preferences > Bluetooth**.
3. If Bluetooth is not on, move the switch to turn Bluetooth on.
4. Touch **Device name**.
5. Enter a name and touch **RENAME**.
6. Touch the Home button.

## Connecting to a Bluetooth Device

Once paired, connect to a Bluetooth device.

1. Go to **Settings**.
2. Touch **Connected devices > Connection preferences > Bluetooth**.

3. In the list, touch the unconnected Bluetooth device.

When connected, **Connected** appears below the device name.

## Selecting Profiles on the Bluetooth Device

Some Bluetooth devices have multiple profiles.

1. Go to **Settings**.
2. Touch **Connected devices > Connection preferences > Bluetooth**.
3. In the **Paired Devices** list, touch  next to the device name.
4. Turn on or off a profile to allow the device to use that profile.
5. Touch the Home button.

## Unpairing a Bluetooth Device

Unpairing a Bluetooth device erases all pairing information.

1. Go to **Settings**.
2. Touch **Connected devices > Connection preferences > Bluetooth**.
3. In the **Paired Devices** list, touch  next to the device name.
4. Touch **FORGET**.
5. Touch the Home button.

## Using a Bluetooth Headset

Use a Bluetooth headset for audio communication when using an audio-enabled app. See Bluetooth for more information on connecting a Bluetooth headset to the device. Set the volume appropriately before putting on the headset. When a Bluetooth headset is connected, the speakerphone is muted.

## Cast

Use **Cast** to mirror the device screen on a Miracast enabled wireless display.

1. Go to **Settings**.
2. Touch **Connected devices > Connection preferences > Cast**.
3. Touch  > **Enable wireless display**.  
The device searches for nearby Miracast devices and lists them.
4. Touch a device to begin casting.
5. Touch the Home button.

## Near Field Communications

NFC/HF RFID is a short-range wireless connectivity technology standard that enables secure transaction between a reader and a contactless smartcard. The technology is based on ISO/IEC 14443 type A and B (proximity) ISO/IEC 15693 (vicinity) standards, using the HF 13.56 MHz unlicensed band.

The device supports the following operating modes:

- Reader mode
- Peer-to-Peer communication
- Card Emulation mode.

Using NFC, the device can:

- Read contactless cards such as contactless tickets, ID cards and ePassport.
- Read and write information to contactless cards such as SmartPosters and tickets, as well as devices with NFC interface such as vending machines.
- Read information from supported medical sensors.
- Pair with supported Bluetooth devices such as printers, ring scanners (ex. RS6000), and headsets (ex. HS3100).
- Exchange data with another NFC device.
- Emulate contactless card such as payment,ticket, or SmartPoster.

The device NFC antenna is positioned to read NFC cards from the top of the device while the device is being held.

The device NFC antenna is centrally aligned with the back housing directly underneath the regulatory label and is designed for reading a range of NFC tags at distances from contact up to 2 cm from the rear of the device.

### Reading NFC Cards

Read contactless cards using NFC.

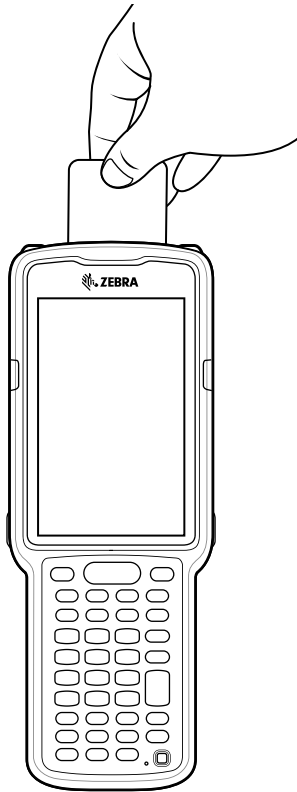
**Figure 26** Reading Cards

1. Launch an NFC enabled application.
2. Hold device as shown.
3. Move the device close to the NFC card until it detects the card.
4. Hold the card steadily until the transaction is complete (usually indicated by the application).

## Sharing Information Using NFC

You can beam content like a web page, contact cards, pictures, YouTube links or location information from your screen to another device by bringing the devices together back to back.

Make sure both devices are unlocked, support NFC, and have both NFC and Android Beam turned on.

1. Open a screen that contains a web page, video, photo or contact.
2. Move the back of the device toward the back of the other device.
3. Align the NFC logo on the device with the NFC antenna on the other device.
4. Move the front of the device toward the front of the other device.

When the devices connect, a sound emits, the image on the screen reduces in size, the message **Touch to beam** displays.

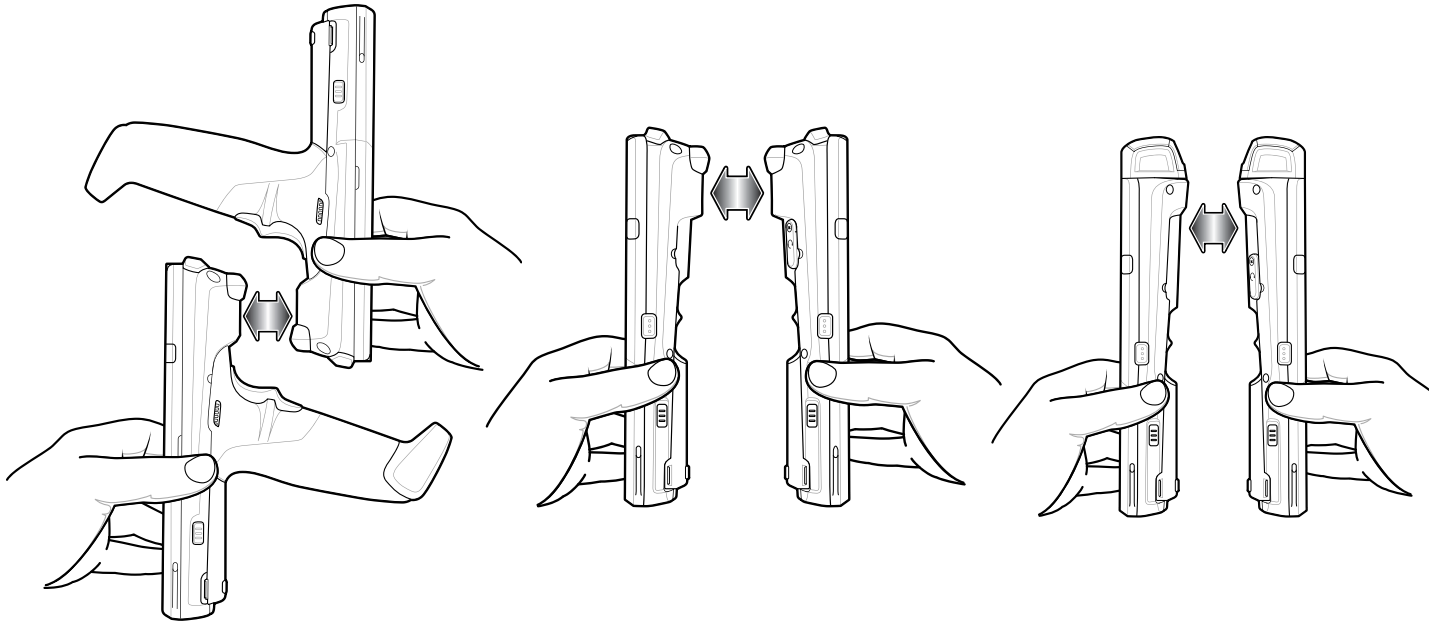

5. Touch anywhere on the screen.  
The transfer begins.

## Enterprise NFC Settings

Improve NFC performance or increase battery life by selecting which NFC features to use on the device.

To open Enterprise NFC Settings, go to **Settings > Connected devices > Connection Preference > Enterprise NFC Settings**.

- **Card Detection Mode** - Select a card detection mode.
  - **Low** - Increases battery life by lowering the NFC detection speed.
  - **Hybrid** - Provides a balance between NFC detection speed and battery life (default).
  - **Standard** - Provides the best NFC detection speed, but reduces battery life.
- **Supported Card Technology** - Select an option to detect only one NFC tag type, increasing battery life, but reducing detection speed.
  - **ISO 14443 Type A**
  - **ISO 14443 Type B**
  - **FeliCa**
  - **ISO15693**
- **NFC Debug Logging** - Allows the logging of NFC events on the device.
- **Other NFC settings available with Zebra administrator tools (CSP)** - Allows configuration of additional Enterprise NFC Settings through staging tools and Mobile Device Management (MDM) solutions with an MX version that supports the Enterprise NFC Settings Configuration Service Provider (CSP). For more information on using the Enterprise NFC Settings CSP, refer to: [techdocs.zebra.com](https://techdocs.zebra.com).



# Accessories

## Introduction

This chapter provides information for using the accessories for the device.

## MC3300x Accessories

The table below lists the accessories available for the MC3300x.

**Table 8** MC3300x Accessories

Accessory	Part Number	Description
<b>Cradles</b>		
1-Slot USB Charge Cradle with Spare Battery Charger	CRD-MC33-2SUCHG-01	Charges the MC3300x main battery and a spare battery, and synchronizes the MC3300x with a host computer through a USB connection. Requires power supply (PWR-BGA12V50W0WW), DC line cord (CBL-DC-388A1-01) and a country specific grounded AC line cord.
5-Slot Charge Only ShareCradle	CRD-MC33-5SCHG-01	Charge only. Charges up to five devices. Requires power supply (PWR-BGA12V108W0WW), DC line cord (CBL-DC-381A1-01) and a country specific grounded AC line cord.
5-Slot Ethernet ShareCradle	CRD-MC33-5SETH-01	Charges up to five devices and provides Ethernet communication for up to five devices. Requires power supply (PWR-BGA12V108W0WW), DC line cord (CBL-DC-381A1-01) and a country specific grounded AC line cord.

**Table 8** MC3300x Accessories (Continued)

Accessory	Part Number	Description
5-Slot Charge ShareCradle with 4-Slot Battery Charger	CRD-MC33-4SC4BC-01	Charge only. Charges up to four devices and up to four spare batteries. Requires power supply (PWR-BGA12V108W0WW), DC line cord (CBL-DC-381A1-01) and a country specific grounded AC line cord.
5-Slot Ethernet ShareCradle with 4-Slot Battery Charger	CRD-MC33-4SE4BC-01	Charges up to four devices and up to four spare batteries and provides Ethernet communication for up to four devices. Requires power supply (PWR-BGA12V108W0WW), DC line cord (CBL-DC-381A1-01) and a country specific grounded AC line cord.
<b>Chargers</b>		
4-Slot Spare Battery Charger	SAC-MC33-4SCHG-01	Charges up to four MC3300x spare batteries. Requires power supply (PWR-BGA12V50W0WW), DC line cord (CBL-DC-388A1-01) and a country specific grounded AC line cord.
20-Slot Spare Battery Charger	SAC-MC33-20SCHG-01	Charges up to 20 MC3300x spare batteries. Requires power supply (PWR-BGA12V108W0WW), DC line cord (CBL-DC-381A1-01) and a country specific grounded AC line cord.
Power Supply	PWR-BGA12V50W0WW	Level VI power supply. Provides 12 VDC, 2.5A power to the 1-Slot USB Charge Cradle and the 4-Slot Spare Battery Charger. Requires a DC line cord (CBL-DC-388A1-01) and a country specific grounded AC line cord.
Power Supply	PWR-BGA12V108W0WW	Level VI power supply. Provides 12 VDC, 2.5A power to the 5-Slot Charge Only Cradle, 5-Slot Ethernet Cradle, 5-Slot Charge Cradle with 4-Slot Battery Charger, 5-Slot Ethernet Cradle with 4-Slot Battery Charger and 20-Slot Battery Charger. Requires a DC line cord (CBL-DC-381A1-01) and a country specific grounded AC line cord.

## Accessories

**Table 8** MC3300x Accessories (Continued)

Accessory	Part Number	Description
Power Supply	PWR-WUA5V12W0US	Wall adapter; Provides 12 VDC, 2.5A power to the USB Charge Cable. Includes plug adapter for use in the United States.
Power Supply	PWR-WUA5V12W0GB	Provides 12 VDC, 2.5A power to the USB Charge Cable. Includes plug adapter for use in the European Union.
Power Supply	PWR-WUA5V12W0EU	Provides 12 VDC, 2.5A power to the USB Charge Cable. Includes plug adapter for use in the United Kingdom.
Power Supply	PWR-WUA5V12W0AU	Provides 12 VDC, 2.5A power to the USB Charge Cable. Includes plug adapter for use in Australia.
Power Supply	PWR-WUA5V12W0CN	Provides 12 VDC, 2.5A power to the USB Charge Cable. Includes plug adapter for use in China.
Power Supply	PWR-WUA5V12W0IN	Provides 12 VDC, 2.5A power to the USB Charge Cable. Includes plug adapter for use in India.
Power Supply	PWR-WUA5V12W0BR	Provides 12 VDC, 2.5A power to the USB Charge Cable. Includes plug adapter for use in Brazil.
US AC Line Cord	23844-00-00R	Provides power to 3-wire power supplies PWR-BGA12V50W0WW and PWR-BGA12V108W0WW.
DC Line Cord	CBL-DC-381A1-01	Provides power from the power supply (PWR-BGA12V108W0WW) to the 5-Slot Charge Only Cradle, 5-Slot Ethernet Cradle, 5-Slot Charge Cradle with 4-Slot Battery Charger, 5-Slot Ethernet Cradle with 4-Slot Battery Charger and 20-Slot Battery Charger.
DC Line Cord	CBL-DC-388A1-01	Provides power from the power supply (PWR-BGA12V150W0WW) to the 1-Slot USB Charge Cradle and 4-Slot Battery Charger.
<b>Cables</b>		
USB Charge Cable	CBL-MC33-USBCHG-01	Provides power and/or communication over USB to the device. Requires wall adapter/power supply PWR-WUA5V12W0xx.
1-Slot Cradle USB Cable	25-124330-01R	Provides USB communication through the 1-Slot USB cradle to the host computer.

**Table 8** MC3300x Accessories (Continued)

Accessory	Part Number	Description
<b>Miscellaneous</b>		
Cradle Adapter	ADP-MC33-CRDCUP-01	MC33XX Charge Only Adapter for backwards compatibility with MC32 cradles. Works with MC32N0 1-Slot USB Cradle, 4-Slot Charge Only Cradle, and 4-Slot Ethernet Cradles.
7000 mAh Battery (Extended PowerPrecision+)	BTRY-MC33-70MA-01	Replacement extended capacity battery.
	BTRY-MC33-70MA-10	Replacement extended capacity battery (10-pack).
	BTRY-MC33-70MA-IN	Replacement extended capacity battery (India).
5200 mAh Battery (High Capacity PowerPrecision+)	BTRY-MC33-52MA-01	Replacement high capacity battery.
	BTRY-MC33-52MA-10	Replacement high capacity battery (10-pack).
	BTRY-MC33-52MA-IN	Replacement high capacity battery (India).
2740 mAh Battery (Standard PowerPrecision+)	BTRY-MC33-27MA-01	Replacement standard capacity battery.
	BTRY-MC33-27MA-10	Replacement standard capacity battery (10-pack).
	BTRY-MC33-27MA-IN	Replacement standard capacity battery (India).
MC3300x-G Hand Strap	SG-MC33-HDSTPG-01	Replacement hand strap for the MC3300x-G. Hand strap loop holds an optional stylus (SG-TC7X-STYLUS-03).
MC3300x-R/S Hand Strap	SG-MC33-HDSTPB-01	Replacement hand strap for the MC3300x-R and MC3300x-S.
Rigid Holster	SG-MC33-RDHLST-01	Provides a clip on holder for the MC3300x-R and MC3300x-S.
MC3300x-G Fabric Holster	SG-MC3021212-01R	Provides a soft, clip on holster and a shoulder strap for the MC3300x-G.
MC3300x-R/S Fabric Holster	SG-MC3X-SHLSTB-01	Provides a soft, clip on holder and a shoulder strap for the MC3300x-R and MC3300x-S.
Shoulder Strap	58-40000-007R	Universal shoulder strap.
Belt	11-08062-02R	Belt for fabric holster.
MC3300x-G Rubber Boot	SG-MC33-RBTG-01	Provides additional protection for wear and tear of the MC3300x-G.
MC3300x-S Rubber Boot	SG-MC33-RBTS-01	Provides additional protection for the MC3300x-S.

**Table 8** MC3300x Accessories (Continued)

Accessory	Part Number	Description
MC3300x-R Rubber Boot for Terminal	SG-MC33-RBTRD-01	Provides additional protection for the MC3300x-R (terminal).
MC3300x-R Rubber Boot for Turret Cup	SG-MC33-RBTRT-01	Provides additional protection for the MC3300x-R (turret cup).
Tempered Glass Screen Protector	MISC-MC33-SCRN-01	Provides additional protection for display (5-pack).
Stylus and Tether	SG-TC7X-STYLUS-03	Conductive carbon-filled stylus for capacitive touch panel; includes coiled tether (3-pack).
Un-powered Forklift Mount	MNT-MC33-FLCHKT-01	Un-powered forklift mount. Allows installing the device on a roll bar or square surface of a forklift. Includes: Forklift holder (MNT-MC33-FLCH-01), RAM double socket arm for 1" ball (MNT-RAM-B201U) and RAM forklift clamp 2.5" max width square rail base with 1" ball (MNT-RAM-B247U25).

## Compatibility

The table below displays compatibility with MC3300x, MC33XX and MC3200 mobile computers and accessories.

Table 9 Compatibility

	MC3300x PP+ Battery	MC33 Series PP+ Batteries	MC32N0 PP Batteries	MC33XX Cradles	MC32N0 Cradles	MC33XX Battery Charger	MC32N0 Battery Charger
MC3300x mobile computer	Yes	Yes	No	Yes	Yes w/adapter	N/A	N/A
MC33XX mobile computer	No	Yes	Yes	Yes	Yes w/adapter	N/A	N/A
MC32N0 mobile computer	No	No	Yes	No	Yes	N/A	N/A
MC3300x PP+ battery	N/A	N/A	N/A	Yes	No	Yes	No
MC33 Series PP+ Batteries	N/A	N/A	N/A	Yes	No	Yes	No
MC32N0 PP Batteries	N/A	N/A	N/A	Yes	Yes	Yes	Yes

- MC3300x mobile computers are only compatible with MC33 PowerPrecision+ batteries.
- MC33XX mobile computers are compatible with all batteries (MC33XX PowerPrecision+ and MC32N0 PowerPrecision).
- MC3300x / MC33XX mobile computers are compatible with all cradles.  
An additional adapter is needed to use the MC32N0 terminal cradles, which provides charge only (no communication support).
- MC33XX battery chargers are compatible with all (MC3300x/MC33XX PowerPrecision+ and MC32N0 PowerPrecision) batteries.
- MC32N0 mobile computers are not compatible with MC33XX cradles.

## Battery Comparison

The table below displays a comparison of the MC3300x, MC33XX and the MC32XX batteries.

Table 10 Battery Comparison

Feature	MC32N0	MC33XX	MC3300x
Battery Type	PowerPrecision	PowerPrecision+	PowerPrecision+
Includes Zebra and PowerPrecision+ recessed logos	No	Yes	Yes
Back Label	Grey	Blue	Black

## Battery Compatibility

- MC3300x-G is compatible with the 7000mAh extended capacity & 5200mAh high capacity PowerPrecision+ batteries.
- MC3300x-R/S is compatible with the 7000mAh extended capacity, 5200mAh high capacity & 2740mAh standard capacity PowerPrecision+ batteries.
- MC3300x devices are not compatible with the legacy MC32N0 PowerPrecision batteries.

The following re-occurring message will be displayed if the incorrect battery is used with the MC3300x device. Please make sure you use one of the MC33XX compatible batteries.

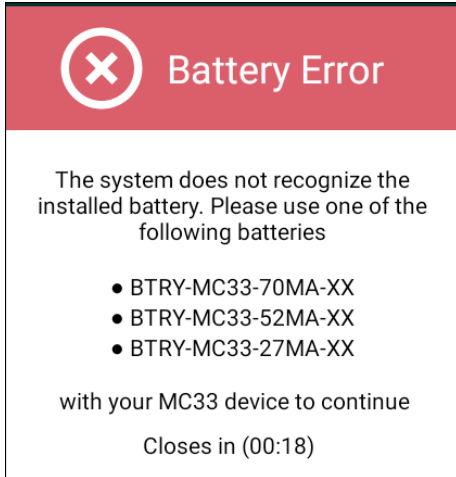

**NOTE:** The battery notification (shown above) cannot be disabled or suppressed on the MC3300x handheld device. Please make sure you use the appropriate MC33 PP+ batteries with the MC3300x device.

## Battery Charging

### Main Battery Charging

The device's Charging/Notification LED indicates the status of the battery charging in the device.

The MC3300x 7000 mAh PowerPrecision+ extended battery charges from 0% to 90% in less than 5.2 hours at room temperature.

The MC33XX 5200 mAh PowerPrecision+ high capacity battery charges from 0% to 90% in less than 3.8 hours at room temperature.

The MC33XX 2740 mAh PowerPrecision+ standard battery charges from 0% to 90% in less than 2.2 hours at room temperature.

### Spare Battery Charging

The spare battery charging LED on the cradle indicates the status of the spare battery charging in the cradle.

**Table 11** Spare Battery LED Charging Indicators

Spare Battery LED (on cradle)	Indication
Off	<ul style="list-style-type: none"> <li>The battery is not charging.</li> <li>The battery is not inserted correctly in the cradle or connected to a power source.</li> <li>Cradle is not powered.</li> </ul>
Blinking Amber	<ul style="list-style-type: none"> <li>Active wireless connectivity session during battery hot swap.</li> </ul>
Solid Amber	<ul style="list-style-type: none"> <li>Battery is charging.</li> </ul>
Solid Green	<ul style="list-style-type: none"> <li>Battery charging is complete.</li> </ul>
Fast Blinking Red 2 blinks/second	Charging error, e.g.: <ul style="list-style-type: none"> <li>Temperature is too low or too high.</li> <li>Charging has gone on too long without completion (typically eight hours).</li> </ul>
Solid Red	<ul style="list-style-type: none"> <li>Spare battery is charging and battery is at the end of useful life.</li> <li>Charging complete and battery is at the end of useful life.</li> </ul>

## Charging Temperature

Charge batteries in temperatures from 0 °C to 40 °C (32 °F to 104 °F). The device or cradle always performs battery charging in a safe and intelligent manner. At higher temperatures (e.g. approximately +37 °C (+98 °F)) the device or cradle may for small periods of time alternately enable and disable battery charging to keep the battery at acceptable temperatures. The device and cradle indicates when charging is disabled due to abnormal temperatures via its LED.



## 1-Slot USB Charge Cradle



**CAUTION:** Ensure that you follow the guidelines for battery safety described in [Battery Safety Guidelines on page 175](#).

The 1-Slot USB Charge Cradle:

- Provides 9 VDC power for charging the mobile computer and charging the battery.
- Provides 4.2 VDC power to charge the spare battery.
- Provides a USB port for data communication between the mobile computer and a host computer or other USB devices (e.g., a printer).
- Synchronizes information between the mobile computer and a host computer. With customized or third party software, it can also synchronize the mobile computer with corporate databases.

Compatible with the following batteries (charging in a device):

- MC3300x 7000mAh PowerPrecision+ extended capacity battery
- MC33XX 5200mAh PowerPrecision+ high capacity battery
- MC33XX 2740mAh PowerPrecision+ standard capacity battery (MC3300x-R/S & MC33XX-R/S only)

Compatible with the following batteries (charging in a spare battery slot only):

- MC3300x 7000mAh PowerPrecision+ extended capacity battery
- MC33XX 5200mAh PowerPrecision+ high capacity battery
- MC33XX 2740mAh PowerPrecision+ standard capacity battery
- MC32N0 5200mAh PowerPrecision high capacity battery
- MC32N0 2740mAh PowerPrecision standard capacity battery

**Figure 27** 1-Slot USB Charge Cradle

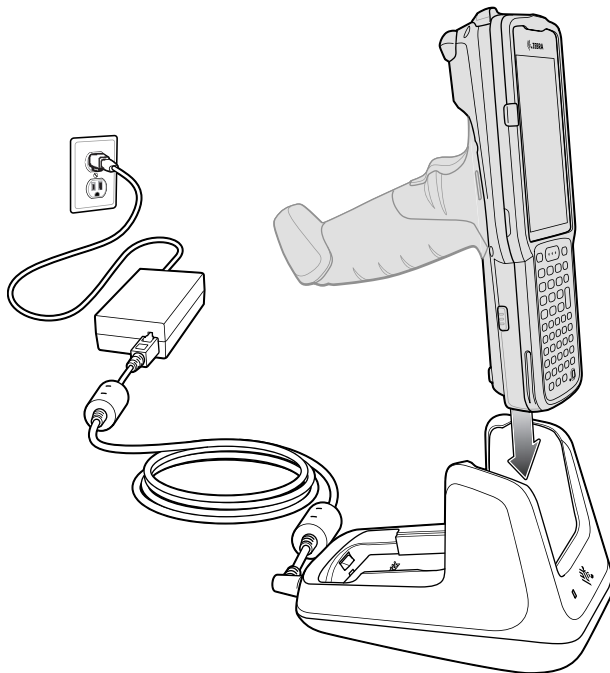

## Setup

**Figure 28** 1-Slot USB Charge Cradle Setup

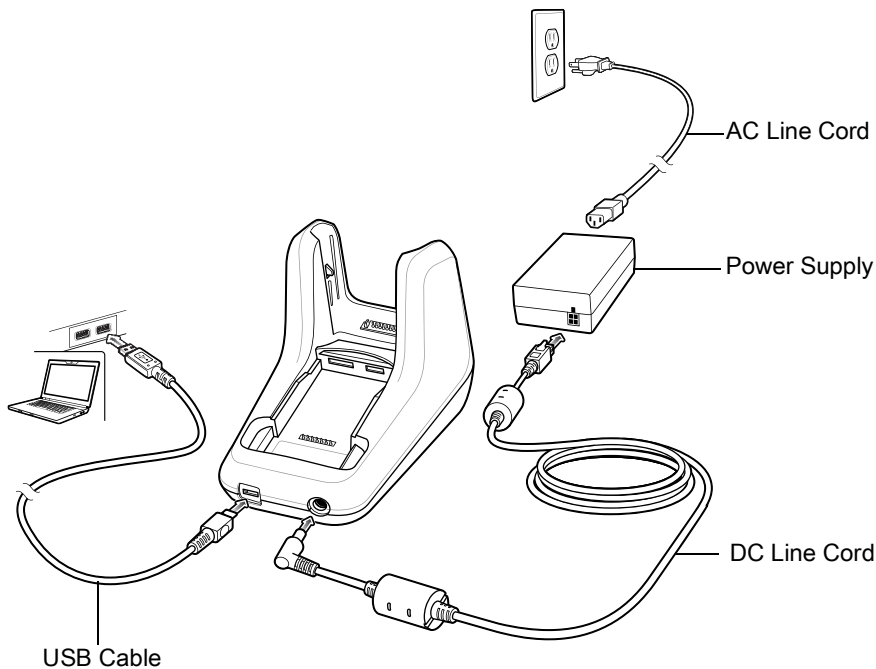

## Charging the MC3300x Battery



**NOTE:** To function properly, remove the entire rubber boot from the device before placing the device in a charging cradle. To function properly, ensure that the MC3300x hand strap, if attached, does not interfere with the charging contacts when the MC3300x is inserted into a charging cradle or cable.

1. Ensure that the cradle is connected to power.
2. Slide the mobile computer into the slot in the cradle. The mobile computer Charge LED Indicator, indicates the mobile computer battery charging status.
3. Gently press down on the device to ensure proper contact.
4. When charging is complete, remove the mobile computer from the cradle slot.

## Charging an MC3300x Spare Battery

1. Ensure that the cradle is connected to power.
2. Insert the spare battery into the cradle, bottom first, and pivot the top of the battery down onto the contact pins.

**Figure 29** MC3300x Spare Battery Charging

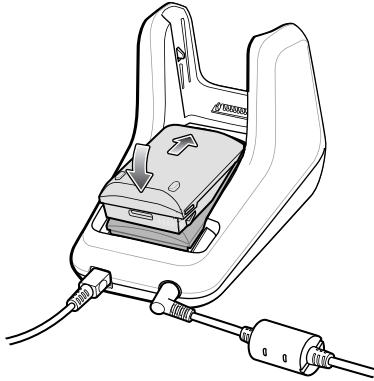

3. Gently press down on the battery to ensure proper contact.

The Spare Battery Charging LED on the front of the cradle indicates the spare battery charging status.

4. When charging is complete, lift the battery out of the slot.

## **Battery Charging in 1- Slot USB Charge Cradle**

The 1-Slot USB charge cradle charges the MC3300x's main battery and a spare battery simultaneously.

The MC3300x's Charge LED indicates the status of the battery charging in the MC3300x.

## 5-Slot Charge Only ShareCradle



**CAUTION:** Ensure that you follow the guidelines for battery safety described in [Battery Safety Guidelines](#) on page 175.

The 5-Slot Charge Only ShareCradle:

- Provides 9 VDC power for operating the mobile computer and charging the battery.
- Simultaneously charges up to five mobile computers.

Compatible with the following batteries (charging in a device):

- MC3300x 7000mAh PowerPrecision+ extended capacity battery
- MC33XX 5200mAh PowerPrecision+ high capacity battery
- MC33XX 2740mAh PowerPrecision+ standard capacity battery (MC3300x-R/S & MC33XX-R/S only)

**Figure 30** 5-Slot Charge Only ShareCradle

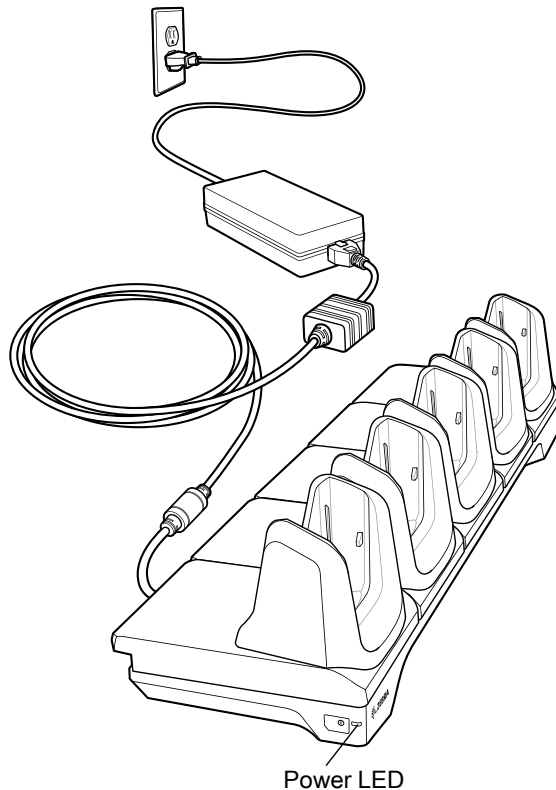

## Setup

**Figure 31** 5-Slot Charge Only ShareCradle Setup

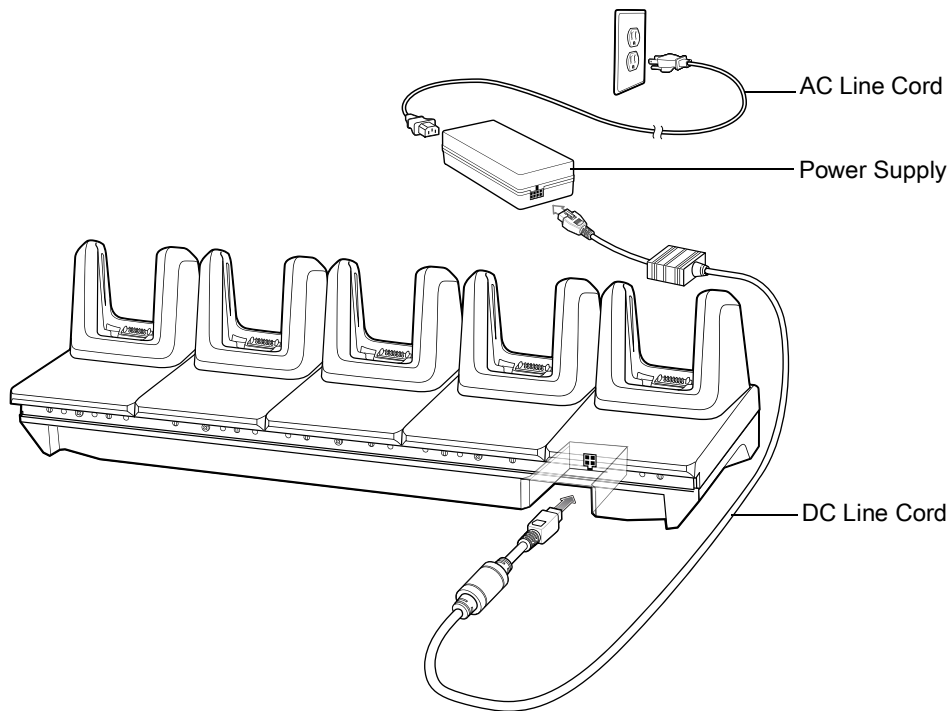

## Charging the MC3300x Battery



**NOTE:** To function properly, remove the entire rubber boot from the device before placing the device in a charging cradle. To function properly, ensure that the MC3300x hand strap, if attached, does not interfere with the charging contacts when the MC3300x is inserted into a charging cradle.

1. Ensure that the cradle is connected to power.
2. Slide the mobile computer into the slot in the cradle. The mobile computer Charge LED Indicator, indicates the mobile computer battery charging status.
3. Gently press down on the device to ensure proper contact.
4. When charging is complete, remove the mobile computer from the cradle slot.

## Battery Charging in the 5-Slot Charge Only ShareCradle

The MC3300x's Charge LED indicates the status of the battery charging in the MC3300x.

## 5-Slot Ethernet ShareCradle



**CAUTION:** Ensure that you follow the guidelines for battery safety described in [Battery Safety Guidelines on page 175](#).

The 5-Slot Ethernet ShareCradle:

- Provides 9 VDC power for operating the mobile computer and charging the battery.
- Simultaneously charges up to five mobile computers.
- Compatible with the following batteries (charging in a device):
  - MC3300x 7000mAh PowerPrecision+ extended capacity battery
  - MC33XX 5200mAh PowerPrecision+ high capacity battery
  - MC33XX 2740mAh PowerPrecision+ standard capacity battery (MC3300x-R/S & MC33XX-R/S only)

**Figure 32** 5-Slot Ethernet ShareCradle

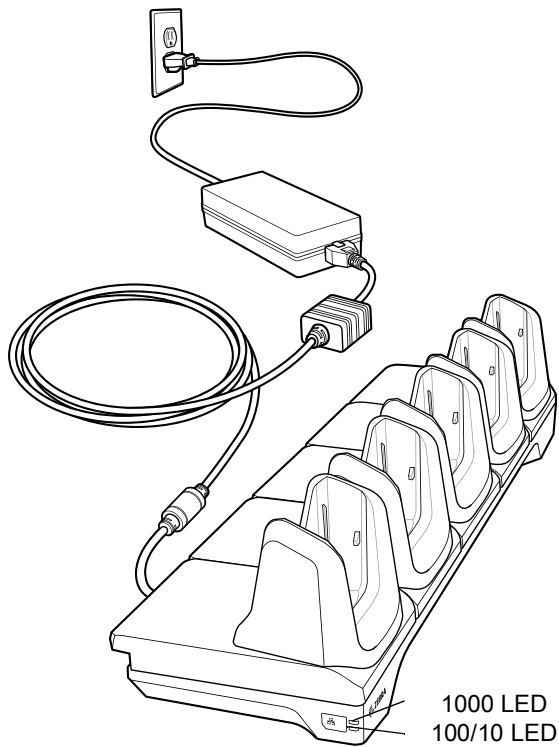

## Setup

Figure 33 5-Slot Ethernet ShareCradle Setup

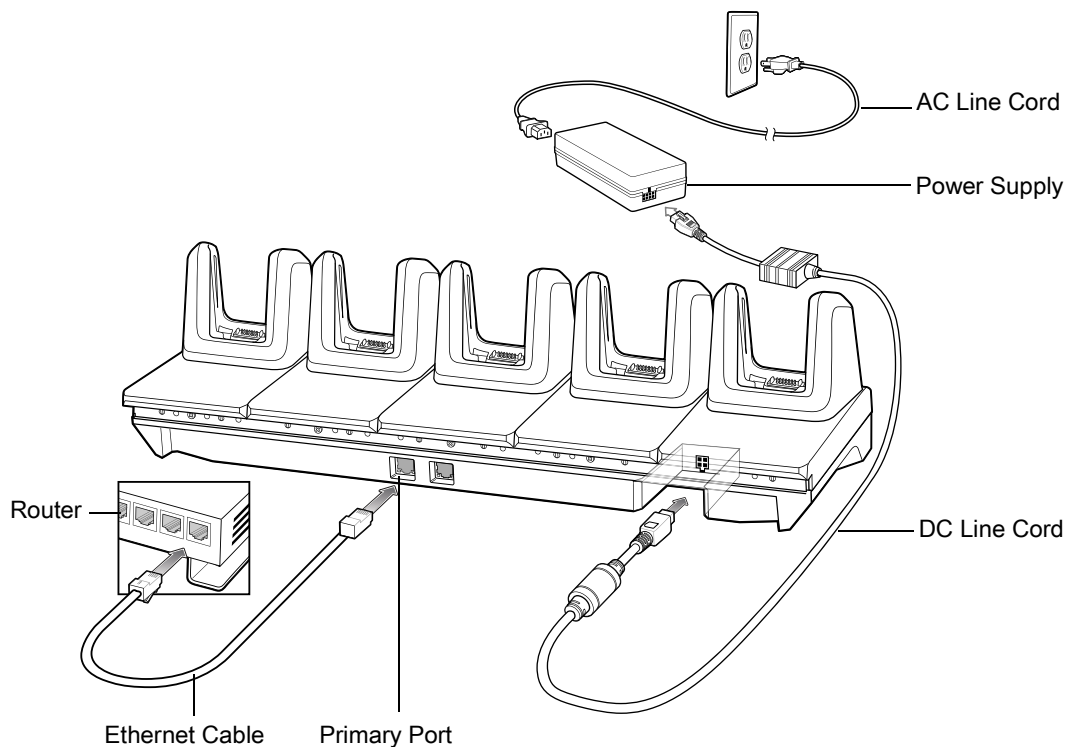

## Charging the MC3300x Battery



**NOTE:** To function properly, remove the entire rubber boot from the device before placing the device in a charging cradle. To function properly, ensure that the MC3300x hand strap, if attached, does not interfere with the charging contacts when the MC3300x is inserted into a charging cradle.

1. Ensure that the cradle is connected to power.
2. Slide the mobile computer into the slot in the cradle. The mobile computer amber Charge LED Indicator, indicates the mobile computer battery charging status.
3. Gently press down on the device to ensure proper contact.
4. When charging is complete, remove the mobile computer from the cradle slot.

## Battery Charging in the 5-Slot Ethernet ShareCradle

The MC3300x's Charge LED indicates the status of the battery charging in the MC3300x.

## Daisy-chaining Ethernet ShareCradles

Daisy-chain up to ten 5-Slot Ethernet ShareCradles to connect several cradles to an Ethernet network. Use either a straight or crossover cable. Daisy-chaining should not be attempted when the main Ethernet connection to the first cradle is 10 Mbps as throughput issues will almost certainly result.

To daisy-chain 5-Slot Ethernet ShareCradles:

1. Connect power to each 5-Slot Ethernet ShareCradle.

2. Connect an Ethernet cable to one of the ports on the switch and the other end to the Primary Port of the first cradle.
3. Connect an Ethernet cable to the Secondary port of the first cradle.
4. Connect the other end of the Ethernet cable to the Primary port of the next 5-Slot Ethernet ShareCradle.

**Figure 34** Daisy-chaining 5-Slot Ethernet ShareCradles

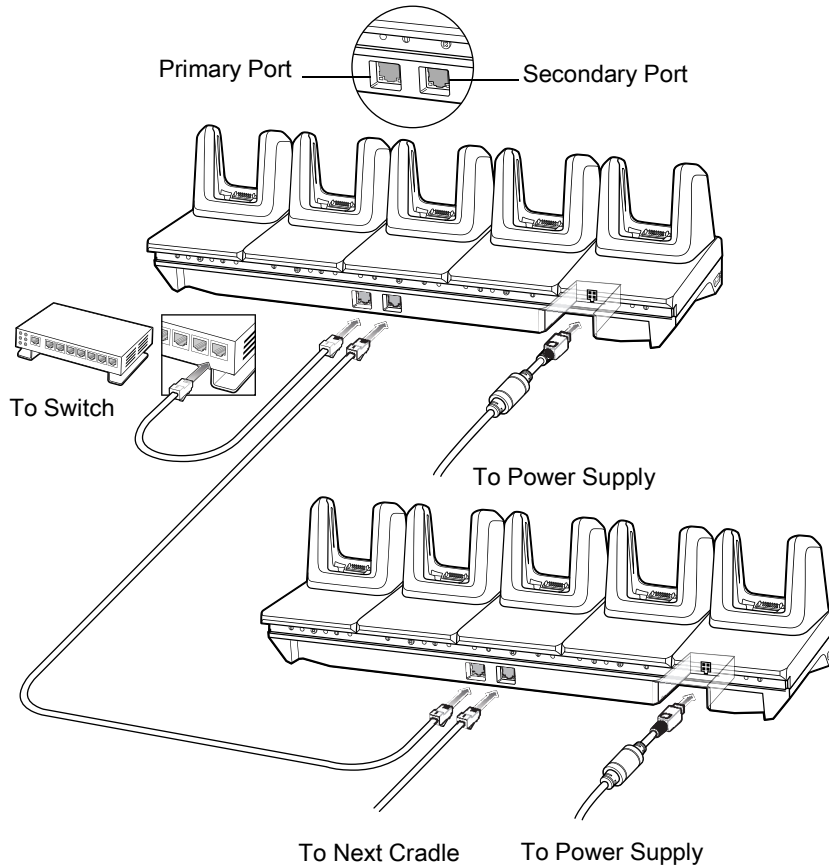

5. Connect additional cradles as described in step 3 and 4.



## Ethernet Settings

The following settings can be configured when using Ethernet communication:

- Proxy Settings
- Static IP.

## Configuring Ethernet Proxy Settings

The MC33XX includes Ethernet cradle drivers. After inserting the MC33XX, configure the Ethernet connection:

1. Swipe down from the status bar to open the quick access panel and then touch .
2. Touch  **Ethernet**.
3. Slide the switch to the **ON** position.



4. Place the MC33XX into the Ethernet cradle slot.
5. Touch and hold **eth0** until the menu appears.
6. Touch **Modify Proxy**.
7. Touch the **Proxy** drop-down list and select **Manual**.

**Figure 35** Ethernet Proxy Settings

eth0

Proxy  
Manual

Proxy hostname  
proxy.example.com

Proxy port  
8080

Bypass proxy for  
example.com,mycomp.test.com,lc

CANCEL MODIFY

8. In the **Proxy hostname** field, enter the proxy server address.
9. In the **Proxy port** field, enter the proxy server port number.



**NOTE:** When entering proxy addresses in the Bypass proxy for field, do not use spaces or carriage returns between addresses.

10. In the **Bypass proxy for** text box, enter addresses for web sites that do not require to go through the proxy server. Use the separator “|” between addresses.
11. Touch **MODIFY**.
12. Touch

## Configuring Ethernet Static IP Address

The MC33XX includes Ethernet cradle drivers. After inserting the MC33XX, configure the Ethernet connection:

1. Swipe down from the status bar to open the quick access panel and then touch
2. Touch **Ethernet**.
3. Slide the switch to the **ON** position.
4. Place the MC33XX into the Ethernet cradle slot.
5. Touch **eth0**.
6. Touch **Disconnect**.
7. Touch **eth0**.
8. Touch the IP settings drop-down list and select **Static**.

 eth0

Proxy  
None

IP settings  
Static

IP address  
192.168.1.128

Gateway  
192.168.1.1

Netmask  
255.255.255.0



DNS 1  
8.8.8.8

DNS 2  
10.61.1.249

CANCEL DISCONNECT

9. In the **IP** address field, enter the proxy server address.
10. If required, in the **Gateway** field, enter a gateway address for the device.
11. If required, in the **Netmask** field, enter the network mask address
12. If required, in the **DNS** address fields, enter a Domain Name System (DNS) addresses.
13. Touch **CONNECT**.
14. Touch .

## Establishing Ethernet Connection

1. Swipe down from the status bar to open the quick access panel and then touch .
2. Touch **Ethernet**.
3. Slide the Ethernet switch to the **ON** position.
4. Insert the device into a slot.  
The  icon appears in the Status bar.
5. Touch **eth0** to view Ethernet connection details.

## LED Indicators

There are two green LEDs on the side of the cradle. These green LEDs light and blink to indicate the data transfer rate.

**Table 12** LED Data Rate Indicators

Data Rate	1000 LED	100/10 LED
1 Gbps	On/Blink	Off
100 Mbps	Off	On/Blink
10 Mbps	Off	On/Blink

## 5-Slot ShareCradle with 4-Slot Battery Charger



**CAUTION:** Ensure that you follow the guidelines for battery safety described in [Battery Safety Guidelines on page 175](#).

The 5-Slot ShareCradle with 4-Slot Battery Charger:

- Provides 9 VDC power for operating the mobile computer and charging the battery.
- Provides 4.2 VDC power for charging spare batteries.
- Simultaneously charges up to four mobile computers and four spare batteries.

Compatible with the following batteries (charging in a device):

- MC3300x 7000mAh PowerPrecision+ extended capacity battery
- MC33XX 5200mAh PowerPrecision+ high capacity battery
- MC33XX 2740mAh PowerPrecision+ standard capacity battery (MC3300x-R/S & MC33XX-R/S only)

Compatible with the following batteries (charging in a spare battery slot only):

- MC3300x 7000mAh PowerPrecision+ extended capacity battery
- MC33XX 5200mAh PowerPrecision+ high capacity battery
- MC33XX 2740mAh PowerPrecision+ standard capacity battery
- MC32N0 5200mAh PowerPrecision high capacity battery
- MC32N0 2740mAh PowerPrecision standard capacity battery

**Figure 36** 5-Slot ShareCradle with 4-Slot Battery Charger

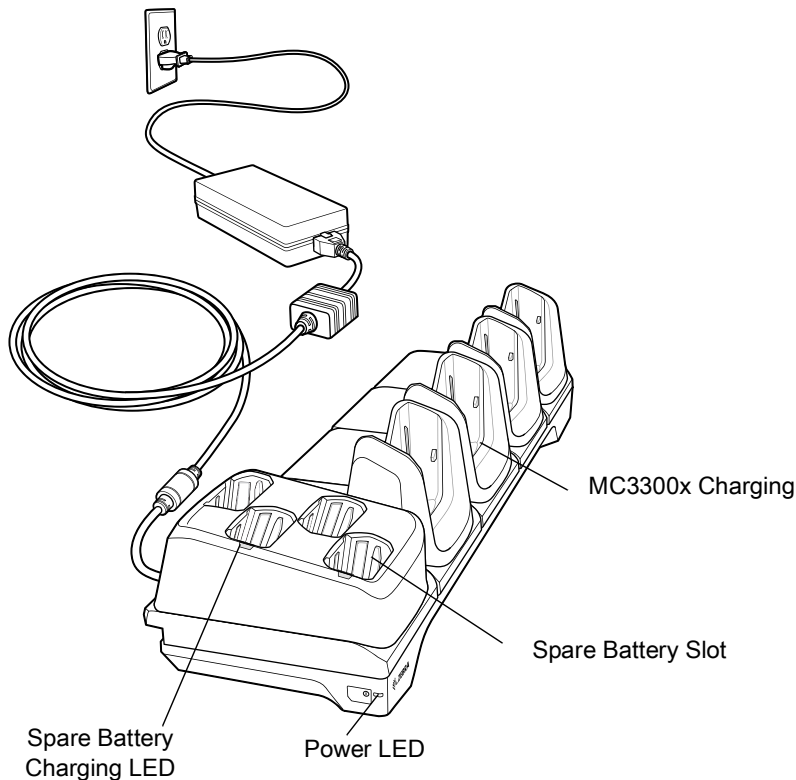

## Setup

**Figure 37** 5-Slot ShareCradle with 4-Slot Battery Charger Setup

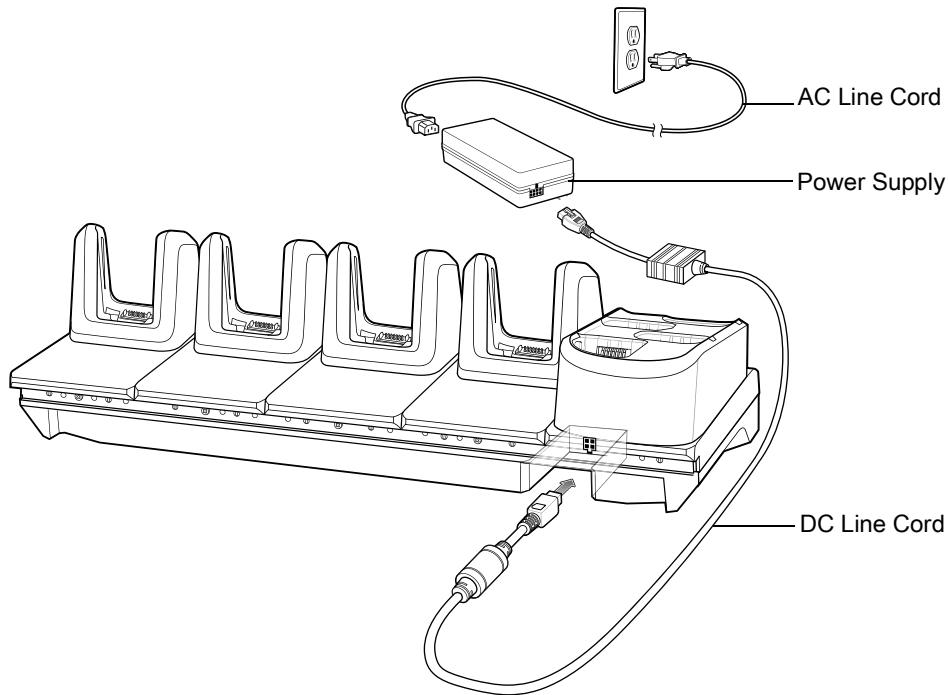

## Charging the MC3300x Battery



**NOTE:** To function properly, remove the entire rubber boot from the device before placing the device in a charging cradle. To function properly, ensure that the MC3300x hand strap, if attached, does not interfere with the charging contacts when the MC3300x is inserted into a charging cradle.

1. Ensure that the cradle is connected to power.
2. Slide the mobile computer into the slot in the cradle. The mobile computer amber Charge LED Indicator, indicates the mobile computer battery charging status.
3. Gently press down on the device to ensure proper contact.
4. When charging is complete, remove the mobile computer from the cradle slot.

## Charging Spare Batteries

Insert the battery into the charger and gently press down on the battery to ensure proper contact.

## Battery Charging in the 5-Slot ShareCradle with 4-Slot Battery Charger

The MC3300x's Charge LED or the spare battery LED indicates the status of the battery charging in the MC3300x.

## 5-Slot Ethernet ShareCradle with 4-Slot Battery Charger



**CAUTION:** Ensure that you follow the guidelines for battery safety described in [Battery Safety Guidelines on page 175](#).

The 5-Slot Ethernet ShareCradle with 4-Slot Battery Charger:

- Provides 9 VDC power for operating the mobile computer and charging the battery.
- Provides 4.2 VDC power for charging spare batteries.
- Simultaneously charges up to four mobile computers and four spare batteries.

Compatible with the following batteries (charging in a device):

- MC3300x 7000mAh PowerPrecision+ extended capacity battery
- MC33XX 5200mAh PowerPrecision+ high capacity battery
- MC33XX 2740mAh PowerPrecision+ standard capacity battery (MC3300x-R/S & MC33XX-R/S only)

Compatible with the following batteries (charging in a spare battery slot only):

- MC3300x 7000mAh PowerPrecision+ extended capacity battery
- MC33XX 5200mAh PowerPrecision+ high capacity battery
- MC33XX 2740mAh PowerPrecision+ standard capacity battery
- MC32N0 5200mAh PowerPrecision high capacity battery
- MC32N0 2740mAh PowerPrecision standard capacity battery

**Figure 38** 5-Slot Ethernet ShareCradle with 4-Slot Battery Charger

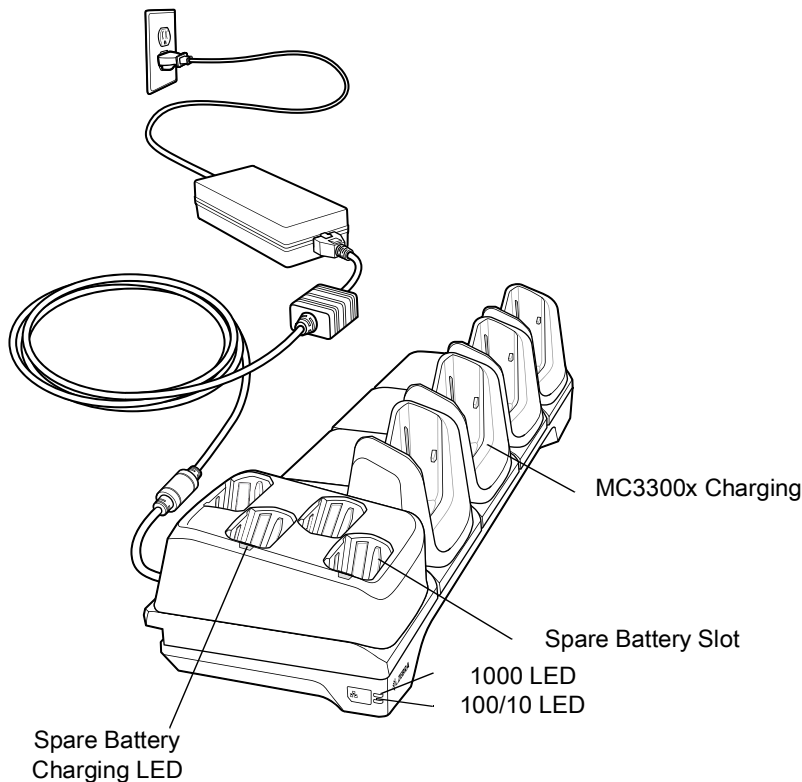

## Setup

**Figure 39** 5-Slot Ethernet ShareCradle with 4-Slot Battery Charger Setup

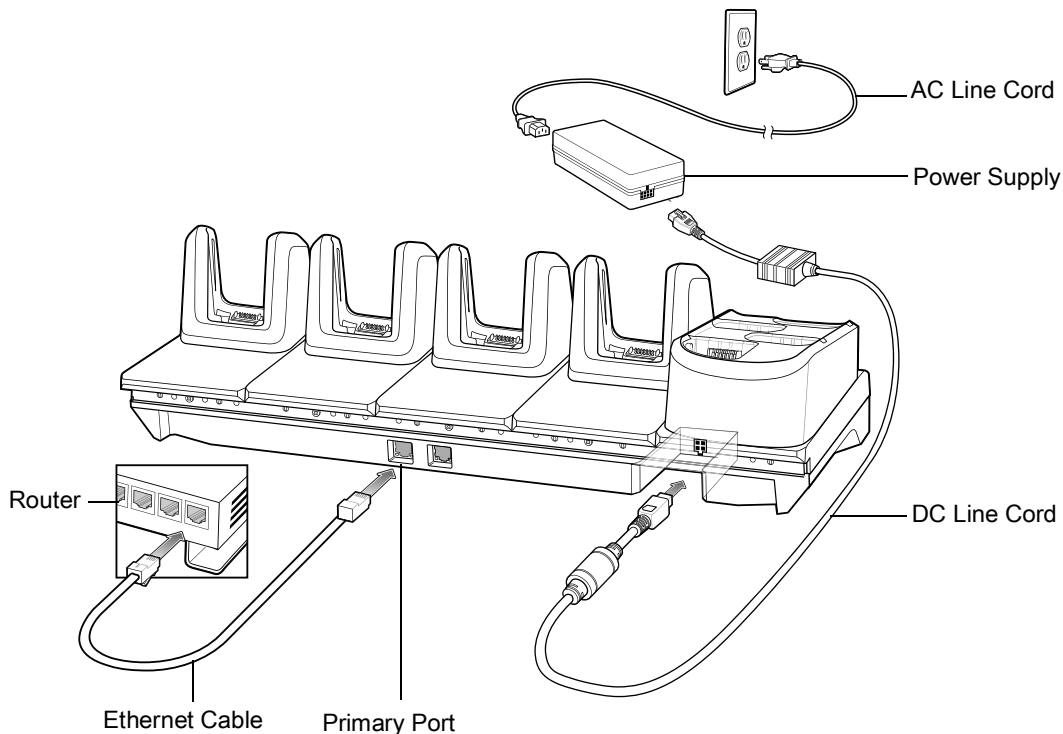

## Charging the MC3300x Battery



**NOTE:** To function properly, remove the entire rubber boot from the device before placing the device in a charging cradle. To function properly, ensure that the MC3300x hand strap, if attached, does not interfere with the charging contacts when the MC3300x is inserted into a charging cradle.

1. Ensure that the cradle is connected to power.
2. Slide the mobile computer into the slot in the cradle. The mobile computer amber Charge LED Indicator, indicates the mobile computer battery charging status.
3. Gently press down on the device to ensure proper contact.
4. When charging is complete, remove the mobile computer from the cradle slot.

## Charging Spare Batteries

Insert the battery into the charger and gently press down on the battery to ensure proper contact.

## Battery Charging in the 5-Slot Ethernet ShareCradle with 4-Slot Battery Charger

The MC3300x's Charge LED or the spare battery LED indicates the status of the battery charging in the MC3300x.

## Daisy-chaining Ethernet Cradles

Daisy-chain up to ten 5-Slot Ethernet ShareCradle with 4-Slot Battery Chargers to connect several cradles to an Ethernet network. Use either a straight or crossover cable. Daisy-chaining should not be attempted when the main Ethernet connection to the first cradle is 10 Mbps as throughput issues will almost certainly result.

To daisy-chain 5-Slot Ethernet ShareCradle with 4-Slot Battery Chargers:

1. Connect power to each 5-Slot Ethernet ShareCradle with 4-Slot Battery Charger.
2. Connect an Ethernet cable to one of the ports on the switch and the other end to the Primary Port of the first cradle.
3. Connect an Ethernet cable to the Secondary port of the first cradle.
4. Connect the other end of the Ethernet cable to the Primary port of the next 5-Slot Ethernet ShareCradle with 4-Slot Battery Charger.

**Figure 40** Daisy-chaining 5-Slot Ethernet ShareCradle with 4-Slot Battery Chargers

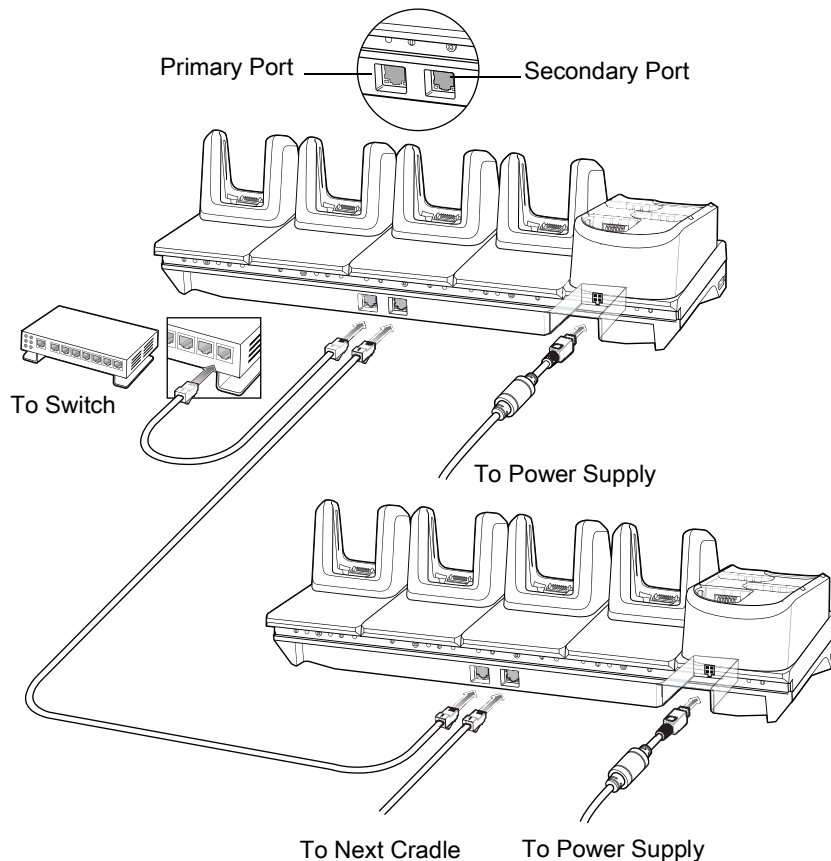

5. Connect additional cradles as described in step 3 and 4.

## Ethernet Settings



The following settings can be configured when using Ethernet communication:

- Proxy Settings
- Static IP.



## Configuring Ethernet Proxy Settings

The MC33XX includes Ethernet cradle drivers. After inserting the MC33XX, configure the Ethernet connection:

1. Swipe down from the status bar to open the quick access panel and then touch .
2. Touch  **Ethernet**.
3. Slide the switch to the **ON** position.
4. Place the MC33XX into the Ethernet cradle slot.
5. Touch and hold **eth0** until the menu appears.
6. Touch **Modify Proxy**.
7. Touch the **Proxy** drop-down list and select **Manual**.

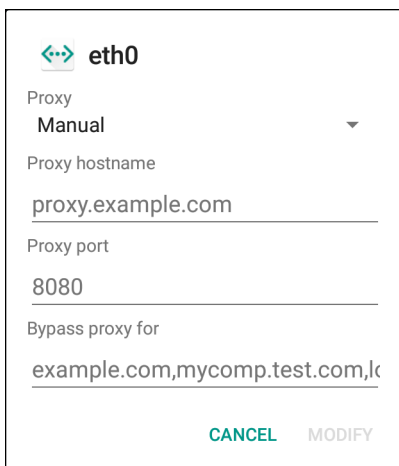

 eth0

Proxy  
Manual

Proxy hostname  
proxy.example.com

Proxy port  
8080

Bypass proxy for  
example.com,mycomp.test.com,lc

CANCEL MODIFY

8. In the **Proxy hostname** field, enter the proxy server address.
9. In the **Proxy port** field, enter the proxy server port number.





**NOTE:** When entering proxy addresses in the Bypass proxy for field, do not use spaces or carriage returns between addresses.

10. In the **Bypass proxy for** text box, enter addresses for web sites that do not require to go through the proxy server. Use the separator “|” between addresses.
11. Touch **MODIFY**.
12. Touch .

## Configuring Ethernet Static IP Address

The MC33XX includes Ethernet cradle drivers. After inserting the MC33XX, configure the Ethernet connection:

1. Swipe down from the status bar to open the quick access panel and then touch .
2. Touch  **Ethernet**.
3. Slide the switch to the **ON** position.
4. Place the MC33XX into the Ethernet cradle slot.
5. Touch **eth0**.

6. Touch **Disconnect**.
7. Touch **eth0**.
8. Touch the IP settings drop-down list and select **Static**.

eth0

Proxy  
None

IP settings  
Static

IP address  
192.168.1.128

Gateway  
192.168.1.1

Netmask  
255.255.255.0



DNS 1  
8.8.8.8

DNS 2  
10.61.1.249

CANCEL DISCONNECT

9. In the **IP** address field, enter the proxy server address.
10. If required, in the **Gateway** field, enter a gateway address for the device.
11. If required, in the **Netmask** field, enter the network mask address
12. If required, in the **DNS** address fields, enter a Domain Name System (DNS) addresses.
13. Touch **CONNECT**.
14. Touch .

## Establishing Ethernet Connection

1. Swipe down from the status bar to open the quick access panel and then touch .
2. Touch **Ethernet**.
3. Slide the Ethernet switch to the **ON** position.
4. Insert the device into a slot.  
The  icon appears in the Status bar.
5. Touch **eth0** to view Ethernet connection details.

## LED Indicators

There are two green LEDs on the side of the cradle. These green LEDs light and blink to indicate the data transfer rate.

**Table 13** LED Data Rate Indicators

Data Rate	1000 LED	100/10 LED
1 Gbps	On/Blink	Off
100 Mbps	Off	On/Blink
10 Mbps	Off	On/Blink

## 4-Slot Spare Battery Charger



**CAUTION:** Ensure that you follow the guidelines for battery safety described in [Battery Safety Guidelines](#) on page 175.

The 4-Slot Battery Charger:

- Charges up to four MC3300x spare batteries.
- Provides 4.2 VDC power to charge the spare battery.

Compatible with the following batteries (charging in a spare battery slot only):

- MC3300x 7000mAh PowerPrecision+ extended capacity battery
- MC33XX 5200mAh PowerPrecision+ high capacity battery
- MC33XX 2740mAh PowerPrecision+ standard capacity battery
- MC32N0 5200mAh PowerPrecision high capacity battery
- MC32N0 2740mAh PowerPrecision standard capacity battery

### Setup

**Figure 41** 4-Slot Battery Charger Setup

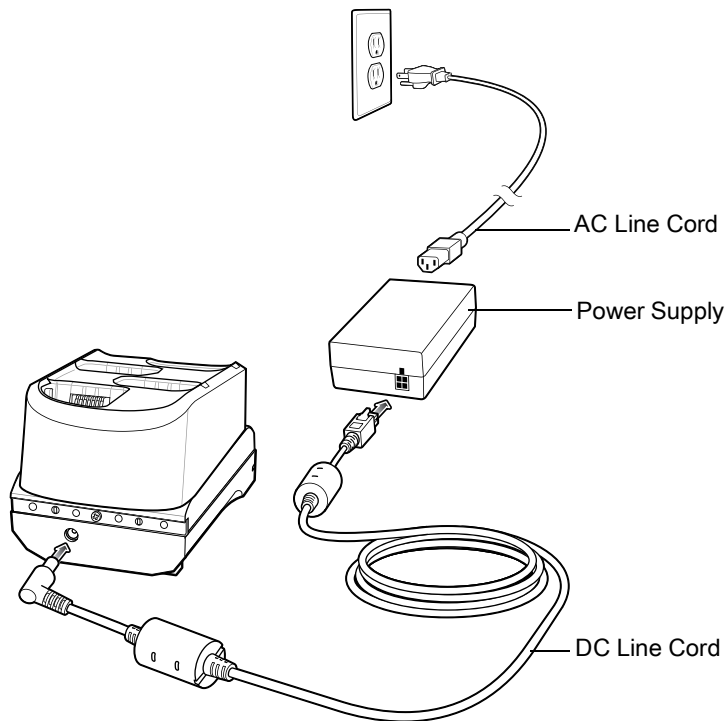

### Charging Spare Batteries

1. Connect the charger to a power source.
2. Insert the battery into the charger and gently press down on the battery to ensure proper contact.

**Figure 42** 4-Slot Battery Charger

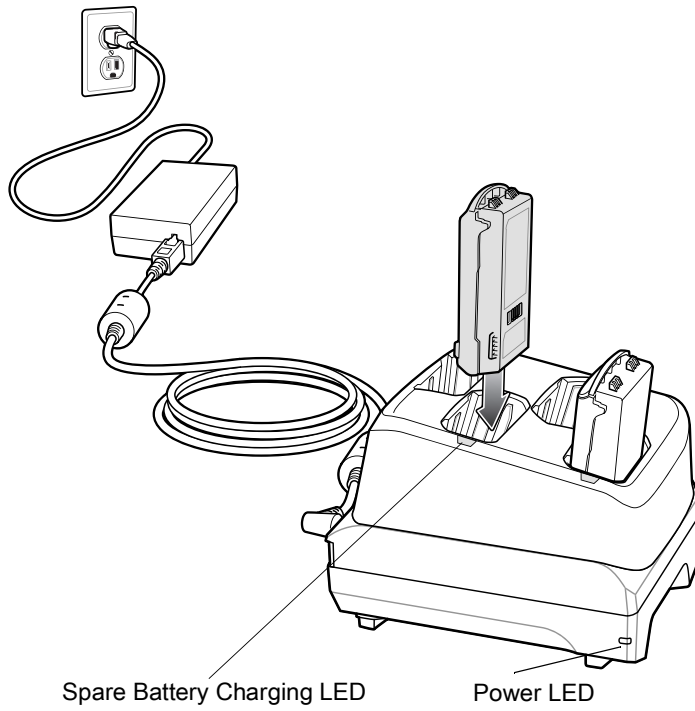

## 20-Slot Spare Battery Charger



**CAUTION:** Ensure that you follow the guidelines for battery safety described in [Battery Safety Guidelines](#) on page 175.

The 20-Slot Battery Charger:

- Charges up to twenty MC3300x spare batteries.
- Provides 4.2 VDC power to charge the spare battery.

Compatible with the following batteries (charging in a spare battery slot only):

- MC3300x 7000mAh PowerPrecision+ extended capacity battery
- MC33XX 5200mAh PowerPrecision+ high capacity battery
- MC33XX 2740mAh PowerPrecision+ standard capacity battery
- MC32N0 5200mAh PowerPrecision high capacity battery
- MC32N0 2740mAh PowerPrecision standard capacity battery

### Setup

**Figure 43** 20-Slot Battery Charger Setup

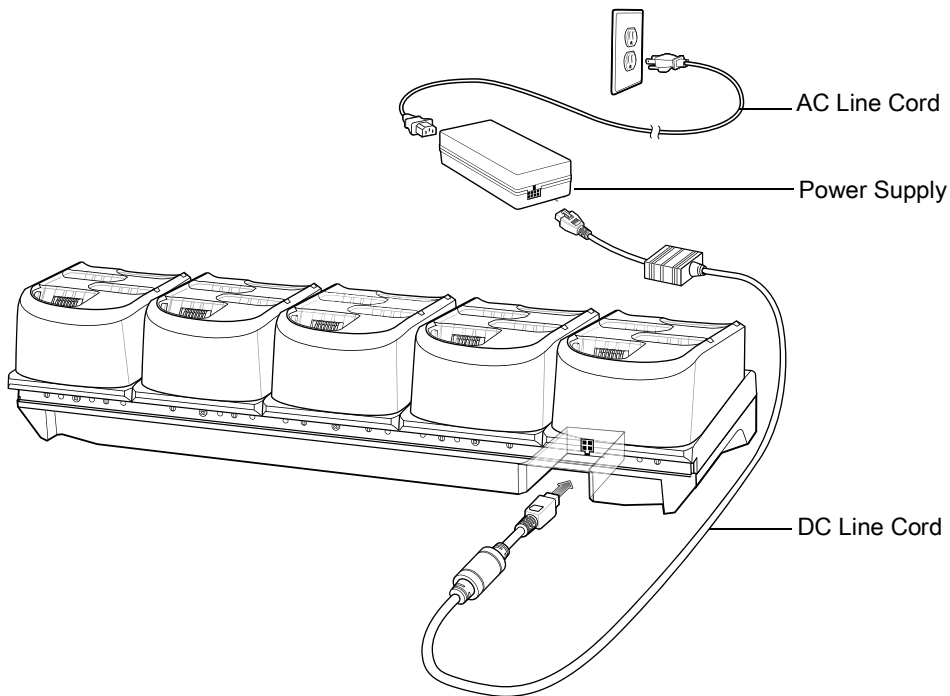

### Charging Spare Batteries

1. Connect the charger to a power source.
2. Insert the battery into the charger and gently press down on the battery to ensure proper contact.

**Figure 44** 20-Slot Battery Charger

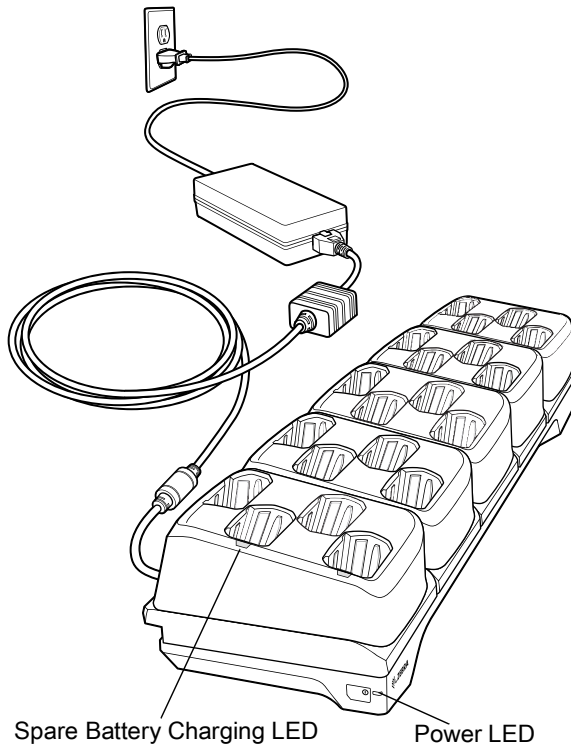

## USB Charge Cable

The USB Charge Cable:

- Provides 5 VDC power to charge the battery.
- Provides power and/or communication with the host computer over USB to the device.
  - Compatible with devices using the following batteries:
    - MC3300x 7000 mAh PowerPrecision+ extended capacity battery
    - MC33XX 5200 mAh PowerPrecision+ high capacity battery
    - MC33XX 2740 mAh PowerPrecision+ standard capacity battery (MC3300x-R/S & MC33XX-R/S only)

The USB Charge Cable snaps onto the bottom of the MC3300x and removes easily when not in use. When attached to the MC3300x allows charging only.

**Figure 45** USB Charge Cable

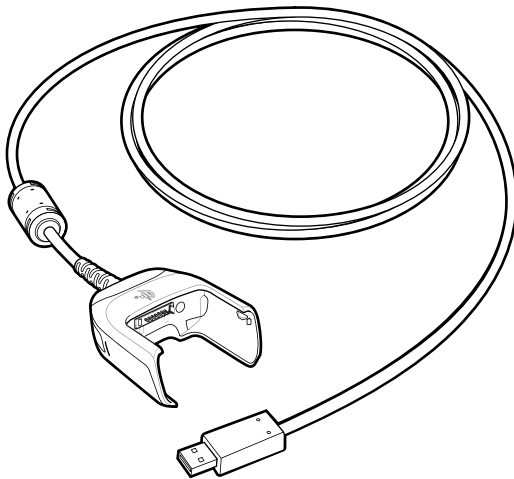

### Connecting the USB Charge Cable to Device



**NOTE:** To function properly, remove the entire rubber boot from the device before placing the device in a charging cradle. To function properly, ensure that the MC3300x hand strap, if attached, does not interfere with the charging contacts when the MC3300x is inserted into a charging cradle or cable.

To connect the USB Charge Cable to the device, insert the USB Charge Cable straight onto the device until the device touches the bottom of the cable cup.



**Figure 46** Connecting the USB Charge Cable

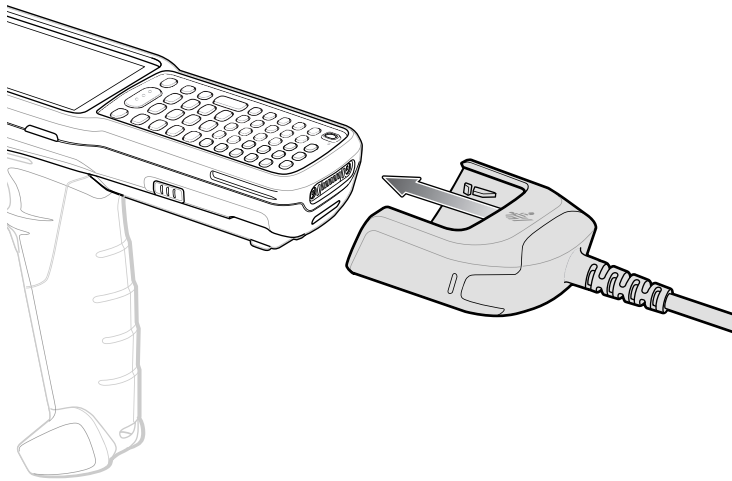

## Connecting the USB Charge Cable to Host Computer

To connect the USB Charge Cable to a host computer:

1. Connect the USB Charge Cable to the MC3300x.
2. Connect the USB connector of the cable to a host computer.

**Figure 47** Connecting USB Charge Cable to Host Computer

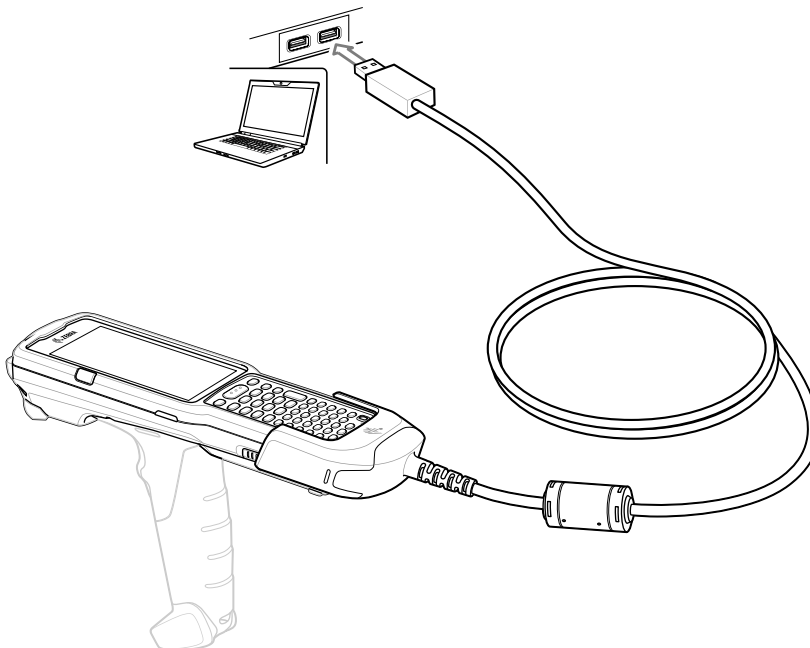

## Main Battery Charging

The device's Charging/Notification LED indicates the status of the battery charging in the device.



**NOTE:** Charging using a host computer USB port could take longer.

To achieve the best charging results use only Zebra charging accessories and batteries. Charge batteries at room temperature with the MC3300x in sleep mode.

### Charging the Device

To charge the device using the USB Charge Cable:

1. Connect the USB Charge Cable to the MC3300x.
2. Connect the USB connector of the power supply.
3. Plug the power supply into a power outlet.

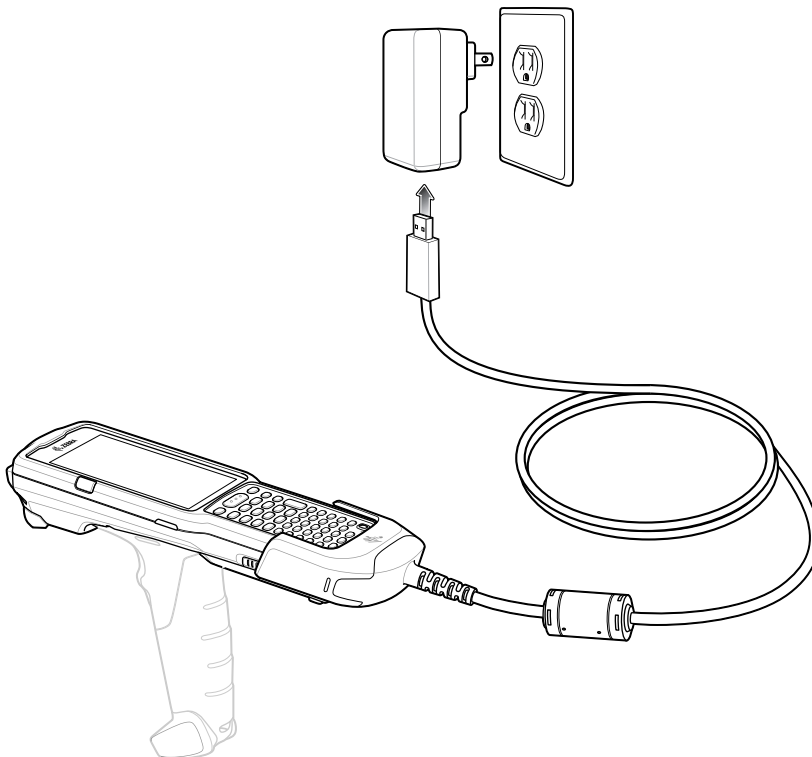

### Main Battery Charging

The device's Charging/Notification LED indicates the status of the battery charging in the device.



**NOTE:** In many cases the 90% charge provides plenty of charge for daily use.

To achieve the best charging results use only Zebra charging accessories and batteries. Charge batteries at room temperature with the MC3300x in sleep mode.

The MC3300x 7000 mAh PowerPrecision+ extended battery charges from 0% to 90% in less than 5 hours at room temperature.

### Disconnecting the USB Charge Cable

To disconnect the USB Charge Cable from the MC3300x:

1. Grasp the cable cup in one hand (by pinching the front and back) and the device in the other hand.

2. Remove the device by pulling straight up.

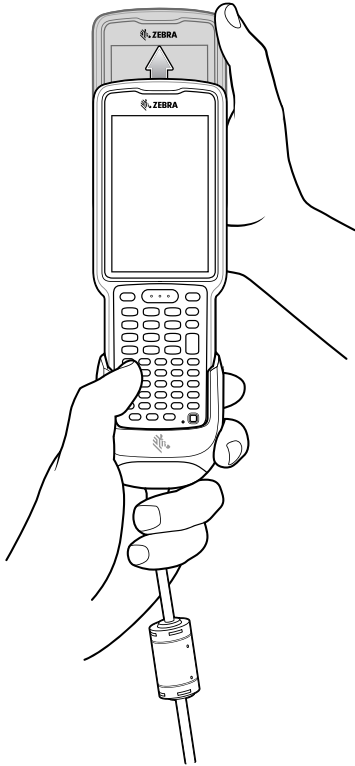

## MC33XX Charge Only Adapter

Use the MC33XX Charge Only Adapter for backwards compatibility with the MC32N0 cradles and the MC33XX or MC3300x mobile computer. The MC33XX Charge Only Adapter is compatible with both the MC33XX and the MC3300x mobile computers for charge only (no communication) on the legacy MC32N0 1-Slot and 4-Slot cradles.

- MC33XX Charge Only Adapter supports the MC32N0 1-Slot USB Cradle, MC32N0 4-Slot Charge Only Cradle, and MC32N0 4-Slot Ethernet Cradle.
- MC33XX Charge Only Adapter provides charge only; no communication when used with the MC32N0 cradles.
- MC32N0 1-Slot USB Cradle provides 5.4 VDC to charge the device.
- MC32N0 1-Slot USB Cradle (with the MC33XX Charge Only Adapter) is compatible with an MC33XX or MC3300x mobile computer charging either MC33XX or MC3300x PowerPrecision+ batteries or MC32N0 PowerPrecision batteries, but the MC32N0 1-Slot USB Cradle spare battery slot is only compatible with MC32N0 PowerPrecision batteries.

## MC33XX Charge Only Adapter Installation

To install the MC33XX Charge Only Adapter into the MC32N0 Cradle:

1. Clean the MC32N0 cradle and contacts with an alcohol wipe, using a back and forth motion with your finger. For more information about cleaning, see [Maintenance and Troubleshooting](#).

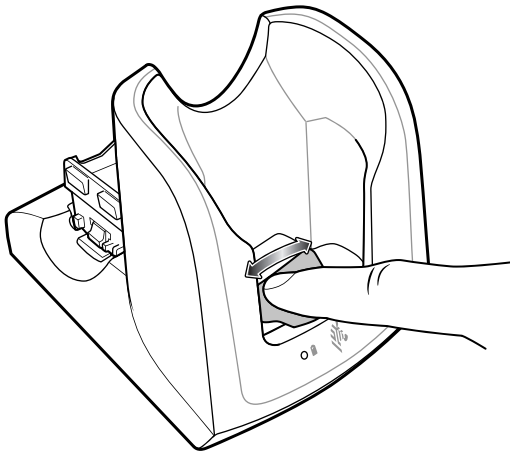

2. Peel and remove the adhesive from the back of the adapter.

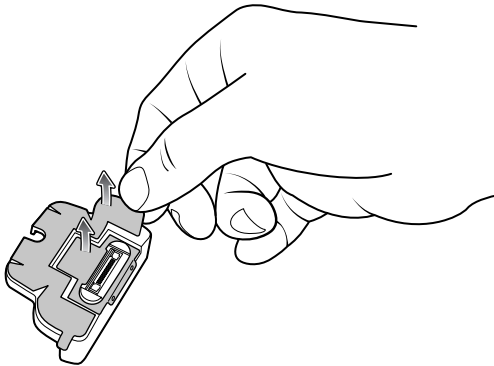

3. Insert the adapter into the MC32N0 cradle and adhere to the bottom of the cradle.

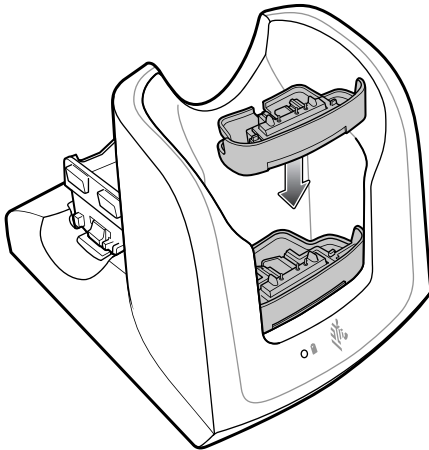

4. Insert the MC33XX or MC3300x mobile computer into the MC32N0 cradle.



**NOTE:** To function properly, ensure that the MC3300x hand strap, if attached, does not interfere with the charging contacts when the MC3300x is inserted into a charging cradle.

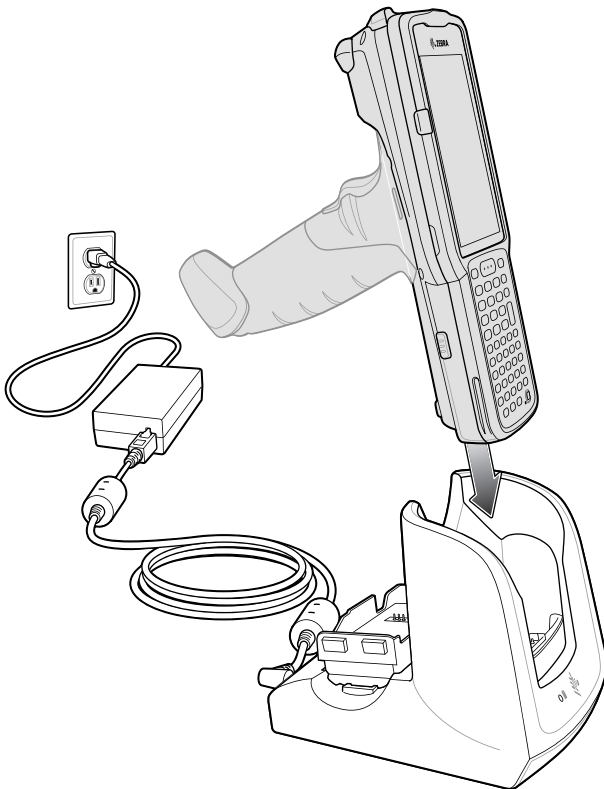

The MC3300x 7000 mAh PowerPrecision+ extended battery charges from 0% to 90% in less than 5.2 hours at room temperature.

## MC3300x-G Rubber Boot

The rubber boot provides additional protection to the MC3300x-G.

To attach the rubber boot:

1. Slide the top of the MC3300x-G into the top of the rubber boot.

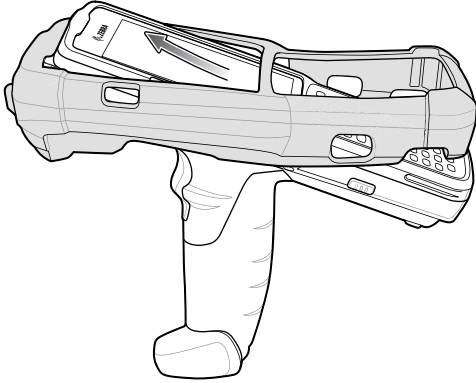

2. Grasp the bottom of the rubber boot and place over the bottom of the MC3300x-G.

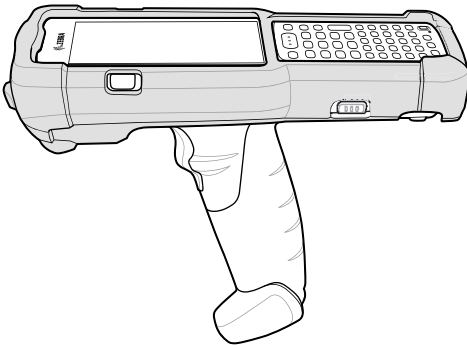

**NOTE:** To function properly, remove the entire rubber boot from the device before placing the device in a charging cradle or rigid holster.

## MC3300x-R Rubber Boot

The rubber boot provides additional protection to the MC3300x-R. The rubber boot is comprised of two pieces; one for the mobile computer and one for the turret cup.

To attach the rubber boot:

1. Insert the rubber boot for the turret cup into the rubber boot for the mobile computer, to form a single piece, if it is not already attached.

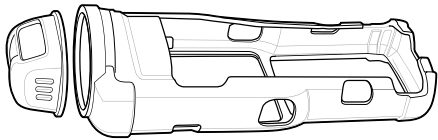

2. Slide the top of the MC3300x-R into the top of the rubber boot.

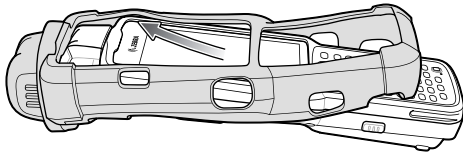

3. Grasp the bottom of the rubber boot and place over the bottom of the MC3300x-R.

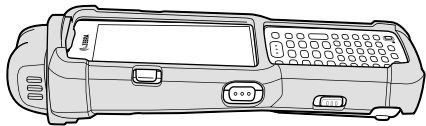

**NOTE:** To function properly, remove the entire rubber boot from the device before placing the device in a charging cradle or rigid holster.

## MC3300x-S Rubber Boot

The rubber boot provides additional protection to the MC3300x-S.

To attach the rubber boot:

1. Slide the bottom of the MC3300x-S into the bottom of the rubber boot.

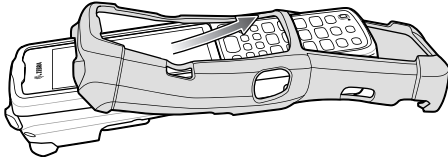

2. Grasp the top of the rubber boot and place over the top of the MC3300x-S.

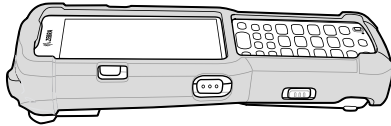

**NOTE:** To function properly, remove the entire rubber boot from the device before placing the device in a charging cradle or rigid holster.



## Rigid Holster

The Rigid Holster provides a holder for the MC3300x-R/S. It consists of a mobile computer holder and a detachable belt clip. Press the release button to remove the detachable belt clip.

**Figure 48** Plastic Holster

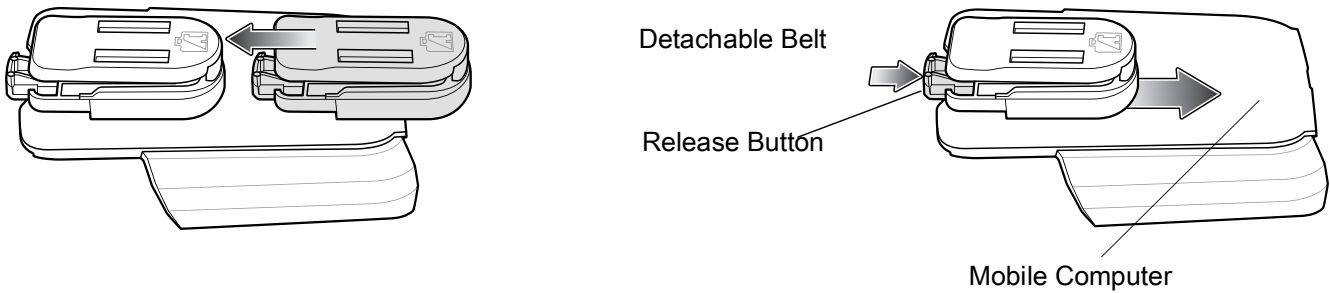

**Figure 49** Attaching the Rigid Holster

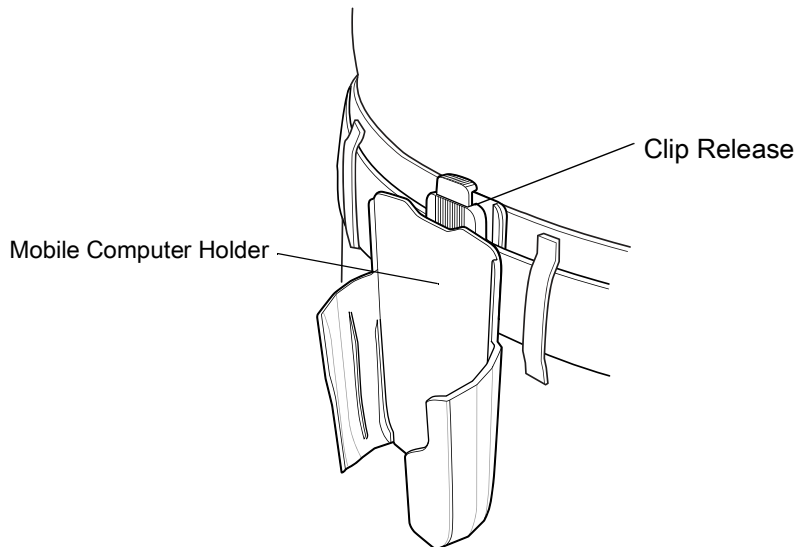

The Rigid Holster holds the mobile computer on a belt or waist band.

To insert the mobile computer, slide the mobile computer into the Rigid Holster with the screen facing the user.

To remove the mobile computer, press and lift to remove the mobile computer.

**Figure 50** Insert and Remove the Mobile Computer

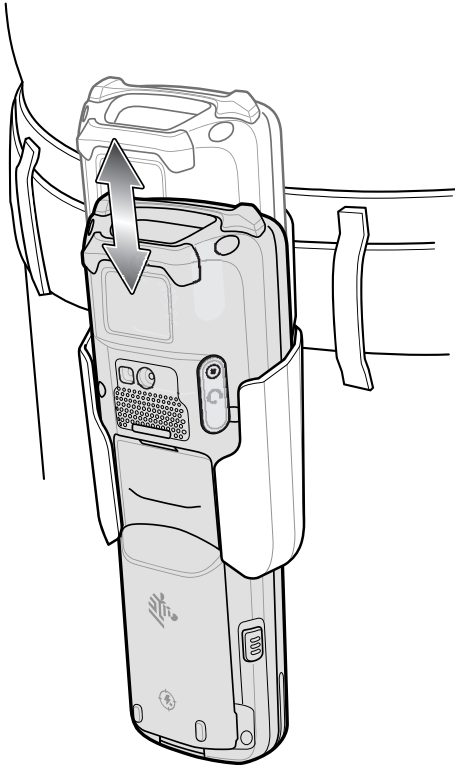

**NOTE:** To function properly, remove the entire rubber boot from the device before placing the device in a charging cradle or rigid holster.

## MC3300x-G Fabric Holster

The fabric holster provides a soft holder for the mobile computer. It consists of a fabric mobile computer holder, a detachable shoulder strap and a belt strap. See figures below to attach the fabric holster to a belt and shoulder strap.

### Belt Strap

Attach the fabric holster to a belt or waist band.

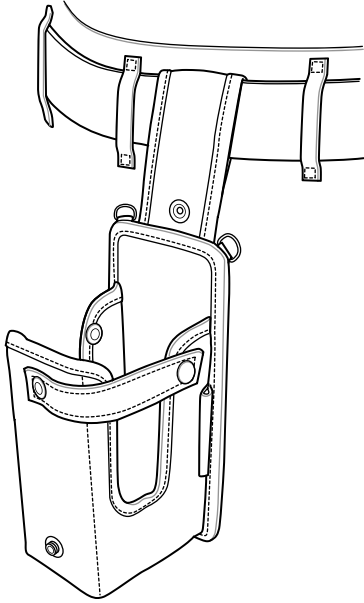

### Shoulder Strap

Attach the fabric holster to a shoulder strap.

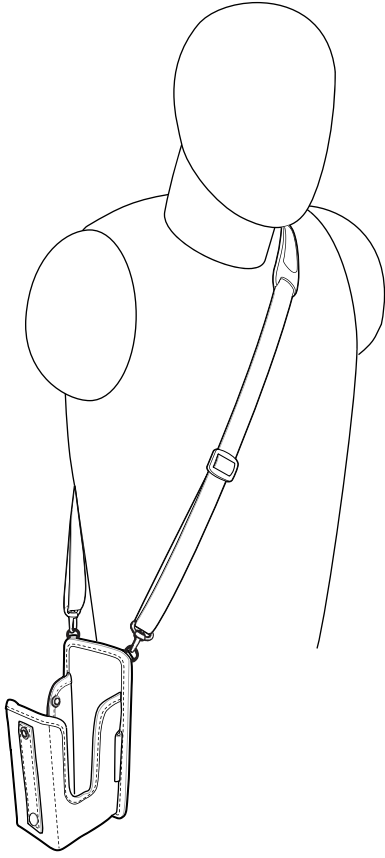

## Using the Belt Strap

The fabric holster holds the MC3300x-G on a belt or waist band.

1. Secure the belt strap over the belt or waistband and snap into place.

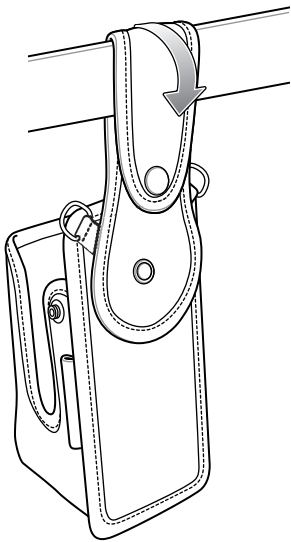

2. To insert the MC3300x-G, slide the mobile computer into the fabric holster with the screen facing the user.

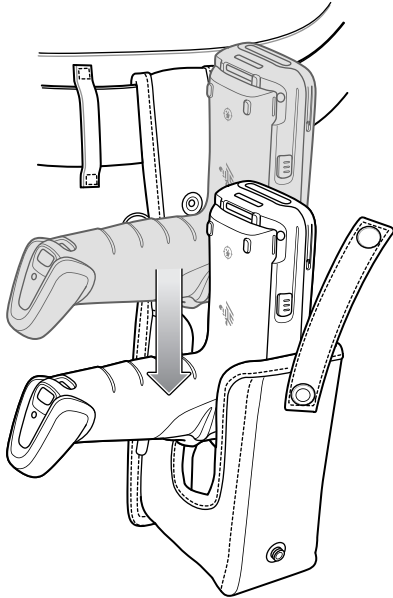

3. Secure the MC3300x-G with the restraining strap and place over the MC3300x-G to secure in place.

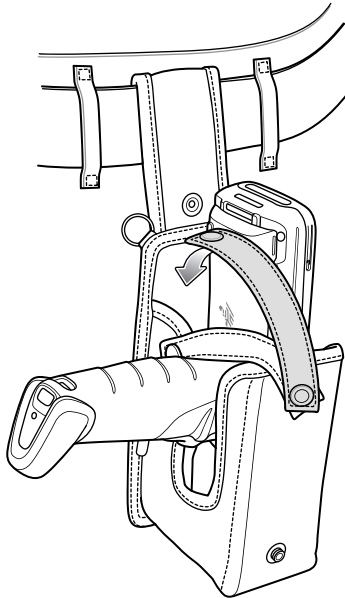

4. To remove the MC3300x-G, unsnap the restraining strap to release. Lift the MC3300x-G out of the fabric holster.

### Using the Shoulder Strap

1. Connect the clips on the shoulder strap to the rings on the fabric holster.

2. Place the shoulder strap over your head and rest on your shoulder.

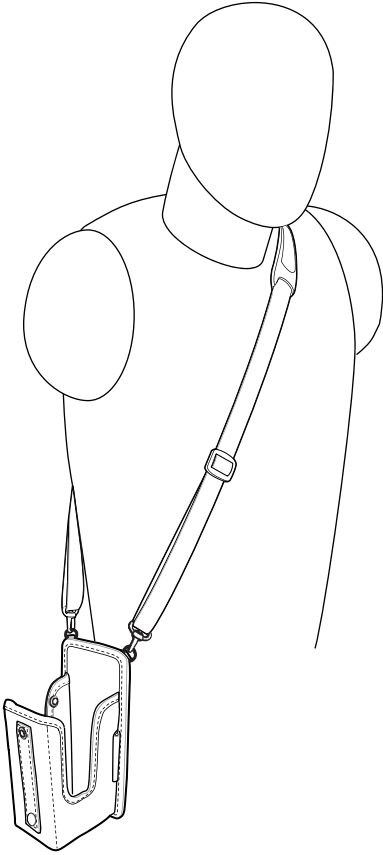

3. Lift the strap and insert the MC3300x-G into the holster.
4. Secure the strap to hold the MC3300x-G in place.

## MC3300x-R/S Fabric Holster

The fabric holster provides a soft holder for the mobile computer. It consists of a fabric mobile computer holder, a detachable shoulder strap and a belt clip. See figures below to attach the fabric holster to a belt and shoulder strap.

### Belt Clip

Attach the fabric holster to a belt or waist band.

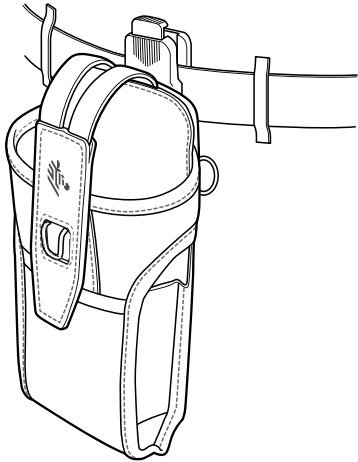

### Shoulder Strap

Attach the fabric holster to a shoulder strap.

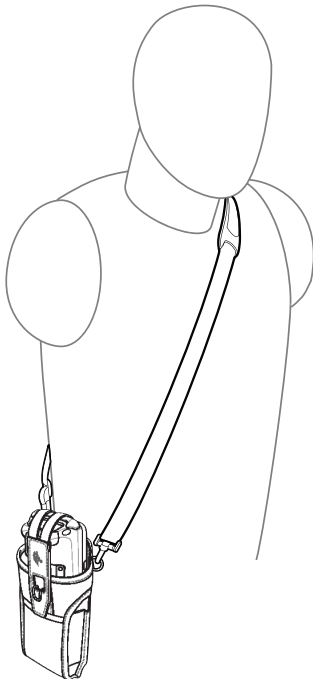

## Using the Belt Clip

The fabric holster holds the MC3300x-R/S on a belt or waist band.

1. Secure the belt clip on the fabric holster, if it is not already attached.

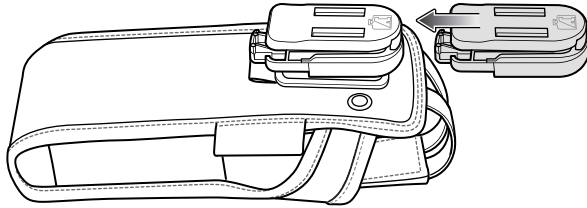

2. Secure the belt clip on the belt or waistband.

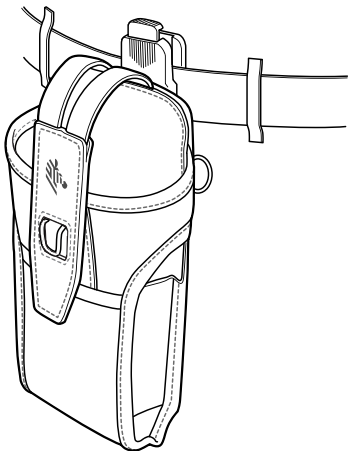

3. To insert the MC3300x-R/S, slide the mobile computer into the fabric holster with the screen facing the user.

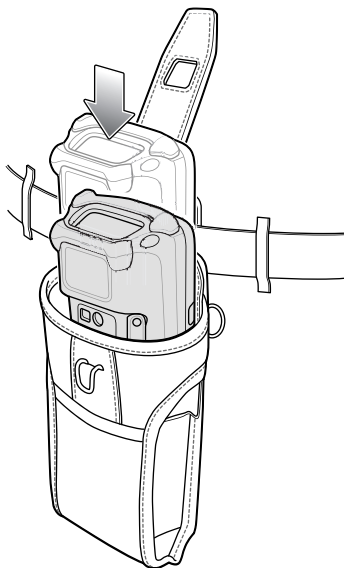



4. Secure the MC3300x-R/S with the restraining strap and place over the MC3300x-R/S to secure in place.

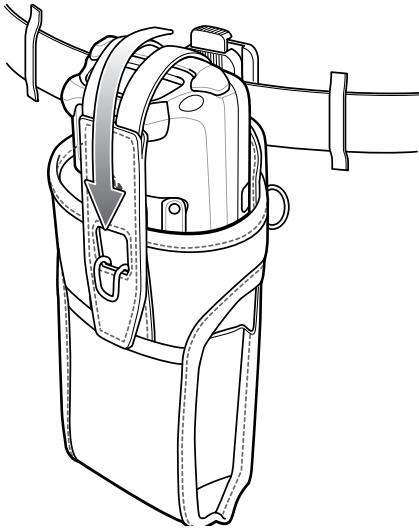

5. To remove the MC3300x-R/S, lift the restraining strap to release. Lift the MC3300x-R/S out of the fabric holster.

### Using the Shoulder Strap

1. Connect the clips on the shoulder strap to the rings on the fabric holster.
2. Place the shoulder strap over your head and rest on your shoulder.

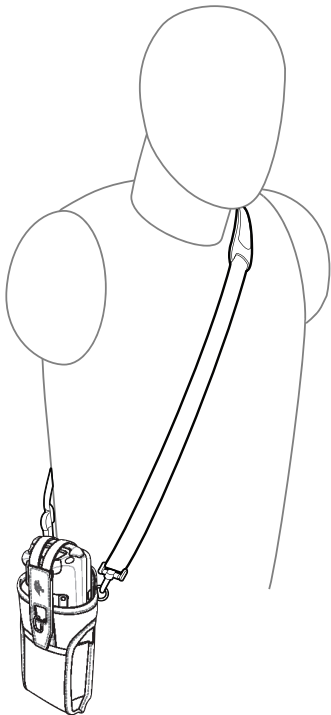

3. Lift the strap and insert the MC3300x-R/S into the holster.
4. Secure the strap to hold the MC3300x-R/S in place.

## Un-powered Forklift Mount

The Un-powered Forklift Mount allows the user to place the MC3300x in a holder while installed on a forklift. However, it does not provide charging or communication to the terminal. The Forklift Mount can be installed on a square surface or roll bar of a forklift and supports portrait (vertical) orientation.

**Figure 51** Forklift Mount

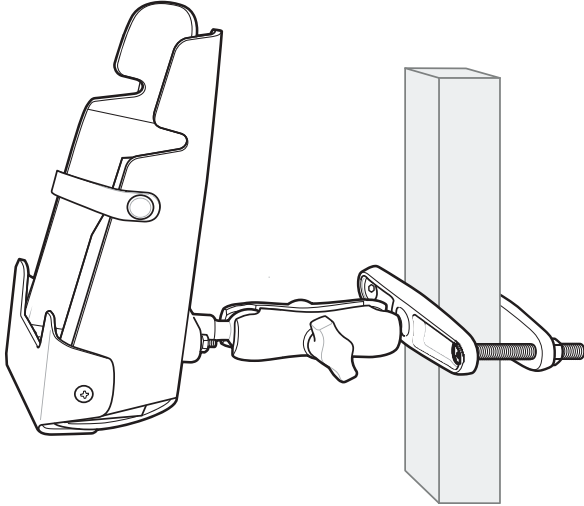

To use the MC3300x in the forklift mount holder:

1. Insert the MC3300x into the Forklift Mount Holder in an upright position.

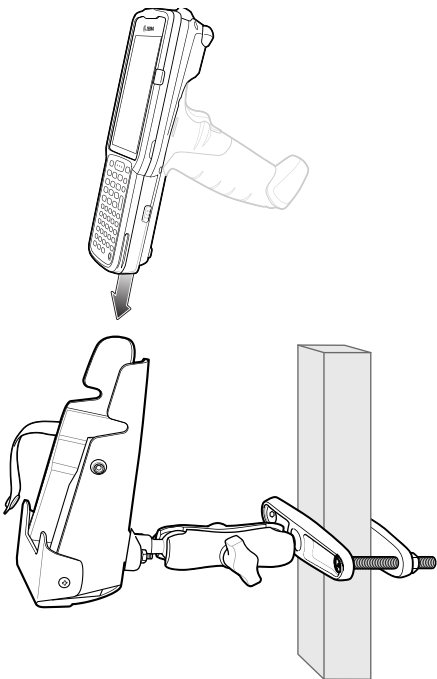

2. Secure the device with the rubber strap and snap into place.

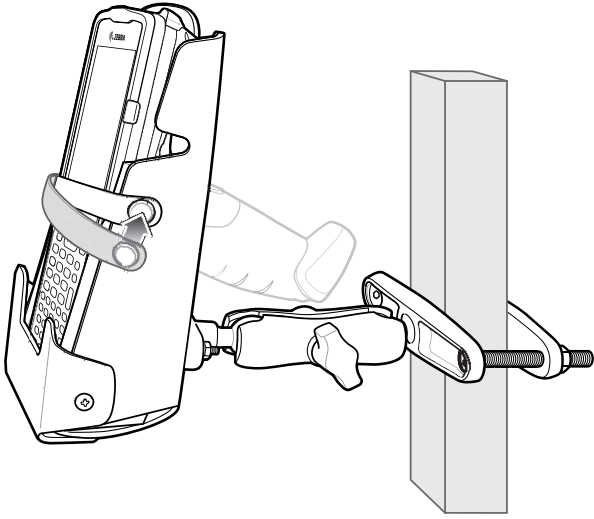

## Replacement Hand Strap for MC3300x-G

To install the hand strap:

1. Thread the lanyard loop through the opening near the base of the trigger handle.

**Figure 52** Insert Loop Through Handle Slot

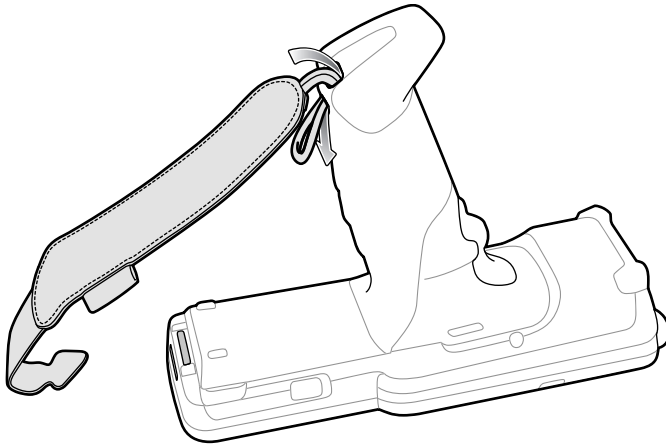

2. Insert the top end of the hand strap through the loop.

**Figure 53** Thread Hand Strap Through Loop

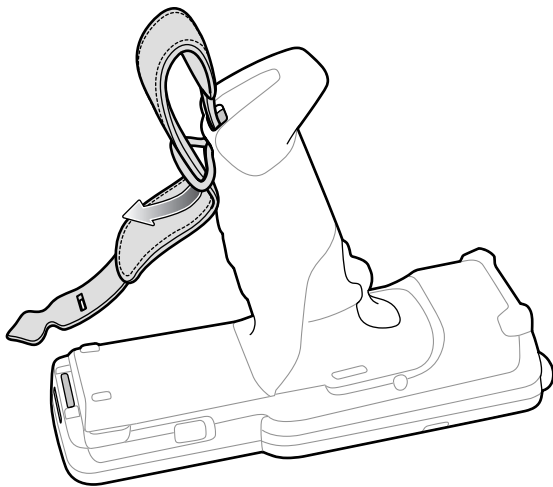

3. Thread the hand strap through the lanyard.
4. Pull the hand strap through the loop.
5. Thread the end of the hand strap with the tab through the slot on the bottom of the MC3300x-G.

**Figure 54** Thread Tab Through Slot

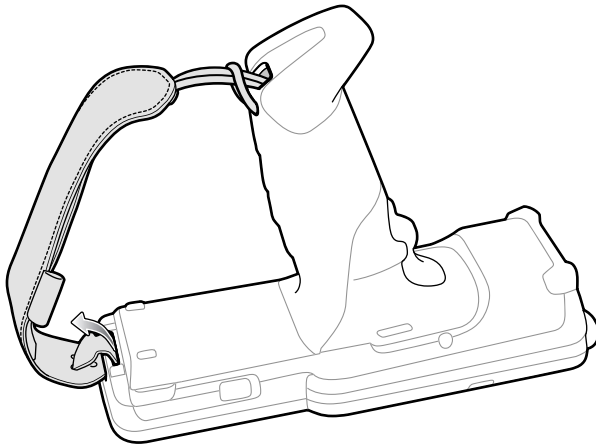

6. Slide the tab through the slit in the hand strap so that the tip of the tab is facing away from the MC3300x-G.

## Replacement Hand Strap for MC3300x-R/S

To install the hand strap:

1. Thread the end of the hand strap with the tab through the slot toward the top of the MC3300x-R/S.

**Figure 55** Thread Tab Through Top Slot

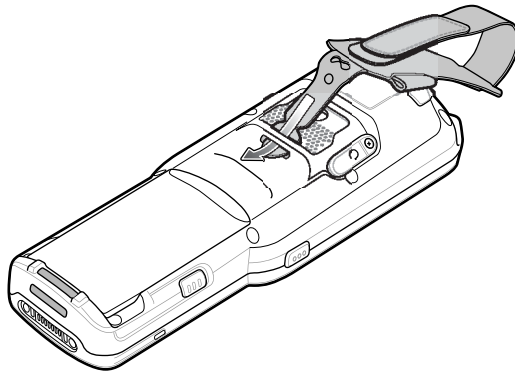

2. Slide the tab through the slit in the hand strap so that the tip of the tab is facing away from the MC3300x-R/S.

**Figure 56** Slide Tab Through Slit

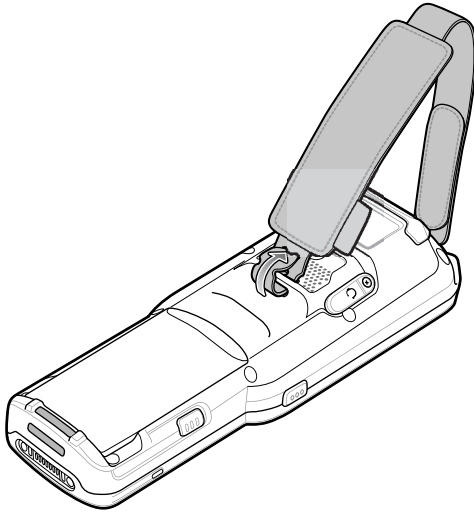

3. Thread the end of the hand strap with the velcro through the slot at the bottom of the MC3300x-R/S.

**Figure 57** Thread Velcro Through Bottom Slot

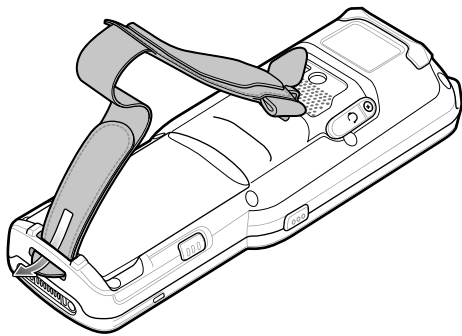

4. Pull the strap to the desired length and secure using the velcro.

**Figure 58** Pull Strap and Secure Velcro

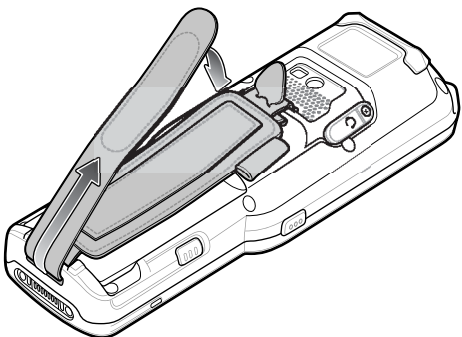

# Application Deployment

## Security

The device implements a set of security policies that determine whether an application is allowed to run and, if allowed, with what level of trust. To develop an application, you must know the security configuration of the device, and how to sign an application with the appropriate certificate to allow the application to run (and to run with the needed level of trust).



**NOTE:** Ensure the date is set correctly before installing certificates or when accessing secure web sites.

## Secure Certificates

If the VPN or Wi-Fi networks rely on secure certificates, obtain the certificates and store them in the device's secure credential storage, before configuring access to the VPN or Wi-Fi networks.

If downloading the certificates from a web site, set a password for the credential storage. The device supports X.509 certificates saved in PKCS#12 key store files with a .p12 extension (if key store has a .pfx or other extension, change to .p12).

The device also installs any accompanying private key or certificate authority certificates contained in the key store.

## Installing a Secure Certificate

To install a secure certificate:

1. Copy the certificate from the host computer to the root of the microSD card or the device's internal memory. See [USB Communication on page 43](#) for information about connecting the device to a host computer and copying files.
2. Go to **Settings**.
3. Touch **Security > Advanced > Encryption & credentials**.
4. Touch **Install a certificate**.
5. Navigate to the location of the certificate file.
6. Touch the filename of the certificate to install.
7. If prompted, enter the password for credential storage. If a password has not been set for the credential storage, enter a password for it twice and then touch **OK**.
8. If prompted, enter the certificate's password and touch **OK**.

9. Enter a name for the certificate and in the Credential use drop-down, select **VPN and apps** or **Wi-Fi**.
10. Touch **OK**.

The certificate can now be used when connecting to a secure network. For security, the certificate is deleted from the microSD card or internal memory.

### Configuring Credential Storage Settings

1. Go to **Settings**.
2. Touch **Security > Advanced > Encryption & credentials**.
  - **Trusted credentials** - Touch to display the trusted system and user credentials.
  - **User credentials** - Touch to display user credentials.
  - **Install from storage** - Touch to install a secure certificate from the microSD card or internal storage.
  - **Clear credentials** - Deletes all secure certificates and related credentials.

## Development Tools

Development tools for Android include Android Studio, EMDK for Android, and StageNow.

### Android Application Development

#### Development Workstation

Android development tools are available at [developer.android.com](http://developer.android.com).

To start developing applications for the device, download Android Studio. Development can take place on a Microsoft® Windows®, Mac® OS X®, or Linux® operating system.

Applications are written in Java or Kotlin, but compiled and executed in the Dalvik virtual machine. Once the Java code is compiled cleanly, the developer tools make sure the application is packaged properly, including the AndroidManifest.xml file.

Android Studio contains a full featured IDE as well as SDK components required to develop Android applications.

#### Enabling Developer Options

The **Developer options** screen sets development related settings. By default, the Developer Options are hidden.

1. Go to **Settings**.
2. Touch **About phone**.
3. Scroll down to **Build number**.
4. Tap **Build number** seven times. The message **You are now a developer!** appears.
5. Touch the Back button.
6. Touch **System > Advanced > Developer options**.
7. Slide the **USB debugging** switch to the **ON** position.



### EMDK for Android

EMDK for Android provides developers with tools to create business applications for enterprise mobile devices. It is designed for use with Google's Android Studio and includes Android class libraries such as Barcode, sample applications with source code, and the associated documentation.

EMDK for Android allows applications to take full advantage of the capabilities that Zebra devices have to offer. It embeds Profile Manager technology within Android Studio IDE, providing a GUI-based development tool designed specifically for Zebra devices. This allows fewer lines of code, resulting in reduced development time, effort, and errors.

For more information go to: [techdocs.zebra.com](http://techdocs.zebra.com).

### StageNow

StageNow is Zebra's next-generation Android Staging Solution built on the MX platform. It allows quick and easy creation of device profiles, and can deploy to devices simply by scanning a barcode, reading a tag, or playing an audio file.

The StageNow Staging Solution includes the following components:

- The StageNow Workstation tool installs on the staging workstation (host computer) and lets the administrator easily create staging profiles for configuring device components, and perform other staging actions such as checking the condition of a target device to determine suitability for software upgrades or other activities. The StageNow Workstation stores profiles and other created content for later use.
- The StageNow Client resides on the device and provides a user interface for the staging operator to initiate staging. The operator uses one or more of the desired staging methods (print and scan a barcode, read an NFC tag or play an audio file) to deliver staging material to the device.

For more information go to: [techdocs.zebra.com](http://techdocs.zebra.com).

### GMS Restricted

GMS Restricted mode deactivates Google Mobile Services (GMS). All GMS apps are disabled on the device and communication with Google (analytics data collection and location services) is disabled.

Use StageNow to disable or enable GMS Restricted mode. After a device is in GMS Restricted mode, enable and disable individual GMS apps and services using StageNow. To ensure GMS Restricted mode persists after an Enterprise Reset, use the Persist Manager option in StageNow. For more information on StageNow, refer to [techdocs.zebra.com](http://techdocs.zebra.com).

### ADB USB Setup

To use the ADB, install the USB driver. This assumes that the development SDK has been installed on the host computer. Go to [developer.android.com/sdk/index.html](http://developer.android.com/sdk/index.html) for details on setting up the development SDK.

ADB driver for Windows and Linux are available on the Zebra Support Central web site at [zebra.com/support](http://zebra.com/support). Download the ADB and USB Driver Setup package. Follow the instructions with the package to install the ADB and USB drivers for Windows and Linux.

### Enabling USB Debugging

By default, USB debugging is disabled.

1. Go to **Settings**.
2. Touch **About phone**.
3. Scroll down to **Build number**.
4. Tap **Build number** seven times. The message **You are now a developer!** appears.
5. Touch the Back button.
6. Touch **System > Advanced > Developer options**.
7. Slide the **USB debugging** switch to the **ON** position.
8. Touch **OK**.
9. Connect the device to the host computer using the Rugged Charge/USB Cable.  
The **Allow USB debugging?** dialog box appears on the device.
10. On the device, touch **OK**.
11. On the host computer, navigate to the **platform-tools** folder.
12. Open a command prompt window and use the adb command:  

```
adb devices
```

The following displays:  

```
List of devices attached
```

```
XXXXXXXXXXXXXXXXX device (where XXXXXXXXXXXXXXXXXXXX is the device number).
```



**NOTE:** If device number does not appear, ensure that ADB drivers are installed properly.

13. Touch the Home button.

## Entering Android Recovery Manually

Many of the update methods discussed in this section require putting the device into Android Recovery mode. If you are unable to enter Android Recovery mode through adb commands, use the following steps to manually enter Android Recovery mode.

1. Press and hold the Power button until the menu appears.
2. Touch **Restart**.
3. Press and hold the Right Scan key (MC3300x-S/R) or the trigger (MC3300x-G) to enter system recovery mode.

## Application Installation

After an application is developed, install the application onto the device using one of the following methods:

- USB connection, see [Installing Applications Using the USB Connection on page 164](#).
- Android Debug Bridge, see [Installing Applications Using the Android Debug Bridge on page 164](#).
- Wireless Android Debug Bridge, see [Installing Applications Using the Wireless Android Debug Bridge on page 165](#).
- microSD Card, see [Installing Applications Using a microSD Card on page 166](#).

- Mobile device management (MDM) platforms that have application provisioning. Refer to the MDM software documentation for details.

### Installing Applications Using the USB Connection



**CAUTION:** When connecting the device to a host computer and mounting the microSD card, follow the host computer's instructions for connecting and disconnecting USB devices, to avoid damaging or corrupting files.

1. Connect the device to a host computer using the Rugged Charge/USB cable.
2. Pull down the Notification panel and touch **Charging this device via USB**.
3. Touch **File Transfer**.
4. On the host computer, open a file manager application.
5. On the host computer, copy the application .apk file from the host computer to the device.



**CAUTION:** Carefully follow the host computer's instructions to unmount the microSD card and disconnect USB devices correctly to avoid losing information.

6. Disconnect the device from the host computer.
7. Swipe the screen up and select  to view files on the microSD card or Internal Storage.
8. Locate the application .apk file.
9. Touch the application file.
10. Touch **Continue** to install the app or **Cancel** to stop the installation.
11. To confirm installation and accept what the application affects, touch **Install** otherwise touch **Cancel**.
12. Touch **Open** to open the application or **Done** to exit the installation process. The application appears in the App list.

### Installing Applications Using the Android Debug Bridge

Use ADB commands to install an application onto the device.



**CAUTION:** When connecting the device to a host computer and mounting its microSD card, follow the host computer's instructions for connecting and disconnecting USB devices, to avoid damaging or corrupting files.

1. Ensure that the ADB drivers are installed on the host computer. See [ADB USB Setup on page 162](#).
2. Connect the device to a host computer using USB. See [USB Communication on page 43](#).
3. Enable Developer options. For more information see [Enabling USB Debugging on page 162](#).
4. Go to **Settings**.
5. Touch **System > Advanced > Developer options**.
6. Slide the switch to the **ON** position.
7. Touch **USB Debugging**. A check appears in the check box. The **Allow USB debugging?** dialog box appears.
8. Touch **OK**.

9. On the host computer, open a command prompt window and use the adb command:  
`adb install <application>`  
 where: <application> = the path and filename of the apk file.
10. Disconnect the device from the host computer. See [USB Communication on page 43](#).

## Installing Applications Using the Wireless Android Debug Bridge

Use ADB commands to install an application onto the device.



**IMPORTANT:** Ensure that the latest adb files are installed on the host computer.



**NOTE:** The device and the host computer must be on the same wireless network.

1. Go to **Settings**.
2. Touch **System > Advanced > Developer options**.
3. Slide the switch to the **ON** position.
4. Slide the **USB debugging** switch to the **ON** position.
5. Slide the **Wireless debugging** switch to the **ON** position.
6. If the device and host computer are connected for the first time, the **Allow wireless debugging on this network?** dialog box with the **Always allow from this network** check box displays. Select the check box, if required.
7. Touch **ALLOW**.
8. Touch **Wireless debugging**.
9. Touch **Pair with pairing code**.  
 The **Pair with device** dialog box displays.
10. On the host computer, navigate to the platform-tools folder and open a command prompt window.
11. Type `adb pair XX.XX.XX.XX.XXXXX`.  
 where XX.XX.XX.XX.XXXXX is the IP address and port number from the Pair with device dialog box.
12. Press Enter.
13. Type the pairing code from the **Pair with device** dialog box.
14. Press Enter.
15. Type `adb connect XX.XX.XX.XX.XXXXX`.  
 The device is now connected to the host computer.
16. On the host computer, use the adb command:  
`adb devices`  
 The following displays:  
**List of devices attached**  
 XXXXXXXXXXXXXXXX device (where XXXXXXXXXXXXXXXX is the device number).



**NOTE:** If device number does not appear, ensure that ADB drivers are installed properly.

17. On the host computer, open a command prompt window and use the adb command:

```
adb install <application>
```



where: <application> = the path and filename of the apk file.

18. On the host computer, type **adb disconnect**.

## Installing Applications Using a microSD Card



**CAUTION:** When connecting the device to a host computer and mounting its microSD card, follow the host computer's instructions for connecting and disconnecting USB devices, to avoid damaging or corrupting files.

1. Copy the apk file to the root of the microSD card.
  - Copy the apk file to a microSD card using a host computer (see [USB Communication](#) for more information), and then install the microSD card into the device (see [Replacing the microSD Card](#) for more information).
  - Connect the device with a microSD card already installed to the host computer, and copy apk file to the microSD card. See [USB Communication](#) for more information. Disconnect the device from the host computer.
2. Press and hold the Power button to turn on the device.
3. Swipe the screen up and select  to view files on the microSD card.
4. Touch  > **SD card**.
5. Locate the application .apk file.
6. Touch the application file.
7. Touch **Continue** to install the app or **Cancel** to stop the installation.
8. To confirm installation and accept what the application affects, touch **Install** otherwise touch **Cancel**.
9. Touch **Open** to open the application or **Done** to exit the installation process. The application appears in the App list.

## Uninstalling an Application

1. Go to **Settings**.
2. Touch **Apps & notifications**.
3. Touch **See all apps** to view all apps in the list.
4. Scroll through the list to the app.
5. Touch the app. The **App info** screen appears.
6. Touch **Uninstall**.
7. Touch **OK** to confirm.

## Performing a System Update

System Update packages can contain either partial or complete updates for the operating system. Zebra distributes the System Update packages on the Zebra Support & Downloads web site. Perform a system update using either a microSD card or using ADB.

## Downloading the System Update Package

1. Go to the Zebra Support & Downloads web site, [zebra.com/support](http://zebra.com/support).
2. Download the appropriate System Update package to a host computer.

## Performing a System Update Using microSD Card

1. Copy the System Update zip file to the root of the microSD card.
  - Copy the zip file to a microSD card using a host computer (see [USB Communication](#) for more information), and then installing the microSD card into the device (see [Replacing the microSD Card](#) for more information).
  - Connect the device with a microSD card already installed to the host computer, and copy zip file to the microSD card. See [USB Communication](#) for more information. Disconnect the device from the host computer.
2. Press and hold the Power button until the menu appears.
3. Touch **Restart**.
4. Press and hold the Right Scan key (MC3300x-S/R) or the trigger (MC3300x-G) to enter system recovery mode.
5. Press the Up and Down arrow keys to navigate to **Apply upgrade from SD card**.
6. Press the Enter key or Power button to select.
7. Press the Up and Down arrow keys to navigate to the System Update file.
8. Press the Enter key or Power button to start the system update install. After the installation the device returns to the Recovery screen.
9. Navigate to **Reboot system now** and press the Enter key or Power button to reboot the device.

## Performing a System Update Using ADB

1. Ensure that the ADB drivers are installed on the host computer. See [ADB USB Setup on page 162](#).
2. Connect the device to a host computer using the Rugged Charge/USB cable or by inserting the device into the 1-Slot USB/Charge Only Cradle.
3. Go to **Settings**.
4. Touch **System > Advanced > Developer options**.
5. Slide the switch to the **ON** position.
6. Touch **USB Debugging**. A check appears in the check box. The **Allow USB debugging?** dialog box appears.
7. Touch **OK**.
8. On the host computer, open a command prompt window and use the adb command:

```
adb devices
```

The following displays:

```
List of devices attached
```

```
XXXXXXXXXXXXXXXXX device (where XXXXXXXXXXXXXXXXXXXX is the device number).
```



**NOTE:** If device number does not appear, ensure that ADB drivers are installed properly.

9. Type:

```
adb reboot recovery
```

If you are not able to enter Android Recovery mode through the adb command, go to [Entering Android Recovery Manually on page 163](#).

10. Press Enter. The System Recovery screen appears on the device.

11. Press the Up and Down arrow keys to navigate to **Apply upgrade from ADB**.

12. Press the Enter key or Power button to select.

13. On the host computer command prompt window type:

```
adb sideload <file>
```

where: <file> = the path and filename of the zip file.

14. Press Enter. The System Update installs (progress appears as percentage in the Command Prompt window) and then the System Recovery screen appears on the device.

15. Navigate to **Reboot system now** and press the Enter key or Power button to reboot the device.

16.

## Verifying System Update Installation

1. Go to **Settings**.
2. Touch **About phone**.
3. Scroll down to **Build number**.
4. Ensure that the build number matches the new system update package file number.

## Enterprise Reset

An Enterprise Reset erases all user data in the `/data` partition, including data in the primary storage locations (`/sdcard` and emulated storage).

Before performing an Enterprise Reset, provision all necessary configuration files and restore after the reset.

Perform Enterprise Reset from the device settings, using a microSD card, or using ADB.

## Performing an Enterprise Reset From Device Settings

1. Go to **Settings**.
2. Touch **System > Reset options > Erase all data (enterprise reset)**.
3. Touch **Erase all data** twice to confirm the Enterprise Reset.

## Downloading the Enterprise Reset Package

1. Go to the Zebra Support & Downloads web site, [zebra.com/support](https://zebra.com/support).
2. Download the Enterprise Reset file to a host computer.

## Performing an Enterprise Reset Using microSD Card

1. Copy the Enterprise Reset zip file to the root of the microSD card.
  - Copy the zip file to a microSD card using a host computer (see [USB Communication](#) for more information) and then installing the microSD card into the device (see [Replacing the microSD Card](#) for more information).
  - Connect the device with a microSD card already installed to the host computer and copy zip file to the microSD card. See [USB Communication](#) for more information. Disconnect the device from the host computer.
2. Press and hold the Power button until the menu appears.
3. Touch **Restart**.
4. Press and hold the Right Scan key (MC3300x-S/R) or the trigger (MC3300x-G) to enter system recovery mode.
5. Press the Up and Down arrow keys to navigate to **Apply from sdcard**.
6. Press the Enter key or Power button to select.
7. Press the Up and Down arrow keys to navigate to the Enterprise Reset file.
8. Press the Enter key or Power button to start the Enterprise Reset. After the Enterprise Reset the device returns to the Recovery screen.
9. Navigate to **Reboot system now** and press the Enter key or Power button to reboot the device.

## Performing an Enterprise Reset Using ADB

1. Connect the device to the Rugged Charge/USB cable or insert the device into the 1-Slot USB/Charge Only Cradle.
2. Connect the cable or cradle to the host computer.
3. Go to **Settings**.
4. Touch **System > Advanced > Developer options**.
5. Slide the switch to the **ON** position.
6. Touch **USB Debugging**. A check appears in the check box. The **Allow USB debugging?** dialog box appears.
7. Touch **OK**.
8. On the host computer, open a command prompt window and type:  
`adb devices.`  
The following displays:  
`List of devices attached`  
`XXXXXXXXXXXXXXXXX device (where XXXXXXXXXXXXXXXXXXXX is the device number).`



**NOTE:** If device number does not appear, ensure that ADB drivers are installed properly.



9. Type:

```
adb reboot recovery
```

If you are not able to enter Android Recovery mode through the adb command, go to [Entering Android Recovery Manually on page 163](#).

10. Press Enter. The System Recovery screen appears on the device.

11. Press the Up and Down arrow keys to navigate to **Apply upgrade from ADB**.

12. Press the Enter key or Power button to select.

13. On the host computer command prompt window type:

```
adb sideload <file>
```

where: <file> = the path and filename of the zip file.

14. Press Enter. The Enterprise Reset package installs and then the System Recovery screen appears on the device.

15. Navigate to **Reboot system now** and press the Enter key or Power button to reboot the device.

## Performing a Factory Reset

A Factory Reset erases all data in the `/data` and `/enterprise` partitions in internal storage and clears all device settings and can be performed using microSD or ADB. A Factory Reset returns the device to the last installed operating system image. To revert to a previous operating system version, re-install that operating system image. See [Performing a System Update](#) for more information.

### Downloading the Factory Reset Package

To download the Factory Reset package:

1. Go to the Zebra Support & Downloads web site, [zebra.com/support](http://zebra.com/support).
2. Download the appropriate Factory Reset file to a host computer.

### Performing a Factory Reset Using microSD Card

1. Copy the Factory Reset zip file to the root of the microSD card.
  - Copy the zip file to a microSD card using a host computer (see [USB Communication](#) for more information) and then installing the microSD card into the device (see [Replacing the microSD Card](#) for more information).
  - Connect the device with a microSD card already installed to the host computer and copy zip file to the microSD card. See [USB Communication](#) for more information. Disconnect the device from the host computer.
2. Press and hold the Power button until the menu appears.
3. Touch **Restart**.
4. Press and hold the Right Scan key (MC3300x-S/R) or the trigger (MC3300x-G) to enter system recovery mode.
5. Press the Up and Down arrow keys to navigate to **Apply upgrade from sdcard**.
6. Press the Enter key or Power button to select.
7. Press the Up and Down arrow keys to navigate to the Factory Reset file.

8. Press the Enter key or Power button to start the Factory Reset. After the Factory Reset the device returns to the Recovery screen.
9. Navigate to **Reboot system now** and press the Enter key or Power button to reboot the device.

### Performing a Factory Reset Using ADB

To perform an Factory Reset using ADB:

1. Connect the device to the Rugged Charge/USB cable or insert the device into the 1-Slot USB/Charge Only Cradle.
2. Connect the cable or cradle to the host computer.
3. Go to **Settings**.
4. Touch **System > Advanced > Developer options**.
5. Slide the switch to the **ON** position.
6. Touch **USB Debugging**. A check appears in the check box. The **Allow USB debugging?** dialog box appears.
7. Touch **OK**.
8. On the host computer, open a command prompt window and type:

```
adb devices.
```

The following displays:

```
List of devices attached
```

```
XXXXXXXXXXXXXXXXX device (where XXXXXXXXXXXXXXXXXXXX is the device number).
```



**NOTE:** If device number does not appear, ensure that ADB drivers are installed properly.

9. Type:

```
adb reboot recovery
```

If you are not able to enter Android Recovery mode through the adb command, go to [Entering Android Recovery Manually on page 163](#).

10. Press Enter. The System Recovery screen appears on the device.
11. Press the Up and Down arrow keys to navigate to **Apply upgrade from ADB**.
12. Press the Enter key or Power button to select.
13. On the host computer command prompt window type:
 

```
adb sideload <file>
```

where: <file> = the path and filename of the zip file.
14. Press Enter. The Factory Reset package installs and then the System Recovery screen appears on the device.
15. Navigate to **Reboot system now** and press the Enter key or Power button to reboot the device.

## Storage

The device contains the following types of file storage:

- Random Access Memory (RAM)
- Internal storage
- External storage (microSD card)
- Enterprise folder.

### Random Access Memory

Executing programs use RAM to store data. Data stored in RAM is lost upon a reset. The operating system manages how applications use RAM. It only allows applications and component processes and services to use RAM when required. It may cache recently used processes in RAM, so they restart more quickly when opened again, but it will erase the cache if it needs the RAM for new activities.

The screen displays the amount of used and free RAM.

- **Performance** - Indicates memory performance.
- **Total memory** - Indicates the total amount of RAM available.
- **Average used (%)** - Indicates the average amount of memory (as a percentage) used during the period of time selected (default - 3 hours).
- **Free** - Indicates the total amount of unused RAM.
- **Memory used by apps** - Touch to view RAM usage by individual apps.

### Viewing Memory

1. Go to **Settings**.
2. Touch **System > Advanced > Developer options > Memory**.

### Internal Storage

The device has internal storage. The internal storage content can be viewed and files copied to and from when the device is connected to a host computer. Some applications are designed to be stored on the internal storage rather than in internal memory.

### Viewing Internal Storage

1. Go to **Settings**.
  2. Touch **Storage**.
- **Internal Storage** - Displays the total amount of space on internal storage and amount used.

If the device has removable storage installed, touch **Internal shared storage** to display a the amount of internal storage used by apps, photos, videos, audio and other files.

### External Storage

The device can have a removable microSD card. The microSD card content can be viewed and files copied to and from when the device is connected to a host computer.

### Viewing External Storage

1. Go to **Settings**.
2. Touch **Storage**.

Portable storage displays the total amount of space on the installed microSD card and the amount used.

To unmount the microSD card, touch .

Touch **SD card** to view the contents of the card.

### Formatting a microSD Card or USB Drive as Portable Storage

1. Touch **SD card** or **USB drive**.
2. Touch  > **Storage settings**.
3. Touch **Format**.
4. Touch **ERASE & FORMAT**.
5. Touch **DONE**.

### Formatting a microSD Card as Internal Memory

You can format a microSD card as internal memory to increase the actual amount of the device's internal memory. Once formatted, the microSD card can only be read by this device.

1. Touch **SD card**.
2. Touch  > **Storage settings**.
3. Touch **Format as internal**.
4. Touch **ERASE & FORMAT**.
5. Touch **DONE**.

## Enterprise Folder

The Enterprise folder (within internal flash) is a super-persistent storage that is persistent after a reset and an Enterprise Reset. The Enterprise folder is erased during a Factory Reset. The Enterprise folder is used for deployment and device-unique data. The Enterprise folder is approximately 128 MB (formatted). Applications can persist data after an Enterprise Reset by saving data to the enterprise/user folder. The folder is ext4 formatted and is only accessible from a host computer using ADB or from an MDM.

## Managing Apps

Apps use two kinds of memory: storage memory and RAM. Apps use storage memory for themselves and any files, settings, and other data they use. They also use RAM when they are running.

1. Go to **Settings**.
2. Touch **Apps & notifications**.
3. Touch **See all XX apps** to view all apps on the device.
4. Touch  > **Show system** to include system processes in the list.
5. Touch an app, process, or service in the list to open a screen with details about it and, depending on the item, to change its settings, permissions, notifications and to force stop or uninstall it.

## App Details



Apps have different kinds of information and controls.

- **Force stop** - Stop an app.

- **Disable** - Disable an app.
- **Uninstall** - Remove the app and all of its data and settings from the device. See [Uninstalling an Application on page 166](#) for information about uninstalling apps.
- **Notifications** - Set the app notification settings.
- **Permissions** - Lists the areas on the device that the app has access to.
- **Storage & cache** - Lists how much information is stored, and includes buttons for clearing it.
- **Mobile data & Wi-Fi** - Provides information about data consumed by an app.
- **Advanced**
  - **Screen time** - Displays the amount of time the app has displayed on the screen.
  - **Battery** - Lists the amount of computing power used by the app.
  - **Open by default** - If you have configured an app to launch certain file types by default, you can clear that setting here.
  - **Display over other apps** - allows an app to display on top of other apps.
  - **App details** - Provides a link to additional app details on the Play store.
  - **Additional settings in the app** - Opens settings in the app.
  - **Modify system settings** - Allows an app to modify the system settings.

## Managing Downloads

Files and apps downloaded using the Browser or Email are stored on the microSD card or Internal storage in the Download directory. Use the Downloads app to view, open, or delete downloaded items.

1. Swipe the screen up and touch .
2. Touch  > **Downloads**.
3. Touch and hold an item, select items to delete and touch . The item is deleted from the device.

# Maintenance and Troubleshooting

## Maintaining the Device

For trouble-free service, observe the following tips when using the device:

- To avoid scratching the screen, use a Zebra approved capacitive compatible stylus intended for use with a touch-sensitive screen. Never use an actual pen or pencil or other sharp object on the surface of the device screen.
- The touch-sensitive screen of the device is glass. Do not drop the device or subject it to strong impact.
- Protect the device from temperature extremes. Do not leave it on the dashboard of a car on a hot day, and keep it away from heat sources.
- Do not store the device in any location that is dusty, damp, or wet.
- Use a soft lens cloth to clean the device. If the surface of the device screen becomes soiled, clean it with a soft cloth moistened with an approved cleanser. For a list of approved cleansers, see Approved Cleanser Active Ingredients.
- Periodically replace the rechargeable battery to ensure maximum battery life and product performance. Battery life depends on individual usage patterns.
- Zebra recommends using a screen protector to minimize wear and tear. Screen protectors enhance the usability and durability of touch screen displays. Benefits include:
  - Protection from scratches and gouges
  - Durable writing and touch surface with tactile feel
  - Abrasion and chemical resistance
  - Glare reduction
  - Keeping the device's screen looking new
  - Quick and easy installation.

## Battery Safety Guidelines

- The area in which the units are charged should be clear of debris and combustible materials or chemicals. Particular care should be taken where the device is charged in a non commercial environment.
- Follow battery usage, storage, and charging guidelines found in this guide.
- Improper battery use may result in a fire, explosion, or other hazard.
- To charge the mobile device battery, the ambient battery and charger temperatures must be between +32°F and +104°F (0°C and +40°C).

- Do not use incompatible batteries and chargers, including non-Zebra batteries and chargers. Use of an incompatible battery or charger may present a risk of fire, explosion, leakage, or other hazard. If you have any questions about the compatibility of a battery or a charger, contact the Global Customer Support Center.
- For devices that utilize a USB port as a charging source, the device shall only be connected to products that bear the USB-IF logo or have completed the USB-IF compliance program.
- Do not disassemble or open, crush, bend or deform, puncture, or shred the battery.
- Severe impact from dropping any battery-operated device on a hard surface could cause the battery to overheat.
- Do not short circuit a battery or allow metallic or conductive objects to contact the battery terminals.
- Do not modify or remanufacture, attempt to insert foreign objects into the battery, immerse or expose to water or other liquids, or expose to fire, explosion, or other hazard.
- Do not leave or store the equipment in or near areas that might get very hot, such as in a parked vehicle or near a radiator or other heat source. Do not place battery into a microwave oven or dryer.
- Battery usage by children should be supervised.
- Please follow local regulations to properly dispose of used rechargeable batteries.
- Do not dispose of batteries in fire.
- In the event of a battery leak, do not allow the liquid to come in contact with the skin or eyes. If contact has been made, wash the affected area with water for 15 minutes, and seek medical advice.
- If you suspect damage to your equipment or battery, contact Customer Support to arrange for inspection.

## Cleaning Instructions



**CAUTION:** Always wear eye protection.

Read warning label on alcohol product before using.

If you have to use any other solution for medical reasons please contact the Global Customer Support Center for more information.



**WARNING:** Avoid exposing this product to contact with hot oil or other flammable liquids. If such exposure occurs, unplug the device and clean the product immediately in accordance with these guidelines.

## Approved Cleanser Active Ingredients

100% of the active ingredients in any cleaner must consist of one or some combination of the following: isopropyl alcohol, bleach/sodium hypochlorite<sup>1</sup> (see important note below), hydrogen peroxide, ammonium chloride, or mild dish soap.



**IMPORTANT:** Use pre-moistened wipes and do not allow liquid cleaner to pool.

<sup>1</sup>When using sodium hypochlorite (bleach) based products, always follow the manufacturer's recommended instructions: use gloves during application and remove the residue afterwards with a damp alcohol cloth or a cotton swab to avoid prolonged skin contact while handling the device.

Due to the powerful oxidizing nature of sodium hypochlorite, the metal surfaces on the device are prone to oxidation (corrosion) when exposed to this chemical in the liquid form (including wipes). In the event that these type of disinfectants come in contact with metal on the device, prompt removal with an alcohol-dampened cloth or cotton swab after the cleaning step is critical.

### Harmful Ingredients

The following chemicals are known to damage the plastics on the device and should not come in contact with the device: acetone; ketones; ethers; aromatic and chlorinated hydrocarbons; aqueous or alcoholic alkaline solutions; ethanolamine; toluene; trichloroethylene; benzene; carbolic acid and TB-lysoform.

Many vinyl gloves contain phthalate additives, which are often not recommended for medical use and are known to be harmful to the housing of the device.

### Device Cleaning Instructions

Do not apply liquid directly to the device. Dampen a soft cloth or use pre-moistened wipes. Do not wrap the device in the cloth or wipe, instead gently wipe the unit. Be careful not to let liquid pool around the display window or other places. Before use, allow the unit to air dry.



**NOTE:** For thorough cleaning, it is recommended to first remove all accessory attachments, such as hand straps or cradle cups, from the mobile device and to clean them separately.

### Special Cleaning Notes

Do not handle the device while wearing vinyl gloves containing phthalates. Remove vinyl gloves and wash hands to eliminate any residue left from the gloves.

If products containing any of the harmful ingredients listed above are used prior to handling the device, such as a hand sanitizer that contains ethanolamine, hands must be completely dry before handling the device to prevent damage to the device.



**IMPORTANT:** If the battery connectors are exposed to cleaning agents, thoroughly wipe off as much of the chemical as possible and clean with an alcohol wipe. It is also recommended to install the battery in the terminal prior to cleaning and disinfecting the device to help minimize buildup on the connectors.

When using cleaning/disinfectant agents on the device, it is important to follow the directions prescribed by the cleaning/disinfectant agent manufacturer.

### Cleaning Materials Required

- Alcohol wipes
- Lens tissue
- Cotton-tipped applicators
- Isopropyl alcohol
- Can of compressed air with a tube.



### Cleaning Frequency

The cleaning frequency is at the customer's discretion due to the varied environments in which the mobile devices are used and may be cleaned as frequently as required. When dirt is visible, it is recommended to clean the mobile device to avoid build up of particles which make the device more difficult to clean later on.

For consistency and optimum image capture, it is recommended to clean the camera window periodically especially when used in environments prone to dirt or dust.

### Cleaning the Device

#### Housing

Thoroughly wipe the housing, including all buttons and triggers, using an approved alcohol wipe.

#### Display

The display can be wiped down with an approved alcohol wipe, but care should be taken not to allow any pooling of liquid around the edges of the display. Immediately dry the display with a soft, non-abrasive cloth to prevent streaking.

#### Camera and Exit Window

Wipe the camera and exit window periodically with a lens tissue or other material suitable for cleaning optical material such as eyeglasses.

### Cleaning Battery Connectors

1. Remove the main battery from the mobile computer.
2. Dip the cotton portion of the cotton-tipped applicator in isopropyl alcohol.
3. To remove any grease or dirt, rub the cotton portion of the cotton-tipped applicator back-and-forth across the connectors on the battery and terminal sides. Do not leave any cotton residue on the connectors.
4. Repeat at least three times.
5. Use a dry cotton-tipped applicator and repeat steps 3 and 4. Do not leave any cotton residue on the connectors.
6. Inspect the area for any grease or dirt and repeat the cleaning process if necessary.



**CAUTION:** After cleaning the battery connectors with bleach-based chemicals, follow the Battery Connector Cleaning instructions to remove bleach from the connectors.

### Cleaning Cradle Connectors

1. Remove the DC power cable from the cradle.
2. Dip the cotton portion of the cotton-tipped applicator in isopropyl alcohol.
3. Rub the cotton portion of the cotton-tipped applicator along the pins of the connector. Slowly move the applicator back-and-forth from one side of the connector to the other. Do not leave any cotton residue on the connector.

4. All sides of the connector should also be rubbed with the cotton-tipped applicator.
5. Remove any lint left by the cotton-tipped applicator.
6. If grease and other dirt can be found on other areas of the cradle, use a lint-free cloth and alcohol to remove.
7. Allow at least 10 to 30 minutes (depending on ambient temperature and humidity) for the alcohol to air dry before applying power to cradle.  
If the temperature is low and humidity is high, longer drying time is required. Warm temperature and low humidity requires less drying time.



**CAUTION:** After cleaning the cradle connectors with bleach-based chemicals, follow the Cleaning Cradle Connectors instructions to remove bleach from the connectors.

## Troubleshooting

### Resetting the Device

The reset functions include the following:

- Soft reset
- Hard reset
- Enterprise reset

#### Performing a Soft Reset

Perform a soft reset if applications stop working.

1. Press and hold the Power button until the menu appears.
2. Touch **Restart**.

The device reboots.

#### Performing a Hard Reset



**CAUTION:** Performing a hard reset with a microSD card installed in the device may cause damage or data corruption to the microSD card. All un-saved data is lost after performing a hard reset.

Perform a hard reset if the device stops responding.

1. Simultaneously press and hold the Power button, 1 and 9 keys for five seconds.
2. When the screen turns off, release the buttons.

The device reboots.

## MC3300x

The following table provide typical problems that might arise and the solution for correcting the problem.

**Table 14** Troubleshooting the MC3300x

Problem	Cause	Solution
When pressing the power button the device does not turn on.	Battery not charged.	Charge or replace the battery in the device.
	Battery not installed properly.	Install the battery properly.
	System crash.	Perform a reset.
Battery did not charge.	Battery failed.	Replace battery. If the device still does not operate, try a soft reset, then a hard reset. See <a href="#">Resetting the Device on page 179</a>
	Device removed from cradle while battery was charging.	Insert device in cradle and begin charging. The MC3300x 7000 mAh PowerPrecision+ extended battery charges from 0% to 90% in less than 5.2 hours at room temperature. The MC33XX 5200 mAh PowerPrecision+ high capacity battery charges from 0% to 90% in less than 3.8 hours at room temperature. The MC33XX 2740 mAh PowerPrecision+ standard battery charges from 0% to 90% in less than 2.2 hours at room temperature.
	Extreme battery temperature.	Battery does not charge if ambient charging temperature of the battery is below 32°F (0°C) or above 104°F (40°C).
Cannot see characters on screen.	Device not powered on.	Press the Power button.
During data communication, no data was transmitted, or transmitted data was incomplete.	Device removed from cradle or unplugged from host computer during communication.	Replace the device in the cradle, or reattach the cable and re-transmit.
	Incorrect cable configuration.	See the system administrator.
Device does not emit sound.	Volume setting is low or turned off.	Click on the speaker icon to increase the volume.
Device turns itself off.	Device is inactive.	The device turns off after a period of inactivity. This period can be set from 15 seconds to Never.
	Battery is depleted.	Recharge or replace the battery.
A message appears stating that the device memory is full.	Too many applications installed on the device.	Remove user-installed applications on the device to recover memory. Go to <b>Settings &gt; Apps</b> . Select the unused programs and touch <b>Uninstall</b> .

**Table 14** Troubleshooting the MC3300x (Continued)

Problem	Cause	Solution
The device does not decode when reading barcode.	DataWedge is not enabled.	Ensure that DataWedge is enabled and configured properly.
	Unreadable barcode.	Ensure the symbol is not defaced.
	Distance between the device and barcode is incorrect.	Place the device within proper scanning range.
	Device is not programmed for the barcode type.	Program the device to accept the type of barcode being scanned.
	Device is not programmed to generate a beep.	If the device does not beep on a good decode, set the application to generate a beep on good decode.
Device cannot find any Bluetooth devices nearby.	Too far from other Bluetooth devices.	Move closer to the other Bluetooth device(s), within a range of 10 meters (32.8 feet).
	The Bluetooth device(s) nearby are not turned on.	Turn on the Bluetooth device(s) to find.
	The Bluetooth device(s) are not in discoverable mode.	Set the Bluetooth device(s) to discoverable mode. If needed, refer to the device's user documentation for help.
Cannot connect to WLAN (on channels 12-13 and all 5GHz channels).	Access Point (AP) does not broadcast country code.	Disable 802.11d feature. Go to <b>Settings &gt; Wi-Fi &gt; &gt; Additional settings &gt; Country Selection</b> . A warning window pops up indicating you must select the country in which you are using the device. This enables all channels for the selected country even if the AP does not broadcast country code.
When trying to open Files or other applications, the application automatically closes.	The Internal Memory is full.	Connect the device to a host computer and delete files from Internal Memory using the host computer.

## 1-Slot USB Charge Cradle

**Table 15** Troubleshooting the 1-Slot USB Charge Cradle

Problem	Cause	Solution
Device Charge LED Indicator does not light when device inserted.	Cradle is not receiving power.	Ensure the power cable is connected securely to both the cradle and to AC power.
	Device is not correctly seated.	Remove and re-insert the device into the cradle, ensuring it is correctly seated.
Spare Battery Charging LED does not light when spare battery is inserted.	Spare battery not correctly seated.	Remove and re-insert the spare battery into the cradle, ensuring it is correctly seated.

**Table 15** Troubleshooting the 1-Slot USB Charge Cradle (Continued)

Problem	Cause	Solution
Device battery is not charging.	Device was removed from cradle or cradle was unplugged from AC power too soon.	Ensure cradle is receiving power. Ensure the device is seated correctly.  The MC3300x 7000 mAh PowerPrecision+ extended battery charges from 0% to 90% in less than 5.2 hours at room temperature.  The MC33XX 5200 mAh PowerPrecision+ high capacity battery charges from 0% to 90% in less than 3.8 hours at room temperature.  The MC33XX 2740 mAh PowerPrecision+ standard battery charges from 0% to 90% in less than 2.2 hours at room temperature.
	Battery is faulty.	Verify that other batteries charge properly. If so, replace the faulty battery.
	The device is not fully seated in the cradle.	Remove and re-insert the device into the cradle, ensuring it is firmly seated.
	Extreme battery temperature.	Battery does not charge if ambient temperature is below 0 °C (32 °F) or above 40 °C (104 °F).
Spare battery is not charging.	Battery not fully seated in charging slot.	Remove and re-insert the spare battery into the cradle, ensuring it is correctly seated.
	Battery inserted incorrectly.	Ensure the contacts are facing down and toward the back of the cradle.
During data communication, no data was transmitted, or transmitted data was incomplete.	Device removed from cradle during communication.	Replace device in cradle and retransmit.
	Incorrect cable configuration.	See the system administrator.
	Communication software is not installed or configured properly.	See the system administrator.

## 5-Slot Charge Only ShareCradle

**Table 16** Troubleshooting the 5-Slot Charge Only ShareCradle

Problem	Cause	Solution
Device Charge LED Indicator does not light when device inserted.	Cradle is not receiving power.	Replace the device in the cradle. Go to <b>Settings &gt; About phone &gt; Battery Information &gt; Charge Status</b> to view battery status.
	Battery is faulty.	Verify that other batteries charge properly. If so, replace the faulty battery.
	Device is not inserted correctly in the cradle.	Remove the device and reinsert it correctly. Verify charging is active. Go to <b>Settings &gt; About phone &gt; Battery Information &gt; Charge Status</b> to view battery status.
	Ambient temperature of the cradle is too warm.	Move the cradle to an area where the ambient temperature is between 0 °C (32 °F) and 35 °C (95 °F).
Device Charge LED indicator is a fast blinking red when device inserted.	Ambient temperature of the cradle is too low or too high.	Move the cradle to an area where the ambient temperature is between 0 °C (32 °F) and 35 °C (95 °F).
	Charging has gone on too long without completion (typically eight hours).	Verify that other batteries charge properly. If so, replace the faulty battery.

## 5-Slot Ethernet ShareCradle

**Table 17** Troubleshooting the 5-Slot Ethernet ShareCradle

Problem	Cause	Solution
Device Charge LED Indicator does not light when device inserted.	Cradle is not receiving power.	Replace the device in the cradle. Go to <b>Settings &gt; About phone &gt; Battery Information &gt; Charge Status</b> to view battery status.
	Battery is faulty.	Verify that other batteries charge properly. If so, replace the faulty battery.
	Device is not inserted correctly in the cradle.	Remove the device and reinsert it correctly. Verify charging is active. Go to <b>Settings &gt; About phone &gt; Battery Information &gt; Charge Status</b> to view battery status.
	Ambient temperature of the cradle is too warm.	Move the cradle to an area where the ambient temperature is between 0 °C (32 °F) and 35 °C (95 °F).
Device Charge LED indicator is a fast blinking red when device inserted.	Ambient temperature of the cradle is too low or too high.	Move the cradle to an area where the ambient temperature is between 0 °C (32 °F) and 35 °C (95 °F).
	Charging has gone on too long without completion (typically eight hours).	Verify that other batteries charge properly. If so, replace the faulty battery.

## 5-Slot ShareCradle with 4-Slot Battery Charger

**Table 18** Troubleshooting the 5-Slot ShareCradle with 4-Slot Battery Charger

Problem	Cause	Solution
Device Charge LED Indicator does not light when device inserted.	Cradle is not receiving power.	Replace the device in the cradle. Go to <b>Settings &gt; About phone &gt; Battery Information &gt; Charge Status</b> to view battery status.
	Battery is faulty.	Verify that other batteries charge properly. If so, replace the faulty battery.
	Device is not inserted correctly in the cradle.	Remove the device and reinsert it correctly. Verify charging is active. Go to <b>Settings &gt; About phone &gt; Battery Information &gt; Charge Status</b> to view battery status.
	Ambient temperature of the cradle is too warm.	Move the cradle to an area where the ambient temperature is between 0 °C (32 °F) and 35 °C (95 °F).

**Table 18** Troubleshooting the 5-Slot ShareCradle with 4-Slot Battery Charger (Continued)

Problem	Cause	Solution
Device Charge LED indicator is a fast blinking red when device inserted.	Ambient temperature of the cradle is too low or too high.	Move the cradle to an area where the ambient temperature is between 0 °C (32 °F) and 35 °C (95 °F).
	Charging has gone on too long without completion (typically eight hours).	Verify that other batteries charge properly. If so, replace the faulty battery.
Spare Battery Charging LED does not light when spare battery is inserted.	Spare battery not correctly seated.	Remove and re-insert the spare battery into the cradle, ensuring it is correctly seated.
Spare battery is not charging.	Battery not fully seated in charging slot.	Remove and re-insert the spare battery into the cradle, ensuring it is correctly seated.
	Battery inserted incorrectly.	Ensure the contacts are facing down and toward the back of the cradle.

## 5-Slot Ethernet ShareCradle with 4-Slot Battery Charger

**Table 19** Troubleshooting the 5-Slot Ethernet ShareCradle with 4-Slot Battery Charger

Problem	Cause	Solution
Device Charge LED Indicator does not light when device inserted.	Cradle is not receiving power.	Replace the MC3300x in the cradle. Go to <b>Settings &gt; About device &gt; Status</b> to view battery status.
	Battery is faulty.	Verify that other batteries charge properly. If so, replace the faulty battery.
	Device is not inserted correctly in the cradle.	Remove the device and reinsert it correctly. Verify charging is active. Go to <b>Settings &gt; About device &gt; Status</b> to view battery status.
	Ambient temperature of the cradle is too warm.	Move the cradle to an area where the ambient temperature is between 0 °C (32 °F) and 35 °C (95 °F).
Device Charge LED indicator is a fast blinking red when device inserted.	Ambient temperature of the cradle is too low or too high.	Move the cradle to an area where the ambient temperature is between 0 °C (32 °F) and 35 °C (95 °F).
	Charging has gone on too long without completion (typically eight hours).	Verify that other batteries charge properly. If so, replace the faulty battery.



**Table 19** Troubleshooting the 5-Slot Ethernet ShareCradle with 4-Slot Battery Charger (Continued)

Problem	Cause	Solution
Spare Battery Charging LED does not light when spare battery is inserted.	Spare battery not correctly seated.	Remove and re-insert the spare battery into the cradle, ensuring it is correctly seated.
Spare battery is not charging.	Battery not fully seated in charging slot.	Remove and re-insert the spare battery into the cradle, ensuring it is correctly seated.
	Battery inserted incorrectly.	Ensure the contacts are facing down and toward the back of the cradle.

## 4-Slot Spare Battery Charger

**Table 20** Troubleshooting the 4-Slot Spare Battery Charger

Problem	Cause	Solution
Spare Battery Charging LED does not light when spare battery is inserted.	Spare battery is not correctly seated.	Remove and re-insert the spare battery into the charging slot, ensuring it is correctly seated.
Spare Battery not charging.	Charger is not receiving power.	Ensure the power cable is connected securely to both the charger and to AC power.
	Spare battery is not correctly seated.	Remove and re-insert the battery into the cradle, ensuring it is correctly seated.
	Battery was removed from the charger or charger was unplugged from AC power too soon.	Ensure charger is receiving power. Ensure the spare battery is seated correctly.  The MC3300x 7000 mAh PowerPrecision+ extended battery charges from 0% to 90% in less than 5.2 hours at room temperature.  The MC33XX 5200 mAh PowerPrecision+ high capacity battery charges from 0% to 90% in less than 3.8 hours at room temperature.  The MC33XX 2740 mAh PowerPrecision+ standard battery charges from 0% to 90% in less than 2.2 hours at room temperature.
	Battery is faulty.	Verify that other batteries charge properly. If so, replace the faulty battery.

## 20-Slot Spare Battery Charger

**Table 21** Troubleshooting the 20-Slot Spare Battery Charger

Problem	Cause	Solution
Spare Battery Charging LED does not light when spare battery is inserted.	Spare battery is not correctly seated.	Remove and re-insert the spare battery into the charging slot, ensuring it is correctly seated.
Spare Battery not charging.	Charger is not receiving power.	Ensure the power cable is connected securely to both the charger and to AC power.
	Spare battery is not correctly seated.	Remove and re-insert the battery into the cradle, ensuring it is correctly seated.
	Battery was removed from the charger or charger was unplugged from AC power too soon.	<p>Ensure charger is receiving power. Ensure the spare battery is seated correctly.</p> <p>The MC3300x 7000 mAh PowerPrecision+ extended battery charges from 0% to 90% in less than 5.2 hours at room temperature.</p> <p>The MC33XX 5200 mAh PowerPrecision+ high capacity battery charges from 0% to 90% in less than 3.8 hours at room temperature.</p> <p>The MC33XX 2740 mAh PowerPrecision+ standard battery charges from 0% to 90% in less than 2.2 hours at room temperature.</p>
	Battery is faulty.	Verify that other batteries charge properly. If so, replace the faulty battery.

## USB Charge Cable

**Table 22** Troubleshooting the USB Charge Cable

Symptom	Possible Cause	Action
Device Charge LED Indicator does not light when device is attached.	Cable is not receiving power.	Ensure the power cable is connected securely to both the cable and to AC power.
	Device is not seated correctly in the cable cup.	Remove and re-insert the device into the cable cup, ensuring it is correctly seated.
Device battery is not charging.	Device was detached from cable or cable was unplugged from AC power too soon.	Ensure the cable is receiving power. Ensure device is seated correctly.  The MC3300x 7000 mAh PowerPrecision+ extended battery charges from 0% to 90% in less than 5.2 hours at room temperature.  The MC33XX 5200 mAh PowerPrecision+ high capacity battery charges from 0% to 90% in less than 3.8 hours at room temperature.  The MC33XX 2740 mAh PowerPrecision+ standard battery charges from 0% to 90% in less than 2.2 hours at room temperature.
	Battery is faulty.	Verify that other batteries charge properly. If so, replace the faulty battery.
	The device is not fully seated in the cable.	Remove and re-insert the device into the cable cup, ensuring it is correctly seated.
During data communication, no data transmits, or transmitted data was incomplete.	Cable was disconnected from MC3300x during communications.	Re-attach the cable and retransmit.
	Incorrect cable configuration.	See the system administrator.
	Communication software is not installed or configured properly.	See the system administrator.

# Technical Specifications

## Introduction

For device technical specifications, go to [www.zebra.com/support](http://www.zebra.com/support).

## Data Capture Supported Symbologies

**Table 23** Data Capture Supported Symbologies

Item	Description
1D	Chinese 2 of 5, Codabar, Code 11, Code 128, Code 39, Code 93, Discrete 2 of 5, EAN-8, EAN-13, GS1 DataBar, GS1 DataBar Expanded, GS1 DataBar Limited, Interleaved 2 of 5, Korean 2 of 5, MSI, TLC 39, Matrix 2 of 5, Trioptic, UPCA, UPCE, UPCE1, Web Code.
2D	Australian Postal, Aztec, Canadian Postal, Composite AB, Composite C, Data Matrix, DotCode, Dutch Postal, Japan Postal, Maxicode, Micro PDF, Micro QR, PDF, QR Code, UK Postal, US Planet, US Postnet, US4State, US4State FICS.

## SE965 Decode Zone

The table below lists the typical distances for selected barcode densities. The minimum element width (or “symbol density”) is the width in mils of the narrowest element (bar or space) in the symbol.

**Table 24** SE965 Decode Distances

Symbol Density/ Barcode Type	Barcode Content/ Contrast <sup>Note 1</sup>	Typical Working Ranges	
		Near	Far
5.0 mil Code 128	1234 80% MRD	1.2 in 3.05 cm	7.7 in 19.56 cm
5.0 mil Code 39	ABCDEFGH 80% MRD	1.2 in 3.05 cm	12.5 in 31.75 cm
7.5 mil Code 39	ABCDEF 80% MRD	1.1 in 2.79 cm	18.5 in 46.99 cm
10 mil Code 128	1234 80% MRD	1.2 in 3.05 cm Note 3	19.0 in 48.26 cm

## Technical Specifications

**Table 24** SE965 Decode Distances (Continued)

Symbol Density/ Barcode Type	Barcode Content/ Contrast <sup>Note 1</sup>	Typical Working Ranges	
		Near	Far
13 mil 100% UPC	012345678905 80% MRD	1.6 in 4.06 cm	27.0 in 68.58 cm
15 mil Code 128	1234 80% MRD	1.0 in 2.54 cm*	29.5 in 74.93 cm
20 mil Code 39	123 80% MRD	1.4 in 3.56 cm*	52.0 in 132.08 cm
55 mil Code 39	CD 80% MRD	3.4 in 8.64 cm*	100.0 in 254.0 cm
100 mil Code 39	123456 80% MRD	2.0 ft 60.96 cm*	17 ft 518.16 cm
<p>Contrast is measured as Mean Reflective Difference (MRD) at 650 nm.</p> <p>Working range specifications at temperature = 23°C, pitch=18°, roll=0°, skew=0°, photographic quality, ambient light ~150 ft-c, humidity 45-70% RH.</p> <p>* Dependent upon width of barcode.</p> <p>Distances measured from front edge of scan engine chassis.</p>			

### SE4770/SE4720 Decode Zone

The table below lists the typical distances for selected barcode densities. The minimum element width (or “symbol density”) is the width in mils of the narrowest element (bar or space) in the symbol.

**Table 25** SE4770/SE4720 Decode Distances

Symbol Density/ Barcode Type	Typical Working Ranges	
	Near	Far
3 mil Code 39	3.0 in 7.6 cm	5.8 in 14.7 cm
5 mil Code 128	2.3 in 5.8 cm	9.8 in 24.9 cm
5 mil PDF417	3.0 in 7.6 cm	7.9 in 20.1 cm
6.67 mil PDF417	2.5 in 6.4 cm	10.1 in 25.7 cm
10 mil Data Matrix	2.1 in 5.3 cm	11.0 in 27.9 cm
100% UPCA	1.6 in* 4.1 cm*	24.9 in 63.2 cm
15 mil Code 128	2.4 in* 6.1 cm*	27.8 in 70.6 cm
20.0 mil Code 39	1.6 in* 4.1 cm*	36.1 in 91.7 cm
<p>Photographic quality barcode at 18° pitch angle under 30 fcd ambient illumination.</p> <p>* Dependent upon width of barcode.</p>		

## SE4770/SE4720 Decode Zone Dark Room

The table below lists the typical distances for selected barcode densities. The minimum element width (or “symbol density”) is the width in mils of the narrowest element (bar or space) in the symbol.

**Table 26** SE4770/SE4720 Decode Distances Dark Room

Symbol Density/ Barcode Type	Typical Working Ranges	
	Near	Far
3 mil Code 39	3.0 in 7.6 cm	5.8 in 14.7 cm
5 mil Code 128	2.3 in 5.8 cm	9.8 in 24.9 cm
5 mil PDF417	3.0 in 7.6 cm	7.9 in 20.1 cm
6.67 mil PDF417	2.5 in 6.4 cm	10.1 in 25.7 cm
10 mil Data Matrix	2.1 in 5.3 cm	11.0 in 27.9 cm
100% UPCA	1.6 in* 4.1 cm*	23.2 in 58.9 cm
15 mil Code 128	2.4 in* 6.1 cm*	25.1 in 63.8 cm
20.0 mil Code 39	1.6 in* 4.1 cm*	28.2 in 71.6 cm
Photographic quality barcode at 18° pitch angle under 0.1 fcd ambient illumination.		
* Dependent upon width of barcode.		

## SE4850-ER Decode Zone

The table below lists the typical distances for selected barcode densities. The minimum element width (or “symbol density”) is the width in mils of the narrowest element (bar or space) in the symbol.

**Table 27** SE4850-ER Decode Distances

Symbol Density/ Barcode Type	Typical Working Ranges @20 Ft-Cd Minimum	
	Near	Far
10 mil Code 39	3.0 in.* 7.6 cm*	85.0 in. 215.9 cm
13 100% UPC	3.5 in. 8.9 cm	90.0 in. 228.6 cm
15 mil Code 128	6.0 in.* 15.2 cm*	100.0 in. 254.0 cm
20 mil Code 39	4.0 in.* 10.2 cm*	172.0 in. 436.9 cm
40 mil Code 39	6.0 in.* 15.2 cm*	340.0 in.** 863.6 cm**

**Table 27** SE4850-ER Decode Distances (Continued)

Symbol Density/ Barcode Type	Typical Working Ranges @20 Ft-Cd Minimum	
	Near	Far
55 mil Code 39	7.0 in.* 17.8* cm *	430.0 in.** 1092.2 cm**
100 mil Code 39 (paper)	20.0 in.* 50.8 cm*	700.0 in.** 1778.0 cm**
100 mil Code 39 (reflective)	30.0 in.* 76.2 cm*	700.0 in. 1778.0 cm
DataMatrix 10	5.0 in. 12.7 cm	45.0 in. 114.3 cm
DataMatrix 55	5.0 in. 12.7 cm	250.0 in. 635.0 cm
15 mil Code 128 (4 in. wide)	8.0 in.* 20.3 cm*	100.0 in. 254.0 cm
* Limited by width of barcode in field of view.		
** Range is reduced under low ambient light level.		

## MC3300x Accessory Technical Specifications

### MC3300x Connector Pin-Out

**Figure 59** I/O Connector

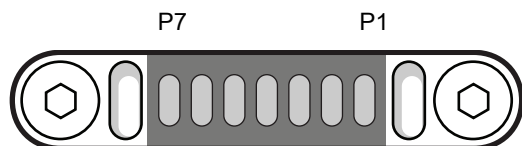

**Table 28** I/O Connector Pin-Outs

Pin	Signal Name	Description
1	Ground	Ground pin connected to the Cradle or USB Charge Cable ground.
2	USB ID	Identification signal for USI OTG communication (USB ID) which determines USB mode (host or device).
3	POWER_IN_CON (9V/1.5A or 5V/2Amax)	DC Power supply from the Cradle.
4	USB PWR	Power supply from USB Charging Cable.
5	USB D-	USB OTG data signal negative.
6	USB D+	USB OTG data signal positive.
7	GND	Ground pin connected to the Cradle or USB Charge Cable ground.

## 1-Slot USB Charge Cradle with Spare Battery Charger Technical Specifications

**Table 29** 1-Slot USB Charge Cradle with Spare Battery Charger Technical Specifications

Item	Description
Dimensions	Height: 104.5 mm (4.11 in.) Width: 99.1 mm (3.90 in.) Depth: 155.5 mm (6.12 in.)
Weight	376 g (13.26 oz)
Input Voltage	12 VDC
Power Consumption	17 watts
Operating Temperature	0°C to 40°C (32°F to 104°F)
Storage Temperature	-40°C to 70°C (-40°F to 158°F)
Charging Temperature	0°C to 40°C (32°F to 104°F)
Humidity	10% to 95% non-condensing
Drop	75 cm (30 in.) to concrete; 2 drops/side for a total of 12 drops at room temperature.
Electrostatic Discharge (ESD)	+/- 20 kV air +/- 10 kV contact +/- 10 kV indirect discharge

## 5-Slot Charge Only ShareCradle Technical Specifications

**Table 30** 5-Slot Charge Only ShareCradle Technical Specifications

Item	Description
Dimensions	Height: 123.9 mm (4.88 in.) Width: 489.0 mm (19.25 in.) Depth: 142.8 mm (5.622 in.)
Weight	1068 g (37.67 oz)
Input Voltage	12 VDC
Power Consumption	45 watts
Operating Temperature	0°C to 40°C (32°F to 104°F)
Storage Temperature	-40°C to 70°C (-40°F to 158°F)
Charging Temperature	0°C to 40°C (32°F to 104°F)
Humidity	10% to 95% non-condensing
Drop	75 cm (30 in.) to concrete; 2 drops/side for a total of 12 drops at room temperature.
Electrostatic Discharge (ESD)	+/- 20 kV air +/- 10 kV contact +/- 10 kV indirect discharge



## 5-Slot Ethernet ShareCradle Technical Specifications

**Table 31** 5-Slot Ethernet ShareCradle Technical Specifications

Item	Description
Dimensions	Height: 123.9 mm (4.88 in.) Width: 489.0 mm (19.25 in.) Depth: 142.8 mm (5.622 in.)
Weight	2070 g (37.67 oz)
Input Voltage	12 VDC
Power Consumption	47 watts
Operating Temperature	0°C to 40°C (32°F to 104°F)
Storage Temperature	-40°C to 70°C (-40°F to 158°F)
Charging Temperature	0°C to 40°C (32°F to 104°F)
Humidity	10% to 95% non-condensing
Drop	75 cm (30 in.) to concrete; 2 drops/side for a total of 12 drops at room temperature.
Electrostatic Discharge (ESD)	+/- 20 kV air +/- 10 kV contact +/- 10 kV indirect discharge

## 5-Slot Charge ShareCradle with 4-Slot Battery Charger Technical Specifications

**Table 32** 5-Slot Charge ShareCradle with 4-Slot Battery Charger Technical Specifications

Item	Description
Dimensions	Height: 123.9 mm (4.88 in.) Width: 489.0 mm (19.25 in.) Depth: 142.8 mm (5.622 in.)
Weight	2194 g (77.39 oz)
Input Voltage	12 VDC
Power Consumption	67 watts
Operating Temperature	0°C to 40°C (32°F to 104°F)
Storage Temperature	-40°C to 70°C (-40°F to 158°F)
Charging Temperature	0°C to 40°C (32°F to 104°F)

**Table 32** 5-Slot Charge ShareCradle with 4-Slot Battery Charger Technical Specifications (Continued)

Item	Description
Humidity	10% to 95% non-condensing
Drop	75 cm (30 in.) to concrete; 2 drops/side for a total of 12 drops at room temperature.
Electrostatic Discharge (ESD)	+/- 20 kV air +/- 10 kV contact +/- 10 kV indirect discharge

## 5-Slot Ethernet ShareCradle with 4-Slot Battery Charger Technical Specifications

**Table 33** 5-Slot Ethernet ShareCradle with 4-Slot Battery Charger Technical Specifications

Item	Description
Dimensions	Height: 123.9 mm (4.88 in.) Width: 489.0 mm (19.25 in.) Depth: 142.8 mm (5.622 in.)
Weight	2229 g (78.62 oz)
Input Voltage	12 VDC
Power Consumption	69 watts
Operating Temperature	0°C to 40°C (32°F to 104°F)
Storage Temperature	-40°C to 70°C (-40°F to 158°F)
Charging Temperature	0°C to 40°C (32°F to 104°F)
Humidity	10% to 95% non-condensing
Drop	75 cm (30 in.) to concrete; 2 drops/side for a total of 12 drops at room temperature.
Electrostatic Discharge (ESD)	+/- 20 kV air +/- 10 kV contact +/- 10 kV indirect discharge

## 4-Slot Spare Battery Charger Technical Specifications

**Table 34** 4-Slot Spare Battery Charger Technical Specifications

Item	Description
Dimensions	Height: 97.17 mm (3.82 in.) Width: 97.55 mm (3.84 in.) Depth: 143.0 mm (5.63 in.)
Weight	510 g (17.98 oz)
Input Voltage	12 VDC

**Table 34** 4-Slot Spare Battery Charger Technical Specifications (Continued)

Item	Description
Power Consumption	30 watts
Operating Temperature	0°C to 40°C (32°F to 104°F)
Storage Temperature	-40°C to 70°C (-40°F to 158°F)
Charging Temperature	0°C to 40°C (32°F to 104°F)
Humidity	10% to 95% non-condensing
Drop	75 cm (30 in.) to concrete; 2 drops/side for a total of 12 drops at room temperature.
Electrostatic Discharge (ESD)	+/- 20 kV air +/- 10 kV contact +/- 10 kV indirect discharge

## 20-Slot Spare Battery Charger Technical Specifications

**Table 35** 20-Slot Spare Battery Charger Technical Specifications

Item	Description
Dimensions	Height: 105.2 mm (4.14 in.) Width: 489.0 mm (19.25 in.) Depth: 142.8 mm (5.62 in.)
Weight	2620 g (92.42 oz)
Input Voltage	12 VDC
Power Consumption	99 watts
Operating Temperature	0°C to 40°C (32°F to 104°F)
Storage Temperature	-40°C to 70°C (-40°F to 158°F)
Charging Temperature	0°C to 40°C (32°F to 104°F)
Humidity	10% to 95% non-condensing
Drop	75 cm (30 in.) to concrete; 2 drops/side for a total of 12 drops at room temperature.
Electrostatic Discharge (ESD)	+/- 20 kV air +/- 10 kV contact +/- 10 kV indirect discharge

## USB Charge Cable Technical Specifications

**Table 36** USB Charge Cable Technical Specifications

Item	Description
Dimensions	Height: 32.6 mm (1.28 in.) Width: 68.2 mm (2.68 in.) Depth: 1690 mm (66.53 in.)
Weight	120 g (4.23 oz)
Input Voltage	5 VDC
Power Consumption	N/A
Operating Temperature	0°C to 50°C (32°F to 104°F)
Storage Temperature	-40°C to 70°C (-40°F to 158°F)
Charging Temperature	0°C to 40°C (32°F to 104°F)
Humidity	10% to 95% non-condensing
Drop	75 cm (30 in.) to concrete; 2 drops/side for a total of 12 drops at room temperature.
Electrostatic Discharge (ESD)	+/- 20 kV air +/- 10 kV contact +/- 10 kV indirect discharge

# Keypads

## Introduction

The MC3300x offers three types of keypad configurations: 29 key, 38 key and 47 key.







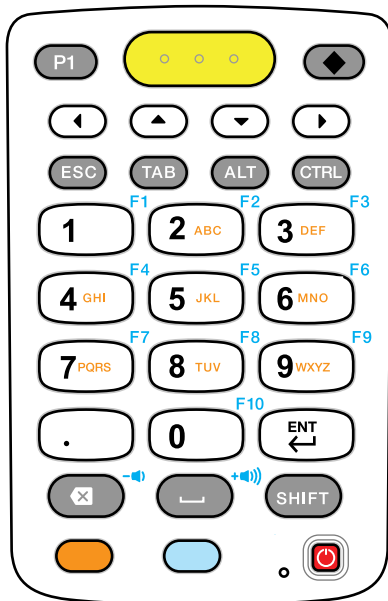

## MC3300x 29-Key Keypad

The 29-key keypad contains a Power button, application keys, scroll keys and function keys. The keypad is color-coded to indicate the alternate function key (blue) values and the alternate ALPHA key (orange) values. Note that keypad functions can be changed by an application so the mobile computer keypad may not function as described. See the tables below for key and button descriptions and keypad alternate functions.

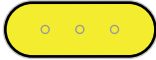
**Figure 60** 29-Key Keypad Configuration













**Table 37** 29-Key Keypad Descriptions

Key	Description
Power (red) 	Powers the mobile computer screen on and off (resume and suspend).
Program 1 	User programmable; defaults to Back button.
Diamond 	Provides a 3x3 matrix on the screen with nine additional symbols. With a single tap you can select via touch input or the keyboard, 1-9 numerical keys. Double tapping the Diamond key locks the 3x3 grid, and you can select multiple keys. Pressing the Diamond key a third time closes the 3x3 matrix.
Scan (yellow) 	Used in scanning applications, press to scan a barcode. This key has the same function as activating the side mounted scan buttons.
Scroll Keys 	Moves up, down, left, or right from one item to another. Increases/decreases specified values.
ESC 	Produces the ESC function.
TAB 	Produces the TAB function.
ALT 	Produces the ALT function.
CTRL 	Press and release the CTRL key to activate the keypad alternate CTRL functions. The <b>C</b> icon appears in the Status bar. <b>A</b> Press and release the CTRL key two times to return to the default keypad functions.

# Keypads

**Table 37** 29-Key Keypad Descriptions (Continued)

Key	Description
<p>Numeric/Alpha/Special Function</p> 	<p>Numeric, alpha or special function keys. Numeric by default. Produces a special function when the blue function key is activated. Produces alpha values when the orange alpha key is activated. In Alpha state, produces the lower case alphabetic characters on the key. Each key press produces the next alphabetic character in sequence. For example, press and release the alpha key and then press the 4 key once to produce the letter 'g'; press and release the alpha key and then press the 4 key three times to produce the letter 'i'. When the SHIFT key is pressed in Alpha state, the upper case alphabetic characters on the key are produced. For example, press and release the alpha key, press and hold the SHIFT key and then press the 4 key once to produce the letter 'G'; press and release the alpha key, press and hold the SHIFT key and then press the 4 key three times to produce the letter 'I'.</p>
<p>Period/Decimal Point</p> 	<p>Produces a period for alpha entries and a decimal point for numeric entries by default.</p>
<p>Enter</p> 	<p>Executes a selected item or function.</p>
<p>BKSP</p> 	<p>Backspace function by default. Decreases volume when the blue function key is activated.</p>
<p>SPACE</p> 	<p>Space function by default. Increases volume when the blue function key is activated.</p>
<p>Shift</p> 	<p>Press and release the SHIFT key to activate the keypad alternate SHIFT functions. The  icon appears on the Status bar. Press and release the SHIFT key again to return to the default keypad functions.</p>
<p>Orange</p> 	<p>Press the orange alpha key to access the alternate alpha characters (shown on the keypad in orange). The  icon appears on the Status bar. Press and release the orange alpha key again to return to the default keypad functions.</p>
<p>Blue</p> 	<p>Press and release the blue function key to activate the keypad alternate functions (shown on the keypad in blue). The  icon appears on the Status bar. Press and release the blue function key again to return to the default keypad functions.</p>

**Table 38** 29-key Keypad Input Modes

Key	Numeric State		Orange Key (Alpha Lowercase State)				Orange Key + Shift Key (Alpha Uppercase State)				Blue Key
		SHIFT + Key	1st Press	2nd Press	3rd Press	4th Press	1st Press	2nd Press	3rd Press	4th Press	
1	1	!	*								F1
2	2	@	a	b	c		A	B	C		F2
3	3	#	d	e	f		D	E	F		F3
4	4	\$	g	h	i		G	H	I		F4
5	5	%	j	k	l		J	K	L		F5
6	6	^	m	n	o		M	N	O		F6
7	7	&	p	q	r	s	P	Q	R	S	F7
8	8	*	t	u	v		T	U	V		F8
9	9	(	w	x	y	z	W	X	Y	Z	F9
0	0	)	0				0				F10
.	.	>	.				.				
Back-space											Decrease Volume
Space											Increase Volume
An application can change the key functions. The keypad may not function exactly as described.											

## MC3300x 38-Key Keypad





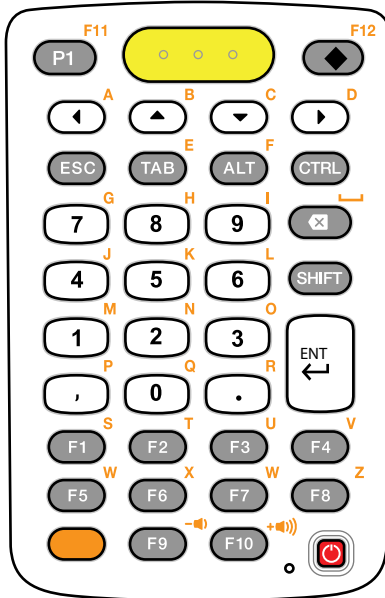

The 38-key keypad contains a Power button, application keys, scroll keys and function keys. The keypad is color-coded to indicate the alternate function key (orange) values. Note that keypad functions can be changed by an application so the mobile computer keypad may not function as described. The tables below provide key and button descriptions and keypad alternate functions.



**Figure 61** 38-Key Keypad Configuration





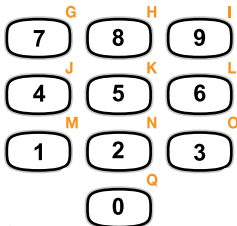





**Table 39** 38-Key Keypad Descriptions

Key	Description
Power (red) 	Powers the mobile computer screen on and off (resume and suspend).
Program 1 	User programmable; defaults to Back button.
Diamond 	Provides a 3x3 matrix on the screen with nine additional symbols. With a single tap you can select via touch input or the keyboard, 1-9 numerical keys. Double tapping the Diamond key locks the 3x3 grid, and you can select multiple keys. Pressing the Diamond key a third time closes the 3x3 matrix.
Scan (yellow) 	Used in scanning applications, press to scan a barcode. This key has the same function as activating the side mounted scan buttons.
Scroll 	Moves up, down, left, or right from one item to another.
Orange 	Press the orange alpha key to access the alternate alpha characters (shown on the keypad in orange). The  icon appears on the Status bar. Press and release the orange alpha key again to return to the default keypad functions.



# Keypads

**Table 39** 38-Key Keypad Descriptions (Continued)

Key	Description
CTRL 	Press and release the CTRL key to activate the keypad alternate CTRL functions. The <b>C</b> icon appears on the Status bar. Press and release the CTRL key again to return to the default keypad functions. Press and release the blue FUNC key and then the CTRL key to activate the ALT functions. The <b>A</b> icon appears on the Status bar. Press and release the CTRL key two times to return to the default keypad functions.
ESC 	Produces the ESC function.
TAB 	Produces the TAB function.
ALT 	Produces the ALT function.
CTRL 	Produces the CTRL function.
Numeric/Alpha/Special Function 	Press for the default numeric value. Produces alpha values when the orange alpha key is activated.
BKSP 	Backspace function by default. Decreases brightness when the blue FUNC key is activated.
Shift 	Press and release the SHIFT key to activate the keypad alternate SHIFT functions. The <b>↑</b> icon appears on the Status bar. Press and release the SHIFT key again to return to the default keypad functions.
Enter 	Executes a selected item or function.

# Keypads

**Table 39** 38-Key Keypad Descriptions (Continued)

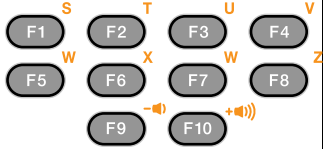
Key	Description
Period 	Produces a period for alpha entries and a decimal point for numeric entries.
Comma 	Produces a comma by default.
F1 - F10 	Special function keys by default.

**Table 40** 38-key Keypad Input Modes

Key	Normal	SHIFT + Key	Orange + Key	Orange + SHIFT + Key
P1			F11	
Diamond			F12	
Left Arrow			a	A
Up Arrow			b	B
Down Arrow			c	C
Right Arrow			d	D
ESC				
TAB			e	E
ALT			f	F
CTRL				
7	7	&	g	G
8	8	*	h	H
9	9	(	l	l
BKSP	Backspace	Backspace	Space	Space
4	4	\$	j	J
5	5	%	k	K
6	6	^	l	L
1	1	!	m	M
2	2	@	n	N
3	3	#	o	O
,	,	<	p	P
0	0	)	q	Q

**Table 40** 38-key Keypad Input Modes (Continued)

Key	Normal	SHIFT + Key	Orange + Key	Orange + SHIFT + Key
.	.	>	r	R
F1			s	S
F2			t	T
F3			u	U
F4			v	V
F5			w	W
F6			x	X
F7			y	Y
F8			z	Z
F9			Decrease Volume	
F10			Increase Volume	

An application can change the key functions. The keypad may not function exactly as described.







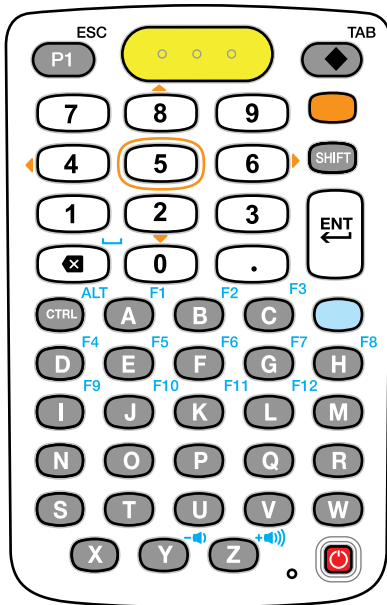





## MC3300x 47-Key Keypad

The 47-key keypad contains a Power button, application keys, scroll keys and function keys. The keypad is color-coded to indicate the alternate function key (blue) values. Note, that keypad functions can be changed by an application so the mobile computer keypad may not function as described. The tables below provide key and button descriptions and keypad alternate functions.

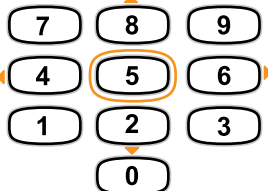
**Figure 62** 47-Key Keypad Configuration



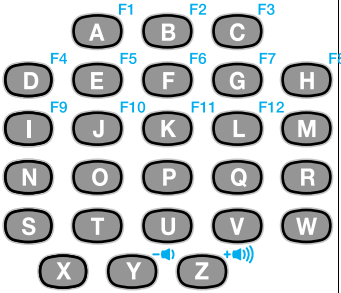



**Table 41** 47-Key Keypad Descriptions

Key	Description
Power (red) 	Powers the mobile computer screen on and off (resume and suspend).
Program 1/ESC 	User programmable; defaults to Back button. With the Shift key activated, P1 produces the ESC function.
Diamond/TAB 	Provides a 3x3 matrix on the screen with nine additional symbols. With a single tap you can select via touch input or the keyboard, 1-9 numerical keys. Double tapping the Diamond key locks the 3x3 grid, and you can select multiple keys. Pressing the Diamond key a third time closes the 3x3 matrix.  With the Shift key activated, Diamond produces the TAB function.
Scan (yellow) 	Used in scanning applications, press to scan a barcode. This key has the same function as activating the side mounted scan buttons on the MC3300x-R or MC3300x-S.
Orange 	Press the orange key to access the alternate navigation and selection functions. The  icon appears on the Status bar. Press and release the orange key again to return to the default keypad functions.
Numeric/Scroll/Select 	Numeric, scroll, select keys. Numeric by default. With the orange key activated, the 2, 4, 6, and 8 keys produce scroll functions and the 5 key produces a select function.
Shift 	Press and release the SHIFT key to momentarily activate the keypad alternate SHIFT functions. The  icon appears on the Status bar. Press and release the SHIFT key a second time to lock the keypad into the Shift-Lock mode. The  icon appears on the Status bar. Press and release the SHIFT key again to return to the default keypad functions.
Enter 	Executes a selected item or function.
Backspace/Space 	Backspace function by default. Produces the Space function when the blue function key is activated.

# Keypads

**Table 41** 47-Key Keypad Descriptions (Continued)

Key	Description
Period 	Produces a period for alpha entries and a decimal point for numeric entries.
CTRL 	Press and release the CTRL key to activate the keypad alternate CTRL functions. The <b>C</b> icon appears on the Status bar. Press and release the CTRL key again to return to the default keypad functions. Press and release the blue function key and then the CTRL key to activate the ALT functions. The <b>A</b> icon appears on the Status bar. Press and release the CTRL key two times to return to the default keypad functions.
Alpha/Special Function 	Alpha by default. Special function by default when the blue function key is activated.
Blue 	Press and release the blue function key to activate the keypad alternate functions (shown on the keypad in blue). The  icon appears on the Status bar. Press and release the blue function key again to return to the default keypad functions.

**Table 42** 47-key Keypad Input Modes

Key	Normal	SHIFT + Key	Blue + Key	Orange + Key
A	a	A	F1	
B	b	B	F2	
C	c	C	F3	
D	d	D	F4	
E	e	E	F5	
F	f	F	F6	
G	g	G	F7	
H	h	H	F8	
I	l	I	F9	
J	j	J	F10	
K	k	K	F11	
L	l	L	F12	
M	m	M		

## Keypads

**Table 42** 47-key Keypad Input Modes (Continued)

Key	Normal	SHIFT + Key	Blue + Key	Orange + Key
N	n	N		
O	o	O		
P	p	P		
Q	q	Q		
R	r	R		
S	s	S		
T	t	T		
U	u	U		
V	v	V		
W	w	W		
X	x	X		
Y	y	Y	Decrease Volume	
Z	z	Z	Increase Volume	
Backspace	Backspace	Delete	Space	
1	1	!		
2	2	@		Down Arrow
3	3	#		
4	4	\$		Left Arrow
5	5	%		
6	6	^		Right Arrow
7	7	&		
8	8	*		Up Arrow
9	9	(		
0	0	)		
.		>		
P1			ESC	
Diamond			TAB	
CTRL			ALT	
An application can change the key functions. The keypad may not function exactly as described.				

# Index

## Numerics

1-slot USB charge cradle	114
20-slot spare battery charger	135
4-slot spare battery charger	133
5-slot charge only cradle	117
5-slot cradle with 4-slot battery charger	125
5-slot ethernet cradle	119
5-slot ethernet cradle with 4-slot battery charger	127

## A

accessories for MC3300x	106
adaptive frequency hopping	98
approved cleanser	176
apps	
accessing	31, 57
camera	60
datawedge demonstration	63
PTT Express	65
RxLogger	69
RxLogger Utility	70

## B

barcode capture	
imager	73
laser scanner	74
barcode scanning	
integrated imager	71
battery	
low battery notification	43
monitor usage	42
battery management	42
battery level	42
battery present status	42
battery optimization	42
battery safety guidelines	175
bluetooth	93, 98
change name	101
PIN	99
power states	100

profiles	99
security	99

## C

camera	56, 60
photo settings	62
recording videos	61
taking photos	60
camera settings	62
cast	102
change bluetooth name	101
charge only adapter	141
charging spare batteries	31
charging temperature	30
cleaning	176, 177
battery connectors	178
camera and exit window	178
cradle connectors	178
display	178
frequency	178
housing	178
instructions	176
materials	177
cleaning instructions	177
cradle	
connector cleaning	178

## D

data capture	
integrated imager	71
datawedge	90
decoders	90
disabling	90
enable	90
datawedge demonstration	63
decoders	90
disconnect host computer	44
display settings	45
DS3678	
pairing	88



# Table of Contents

pairing using Bluetooth HID	89		
pairing using simple serial interface	88		
scanning	82		
<b>E</b>			
EAP	93		
<b>F</b>			
fabric holster	148		
features			
MC3300x-G	19		
MC3300x-R	21		
MC3300x-S	23		
file transfer	44		
font size	46		
<b>G</b>			
general sound setting	47		
<b>H</b>			
hard reset	179		
harmful ingredients	177		
home screen	36		
rotation	37		
hot swap mode/backup power	31		
<b>I</b>			
install microSD card	25		
installing battery - MC3300x-G	27		
installing battery - MC3300x-R/S	28		
integrated imager			
barcode scanning	71		
data capture	71		
operational modes	71		
interactive sensor technology	43		
<b>K</b>			
keyboards	51		
additional character tab	52		
alpha tab	52		
configuration	51		
editing text	52		
numeric tab	52		
keypad			
29-key	198		
38-key	201		
47-key	205		
<b>L</b>			
laser scanner	71		
lock screen notifications	54		
low battery notification	43		
<b>M</b>			
maintenance	179		
battery safety guidelines	175		
clean battery connectors	178		
clean camera and exit window	178		
clean cradle connectors	178		
clean display	178		
clean housing	178		
cleaning frequency	178		
cleaning instructions	176		
cleaning materials required	177		
device cleaning instructions	177		
harmful ingredients	177		
maintaining the device	175		
special cleaning notes	177		
managing notifications	40		
MC3300x-G			
features	19		
installing battery	27		
replacing battery	32		
MC3300x-R			
features	21		
MC3300x-R/S			
installing battery	28		
MC3300x-S			
features	23		
MC33XX-R			
rotating scan turret	21		
monitor battery usage	42		
<b>N</b>			
near field communication	93		
near field communications	102		
NFC	102		
sharing information	104		
notational conventions	15		
notification icons	38		
notifications			
lock screen	54		
managing	40		
<b>O</b>			
operational modes			
decode mode	71		
pick list mode	71		

# Table of Contents

<b>P</b>	
pairing	
DS3678	88
RS507/RS6000 hands-free imager	84
using Bluetooth HID (RS507/RS6000)	87
using Bluetooth HID(DS3678)	89
using simple serial interface (DS3678)	88
using simple serial interface(RS507/RS6000)	86
photo transfer	44
photos	
camera settings	62
taking	60
PTT Express	
disabling communication	68
enabling communication	67
notification icons	66
private response	67
talk groups	67
user interface	65
Voice Client	65
PTT-Express	
PTT communication	67
<b>Q</b>	
quick access panel	40
quick settings	
edit icons	42
<b>R</b>	
remove wi-fi	94
replacement hand strap	
MC3300x-G	157
replacing battery - MC3300x-G	32
reset device	179
hard reset	179
soft reset	179
rigid holster	146
rotating scan turret	21
RS507	
scanning	74, 78
RS507 scanning	75, 78, 80, 81, 82, 84
RS507/RS6000	
pairing	84
pairing using Bluetooth HID	87
pairing using simple serial interface	86
RS6000 scanning	77
rubber boot - MC3300x-G	143
rubber boot - MC3300x-R	144
rubber boot - MC3300x-S	145
RxLogger	69
configuration	69
configuration file	69
disable logging	69
enable logging	69
extract log files	69
RxLogger Utility	70
<b>S</b>	
scanning	
considerations	72
DS3678	82
RS507	74, 78
screen font size	46
security	93
setting	
camera	62
settings	45
accessing	45
camera photos	62
display	45
general sound	47
setup	25
sharing information using NFC	104
soft reset	179
software version	17
software versions	17
status bar	37
<b>T</b>	
transferring files using USB	43
<b>U</b>	
un-powered forklift mount	155
USB	43
USB charge cable	137
<b>V</b>	
videos	
recording	61
<b>W</b>	
WEP	93
Wi-Fi direct	98
wireless local area network	93
WLAN	93
WPA	93

