



DMS Cloud

User Manual

Copyright

Copyright ©2022 BenQ Corporation. All rights reserved. No part of this publication may be reproduced, transmitted, transcribed, stored in a retrieval system or translated into any language or computer language, in any form or by any means, electronic, mechanical, magnetic, optical, chemical, manual or otherwise, without the prior written permission of BenQ Corporation.

All other logos, products, or company names mentioned in this manual may be the registered trademarks or copyrights of their respective companies, and are used for informational purposes only.

Disclaimer

BenQ Corporation makes no representations or warranties, either expressed or implied, with respect to the contents hereof and specifically disclaims any warranties, merchantability or fitness for any particular purpose. Further, BenQ Corporation reserves the right to revise this publication and to make changes from time to time in the contents hereof without obligation of BenQ Corporation to notify any person of such revision or changes.

This user manual aims to provide the most updated and accurate information to customers, and thus all contents may be modified from time to time without prior notice. Please visit <http://www.benq.com> for the latest version of this manual.

The illustrations and the screens shown in this guide are for your reference. The actual content and available functions may vary by the connected devices and the product supplied for your region.

Table of Contents

Copyright	i
Introduction	1
System requirements	1
Initial Setup	2
Configuring Settings (For Projectors Only).....	2
Using DMS Cloud	3
Logging in to DMS Cloud.....	3
The DMS Cloud Main Page.....	4
Switching Companies	6
Adding Devices	7
Uploading Device Information.....	7
Adding Devices in DMS Cloud.....	7
Adding Devices via the BenQ DMS Tool App.....	9
Managing Your Devices.....	10
Creating Groups.....	10
Renaming a Device	12
Deleting a Device	12
Device Tree Icons	13
Status Icons	13
Monitoring Your Devices	14
The Device Panel.....	14
The Information Tab.....	16
Controlling Your Devices.....	18
The Control Tab (Single BenQ Display)	19
The Control Tab (Single BenQ Projector).....	20
The Control Tab (Single Non-BenQ Projector)	21
The Control Tab (Multiple Devices).....	21
Quick Settings	22
Direct Command Input (for Displays Only)	23
Scheduling Your Device to Automatically Power On/Off.....	27
Editing a Scheduled Power On/Off.....	29
Resetting (Deleting) a Scheduled Power On/Off.....	29

The App List Tab	30
Viewing Installed Apps	30
Installing an App	31
Uninstalling an App.....	33
Updating an App.....	34
Updating the Android Operating System on your Device.....	35
Changing Your DMS Cloud Password	39
Other Functions	40
Viewing DMS Cloud Activity Logs	40
Viewing Usage Data for Devices	40
Software Management.....	42
Adding or Updating an App to the DMS Cloud Database.....	44
Deleting Apps from the DMS Cloud Database.....	45
Installing Apps onto a Device from the App List	46
Editing App Descriptions	47
Accessing Older Versions of an App.....	47
About DMS Cloud	48
Troubleshooting	49
Network Whitelist.....	50

Introduction

DMS Cloud is a cloud-based tool for computers that enables remote and centralized management of multiple digital projectors and/or displays by IT administrators/technicians via the cloud. DMS Cloud's management capabilities include the ability to remotely monitor, control, and configure projectors/displays individually or as groups.

DMS Cloud is designed for use in settings where multiple devices are spread out across various spaces and, as a result, needs a cloud-based portal to manage and monitor each device remotely, for example a multi-floored office building or a school with multiple classrooms.

System requirements

To use DMS Cloud, a computer must meet the following minimum hardware and software requirements.

CPU	1.8GHz
Free memory	8 GB
Display Resolution	1024x768 or higher
Browser	<ul style="list-style-type: none">• Chrome version 75.0.3770 or higher• Firefox version 70.0  DMS Cloud does not support the use of Microsoft Internet Explorer, Microsoft Edge or any other web browser.
Other	Internet access

For a device to support management via DMS Cloud, the device must feature the following item:

- An RJ-45 Ethernet port with LAN control functionality



DMS Cloud also supports non-BenQ projectors that utilize the PJLink protocol.

Initial Setup

Before you can properly use DMS Cloud to manage your device(s), the following setup procedures must be completed:

- Connect the devices to a network with Internet access
- Ensure the computer using DMS Cloud is connected to a network with Internet access
- Configure device settings

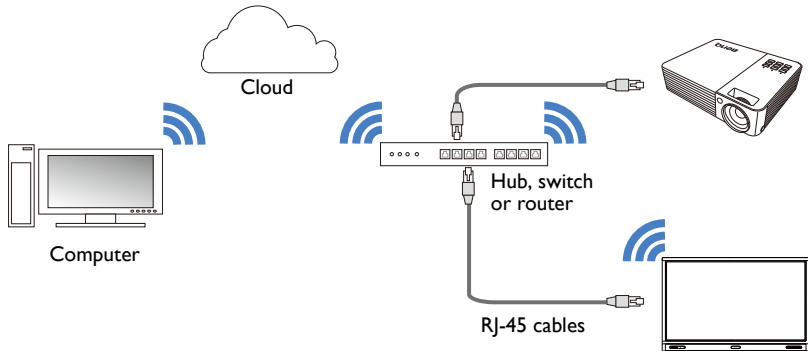

- For details on the location of ports and connectors, please refer to the documentations for the computer and devices.
- [For Projectors only]: Ensure that the IP address for each projector is properly set and that the IP address is shown on the OSD menu of the projector. You may need to contact your network administrator for assistance in setting the projectors' IP addresses.

Configuring Settings (For Projectors Only)

For DMS Cloud to be able to access a projector while it is in standby mode, the settings on the projector must be pre-configured by your IT administrator to ensure that the **Enable Network Standby Mode** setting in the projector's setting menu is set to **On**.



- For BenQ projectors, this setting can be found in either the **System > Standby Settings > Network** or **Advanced > Standby Settings > Network** menu.
- For non-BenQ projectors, refer to the documentation for the device.
- For certain projectors, "Monitor Out" should be enabled in the standby settings menu to ensure that the projector is accessible while in standby mode. Please refer to your projector's user manual for details.

Using DMS Cloud

Logging in to DMS Cloud

Once you have completed the steps described in [Initial Setup](#), you can begin using DMS Cloud by opening the following URL in your browser:

<http://dms.benq.com>

After opening the DMS Cloud website, log in using the account ID/E-mail and password provided by your system administrator.

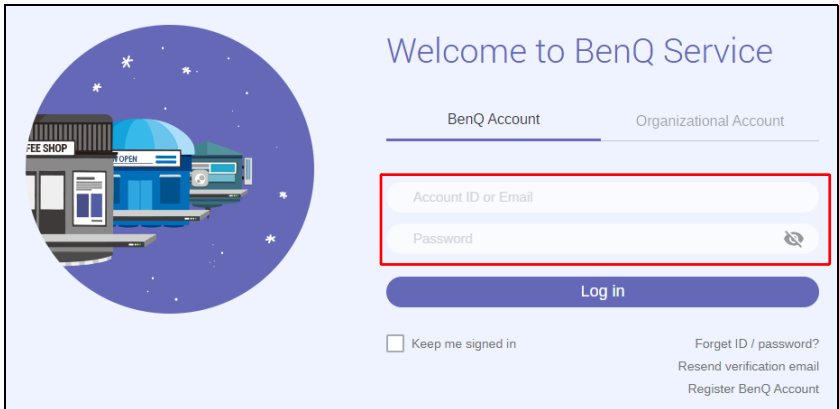

Welcome to BenQ Service

BenQ Account Organizational Account

Account ID or Email

Password

Log in

Keep me signed in

[Forget ID / password?](#)
[Resend verification email](#)
[Register BenQ Account](#)





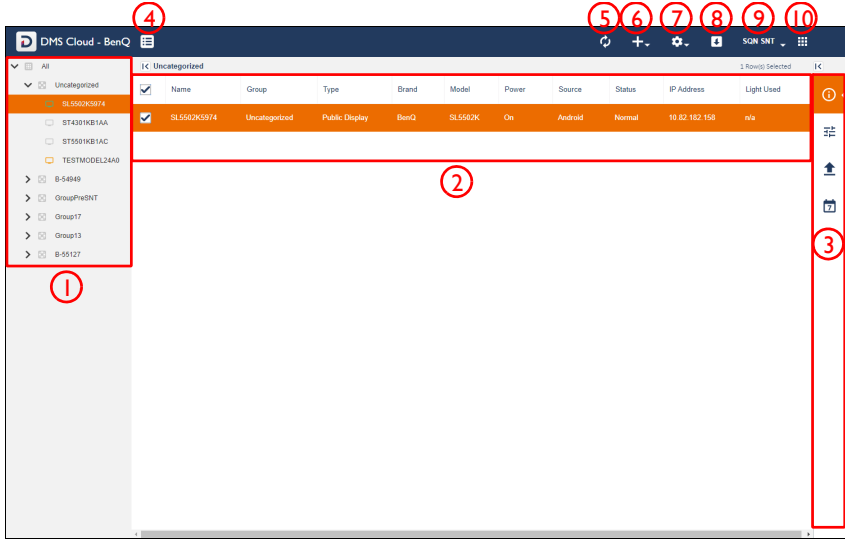







The DMS Cloud Main Page

Once you have logged in, the main page for DMS Cloud will be shown. The following items are featured on the DMS Cloud main page.



The illustrations and the screens shown in this guide are for your reference. The actual content and available functions may vary by the connected devices and the product supplied for your region.

No.	Item	Description
1	Device Tree	Shows all the devices and device groups managed by DMS Cloud in a tree-view structure. See Adding Devices for more information on the adding devices to the device tree. See Device Tree Icons for more information on the status icons shown in the device tree.
2	Device Panel	Shows status information for the device(s) or device groups selected in the device tree. See The Device Panel for more information on the various fields featured in the device panel.

No.	Item	Description
3	Action Panel	<p>Provides various tools that allow you to further manage/monitor devices and device groups, including the information tab () , control tab () , and the schedule tab () .</p> <p>For certain devices, an apps list tab () is also available in the Action Panel.</p> <p>See The Information Tab, Controlling Your Devices, Scheduling Your Device to Automatically Power On/Off, or The App List Tab for more information on each tab in the Action Panel.</p> <p> The action panel only appears when a device or device group is selected in the device panel. The information tab only appears when a single device is selected in the device panel.</p>
4	Select Company 	<p>Click to switch over to a different company's set of devices to be managed by the same DMS Cloud account.</p> <p>See Switching Companies for more information.</p> <p> Only accounts which have activated multi-company functionality will be able to access this feature.</p>
5	Refresh 	<p>Click to refresh the status of the devices shown on the main page.</p> <p> DMS Cloud will automatically refresh the device status after a given interval of time. The refresh button is to allow users to get the most up-to-date information at any given time.</p>
6	Add 	<p>Click to add devices to the DMS Cloud management system, or to create groups for better organization in the device tree.</p> <p>See Adding Devices for more information on adding devices and device groups.</p>
7	Settings 	<p>Click to access various system management functions for administrators, such as viewing device status reports/logs, and more.</p> <p>See Other Functions for more information on the system management functions available for the Settings button.</p>
8	Software Management 	<p>Click to open the Software Management interface to manage the database of apps available in DMS Cloud.</p> <p>See Software Management for more information on the Software Management interface.</p>
9	User	<p>Click to edit selected account information and/or change your login password.</p> <p>See Changing Your DMS Cloud Password for more information on setting up a login password.</p>

No.	Item	Description
10	 Other Services	Click to switch to another BenQ cloud-based service.

Switching Companies

For System Integrators (SI) who may be responsible for the operations of more than one company's system, the Select Company button  on the top toolbar allows the user to easily switch between the companies administered by the same login account.

To switch companies:

1. Click the Select Company button.

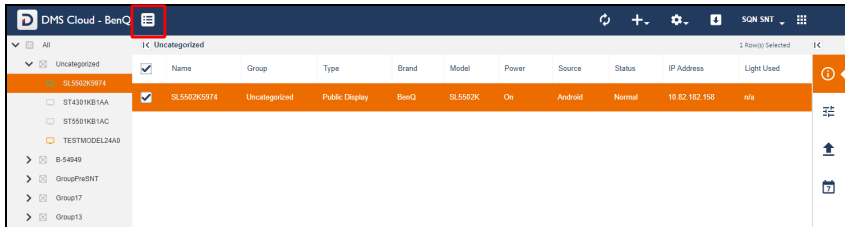

2. Select the company you want to switch to.

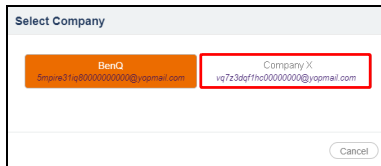

- In the **Add new device** pop-up window, choose one of the following options:
 - If you uploaded the device's information using the DMS Client app or DMS Local's Agent Mode, select **Add via Unique ID** and then enter the **Unique ID** or **Temporary Pairing Code** provided for the device.

Add new device

Pick an add method
Please select a way below for adding new device.

Add via Unique ID

Import new device from a file

Next Cancel

- If you exported the device's information in DMS Local, select **Import new device from a file** and then select the exported file.

Add new device

Pick an add method
Please select a way below for adding new device.

Add via Unique ID

Import new device from a file

Next Cancel

- Once the list of devices appear, you can choose from the following options:

Add new device (Local agent) Total found: 3 | Valid: 3

Selected device(s) to be added
Checked device(s) will be added. Modify Name/Description fields if needed.

Local agent name: B-54802

<input checked="" type="checkbox"/>	Unique ID ▲	Model Name	Name b	Description c
<input checked="" type="checkbox"/>	MDA6MTg6MjM6NTA6RDI6NDI=	SX751	SX751D27B	
<input checked="" type="checkbox"/>	QjA6QzU6Q0E6NzA6MDlBQTQ=	ST650K	ST650K02A4	
<input checked="" type="checkbox"/>	UEQxMUowMDAvMTIwMA==	EW800ST	EW800ST1200	

a

Back Add Cancel

- Check the box next to the device(s) you want to add or check the select all box to select all the devices on the list.
- Enter a name for the device in the **Name** field. If you do not enter a name in the field, the default name for the device (the device's full model name) will be used.
- Enter a description for the display in the **Description** field to provide more detailed information about the device to be viewed in the Information Tab.



The **Name** and **Description** used in DMS Local will not be carried over to DMS Cloud.

Managing Your Devices

Once you have added the device(s) into the DMS Cloud system, the devices will appear in the device tree on the main page. Initially all newly added device will be listed in the **Uncategorized** group of devices.

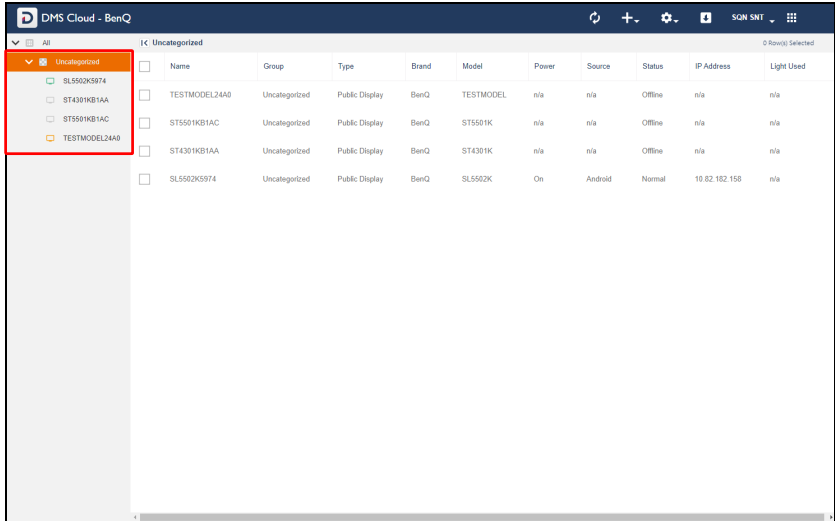

To help you better organize and identify your devices, DMS Cloud features the following options:

- Create Device Groups
- Rename Devices
- Delete Devices

Creating Groups

In instances where DMS Cloud is used to manage a large number of devices spread out over various spaces, organizing devices into groups may be useful to manage your devices. To create a device group, follow the steps below:

1. Select the **All** category in the device tree, then click the add button (**+ -**) and select **Add Group**.

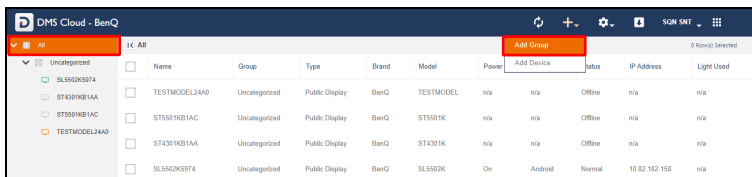

- To create a sub-group, select the group in the device tree that you want to create the sub-group in and then follow the steps in this section.
- A group cannot be created within the **Uncategorized** group in the device tree.

- In the **Add New Group** pop-up window, enter a name for the group and then click **Add**.

Add New Group

Please enter the name of the new group.

East Building

Add
Cancel

- Once the new group has been created, it will appear in the device tree. You can begin adding devices to the group by selecting the respective device in the device tree, dragging it into the group, and then confirming the addition.

Name	Group	Type	Brand	Model	Power	Source	Status	IP Address	Light Used
TESTMODEL2440	Uncategorized	Public Display	BenQ	TESTMODEL	n/a	n/a	Offline	n/a	n/a
ST5501KB1AC	Uncategorized	Public Display	BenQ	ST5501K	n/a	n/a	Offline	n/a	n/a
ST4301KB1AA	Uncategorized	Public Display	BenQ	ST4301K	n/a	n/a	Offline	n/a	n/a
SL5502K5974	Uncategorized	Public Display	BenQ	SL5502K	On	Android	Normal	10.82.182.158	n/a



A device can only be part of one group at a time.

- To rename a group, right-click the group you want to rename and select **Rename**.

Renaming a Device

As described in [Adding Devices](#), the **Add new device** menu allows you to rename a device while adding it to DMS Cloud. In instances where a device is not renamed while it is being added to DMS Cloud, the device will be added using its default name (the IP address for the device followed by the device's model number). You can then rename a device to a more easily identifiable name at any time by following the steps below:

1. Right-click on the device you want to rename in the device tree, and then select **Rename**.

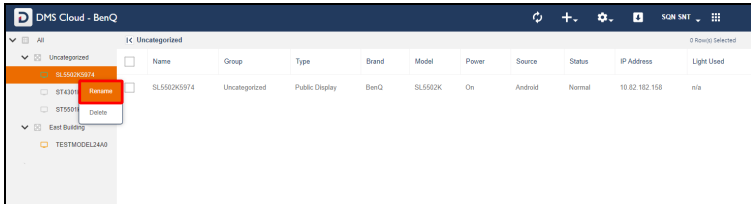

2. In the **Rename** menu, enter the new name and then click **Rename**.

Rename

Please enter the new name for "ST4301KB1AA"

Deleting a Device

To delete a device from the device tree, right-click on the device you want to delete in the device tree, and then select **Delete**.

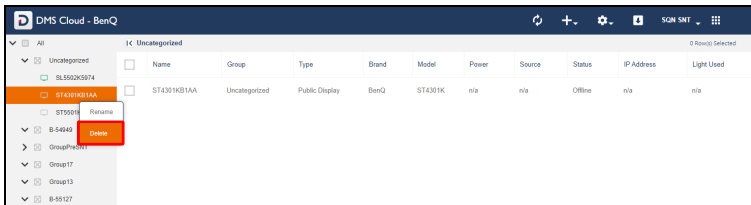

Deleting a device not only removes the device from your device tree, but also deletes the device listing from the entire DMS Cloud database, preventing other users from accessing the device. Before deleting a device, ensure that the device is not used by any other user in your network.

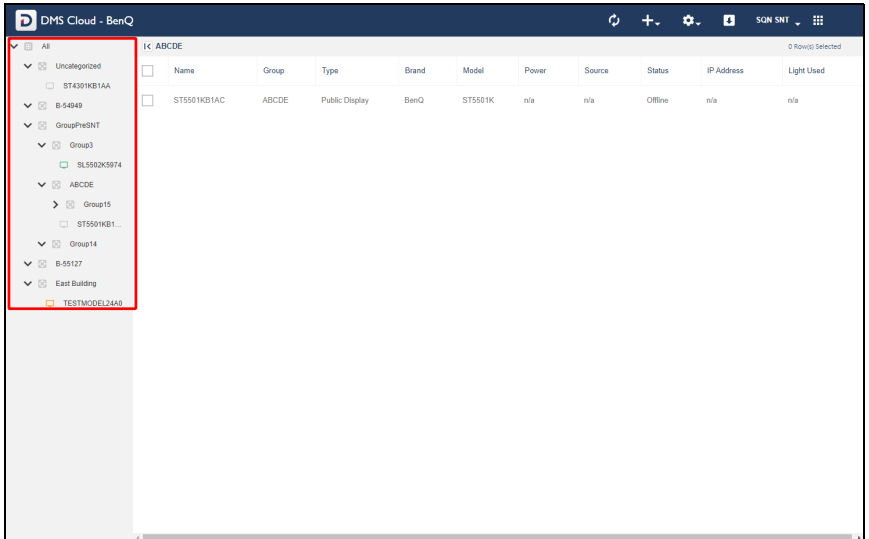

Device Tree Icons

As described earlier, the device tree lists all devices managed by DMS Cloud in a hierarchical, tree-view structure. The device tree also shows various icons that allow you to quickly view the current status of all devices and whether or not there are any errors causing the device to malfunction.



Status Icons

Icons that indicate the current status of each device appears to the left of the device's name in the device tree. Icons that indicate errors for a device appears to the right of the device's name in the device tree. The table below provides descriptions of each icon.

Icon	Status	Description
	Online	The device is powered on.
	Standby	The device is in standby mode.
	Offline	The device is undetected by DMS Cloud. This status usually indicates a problem with the device's connection to the network or with the network itself, in such instances it is suggested that you check the device's connection.

Monitoring Your Devices

Beyond the status icons shown in the device tree, DMS Cloud features the device panel to monitor the status of your device and the information tab to view detailed information for each device, both of which are described in the sections below.

The Device Panel

When either an individual device or a device group is selected in the device tree, the device panel of the DMS Cloud main page will show in-depth status information for the selected device or the devices in the selected group.

Name	Group	Type	Brand	Model	Power	Source	Status	IP Address	Light Used
TESTMODEL24A0	Uncategorized	Public Display	BenQ	TESTMODEL	n/a	n/a	Offline	n/a	n/a
ST4301KB1AA	Uncategorized	Public Display	BenQ	ST4301K	n/a	n/a	Offline	n/a	n/a
SL550K5974	Uncategorized	Public Display	BenQ	SL550K	On	Android	Normal	10.02.102.158	n/a

The table below describes the information featured in the device panel.

Item	Description
Name	Name of the device.
Group	Group that the device belongs to.
Type	Type of device, projector, or public display.
Brand	Brand of the device.
Model	Model name for device.
Power	Current power status of the device. See Power for definitions of the various power statuses.
Source	Current signal source for the device.
Status	Current operating status of the device. See Status for definitions of the various statuses.
IP Address	IP address for the device.

Item	Description
Light Used*	The cumulative hours the light has been used.
Light 2 Used*	The cumulative hours the second light has been used.
*For projectors only	

Power

The **Power** column in the device panel shows the current power status of the device(s). The following table defines the various power statuses available in the device panel.

Power Status	Description
On	The device is powered on.
Standby	The device is in standby mode.
N/A	The device is undetected by DMS Cloud. This status usually indicates a problem with the device's connection to the network or with the network itself, in such instances it is suggested that you check the device's connection.

Status

The **Status** column in the device panel shows the current operating status of the device(s). The following table defines the various statuses available in the device panel.

Status	Description
Normal	The device is operating normally.
N/A	<ul style="list-style-type: none"> • The device does not support the transmission of error messages over the network. • The device is in standby mode.
Offline	The device is undetected by DMS Cloud. This status usually indicates a problem with the device's connection to the network or with the network itself, in such instances it is suggested that you check the device's connection.

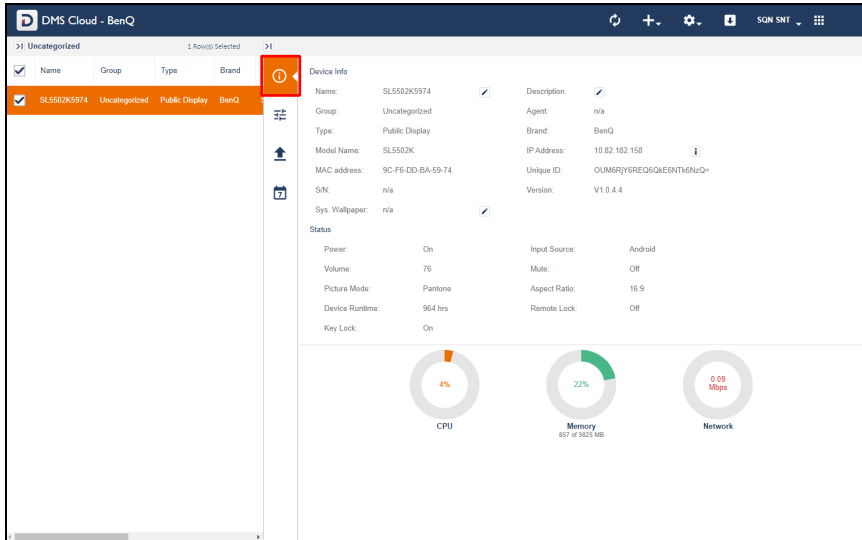

The Information Tab

The information tab of DMS Cloud shows detailed information for a device and is only accessible when a single device is selected in the device panel and the information button in the action panel is clicked.



The screenshot displays the DMS Cloud interface. On the left, a table lists devices under the 'Uncategorized' group. The selected device is 'SL5502K5974', a 'Public Display' by 'BenQ'. The main panel shows detailed information for this device, including its name, description, group, agent, type, brand, model name, IP address, MAC address, unique ID, serial number, version, system wallpaper, status, power, volume, picture mode, device runtime, key lock, input source, mute, aspect ratio, and remote lock. At the bottom, three circular gauges show resource usage: CPU at 4%, Memory at 22%, and Network at 0.09 Mbps.

The table below describes the detailed information featured in the information tab.

Item	Description
Name	Name of the device. Click the edit button  to change the device name.
Description	Brief description of the device. Click the edit button  to change the description.
Group	Group that the device belongs to.
Agent	Agent ID for user that added the device via DMS Local Agent Mode.
Type¹	Describes the type of device/display (e.g. public display or projector).
Brand	Brand of the device.
Model Name	Model name for device.
IP Address	IP address for the device.
MAC Address	MAC address for the device.
Unique ID	Unique ID number for the device added via the DMS Client app or DMS Local Agent Mode.
S/N	Serial number for the device.
Version	Indicates the firmware version installed on the display.

Item	Description
Sys. Wallpaper³	Click the edit button  to select an image file as the pre-login wallpaper for the device.
Power	Current power status of the device. See Power for definitions of the various power statuses.
Input Source	Current signal source for the device.
Blank²	Indicates whether the blank screen function for the device is on or off.
Volume	Current volume level for the device.
Mute	Current mute status for the device.
Picture Mode	Current picture mode setting for the device.
Light Mode²	Current light mode setting for the projector.
Aspect Ratio	Current aspect ratio for the device.
Device Runtime¹	Current operating time for the display (in hours).
Remote Lock¹	Current remote control lock status for the display.
Key Lock¹	Current keypad lock status for the display.
Thermal Level²	Current thermal level for the projector.
Light Used²	The cumulative hours the light has been used.
Light 2 Used²	The cumulative hours the 2nd light has been used.
High Altitude²	Indicates whether the high altitude configuration is on or off.
Filter Usage²	Current filter used for the projector.
Hardware Status	Indicates the usage/performance levels for the device's CPU, memory, and network connection.
¹ For displays only	
² For projectors only	
³ For select models only	



- The fields displayed in the information tab may vary depending on the model selected.
- If the projector does not support the transmission of a certain field's information over the network, the field will show "N/A".
- For non-BenQ projectors, only the following fields will display information: **Name**, **Group**, **Brand**, **Model**, **Power**, and **IP Address**. All other fields will show "N/A"

Controlling Your Devices

The control tab of DMS Cloud features a panel of functions that allows you to control an individual device or an entire group when they are selected in the device panel and the control button in the action panel is clicked. The control tab also allows users to enter and save control command codes using the BenQ protocol (for BenQ devices), the PJLink protocol or self-input via the protocol port (for non-BenQ projectors) to create custom controls for the device.

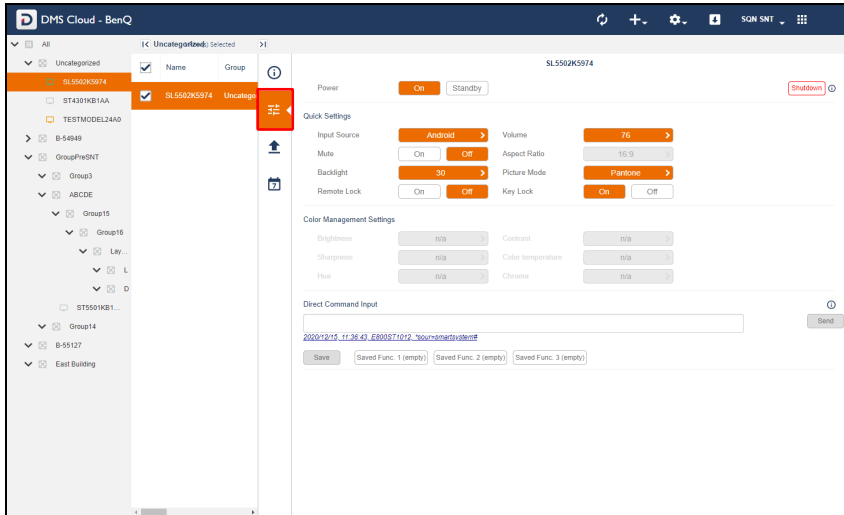

When DMS Cloud detects a problem with the device's connection to the network, all the buttons and fields in the control tab will be greyed out.

The control tab will show different control items depending on what type of selection is made in the device panel. The possible selections include the following:

- A single BenQ display
- A single BenQ projector
- A single non-BenQ projector
- Multiple projectors in a group
- Multiple displays in a group



The sections below describe the control panel for each of the items above.



The Control Tab (Single BenQ Display)

When a single BenQ display is selected in the device panel, the control tab features the following items:

The screenshot shows the control interface for a BenQ display (model CP8601K278C). The interface is divided into several sections:

- Power:** Includes 'On', 'Standby', and 'Shutdown' buttons. Callout 1 points to the device ID 'CP8601K278C'.
- Quick Settings:** Contains controls for Input Source (Android), Volume (10), Mute (On/Off), Aspect Ratio (16:9), Backlight (100), Picture Mode (Standard), Remote Lock (On/Off), and Key Lock (On/Off). Callout 2 points to the Backlight control.
- Color Management Settings:** Contains controls for Brightness (50), Contrast (60), Sharpness (n/a), Color temperature (Normal), Hue (n/a), and Chroma (n/a). Callout 3 points to the Contrast control.
- WOL (Wake-on-LAN) Settings:** Includes a 'WOL' toggle switch (On/Off). Callout 4 points to the WOL toggle.
- Direct Command Input:** A text input field containing a URL, a 'Send' button, and 'Save' buttons for saved functions. Callout 5 points to the input field.

No.	Item	Description
1	Power	<p>Powers on the display, puts it in standby mode, or powers off (shuts down) the display.</p> <p> To power on the display via DMS Cloud, make sure that the WOL (Wake-on-LAN) Settings on the display is enabled and that the display is connected to the network via the LAN (RJ-45) port. Wake-on-LAN does not work over a Wi-Fi connection.</p>
2	Quick Settings	<p>Features buttons and menus to control your display.</p> <p>See Quick Settings for more information on the quick settings controls.</p>
3	Color Management Settings	<p>Allows you to adjust image settings including Brightness, Contrast, Sharpness, Color Temperature, Hue, and Chroma.</p> <p> Support for each image setting depends on model.</p>

No.	Item	Description
4	WOL (Wake-on-LAN) Settings	<p>Allows the display to be able to be powered-on remotely from a shutdown state via the LAN port.</p> <p> The WOL (Wake-on-LAN) Settings option is only available for displays added to DMS Cloud via DMS Local's Agent Mode.</p> <p> The WOL (Wake-on-LAN) Settings function only works on displays that are connected to the network via their LAN (RJ-45) port and administered via DMS Local. Displays that are connected to the network via a Wi-Fi connection will not be able to use the WOL (Wake-on-LAN) Settings function.</p>
5	Direct Command Input	<p>Send or save custom control command codes for the display using the BenQ protocol for display control.</p> <p>See Direct Command Input (for Displays Only) for more information on the basic controls.</p>

The Control Tab (Single BenQ Projector)

When a single BenQ projector is selected in the projector panel, the control tab features the following items:

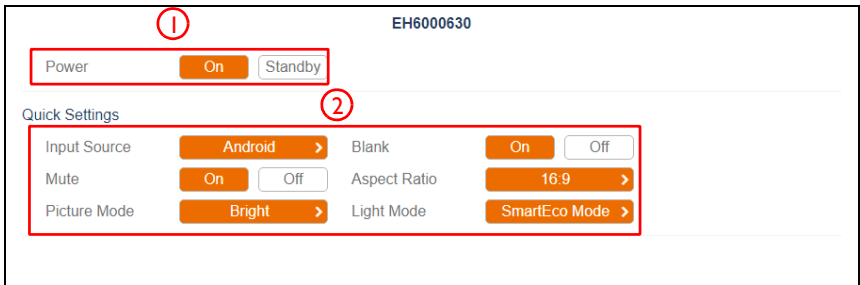

No.	Item	Description
1	Power	Powers on the projector or puts it in standby mode.
2	Quick Settings	<p>Features buttons and menus to control your projector.</p> <p>See Quick Settings for more information on the quick settings controls.</p>

The Control Tab (Single Non-BenQ Projector)

When a single non-BenQ projector is selected in the projector panel, the control tab features the following items:





No.	Item	Description
1	Power	Powers on the projector or puts it in standby mode via the PJLink protocol.

The Control Tab (Multiple Devices)

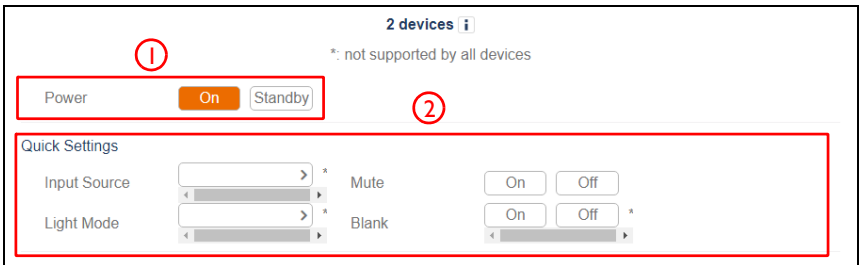
When multiple devices including both projectors and displays are selected in the device panel, the control tab features the following items:



No.	Item	Description
1	Power	<p>Powers on the devices, puts them in standby mode, or powers off (shuts down) the devices.</p> <p> To power on the display via DMS Cloud, make sure that the WOL (Wake-on-LAN) Settings on the display is enabled and that the display is connected to the network via the LAN (RJ-45) port. Wake-on-LAN does not work over a Wi-Fi connection.</p>
2	Quick Settings	<p>Features buttons and menus to control your device.</p> <p>See Quick Settings for more information on the quick settings controls.</p> <p> Only functions supported by all devices in the group will be supported in the Quick Settings section. Functions that are not supported by all displays will show an asterisk (*).</p>

Quick Settings

The quick settings section of the control tab features the following buttons and menus which help you control your device.

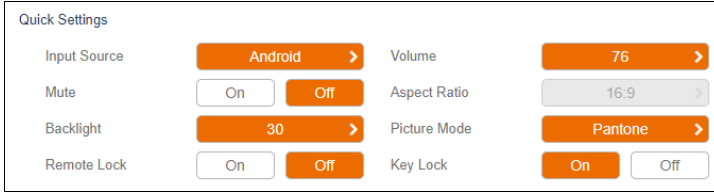

Button	Description
Input Source	Sets the input source for the device.
Volume*	Adjusts the audio volume.
Blank²	Toggles a blank screen for the projector on or off.
Light Mode	Select the light mode settings for the device.
Mute	Mutes or unmutes the audio output.
Aspect Ratio*	Sets the image aspect ratio for the device.
Backlight^{1*}	Sets the brightness level of the backlight for the display.
Brightness^{2*}	Sets the brightness level for the projector.
Picture Mode*	Sets the picture mode for the device.
Remote Lock¹	Enables/Disables the remote control lock.
Key Lock¹	Enables/Disables the keypad lock.
Network^{2*}	Enables/Disables the network function in standby mode.
Monitor Out^{2*}	Enables/Disables outputting the signal via the Monitor Out port.
¹ For displays only	
² For projectors only	
*Not available for multiple devices.	



- The fields displayed in the quick settings section may vary depending on the model selected.
- When the device is in standby mode, all fields in the quick settings section will be empty.
- When the device is powered on, the fields in the quick settings section will be set to the current configurations of the device.
- When DMS Cloud detects a problem with the device's connection to the network, the fields in the quick settings section will be greyed out.
- When the quick settings section is opened for multiple devices, both control fields and available options that are not supported by all devices will feature an asterisk (*).

Direct Command Input (for Displays Only)

The **Direct Command Input** section of the control tab allows you to create custom controls for your device using direct commands. For instance, you can create a command to have your device rotate its screen clockwise 90-degrees.



- Functions available to devices that support direct command controls and their corresponding commands vary by model. Check the specifications and user manual for your device for available functions and commands.
- Direct command controls can only be used on one device at a time.

The **Direct Command Input** section for a BenQ display is shown below:

The **Direct Command Input** section for a non-BenQ display is shown below:

Creating a One-Time-Only Direct Command

To create a one-time-only direct command, follow the steps below:

1. For BenQ displays - Enter the direct command code in the **Direct Command Input** field.

For non-BenQ displays - Enter the direct command code in the **Direct Command Input** field and the TCP port for the projector in the **Port** field.



Commands for BenQ displays must be in ASCII format, while commands for non-BenQ displays must be in hexadecimal format. For more information on creating direct commands, see [Direct Command Help](#).

2. Click **Send** and wait for a confirmation that the command has been executed successfully.



To prevent quick changes to the device's state, the **Direct Command Input** will be grayed out while DMS Cloud is confirming whether the direct command is successful. Once the direct command has been confirmed or the confirmation process has timed out, the field will return to its normal state.

Saving a Custom Direct Command Button

To save a direct command as a custom button, follow the steps below:

1. Click the button you want to customize in the direct command control section.



The direct command control section for BenQ devices features three direct command buttons available for customization, while the direct command control section for non-BenQ devices features 16 direct command buttons available for customization.

2. In the **Saved Func.** window, click the options button () and select **Edit**.

- For BenQ devices - In the **Edit Saved Function** window enter a name for the button in the **Name** field and the direct command code in the **Command** field.

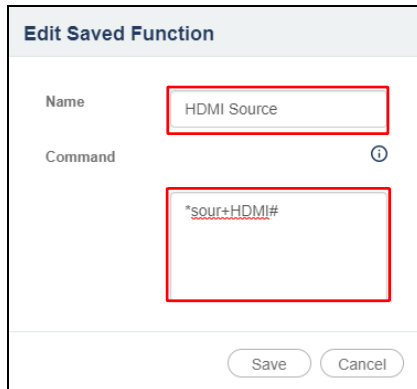

Edit Saved Function

Name: HDMI Source

Command: *sour+HDMI#

Save Cancel

For non-BenQ projectors - In the **Edit Saved Function** window enter a name for the button in the **Name** field, the direct command code in the **Command** field, and the TCP port for the projector in the **Port** field.

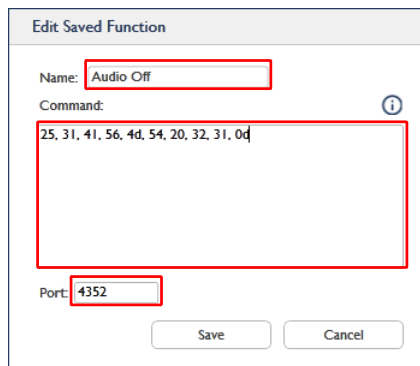

Edit Saved Function

Name: Audio Off

Command: 25, 31, 41, 56, 4d, 54, 20, 32, 31, 0d

Port: 4352

Save Cancel



Commands for BenQ projectors must be in ASCII format, while commands for non-BenQ devices must be in hexadecimal format. For more information on creating direct commands, see [Direct Command Help](#).

- Click **Save** in the **Edit Saved Function**, and your custom direct command button will appear in the direct command control section of the control panel, which you can click to send the command.

Direct Command Help

If you need help with creating direct commands in DMS Cloud, you can click the help button  located in the direct command control section for guidelines on creating direct commands.



Direct Command Input

The screenshot shows a 'Direct Command Input' form. At the top right, there is a help button (an 'i' in a circle) highlighted with a red box. Below the title is a large text input field containing the command '2020/12/15 11:36:43_E800ST1012_*sour=smartsystem#'. To the right of this field is a 'Send' button. Below the input field are four buttons: 'Save', 'Saved Func. 1 (empty)', 'Saved Func. 2 (empty)', and 'Saved Func. 3 (empty)'.

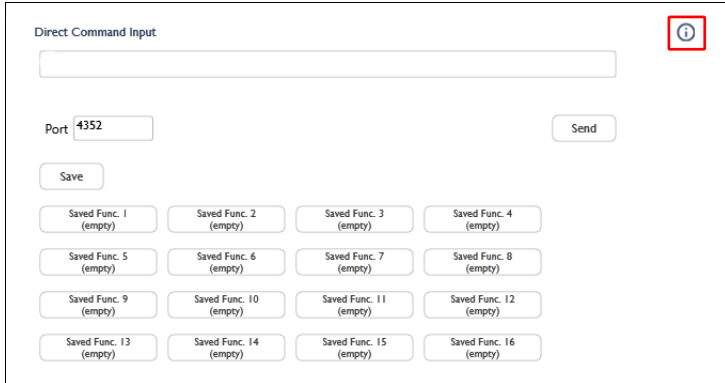

Direct Command Input

Port

The screenshot shows a 'Direct Command Input' form. At the top right, there is a help button (an 'i' in a circle) highlighted with a red box. Below the title is a large text input field. Below this is a 'Port' label followed by an input field containing '4352' and a 'Send' button. Below the port field is a 'Save' button. At the bottom, there are 16 buttons arranged in a 4x4 grid, labeled 'Saved Func. 1 (empty)' through 'Saved Func. 16 (empty)'.

Scheduling Your Device to Automatically Power On/Off

The schedule tab of DMS Cloud allows you to schedule a day and time for your device to power on or off automatically.

The screenshot shows the DMS Cloud interface for a device named 'SL5502K5974' under the group 'East Building'. The 'On-device Daily Scheduling' tab is active, displaying a table with the following columns: Enable, On, Off, Input Source, Frequency, and Edit/Reset. The table contains six rows, all with 'n/a' for On, Off, and Frequency, and 'No change' for Input Source. The 'Enable' column has checkboxes, and the 'Edit/Reset' column has edit and reset icons.

Enable	On	Off	Input Source	Frequency	Edit/Reset
<input type="checkbox"/>	n/a	n/a	VGA	n/a	<input type="checkbox"/> <input type="checkbox"/>
<input type="checkbox"/>	n/a	n/a	No change	n/a	<input type="checkbox"/> <input type="checkbox"/>
<input type="checkbox"/>	n/a	n/a	No change	n/a	<input type="checkbox"/> <input type="checkbox"/>
<input type="checkbox"/>	n/a	n/a	No change	n/a	<input type="checkbox"/> <input type="checkbox"/>
<input type="checkbox"/>	n/a	n/a	No change	n/a	<input type="checkbox"/> <input type="checkbox"/>
<input type="checkbox"/>	n/a	n/a	No change	n/a	<input type="checkbox"/> <input type="checkbox"/>



The schedule tab is not available for groups or multiple devices.

To schedule a day and time for your device to power on or off automatically:

1. Select the device(s) you want to automatically power on/off in the device panel and then click the schedule tab.

The screenshot shows the DMS Cloud interface for a device named 'SL5502K5974' under the group 'East Building'. The device panel is visible, showing the device's details: Name, Group, Type, Brand, Model, Power, Source, Status, IP Address, and Light Used. The 'Schedule' tab is highlighted in the right-hand sidebar.

Name	Group	Type	Brand	Model	Power	Source	Status	IP Address	Light Used
SL5502K5974	East Building	Public Display	BenQ	SL5502K	On	Android	Normal	10.82.102.168	n/a

- Choose one of the empty items in the schedule tab and click the Edit button .

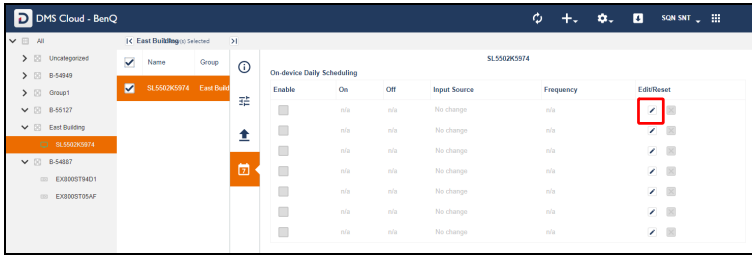

The schedule tab is pre-configured with seven available schedule items for you to create schedules with. If you have already created schedules using all seven slots, you must override one of the existing items.

- Configure the following items in the **Edit on-device daily scheduling** menu:

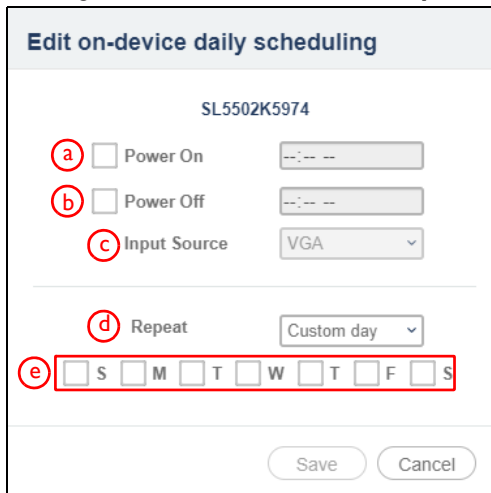

- Check the box if you want your device to automatically power on at a given day and time, and then set the time when you want the device to power on.
 - Check the box if you want your device to automatically power off at a given day and time, and then set the time when you want the device to power off.
 - If you checked the **Power On** box, select the input source you want the device to power on to.
 - Select the frequency in which your device powers on/off. The available options are **Everyday**, **Weekday**, **Weekend**, or **Custom day**.
 - If **Custom day** is selected in the **Repeat** field, check the boxes next to the days in which you want your device to power on/off.
- Click the **Save** button to finish the scheduling process. By default the created task will automatically be enabled.

Editing a Scheduled Power On/Off

To edit a scheduled power on/off:

1. Click the edit button () for the item you want to edit in the schedule tab for the device.
2. Edit the items in the **Edit on-device daily scheduling** menu based on the descriptions in step 3 above.
3. Click the **Save** button to finish editing the scheduled task. The edited task will retain the enabled/disabled setting from before it was edited.

Resetting (Deleting) a Scheduled Power On/Off

To reset (delete) a scheduled power on/off, click the reset button () for the item you want to reset in the schedule tab for the device. The schedule item will clear itself of the scheduling conditions and become disabled.

The App List Tab

For certain devices with compatible Android operating systems, the Action Panel features an app list tab that allows you to view the apps installed on your devices, view each app's description, install and/or uninstall apps on your device, and update the device's Android operating system.

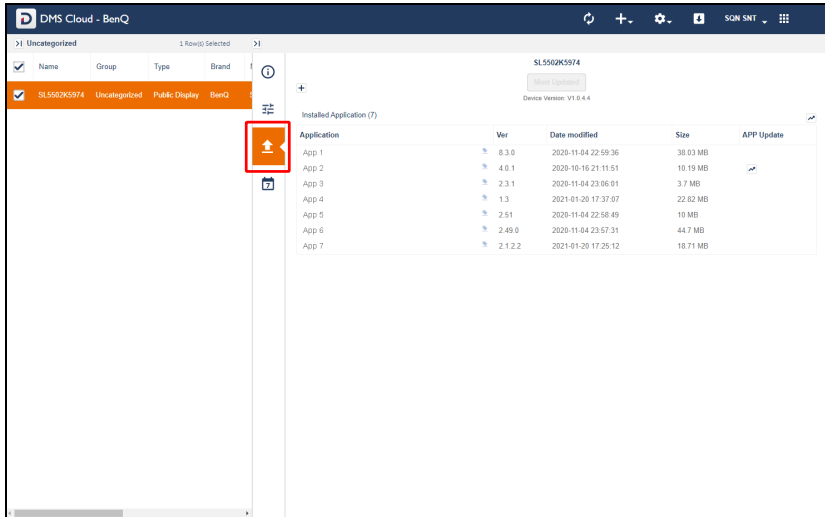

Support for the app list function depends on the version of the Android OS installed on your device. Not all devices with the Android OS will support the app list function.

Viewing Installed Apps

After selecting the app list button () in the Action Panel, the app list menu will appear displaying a list of the apps installed on your device as well as information such as version number, date modified, and file size for each app.

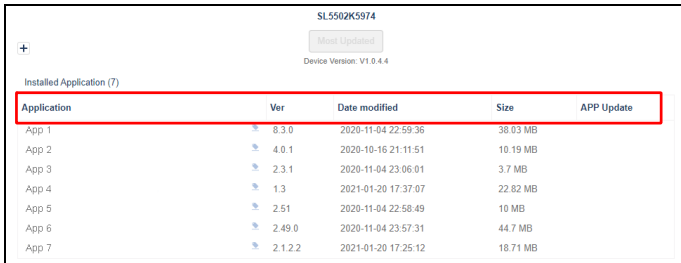

To view a detailed description for each app, select the tag button () to the right of the app name.

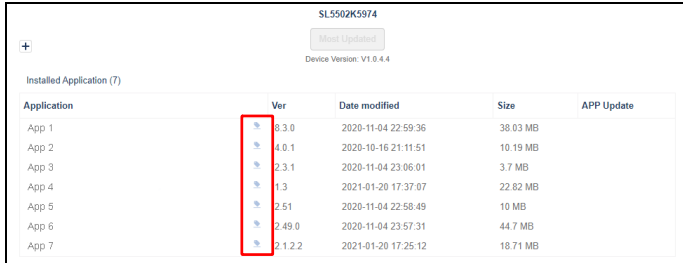

Application	Ver	Date modified	Size	APP Update
App 1	8.3.0	2020-11-04 22:59:36	38.03 MB	
App 2	4.0.1	2020-10-16 21:11:51	10.19 MB	
App 3	2.3.1	2020-11-04 23:06:01	3.7 MB	
App 4	1.3	2021-01-20 17:37:07	22.82 MB	
App 5	2.51	2020-11-04 22:58:49	10 MB	
App 6	2.49.0	2020-11-04 23:57:31	44.7 MB	
App 7	2.1.2.2	2021-01-20 17:25:12	18.71 MB	

Once selected, a window will pop up showing the app's description.

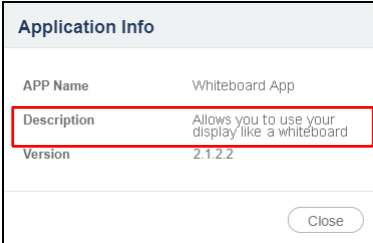

Application Info	
APP Name	Whiteboard App
Description	Allows you to use your display like a whiteboard
Version	2.1.2.2
<input type="button" value="Close"/>	

Installing an App

The app list tab allows you to install apps stored either locally as an APK file or in the DMS Cloud Software Management database onto your devices via DMS Cloud. See [Adding or Updating an App to the DMS Cloud Database](#) for more information on uploading apps into the Software Management database.



- DMS Cloud supports installing apps on devices that are currently offline. After you complete the installation process described below for an offline device, DMS Cloud will install the app once the device comes online. If the designated device does not come online within a span of a week, DMS Cloud will cancel the installation process.
- Support for the app depends on the compatibility of the app with the version of Android OS installed on your device. See [Software Management](#) for more information on managing and accessing older versions of stored apps in the Software Management database.

To install an APK installation file:

1. Click the install button () in the app list.

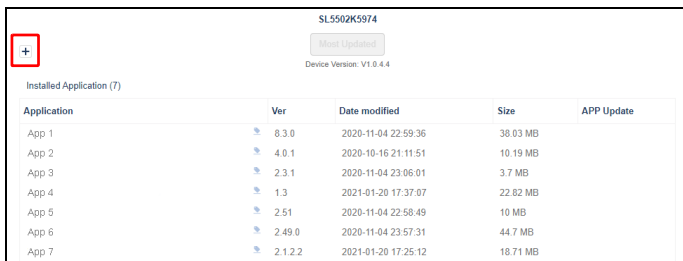

Application	Ver	Date modified	Size	APP Update
App 1	8.3.0	2020-11-04 22:59:36	38.03 MB	
App 2	4.0.1	2020-10-16 21:11:51	10.19 MB	
App 3	2.3.1	2020-11-04 23:06:01	3.7 MB	
App 4	1.3	2021-01-20 17:37:07	22.82 MB	
App 5	2.51	2020-11-04 22:58:49	10 MB	
App 6	2.49.0	2020-11-04 23:57:31	44.7 MB	
App 7	2.1.2.2	2021-01-20 17:25:12	18.71 MB	

2. Choose one of the following options:

- To install an app stored locally as an APK file: click **Select From Local File**, and then navigate to the location of the APK file located on your computer.

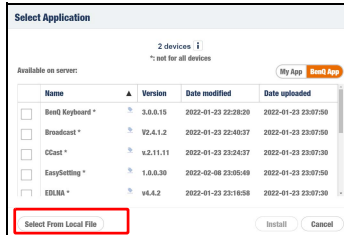

- To install apps from the Software Management database: first select the **My App** or **BenQ App** button and then select the apps you want to install in the **Available on server** list. Click the **Install** button to download the apps.

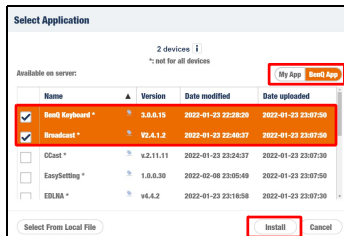

3. Once the installation has successfully finished, the newly installed app will appear in the app list for the device.

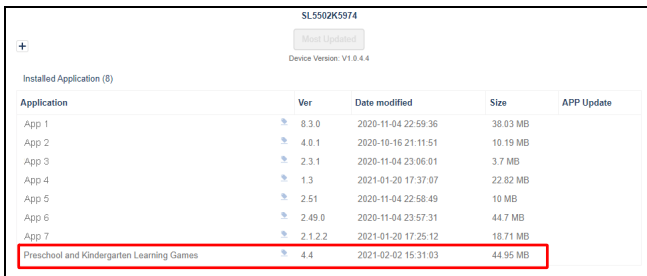

If the installed app does not appear shortly after the installation process is complete, select the refresh button () in the DMS Cloud toolbar.

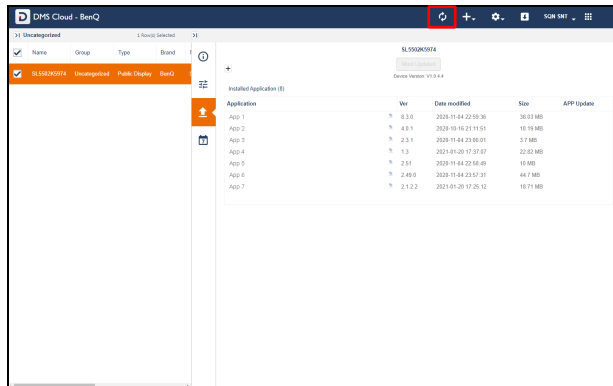

If the app in question does not appear in the app list even after refreshing DMS Cloud, there may be support issues for the app that resulted in a failed installation process. Support for the app depends on the compatibility of the app with the version of Android OS installed on your device.

Uninstalling an App

To uninstall an app in the app list, right-click on the app you want to uninstall and then select **Uninstall Application**.

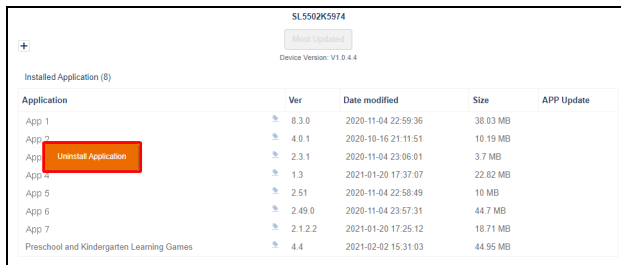

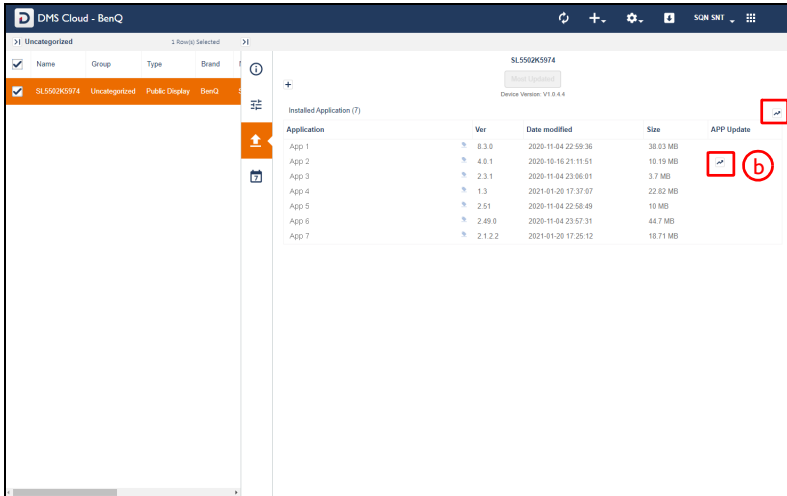

Updating an App

To update the apps in the app list, click the update button () to update all apps or an individual app.



The screenshot shows the DMS Cloud interface for a device named 'SL5502K5974'. The interface displays a list of installed applications with columns for Application, Ver, Date modified, Size, and APP Update. The APP Update column contains update icons for each application. Two red boxes with letters 'a' and 'b' are overlaid on the image to indicate update actions: box 'a' is around the update icon for the top application, and box 'b' is around the update icon for 'App 2'.

Application	Ver	Date modified	Size	APP Update
App 1	8.3.0	2020-11-04 22:59:36	38.03 MB	
App 2	4.0.1	2020-10-10 21:11:51	10.19 MB	
App 3	2.3.1	2020-11-04 23:06:01	3.7 MB	
App 4	1.3	2021-01-20 17:37:07	22.82 MB	
App 5	2.51	2020-11-04 22:58:49	10 MB	
App 6	2.49.0	2020-11-04 23:57:31	44.7 MB	
App 7	2.1.2.2	2021-01-20 17:25:12	18.71 MB	

- a. Click to update all applications
- b. Click to update an individual app

Updating the Android Operating System on your Device

The app list tab also allows you to update the Android operating system installed on your device via DMS Cloud.

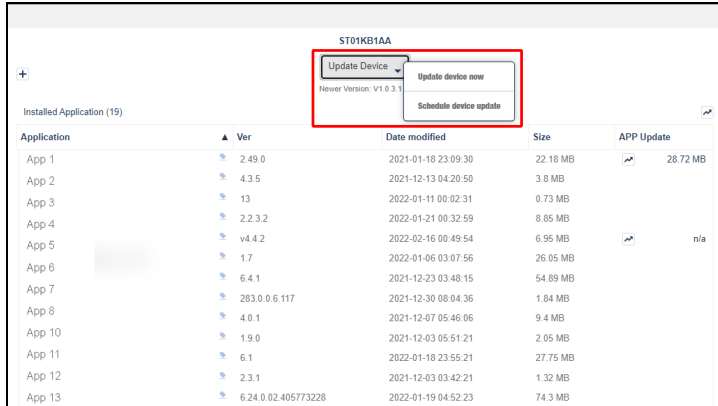

The entire process will take some time, during this time you will not be able to use any other DMS Cloud functions. Once the update is finished, your device will restart.



If the update file is corrupt or an error occurs during the update process, a **Device Update Failed** message will appear. Check with the manufacturer of your device for more information regarding the update file and its compatibility with your device.

Updating the operating system on your device immediately

1. Select the device(s) you want to update then select the app list button ().

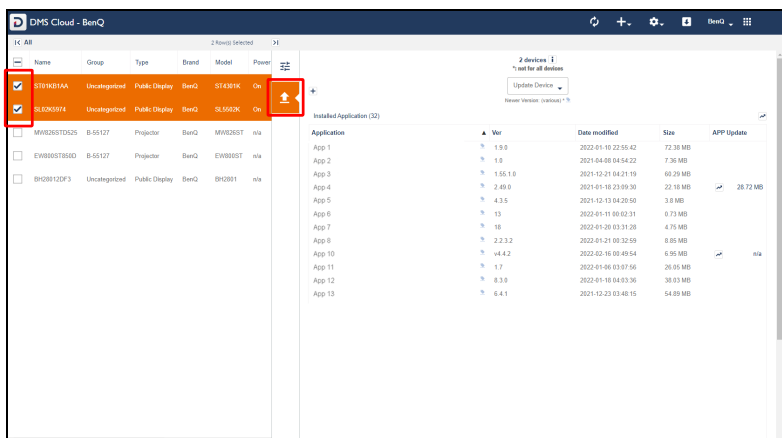

- Select **Update Device > Update device now** to check the update information.

2 devices |
*; not for all devices

Update Device
Update device now
Schedule device update

Installed Application (32)

Application	Ver	Date modified	Size	APP Update
App 1	1.9.0	2022-01-10 22:55:42	72.38 MB	
App 2	1.0	2021-04-08 04:54:22	7.36 MB	
App 3	1.55.1.0	2021-12-21 04:21:19	60.29 MB	
App 4	2.49.0	2021-01-18 23:09:30	22.18 MB	28.72 MB
App 5	4.3.5	2021-12-13 04:20:50	3.8 MB	
App 6	13	2022-01-11 00:02:31	0.73 MB	
App 7	18	2022-01-20 03:31:28	4.75 MB	
App 8	2.2.3.2	2022-01-21 00:32:59	8.85 MB	
App 10	v4.4.2	2022-02-16 00:49:54	6.95 MB	n/a
App 11	1.7	2022-01-06 03:07:56	26.05 MB	
App 12	8.3.0	2022-01-18 04:03:36	38.03 MB	
App 13	6.4.1	2021-12-23 03:48:15	54.89 MB	

- Click **Update Now** and the update process will begin for all selected devices.

Device Update (various)

There are various updates available. Please check the detail first before each update operation.

Newer version: V1.0.3.1 866 MB

V1.0.3.1 **Update Now**

Applicable devices: 1 (out of 2)

ST01KB1AA

Newer version: V1.0.7.2 1354 MB

V1.0.7.2 **Update Now**

Applicable devices: 1 (out of 2)

SL02K5974

Close

Scheduling the operating system update on your device

1. Select the device(s) you want to schedule for an update then select the app list button ().

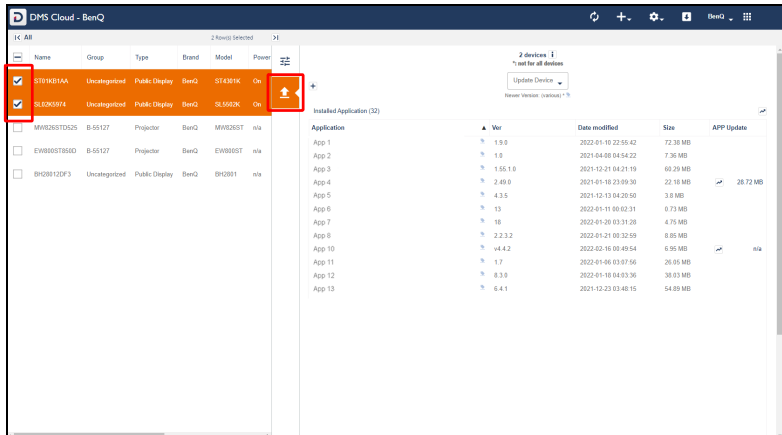

The screenshot shows the DMS Cloud interface with two devices selected: ST4301K and SL5502K. The 'Update Device' button is highlighted, and the 'App list' button (represented by an upward arrow icon) is also highlighted. The 'Installed Application (32)' table is visible below the device list.

Name	Group	Type	Brand	Model	Power
<input checked="" type="checkbox"/> ST4301K	Uncategorized	Public Deploy	BenQ	ST4301K	On
<input checked="" type="checkbox"/> SL5502K	Uncategorized	Public Deploy	BenQ	SL5502K	On
<input type="checkbox"/> MW6260TD25	B-55127	Projector	BenQ	MW6260T	n/a
<input type="checkbox"/> EW8060T860	B-55127	Projector	BenQ	EW8060T	n/a
<input type="checkbox"/> BH201120F3	Uncategorized	Public Deploy	BenQ	BH2011	n/a

Application	Ver	Date modified	Size	APP Update
App 1	1.9.0	2022-01-10 22:55:42	72.38 MB	
App 2	1.0	2021-04-08 04:54:22	7.36 MB	
App 3	1.55.1.0	2021-12-21 04:21:19	60.29 MB	
App 4	2.49.0	2021-01-18 23:09:30	22.18 MB	28.72 MB
App 5	4.3.5	2021-12-13 04:20:50	3.8 MB	
App 6	13	2022-01-11 00:02:31	0.73 MB	
App 7	18	2022-01-20 03:31:28	4.75 MB	
App 8	2.2.3.2	2022-01-21 00:32:59	8.85 MB	
App 10	v4.4.2	2022-02-16 00:49:54	6.95 MB	n/a
App 11	1.7	2022-01-06 03:07:56	26.05 MB	
App 12	8.3.0	2022-01-18 04:03:36	38.03 MB	
App 13	6.4.1	2021-12-23 03:48:15	54.89 MB	

2. Select **Update Device > Schedule device update** to set the update schedule.

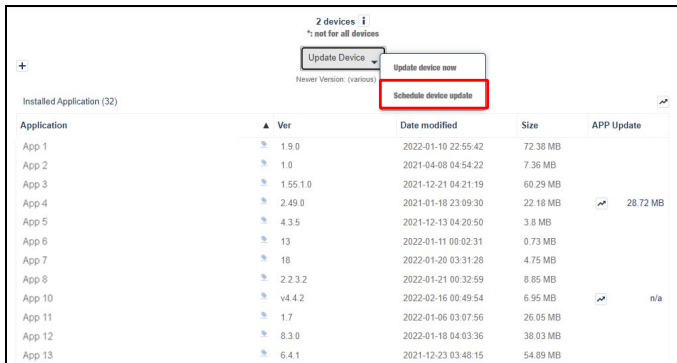

The screenshot shows the 'Update Device' dropdown menu open, with 'Schedule device update' selected. The 'Installed Application (32)' table is visible below the menu.

Application	Ver	Date modified	Size	APP Update
App 1	1.9.0	2022-01-10 22:55:42	72.38 MB	
App 2	1.0	2021-04-08 04:54:22	7.36 MB	
App 3	1.55.1.0	2021-12-21 04:21:19	60.29 MB	
App 4	2.49.0	2021-01-18 23:09:30	22.18 MB	28.72 MB
App 5	4.3.5	2021-12-13 04:20:50	3.8 MB	
App 6	13	2022-01-11 00:02:31	0.73 MB	
App 7	18	2022-01-20 03:31:28	4.75 MB	
App 8	2.2.3.2	2022-01-21 00:32:59	8.85 MB	
App 10	v4.4.2	2022-02-16 00:49:54	6.95 MB	n/a
App 11	1.7	2022-01-06 03:07:56	26.05 MB	
App 12	8.3.0	2022-01-18 04:03:36	38.03 MB	
App 13	6.4.1	2021-12-23 03:48:15	54.89 MB	

- Click **Next: Set schedule** to continue setting the schedule.

Device Update (various)

There are various updates available. Please check the detail first before each update operation.

Newer version: V1.0.3.1	866 MB
V1.0.3.1	Next: Set schedule
Applicable devices: 1 (out of 2)	
ST01KB1AA	

Newer version: V1.0.7.2	1354 MB
V1.0.7.2	Next: Set schedule
Applicable devices: 1 (out of 2)	
SL02K5974	

Close

- Set a date and time for device update and click **Set schedule** to finish the scheduling process.

Schedule Device Update

Please set scheduling time for device update.

Start device update at:

New Version	V1.0.3.1
Size	866 MB
Description	V1.0.3.1

Set schedule **Cancel**

- The update process will begin at the designated timing. If a device is shut down prior to the scheduled timing, the scheduled update will not be performed.

Changing Your DMS Cloud Password

To change your login password for DMS Cloud, follow the steps below:

1. Click the user button in the top toolbar and select **View Personal Profile**.



2. In the **Profile** menu, click **Change password**.

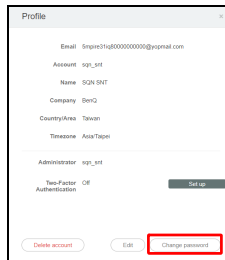

3. In the **Change password** menu, enter the current password in the **Current password** field and then the new password you want in both the **New password** and **Confirm password** fields.

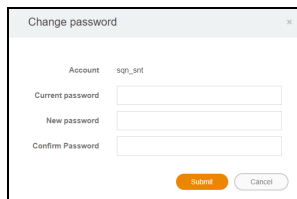

4. Click **Save** to finish changing your password for DMS Cloud.



If you forget your login password for DMS Cloud, click the **Forget ID / password?** link at the bottom of the login window and contact your local BenQ service team to provide them with the password retrieval code shown in the **Forget ID / password?** prompt.

Other Functions

DMS Cloud also allows you to do the following functions to further help you manage your devices:

- View DMS Cloud activity logs
- View usage/performance data for devices

Viewing DMS Cloud Activity Logs

DMS Cloud allows you to view a log of all the actions performed in DMS Cloud on the devices in your device tree for the past 30 days. The log includes the date and time of each action, the user who was responsible for the action, a description of the action, and the status of the action.

To view an activity log for your devices:

1. Click the settings button (⚙️) in the top toolbar and select **Status & Log**.

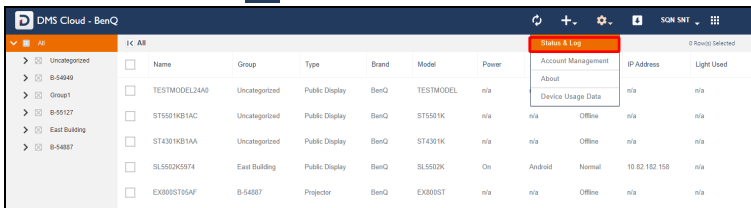

2. Scroll up to view past items in the log.

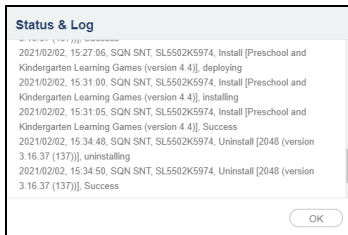

Viewing Usage Data for Devices

DMS Cloud also allows you to view usage data for up to 30 devices. The data will include various items such as hardware (e.g. CPU, memory, etc.) usage, performance levels (e.g. carbon output), and other related items.

To view the usage data for your devices:

1. Click the settings button (⚙️) in the top toolbar and select **Device Usage Data**. DMS Cloud will open a **Device Usage Data** page.

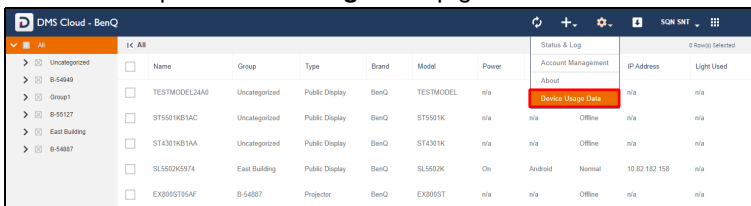

- Select one or more devices or groups in the device tree of the **Device Usage Data** page, and then select **Generate**.



The screenshot shows the 'Device Usage Data' interface. On the left, a tree view lists various devices and groups, including 'Unassigned', 'ST420/KB1AA', 'ST550/KB1AC', 'TESTMOREL2', 'B-54849', 'Group1', 'B-55127', 'East Building', and 'B-54857'. The 'TESTMOREL2' item is highlighted in orange. A red 'Generate' button is visible at the top right of the tree view.



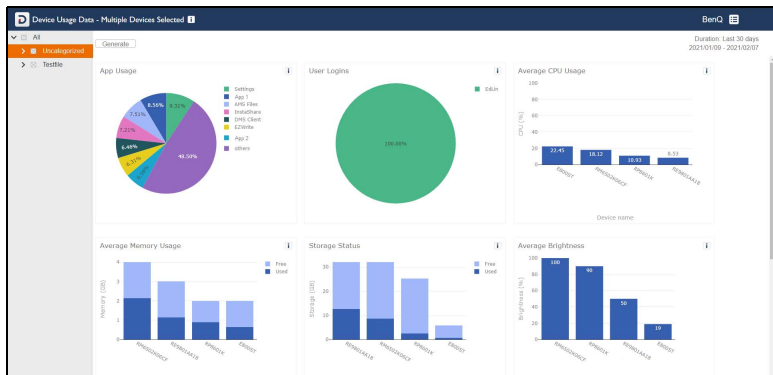

To select multiple items in the device tree, press and hold Ctrl on your keyboard and then select an item.

- Scroll down to see all the items in the usage data report.





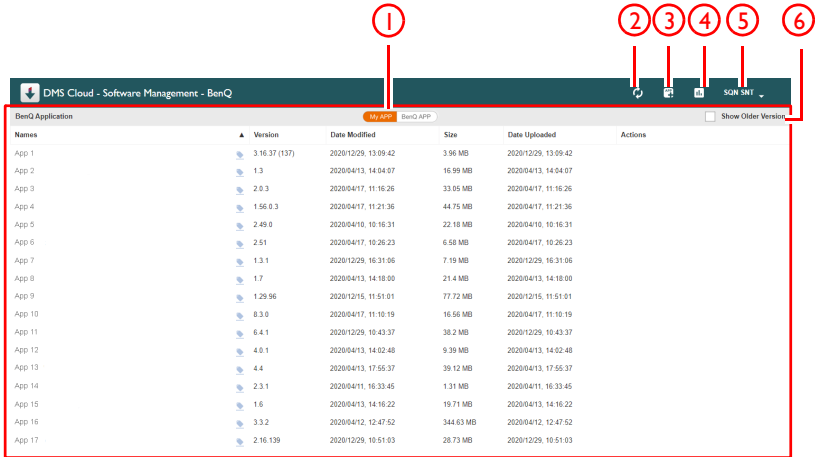

Software Management

The Software Management page allows you to manage the apps stored in the DMS Cloud database. To access the Software Management page, click the Software Management button () at the top toolbar in DMS Cloud.

Once you click the Software Management button (), the Software Management page will be shown. The following items are featured on the Software Management page.



No.	Item	Description
1	Apps List	<p>Shows all the apps managed by the Software Management page. Click the My App or BenQ App button to switch the app list.</p> <p>Click the tag button () next to each app name to see more details regarding the app, including app name, description, and version.</p> <p>Hover over the Actions column for an app for more app related actions, including installing, editing, or deleting the app.</p> <p>See Installing Apps onto a Device from the App List or Deleting Apps from the DMS Cloud Database for more information on installing or deleting an app on a device.</p> <p>See Editing App Descriptions for more information on editing an app's details.</p>
2	Refresh 	<p>Click to refresh the apps list.</p> <p> The Software Management page will automatically refresh the apps list after a given interval of time. The refresh button is to allow users to get the most up-to-date information at any given time.</p>

No.	Item	Description
3	Add/Update Applications 	Click to add a new app to the Software Management page or update an existing app to the newest version. See Adding or Updating an App to the DMS Cloud Database for more information on adding devices and device groups.
4	Status & Log 	Click to view the DMS Cloud activity log. See Viewing DMS Cloud Activity Logs for more information.
5	User	Click to edit selected account information and/or change your login password. See Changing Your DMS Cloud Password for more information on setting up a login password.
6	Show Older Version	Check this box to show older available versions of the apps in the apps list. See Accessing Older Versions of an App for more information on viewing older versions of an app via the Software Management page.

Adding or Updating an App to the DMS Cloud Database

To add an app or update an existing app to a newer version:



Added/Updated apps must be in the .apk file format.

1. Click the add/update applications button .

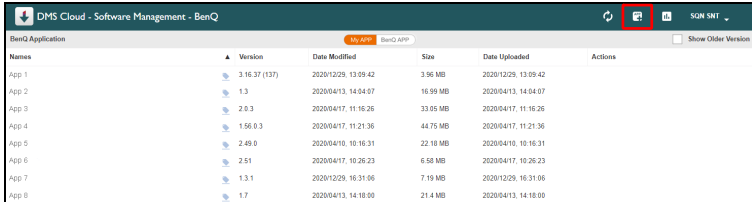

Names	Version	Date Modified	Size	Date Uploaded	Actions
App 1	3.16.37 (137)	2020/12/29, 13:09:42	3.96 MB	2020/12/29, 13:09:42	
App 2	1.3	2020/04/13, 14:04:07	16.99 MB	2020/04/13, 14:04:07	
App 3	2.0.3	2020/04/17, 11:16:26	33.05 MB	2020/04/17, 11:16:26	
App 4	1.56.0.3	2020/04/17, 11:21:36	44.75 MB	2020/04/17, 11:21:36	
App 5	2.49.0	2020/04/10, 10:16:31	22.18 MB	2020/04/10, 10:16:31	
App 6	2.51	2020/04/17, 10:26:23	6.58 MB	2020/04/17, 10:26:23	
App 7	1.3.1	2020/12/29, 16:31:06	7.19 MB	2020/12/29, 16:31:06	
App 8	1.7	2020/04/13, 14:18:09	21.4 MB	2020/04/13, 14:18:09	

2. Navigate to and select the app file located in your local storage.
3. Enter a description for the app in the **Description** field of the **Add Application Info** window that appears and/or select **Continue**.

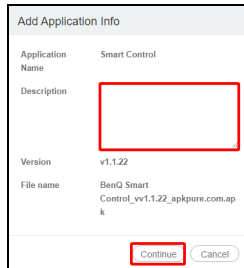

Add Application Info

Application Name: Smart Control

Description:

Version: v1.1.2Z

File name: BenQ Smart Control_vv1.1.2Z_apkpure.com.apk



Entering an app description is not a required step. To add/edit an app description at a later time, see [Editing App Descriptions](#).

4. Depending on the size of the app, the upload process may take some time. A confirmation window will appear once you have successfully uploaded the app to the DMS Cloud database. Click **Close** to finish the process.



Message

Application upload success

Deleting Apps from the DMS Cloud Database

To delete an app from the DMS Cloud Database:



- Deleting an app from the DMS Cloud database will not delete the respective app from devices that it has already been installed on via DMS Cloud.
- This function is only available for apps in the category of **My App**.

1. Use the cursor to hover over the **Actions** column for the app you want to delete, and then click the delete button (✕).

Names	Version	Date Modified	Size	Date Uploaded	Actions
App 1	3.16.37 (137)	2020/12/29, 13:29:42	3.96 MB	2020/12/29, 13:29:42	
App 2	1.3	2020/04/13, 14:04:07	16.99 MB	2020/04/13, 14:04:07	
App 3	2.0.3	2020/04/17, 11:16:26	33.05 MB	2020/04/17, 11:16:26	
App 4	1.56.0.3	2020/04/17, 11:21:36	44.75 MB	2020/04/17, 11:21:36	
App 5	2.49.0	2020/04/10, 10:16:31	22.18 MB	2020/04/10, 10:16:31	
App 6	2.51	2020/04/17, 10:26:23	6.58 MB	2020/04/17, 10:26:23	
App 7	1.3.1	2020/12/29, 16:31:06	7.19 MB	2020/12/29, 16:31:06	
App 8	1.7	2020/04/13, 14:18:00	21.4 MB	2020/04/13, 14:18:00	

2. Select **Delete** in the confirmation window that appears.

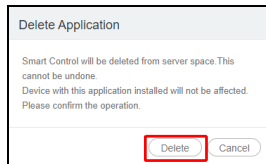

Installing Apps onto a Device from the App List

To install an app located on the DMS Cloud database using the Software Management app list:

1. Use the cursor to hover over the **Actions** column for the app you want to install onto your device, and then click the install button ().

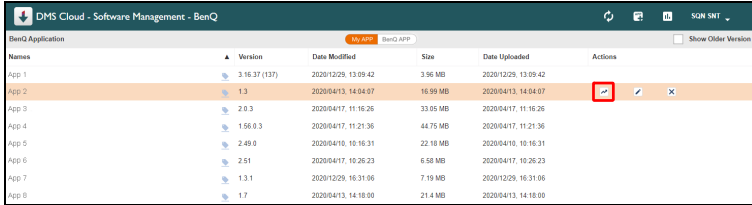

2. In the selection window, check the boxes for all the devices in the device tree you want to install the app to, and then click **Install**.

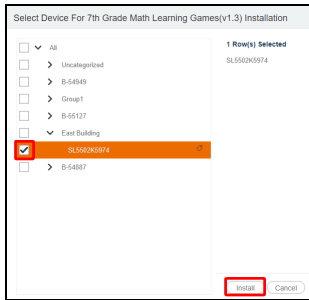

3. Once the app has been successfully installed onto the device, a success message will appear at the bottom of the Software Management page.

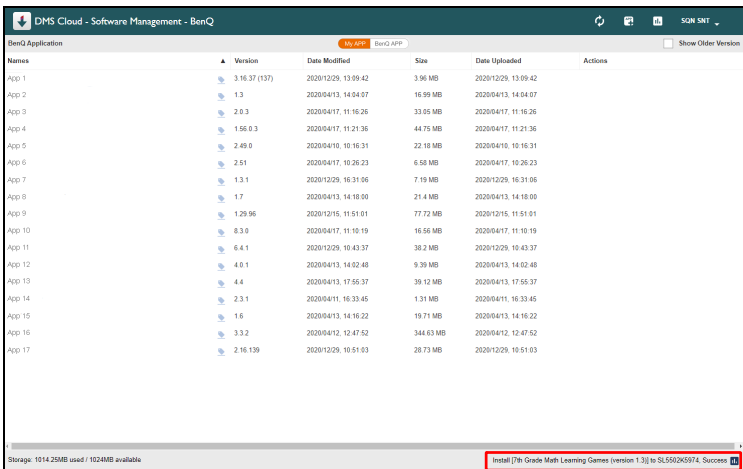



Editing App Descriptions

To edit the description for an app:



This function is only available for apps in the category of **My App**.

1. Use the cursor to hover over the **Actions** column for the app you want to edit the description for, and then click the edit button ().

Names	Version	Date Modified	Size	Date Uploaded	Actions
App 1	3.16.37 (137)	2020/12/29, 13:09:42	3.96 MB	2020/12/29, 13:09:42	
App 2	1.3	2020/04/13, 14:04:07	16.99 MB	2020/04/13, 14:04:07	 
App 3	2.0.3	2020/04/17, 11:16:26	33.05 MB	2020/04/17, 11:16:26	
App 4	1.56.0.3	2020/04/17, 11:21:36	44.75 MB	2020/04/17, 11:21:36	
App 5	2.49.0	2020/04/10, 10:16:31	22.18 MB	2020/04/10, 10:16:31	
App 6	2.51	2020/04/17, 10:26:23	6.68 MB	2020/04/17, 10:26:23	
App 7	1.3.1	2020/12/29, 16:31:06	7.19 MB	2020/12/29, 16:31:06	
App 8	1.7	2020/04/13, 14:18:00	21.4 MB	2020/04/13, 14:18:00	

2. In the edit window, enter the description and click **Save**.

Application Name: 7th Grade Math Learning Games

Description:

Version: 1.3

File name: 7th Grade Math Learning Games.apk

The description for the app can be viewed by clicking the tag button () for the app in the app list.

Accessing Older Versions of an App

The Software Management page allows you to access older versions of an app in the app list that had been previously uploaded to edit or delete from a device.

To access older versions of an app, check the **Show Older Version** box.

Names	Version	Date Modified	Size	Date Uploaded	Actions
App 1	3.16.37 (137)	2020/12/29, 13:09:42	3.96 MB	2020/12/29, 13:09:42	
App 1	3.16.36 (136)	2020/12/29, 10:00:46	4.10 MB	2020/12/29, 10:00:46	
App 1	3.16.36 (136)	2020/12/29, 10:04:37	4.10 MB	2020/12/29, 10:04:37	
App 2	1.3	2020/04/13, 14:04:07	16.99 MB	2020/04/13, 14:04:07	<input checked="" type="checkbox"/> Show Older Versions
App 3	2.0.3	2020/04/17, 11:16:26	33.05 MB	2020/04/17, 11:16:26	
App 3	1.8.0	2020/04/17, 11:13:48	34.22 MB	2020/04/17, 11:13:48	
App 3	1.8.0	2020/04/17, 11:12:31	34.52 MB	2020/04/17, 11:12:31	
App 4	1.56.0.3	2020/04/17, 11:21:36	44.75 MB	2020/04/17, 11:21:36	

Once the older versions appear in the app list, you can edit or delete a previous version of an app using the same steps described in the corresponding sections above.

About DMS Cloud

For more information regarding DMS Cloud including version number, click the settings button (⚙️) in the DMS Cloud top toolbar and select **About**.

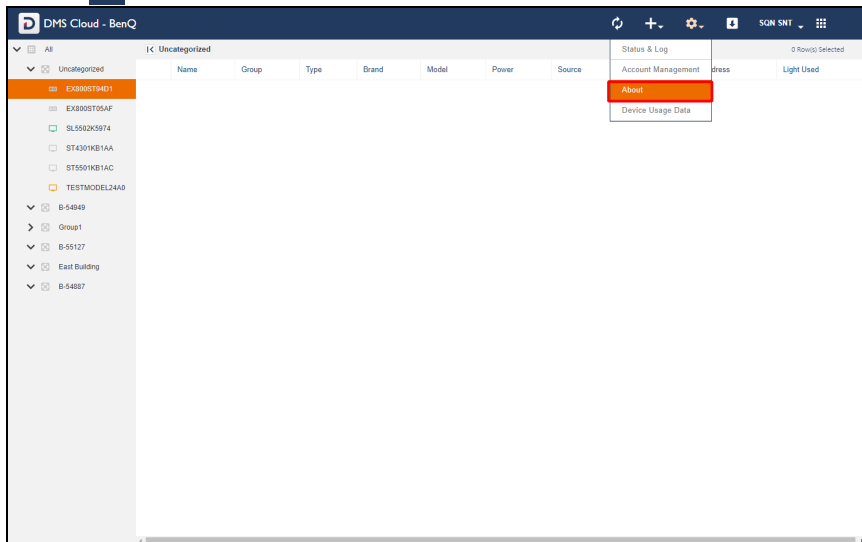

Troubleshooting

If you encounter problems while using the DMS Cloud, please refer to the following troubleshooting tips to try to solve the problems by yourself. If the problem persists, please contact BenQ Customer Support for help.

Problem	Solution
Cannot connect to the device(s) (The device is showing offline in the device list)	Check the following: <ul style="list-style-type: none"> • Check the cable connection. Is the device correctly connected to the network? • Is the device turned on? • Is the device network setting correct? • Check if the device's firmware version is up-to-date. • Check if the DMS Client app is up-to-date. • Check if a whitelist has been added for DMS Cloud (see the table below).
The device is showing that it is online, but in DMS Cloud it is listed as offline.	<ul style="list-style-type: none"> • Check if the device's firmware version is up-to-date. • Check if the DMS Client app is up-to-date. • Clear all cookies on your browser. • Use Incognito mode on your browser and then launch DMS Cloud. • Check if a whitelist has been added for DMS Cloud (see the table below).
Cannot power on the device via DMS Cloud	<ul style="list-style-type: none"> • Ensure that WOL (Wake-on-LAN) Settings is enabled on the device. • Ensure that the device is connected to the network via the LAN (RJ-45). Wake-on-LAN does not work over a Wi-Fi connection.
Cannot add a device into DMS Cloud	Check if the device supports LAN control.

Network Whitelist

If your network is in a private environment, please add a whitelist for DMS Cloud using the following URLs.

URL/DNS	Description	Port
https://dms.benq.com/	API URL (DMS Cloud & Local)	http(80)/https(443)
https://vod.benq.com/	Get Device JSON files (DMS Cloud & Local)	
http://staging2.benq.com	Get Device JSON files (v1.0.0.1) (DMS Cloud Only)	
https://dms-relay.benq.com	MQTT Connection (DMS Cloud Only)	
https://cmota.s3.amazonaws.com/	MDA command data used by DMS > (DMS Cloud & Local)	
https://dsdownload.benq.com	Verify Key or Release Key (DMS Local Only)	
apexd90h2t5wg-ats.iot.eu-central-1.amazonaws.com	AWS IoT service for MQTT Connection > (DMS Cloud)	(443/8883 port)
apexd90h2t5wg-ats.iot.eu-central-1.amazonaws.com	AWS IoT service for MQTT Connection > (DMS Local)	
N/A	DMS Local search device protocol	Ping(ICMP)