







# MicroScanner Series



## Getting Started Guide

### Symbols

	Warning or Caution: Risk of damage or destruction to equipment or software. See explanations in the manuals. On the tester's display this symbol indicates a cable fault or voltage on the cable.
	Warning: Risk of fire, electric shock, or personal injury.
	See the user documentation
	This equipment not for connection to public communications networks, such as active telephone systems.
	Conformite Europeene. Conforms to the requirements of the European Union and the European Free Trade Association (EFTA).
	Conforms to relevant Australian standards.
	EMC approval for Korea. Class A Equipment (Industrial Broadcasting & Communication Equipment). This product meets requirements for industrial (Class A) electromagnetic wave equipment and the seller or user should take notice of it. This equipment is intended for use in business environments and is not to be used in homes.

## Safety Information

---

	<p>This product complies with the WEEE Directive marking requirements. The affixed label indicates that you must not discard this electrical/electronic product in domestic household waste. Product Category: With reference to the equipment types in the WEEE Directive Annex I, this product is classed as category 9 "Monitoring and Control Instrumentation" product. Do not dispose of this product as unsorted municipal waste. To return unwanted products, contact the manufacturer's web site shown on the product or your local sales office or distributor.</p>
	<p>40 year Environment Friendly Use Period (EFUP) under China Regulation - Administrative Measure on the Control of Pollution Caused by Electronic Information Products. This is the period of time before any of the identified hazardous substances are likely to leak out, causing possible harm to health and the environment.</p>
	<p>This key turns the Product on and off.</p>

---

## Safety Information

---

### Warning

To prevent possible fire, electric shock, or personal injury:

- Read all safety information before you use the Product. For additional information, see the *MicroScanner Series Cable Verifiers Users Manual* on the Fluke Networks website.

- Carefully read all instructions.
- Do not open the case. You cannot repair or replace parts in the case.
- Do not modify the Product.
- Use only replacement parts that are approved by Fluke Networks.
- Do not touch voltages > 30 V AC rms, 42 V AC peak, or 60 V DC.
- The tester is not intended to be connected to active telephone inputs, systems, or equipment, including ISDN devices. Exposure to the voltages applied by these interfaces may damage the tester and create a potential shock hazard. The tester shows a warning symbol () and other indicators when it detects high voltage. See the Users Manual for examples of these displays. Disconnect the tester if it detects high voltage.
- Do not use the Product around explosive gas, vapor, or in damp or wet environments.
- Use this Product indoors only.
- Do not connect the Product to voltages that are higher than the maximum voltage rating for the Product.
- For Products that have multiple connectors for different types of tests on copper cabling, disconnect unused test leads from the connectors before you do a test.
- Use the Product only as specified, or the protection supplied by the Product can be compromised.

- **Do not use and disable the Product if it is damaged.**
- **Do not use the Product if it operates incorrectly.**
- **Batteries contain hazardous chemicals that can cause burns or explode. If exposure to chemicals occurs, clean with water and get medical aid.**
- **Remove the batteries if the Product is not used for an extended period of time, or if stored in temperatures above 50 °C. If the batteries are not removed, battery leakage can damage the Product.**
- **The battery door must be closed and locked before you operate the Product.**
- **Repair the Product before use if the battery leaks.**
- **Replace the batteries when the low battery indicator shows to prevent incorrect measurements.**
- **Turn off the Product and disconnect all test leads, patch cords, and cables before you replace the battery.**
- **Be sure that the battery polarity is correct to prevent battery leakage.**
- **Do not disassemble or crush battery cells and battery packs.**
- **Do not operate the Product with covers removed or the case open. Hazardous voltage exposure is possible.**
- **Remove the input signals before you clean the Product.**

- Have an approved technician repair the Product.
- Do not put metal objects into connectors.

---

## Keys

---

Combinations of keys provide additional functions. See the Users Manual.

---

### MicroScanner<sup>2</sup>

Selects the active port (RJ45 or coaxial)

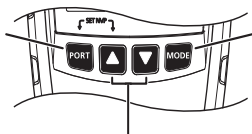

Selects the test mode

Scrolls through settings and detailed results.

---

### MicroScanner PoE

Cable test

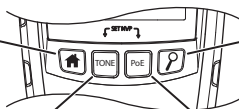

Scrolls through settings and detailed results.

Toner

Power over Ethernet test



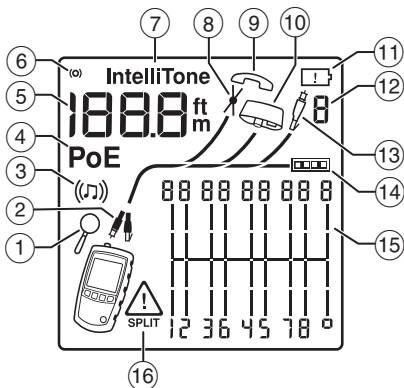

# Display Features

## MicroScanner<sup>2</sup>

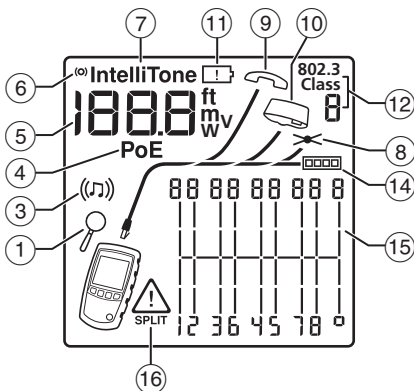

## MicroScanner PoE



- ① Detail screen indicator. To scroll through detail screens, press   or  during a cable test.
- ② MicroScanner<sup>2</sup>: Indicates which port is active, the RJ45 port () or the coaxial port ()
- ③ Tone mode indicator
- ④ Power over Ethernet mode indicator
- ⑤ Numeric display with feet/meters indicator. MicroScanner PoE also shows watts or volts when it detects 802.3 compliant (**W**) or passive (**V**) PoE.
- ⑥ Test activity indicator
- ⑦ Appears when the toner is in IntelliTone mode.
- ⑧ Indicates a short on the cable.
- ⑨ Telephone voltage indicator. **P** and **n** appear in the wiremap diagram over the positive (tip) and negative (ring) wires.
- ⑩ Indicates a wiremap adapter or remote ID locator is connected to the far end of the cable.
- ⑪ Low battery indicator
- ⑫ The 7-segment display shows the number of the ID locator connected to the far end of the cable. A **!** shows for the wiremap adapter.

MicroScanner PoE: **802.3 Class** and the 7-segment display show the maximum class of PoE available (802.3 classes 0 through 8).

## Changing the Length Units







---

- ⑬ MicroScanner<sup>2</sup>: Indicates an ID locator is connected to the far end of the cable.
- ⑭ Ethernet port indicator. The speeds of the port show under the indicator.
- ⑮ Wiremap diagram. The rightmost segments indicate the shield.
- ⑯ The  indicates a fault or high voltage on the cable. **SPLIT** appears when the fault is a split pair.

---

## Changing the Length Units

---

- 1 Hold down  and  or  and  while turning on the tester.
- 2 Press  or  to switch between meters and feet.

---

## Auto Shutoff



---

The tester turns off after 10 minutes if no keys are pressed and nothing changes at the tester's connectors.

---

## Testing Cabling

---

- 1 Press ① to turn on the tester.
- 2 MicroScanner<sup>2</sup>: Press  to switch between twisted pair () and coaxial () modes.
- 3 Connect as shown in the following figures. If the **PoE** indicator appears, see page 11.



---

## Connecting to Twisted Pair Network Cabling

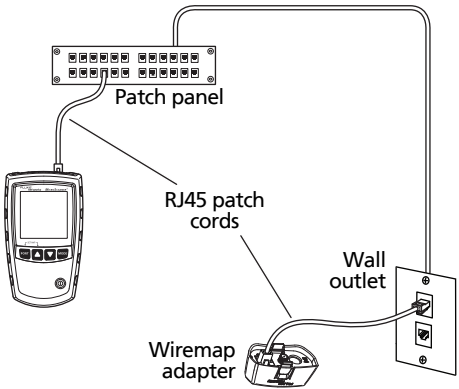

---

## Connecting to a Bus Topology

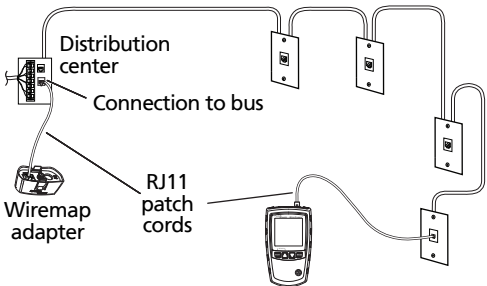

Note: You can swap the locations of the tester and wiremap adapter.

### Connecting to a Star Topology

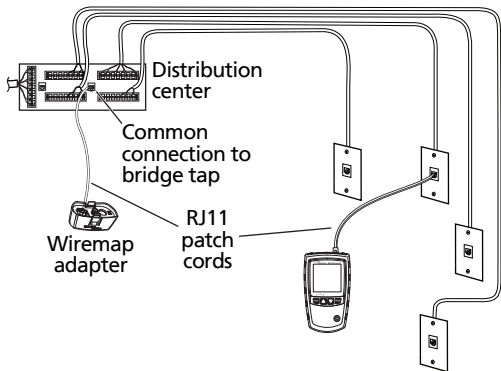

Note: For a correct length reading, connect the tester and wiremap adapter as shown. See the Users Manual for details.

### Connecting to Coaxial Cabling (MicroScanner<sup>2</sup>)

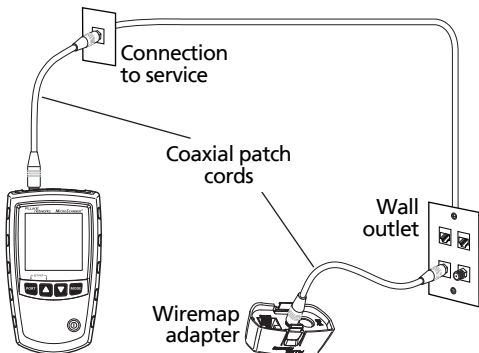

## Using the Toner

---

- 1 MicroScanner<sup>2</sup>: Press **PORT** to select twisted pair (🔌) or coaxial (🔌) cable.
- 2 Connect the tester to the cable.
- 3 Press **MODE** or **⏮** until ((🎵)) appears on the display.
- 4 To cycle through the IntelliTone and analog toner songs, press **▲** **▼** or **🔍**.
- 5 Use an optional IntelliTone probe or an analog probe to locate the cable.

If the PoE indicator appears, see page 11.

### *Note*

*Auto shutoff is disabled in toner mode.*

---

## Detecting Power Over Ethernet

---

MicroScanner<sup>2</sup> can detect PoE voltages from active 802.3af sources.

MicroScanner PoE can use the 802.3af, at, and bt standards at the hardware layer, or at the link layer with LLDP (Link Layer Discovery Protocol), to negotiate and solicit PoE from active sources. It can also negotiate and solicit PoE from sources that use Cisco's UPOE<sup>®</sup> (Universal Power over Ethernet) technology. The display shows the maximum class of power available and the expected wattage for that class.

## Replacing the Batteries

---

To select PoE mode, press **MODE** or **PoE** until PoE appears on the display. In PoE mode, the tester solicits PoE power on pairs 1,2-3,6 and 4,5-7,8. The tester may activate a PoE source and will not be damaged by PoE power.

If PoE power is detected, **PoE** appears above the powered pairs. The **PoE** may blink as the PoE source turns the power on and off.

In twisted pair test mode, a flashing **PoE** mode indicator means that PoE power may be available. To verify the presence of a PoE source, switch the tester to PoE mode.

---

## Replacing the Batteries

---

The batteries last for about 20 hours of typical use.

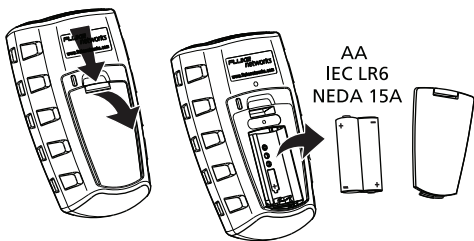

---

## Learn More

---

- Download the Users Manual:  
[www.flukenetworks.com/support/manuals](http://www.flukenetworks.com/support/manuals)
- Read articles in the Knowledge Base:  
[www.flukenetworks.com/knowledge-base](http://www.flukenetworks.com/knowledge-base)

---

## Contacting Fluke Networks

---



[www.flukenetworks.com/support](http://www.flukenetworks.com/support)



[info@flukenetworks.com](mailto:info@flukenetworks.com)



1-800-283-5853, +1-425-446-5500



**Fluke Networks**  
6920 Seaway Boulevard, MS 143F  
Everett WA 98203 USA

Fluke Networks operates in more than 50 countries worldwide. For more contact information, visit our website.

---

## General Specifications

---

<b>Battery Type</b>	2 AA alkaline, NEDA 15A, IEC LR6
<b>Temperature</b>	Operating: 0 °C to 45 °C Storage: -20 °C to +60 °C
<b>Altitude</b>	Operating: 4,000 m Storage: 12,000 m

## LIMITED WARRANTY AND LIMITATION OF LIABILITY

Fluke Networks mainframe products will be free from defects in material and workmanship for one year from the date of purchase, unless stated otherwise herein. The warranty period for the MicroScanner wiremap adapter is also one year. Parts, accessories, product repairs and services are warranted for 90 days, unless otherwise stated. Ni-Cad, Ni-MH and Li-Ion batteries, cables or other peripherals are all considered parts or accessories. This warranty does not cover damage from accident, neglect, misuse, alteration, contamination, or abnormal conditions of operation or handling. Resellers are not authorized to extend any other warranty on Fluke Networks' behalf. To obtain service during the warranty period, contact your nearest Fluke Networks authorized service center to obtain return authorization information, then send your defective product to that Service Center with a description of the problem.

For a list of authorized resellers, visit [www.flukenetworks.com/wheretobuy](http://www.flukenetworks.com/wheretobuy).

THIS WARRANTY IS YOUR ONLY REMEDY. NO OTHER WARRANTIES, SUCH AS FITNESS FOR A PARTICULAR PURPOSE, ARE EXPRESSED OR IMPLIED. FLUKE NETWORKS IS NOT LIABLE FOR ANY SPECIAL, INDIRECT, INCIDENTAL OR CONSEQUENTIAL DAMAGES OR LOSSES, ARISING FROM ANY CAUSE OR THEORY. Since some states or countries do not allow the exclusion or limitation of an implied warranty or of incidental or consequential damages, this limitation of liability may not apply to you.

4/15-MS

Fluke Networks  
PO Box 777  
Everett, WA 98206-0777  
USA